



OPERATION, MAINTENANCE, AND INSTALLATION GUIDE

Zenith ZTG series

For ZTG(D) series automatic transfer switches, 30-1200 A, 200-480 Vac





Receiving, handling and storage

**Warning**

Indicates a hazardous situation that, if not avoided, could result in death or serious injury.

**HAZARD OF EQUIPMENT
OVERTURNING**

When moving with a fork lift, do not remove the shipping packaging until the device is in its final location.

Failure to follow this instruction may result in personal injury or equipment damage.

Receiving and handling

Upon receipt, carefully inspect the transfer switch for damage that may have occurred during transit. If damage is evident, or there is visible indication of rough handling, immediately file a damage claim with the transportation company, and notify your local ABB sales office.

Do not remove the shipping packaging until ready to install the switch.

Storage

If the unit will not be placed into service immediately, store the transfer switch in its original package in a clean, dry location. To prevent condensation, maintain a uniform temperature. Store the unit in a heated building, allowing adequate air circulation and protection from dirt and moisture. Storing the unit outdoors could cause harmful condensation inside the transfer switch enclosure.

Read these safety instructions carefully before using this product!

**Danger**

Indicates a hazardous situation that, if not avoided, will result in death or serious injury.

HAZARD OF ELECTRIC SHOCK, EXPLOSION, OR ARC FLASH

- Apply appropriate personal protective equipment and follow safe electrical work practices.
- This equipment must only be installed and serviced by qualified electrical personnel.
- Before performing visual inspections, tests, or maintenance on the equipment, disconnect all sources of electric power. Assume that all circuits are live unless they are completely de-energized, tested, grounded, and tagged. Pay particular attention to the design of the power system. Consider all sources of power, including the possibility of backfeeding.
- Disconnect all sources of electric power before removing or making source side or load side connections to the transfer switch.
- Always use a properly rated voltage sensing device at all line and load connections to confirm transfer switch is disconnected from all live electrical sources.
- Turn off power supplying transfer switch before doing any other work on or inside switch.

Failure to follow these instructions could result in death or serious injury.

Operation, maintenance, and installation instruction

Automatic transfer
switches, Zenith ZTG
series ATS

OPERATION AND MAINTENANCE
INSTRUCTIONS, ZENITH
ZTG SERIES ATS,
CHAPTERS 1–8

INSTALLATION INSTRUCTIONS,
ZENITH ZTG SERIES ATS,
CHAPTERS 9–11

1

2

Operation and maintenance instruction

Automatic transfer switches, Zenith ZTG series ATS

1. Introduction	11
1.1 Hazard Categories	11
1.2 Definitions	12
1.3 Warranty	13
1.4 Product Specification	14
2. Product overview	15
2.1 General overview	16
2.1.1 Operation types	17
2.2 HMI	18
2.3 Zenith ZTG series features	19
2.4 Typical applications	22
2.5 Sequence of operations	24
2.5.1 Switching sequence / Automatic	24
2.6 Special features description	30
2.6.1 Automatic configuration	30
2.6.2 In-phase monitor	30
2.6.3 Powering supply scenarios	30

3. General operation	31
3.1 Position indication	31
3.2 Operating and locking	32
3.3 Manual handle operation	33
3.4 Return to automatic mode, operating by HMI	35
3.5 LED functionality in HMI	36
3.6 Using HMI	38
3.6.1 Keypad	38
3.6.2 Navigating in menu	38
4. Navigating HMI menu	39
4.1 Start screens	39
4.2 Using main menu and setting parameters	41
4.3 Menus and parameters	42
5. Electronic accessories	53
5.1 Using Ekip Connect -software	54
5.2 Using Ekip Bluetooth-module	55
5.2.1 LED indications	55
5.3 Using Ekip Programming -module	56
5.3.1 LED indications	56
5.4 Auxiliary power supply module	57
5.4.1 Electrical characteristics	57
5.4.2 LED indications	57

5.5 Using Ekip Signalling 2K-_ -module	58
5.5.1 Electrical characteristics of Ekip Signalling 2K-_ -module	58
5.5.2 Access from the display / Ekip Signalling 2K-_ -module	58
5.5.3 LED indications and inputs/outputs of Ekip Signalling 2K-_ -module	61
5.6 Using Ekip Com _ -modules	62
5.6.1 Ekip Com Modbus RTU -module	62
5.6.2 Ekip Com Profibus DP -module	65
5.6.3 Ekip Com DeviceNet -module	68
5.6.4 Ekip Com Modbus TCP -module	72
5.6.5 Ekip Com Profinet -module	76
5.6.6 Ekip Com EtherNet/IP -module	79
6. Troubleshooting	83
6.1 Alarms	83
6.2 Warnings	85
6.3 Information	86
7. Technical data	87
7.1 General technical data	87
7.2 Circuit diagrams	90
7.3 Overall dimensions	92
8. Maintenance	95

1. Introduction

This manual describes the installation, basic operation, and maintenance of the Zenith ZTG series (30-1200A, 200-480Vac) automatic transfer switches, manufactured by ABB. Installation instructions for the transfer switch and available accessories can be found in chapters 9 and 10.

1.1 Hazard Categories

The following important highlighted information appears throughout this document to warn of potential hazards or to call attention to information that clarifies a procedure.

Carefully read all instructions and become familiar with the devices before trying to install, operate, service or maintain this equipment.



Danger

Indicates a hazardous situation that, if not avoided, will result in death or serious injury.



Warning

Indicates a hazardous situation that, if not avoided, could result in death or serious injury.



Caution

Indicates a hazardous situation that, if not avoided, could result in minor or moderate injury. Failure to comply with these instructions may result in product damage.



Notice

It is used to notify of practices not related to personal injury. Failure to comply with these instructions may result in product damage.

1.2 Definitions

1

ATS

Automatic transfer switches

Ekip

Electronic accessories / Ekip-modules; communication, signaling and connectivity modules

HMI

Control interface (Human Machine Interface), operating and configuration

Programming port

Only for Ekip Programming and Ekip Bluetooth -modules (USB port)

Slide switch

Switch for operating mode selection (Hand - Locking - AUTO)

S1

SOURCE 1, power supply

S2

SOURCE 2, power supply

Zenith ZTG series ATS

General purpose commercial & industrial enclosed automatic transfer switches, product name

Load Shed

Digital output function for signaling a downstream load to disconnect. This functionality is different than the legacy Zenith R15 Load Shed which is an input for the ATS to disconnect generator when signaled.

1.3 Warranty

This document is based on information available at the time of its publication. While efforts have been made to ensure accuracy, the information contained herein does not cover all details or variations in hardware and software, nor does it provide for every possible contingency in connection with installation, operation, and maintenance. Features may be described herein that are not present in all hardware and software systems.

ABB Zenith assumes no obligation of notice to holders of this document with respect to changes subsequently made. ABB Zenith makes no representation or warranty, expressed, implied, or statutory, and assumes no responsibility for the accuracy, completeness, sufficiency, or usefulness of the information contained herein. No warranties of merchantability or fitness for purpose shall apply.

Contact your local sales office if further information is required concerning any aspect of the automatic transfer switch operation or maintenance.

Warranty Period

The Warranty Period for ZTG series transfer switch products is twenty-four (24) months from the date of shipment.

Notes: This warranty is valid only in the United States and for products sold and installed within seller-specified countries.

Replacement parts are warranted for a period of 90 days when installed by a factory or an authorized service station.

Contact Service team at: +1 800 637 1738

1.4 Product Specification

Quality Assurance

All ABB Zenith automatic transfer switches have been designed and manufactured to the highest technical standards. Strict procedures ensure first-class product quality.

Product Serial Number

Please have the serial number available when communicating about the automatic transfer switch. The serial number can be found on the product nameplate affixed to each power panel assembly. See example below.

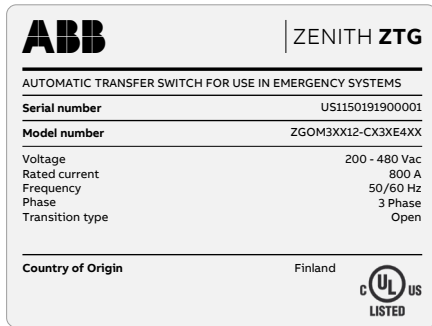

Figure 1.1: Sample nameplate

Product Rating / Applicable Standards

For UL 1008 'withstand' and 'close on short circuit' ratings, refer to ABB publication number TB-1102.

2. Product overview

Zenith ZTG series automatic transfer switches, from 30 A up to 1200 A, are designed for use in general purpose commercial and industrial low voltage automatic transfer switch applications. Zenith ZTG series automatic transfer switches can be operated electrically by LCD control interface (HMI) or manually by using the handle. You can select the operating mode by the slide switch (Hand - Locking - AUTO) on switch front. Configuration is done by LCD HMI.

The available operation types for automatic transfer switches:

- Open (standard) transition Zenith ZTG series ATS, type codes beginning ZGO_from 30-1200 A, 200-480 Vac
- Delayed transition Zenith ZTGD series ATS, type codes beginning ZGD_from 30-1200 A, 200-480 Vac

2.1 General overview

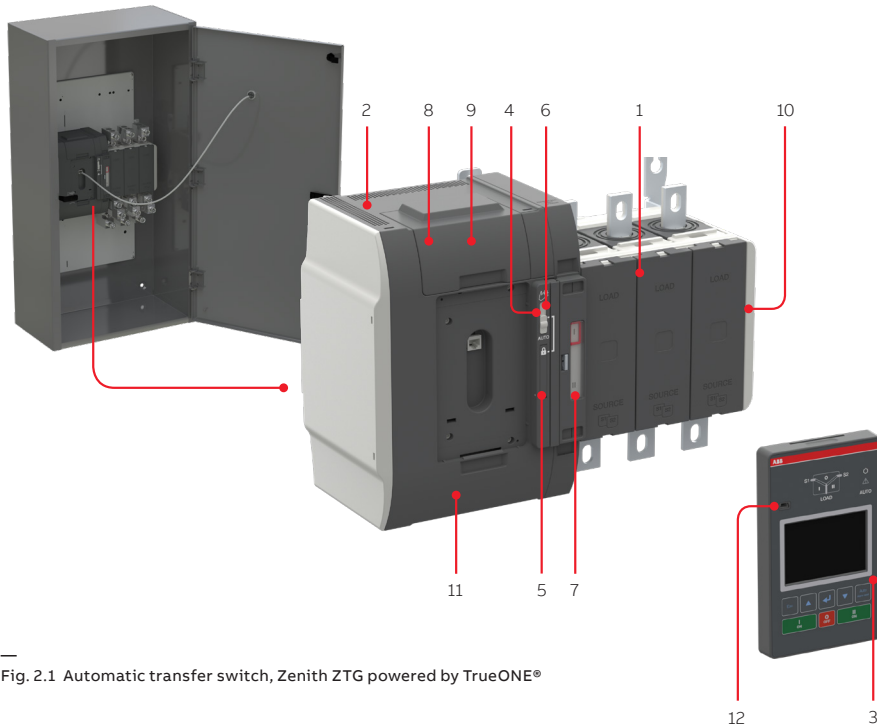

Fig. 2.1 Automatic transfer switch, Zenith ZTG powered by TrueONE®

- 1 Automatic transfer switch
- 2 Embedded ATS control unit and mechanism
- 3 HMI unit, ZTG LCD
- 4 Slide switch (Hand - Locking - AUTO) for selection of the operation mode
- 5 Padlocking the automatic transfer switch to prevent automatic and manual operation
- 6 Handle for manual operation
- 7 Position indication
- 8 Terminals for control circuit connections (behind the cover)
- 9 Place for connectivity modules (aux power supply, com and signaling)
- 10 Place for auxiliary contact block
- 11 Location of product identification label
- 12 Programming port, only for Ekip Programming module and Ekip Connect software

2.1.1 Operation types

In this table you can find the differences of the automatic transfer switch open and delayed transition operation types. Due to the different transition types, there are variances with HMI and on wiring of I/O contacts. For more information on HMIs, see chapter 2.2.





Operation types, ZTG series ATS		Ekip-modules suitable
Delayed transition, ZTGD	Open transition, ZTG	
<p>S1 I O II S2</p>  <p>Load</p>	<p>S1 I II S2</p>  <p>Load</p>	
ZTG series HMI (with LCD-screen) and connections of control circuit		
		<p>Suitable</p> 
		

Table 2.1 The differences of level types / operation types and the suitability of Ekip-modules



2.2 HMI

The HMI is the control interface (Human Machine Interface) of the ATS.

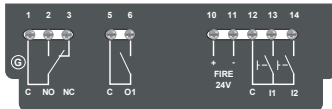
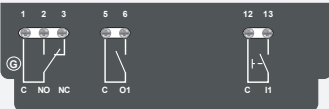
Zenith ZTG series has an LCD HMI with push buttons. The HMI is used for configuring parameters for automatic operation.

ZTG:
HMI with
LCD-screen



I - O - II (or II - O - I)



I - II (or II - I)

Fig. 2.2 The HMI form will correspond to the type of ZTG series - open or delayed transition

2.3 Zenith ZTG series features

Feature comparison

ZTG(D) controls (LCD)

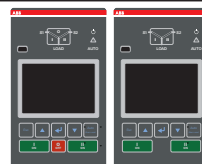

Ampere sizes available	UL: 30-1200 A
Rated voltage	200-480 Vac
Rated frequency	50 / 60 Hz
Phase system	Single and Three
Number of poles	2, 3 and 4
Neutral configuration	
Switched	Yes
Product type	
Open transition (I-II)	Yes
Delayed transition (I - O - II or II - O - I)	Yes
Voltage and frequency settings	
Pick up SOURCE 1 Voltage	71-99 %, 101-119 %
Drop out SOURCE 1 Voltage	70-98 %, 102-120 %
Pick up SOURCE 2 Voltage	71-99 %, 101-119 %
Drop out SOURCE 2 Voltage	70-98 %, 102-120 %
Pick up SOURCE 1 Frequency	80.5-99.5 %, 100.5-119.5 %
Drop out SOURCE 1 Frequency	70-99 %, 101-120 %
Pick up SOURCE 2 Frequency	80.5-99.5 %, 100.5-119.5 %
Drop out SOURCE 2 Frequency	70-99 %, 101-120 %
Time delay settings	
Override momentary SOURCE 1 Outage, sec	0-60
Transfer from SOURCE 1 to SOURCE 2, sec	0-3600
Override momentary SOURCE 2 Outage, sec	0-60
Transfer from SOURCE 2 to SOURCE 1, min	0-120
Generator stop delay, min	0-60
Center-OFF delay, sec	0-300

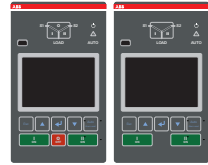
Feature comparison**ZTG(D) controls (LCD)**

Pre-transfer delay S1 to S2, sec	0-300
Post-transfer delay S1 to S2, sec	0-300
Pre-transfer delay S2 to S1, sec	0-300
Post-transfer delay S2 to S1, sec	0-300
Elevator Pre-signal delay S1 to S2, sec	0-300
Elevator Post-signal delay S1 to S2, sec	0-300
Elevator Pre-signal delay S2 to S1, sec	0-300
Elevator Post-signal delay S2 to S1, sec	0-300
Load shed delay, sec	0-300
Source failure detections	
No voltage	Yes
Undervoltage	Yes
Overvoltage	Yes
Phase missing	Yes
Voltage unbalance	Yes
Invalid frequency	Yes
Incorrect phase sequence	Yes
Features	
Controls	LCD + keys
LED indications for ATS, S1 and S2 status	Yes
Open transition - Standard digital inputs/outputs	1 / 1
Delayed transition - Standard digital inputs/outputs	2 / 1
Programmable digital inputs/outputs	Yes
Auto config (voltage, frequency, phase system)	Yes
Source priority	SOURCE 1/2, No priority
Manual re-transfer	Yes
In-phase monitor	Yes
Genset exercising: on-load, off-load	Yes

Feature comparison	ZTG(D) controls (LCD)
	
In-built power meter module	No
Load shedding	Yes
Real time clock	Yes
Event log	Yes
Field-mount accessories	
Auxiliary contacts for position indication	Yes
Digital input/output modules	Yes
12-24 Vdc aux supply module for controller	Yes
Communication modules	Yes
Connectivity	
Modbus RS485	Yes
Modbus/TCP	Yes
Profibus DP	Yes
ProfiNet	Yes
DeviceNet	Yes
Ethernet IP	Yes
Monitoring via ABB Ability™: EDCS	Yes
Enclosures	
Type 1, 3R, 4, 12, and 4X	Yes
For applications	
Mains - Mains	Yes
Mains - Generator	Yes

Table 2.2 ATS features not limited to what is in the table above

2.4 Typical applications

1

Zenith ZTG series automatic transfer switches from 30 A up to 1200 A, are designed for use in emergency or standby systems to choose and to switch between two power sources. See possible supply phase scenarios on next page. You have to define your own supply phase system - reference Chapter 4 / Navigating menu / Parameters: Power distribution systems. Factory setting: 3 phases with neutral.

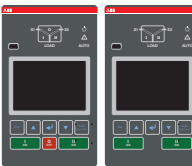
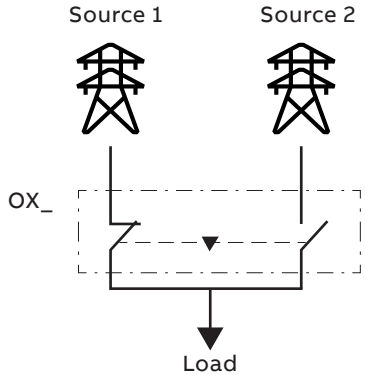
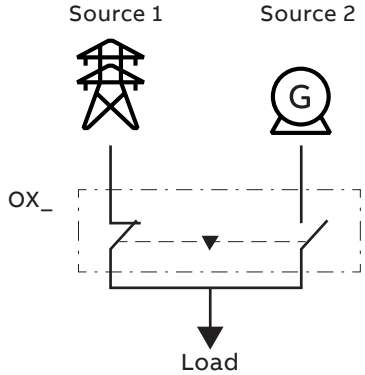
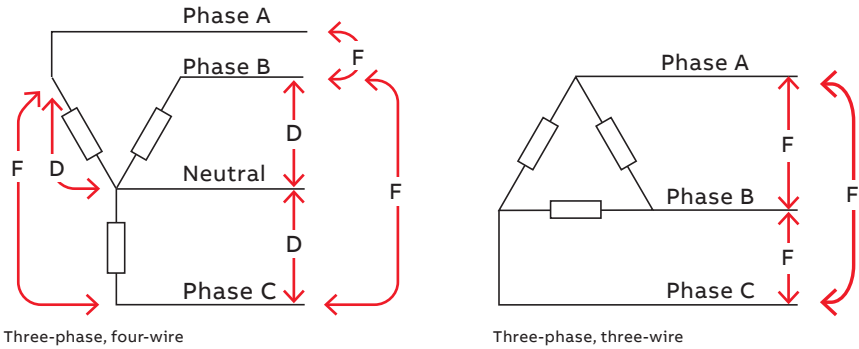
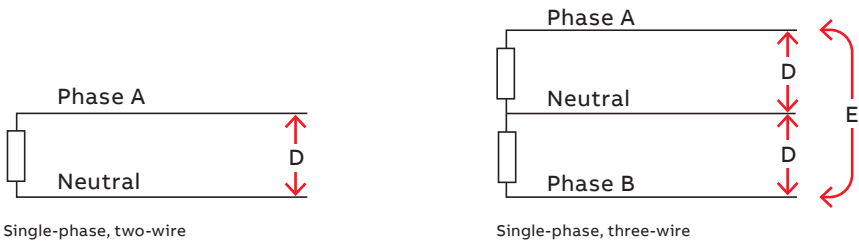
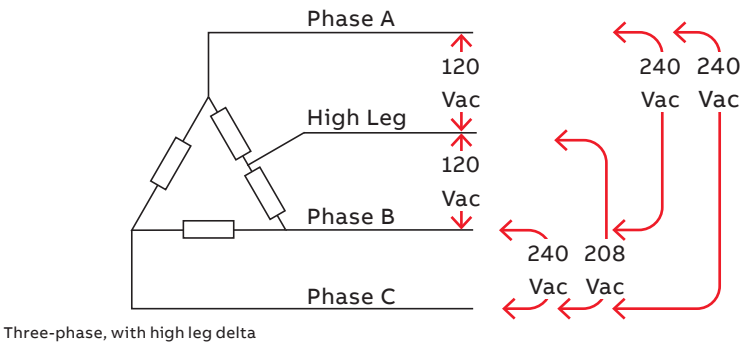

Fig. 2.3 Typical applications of automatic transfer switches



D	E	F
200-480 Vac L-N	200-480 Vac L-L	200-480 Vac L-L



A07482

Fig. 2.4 Possible supply phase scenarios

2.5 Sequence of Operations

1

2.5.1 Switching sequence / Automatic

2.5.1.1 SOURCE 1 Priority (SOURCE 2 = Generator)

The switching sequence can be summarized in the following steps:

- An anomaly occurs on SOURCE 1
- Override momentary S1 outage delay
- Generator start
- SOURCE 2 OK
- Transfer from S1 to S2 delay
- Pre-transfer signal on
- Load shed signal on
- Pre-transfer S1 to S2 delay
- Load shed delay
- Transfer switch (SOURCE 1) to position O
- Center-off delay (only with Delayed transition I - O - II type)
- Transfer switch (SOURCE 2) to position II
- Post-transfer S1 to S2 delay
- Pre-transfer signal off

The re-transfer sequence can be summarized in the following steps:

- SOURCE 1 is restored
- Transfer from S2 to S1 delay
- Pre-transfer signal on
- Pre-transfer S2 to S1 delay
- Transfer switch (SOURCE 2) to position O
- Center-off delay (only with Delayed transition I - O - II type)
- Transfer switch (SOURCE 1) to position I
- Load shed signal off
- Generator stop delay
- Post-transfer S2 to S1 delay
- Pre-transfer signal off
- Generator stop
- SOURCE 2 off

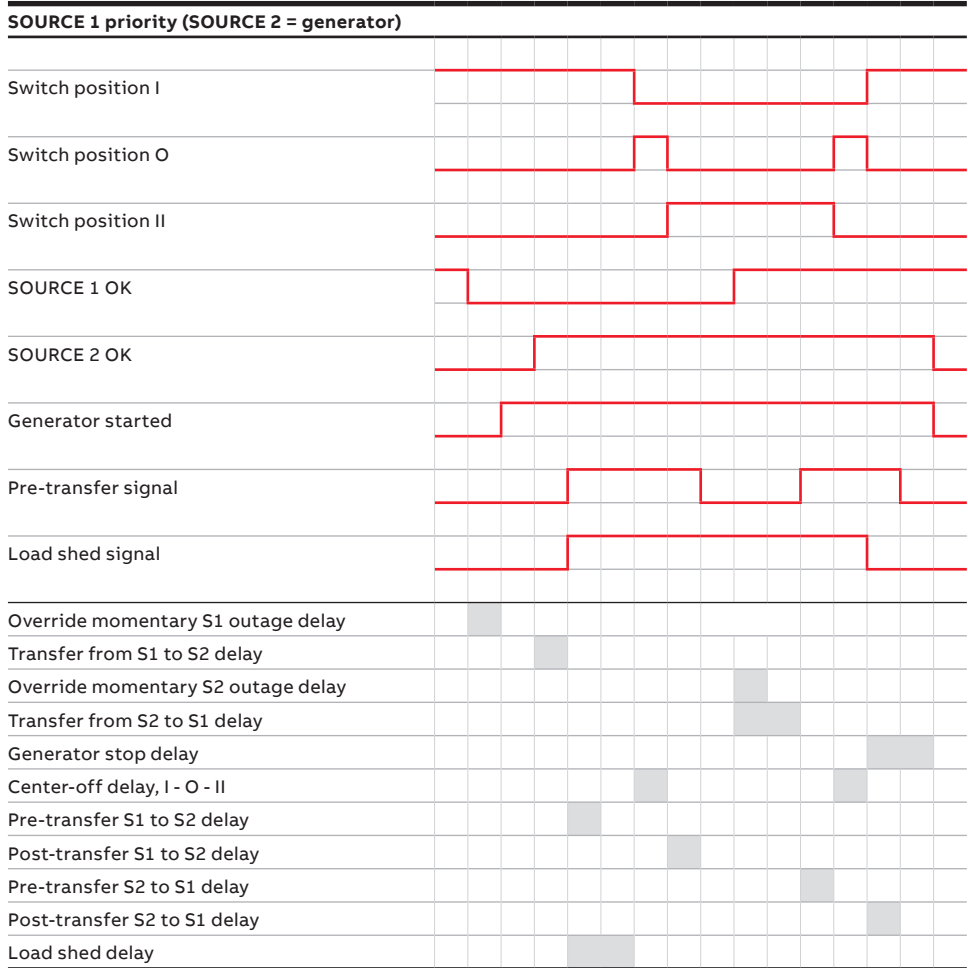

Table 2.3 Automatic Switching Sequences, SOURCE 1 Priority (SOURCE 2 = Generator)

2.5.1.2 SOURCE 2 Priority (No generator)

The switching sequence can be summarized in the following steps:

- An anomaly occurs on SOURCE 2
- Override momentary S2 outage delay
- Transfer from S2 to S1 delay
- Pre-transfer signal on
- Load shed signal on
- Pre-transfer S2 to S1 delay
- Load shed delay
- Transfer switch (SOURCE 2) to position O
- Center-off delay (only with Delayed transition I - O - II type)
- Transfer switch (SOURCE 1) to position I
- Post-transfer S2 to S1 delay
- Pre-transfer signal off

And the re-transfer sequence can be summarized in the following steps:

- SOURCE 2 is restored
- Transfer from S1 to S2 delay
- Pre-transfer signal on
- Pre-transfer S1 to S2 delay
- Transfer switch (SOURCE 1) to position O
- Center-off delay (only with Delayed transition I - O - II type)
- Transfer switch (SOURCE 2) to position I
- Load shed signal off
- Post-transfer S1 to S2 delay
- Pre-transfer signal off

SOURCE 2 priority (no generator)

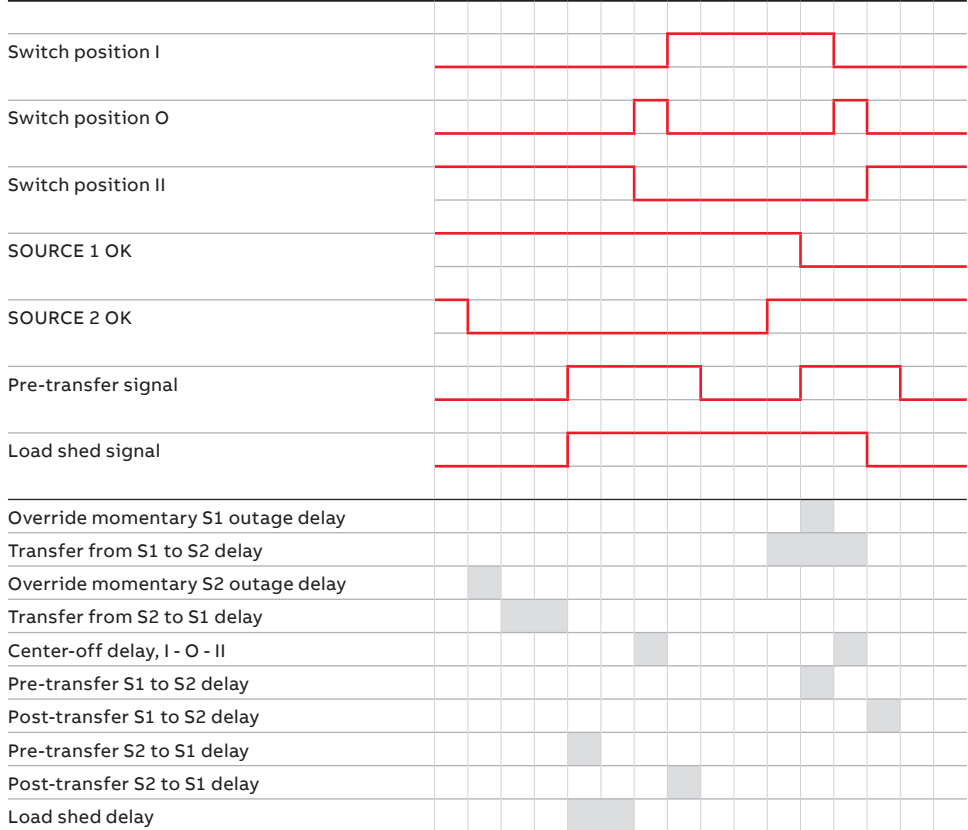

Table 2.4 Automatic Switching Sequences, SOURCE 2 Priority (No generator)

2.5.1.3 No Source Priority (Generator and load shed usage disabled)

The switching to available source can be summarized in the following steps:

- An anomaly occurs on SOURCE 1
- Override momentary S1 outage delay
- Transfer from S1 to S2 delay
- Pre-transfer signal on
- Pre-transfer S1 to S2 delay
- Transfer switch (SOURCE 1) to position O
- Center-off delay (only with Delayed transition I - O - II type)
- Transfer switch (SOURCE 2) to position II
- Post-transfer S1 to S2 delay
- Pre-transfer signal off

When an anomaly occurs in the source in-use, the re-transfer to available source can be summarized in the following steps:

- SOURCE 1 is restored
- An anomaly occurs on the SOURCE 2
- Transfer from S2 to S1 delay
- Pre-transfer signal on
- Pre-transfer S2 to S1 delay
- Transfer switch (SOURCE 2) to position O
- Center-off delay (only with Delayed transition I - O - II type)
- Transfer switch (SOURCE 1) to position I
- Post-transfer S2 to S1 delay
- Pre-transfer signal off

No source priority (generator and load shed usage disabled)

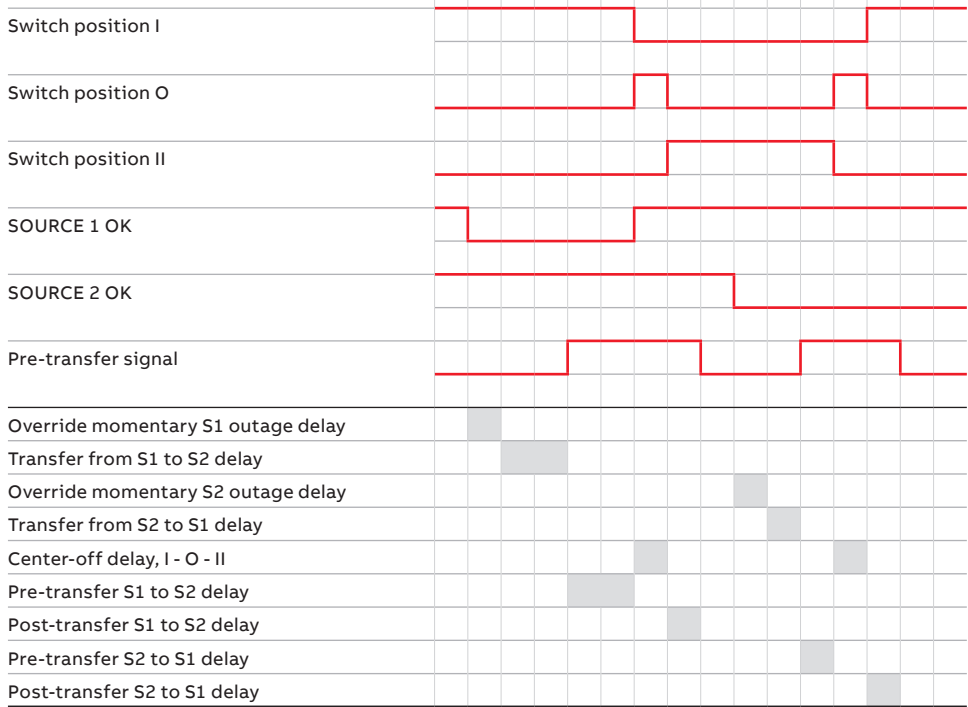

Table 2.5 Automatic Switching Sequences, No Source Priority (Generator and load shed usage disabled)

2.6 Special features description

2.6.1 Automatic configuration

Basic system parameters can be automatically configured from the HMI: rated voltage, rated frequency, each supply power distribution system type, and neutral location will be recognized and set by the controller. Other parameters are set to factory values; see Chapter 4, Navigating menu.

2.6.2 In-phase monitor

In-phase monitor is a feature that calculates the phase difference of supply lines, preventing transfer when sources are not in sync. The user can set On/Off from the HMI. When the in-phase monitor is set to On, the device measures and detects when both sources are in sync with each other. The ATS will allow transfer from SOURCE 1 (S1) to SOURCE 2 (S2) only when they are in sync with each other. Any of these conditions will prevent source transfer when In-phase monitor is set to On:

- Phase difference between sources remains greater than 5 degrees
- Phase order between sources is not the same
- Voltage amplitude is out of range
- Phase is missing
- Voltage is asymmetric
- Frequency is out of range

2.6.3 Powering supply scenarios

Device can be powered by the the following methods:

- Direct from SOURCE 1 or SOURCE 2: Controller and HMI are powered and ATS can be operated electrically.
- Auxiliary power supply module, OXEA1: Controller and HMI are powered, but load transfer cannot be performed.
- Programming port on HMI (USB port): Only the main board is powered. Allows software update to main device and connection of Ekip Connect commissioning tool.

3. General operation

3.1 Position indication

Contact movement and position indication is indicated in the figure below, on left side: Open transition I - II (or II - I) and on right side: Delayed transition I - O - II (or II - O - I)

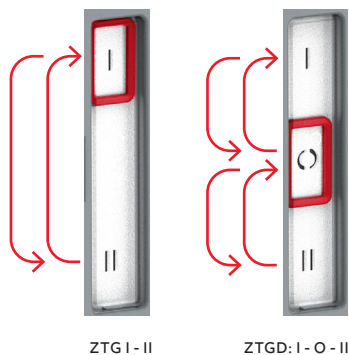

Fig. 3.1 Contact movement / position indication:
Type ZTG, Open transition; Type ZTGD, Delayed transition

3.2 Operating and locking

The operation mode is selected by using the slide switch (Hand - Locking - AUTO) located on the front of the automatic transfer switch (ATS).

- **Hand-position = Manual mode**, enabling emergency manual operation using the handle. ATS functionality is disabled when in Hand position.
- **Lock-position = Locking mode**, padlocking the automatic transfer switch in a specific position to prevent automatic and manual operation.



Notice

The handle has to be in its stored position (not in use), after which the slide switch will move to the Locking mode automatically and the switch is allowed to be padlocked. To set the operating handle back to its place, refer to the left most picture in Fig. 3.6.

- **AUTO-position = Automatic control mode enabled**, ATS is operable in Automatic mode or from the HMI manual control keys. When the slide switch is moved to the AUTO position, the ATS is functioning immediately in the automatic control mode.



Manual mode

Automatic mode

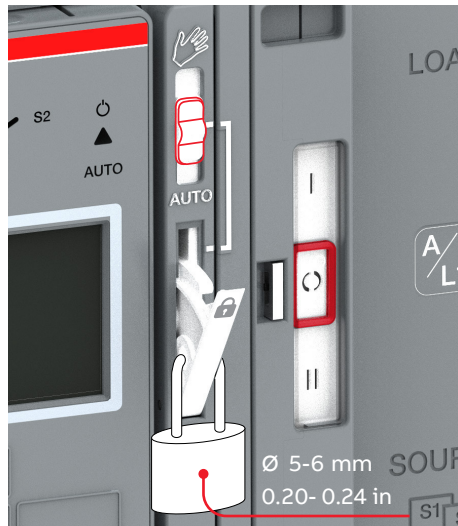

Locking mode

Fig. 3.2 Above the selection of the operation modes (Manual or Automatic) by the slide switch. Below padlocking the automatic transfer switch; The handle has to set standby slot (not in use), after that the slide switch will move to the Locking mode automatically and the switch is allowed to be padlocked.

3.3 Manual handle operation



Warning

Verify the condition of power source prior to manually transferring. Manual operation may result in out-of-phase transfer when both sources are energized.

To mount the handle in the operating position, turn the slide switch to the Manual mode (Hand), lift the handle from its place inside and place it to the operating position.

More information, see animation: Manual and automatic operation - TruONE® ATS (<https://youtu.be/bosvSPVi2sM>).



Fig. 3.3 Mounting of the handle in the operating position

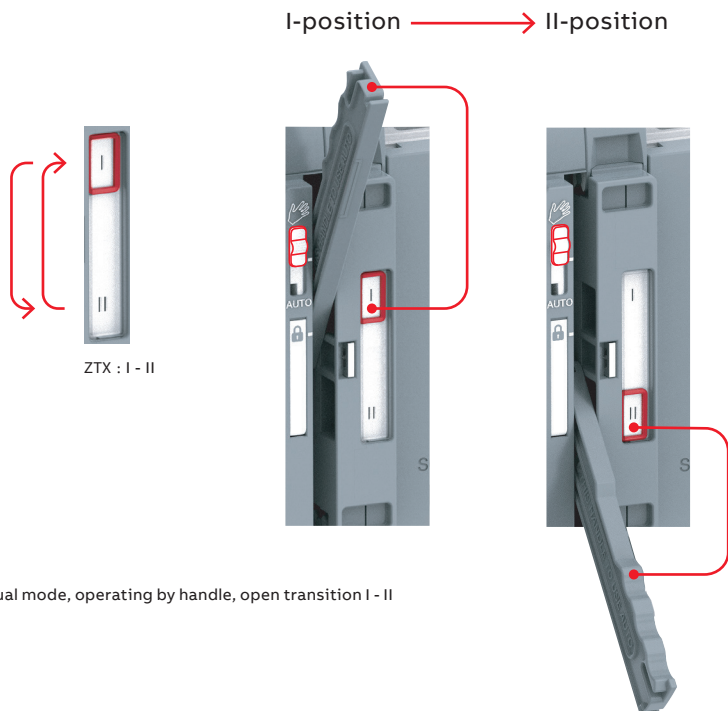

Fig. 3.5 Manual mode, operating by handle, open transition I - II

3.4 Return to Automatic mode, operating by HMI

When operating the automatic transfer switch by HMI, turn the slide switch to Automatic mode (AUTO). Remark! The handle has to be standby slot (not in use) before turning to automatic mode.



Notice

When the slide switch is moved to the AUTO position, the ATS will enter auto mode after a 3 second delay.

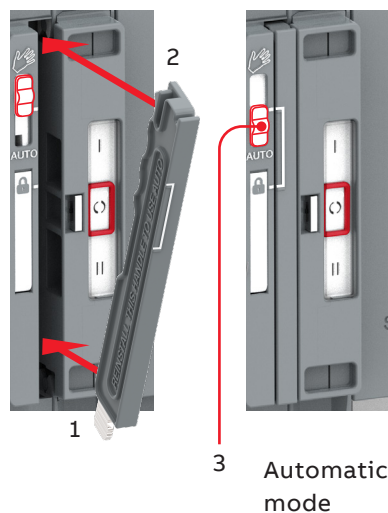
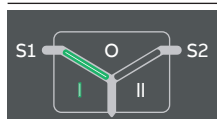



Fig. 3.6 The operating handle must set back to standby slot before moving to the automatic mode

I, II and O ledsON, fixed light 

Switch position is indicated with fixed light in I, O or II led. Only one can be on simultaneously

Flash/1 s, 50%/50% 

Delay ongoing. Going to move away from the blinking status

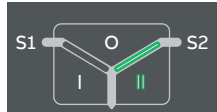
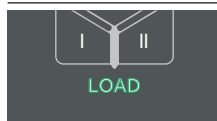
**Load led**ON 

Supply ok and connected to load

OFF 

Not connected to load

Auto ledON, fixed light 

Switch is in automatic mode

Flash/1 s, 50%/50% 

Test on load

Flash/1 s, 90%/10% 

Test off load

5 flashes/1 s, 50%/50% 

Autoconfig completed

Alarm ledOFF 

No alarms

ON, fixed light 

Handle attached, locked, other alarm

2 quick flashes/1s 

Control Alarm

5 flashes/1 s, 50%/50% 

Auto configuration ongoing

Flash/1 s, 50%/50% 

Control Retry

Flash/1 s, 10%/90% 

Auto mode off

Table 3.1 LED functionality

3.6 Using HMI

1

3.6.1 Keypad

- 1 **Esc:** Go back in menu. When pressed in root page, the alarm list is shown.
- 2 **Up, Down:** Move in menu or choose parameter values.
- 3 **Enter:** Opens menu from root page. Enter a new menu page and accept function. Also, selects parameters.
- 4 **Auto (Alarm reset):** If there are any alarms, by pressing this button you can reset all alarms. If there are not alarms, ATS will be set to Auto-mode.
- 5 **I ON:** Operate switch to I position.
- 6 **II ON:** Operate switch to II position.
- 7 **O OFF:** Operate switch to O position, only in delayed transition switches (ZTGD), I - O - II.

3.6.2 Navigating in menu

See the menu tree in Chapter 4.

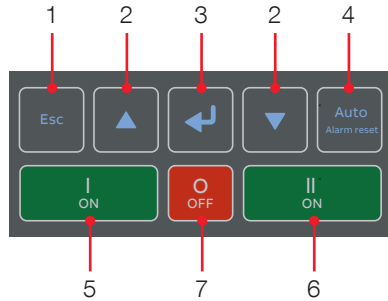

ZTGD, delayed transition, I - O - II

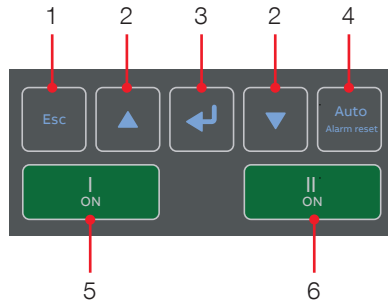

ZTG, open transition, I - II

Fig. 3.8 Keypad in HMI with LCD screen

4. Navigating HMI menu

4.1 Start Screens

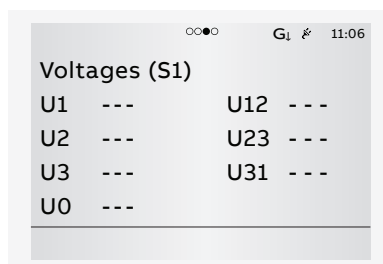
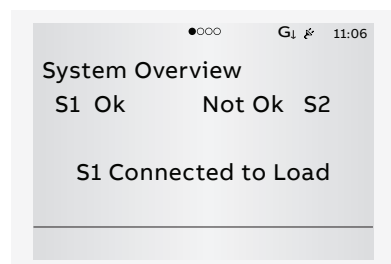

Fig. 4.1 From System Overview screen you will find Switch status and Supply info views, and by pressing Up and Down -keys (2), you can go forward to see Voltages and Synchronization view, see the table below.

Start screens

System Overview (Switch status)

Shows voltages and frequencies of both supplies and the switch position.

Supply info view

Shows Phase to Phase voltages of both supplies and the frequencies.

Voltages (S1)

S1 phase voltages

S1 line voltage

Voltages (S2)

S2 phase voltages

S2 line voltage

Synchronization view

Enabled only when In-phase monitor is on.

Show the time to next sync, sync period

Current view

Enabled only when current measurement module is connected.

Phase currents

Neutral current

Residual current

Active Power view

Enabled only when current measurement module is connected.

Active power by phase

Total active power

Reactive Power view

Enabled only when current measurement module is connected.

Reactive power by phase

Total reactive power

Apparent Power view

Enabled only when current measurement module is connected.

Apparent power by phase

Total apparent power

Energy Counters view

Enabled only when current measurement module is connected.

Active energy by source

Reactive energy by source

Apparent energy by phase

Total active energy

Total reactive energy

Total apparent energy

1

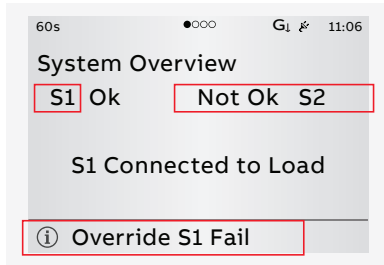

Fig. 4.2 Location of the small icons and the alarms

Alarm List

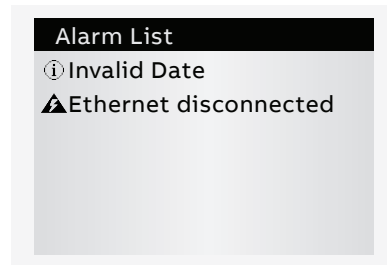

Fig. 4.3 When pressed Esc-key (1) in System Overview -pages, the alarm list is shown.

The small icons in System Overview -pages are:

On upper right corner

●○○○ Indicates the amount of pages and the page where you are at the moment



Auxiliary voltage connected

11:06 Time



Generator selected, not started



Generator selected, started

On upper left corner

60s Time delay, in Alarm list you can see the name of delay at the same time, e.g. Override S1 Fail

On the lower edge of the screen you can see the Alarms. When pressed Esc-key (1) in System Overview -pages, the alarm list is shown.



Notice

The default values are marked in the menu tree by *-marking.

For more information, see chapter 6, Troubleshooting

4.2 Using main menu and setting parameters

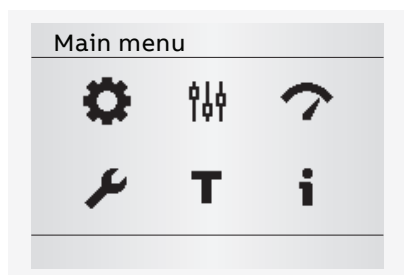

Fig. 4.4

By pressing Enter-key (3) you will move to the main menu page of Operation, Parameters, Measurements, Settings, Test and About, see the table below for the selections. You can move in menu or choose parameter values by Up and Down -keys (2) and by Enter-key (3) you can accept function and enter a new menu page. By Esc-key (1) you can go back in menu.

The default password is 00001, enter the password when prompted (see Fig. 4.5).

The keypad is described In Chapter 3.6, see Fig. 3.8. By pressing the Enter-key (3) you can:

- open the menu in root page
- enter a new menu page
- accept the function

By pressing Up and Down -keys (2) you can:

- move in the menu
- choose the parameter value

By pressing Esc-key (1) you can:

- go back in the menu



Notice

When you have changed the parameter, always go back in the menu by pressing Esc-key and when prompted confirm changes with Enter-key.

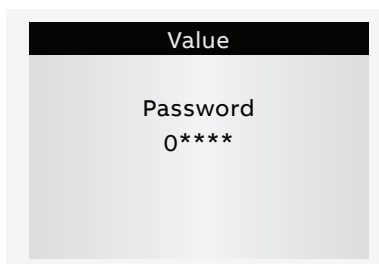

Fig. 4.5 Enter the password when asked, choose the right number by Up and Down -keys (2) and confirm by Enter-key (3), go forward setting number after number

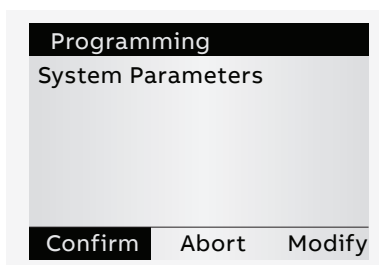





Fig. 4.6 After you have changed the parameter, always go back in the menu by pressing Esc-key and when prompted confirm changes with Enter-key

4.3 Menus and Parameters

Operation		*Default
	Bypass Time Delay	
		Bypass any currently running time delay
HMI Control Keys (I, II)		Enabled*
		Disabled
	Energy Counters	Reset

Parameters		*Default
	System parameters	
	Start Automatic Configuration	
	Power distribution systems (see Fig. 2.2)	
	Source 1	1 Phase, 2 Wire
		2 Phases, 3 Wire (Split Neutral)
		3 Phases, no Neutral (3ph3w)
		3 Phase with Neutral (3ph4w)*
		3 Phase, High-Leg Delta
	Source 2	1 Phase, 2 Wire
		2 Phases, 3 Wire (Split Neutral)
		3 Phases, no Neutral (3ph3w)
		3 Phase with Neutral (3ph4w)*
		3 Phase, High-Leg Delta
	Rated Voltage	
	200 V (3ph), 208 V (3ph), 220 V (3ph), 230 V (3ph), 240 V (3ph), 277 V (3ph), 347 V (3ph), 380 V (3ph), 400 V (3ph)* , 415 V (3ph), 440 V (3ph), 460 V (3ph), 480 V (3ph), 200 V (1ph), 220 V (1ph), 230 V (1ph), 240 V (1ph), 254 V (1ph), 265 V (1ph), 277 V (1ph), 318 V (1ph), 333 V (1ph), 347 V (1ph), 380 V (1ph), 400 V (1ph), 415 V (1ph), 440 V (1ph), 460 V (1ph), 480 V (1ph)	
Rated Frequency		
50 Hz*		
60 Hz		
Neutral Position		
Pole 4*		
Pole 1		
Phase Sequence		
ABC*		
ACB		
Not Enabled		

Continued on the next page

Parameters (continued)		*Default	
	Device Parameters		
	In-phase Monitor		
	Enable	Off*	
		On	
	Synchronization Delay	0*-60 s	
	Time Delays		
	Override S1 Failure	0-60 s (2* s)	S1 priority: How long the device is waiting S1 recovery before starting transfer sequence to S2. S2 priority: How long the device is keeping the load on failed S1 although S2 is already available.
	Transfer from S1 to S2	0-60 min (2* s)	S1 priority: How long the device is keeping the load on failed S1 after S2 becomes available. S2 priority: How long the device waits before transfer sequence back to available S2 begins. This delay is bypassed by 'Override S1 Failure' in case of S1 failure.
	Pre-transfer S1 to S2	0*-300 s	Enabled only when any digital output is configured as 'Pre-transfer Signal'. How long the device is keeping pre-transfer signal activated before transferring from S1 to S2.
	Center-off	0*-300 s	Only delayed transition I-O-II type. How long the switch is stopped at position O while transferring from S1 to S2 or from S2 to S1 and the original source is not completely down. Center-OFF delay is bypassed in case all phases are missing from the original source which we are leaving.
Post-transfer S1 to S2	0*-300 s	Enabled only when any digital output is configured as 'Pre-transfer Signal'. How long the device is keeping pre-transfer signal activated after transferring from S1 to S2.	
Override S2 Failure	0-60 s (2* s)	S1 priority: How long the device is keeping the load on failed S2 although S1 is already available. S2 priority: How long the device is waiting S2 recovery before starting transfer sequence to S1.	

Continued on the next page

Parameters (continued)		*Default	
	Device Parameters (continued)		
	Time Delays (continued)		
	Transfer from S2 to S1	0-120 min (2* s)	S1 priority: How long the device waits before transfer sequence back to available S1 begins. This delay is overridden by 'Override S2 Failure' in case of S2 failure. S2 priority: How long the device is keeping the load on failed S2 although S1 is already available.
	Pre-transfer S2 to S1	0*-300 s	Enabled only when any digital output is configured as 'Pre-transfer Signal'. How long the device is keeping pre-transfer signal activated before transferring from S2 to S1.
	Post-transfer S2 to S1	0*-300 s	Enabled only when any digital output is configured as 'Pre-transfer Signal'. How long the device is keeping pre-transfer signal activated after transferring from S2 to S1.
	Generator Stop	0-60 min (5* min)	Enabled only when generator is in use. Generator cooling time, how long the device is keeping the generator running without load after returning to priority source.
	Load Shed	0*-60 s	Enabled only when any digital output is configured as 'Load Shed'. How long before the transfer from priority to non-priority source the device activates load shed signal.
	Elevator Pre-signal S1 to S2	0*-60 s	Enabled only when any digital output is configured as 'Elevator pre-signal'. How long the device is keeping pre-signal signal activated before transferring from S1 to S2.
	Elevator Post-signal S1 to S2	0*-60 s	Enabled only when any digital output is configured as 'Elevator pre-signal'. How long the device is keeping pre-signal signal activated after transferring from S1 to S2.
	Elevator Pre-signal S2 to S1	0*-60 s	Enabled only when any digital output is configured as 'Elevator pre-signal'. How long the device is keeping pre-signal signal activated before transferring from S2 to S1.
Elevator Post-signal S2 to S1	0*-60 s	Enabled only when any digital output is configured as 'Elevator pre-signal'. How long the device is keeping pre-signal signal activated after transferring from S2 to S1.	

Continued on the next page

Parameters (continued)		*Default
 Device Parameters (continued)		
Voltage & Frequency Setpoints		Defines the voltage and frequency limits for source being acceptable. Source has an anomaly when measured voltage/frequency goes out of range drop-out lower/drop-out Upper. Source becomes acceptable when measured voltage/frequency goes back in range pick-up lower/pick-up higher.
S1 Setpoints		
S1 Drop-out Voltage	Upper Threshold	102-120 % Un (115* % Un)
	Lower Threshold	70-98 % Un (85* % Un)
S1 Pick-up Voltage	Upper Threshold	101-119 % Un (114* % Un)
	Lower Threshold	71-99 % Un (86* % Un)
S1 Drop-out Frequency	Upper Threshold	101-120 % fn (115* % fn)
	Lower Threshold	80-99 % fn (85* % fn)
S1 Pick-up Frequency	Upper Threshold	100.5-119.5 % fn (114* % fn)
	Lower Threshold	80.5...99.5 % fn (86* % fn)
S2 Setpoints		
S2 Drop-out Voltage	Upper Threshold	102-120 % Un (115* % Un)
	Lower Threshold	70-98 % Un (85* % Un)
S2 Pick-up Voltage	Upper Threshold	101-119 % Un (114* % Un)
	Lower Threshold	71-99 % Un (86* % Un)
S2 Drop-out Frequency	Upper Threshold	101-120 % fn (115* % fn)
	Lower Threshold	80-99 % fn (85* % fn)
S2 Pick-up Frequency	Upper Threshold	100.5-119.5 % fn (114* % fn)
	Lower Threshold	80.5-99.5 % fn (86* % fn)
Generator Exercisers		Switch and generator functioning can be tested automatically and also periodically by using four independent exerciser events. Test on load function starts the generator and transfers the load to it. Test off load function only starts the generator for the duration of the event. Overlapping events are prioritized, event 1 has the highest priority.
Exerciser 1 / 2 / 3 / 4		
Status	Disabled* Non-periodic Daily Weekly Bi-weekly Monthly Yearly	

Continued on the next page

Parameters (continued)	*Default
	
Device Parameters (continued)	
Generator Exercisers (continued)	
Exerciser 1 / 2 / 3 / 4 (continued)	
Function	No Function*
	Test on Load
	Test off load
Duration (hh:mm:ss)	00:00:00-24:00:59 (00:01:00*)
Time (hh:mm)	Starting time of the event: 00:00*-23:59
Date (month day, year)	Starting date of the event Jan 01, 2000 (---*)
Application	
S1-Transformer/S2-Generator*	
S2-Transformer/S1-Generator	
2 Transformers/S1 Priority	
2 Transformers/S2 Priority	
2 Transformers/No Priority	
Manual Retransfer	
Off*	Automatic retransfer sequence enabled. Load is automatically retransferred to priority source upon the restoration of priority source.
On	Automatic retransfer sequence disabled. Load will be kept on non-priority source until operator manually (by HMI or manual handle) or remotely operates the load back to priority source. Load is also retransferred when the feature is set OFF.
Commit Transfer	
Off*	If priority source fails, device cancels the transfer sequence to non-priority source (generator) if priority source returns before non-priority source becomes acceptable.
On	If priority source fails, device continues transfer sequence to non-priority source (generator) even if priority returns before non-priority source becomes acceptable. Retransfer sequence according to time delays.
Transfer to Dead Source	
On*	User can transfer to an unavailable source by using HMI keys I/II or by a remote command.
Off	Transfer to an unavailable source is disabled.

Measurements

Switch Diagnostics

Total operations	I-O-II switches: Total number of transfers I-O, O-II, II-O and O-I. I-II switches: Total number of transfers I-II and II-I.
Manual operations	Total transfers operated by the handle.
Number of load transfers	Total number of transfers I-II and II-I.
Transfer time	Time it took to transfer the load between sources (ms).
Source fail transfers	Total number of automatic transfers due to source failures.
Days energized	
Total time on S1	Hours
Total time on S2	Hours
Time S1 available	Minutes
Time S2 available	Minutes
Last generator start	MMM DD, YYYY hh:mm:ss
Generator starting time	How long it took for the generator to become acceptable after latest start (s).
In-phase time	How long it took for the in-phase monitor to achieve synchronized transfer (s).

Event Log 250 time stamped events, latest first.

Harmonics Harmonic components up to 15th are calculated for the selected phase.

Measured Phase	Disabled*
	Phase 1
	Phase 2
	Phase 3
Voltage	Total distortion THD for each phase of both voltage sources.
	S1 Components Each harmonic component of the selected S1 phase.
	S2 Components Each harmonic component of the selected S2 phase.

Power Factor Enabled only when current measurement module is connected.

Settings		*Default
 Standard I/O Settings		
I01 / I02 / I03		
Function	No function	Input disabled.
	Emergency Stop* (default in I01)	Transfers to O position in delayed transition I-O-II type switches. Disables automatic control mode in both delayed and open transition types.
	Remote Test On Load* (default in I02)	Start/stop test on load sequence in rising (NO) or falling (NC) edge of the input signal.
	Remote Test Off Load* (default in I03)	Start/stop test off load sequence in rising (NO) or falling (NC) edge of the input signal.
	Inhibit AUTO Mode	Prevent switch control operations, configuration, test sequences and generator start in case of priority source failure.
	Manual Retransfer	Disables automatic transfer back to priority source.
	Source Priority S1	Sets priority for source 1 in transformer-transformer application.
	Source Priority S2	Sets priority for source 2 in transformer-transformer application.
	Inhibit Transfer	Disables automatic transfer from priority source to non-priority source.
	Bypass Running Time Delays	Bypass any currently running time delay
	Remote Control to S1	Transfer to S1 when active. Overridden by activated 'Remote Control to OFF' signal.
	Remote Control to OFF	Transfer to O position when active.
	Remote Control to S2	Transfer to S2 when active. Overridden by activated 'Remote Control to OFF' or 'Remote Control to S1' signals.
	Reset Alarm	Reset any active switch control alarms (open I failure, close I failure, open II failure, close II failure)
	Manual-Auto Mode	Toggle automatic/HMI control mode, input is active only in rising/falling edge according to contact type.
Contact type	NC	Active open.
	NO*	Active closed.
O01		
Function	No Function	Output disabled.
	Alarm / Product availability*	Signals any active alarms or ATS being disabled for automatic transfer operations.
	Load Connected to S1	Switch in position I.
	Load Disconnected	Switch in position O.
	Load Connected to S2	Switch in position II.

Continued on the next page

Settings		*Default
 Standard I/O Settings (continued)		
O 01 (continued)		
Function (continued)		
	Pre-transfer Signal	Signal is activated and transfer is delayed according to pre-transfer delay. Signal is kept activated according to post-transfer delay after transfer.
	Source 1 Available	No anomalies in S1 voltage supply.
	Source 2 Available	No anomalies in S2 voltage supply.
	Load Shed 1	Used for shedding non-essential loads before transferring to non-priority source. Signal is activated before transferring to non-priority source according to load shed delay and kept activated until load is transferred back to priority source.
	Elevator pre-signal	Signal is activated and transfer is delayed according to Elevator pre-signal delay. Signal is kept activated according to Elevator post-signal delay after transfer.
Contact type	NC	Active open.
	NO*	Active closed.
Modules (See Chapter 5, Electronic accessories)		
System		
	RESET to Factory Setting	Restore default parameter values.
	Date ¹⁾	Month day, year
	Time ¹⁾	Hours:Minutes
	Language	
	English*	
	Italian	
	French	
	German	
	Spanish	
	Russian	
	Chinese	
	New Password	Five digits
	Temperature Unit	
	Celsius*	
	Fahrenheit	
	Clock Format	24 h*
		12 h
	Display Contrast	10 - 100% (30 %*)

¹⁾ RTC capacitor must be charged before inserting Date/Time. RTC capacitor is charged from source voltage (not AUX) and takes about 10 minutes. RTC capacitor keeps the date/time saved for 48 h in case of no source voltage available.

Test	*Default	
T	On-Load Test Settings	
	Bypass Local Test	
	Bypass if Gen. fails*.	
	Stay on Gen.	
	Bypass Remote Test	
	Bypass if Gen. fails*.	
	Stay on Gen.	
	Test On Load	Test generator with transferring the load. Test with switch transfer.
	Test off Load	Test generator without transferring the load. Test without switch transfer.
	HMI Test	Initiate display test screen and turn all LEDs on.
Optional modules (See Chapter 5, Electronic accessories)		

About	
	HMI
	HMI serial number
	Software version
	Software subversion
	HMI Type code
	Controller Unit
	Time
	Date
	Serial number
	Normative
Controller software version	
Controller software subversion	
Automatic Transfer Switch	
TAG name	
ATS Type Code	
ATS serial number	
Rated current	
Number of poles	
ATS Type	
Modules (See Chapter 5, Electronic accessories)	

4.3.1 Esc key

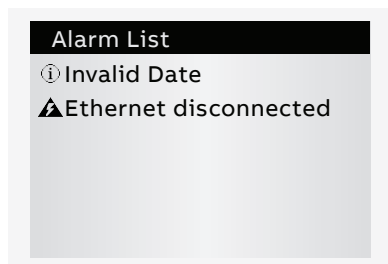

Fig. 4.7

By pressing Esc-key (1) in System Overview
-pages, the alarm list is shown.

Alarm list

More information, see chapter 6, Troubleshooting



5. Electronic accessories



Warning

Hazardous voltage may be present within the panel when connecting electronic accessories. Remove all sources of power to the ATS panel before connecting Ekip modules.

Ekip Connect Software and Bluetooth and Programming -modules are suitable for all ZTG(D) 30-1200 A, 200-480 Vac automatic transfer switches, refer to chapters 5.1-5.3. for more details on:

- Ekip Connect -software
- Ekip Bluetooth -module
- Ekip Programming -module

Ekip Signalling and Com modules are suitable for all ZTG(D) 30-1200 A, 200-480 Vac automatic transfer switches. These modules are mounted with auxiliary power supply module, OXE1 (refer to Chapter 10.3 for further details).

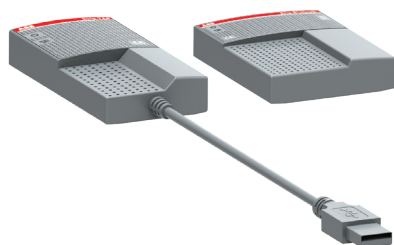

Fig. 5.1 Programming and bluetooth -modules

Ekip-modules mounted with auxiliary power supply module are (see chapters 5.4-5.8):

- Ekip Signalling 2K_
- Ekip Com modules
- Ekip Com Modbus RTU
- Ekip Com Profibus DP
- Ekip Com DeviceNet
- Ekip Com Modbus TCP
- Ekip Com Profinet
- Ekip Com EtherNet/IP
- Ekip Link

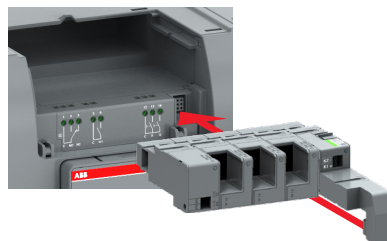

Fig. 5.2 Ekip Signalling, Com and Link -modules are mounted to automatic transfer switch OX_ with an auxiliary power supply module, OXE1

5.1 Using Ekip Connect -software

Ekip Connect is a free software for communication and testing of ABB automatic transfer switches. The software is compatible with ZTG(D) 30-1200 A, 200-480 Vac automatic transfer switches. It can be installed on PCs equipped with the Microsoft Windows® operating system. To download it, see the address below: <http://www.abb.com/abblibrary/DownloadCenter/>

With its communication function, it allows you to:

- Monitor the state of the automatic transfer switches connected and record information.
- Configure the automatic transfer switches with customized parameters.
- Configure the electronic accessories, connected to the automatic transfer switch via Local Bus.
- Create communication reports.
- Reset configurations.

Further information on the Ekip Connect application is available from the web site, see the address below, particularly the manual 1SDH000891R0002.

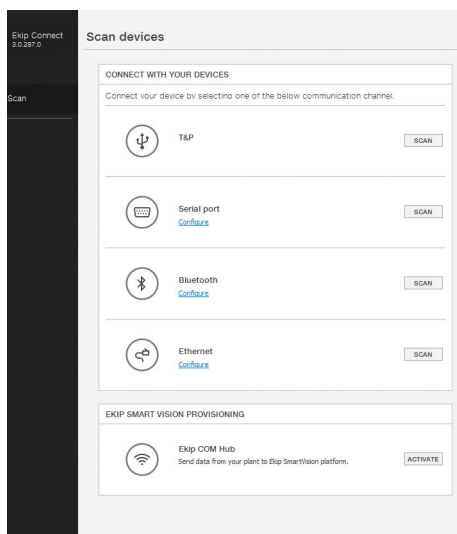

Fig. 5.3 Ekip Connect -software

5.2 Using Ekip Bluetooth-module

The Ekip Bluetooth module allows connection via Bluetooth between the automatic transfer switch and a support device (PC, tablet, or smart phone) with the Ekip Connect software installed. Ekip Bluetooth -module is suitable to use with all ZTG(D) 30-1200 A, 200-480 Vac automatic transfer switches.

The Ekip bluetooth module draws its power from a rechargeable lithium-polymer battery supplied with the unit. It is connected directly to the programming port (see Fig. 5.6) powers the controller without the need for auxiliary voltage supply. The programming port is only compatible for use with Ekip Bluetooth and Ekip Programming -modules.



Notice

Ekip Bluetooth only powers the main controller board (HMI and external modules excluded). Therefore, in order to identify all connected parts with Ekip Connect, the auxiliary power supply module, type OXE A1, must be used (see chapter 5.4).

5.2.1 LED indications

Ekip Bluetooth -module is switched on by pressing the power button on the side, and is equipped with two LEDs:

- The first LED illuminates in green with the device on and the battery charge, red with the device turned on and low battery.
- The second LED flashes blue with active Bluetooth communication.

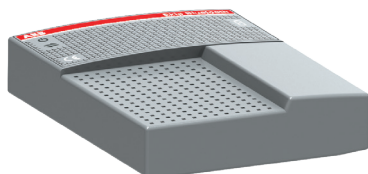

Fig. 5.4 Ekip Bluetooth-module

5.3 Using Ekip Programming -module

1

The Ekip Programming -module is suitable to use with all ZTG(D) 30-1200 A, 200-480 Vac automatic transfer switches. You can connect the module via the programming port, see Fig. 5.6. The programming port is only compatible for use with Ekip Programming and Ekip Bluetooth -modules.

Ekip Programming -module allows you to:

- With Ekip Connect software update the software and load, set and read the parameters

The Ekip Programming -module draws its power from the PC and connects one side directly to the programming port (see Fig. 5.6) and on the other to the USB port of the PC with the cable supplied.



Notice
 Ekip Programming only powers the controller board (HMI and external modules excluded). Therefore, in order to identify all connected parts with Ekip Connect, the auxiliary power supply module, type OXEA1, must be used (see chapter 5.4).

5.3.1 LED indications

Ekip Programming -module turns on after connecting to the PC, and is equipped with two LEDs. The first, illuminates green indicating that the module is on, and the second, illuminates yellow indicating active communication.

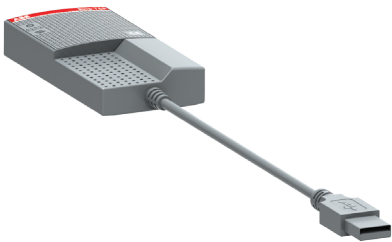

Fig. 5.5 Ekip Programming -module



Fig. 5.6 Programming port (USB port) is situated in the front of the HMI, on left side

5.4 Auxiliary power supply module

When connected to a 12-24 Vdc source, the auxiliary power supply module, type OXE1, supplies power to the external Ekip-modules, HMI and main control unit. It is supplied by external supply, for example from generator battery or from isolated transformer connected to the main power circuit. Powering product only with Auxiliary power supply module limits

some operation functions of the main control unit, for example: Operation of the main switch contacts is not possible.

Connections are push-in spring terminals, no tool is required.

For external wiring, cable cross section; AWG 22-16 / 0.5-1.5 mm².

5.4.1 Electrical characteristics

The following table lists the electrical characteristics of OXE1:

Module	OXEA1
Power supply input voltage	12 - 24 V DC \pm 10 % SELV
Nominal power consumption	5 - 12 W
Inrush current	Maximum 2 A

Table 5.1 Electrical characteristics of auxiliary power supply module OXE1

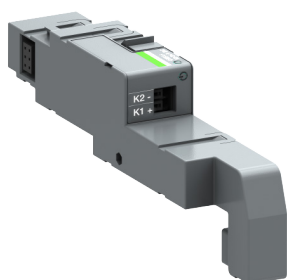

Fig. 5.7 Auxiliary power supply module, type OXE1, is needed when Ekip Signalling, Com and Link -modules are mounted to automatic transfer switch OX_

5.4.2 LED indications

LED	Indication	Description
Power LED, green	On, fixed	Power is connected to the input of the module.
	Off	Power is not connected.

Table 5.2 Indication / auxiliary power supply module OXE1



Fig. 5.8 Signals of auxiliary power supply module OXE1

5.5 Using Ekip Signalling 2K-_-module

The Ekip Signalling 2K-_- is a signalling accessory module. It is suitable for all ZTG(D) 30-1200 A, 200-480 Vac automatic transfer switches. The module has:

- Two digital inputs, and two contacts for output signals.
- A power status LED, and four signalling LEDs (one LED for every input/output).



Notice
 On each ATS, a maximum of three Ekip Signalling 2K modules can be installed: one 2K-1, one 2K-2, and one 2K-3. These modules differ by their name and label, and have distinct wiring, but they are identical in terms of their characteristics and manner of installation.



Fig. 5.9 Ekip Signalling 2K-module

5.5.1 Electrical characteristics of Ekip Signalling 2K-_-module

The following table lists the electrical characteristics of the module:

Component	Characteristics
Output contacts	Maximum switching voltage*: 150 V DC / 250 V AC Breaking power*: 2 A @ 30 V DC, 0.8 A @ 50 V DC, 0.2 A @ 150 V DC, 4 A @ 250 V AC Dielectric strength between each contact and coil: 1000 V AC (1 minute @ 50 Hz) Dielectric strength between open contacts: 1000 V AC (1 minute @ 50 Hz)
Input contacts	5 V@2.5 mA Do not connect to any power supply

*Data relating to a resistive load

Table 5.3 Electrical characteristics of Ekip Signalling 2K-_-module

5.5.2 Access from the display / Ekip Signalling 2K-_-module

With modules energized, and Local Bus enabled, the presence of the modules on the module slot activates additional menus on the display:

- In order to configure the inputs and output contacts.
- To display information on the modules and the state of inputs and outputs.

The following table illustrates the path for accessing the configuration parameters of the module from the display:

Settings (*Default)		Description
Modules (Optional modules)		
Ekip Signalling 2K-1 / -2 / -3		
I 11/12, I 21/22, I 31/32		
Function	No Function*	Input disabled
	Emergency Stop	Transfers to O position in delayed transition I-O-II type switches. Disables automatic control mode in both delayed and open transition types.
	Remote Test on Load	Start/stop test on load sequence in rising (NO) or falling (NC) edge of the input signal.
	Remote Test off Load	Start/stop test off load sequence in rising (NO) or falling (NC) edge of the input signal.
	Inhibit AUTO Mode	Prevent switch control operations, configuration, test sequences and generator start in case of priority source failure.
	Manual Retransfer	Disables automatic transfer back to priority source.
	Source Priority S1	Sets priority for source 1 in transformer-transformer application.
	Source Priority S2	Sets priority for source 2 in transformer-transformer application.
	Inhibit Transfer	Disables automatic transfer from priority source to non-priority source.
	Bypass Running Time Delays	Bypass any currently running time delay.
	Remote Control to S1	Transfer to S1 when active. Overridden by activated 'Remote Control to OFF' signal.
	Remote Control to OFF	Transfer to position O when active.
	Remote Control to S2	Transfer to S2 when active. Overridden by activated 'Remote Control to OFF' or 'Remote Control to S1' signals.
	Reset Alarm	Reset any active switch control alarms (open I failure, close I failure, open II failure, close II failure).
	Manual-Auto Mode	Toggle automatic/HMI control mode, input is active only in rising/falling edge according to contact type.
Contact Type	NC	Active open
	NO*	Active closed
O 11/12, O 21/22, O 31/32		
Function	No Function*	Output disabled
	Alarm/Product Availability	Signals any active alarms or ATS being disabled for automatic transfer operations.
	Load Connected to S1	Switch in position I.
	Load Disconnected	Switch in position O.
	Load Connected to S2	Switch in position II.
	Pre-transfer Signal	Signal is activated and transfer is delayed according to pre-transfer delay. Signal is kept activated according to post-transfer delay after transfer.

Continued on the next page

1

Settings (*Default) (continued)		Description
Modules (Optional modules) (continued)		
Ekip Signalling 2K-1 / -2 / -3 (continued)		
O 11/12, O 21/22, O 31/32 (continued)		
Function (continued)		
	Source 1 Available	No anomalies in S1 voltage supply.
	Source 2 Available	No anomalies in S2 voltage supply.
	Load Shed 1	Used for shedding non-essential loads before transferring to non-priority source. Signal is activated before transferring to non-priority source according to load shed delay and kept activated until load is transferred back to priority source.
	Elevator pre-signal	Signal is activated and transfer is delayed according to Elevator pre-signal delay. Signal is kept activated according to Elevator post-signal delay after transfer.
Contact Type	NC	Active open
	NO*	Active closed

Test	
:	
Modules (Optional modules)	
Ekip Signalling 2K-1 / -2 / -3	Auto Test
:	

Table 5.4 Configuration and test parameters of Ekip Signalling 2K_- module in HMI

The following table illustrates the path from the display for accessing information on the module:

About	Description
:	
Modules (Optional modules)	
Ekip Signalling 2K-1 / -2 / -3	
SN	Serial number
Version	Software version
Input 1	The logical state of the inputs: "Off" if not active, "On" if active
Input 2	
Output 1	The state of the output contacts: "Open" if open, "Closed" if closed
Output 2	
:	

Table 5.5 Information of Ekip Signalling 2K_- module in HMI

5.5.3 LED indications and inputs/outputs of Ekip Signalling 2K_-module

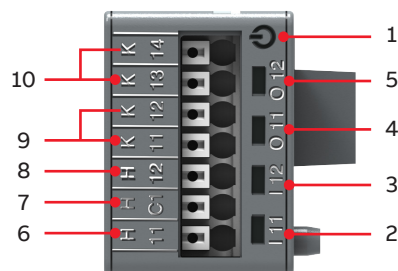

Fig. 5.10 Signals and inputs/outputs of Ekip Signalling 2K_-module

- 1 Power LED, green. The possible states are:
 - Off: power supply absent.
 - On fixed: power supply and communication with the device present.
 - On, with two quick flashes per second (not synchronized with those of the green LED on the device): power supply present, and communication with device absent (for example: for Local Bus disabled)¹⁾
- 2 Green³⁾ LED for signalling the physical state of the input H x 1²⁾. The possible states are:
 - Off: floating input
 - On fixed: input short-circuited on H Cx²⁾
- 3 Green³⁾ LED for signalling the physical state of the input H x 2²⁾. The possible

states are:

- Off: floating input
 - On fixed: input short-circuited on H Cx
- 4 Green³⁾ LED for signalling contact K x1 - K x2²⁾. The possible states are:
 - Off: contact open
 - On fixed: contact closed
 - 5 Green³⁾ LED for signalling the state of the contact K x3 - K x4²⁾. The possible states are:
 - Off: contact open
 - On fixed: contact closed
 - 6 Input I x1
 - 7 Conductive part of the inputs H x1 and H x2²⁾
 - 8 Input I x2²⁾
 - 9 Output contact pin O x1²⁾
 - 10 Output contact pin O x2²⁾
- 1) The absence of communication is signalled immediately by the power LED, unlike the outputs which (apart from those programmed to be activated in the case of disconnection) are deactivated if the condition persists for at least 8 s
 - 2) With x = 1, 2, or 3
 - 3) The LED turns on and off according to the physical state of the input, without taking any account of how the Delay parameter is set.

For external wiring, cable cross section;
AWG 22-16 / 0.5-1.5 mm².

5.6 Using Ekip Com _ -modules

1

Suitable Ekip Com _ -modules are:

- Ekip Com Modbus RTU
- Ekip Com Profibus DP
- Ekip Com DeviceNet
- Ekip Com Modbus TCP
- Ekip Com Profinet
- Ekip Com EtherNet/IP

5.6.1 Ekip Com Modbus RTU -module

The Ekip Com Modbus RTU is a communication accessory module, that integrates the automatic transfer switch in an industrial remote supervision and control network. The module is suitable for all ZTG(D) 30-1200 A, 200-480 Vac automatic transfer switches.

It can be connected to a RS-485 network with a Modbus RTU communication protocol, and allows you to:

- Connect the automatic transfer switch to the network, with dialog functionality.
- Provide the status information of the automatic transfer switch (e.g. open, closed).

For the communication lines W1 (A) and W2 (B), Belden type 3105 A or equivalent cables must be used.



Fig. 5.11 Ekip Com Modbus RTU -module

5.6.1.1 LED indications

The following table illustrates the possible signals, and their meaning:

LED	Indication	Description
Power LED, green	Off	Power supply absent.
	On fixed	Power supply and communication with the device present.
	On, with two quick flashes per second	Power supply present, and communication with device absent.
RX and TX LEDs, green	Off	Modbus RTU communication not active.
	On, flashing rapidly	Modbus RTU communication active.

Table 5.6 Indication / Ekip Com Modbus RTU -module

5.6.1.2 Termination resistor

On the Ekip Com Modbus RTU module it is possible to activate the terminating resistance $R_{term} = 120 \Omega$. To enable the R_{term} , the corresponding dip-switches 1 and 2 (on the side of the module) must be positioned to ON. This option must be selected before the installation of the module.

With the Ekip Com Modbus RTU modules, the dip-switches 3 and 4 of the Rpol (polarization resistance), are not used.



Fig. 5.12 Signals of Ekip Com Modbus RTU -module

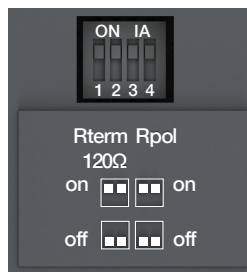

Fig. 5.13 Termination resistor; To enable the R_{term} , the dip-switches 1 and 2 must be positioned to ON. This option must be selected before the installation of the module

5.6.1.3 Access from the display / Ekip Com Modbus RTU –module

With modules connected and energized the presence of the modules on the module slot activates additional menus on the display. The following table illustrates the path for accessing the configuration parameters of the modules from the display:

Settings (*Default value)		Description
:		
Modules (Optional modules)		
Ekip Com Modbus RTU		
Serial address	1-247, default 247*	Address to be assigned to the modules. NOTE: devices connected to the same network must have different addresses
Baudrate	9600 bit/s, 19200 bit/s*, 38400 bit/s	Data transmission speed
Physical protocol	8.E,1*, 8.O,1, 8.N,2, 8.N,1	8.E,1 = 8 data bits, 1 EVEN parity bit, 1 STOP bit 8.O,1 = 8 data bits, 1 ODD parity bit, 1 STOP bit 8.N,2 = 8 data bits, no parity bit, 2 STOP bits 8.N,1 = 8 data bits, no parity bit, 1 STOP bit
:		

Table 5.7 The path for accessing the configuration parameters of the Ekip Com Modbus RTU -module from the display

The following table illustrates the path from the display for accessing information on the module:

About	Description
:	
Modules (Optional modules)	
Ekip Com Modbus RTU	
SN	Serial number
Version	Software version
:	

Table 5.8 Information of Ekip Com Modbus RTU -module in HMI



5.6.2 Ekip Com Profibus DP -module

The Ekip Com Profibus DB is a communication accessory module, that integrates the automatic transfer switch in an industrial remote supervision and control network. The module is suitable for all ZTG(D) 30-1200 A, 200-480 Vac automatic transfer switches.

It can be connected to a network RS-485 of Profibus communication protocol, and allows:

- Connecting the automatic transfer switch as a slave to the network, with dialog functionality.
- Provide the status information of the automatic transfer switch (e.g. open, closed).

For the communication lines W5 (B) and W6 (A), Belden type 3079A or equivalent cables must be used.

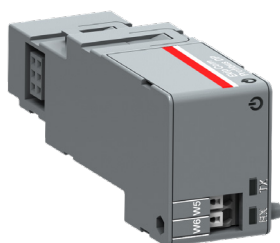

Fig. 5.14 Ekip Com Profibus DP -module

5.6.2.1 LED indications

The following table illustrates the possible signals, and their meaning:

LED	Indication	Description
Power LED, green	Off	Power supply absent.
	On fixed	Power supply and communication with the device present.
	On, with one flash per second	Power supply and communication with device present.
	On, with two quick flashes per second	Power supply present, and communication with device absent.
RX LED, green	Off	Communication not active.
	On, fixed	Communication active.
TX LED, green	Off	Communication not active.
	On, flashing	Communication active.

Table 5.9 Indication / Ekip Com Profibus DP -module

5.6.2.2 Termination resistor

The Ekip Com Profibus DP modules provide the possibility to insert a 220 Ω termination resistor on the RS-485 bus, by setting the DIP-switches Rterm (1 and 2) on the side of the modules, in position ON.

In the event of termination of the bus, a 390 Ω pull-up or pull-down resistor must also be inserted on the lines, by setting the DIP-switches Rpol (3 and 4), in position ON.

These options must be selected before installation of the modules.

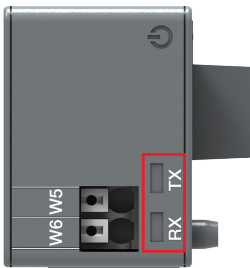

Fig. 5.15 Signals of Ekip Com Profibus DB -module

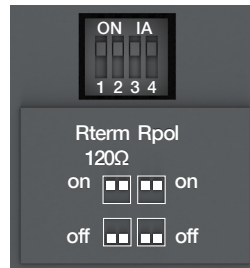

Fig. 5.16 Termination resistor; To enable the Rterm, the dip-switches 1 and 2 must be positioned to ON. When Rterm is activated, the Rpol must also be activated by turning dip-switches 3 and 4 to ON-position. These options must be selected before the installation of the modules

5.6.2.3 Access from the display / Ekip Com Profibus DB -module

With modules connected and energized, the presence of the modules on the module slot activates additional menus on the display.

The following table illustrates the path for accessing the configuration parameters of the modules from the display:

Settings (*Default value)	Description
:	
Modules (Optional modules)	
Ekip Com Profibus DB	
Serial address	1-125, default 125*
	Address to be assigned to the modules. IMPORTANT: devices connected to the same network must have different addresses
:	

Table 5.10 Configuration of Ekip Com Profibus DB -module in HMI

The following table illustrates the path from the display for accessing information on the module:

About	Description
:	
Modules (Optional modules)	
Ekip Com Profibus DB -module	
SN	Serial number
Version	Software version
:	

Table 5.11 Information of Ekip Com Profibus DB -module in HMI

1

5.6.3 Ekip Com DeviceNet -module

The Ekip Com DeviceNet –module is a communication accessory module, that integrates the automatic transfer switch in an industrial remote supervision and control network. The module is suitable for all ZTG(D) 30-1200 A, 200-480 Vac automatic transfer switches.

It can be connected to a CAN network with a DeviceNet™ communication protocol, and allows you to:

- Connect the automatic transfer switch as a slave to the network, with dialog functionality.
- Provide the status information of the automatic transfer switch (e.g. open, closed).

For the communication lines, Belden type 3084A or equivalent cables must be used.

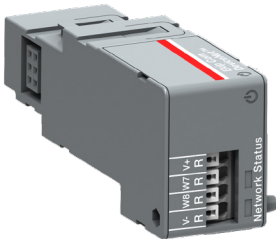

Fig. 5.17 Ekip Com DeviceNet -module

5.6.3.1 LED indications

The following table illustrates the possible signals, and their meaning:

LED	Indication	Description
Power LED, green	Off	Power supply absent.
	On fixed	Power supply and communication with the device present.
	On, with two quick flashes per second	Power supply present, and communication with device absent.
Network LED, red	Off	Device off line (with red LED off) ¹⁾ , or in error conditions (with red LED on).
	On, fixed	Device on line, and allocated on a master (operating condition).
	On, flashing	Device on line, but not allocated on a master (device ready for communication).
Status LED, green	Off	No error.
	On, fixed	Device in bus off, or Network Power absent condition.
	On, flashing	I/O connection (cyclic data) in timeout.

¹⁾ The device has not yet sent Duplicate ID sequence on line.

Table 5.12 Indication / Ekip Com DeviceNet -module in HMI



Fig. 5.18 Signals of Ekip Com DeviceNet -module

5.6.3.2 Termination resistor

The modules provide the possibility to insert a 120 Ω termination resistor on the CAN bus, by setting the DIP-switches Rterm (1 and 2) on the side of the modules, in position ON. This option must be selected before the installation of the modules. With the Ekip Com DeviceNet - modules, the dip-switches 3 and 4 of the Rpol (polarization resistance), are not used.



Notice

The termination resistors must never be included in the nodes. The inclusion of this capability could easily lead to a network with improper termination (impedance too high or too low), potentially causing a failure. For example the removal of a node, which includes a termination resistor, could result in a network failure. The termination resistors must not be installed at the end of a branch (drop line), only at the two ends of the main backbone (trunk line).

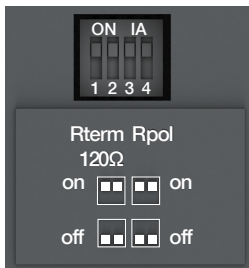

Fig. 5.19 Termination resistor; To enable the Rterm, the dip-switches 1 and 2 must be positioned to ON. This option must be selected before the installation of the module.

5.6.3.3 Access from the display / Ekip Com DeviceNet –module

With modules connected and energized, the presence of the modules on the module slot activates additional menus on the display.

The following table illustrates the path for accessing the configuration parameters of the modules from the display:

Settings (*Default value)	Description
:	
Modules (Optional modules)	
Ekip Com DeviceNet	
MAC address	1-63, default 63* Address to be assigned to the modules. IMPORTANT: devices connected to the same network must have different addresses
Baudrate	125 kbit/s, 250 kbit/s*, 500 kbit/s Data transmission speed
:	

Table 5.13 The path for accessing the configuration parameters of the Ekip Com DeviceNet -module from the display

The following table illustrates the path from the display for accessing information on the module:

About	Description
:	
Modules (Optional modules)	
Ekip Com DeviceNet	
SN	Serial number
Version	Software version
:	

Table 5.14 Information of Ekip Com DeviceNet -module in HMI

5.6.4 Ekip Com Modbus TCP -module

Ekip Com Modbus TCP is an accessory module that can function as a communication module integrating the automatic transfer switch in an industrial remote supervision and control network or as an HTTP Server. The module is suitable for all ZTG(D) 30-1200 A, 200-480 Vac automatic transfer switches.

As a communication module, it can be connected to an Ethernet network with the Modbus TCP communication, and allows:

- Connecting the automatic transfer switch to the network, with dialog functionality.
- Provide the status information of the automatic transfer switch (e.g. open, closed).

As an HTTP Server, connected to an Ethernet network it allows read-only access to the information of the automatic transfer switch. This access is possible through a browser, inserting the IP address of the module as the URL. Once the switch has been found, a login page is opened that asks for the user password to be inserted, which is the same password to be inserted in the display in order to edit parameters.



Notice

Since the module allows access to the data contained in the automatic transfer switch, it can only be connected to networks that meet all the necessary requirements for safety and prevention of unauthorized access (for example, the network of the control system of an installation). It is the installer's responsibility to ensure that all the necessary safety measures are adopted (for example, firewalls, and so on). The module cannot be connected directly to the Internet. It is recommended to connect it only to dedicated Ethernet networks, with the Modbus TCP communication protocol.

For the communication bus, a cable of type Cat.6 S/FTP must be used (Cat.6 with S/FTP double shielding).

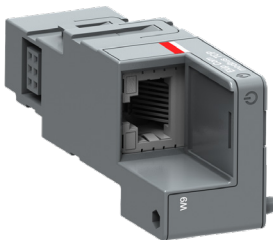

Fig. 5.20 Ekip Com Modbus TCP -module

The following table illustrates the ports used by the module:

Port	Service	Notes
502/tcp	Modbus TCP	When the module is used as a Modbus TCP/IP communication module.
80/tcp	Server HTTP	When the module is used as a Server HTTP.
319/udp	IEEE 1588	When IEEE protocol 1588 is enabled
320/udp		

Table 5.15 Ports of Ekip Com Modbus TCP -module

5.6.4.1 LED indications

The following table illustrates the possible signals, and their meaning:

LED	Indication	Description
Power LED, green	Off	Power supply absent.
	On fixed	Power supply and communication with the device present.
	On, with two quick flashes per second	Power supply present, and communication with device absent.
Link LED, green	Off	Connection error (signal absent).
	On, fixed	Correct connection.
Activity LED, yellow	Off	No activity on the line.
	On, flashing	Activity present on the line (in reception and/or transmission).

Table 5.16 Indication / Ekip Com Modbus TCP -module

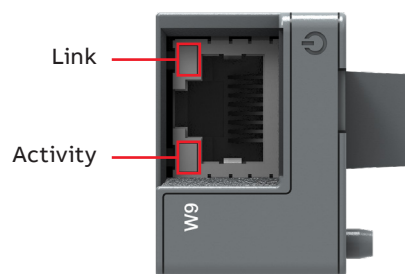

Fig. 5.21 Signals of Ekip Com Modbus TCP -module

5.6.4.2 Access from the display / Ekip Com Modbus TCP -module

With modules connected and energized, the presence of the modules on the module slot activates additional menus on the display:

- For setting the function and addressing of the modules.
- In order to display information on the modules.

The following table illustrates the path from the display, for setting the function and addressing of the modules:

Settings (* Default value)	Description	
:		
Modules (Optional modules)		
Ekip Com Modbus TCP		
Function	HTTP Server	HTTP Server operating mode.
	TCPModbus*	Communication module operating mode.
Force Static IP address	Off*	Dynamic IP address.
	On	Static IP address.
Static IP Address	Displayed with static IP Address enabled, it must be selected in order to insert the IP Address of the modules.	
Static Network Mask	Displayed with static IP Address enabled, it must be selected in order to insert the subnet mask of the modules.	
Static Gateway addr	Displayed with static IP Address enabled, it must be selected in the presence of multiple subnets, in order to insert the IP Address of the node to which the modules are connected.	
:		

Table 5.17 The path for setting the function and addressing of the modules of the Ekip Com Modbus TCP -module from the display



The following table illustrates the path from the display for accessing information on the module:

About	Description
:	
Modules (Optional modules)	
Ekip Com Modbus TCP	
SN	Serial number
Version	Software version
IP Address	This is the address assigned to the modules at the moment of connection to the network. It consists of four bytes (for a total of 32 bits), each of which can have value from 0 to 255. By default, allocation is dynamic. With dynamic allocation, the modules wait to receive the IP address from a DHCP server. Without a DHCP server, the modules adopt an Autoconfiguration IP Address in the range 169.254.xxx.xxx, calculated in a pseudo random manner so as to be the same at every switch-on. Alternatively, you can enable the static IP address option, which allows the IP address to be forced. In this case, you must make sure that the IP Address inserted is different to that of the other devices connected to the same network.
Network Mask	This is the subnet mask, and identifies the method to recognize the subnet to which the modules belong, with the possibility of searching for the modules within a defined set of recipients. If you enabled the option Static IP Address, you must also enter the correct Network Mask.
Gateway Address	The IP address of the node to which the module it is connected, in the presence of multiple subnets. If you enabled the Static IP Address option, you must also enter the correct Gateway Address.
TCP Client	There are three IP Addresses of the client devices connected to the modules.
MAC Address	It is the address assigned by ABB, having a OUI equal to ac:d3:64 ¹⁾ .
:	

¹⁾ Organizationally Unique Identifier, formed from the first three bytes of a MAC address, and which uniquely identifies the manufacturer of an Ethernet device.

Table 5.18 Information of Ekip Com Modbus TCP -module in HMI

5.6.5 Ekip Com Profinet -module

The Ekip Com Profinet is a communication accessory module, that integrates the automatic transfer switch in an industrial remote supervision and control network. The module is suitable for all ZTG(D) 30-1200 A, 200-480 Vac automatic transfer switches.

It can be connected to an Ethernet network with a Profinet communication protocol, and allows you to:

- Connect the automatic transfer switch to the network, with dialog functionality.
- Provide the status information of the automatic transfer switch (e.g. open, closed).



Notice

The module can only be connected to networks that meet all the necessary requirements for safety and prevention of unauthorized access (for example, the network of the control system of an installation). It is the installer's responsibility to ensure that all the necessary safety measures are adopted (for example, firewalls, and so on). It is recommended to connect it only to dedicated Ethernet networks, with the Profinet communication protocol. The module cannot be connected to the Internet.

For the communication bus, a cable of type Cat.6 S/FTP must be used (Cat. 6 with S/FTP double shielding).

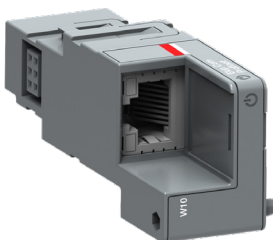

Fig. 5.22 Ekip Com Profinet -module

The following table illustrates the ports used by the module:

Ethertype	Port	Service	Notes
0x88CC	-	LLDP	Link Layer Discovery Protocol
0x8892 (Profinet)	-	Profinet IO	Specific for real time communications (RT)
0x0800	34964/udp	Profinet-cm (Context Manager)	DCE/RP

Table 5.19 Ports of Ekip Com Profinet -module

5.6.5.1 LED indications

The following table illustrates the possible signals, and their meaning:

LED	Indication	Description
Power LED, green	Off	Power supply absent.
	On fixed	Power supply and communication with the device present.
	On, with two quick flashes per second	Power supply present, and communication with device absent.
Link LED, green	Off	Connection error (signal absent).
	On, fixed	Correct connection.
Activity LED, yellow	Off	No activity on the line.
	On, flashing	Activity present on the line (in reception and/or transmission).

Table 5.20 Indication / Ekip Com Profinet -module

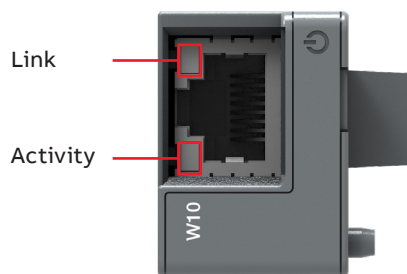

Fig. 5.23 Signals of Ekip Com Profinet -module

5.6.5.2 Access from the display / Ekip Com Profinet -module

The following table illustrates the path from the display for accessing information on the module:

About	
:	
Modules (Optional modules)	
Ekip Com Profinet -module	
SN	Serial number
Version	Software version
MAC Address	It is the address assigned by ABB and with an OUI (Organizationally Unique Identifier, formed of the first three bytes of a MAC address, and which uniquely identifies the manufacturer of an Ethernet device) equal to ac:d3:64.
:	
—	

Table 5.21 Information of Ekip Com Profinet -module

5.6.6 Ekip Com EtherNet/IP -module

The Ekip Com EtherNet/IP is an accessory module that can act as a communication module integrating the automatic transfer switch in an industrial remote supervision and control network. The module is suitable for all ZTG(D) 30-1200 A, 200-480 Vac automatic transfer switches.

It can be connected to an Ethernet network with a EtherNet/IP™ -communication protocol, and allows you to:

- Connect the automatic transfer switch to the network, with dialog functionality.
- Provide the status information of the automatic transfer switch (e.g. open, closed).



Notice

Since this module allows the access to the data contained in the automatic transfer switch, it can only be connected to networks possessing all the necessary requirements for security and prevention of unauthorized access (for example, the network of the control system of an installation). It is responsibility of the installer to make sure that all the necessary security measures are adopted (for example firewalls and so on). The module cannot be connected directly to the Internet. It is recommended to connect it only to dedicated Ethernet networks using the EtherNet/IP™ -communication protocol.

For the communication bus, a cable of type Cat.6 S/FTP must be used (Cat.6 with S/FTP double shielding).

The following table illustrates the ports used by the module:

Port	Protocol	Notes
44818	TCP	Encapsulation Protocol (example: ListIdentity, UCMM, CIP Transport Class 3)
44818	UDP	Encapsulation Protocol (example: ListIdentity)
2222	UDP	CIP Transport Class 0 or 1

Table 5.22 Ports of Ekip Com EtherNet/IP -module

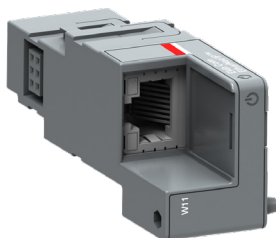

Fig. 5.24 Ekip Com EtherNet/IP -module

5.6.6.1 LED indications

The following table illustrates the possible signals, and their meaning:

LED	Indication	Description
Power LED, green	Off	Power supply absent.
	On fixed	Power supply and communication with the device present.
	On, with two quick flashes per second	Power supply present, and communication with device absent.
Link LED, green	Off	Connection error (signal absent).
	On, fixed	Correct connection.
Activity LED, yellow	Off	No activity on the line.
	On, flashing	Activity present on the line (in reception and/or transmission).

Table 5.23 Indication / Ekip Com EtherNet/IP -module

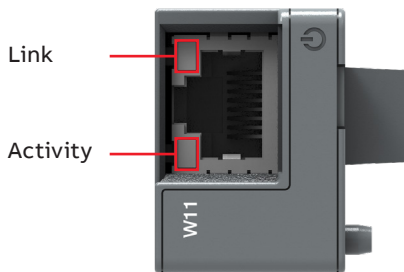

Fig. 5.25 Signals of Ekip Com EtherNet/IP -module

5.6.6.2 Access from the display / Ekip Com EtherNet/IP

With modules connected and energized, the presence of the modules on the module slot activates additional menus on the display:

- To set the addressing of the modules.
- In order to display information on the modules.

The following table illustrates the path from the display, for setting the function and addressing of the modules:

Settings (*Default value)	Description
:	
Modules (Optional modules)	
Ekip Com EtherNet/IP	
Force Static IP address	Off* On
	Dynamic IP address. Static IP address.
Static IP Address	Displayed with static IP Address enabled, it must be selected in order to insert the IP Address of the modules.
Static Network Mask	Displayed with static IP Address enabled, it must be selected in order to insert the subnet mask of the modules.
Static Gateway addr	Displayed with static IP Address enabled, it must be selected in the presence of multiple subnets, in order to insert the IP Address of the node to which the modules are connected.
:	
—	

Table 5.24 The path for setting the function and addressing of the modules of the Ekip Com Ethernet/IP -module from the display

The following table illustrates the path from the display for accessing information on the module:



About	Description
:	
Modules (Optional modules)	
Ekip Com EtherNet/IP	
SN	Serial number
Version	Software version
IP Address	This is the address assigned to the modules at the moment of connection to the network. It consists of four bytes (for a total of 32 bits), each of which can have value from 0 to 255. By default, allocation is dynamic. With dynamic allocation, the modules wait to receive the IP address from a DHCP server. Without a DHCP server, the modules adopt an Autoconfiguration IP Address in the range 169.254.xxx.xxx, calculated in a pseudo random manner so as to be the same at every switch-on. Alternatively, you can enable the static IP address option, which allows the IP address to be forced. In this case, you must make sure that the IP Address inserted is different to that of the other devices connected to the same network.
Network Mask	This is the subnet mask, and identifies the method to recognize the subnet to which the modules belong, with the possibility of searching for the modules within a defined set of recipients. If you enabled the option Static IP Address, you must also enter the correct Network Mask.
Gateway Address	The IP address of the node to which the module it is connected, in the presence of multiple subnets. If you enabled the Static IP Address option, you must also enter the correct Gateway Address.
TCP Client	There are three IP Addresses of the client devices connected to the modules.
MAC Address	It is the address assigned by ABB, having a OUI equal to ac:d3:64 ¹⁾ .
:	

¹⁾ Organizationally Unique Identifier, formed from the first three bytes of a MAC address, and which uniquely identifies the manufacturer of an Ethernet device.

Table 5.25 Information of Ekip Com EtherNet/IP -module in HMI

6. Troubleshooting



Warning

Any troubleshooting should be conducted by trained and authorized personnel only. Appropriate personal protective equipment (PPE) shall be used when troubleshooting the ATS panel. Hazardous voltage may be present. Disconnect all power sources before performing work inside the ATS panel. Failure to do so may result in serious injury or death.

6.1 Alarms



LCD



Touch

Message	Fault	Action
Locked, Alarm LED on	Lock input activated	Unlock
Switch not in AUTO mode, Alarm LED on	Slide switch is in handle or lock position	Turn slide switch into the AUTO position
Phases crossed	Phase rotation of sources 1 and 2 are different	Connect the phases of both sources in the same order
S1 undervoltage	Voltage of source 1 is under the threshold level set in parameter "Dropout voltage, lower threshold"	Check the correlation between power source and device configuration
S1 overvoltage	Voltage of source 1 is over the threshold level set in parameter "Dropout voltage, upper threshold"	Check the correlation between power source and device configuration
S1 phase missing	One or two phases of source 1 are missing	Check the power source and connections
S1 unbalance	Phases of source 1 are not symmetric	Check the power source
S1 phase rotation	Phase rotation of source 1 is different from the value of parameter "Phase sequence"	Connect the phases according to the configuration
S1 invalid frequency	Frequency of source 1 is out of range set in parameters "Drop-out frequency, upper threshold" and "Drop-out frequency, lower threshold"	Check the correlation between power source and device configuration
S2 undervoltage	Voltage of source 2 is under the threshold level set in parameter "Dropout voltage, lower threshold"	Check the correlation between power source and device configuration

Table 6.1 Alarms-list in level 3 and 4, LCD and touch control interfaces

Message	Fault	Action
S2 overvoltage	Voltage of source 2 is over the threshold level set in parameter "Dropout voltage, upper threshold"	Check the correlation between power source and device configuration
S2 phase missing	One or two phases of source 2 are missing	Check the power source and connections
S2 unbalance	Phases of source 2 are not symmetric	Check the power source
S2 phase rotation	Phase rotation of source 2 is different from the value of parameter "Phase sequence"	Connect the phases according to the configuration
Frequency Difference	Frequency difference of voltage sources is greater than 3 Hz while inphase monitor is on	Alarm is active and transfer operations disabled as long as the frequency difference is above the accepted level
S2 invalid frequency	Frequency of source 2 is out of range set in parameters "Drop-out frequency, upper threshold" and "Drop-out frequency, lower threshold"	Check the correlation between power source and device configuration
Open I failure, Alarm LED blinking	Switch transfer from position I to O or II failed	Reset alarm by pressing Auto button or via menu page Operation / Alarm Reset
Close I failure, Alarm LED blinking	Switch transfer to position I failed	Reset alarm by pressing Auto button or via menu page Operation / Alarm Reset
Open II failure, Alarm LED blinking	Switch transfer from position II to O or I failed	Reset alarm by pressing Auto button or via menu page Operation / Alarm Reset
Close II failure, Alarm LED blinking	Switch transfer to position II failed	Reset alarm by pressing Auto button or via menu page Operation / Alarm Reset
Switch position alarm, Alarm LED on	More than one switch position indication inputs are activated	Switch service needed
Pole temperature alarm	Measured pole temperature is too high	Switch service needed
Local bus Ethernet disconnected	Communication between HMI and switch controller is off	Check connection
	Ethernet module not connected	Check connection
Fire Fighting	Fire fighting input activated	Alarm is active and disables transfer operations as long as the input is active
Control Voltage Failure	Control voltage dropped during switch control	Check power source
Control Voltage Low	Switch control voltage is below the minimum	Check power source
Configuration Error	Invalid configuration	Check parameter values
IEC 61850 Error	IEC 61850 failure	Check configuration file
Ekip Com Hub Alarm	Ekip Com Hub failure	Check configuration

Table 6.1 Alarms-list in level 3 and 4, LCD and touch control interfaces

6.2 Warnings



LCD



Touch

Message	Reason
S1 and S2 not in sync	Voltage sources are not synchronized
Voltage Not Calibrated	Calibration data in power module is invalid or unavailable
Current Not Calibrated	Calibration data in current measurement module is invalid or unavailable
Control Retry	Failed transfer sequence retry activated
Auto Control Disabled	Device is in manual operating mode
Local Bus	Module heartbeat error
Configuration	Configuration session ports are open
RTC capacitor charging	Real time clock is not yet operational, date & time setting is disabled as long as this warning is active. RTC capacitor is charged from source voltage (not AUX) and takes about 10 minutes.

Table 6.2 Warnings-list in level 3 and 4, LCD and touch control interfaces

6.3 Information



LCD



Touch

Message	Description
Invalid Date	Date not set
Test on Load	Test on load sequence active
Test off Load	Test off load sequence active
Alarm/Product Availability	Digital output function activated
In Position I	Digital output function activated
In Position O	Digital output function activated
In Position II	Digital output function activated
Pre-transfer Signal	Digital output function activated
Source 1 Available	Digital output function activated
Source 2 Available	Digital output function activated
Load Shed	Digital output function activated
Emergency Stop	Digital input function activated
Remote Test on Load	Digital input function activated
Remote Test off Load	Digital input function activated
Inhibit Auto Mode	Digital input function activated
Manual Retransfer	Digital input function activated
Priority S1	Digital input function activated
Priority S2	Digital input function activated
Inhibit Transfer	Digital input function activated
Bypass Running Delays	Digital input function activated
Remote Control to S1	Digital input function activated
Remote Control to Off	Digital input function activated
Remote Control to S2	Digital input function activated
Alarm Reset	Digital input function activated
Manual-Auto Mode	Digital input function activated

Table 6.3 Info statements in level 3 and 4, LCD and touch control interfaces

7. Technical data

7.1 General technical data

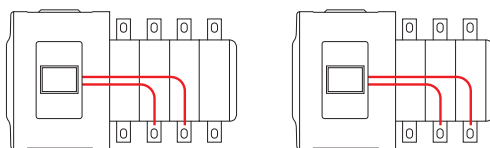
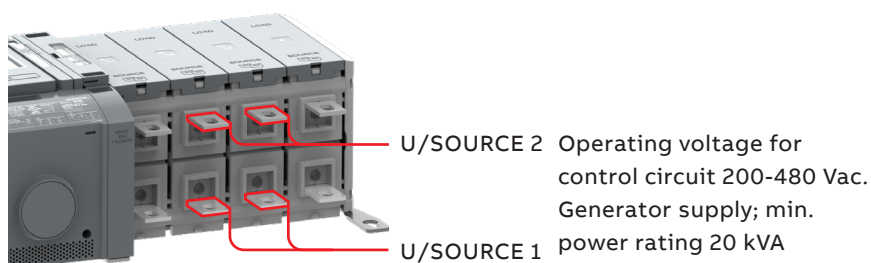
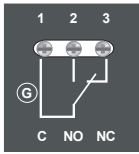
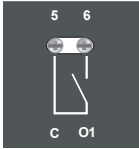
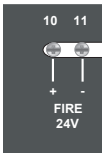
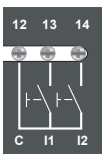

Fig. 7.1 Power supply for control and power switching circuits

Automatic transfer switch, power circuit	Value	
Rated operational voltage	200-480 Vac	
Rated frequency	50 / 60 Hz	
Rated impulse withstand voltage	12 / 8 kV	
Operating times	See Table 7.3	
Automatic transfer switch, control circuit	Value	Remark
Voltage supply	200-480 Vac	Integrated, see Fig. 7.1
Operating voltage range	±20 %	
Voltage measurement accuracy		
Rated frequency	50 / 60 Hz	
Operating frequency range	±20 %	
Frequency measurement accuracy		
Rated impulse withstand voltage	6 kV	

Automatic transfer switch, I/O contacts	Cabling / Terminal	Rating / Remark
Generator start/stop	24-14 AWG	Stripping length; 0.255"
	Common, voltage supply	1 5 A@250 Vac (AC-1), 5 A@30 Vdc
	Generator start/stop NO	2
	Generator start/stop NC	3
Output relay features	24-14 AWG	
	Common, voltage supply	5 5 A@250 Vac (AC-1), 5 A@30 Vdc
	Programmable output (default; Product available)	6
Fire Fighting applications	24-14 AWG	Only in ZTGD-types, delayed transition, I – O – II
	Fire fighting input 24 Vdc (+)	10 SELV
	Fire fighting input 24 Vdc (-)	11
Input contact features	24-14 AWG	Do not connect to any power supply
Common input	12	24 Vdc 5 mA
	Programmable input (default; Remote test on load)	13
	Programmable input (default; Remote test off load)	14
		Only in OXB_-types, delayed transition, I – O – II or II – O – I

AC15		AC12			AC13	
Ue/[V]	Ie/[A]	Ue/[V]	Ie/[A]	P/[W]	Ie/[A]	P/[W]
230	6	24	10	240	2	50
400	4	72	4	290	0.8	60
415	4	125	2	250	0.55	70
690	2	250	0.55	140	0.27	
		440	0.1	44		

Table 7.1 Technical data for auxiliary contacts according to IEC 60947-5-1, for OA1G_, OA3G_

Recommended Operating / Storage Temperature

Do not store the automatic transfer switch in corrosive environments above LC1 (sea salt mist) and G1 as per ANSI/ ISA-S71.04-1985. Failure to comply with these instructions may result in product damage. Store the automatic transfer switch and related accessories in a clean, dry location in their original packaging.

Environmental	Value
Environments category	E
EMC environment	Environment A
Operating temperature (without derating)	-20 - +40 °C
Operating temperature (with derating)	-25 - +70 °C
Transportation and storage temperature	-40 - +70 °C
Altitude (without derating)	Up to 2000 m

Table 7.2 General technical data of automatic transfer switch

Type	Voltage [Vac]	Nominal current* [A]	Operating time* = current duration I-0, 0-I, 0-II, II-0 [ms]	Operating transfer time ^{1,2} AUTO mode I-II or II-I [ms]	Contact transfer time ¹ I-II or II-I [ms]
ZTG 30 - 260A	200 - 480	37	-	< 500	< 50
ZTGD 30 - 260A	200 - 480	37	< 110	< 500	< 50
ZTG 400 - 600A	200 - 480	40	-	< 500	< 50
ZTGD 400 - 600A	200 - 480	40	< 130	< 500	< 50
ZTG 800 - 1200A	200 - 480	40	-	< 500	< 50
ZTGD 800 - 1200A	200 - 480	40	< 130	< 500	< 50

¹Under nominal conditions

²Time from source fail detection to contact closing on already-available secondary source

³All times consider that all timers are set to "0"

Table 7.3 Specified technical data of operating times

7.2 Circuit diagrams

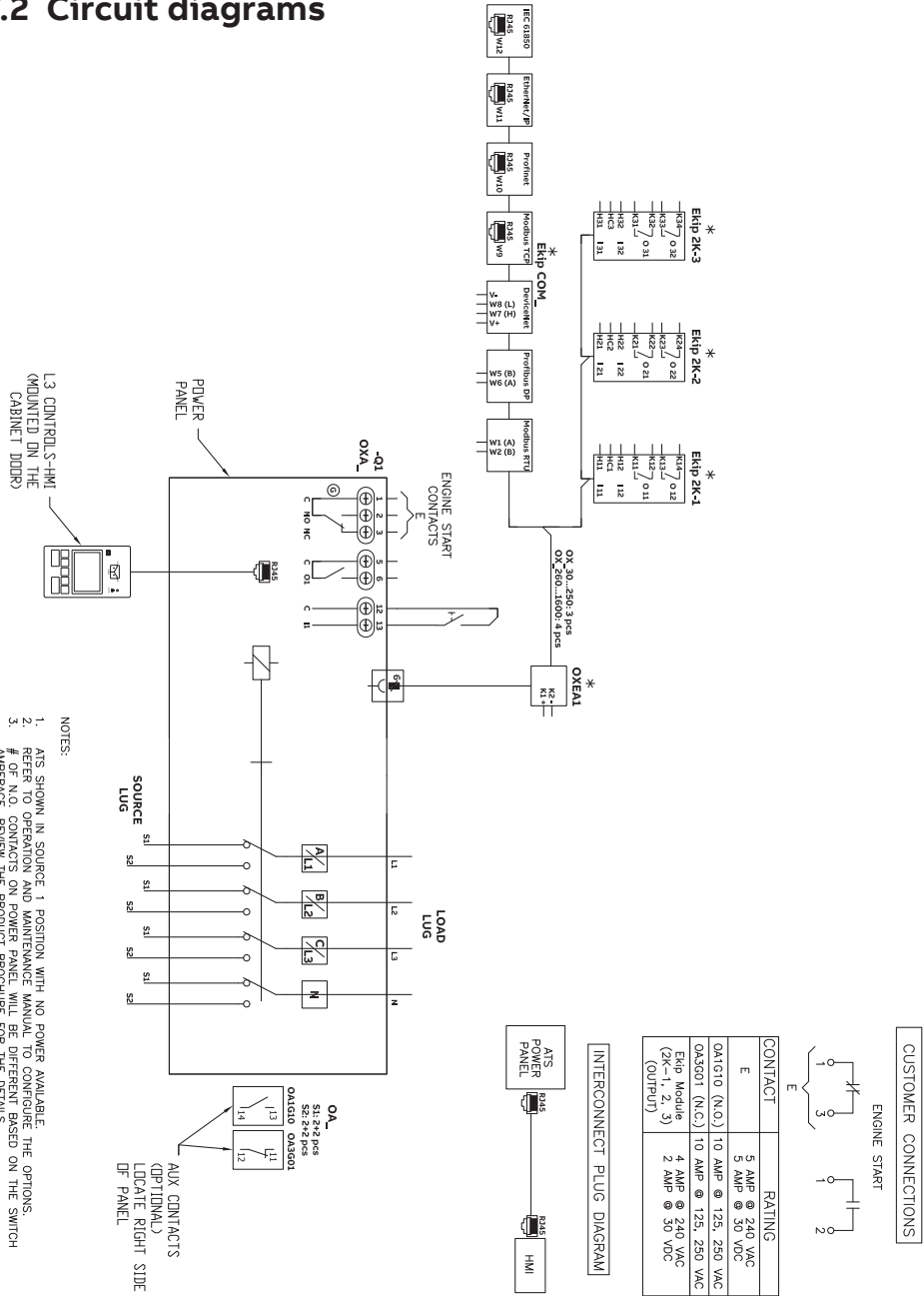

Fig. 7.2 ZTG, open transition circuit diagram

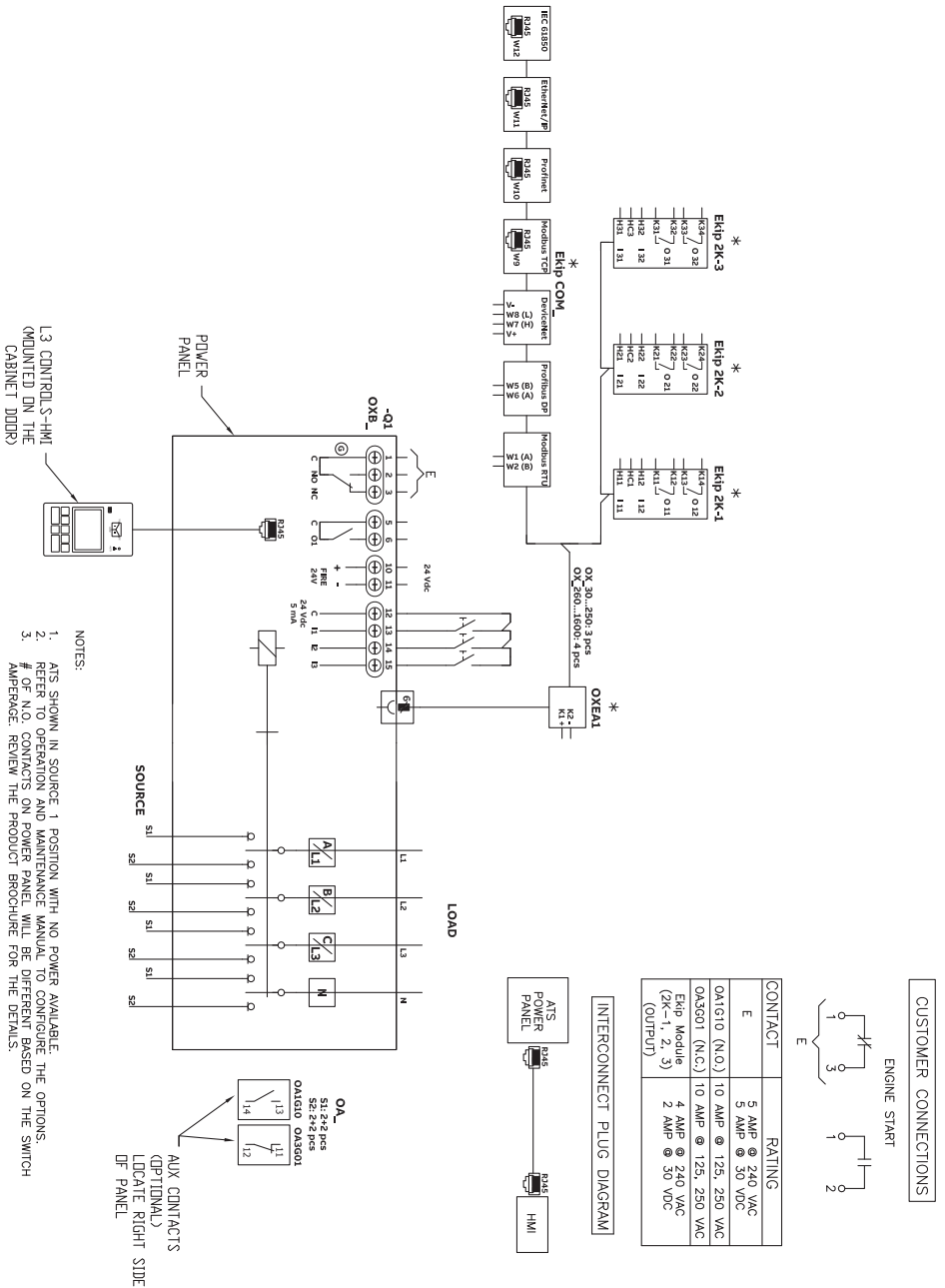

Fig. 7.3 ZTGD, delayed transition circuit diagram

7.3 Overall Dimensions

ZTG series dimensions and weights, UL Type 1 Enclosure

Model	ATS Rating (A)	Poles	Ref. Figure	Weight ¹ lb (kg)	Dimensions ² in (mm)		
					Height	Width	Depth
ZTG ZTGD	30 - 200	2	A	89 (40)	32 (813)	24 (610)	12 (305)
		3	A	93 (42)	32 (813)	24 (610)	12 (305)
		4	A	98 (44)	32 (813)	24 (610)	12 (305)
	260	2	A	145 (66)	46 (1168)	24 (610)	14 (356)
		3	A	150 (68)	46 (1168)	24 (610)	14 (356)
		4	A	155 (70)	46 (1168)	24 (610)	14 (356)
	400	2	A	153 (69)	46 (1168)	24 (610)	14 (356)
		3	A	159 (72)	46 (1168)	24 (610)	14 (356)
		4	A	290 (131)	54 (1372)	28 (711)	19.5 (495)
600	2	B	278 (126)	54 (1372)	28 (711)	19.5 (495)	
	3	B	284 (129)	54 (1372)	28 (711)	19.5 (495)	
	4	B	290 (131)	54 (1372)	28 (711)	19.5 (495)	
800 - 1200	3	C	482 (219)	74 (1880)	40 (1016)	19.5 (495)	
	4	C	515 (234)	74 (1880)	40 (1016)	19.5 (495)	

¹Enclosures Type 3R, 12, 4, and 4X weights are up to 22% greater than Type 1 Enclosures.

²Enclosures Type 3R, 12, 4, and 4X dimensions differ. Consult Tech Support for details.

³All dimensions and weights are approximate and subject to change without notice.

⁴Packing materials must be added to weights shown. Allow 15% additional weight for cartons, skids, crates, etc.

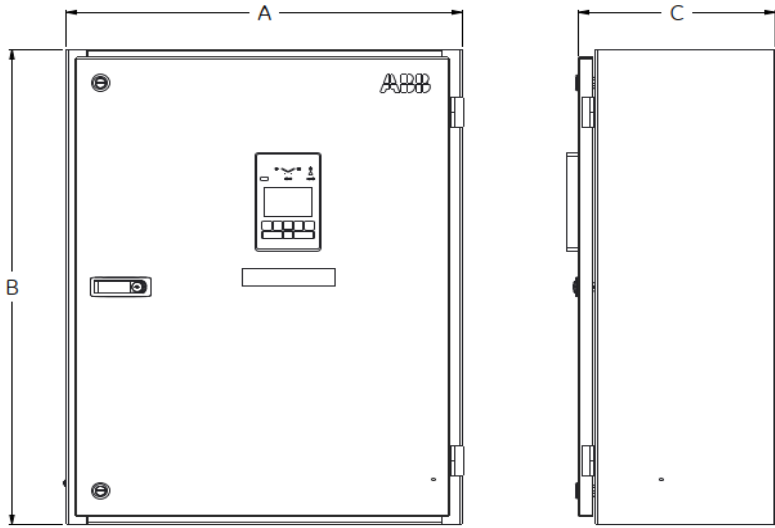

Figure A

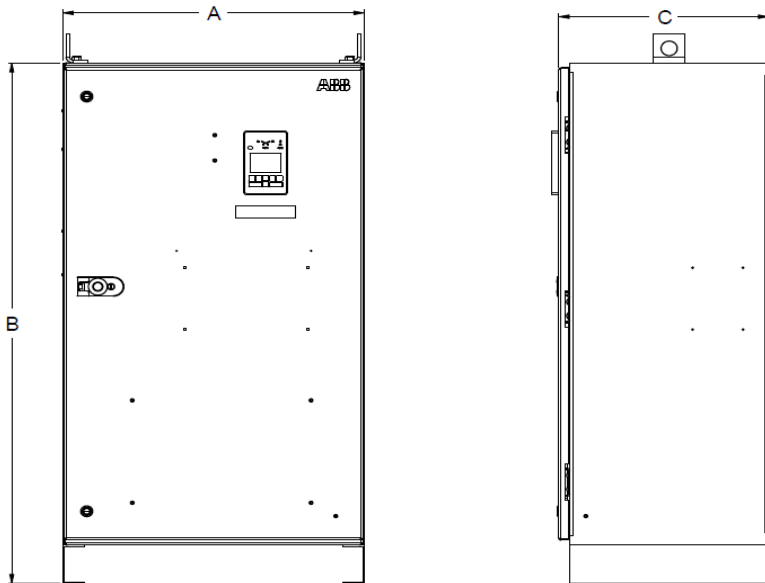

Figure B



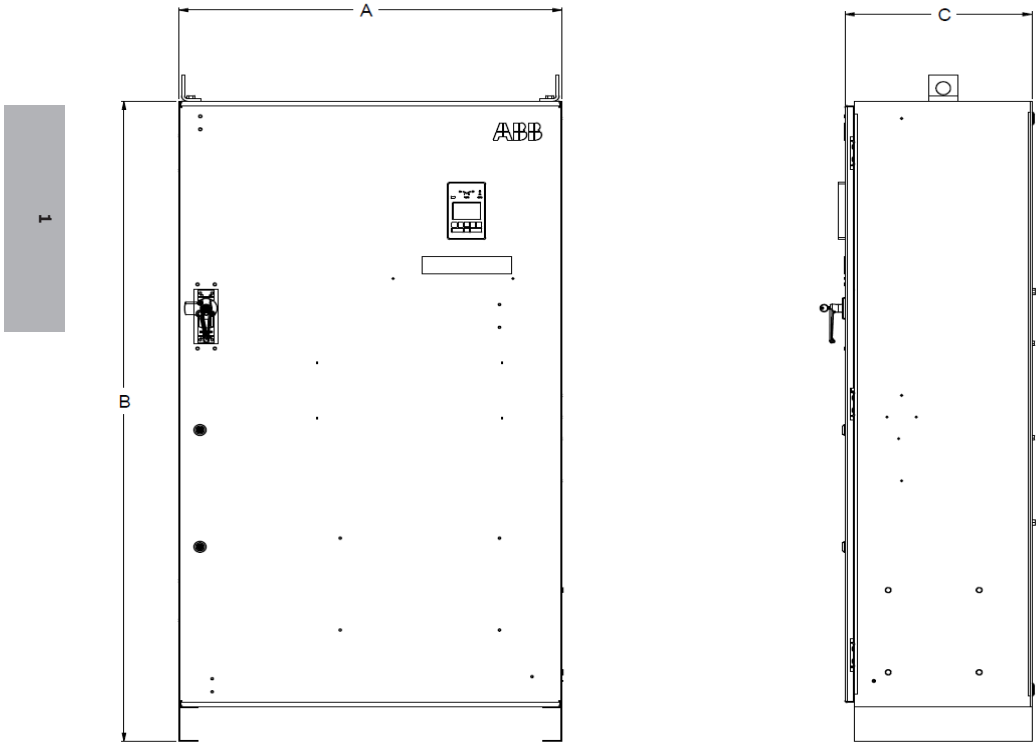

Figure C

8. Maintenance



Warning

Any maintenance should be conducted by trained and authorized personnel only. Appropriate personal protective equipment (PPE) shall be used when performing maintenance on the ATS panel. Hazardous voltage may be present. Disconnect all power sources before performing work inside the ATS panel. Failure to do so may result in serious injury or death.

Maintenance Principle

The Zenith ZTG(D) series 30-1200 A, 200-480 Vac automatic transfer switches, powered by TruONE, are designed so that the contacts last their designed lifetime without any routine maintenance needs. If there are abnormal conditions such as a fault or overload without adequate protection, or extreme environment conditions, a failure of ATS components may occur. Fortunately, all critical modules, including complete mechanism with electronics (controller, power module, and solenoid mechanism), HMI, and accessories are easily replaceable. Refer to Chapter 11 for replacement parts.

On the other hand, when the contacts have seen an event, or have met the end of their lifetime, the whole switch should be replaced – which can be done easily by replacing the complete TruONE power panel within the enclosure.

In the case you suspect a failure may be due to manufacturer defect and covered under warranty, see Chapter 1.3.

Refer to Chapter 7 technical data for ATS contact endurance and note that the number of operations can be viewed in the information menu from the HMI.

Routine Inspection

ABB recommends a routine (such as annual) inspection to, e.g. , check electrical termination temperatures, ensure unit is clean, check voltage levels, test transfers, # of operations, etc. to ensure everything is in proper working order.

Recommended annual inspection includes:

- Review event log
- Check number of operations and other switch status figures
- Visual inspection both inside and outside of enclosure for damage or debris
- Test transfer of load
- Observe voltage levels of both sources within expected range
- Cable lug torque verification



Installation instruction

Automatic transfer switches

9. Panel installation	99
9.1 Basic Tools for Installation and Maintenance	100
9.2 Equipment Inspection and Storage	100
9.3 Lifting and mounting the panel	101
9.4 Mounting the automatic transfer switch	102
9.4.1 Mounting hole dimensions	102
9.5 Mounting of the handle	103
9.5.1 Mounting of the handle to operation position, manual mode	103
9.5.2 Mounting of the HMI, automatic mode	104
9.5.3 HMI Installation	105
9.6 Wire Connection	106
9.7 Final Equipment Inspection	106
9.8 Initial Energizing	107

10. Accessories	109
10.1 Phase barriers	109
10.2 Auxiliary contact blocks	110
10.3 Auxiliary power supply and Ekip -modules	111
10.4 HMI protective cover	113
11. Replacement parts	115

9. Panel installation

Before mounting the product, please, check the product identification from the product identification label, which is located on the front panel under the control interface unit (HMI). This label indicates the product model (type number), some important technical data information, minimum enclosure size, suitable wire information, etc.



Notice

Final inspection of the equipment should be performed prior to energizing the automatic transfer.

Remove any dirt or debris that may have collected during shipment or installation. NEVER use compressed air. Doing so could drive dirt or other foreign objects into electrical or mechanical components, which could cause damage. Use an industrial-quality vacuum cleaner to remove any dirt or foreign objects.

Be certain all cable connections are correct and that the phase rotation of both sources match.

Inspect the engine start connections and verify the correct connection of all control wires.

Check all programmable set points and adjust as necessary. In addition, adjust any optional accessories as required.

Be certain that the actual lug torque values are in keeping with the requirements outlined in the instruction book to ensure the integrity of power connections.

Check to be sure that all covers and barriers are properly installed and fastened.

If any damage is found or suspected, file a claim as soon as possible with the carrier, and notify the nearest ABB Zenith representative, or call 1-800-637-1738.

9.1 Basic Tools for Installation and Maintenance

Tool	Task
1/4" to 1/2" Allen head socket driver	Power cable connection
Torque wrench	Torquing of the lugs and other hardware as required. Range of device to be 50 - 500 in-lbs (5-57 N-m)
Torque screwdriver	Torquing of control wire terminations, auxiliary contact input terminals. 5 - 25 in-lbs (0.5 - 2.8 N-m)
Wire cutters/wire crimpers	Auxiliary contacts wire installation, Options installation
Voltmeter	Trouble shooting tool for measuring incoming voltage, frequency, continuity and control signal transmission.
Controller default password 00001	Changing parameters within the controller

Table 9.1 Required tools for common installation and maintenance tasks

9.2 Equipment Inspection and Storage



Warning

When performing a hi-pot or dielectric test on the power section of the ATS panel, DISCONNECT the complete electronics, controller, and mechanism section of the ATS from the power section to avoid potential damage to the electronics.

Before installation, if it is necessary, store the transfer switch in a clean dry place, protected from dirt and water. Provide ample air circulation and heat, if necessary, to prevent condensation.

See table 7.2 for recommended storage and ambient operating temperatures.

Once you have received the transfer switch, inspect it for any damage. This includes damage to the enclosure, power panel, control panel and wiring harness. If any damage is found or suspected, file a claim as soon as possible with the carrier and notify the nearest ABB Zenith representative.

9.3 Lifting and Mounting the Panel

Lifting guidelines

Adequate lifting means must be used to mount the transfer switch into place. The recommended method for moving the ATS, up to 1200 A, is with lifting strap and lifting equipment rated for the equipment weight.

Lifting, Mounting and Installation

The safe operation of your switch at all times is paramount to ABB. Please recognize that hazardous voltages and currents can exist during normal operation, and any maintenance on the transfer switch must be performed utilizing appropriate safety measures. Installation, adjustment, maintenance or removal of the switch must only be carried out by qualified personnel and with all power to the switch turned off. It is recommended that only qualified electricians be allowed to install or provide maintenance on the switch.

Prior to installation, store the transfer switch in a clean dry location, protected from dirt and water. Provide ample air circulation and heat if necessary to prevent condensation. See table 7.2 for recommended storage and ambient operating temperatures.

ABB Zenith automatic transfer switches are packaged as per the standard packaging regulatory standards requirement suitable for domestic and international shipment through all modes of transportation (air, sea and road). Once you unpack the units, please make sure all the components are received as per the BOM. For any missing items, contact your local ABB Zenith service representative.



Danger
Hazardous Voltage can Cause Severe Injury or Death

Turn OFF all power before installation, adjustment, or removal of transfer switch or any of its components.



Warning

Due to hazardous voltages and currents, ABB recommends that an ABB Certified technician or a qualified electrician perform the installation & maintenance of the switch.



Danger
Hazardous Voltage can Cause Severe Injury or Death

Automatic Transfer Switch Equipment must be electrically grounded. Failure to do so may result in malfunction of the switch and possible damage to surrounding equipment.



Warning

Before drilling conduit entry holes or any accessory mounting holes, cover and protect the switch and control panel to prevent dirt and metal fragments from entering the mechanical and electrical components.

9.4 Mounting the automatic transfer switch

9.4.1 Mounting hole dimensions

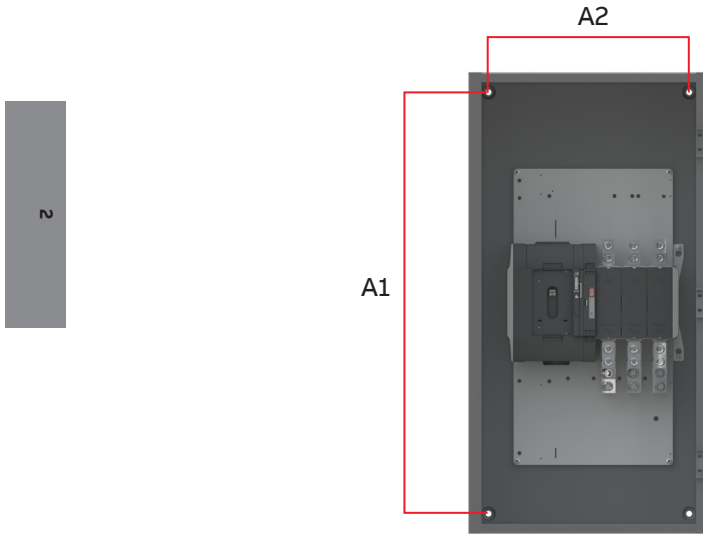

Fig. 9.1 Automatic transfer switches, Mounting hole dimensions, refer to Table 9.2 for A1 and A2 values

ZTG series enclosure mounting dimensions

Model	ATS Rating (A)	Poles	Type 1, in (mm)		Type 3R/4/4X/12, in (mm)	
			Height (A1)	Width (A2)	Height (A1)	Width (A2)
ZTG ZTGD	30 - 200	2	28.0 (711)	20.0 (508)	33.3 (845)	18.0 (457)
		3	28.0 (711)	20.0 (508)	33.3 (845)	18.0 (457)
		4	28.0 (711)	20.0 (508)	33.3 (845)	18.0 (457)
	260	2	42.0 (1067)	20.0 (508)	47.25 (1200)	18.0 (457)
		3	42.0 (1067)	20.0 (508)	47.25 (1200)	18.0 (457)
		4	42.0 (1067)	20.0 (508)	47.25 (1200)	18.0 (457)
	400	2	42.0 (1067)	20.0 (508)	47.25 (1200)	18.0 (457)
		3	42.0 (1067)	20.0 (508)	47.25 (1200)	18.0 (457)
		4	46.0 (1168)	24.0 (610)	51.25 (1302) ¹	22.0 (559)
	600	2	46.0 (1168)	24.0 (610)	51.25 (1302) ¹	22.0 (559)
		3	46.0 (1168)	24.0 (610)	51.25 (1302) ¹	22.0 (559)
		4	46.0 (1168)	24.0 (610)	51.25 (1302) ¹	22.0 (559)
800 - 1200	3	66.0 (1676)	35.0 (889)	71.25 (1810)	34.0 (864)	
	4	66.0 (1676)	35.0 (889)	71.25 (1810)	34.0 (864)	

¹ 4X enclosures add 0.05 inches to dimensions

Table 9.2 Zenith ZTG(D) panel mounting dimensions

9.5 Mounting of the handle

For more information of operating, position indication and the selection of the operating mode, see the Chapter 3.2 Operating and locking.

More information, see animation: Manual and automatic operation - TruONE® ATS (<https://youtu.be/bosvSPVi2sM>).



Warning

Verify the condition of power source prior to manually transferring. Manual operation may result in out-of-phase transfer when both sources are energized.

9.5.1 Mounting of the handle to operation position, manual mode

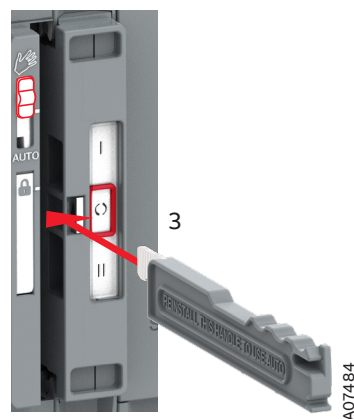
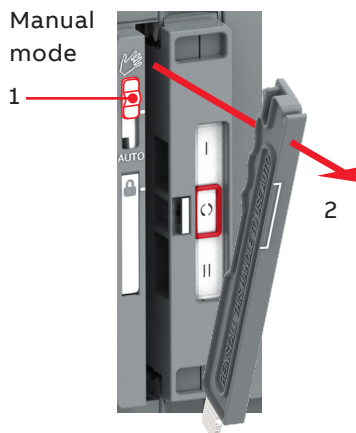
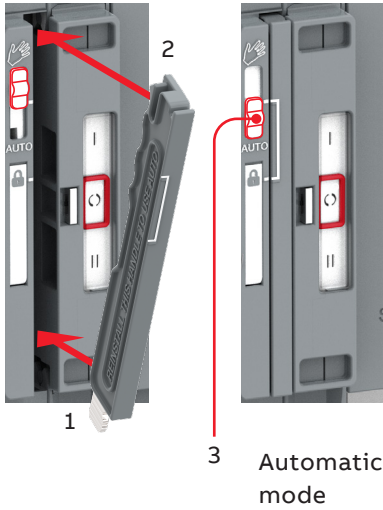

Fig. 9.2 Mounting the handle to the operating position; turn the slide switch to the Manual mode (Hand), lift the handle and place it to the operating position

9.5.2 Mounting of the HMI, automatic mode



A07484



Notice

When the slide switch is moved to the AUTO position, the ATS is functioning immediately in the automatic control mode.

Fig. 9.3 Before moving to the Automatic mode, the operating handle must set to its place. When the handle is in its place properly, the slide switch will move to the Locking mode automatically and the switch is allowed to be padlocked, if needed. From the Locking mode the slide switch can be moved to the Automatic mode

9.5.3 HMI Installation



Max. 3 m,
HMI (RJ45) cable

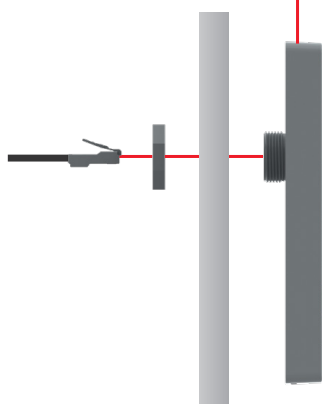

A07490

Fig. 9.4 HMI can be mounted on the switch or the door, door drilling. HMI protective cover available as accessory, type OXEC21, provides protection against accidental contact, see Chapter 10.4, Mounting of accessories

9.6 Wire Connection



Notice
Lugs come pre-installed and torqued

ZTG series AL/CU UL Listed Solderless Screw-Type Terminals for External Power Connections

Model	ATS Rating (A)	Source/Load	Lug Type	Wire Range	Cables per pole	Cables - Tightening Torque ¹ , lb-in (N-m)
ZTG ZTGD	30 - 60	Source 1	OZXA-24	14 - 2/0 AWG	1	50/5.7
		Source 2 / Load	OZXA-100	12 - 2/0 AWG	1	132/15.0
	100 - 200	Source 1	OZXA-25	6 AWG - 300 KCMIL	1	275 / 31.1
		Source 2 / Load	OZXA-200	4 AWG - 300 KCMIL	1	200 / 22.6
	260 - 400	Source 1	OZXA-26	2 AWG - 600 KCMIL	1	375 / 42.4
		Source 2 / Load	OZXA-400	2 AWG - 600 KCMIL	1	375 / 42.4
	600	Source 1	OZXA-800L	2 AWG - 600 KCMIL	2	500/56.5
		Source 2 / Load	OZXA-800E	2 AWG - 600 KCMIL	2	500/56.5
	800 - 1200	Source 1	OZXA-1200	2 AWG - 600 KCMIL	4	500/56.5
		Source 2	OZXA-800S	2 AWG - 600 KCMIL	4	500/56.5
		Load	OZXA-1200	2 AWG - 600 KCMIL	4	500/56.5

¹Do not exceed this value - may cause damage to switch, voiding warranty

Table 9.3 Power Cable Torque Requirements

9.7 Final Equipment Inspection

Prior to energizing the transfer switch:

1. Remove any debris incurred, with a vacuum, due to shipment or installation.
2. Verify that all cabled connections are correct and that phase rotation of both sources match.
3. Check engine start connections.
4. Verify the correct connection of all control wires.
5. Check settings of all timers and adjust as necessary.
6. Adjust any optional accessories as required.
7. Check the lug torque values of the power connections.
8. Make sure that all covers and barriers are installed and properly fastened.

For simple details on start-up refer to ZTG Quick start guide document number 1SCC303023K0201.

Each ABB Zenith transfer switch is factory wired and tested. A complete information package is furnished with each switch which includes:

- Sequence of operation.
- Description and operation of all accessories supplied.
- Power panel connection diagram and schematic.
- Description and identification of all customer field connections.

Installation of ABB Zenith transfer switches includes:

- Mounting the transfer switch cabinet.
- Connection of Source 1, Source 2, and Load cables or bus bars.
- Connection of external control circuits as required.

9.8 Initial Energizing

Before proceeding, refer to the information package supplied with the ATS and read and understand the information on all accessories provided, including this complete document.

Before energizing the panel

1. Confirm that installation has been performed by a qualified person and in accordance with NFPA 70 (NEC).



Notice
This installation should be properly operated and maintained in accordance with the safety practices of NFPA 70E.

2. Confirm rating label matches the installed application. Rating label is located inside the panel enclosure.
3. Confirm that cables are connected properly and torqued according to the ATS labeling.
4. Verify that the enclosure ground connection is properly terminated.
5. Confirm that control wiring for engine start is properly terminated to the engine start contact (located in Figure 2.1, number 8). Additionally, connect all applicable digital I/O, communications, and auxiliary contact wiring.
6. Flip slide switch (Figure 2.1, number 4) to AUTO
7. Ensure that all objects and debris are removed from enclosure, and enclosure is closed and latched.

Energizing the panel

1. Close Source 1 circuit breaker.

NOTE: The HMI should illuminate if line voltage is present and S1 LED should light up.

2. Verify the phase to phase voltages at the Source 1 terminals.
3. Initiate auto configure from HMI default screen: Enter>Parameters>System Parameters>Start Automatic Configuration and allow a few seconds for system parameters to set.
4. Close the Source 2 circuit breaker.
5. Start the generator engine.

NOTE: If generator voltage is present at Source 2 terminals, S2 LED should light up.

6. Verify phase rotation of S1 matches that of S2.
- NOTE:** The ATS will not allow transfer if phase rotation does not match.
7. Shut down the generator engine.
8. Place the ATS in AUTO mode from the HMI by pressing AUTO key.
9. For additional start-up guidance for the ATS, please refer to ZTG Quick Start Guide, document number 1SCC303023K0201.

10. Accessories



Warning

Any troubleshooting should be conducted by trained and authorized personnel only. Appropriate personal protective equipment (PPE) shall be used when troubleshooting the ATS panel. Hazardous voltage may be present. Disconnect all power sources before performing work inside the ATS panel. Failure to do so may result in serious injury or death.

More information, see animation:
Installation of accessories - TruONE® ATS
(<https://youtu.be/qV2KolV38GY>).



10.1 Phase barriers

Phase barriers must be used to maintain a clearance of 1 inch on the automatic transfer switch types. They are included with the shipment of ZTG series ATS Panel.

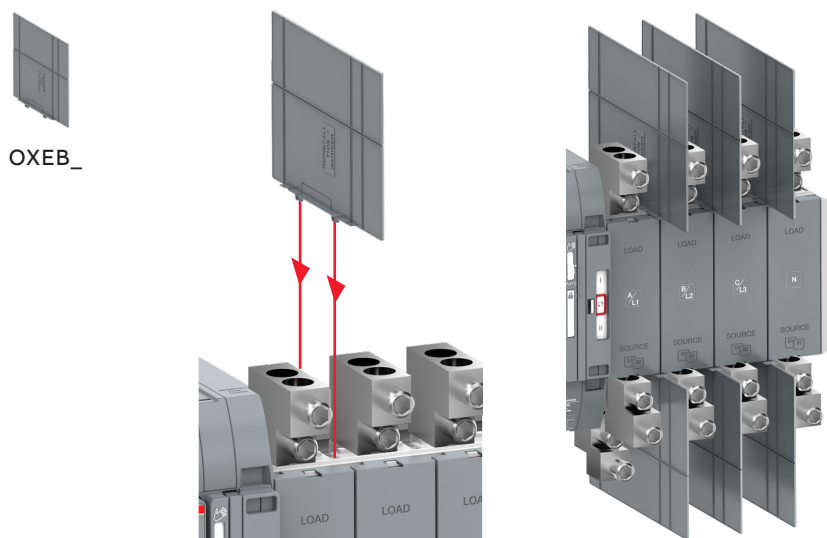

Fig. 10.1 Mounting of phase barriers, type OXEB_

10.2 Auxiliary contact blocks

Refer to Figure 7.1 for auxiliary contact ratings.

Position	OA1G10	OA3G01
SOURCE 1 (S1), max 2+2		
I		
O		
II		
SOURCE 2 (S2), max 2+2		
I		
O		
II		

Table 10.1 Contact positions

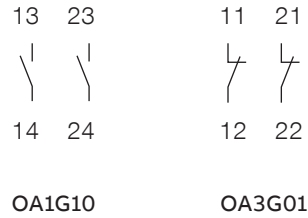

Fig. 10.3 Labels for contact numbering

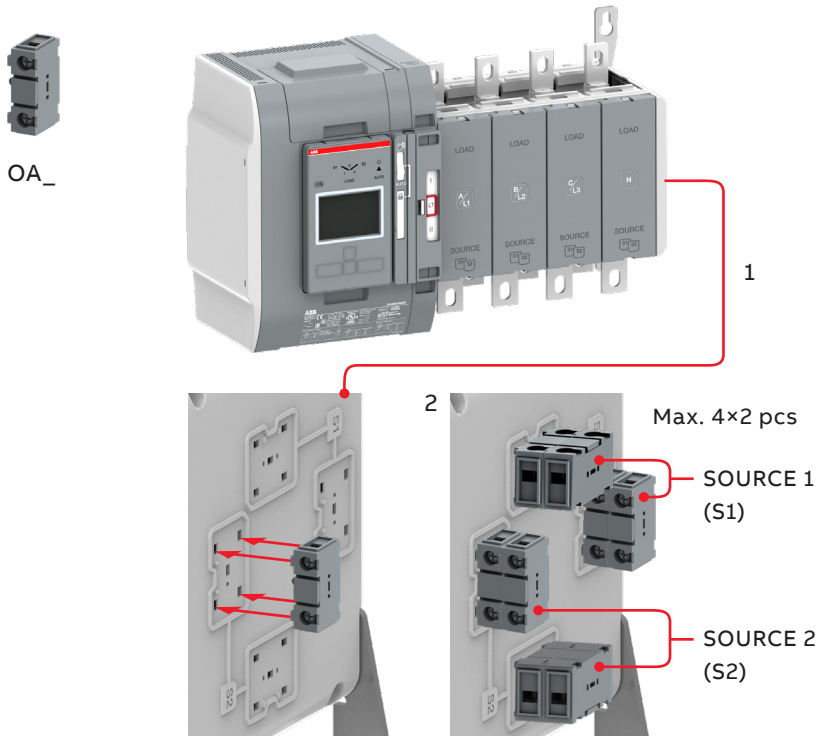

Fig. 10.2 Mounting of the auxiliary contact blocks, type OA_

10.3 Auxiliary power supply and Ekip -modules

ZTG(D) 30-1200 A, 200-480 Vac
Automatic transfer switches can be equipped with Ekip-modules. Ekip-modules are mounted with a auxiliary power supply module, OXEA1. Suitable Ekip-modules are: Ekip link, signalling and connectivity modules. For more information, see Chapter 5, Electronic accessories.

The maximum number of Ekip-modules varies by panel ampacity :

- 30-200 A: 3 Ekip modules
- 260-400 A: 4 Ekip modules

2

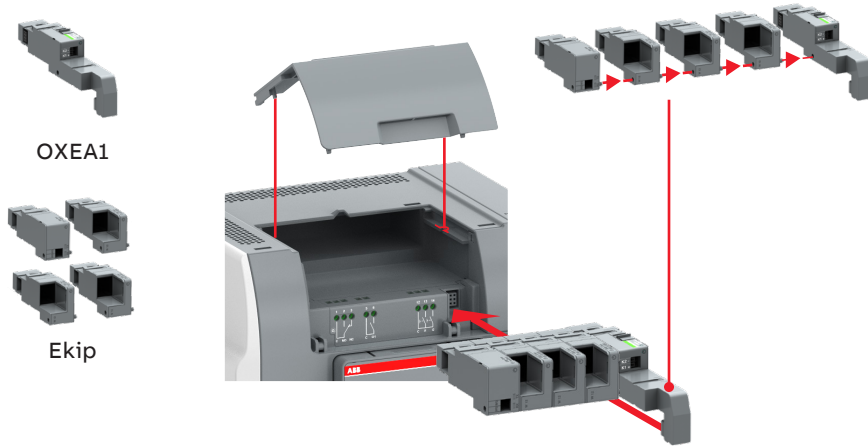

Fig. 10.4 Mounting of the auxiliary power supply module OXE1 and Ekip –modules

A07491

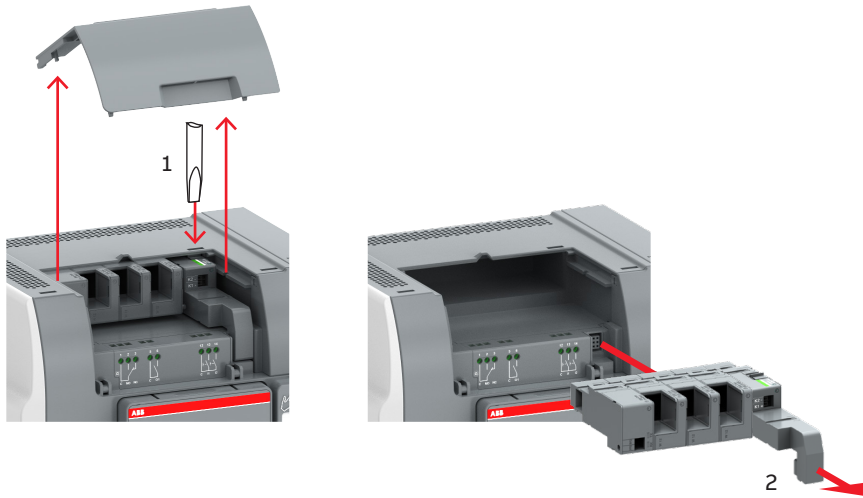

Fig. 10.5 Removing the auxiliary power supply module OXE1 and Ekip –modules from the automatic transfer switch

A07491

10.4 HMI protective cover

UL Type 3R HMI protective cover, type OXEC21, provides protection against water ingress. It comes standard with NEMA 3R enclosures, and is available as a replacement part.

Fig. 10.6 Mounting of HMI protective cover, type OXEC21

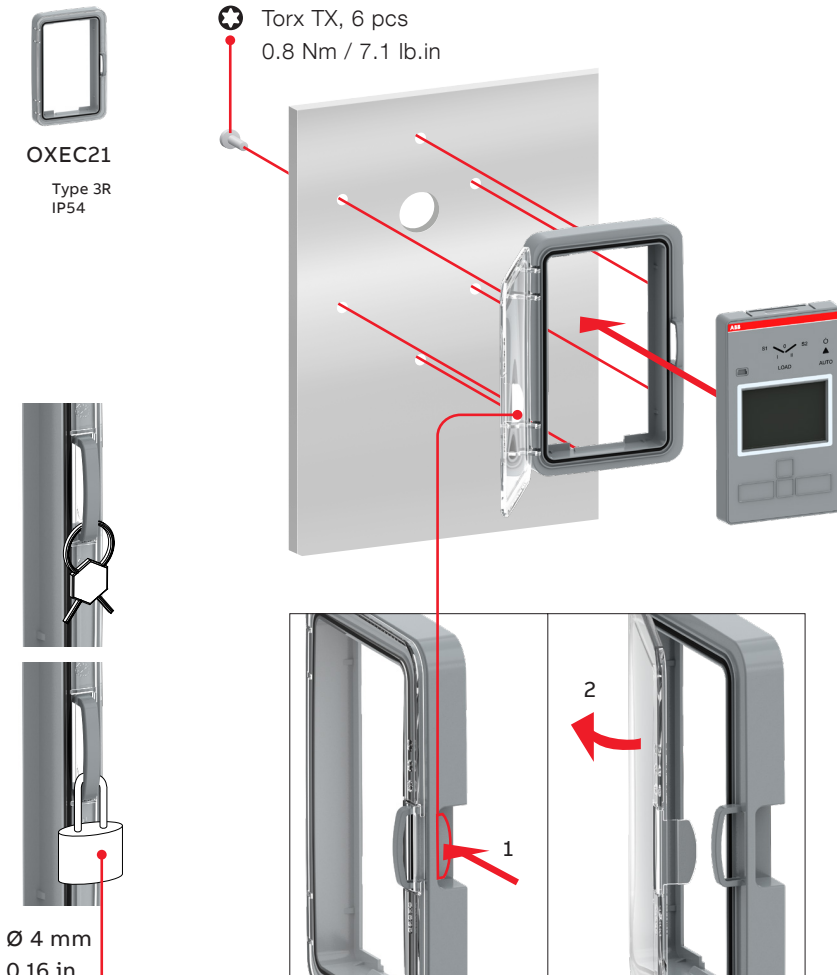

11. Replacement Parts

ZTG series replacement parts				
Type	Suitable for Switches	Order code	Weight (lb)	
HMI module	Open transition (ZTG 30-1200 A, 200-480 Vac)	OXAHMI-L3	0.42	
	Delayed transition (ZTGD 30-1200 A, 200-480 Vac)	OXBHMI-L3	0.42	
Manual handle	Open transition and delayed transition (ZTG(D) 30-1200 A, 200-480 Vac)	OXHANDLE-1600	0.18	
Open transition (ZTG, 200-480 Vac)				
Complete ¹ mechanism with electronics	30-260 Amps	OXAMECH-2-L3	16.28	
	400-600 Amps	OXAMECH-3-L3	21.12	
	800-1200 Amps	OXAMECH-4-L3	23.32	
	Delayed transition (ZTGD, 200-480 Vac)			
	30-260 Amps	OXBMECH-2-L3	16.50	
	400-600 Amps	OXBMECH-3-L3	21.34	
Phase barrier	800-1200 Amps	OXBMECH-4-L3	23.54	
	30-1200 Amps, 3 pole	OXEB1600/4	1.10	
	30-1200 Amps, 4 pole	OXEB1600/6	1.54	

¹Includes the tested, field replaceable module complete with operating mechanism, power module, and controller

Fig. 11.1 Replacement parts, available in Empower



Contact us

ABB Zenith Controls, Inc.

305 Gregson Drive
Cary, NC 27511

24-hour support:

ABB Technical Services
+1 (800) 637-1738
epis.pqs-service@abb.com

abb.com/lowvoltage