

# Flexitest switch assemblies Type FT-19R and FT-19RX

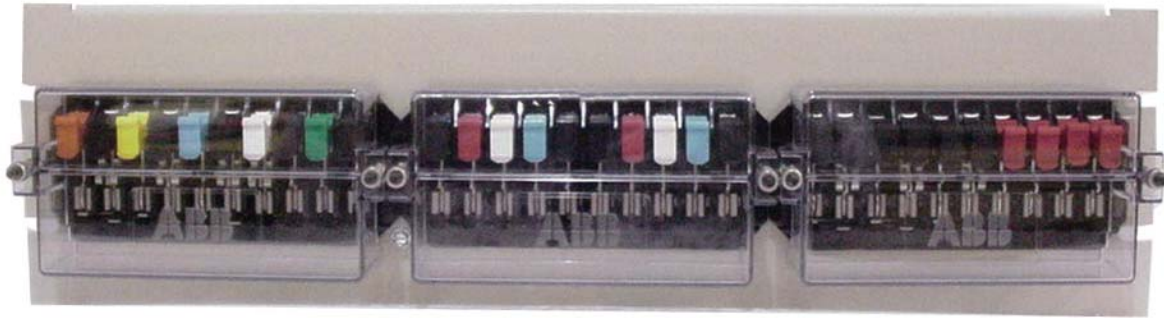

FT-19R 3RU with Individual Clear Covers

## APPLICATION

The type FT-19R (standard length) and FT-19RX (extended length) Flexitest Switch Assemblies for rack and switchboard mounting permit convenient isolation of switchboard relays, meters, and instruments, allowing quick and easy multi-circuit testing by any conventional test method. The FT-19R and FT-19RX both utilize FT-1 switches to isolate protective relays, meters, and equipment, allowing the user to safely service installed equipment without disturbing the system.

## FEATURES

The FT-19R and FT-19RX assemblies accommodate up to three FT-1 switches mounted on a 19" wide, two-rack unit (2RU), three-rack unit (3RU), or four-rack unit (4RU) high (steel or aluminum) mounting panel. Any combination of FT-1 switches may be selected. Steel panels are commonly available in gray, beige and black; although panel color or finish, as well as panel height, can be customized to meet the user's requirements. The three rack unit (3RU) assembly also allows switches to be positioned off-center, in either low or high upper mounting positions in the rack panel, allowing room for special customer label requirements.

The FT-19RX extends the rear terminals of the FT-1 switches to the same depth as most 19" rack mounted equipment thereby providing improved access to the rear terminals. FT-19RX two-rack unit assemblies (2RU) allow the user to mount protective relays or other equipment in the racks directly above and below the FT-19RX, optimizing the space in the rack and reducing the amount of wire required.

Either assembly can be ordered with a full-length clear cover (standard), or optional individual clear covers for each switch. All clear covers allow the switch handles to be opened or closed when the cover is in place, which is especially important during maintenance and repair of equipment. Full-length black or individual black covers are also available for applications that require switch handles to be always closed when the cover is on. All covers can be secured with a meter seal or similar lockout device.

Both the FT-19R and FT-19RX Switch Assemblies make troubleshooting, testing, and wiring easier and more reliable. They also help to prevent inadvertent or unintended equipment operation.

## ADVANTAGES

- **Safety** - the positive make before break current shorting feature of the FT-1 switches safely isolate equipment from CT (current transformer) circuits.
- **Security** - meter seals can be inserted through the cover studs to prevent unauthorized access with lockable covers further increasing security.
- **Convenience** - immediate access to relay or other device circuits without disconnecting any wiring.
- **Flexibility** - switches are available in any combination of up to 10 current and/or potential poles, all easily configured using online FT-1 and FT-19R configurator found at [www.ft1switch.com](http://www.ft1switch.com).
- **Quality** - over 50 years of field proven applications.
- **Technical and application engineering support** - available 24/7.
- **Certifications** - UL, CUL, CSA listed, Class 1E qualified.

## SPECIFICATIONS

The standard length FT-19R assembly and the extended length FT-19RX are rated at 600 volts and 30 amps. All assemblies meet or exceed all requirements of ANSI/IEEE Standard C37-90.

## MOUNTING

The FT-19R and FT-19RX are designed for mounting on 19-inch rack structures or conventional panels. Connections, layout, weight and dimensions are shown on page 20 - 23, figures 1, 2 and 3.

## WARRANTY

All products made at the ABB Protective Relays and Switches Division are backed by a standard 12-YEAR warranty. The quality of ABB products comes from years of experience and vigorous quality testing programs.





FT-19R 2RU with Full Length Clear Cover



FT-19 3RU lockable version



FT-19 3RU with Full Length Clear Cover. Switches mounted in the lower position, with special customer labels



FT-19RX 3RU with Full Length Clear Cover

**FT-19R Flexitest Switch Assembly**

The FT-19R assembly consists of up to three FT-1 switches mounted in a 19-inch wide, two, three or four rack unit panel suitable for rack or switchboard mounting. Any combination of FT-1 switch styles may be selected. These assemblies include a full length clear cover standard.

**FT-19R ordering information**

**FT-19R assembly**

**Terminal connections**

- Screw type (standard)
- Stud & nut type (optional)

**Panel height**

- Two rack units
- Three rack units (switches centered)
- Three rack units (switches low)
- Three rack units (switches high)
- Four rack units (switches low)
- Special<sup>1</sup>

**Color and material**

- Brushed finish aluminum
- Beige (textured surface) steel
- Gray (ANSI 61 smooth surface) steel
- Gray (ANSI 70 smooth surface) steel
- Gray (RAL7035 smooth surface) steel
- Black (smooth surface) steel
- Special<sup>1</sup>

**FT-1 switch code numbers**

- Position A (see table for code number)
- Position B (see table for code number)
- Position C (see table for code number)

000 = No switch (cover plate provided over switch cutout)  
 3-Digit FT-1 code number (see page 10-19 Switch Selection Guide)

**Cover**

- Full length clear cover (standard)
- Full length clear cover (use with additional features only)<sup>2</sup>
- Full length black cover
- Individual black covers
- Individual clear covers
- Lockable full length clear covers
- Lockable full length black covers

**Additional Features**

- None
- Flat panel (panel and cabinet mount only)<sup>2</sup>

**Typical catalog number**

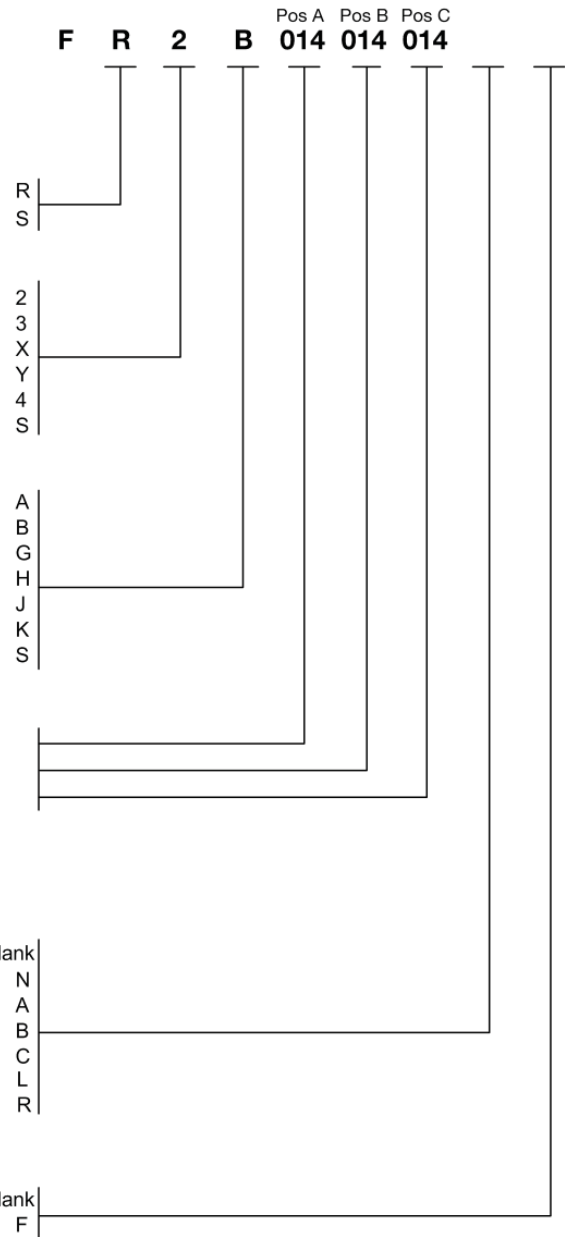

<sup>1</sup> Code "S" may be used to identify special requirements.  
<sup>2</sup> Must select cover option when "additional features" is selected.

**FT-19RX Flexitest Switch Assembly**

The FT-19RX assembly consists of up to three FT-1X switches mounted in a 19-inch wide, two, three or four rack unit panel suitable for rack or switchboard mounting. Any combination of FT-1X switch styles may be selected. These assemblies include a full length clear cover standard.

**FT-19RX ordering information**

**FT-19RX assembly**

**Terminal connections**

- Screw type (standard)
- Stud & nut type (optional)

**Panel height**

- Two rack units
- Three rack units (switches centered)
- Three rack units (switches low)
- Three rack units (switches high)
- Four rack units (switches low)
- Special <sup>1</sup>

**Color and material**

- Brushed finish aluminum
- Beige (textured surface) steel
- Gray (ANSI 61 smooth surface) steel
- Gray (ANSI 70 smooth surface) steel
- Gray (RAL7035 smooth surface) steel
- Black (smooth surface) steel
- Special <sup>1</sup>

**FT-1 switch code numbers**

- Position A (see table for code number)
- Position B (see table for code number)
- Position C (see table for code number)

000 = No switch (cover plate provided over switch cutout)  
 3-Digit FT-1 code number (see page 10-19 Switch Selection Guide)

**Cover**

- Full length clear cover
- Full length black cover
- Individual black covers
- Individual clear covers
- Lockable full length clear covers
- Lockable full length black covers

**Extended length switches**

- 8.25 inches
- 10.25 inches

**Additional features**

- None
- Flat panel (panel and cabinet mount only)

**Typical catalog number**

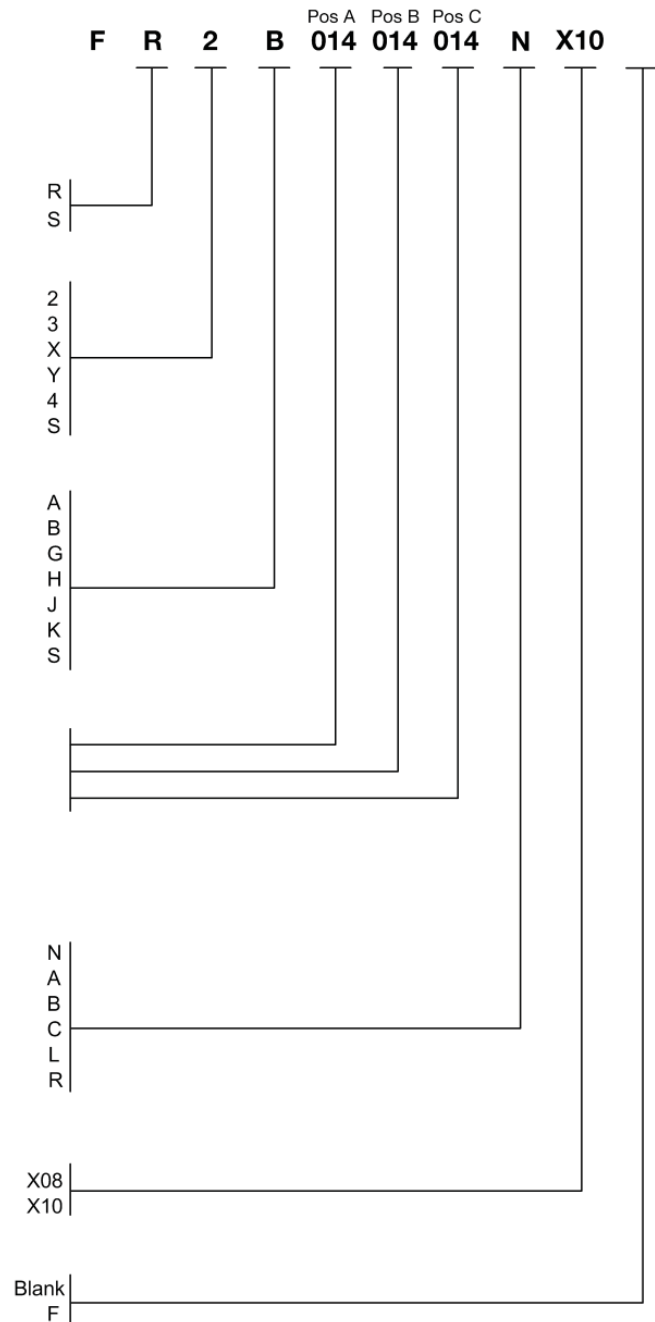

<sup>1</sup> Code "S" may be used to identify special requirements.

## ORDERING INFORMATION FOR FT-19R/FT-19RX

### Terminal Connections

The FT-1 Switches for FT-19R and FT-19RX assemblies can be ordered with standard (# 8) screw terminals or optional stud & nut terminals.

### Panel Height

The 19" wide mounting panel can be ordered in different Rack Unit (RU) heights: 2RU, 3RU or 4RU. The 3RU assembly is available with switch positions centered, mounted high or mounted low. The 4RU is available with switches mounted low. Other panel specifications can be ordered using the letter "S" in the Panel Height field, indicating special requirements in the order notes.

### Panel Color & Material

Panels are available in the following colors and materials: ANSI 61 gray - steel; ANSI 70 gray - steel; RAL7035 gray - steel; beige - steel; black - steel; and brushed finish aluminum. Other panel specifications can be ordered using the letter "S" in the Panel Color & Material field, indicating special requirements in the order notes.

### FT-1 Switch Code Numbers (Positions A, B, and C)

Each FT-1 switch is identified by a unique three-digit "Code Number", which is required for each of the three FT-1 positions in the assembly (positions A, B and C).

To obtain the FT-1 Switch Style Number and the three-digit Code Number refer to the Switch Selection Guide on pages 10-23. To view by configuration, refer to page 10-19. To view by style number, refer to page 20-23. If a particular arrangement is not listed, contact the Coral Springs factory. A blanking plate will be provided for unused switch positions (A, B, or C) by using Code Number "000".

Switch Replacement: To add an FT-1 Switch in an unused position, or to replace a switch in an FT-19R assembly, provide the required FT-1 Switch Style(s) with an "R" prefix for screw terminals (e.g., R129A501G01), or an "RS" prefix for optional stud type terminals (e.g., RS129A501G01). For FT-19RX assemblies provide the required FT-1 Switch Style with an "R" or "RS" prefix plus the X08 or X10 length suffix (e.g., R129A501G01X10).

### Cover

For FT-19R assemblies, the Cover field should be left BLANK to order the unit with the standard full length clear cover. Optional covers are also available (full length black, individual clear, individual black, lockable full length clear, or lockable full length black), as noted. The cover field is always required on FT-19RX part numbers.

### Additional Features

To order special or customized features, use the code "S" in the proper position of the ordering information. All custom orders must be confirmed with the Coral Springs factory and sufficient information about the specifics should be provided. When ordering the "Flat panel" version, please note this is meant for applications where flush panel or cabinet mounting is required.

### Online Configurator

ABB has a web based tool to help build any FT switch or FT-19R switch panel assembly. Select options, view schematic details, and get style number information all with this easy to use tool. Please visit [www.ft1switch.com](http://www.ft1switch.com) to find out more.

**COVER PART ORDERS**

FT-19R and FT-19RX have several cover options. Each one may be purchased separately, and can retrofit any existing 19R assembly out in the field.

**Full length covers**

Span all three FT-1 switches.

**Clear** - Switch handles may be opened or closed with the cover on and secured. Order as Style 9676A28G01.

**Black** - Switch handles must be closed before cover can be mounted and secured. Order as Style 9676A28G02.

To retrofit a full length cover unto an existing 19R assembly purchased with individual covers, simply replace the inside FT-1 mounting studs with mounting hardware.

**Individual covers**

Span a single FT-1 switch.

**Clear** - Switch handles may be opened or closed with the cover on and secured. Order as Style 9683A78G01.

**Black** - Switch handles must be closed before cover can be mounted and secured. Order as Style 9683A78G03.

To retrofit individual covers unto an existing 19R assembly purchased with full length covers, simply replace FT-1 mounting hardware with cover mounting studs provided.

**Lockable Covers**

Lockable full length covers are also available which feature a slot to accommodate the locking bracket that is included. Order Style #9669A52G01 for clear and Style #9669A52G02 for black.



S# 9676A28G01  
Full Length Clear Cover



S# 9676A28G02  
Full Length Black Cover





S# 9683A78G01  
Individual Clear Cover







S# 9683A78G03  
Individual Black Cover



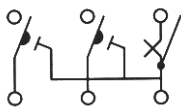
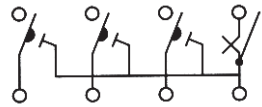



**FT-1 SWITCH ARRANGEMENT INFORMATION**

FT-1 SW ARRANGEMENT	P	T	C
SCHEMATIC			

FT-1 SW ARRANGEMENT	C-C	C-C-C	C-C-C-C
SCHEMATIC			

FT-1 SW ARRANGEMENT	C-A	C-B	C-D	C-E
SCHEMATIC				

SCHEMATIC LEGEND			
			
NON-SHORTING BLADE	SHORTING BLADE	CURRENT TEST JACK	SHORT CIRCUIT SPRING

P = Potential or control circuit with black handle. Potential blades with color switch handles are as follows:

T = Red, G = Green, Y = Yellow, Z = Blue, W = White, O = Orange, H = Brown, V = Purple.

C = Current Circuit, non-shortening, with black handle.

C-C, C-C-C, C-C-C-C = Current Shorting (make-before-break), with black handles. Current blades with color switch handles are as follows:

R= Red, 5 = Green, 6 = Yellow, 7 = Blue, 8 = White, 9 = Orange, 3 = Brown, 4 = Purple.

Note: The above represents standard schematic arrangements for the FT-1 Switch. For special arrangements, or for more detailed information on the FT-1 Switch, see DB 41-077.

Switch Selection Guide - Sorted by Configuration

\*P=potential, \*C=current

*P	*C	CONFIGURATION	CODE	STYLE
<u>1 Pole</u>				
		A B C D E F G H I J		
1	0	P . . . . .	415	R774B542G09
<u>2 Pole</u>				
		A B C D E F G H I J		
2	0	. . . . . P . P	343	R291B954G15
2	0	. . . P . . P . . .	032	R129A534G01
2	0	P P . . . . .	089	R291B954G13
2	0	T . . . . . T	342	R291B954G14
2	0	T O . . . . .	603	R9688A46G01
2	0	T T . . . . .	090	R291B954G16
2	0	Z Z . . . . .	467	R9676A38G01
0	2	. . . . . C-C .	088	R291B954G12
0	2	. . . . . C-C . . .	029	R129A531G01
0	2	. C-C . . . . .	076	R498A026G01
0	2	C-C . . . . .	738	R9689A74G01
<u>3 Pole</u>				
		A B C D E F G H I J		
3	0	. . . . . P P P	156	R716B871G11
3	0	. . . P P P . . . .	155	R716B871G09
3	0	. . . T T T . . . .	739	R9689A75G01
3	0	. . . Z Z Z . . . .	639	R9688A63G01
3	0	P . . . P . . . . P	157	R716B871G12
3	0	T Y O . . . . .	939	R991A939G01
1	2	C-C . . . . . T	285	R9663A78G01
0	3	. . . C C C . . . .	405	R716B871G10
<u>4 Pole</u>				
		A B C D E F G H I J		
4	0	. . . T P T P . . .	461	R9676A26G01
4	0	. . . T T T P . . .	462	R9676A27G01
4	0	. . P P P P . . . .	023	R129A524G01
4	0	. . T . T . T . T .	193	R291B956G31
4	0	. . T T T T . . . .	336	R1586C39G01
4	0	. . T T T T . . . .	196	R291B956G32
4	0	. . Z Z Z Z . . . .	744	R9689A80G01
4	0	. P . P . P . P . .	640	R9688A64G01
4	0	P . . . . . P P P	006	R129A506G01
4	0	P . . P . . P . . P	344	R291B956G24
4	0	P . . P P P . . . .	345	R291B956G25
4	0	P . . T . . Y . . Z	629	R9647A17G01
4	0	P P . . . . . P P	035	R129A538G01
4	0	P P P . . . . . P	075	R498A022G01
4	0	P P P . . . . . T	287	R9663A80G01
4	0	P P P P . . . . .	427	R9672A73G01
4	0	T . . . . . P P T	411	R763A166G01
4	0	T . . . . . T T T	067	R498A012G01
4	0	T . T . . . . T . T	086	R862A584G01
4	0	T T . . . . . P P	932	R991A932G01
4	0	T T . . . . . T T	A55	R991AA55G01
4	0	T T T . . . . . T	203	R1586C39G02
4	0	T T T T . . . . .	653	R9688A79G01
3	1	P P C . . . . . P	346	R291B956G26
3	1	P P P S . . . . .	643	R9688A67G01
2	2	O O C-C . . . . .	591	R9688A25G01

*P	*C	CONFIGURATION	CODE	STYLE
2	2	P . . . . . C-C P	007	R129A507G01
2	2	P P . . . . . C-C .	092	R291B956G18
2	2	P P C-C . . . . .	095	R291B956G30
2	2	T . . . . . C-C P	313	R9671A05G01
2	2	T T . . . . . C-C .	465	R9676A36G01
2	2	W W . . . . . C-C .	572	R9688A03G01
1	3	. . . C C C . . . P	347	R291B956G28
1	3	. . . C-C-C . . . P	219	R991A219G01
0	4	. . . . . C-C C-C .	091	R291B956G13
0	4	. C C C C . . . . .	093	R291B956G23
0	4	. C-A . . . . . C-A .	616	R9666A12G01
0	4	. C-C . . . C-C . . .	410	R763A109G01
0	4	. C-C C-C . . . . .	077	R498A027G01
0	4	C C C C . . . . .	195	R291B956G27
0	4	C-A C-A . . . . .	683	R9689A12G01
0	4	C-C C-C . . . . .	094	R291B956G29
0	4	C-C-C-B . . . . .	626	R991A626G01
0	4	C-C-C-C . . . . .	417	R837A087G01
<u>5 Pole</u>				
		A B C D E F G H I J		
5	0	P P . . . . . P P P	005	R129A505G01
5	0	P P P P P . . . . .	096	R291B957G15
5	0	T T . . . . . T T T	466	R9676A37G01
5	0	T Y Z W P . . . . .	610	R9688A55G01
3	2	P C-C P . . . . . P	008	R129A508G01
3	2	P P . . . . . C-C P	031	R129A533G01
3	2	P P . . . . . C-C P	838	R9666A95G01
3	2	P P . . . C-C . . . P	350	R291B957G17
3	2	P P P C-C . . . . .	349	R291B957G16
3	2	T P . . . . . C-C T	348	R291B957G09
1	4	. C C . C . C . P .	061	R498A002G01
1	4	C-C-C-C . . . . . P	717	R9689A54G01
0	5	C . C . C . C . C .	049	R129A555G01
0	5	C-C-C-C-D . . . . .	995	R991A995G01
<u>6 Pole</u>				
		A B C D E F G H I J		
6	0	. . . P P P P P P .	053	R188A416G01
6	0	P P . . . . . P P P P	421	R837A889G01
6	0	P P . . . P P . . P P	377	R629A568G01
6	0	P P P . . . . . P P P	004	R129A504G01
6	0	P P P P . . . . . P P	046	R129A550G01
6	0	P P P P P P . . . . .	216	R291B958G25
6	0	P P T . . . . T T T	206	R1586C40G01
6	0	T T T T . . . . . P P	558	R9683A81G01
6	0	T T T T . . . . . T T	102	R291B958G33
6	0	T T T T T T . . . . .	473	R9676A65G01
6	0	T Y O . . . . O Y T	597	R9688A40G01
6	0	W W . . . P P . . W W	573	R9688A04G01
6	0	Y Y Y Y . . . . . Y Y	916	R9669A31G01
6	0	Z Z T T T T . . . . .	A57	R991AA57G01
6	0	Z Z Z P P . . . . . P	782	R9666A39G01
4	2	P . . . . P P C-C P	009	R129A509G01

Switch Selection Guide - Sorted by Configuration

\*P=potential, \*C=current

*P	*C	CONFIGURATION	CODE	STYLE
4	2	P P P P R-R . . . .	289	R9667A02G01
4	2	T T . . . P P . C-C	327	R9672A03G01
3	3	P P . . . . C C C P	351	R291B958G24
3	3	P P . . . . C C-C P	039	R129A543G01
3	3	P P P . . . C C C .	456	R9676A19G01
2	4	. . . C-C C-C P P .	099	R291B958G30
2	4	P . . . . C-C C-C P	034	R129A537G01
2	4	P . . . . P C-C C-C	100	R291B958G31
2	4	P . . C C C C . . P	353	R291B958G27
0	6	. . . . C-C C-C C-C	426	R9672A72G01
0	6	. . . . R-R 7-7 8-8	600	R9688A43G01
0	6	. . . . R-R 8-8 7-7	595	R9688A30G01
0	6	. . . 8-8 8-8 8-8 .	742	R9689A78G01
0	6	. . . C C C C C C .	054	R188A454G01
0	6	. . . C-A C-A C-A .	352	R291B958G26
0	6	. . . C-A C-A C-C .	098	R291B958G29
0	6	. . . C-B C-B C-B .	369	R498A017G01
0	6	. . . C-C C-C C-C .	016	R129A516G01
0	6	. . . R-R R-R R-R .	270	R291B958G28
0	6	. . C C C C C C . .	022	R129A523G01
0	6	. . C-C C-C C-C . .	991	R991A991G01
0	6	. 6-6 . 7-7 . 9-9 .	821	R9666A83G01
0	6	. C-C . C-C . C-C .	069	R498A014G01
0	6	. C-C C-C C-C . . .	556	R9683A76G01
0	6	C . C . C . . C C C	052	R188A304G01
0	6	C C C C C C . . . .	952	R991A952G01
0	6	C-C . . C-C . . C-C	694	R9689A23G01
0	6	C-C . C-C . C-C . .	A53	R991AA53G01
0	6	C-C C-C C-C . . . .	273	R9660A97G01
7 Pole		A B C D E F G H I J		
7	0	. . . T T T T T T T	672	R9688A99G01
7	0	. P P P P P P P . .	025	R129A526G01
7	0	P . . P P P . P P P	003	R129A503G01
7	0	P . . P P P P P . P	104	R291B959G19
7	0	P P P . . . P P P P	043	R129A547G01
7	0	P P P . . . P P P P	106	R291B959G30
7	0	P P P P . . P P P .	068	R498A013G01
7	0	P P P P P P . . . T	286	R9663A79G01
7	0	P P P P P P P . . .	357	R291B959G28
7	0	T . . P P P . P P T	413	R763A168G01
7	0	T T P . . . P P P P	109	R291B959G33
5	2	P C-C P . . . P P P	051	R188A261G01
5	2	P P . . . C-C P P P	010	R129A510G01
5	2	P P P P P . . . C-C	356	R291B959G27
5	2	P P P P P . . C-C .	103	R291B959G18
5	2	T P . . . P P C-C T	341	R188A622G01
5	2	T T . . . R-R T T T	292	R9667A17G01
4	3	P P C . C . C . P P	055	R188A477G01
3	4	P C C . C . C . P P	057	R188A618G01
3	4	P C-C . P . C-C . P	657	R9688A83G01

*P	*C	CONFIGURATION	CODE	STYLE
3	4	P P . . . C-C C-C P	011	R129A511G01
3	4	P P P . . C-C C-C .	063	R498A008G01
3	4	T C-C T C-C T . . .	355	R291B959G26
3	4	T T T . . . C C C C	108	R291B959G32
3	4	T T T . . C-C C-C .	354	R291B959G20
3	4	T T T . C-C . . C-C	481	R9676A79G01
2	5	C-C-C-C-C T T . . .	858	R9682A43G01
1	6	. . . C-C C-C C-C T	368	R498A003G01
1	6	C-C C-C C-C . . . T	284	R9663A77G01
1	6	P C-C C-B C-B . . .	332	R129A540G01
1	6	T . . . R-R 8-8 7-7	936	R991A936G01
0	7	. . C C-C C-C C-C .	105	R291B959G29
0	7	C-C C-C C-C C . . .	459	R9676A24G01
8 Pole		A B C D E F G H I J		
8	0	. P P P P P P P P .	187	R291B960G37
8	0	O O O O O O O . .	755	R9689A95G01
8	0	P . . P P P P P P P	045	R129A549G01
8	0	P P . P P . P P P P	693	R9689A22G01
8	0	P P P . . P P P P P	406	R719B591G09
8	0	P P P . P P . P P P	112	R291B960G39
8	0	P P P P . . P P P P	002	R129A502G01
8	0	P P P P . . P P P T	331	R129A536G01
8	0	P P P P P . . P P P	042	R129A546G01
8	0	P P P P P . . P T T	160	R719B591G14
8	0	P P P P P P . . T T	557	R9683A80G01
8	0	P P P P P P P P . .	407	R719B591G10
8	0	T T . . Z Z Z Z Z Z	753	R9689A90G01
8	0	T T T . T . O O G G	740	R9689A76G01
8	0	T T T T . . T T T T	507	R9683A10G01
8	0	T T T T T . . T T T	158	R719B591G12
8	0	T T T T T T . . T T	937	R991A937G01
6	2	O O C-C . . Z Z Z Z	552	R9683A71G01
6	2	P P P . . C-C P P P	110	R291B960G26
6	2	P P P P P . . C-C P	058	R188A632G01
6	2	P P P P P P . . C-C	111	R291B960G36
6	2	T . . P P P P C-C T	412	R763A167G01
6	2	W W W W W W . . C-C	687	R9689A16G01
4	4	. . P P P C-C C-C P	080	R629A315G01
4	4	C-C C-C . . P P P P	159	R719B591G13
4	4	C-C C-C . P P P P .	408	R719B591G11
4	4	C-C-C-C W W W W . .	917	R9669A32G01
4	4	P C-C P . . P C-C P	012	R129A512G01
4	4	P P . C C C C . P P	071	R498A016G01
4	4	P P . C-C C-C . P P	028	R129A530G01
4	4	P P P P . C-C C-C .	040	R129A544G01
3	5	T P . . . C C-C C-C T	359	R291B960G27
2	6	. C C C C C C . P P	293	R9667A21G01
2	6	. C-C C-C C-C . P P	021	R129A521G01
2	6	. C-C C-C C-C . T T	515	R9683A22G01
2	6	. C-C C-C C-C P P .	024	R129A525G01

Switch Selection Guide - Sorted by Configuration

\*P=potential, \*C=current

*P	*C	CONFIGURATION	CODE	STYLE
2	6	C-B C-B C-B . . P P	361	R291B960G38
2	6	C-C C-C C-C . . T T	938	R991A938G01
2	6	T . C-C C-C C-C . T	990	R991A990G01
2	6	T T . . C-C C-C C-C	305	R9668A69G01
2	6	Z Z . . C-C C-C C-C	641	R9688A65G01
1	7	C . . C-B C-B C-B P	370	R498A018G01
1	7	P . C C-C C-C C-C .	072	R498A019G01
0	8	. . C-C C-C C-C C-C	A37	R991AA37G01
0	8	. C C C C C C C C .	062	R498A004G01
0	8	. C-C C-C C-C C-C .	017	R129A517G01
0	8	. C-C-C-B . C-C-C-B	375	R498A029G01
0	8	. C-C-C-B C-C-C-B .	358	R291B960G20
0	8	. C-C-C-C C-C-C-C .	360	R291B960G33
0	8	. R-R R-R R-R R-R .	266	R9660A84G01
0	8	5-5 . . R-R 7-7 8-8	599	R9688A42G01
0	8	5-5-5-A . . 5-5-5-A	697	R9689A27G01
0	8	6-6 R-R 5-5 . . 8-8	817	R9666A78G01
0	8	C C C C . . C C C C	050	R188A229G01
0	8	C C C C C-C-C-C . .	A04	R991AA04G01
0	8	C-C . . C-C C-C C-C	328	R9672A10G01
0	8	C-C C-C C-C . . C-C	278	R1586C41G01
0	8	C-C C-C C-C C-C . .	691	R9689A20G01
0	8	C-C-C-A . . C-C-C-A	563	R9683A93G01
0	8	C-C-C-A C-C-C-B . .	419	R837A099G01
0	8	C-C-C-B . . C-C-C-B	373	R498A025G01
0	8	C-C-C-C . . C-C-C-C	823	R9666A85G01
0	8	C-C-C-C C-C-C-B . .	418	R837A098G01
0	8	D D D C-C-C-C-S . .	644	R9688A70G01
9 Pole		A B C D E F G H I J		
9	0	P P . P P P P P P P	044	R129A548G01
9	0	P P P P . P P P P P	047	R129A551G01
9	0	P P P P . T T T T T	859	R9682A44G01
9	0	P P P P P P P P P .	692	R9689A21G01
9	0	T T T T T T T T . O T	940	R991A940G01
9	0	T T T T T T T T . T	602	R9688A45G01
6	3	P P P C C C P P P .	113	R291B961G23
6	3	P P P P P . C C C P	116	R291B961G30
6	3	P P P P P . C C-C P	333	R129A552G01
6	3	P P P P P . C-C C P	081	R629A483G01
5	4	P P P P . C-C C-C P	059	R188A633G01
5	4	P P P P P . C-C C-C	362	R291B961G22
5	4	P P P P P C C C C .	365	R291B961G28
5	4	P P P P P C-C C-C .	041	R129A545G01
4	5	P P P P . C C-C-C-B	374	R498A028G01
4	5	P P P P . C-C-C-C-E	681	R9689A10G01
3	6	. T C-C T C-C T C-C	277	R9663A34G01
3	6	P C-C P C-C P C-C .	423	R861A551G01
3	6	P P . C-C C-C C-C P	015	R129A515G01
3	6	P P P . C-C C-C-C-B	372	R498A024G01
3	6	P P P C-C C-C . C C	364	R291B961G27

*P	*C	CONFIGURATION	CODE	STYLE
3	6	P P P C-C C-C C-C .	366	R291B961G29
3	6	T T . C-C C-C C-C T	283	R9663A74G01
3	6	T T O . R-R 8-8 7-7	718	R9689A56G01
3	6	T T T . R-R 8-8 7-7	719	R9689A57G01
2	7	P P . C-B C-B C-B S	115	R291B961G26
1	8	. C-C C-C C-C C-C T	064	R498A009G01
1	8	T . C-C C-C C-C C-C	306	R9668A70G01
0	9	. C C-B C C-B C C-B	371	R498A023G01
0	9	C C-C C-C C-C C-C .	074	R498A021G01
0	9	C-C C-C C-C C . C-C	460	R9676A25G01
10 Pole		A B C D E F G H I J		
10	0	G G G G G G G G G G	613	R9688A58G01
10	0	G G G G G G G G Y Y	730	R9689A62G01
10	0	G G G G G G T G T T	705	R9689A37G01
10	0	G G G G G G T T T T	612	R9688A57G01
10	0	G G G G G O O O O O	813	R9666A73G01
10	0	G G G G G Y Y Y Y Y	592	R9688A26G01
10	0	G G G G G Z Z Z Z Z	560	R9683A88G01
10	0	G G G G P P T T T T	611	R9688A56G01
10	0	G G G G Y Y Y T T T	623	R991A623G01
10	0	G G G G Y Y Y Y Y Y	550	R9683A69G01
10	0	G G T T T T T T T Y	961	R991A961G01
10	0	G G Y Y Y Y Y Y Y Y	892	R9682A77G01
10	0	G O O O O O O O O O	874	R9682A57G01
10	0	G P P P P P P P P P	A45	R991AA45G01
10	0	G T T G T T T T T T	732	R9689A65G01
10	0	G T T T T T T T G T	857	R9682A42G01
10	0	G T T T T T T T T T	727	R9689A59G01
10	0	G T T T T T T T T Y	962	R991A962G01
10	0	G Y T T T T G T T T	757	R9689A99G01
10	0	O G O P P P P P P P	580	R9688A13G01
10	0	O O O O O O O O O O	440	R9672A97G01
10	0	O O O O O Y Y Y Y Y	575	R9688A08G01
10	0	O O O O O Z Z Z Z Z	801	R9666A58G01
10	0	O O T T T T P P P P	549	R9683A61G01
10	0	O W Z Z G W Y Y W W	511	R9683A18G01
10	0	P O Y Z W G V H T P	A05	R991AA05G01
10	0	P P G Y T T T T G G	922	R9669A37G01
10	0	P P P P G T P P P P	A18	R991AA18G01
10	0	P P P P G T T P P P	793	R9666A50G01
10	0	P P P P G T T T P P	792	R9666A49G01
10	0	P P P P G T T T T G	A28	R991AA28G01
10	0	P P P P O O O O O O	805	R9666A62G01
10	0	P P P P P O O T T T	664	R9688A90G01
10	0	P P P P P P P P G T	A19	R991AA19G01
10	0	P P P P P P P P P O	621	R991A621G01
10	0	P P P P P P P P P P	001	R129A501G01
10	0	P P P P P P P P P T	170	R774B430G19
10	0	P P P P P P P P P W	930	R991A930G01
10	0	P P P P P P P P T P	488	R9676A88G01

Switch Selection Guide - Sorted by Configuration

\*P=potential, \*C=current

*P	*C	CONFIGURATION	CODE	STYLE
10	0	P P P P P P P P T T	212	R1586C42G23
10	0	P P P P P P P P Z Z	323	R9671A94G01
10	0	P P P P P P P T T P	430	R9672A77G01
10	0	P P P P P P P T T T	214	R1586C42G25
10	0	P P P P P P P W P P	898	R9682A83G01
10	0	P P P P P P T P P P	245	R1586C42G29
10	0	P P P P P P T P P T	448	R9676A08G01
10	0	P P P P P P T P T P	429	R9672A75G01
10	0	P P P P P P T P T T	246	R1586C42G30
10	0	P P P P P P T T T P	441	R9672A98G01
10	0	P P P P P P T T T T	330	R9672A71G01
10	0	P P P P P P W W P P	A31	R991AA31G01
10	0	P P P P P P W W W W	A32	R991AA32G01
10	0	P P P P P P Z Z G T	614	R9688A59G01
10	0	P P P P P P Z Z O O	979	R991A979G01
10	0	P P P P P P Z Z Z Z	324	R9671A95G01
10	0	P P P P P T P T P T	496	R9676A97G01
10	0	P P P P P T T T T T	213	R1586C42G24
10	0	P P P P P T T T T T	380	R670B197G21
10	0	P P P P T G T G P P	931	R991A931G01
10	0	P P P P T P P P P P	583	R9688A16G01
10	0	P P P P T P P P P T	670	R9688A96G01
10	0	P P P P T P P T P P	291	R9667A06G01
10	0	P P P P T P T P T P	886	R9682A71G01
10	0	P P P P T P T T T T	244	R1586C42G28
10	0	P P P P T T P P P P	669	R9688A95G01
10	0	P P P P T T T P P P	452	R9676A14G01
10	0	P P P P T T T T P P	594	R9688A28G01
10	0	P P P P T T T T T P	582	R9688A15G01
10	0	P P P P T T T T T T	185	R670B197G26
10	0	P P P P T T Y Y Z Z	A50	R991AA50G01
10	0	P P P P T T Z Z Z Z	A07	R991AA07G01
10	0	P P P P W W T T T T	565	R9683A95G01
10	0	P P P P Z Z O O Y Y	977	R991A977G01
10	0	P P P P Z Z Y Y Y Y	973	R991A973G01
10	0	P P P T P P P P P P	743	R9689A79G01
10	0	P P P T T P P T T T	804	R9666A61G01
10	0	P P P T T T T T T P	428	R9672A74G01
10	0	P P P T T T T T T T	701	R9689A32G01
10	0	P P T P P P P P P P	490	R9676A90G01
10	0	P P T P P P P P P T	A06	R991AA06G01
10	0	P P T P T P P P P P	242	R1586C42G15
10	0	P P T T P P P P O O	860	R9682A45G01
10	0	P P T T P P P P P P	819	R9666A80G01
10	0	P P T T P T T P P P	A10	R991AA10G01
10	0	P P T T P T T T P P	999	R991A999G01
10	0	P P T T T P P T T T	756	R9689A97G01
10	0	P P T T T T P P P P	224	R991A224G01
10	0	P P T T T T P P T T	870	R9652A29G01
10	0	P P T T T T T P P P	776	R9664A98G01

*P	*C	CONFIGURATION	CODE	STYLE
10	0	P P T T T T T T P P	775	R9664A97G01
10	0	P P T T T T T T T T	123	R670B197G24
10	0	P P W W P P P Y Y	919	R9669A34G01
10	0	P P Y Y Y Y W W W W	891	R9682A76G01
10	0	P T P P P P P P T	587	R9688A20G01
10	0	P T P P P P P P T T	586	R9688A19G01
10	0	P T P P T P P T P P	301	R9668A27G01
10	0	P T P P T T P P T P	290	R9667A03G01
10	0	P T P T P P T P T P	311	R9670A98G01
10	0	P T T P P P P P P P	320	R9671A69G01
10	0	P T T P P P P T T T	585	R9688A18G01
10	0	P T T T P P T T P P	468	R9676A53G01
10	0	P T T T T T T T T T	584	R9688A17G01
10	0	P T W Z P P T W Z P	567	R9683A97G01
10	0	P W T G O Z T T T T	658	R9688A84G01
10	0	P Y P P P P P P P P	229	R991A229G01
10	0	P Y P P P P T T P P	996	R991A996G01
10	0	P Y P P T T P P P P	A11	R991AA11G01
10	0	P Y P Y P P Z Z T T	225	R991A225G01
10	0	P Y T T P T T P P P	998	R991A998G01
10	0	P Y T T P T T T P P	A09	R991AA09G01
10	0	P Y T T T T P P P P	223	R991A223G01
10	0	P Y T T T T T T P P	228	R991A228G01
10	0	T G T T T Y Y G G G	A44	R991AA44G01
10	0	T G T Z Z Z Z Z Z Z	579	R9688A12G01
10	0	T O Y T Z O O T Y T	601	R9688A44G01
10	0	T P P P P P P P P P	247	R1586C42G31
10	0	T P P P P P P P P T	181	R670B197G36
10	0	T P P P P P P P P W	770	R9664A92G01
10	0	T P P P P P P P T T	875	R9682A59G01
10	0	T P P P P T P P P P	300	R9667A93G01
10	0	T P P P P T T T T P	887	R9682A72G01
10	0	T P P T P P P P P P	309	R9670A35G01
10	0	T P P T P P P P T T	888	R9682A73G01
10	0	T P P T P P T P P P	308	R9670A34G01
10	0	T P P T P P T P P T	310	R9670A97G01
10	0	T P T P P P P P P P	317	R1586C42G06
10	0	T P T P P P P P T T	894	R9682A79G01
10	0	T P T P P P P T P T	263	R1586C42G46
10	0	T P T P T P P P P P	487	R9676A87G01
10	0	T P T P T P T P P P	489	R9676A89G01
10	0	T P T P T P T P T P	304	R9668A54G01
10	0	T P T T T P T P T P	463	R9676A34G01
10	0	T T G G G G G G G G	713	R9689A49G01
10	0	T T G G G G T T T T	714	R9689A50G01
10	0	T T G O T T T T T T	856	R9682A41G01
10	0	T T G T T T T T T T	476	R9676A72G01
10	0	T T O O Y Y T T G G	577	R9688A10G01
10	0	T T P P P P P P P P	262	R1586C42G45
10	0	T T P P P P P P P T	297	R9667A78G01

Switch Selection Guide - Sorted by Configuration

\*P=potential, \*C=current

*P	*C	CONFIGURATION	CODE	STYLE
10	0	T T P P P P P P W	814	R991A814G01
10	0	T T P P P P P P T P	885	R9682A70G01
10	0	T T P P P P P P T T	258	R1586C42G41
10	0	T T P P P P P T P	A17	R991AA17G01
10	0	T T P P P P T T P P	269	R9660A92G01
10	0	T T P P P P T T T T	220	R991A220G01
10	0	T T P P P T T P P P	319	R9671A68G01
10	0	T T P P T P P P P P	836	R9666A93G01
10	0	T T P P T T P P T T	299	R9667A86G01
10	0	T T P P T T P T P	221	R991A221G01
10	0	T T T G G T P P Z Z	735	R9689A70G01
10	0	T T T G T T T T T T	A54	R991AA54G01
10	0	T T T G Y Z Y O O Y	795	R9666A52G01
10	0	T T T O O O O O O O	788	R9666A45G01
10	0	T T T O O O O O O O	850	R9682A35G01
10	0	T T T O T T T T T T	A52	R991AA52G01
10	0	T T T P P P P P P P	485	R9676A84G01
10	0	T T T P P P P T T T	274	R9663A25G01
10	0	T T T P P P T T P P	222	R991A222G01
10	0	T T T P P P W P P T	929	R991A929G01
10	0	T T T P T T P T P	230	R991A230G01
10	0	T T T P Y Y Y P O P	853	R9682A38G01
10	0	T T T T O O O O O O	878	R9682A62G01
10	0	T T T T P P P P P P	127	R670B197G31
10	0	T T T T P P P P P W	A01	R991AA01G01
10	0	T T T T P P P P T T	876	R9682A60G01
10	0	T T T T P P T T T T	700	R9689A31G01
10	0	T T T T P P W P P P	302	R991A302G01
10	0	T T T T T P P P P P	315	R9671A13G01
10	0	T T T T T T G G O O	848	R9682A31G01
10	0	T T T T T T P P P P	140	R716B562G10
10	0	T T T T T T P P T P	808	R9666A65G01
10	0	T T T T T T P P Z Z	734	R9689A69G01
10	0	T T T T T T T O T T	728	R9689A60G01
10	0	T T T T T T T P P P	815	R9666A76G01
10	0	T T T T T T T T O O	881	R9682A66G01
10	0	T T T T T T T T P P	261	R1586C42G44
10	0	T T T T T T T T T G	963	R991A963G01
10	0	T T T T T T T T T P	786	R9666A43G01
10	0	T T T T T T T T T T	036	R129A539G01
10	0	T T T T T T T T T W	847	R9682A30G01
10	0	T T T T T T T T T Y	A51	R991AA51G01
10	0	T T T T T T T T W W	882	R9682A67G01
10	0	T T T T T T T W W W	849	R9682A32G01
10	0	T T T T T T T Y Y Y	976	R991A976G01
10	0	T T T T T T V V V V	905	R9682A90G01
10	0	T T T T T T W T T T	966	R991A966G01
10	0	T T T T T T W W T Y	964	R991A964G01
10	0	T T T T T T Y Y Y Y	501	R9683A03G01
10	0	T T T T T T Y Y Z Z	978	R991A978G01

*P	*C	CONFIGURATION	CODE	STYLE
10	0	T T T T T T Z Z O O	911	R9682A96G01
10	0	T T T T T T Z Z Z Z	326	R9672A02G01
10	0	T T T T T Y Y Y Y Y	981	R991A981G01
10	0	T T T T T Z Z Z Z T	954	R991A954G01
10	0	T T T T T Z Z Z Z Z	504	R9683A06G01
10	0	T T T T W W W W W W	914	R9682A99G01
10	0	T T T T Y Y W W T P	984	R991A984G01
10	0	T T T T Y Y Y Y Y Y	980	R991A980G01
10	0	T T T T Z T T T T T	759	R9664A79G01
10	0	T T T T Z Z Z G G G	729	R9689A61G01
10	0	T T T T Z Z Z Z Z Z	667	R9688A93G01
10	0	T T T Y Y P P P P P	478	R9676A74G01
10	0	T T T Z Z T T T T T	758	R9664A78G01
10	0	T T W W T T T T T T	A16	R991AA16G01
10	0	T T Y Y P P P P P P	477	R9676A73G01
10	0	T T Y Y Z Z Z Z T P	679	R9689A08G01
10	0	T T Z Z P P T G O G	768	R9664A88G01
10	0	T T Z Z T T T T T T	846	R9682A29G01
10	0	T T Z Z T T T T T T	852	R9682A37G01
10	0	T T Z Z Z Z O O O O	968	R991A968G01
10	0	T T Z Z Z Z Z Z Z Z	833	R9652A26G01
10	0	T W P P P P P P P P	790	R9666A47G01
10	0	T W P W T T W P W T	303	R991A303G01
10	0	T W W W W P P P P P	867	R9682A52G01
10	0	T Y Z O P P P P P P	A25	R991AA25G01
10	0	T Y Z O T T T T T T	A03	R991AA03G01
10	0	T Y Z P P P P P O O	779	R9666A36G01
10	0	T Y Z T Y Z T Y Z P	707	R9689A40G01
10	0	T Y Z W G G G G G G	704	R9689A36G01
10	0	T Y Z W G G G G G P	609	R9688A54G01
10	0	T Y Z W P P P G G G	607	R9688A52G01
10	0	T Y Z W P P P P P P	608	R9688A53G01
10	0	T Y Z W T Y Z W P P	617	R9666A13G01
10	0	T Z P O T G W P O G	764	R9664A84G01
10	0	V T V T T T T T T T	965	R991A965G01
10	0	V V V V V O O O O O	A30	R991AA30G01
10	0	V V V V V P P P P P	A26	R991AA26G01
10	0	W W O O Y Y Z Z Y W	634	R9647A22G01
10	0	W W P P G G P P P P	918	R9669A33G01
10	0	W W P P P P P P P P	232	R991A232G01
10	0	W W T T T G P P P P	633	R9647A21G01
10	0	W W T T Y Z Y O O P	796	R9666A53G01
10	0	W W T T Y Z Y O O Y	637	R9649A37G01
10	0	W W W T T T T T T T	619	R9641A64G01
10	0	W W W W W W W W T	620	R9646A77G01
10	0	W W W W W W W W W	492	R9676A93G01
10	0	W W W W W Y Y Y Y Y	731	R9689A63G01
10	0	W W W W Y Y Y Y G G	642	R9688A66G01
10	0	W W W W Y Y Y Y Y Y	A14	R991AA14G01
10	0	W W Y Y Y Y Y Y Y Y	972	R991A972G01

Switch Selection Guide - Sorted by Configuration

\*P=potential, \*C=current

*P	*C	CONFIGURATION	CODE	STYLE
10	0	W Y Z Z Y Y G T T T	510	R9683A17G01
10	0	W Y Z Z Y Y O W W W	512	R9683A19G01
10	0	Y G V Z P P P P P P	987	R991A987G01
10	0	Y G Y G Y Y Y W W W	581	R9688A14G01
10	0	Y O V T G Z H W T P	A56	R991AA56G01
10	0	Y T G W Z W T T T P	818	R9666A79G01
10	0	Y Y G G Y Y G G G G	956	R991A956G01
10	0	Y Y T T T T T T T T	825	R9666A87G01
10	0	Y Y W W W W W W W W	656	R9688A82G01
10	0	Y Y W W W W Y Y Y Y	647	R9688A73G01
10	0	Y Y W W Y Y W Y Y Y	646	R9688A72G01
10	0	Y Y Y Y G Y Y Y Y G	957	R991A957G01
10	0	Y Y Y Y T T T T T T	824	R9666A86G01
10	0	Y Y Y Y W W W W T T	926	R9669A41G01
10	0	Y Y Y Y W W W W W W	645	R9688A71G01
10	0	Y Y Y Y W W Y Y Y Y	712	R9689A47G01
10	0	Y Y Y Y Y T T T T T	576	R9688A09G01
10	0	Y Y Y Y Y W W W W W	655	R9688A81G01
10	0	Y Y Y Y Y Y P P P P	923	R9669A38G01
10	0	Y Y Y Y Y Y T T P P	861	R9682A46G01
10	0	Y Y Y Y Y Y W W W W	652	R9688A78G01
10	0	Y Y Y Y Y Y W W Y Y	654	R9688A80G01
10	0	Y Y Y Y Y Y Y T T T	684	R9689A13G01
10	0	Y Y Y Y Y Y Y Y G G	590	R9688A24G01
10	0	Y Y Y Y Y Y Y Y T T	828	R9666A90G01
10	0	Y Y Y Y Y Y Y Y W W	651	R9688A77G01
10	0	Y Y Y Y Y Y Y Y Y Y	499	R9683A01G01
10	0	Y Y Z Z Z Z Z Z T P	680	R9689A09G01
10	0	Z Z G G G G G G G G	816	R9666A77G01
10	0	Z Z G G G G G G W W	555	R9683A75G01
10	0	Z Z G G G G W W W W	A15	R991AA15G01
10	0	Z Z G G G G W W W Y	551	R9683A70G01
10	0	Z Z G G W W W W W W	589	R9688A23G01
10	0	Z Z G G W W Y Y Y Y	834	R9652A27G01
10	0	Z Z G G W Y Y Y W W	648	R9688A74G01
10	0	Z Z G G Y Y Y Y W W	955	R991A955G01
10	0	Z Z O O Y Y Y Y Y Y	974	R991A974G01
10	0	Z Z P P P P P P P P	880	R9682A65G01
10	0	Z Z P P W W P P P P	943	R991A943G01
10	0	Z Z T T T T T T T T	953	R991A953G01
10	0	Z Z W W W W W W W W	650	R9688A76G01
10	0	Z Z W W W W W W Y Y	500	R9683A02G01
10	0	Z Z Y Y Y Y W W W W	831	R9666A92G01
10	0	Z Z Y Y Y Y Y W W W	971	R991A971G01
10	0	Z Z Y Y Y Y Y Y G W	279	R9663A41G01
10	0	Z Z Y Y Y Y Y Y W W	893	R9682A78G01
10	0	Z Z Y Y Y Y Y Y Y Y	975	R991A975G01
10	0	Z Z Z O O O O O O O	663	R9688A89G01
10	0	Z Z Z P P P P P P P	904	R9682A89G01
10	0	Z Z Z T T T T T T Z	227	R991A227G01

*P	*C	CONFIGURATION	CODE	STYLE
10	0	Z Z Z Z O O O O O O	662	R9688A88G01
10	0	Z Z Z Z P P P P P P	879	R9682A64G01
10	0	Z Z Z Z T T T T T T	924	R9669A39G01
10	0	Z Z Z Z Z O O O O O	686	R9689A15G01
10	0	Z Z Z Z Z Z O O O O	666	R9688A92G01
10	0	Z Z Z Z Z Z T T T T	830	R9682A19G01
10	0	Z Z Z Z Z Z Z Z O O	754	R9689A91G01
10	0	Z Z Z Z Z Z Z Z P P	483	R9676A81G01
10	0	Z Z Z Z Z Z Z Z W W	491	R9676A91G01
10	0	Z Z Z Z Z Z Z Z Z Z	493	R9676A94G01
9	1	C P P P P P P P P P	066	R498A011G01
9	1	C T T T T T T T T T	255	R1586C42G39
9	1	O Y C W G P P T T T	631	R9647A19G01
8	2	C-A P P P P P P P P	395	R714B325G31
8	2	C-A T T T T T T T T	895	R9682A80G01
8	2	C-C P P P P P P P P	202	R837A665G01
8	2	C-C P P P P T T T T	628	R9647A12G01
8	2	C-C P P T T T T T T	627	R9647A11G01
8	2	C-C T T P P P P P P	486	R9676A86G01
8	2	C-C T T P P T T P P	574	R9688A07G01
8	2	C-C T T T T P P P P	636	R9647A98G01
8	2	C-C T T T T T T P P	553	R9683A72G01
8	2	C-C T T T T T T T T	209	R1586C42G20
8	2	C-C Y Y Y Y Y Y Y Y	A13	R991AA13G01
8	2	C-C Z Z Z Z Z Z Z Z	944	R991A944G01
8	2	O Y Z W G C-C T V H	934	R991A934G01
8	2	P C C P P P T P P P	248	R1586C42G32
8	2	P P C-C P P P P P P	178	R670B197G33
8	2	P P P C-C P P P P P	403	R716B562G21
8	2	P P P P P C-C P P P	736	R9689A72G01
8	2	P P P P P P 8-8 Z Z	726	R9666A28G01
8	2	P P P P P P C-C P P	282	R9663A60G01
8	2	P P P P P P P C-B P	820	R9666A82G01
8	2	P P P P P P P C-C P	038	R129A542G01
8	2	P P P P P P P C-C T	254	R1586C42G38
8	2	P P P P P P P P C-A	136	R714B325G30
8	2	P P P P P P P P C-C	145	R716B562G26
8	2	P P P P P P P P C-E	842	R9682A25G01
8	2	P P P P P P P R-R P	453	R9676A15G01
8	2	P P P P P T T T C-C	241	R991A241G01
8	2	P P P P T T P C-C P	152	R716B562G35
8	2	P P P R-R P P P P P	889	R9682A74G01
8	2	P P P T T T T C-C P	785	R9666A42G01
8	2	P P P T T T T T C-C	226	R991A226G01
8	2	P P R-B T P P P P P	967	R991A967G01
8	2	P P R-R T P P P P P	695	R9689A25G01
8	2	P P T T T T T T C-C	671	R9688A98G01
8	2	T P P P P P P C-C P	432	R9672A83G01
8	2	T P P P P P P C-C T	215	R1586C42G26
8	2	T P T P T T T 6-6 P	949	R991A949G01

Switch Selection Guide - Sorted by Configuration

\*P=potential, \*C=current

*P	*C	CONFIGURATION	CODE	STYLE
8	2	T T C-C P G Y W Z O	444	R9676A04G01
8	2	T T R-A T T T T T T	750	R9689A87G01
8	2	T T R-R T T T T T T	933	R991A933G01
8	2	T T T C-C P P P P P	811	R9666A69G01
8	2	T T T P T T T 6-6 P	950	R991A950G01
8	2	T T T S T S O O G G	751	R9689A88G01
8	2	T T T T C-A T T T T	960	R991A960G01
8	2	T T T T C-C T T T T	249	R1586C42G33
8	2	T T T T T T 5-5 P P	900	R9682A85G01
8	2	T T T T T T C-A T T	615	R9688A62G01
8	2	T T T T T T R-R T T	777	R9666A34G01
8	2	T T T T T T T C-C T	264	R1586C42G47
8	2	T T T T T T T R-A T	839	R9666A96G01
8	2	T T T T T T T R-E T	983	R991A983G01
8	2	T T T T T T T R-R T	118	R670B197G17
8	2	T T T T T T T T C-C	436	R9672A89G01
8	2	Z Z T T P P P 6-6 P	947	R991A947G01
8	2	Z Z Z Z Z T T T 7-A	992	R991A992G01
7	3	P P P P P P C C-C P	048	R129A553G01
6	4	6-6 7-7 G Y Z W O W	725	R9666A27G01
6	4	C C P P P P P P C C	402	R716B562G20
6	4	C-5-3-9 P P P P P P	A02	R991AA02G01
6	4	C-A C-A P P P P P P	392	R714B325G27
6	4	C-C C-C P P P P P O	622	R991A622G01
6	4	C-C C-C P P P P P P	070	R498A015G01
6	4	C-C C-C P P P P P T	192	R1586C42G13
6	4	C-C C-C P P P P T T	431	R9672A80G01
6	4	C-C C-C P P P T T T	218	R991A218G01
6	4	C-C C-C P P T T T T	446	R9676A06G01
6	4	C-C C-C T T P P P P	334	R991A334G01
6	4	C-C C-C T T T T T T	275	R9663A31G01
6	4	C-C P P C-C P P P P	400	R716B562G17
6	4	C-C P P P P C-C P P	143	R716B562G19
6	4	C-C P P P P P P C-C	087	R877A077G01
6	4	C-C T T T C-C T T T	840	R9666A97G01
6	4	C-C-C-A T T T T T T	564	R9683A94G01
6	4	C-C-C-C P P P P P P	A23	R991AA23G01
6	4	C-C-C-C P P P P P T	190	R1586C42G11
6	4	C-C-C-C P P P P T T	191	R1586C42G12
6	4	C-C-C-C T T T T T T	442	R9672A99G01
6	4	C-C-C-C W W W T T T	706	R9689A38G01
6	4	C-C-C-E T T T T T T	434	R9672A87G01
6	4	O O O O O O C-C C-C	969	R991A969G01
6	4	O O P P P P R-6-7-C	780	R9666A37G01
6	4	P C-C C-C P P P P P	256	R716B562G36
6	4	P C-C C-C T T T T T	851	R9682A36G01
6	4	P C-C P P P P C-C P	013	R129A513G01
6	4	P C-C P P P P C-C T	378	R629A735G01
6	4	P C-C P P P T C-C P	211	R1586C42G22
6	4	P C-C P P T T C-C T	217	R1586C42G27

*P	*C	CONFIGURATION	CODE	STYLE
6	4	P C-C-C-C P P P P P	416	R836A867G01
6	4	P P C P C P C P C P	506	R991A506G01
6	4	P P C-A C-A P P P P	393	R714B325G28
6	4	P P C-C P P C-C P P	142	R716B562G15
6	4	P P P C-C C-C P P P	745	R9689A81G01
6	4	P P P C-C C-C T T T	871	R9652A30G01
6	4	P P P C-C P P C-C P	020	R129A520G01
6	4	P P P C-C-C-C P P P	335	R991A335G01
6	4	P P P P C C C C P P	673	R9689A01G01
6	4	P P P P C-A C-A P P	394	R714B325G29
6	4	P P P P C-C C-C P P	379	R670B197G19
6	4	P P P P C-C P P C-C	179	R670B197G34
6	4	P P P P P C-C C-C P	030	R129A532G01
6	4	P P P P P P C-A C-A	132	R714B325G16
6	4	P P P P P P C-C-C-A	134	R714B325G18
6	4	P P P P P P C-C-C-C	126	R670B197G28
6	4	P P R-8-7-9 P P P P	A35	R991AA35G01
6	4	P P T P P P C-C C-C P	449	R9676A09G01
6	4	P P T P T P C-C-C-C	243	R1586C42G14
6	4	P T P R-C P P R-C P	475	R9676A71G01
6	4	R-A R-A T T T T T T	737	R9689A73G01
6	4	R-R R-R O O O O O O	913	R9682A98G01
6	4	R-R R-R T T T T T T	124	R670B197G25
6	4	T P C P C P C P C P	182	R670B197G37
6	4	T P P C-C P P C-C P	268	R9660A91G01
6	4	T P P C-C T P P C-C	445	R9676A05G01
6	4	T P P P P C-C C-C T	422	R849A307G01
6	4	T R-E T R-E T T T T	231	R991A231G01
6	4	T T C-C T T T T C-C	970	R991A970G01
6	4	T T R-A T T T R-A T	958	R991A958G01
6	4	T T T R-R T T R-R T	085	R861A670G01
6	4	T T T T T T C-C C-C	235	R991A235G01
6	4	T T T W W W C-C-C-C	A21	R991AA21G01
6	4	T Y Z T Y Z R-6-7-C	709	R9689A42G01
6	4	Z Z O O O O C-C C-C	689	R9689A18G01
5	5	P P C C-C P C-C P P	120	R670B197G20
5	5	T D D D D Y G V Z	989	R991A989G01
4	6	7-7 7-7 7-7 O O O O	A41	R991AA41G01
4	6	7-7 7-7 7-7 P P O O	863	R9682A48G01
4	6	7-7 7-7 7-7 T T T T	864	R9682A49G01
4	6	7-7 7-7 7-7 Y Y Y Y	865	R9682A50G01
4	6	8-8 8-8 8-8 W W W W	866	R9682A51G01
4	6	9-9 9-9 9-9 P P G G	A48	R991AA48G01
4	6	9-9 9-9 9-9 P P P P	928	R9669A43G01
4	6	9-9 9-9 9-9 T T T T	A49	R991AA49G01
4	6	9-9 9-9 9-9 W W W W	921	R9669A36G01
4	6	9-9 9-9 9-9 Y Y Y Y	A47	R991AA47G01
4	6	C C C C C P P P P P	169	R774B430G18
4	6	C C-C C-C C T T T T	210	R1586C42G21
4	6	C-C 5-5 R-R P P P P	829	R9666A91G01



Switch Selection Guide - Sorted by Configuration

\*P=potential, \*C=current

*P	*C	CONFIGURATION	CODE	STYLE
4	6	C-C C-C C-C G T T T	508	R9683A15G01
4	6	C-C C-C C-C O O W W	514	R9683A21G01
4	6	C-C C-C C-C O Y W W	513	R9683A20G01
4	6	C-C C-C C-C P P P P	171	R774B430G20
4	6	C-C C-C C-C P P P T	252	R1586C42G36
4	6	C-C C-C C-C P P T T	321	R9671A70G01
4	6	C-C C-C C-C T T P P	554	R9683A73G01
4	6	C-C C-C C-C T T T T	183	R774B430G24
4	6	C-C C-C C-C T T W W	238	R991A238G01
4	6	C-C C-C C-C Y Y Z Z	239	R991A239G01
4	6	C-C C-C C-C Z Z Y Y	803	R9666A60G01
4	6	C-C C-C C-C Z Z Z Z	997	R991A997G01
4	6	C-C P P C-C P P C-C	399	R716B562G16
4	6	C-C T P C-C-C-C P T	189	R1586C42G10
4	6	C-C-C-C C-C P P P P	161	R774B430G09
4	6	C-C-C-C C-C P P P T	A12	R991AA12G01
4	6	C-C-C-C C-C P T P T	497	R9676A98G01
4	6	C-C-C-D P L C-C T T	568	R9683A98G01
4	6	G G 9-9 9-9 9-9 P P	927	R9669A42G01
4	6	L L L L C-E C-E C-E	272	R9660A96G01
4	6	O G T W C-C C-C C-C	498	R9676A99G01
4	6	O O O O C-C C-C C-C	685	R9689A14G01
4	6	O Y Y O C-C C-C C-C	720	R9666A20G01
4	6	O Y Z 8-9 8-6 8-7 P	503	R9683A05G01
4	6	P C-A P C-A P C-A P	676	R9689A04G01
4	6	P C-C C-C C-C P P P	144	R716B562G37
4	6	P C-C C-C C-C P P P	162	R774B430G10
4	6	P C-C P C-C P C-C P	026	R129A528G01
4	6	P C-E P C-E P C-E P	A39	R991AA39G01
4	6	P G T C-C 5-5 R-R W	470	R9676A58G01
4	6	P P C C C C C C P P	172	R774B430G21
4	6	P P C C-C C-C C P P	385	R714B325G19
4	6	P P C-C P P C-C C-C	401	R716B562G18
4	6	P P P 6-6 6-6 6-6 P	771	R9664A93G01
4	6	P P P 6-6 6-6 6-6 T	946	R991A946G01
4	6	P P P C C C C C C P	307	R9670A05G01
4	6	P P P C-A C-A C-A P	588	R9688A22G01
4	6	P P P C-A P C-C-C-A	133	R714B325G17
4	6	P P P C-C C-C C-C P	014	R129A514G01
4	6	P P P C-C C-C C-C T	128	R670B197G32
4	6	P P P C-C C-C C-C Z	322	R9671A93G01
4	6	P P P C-C C-R C-R T	250	R1586C42G34
4	6	P P P C-C P C-C-C-C	125	R670B197G27
4	6	P P P C-D C-D C-D P	A33	R991AA33G01
4	6	P P P G R-R R-R R-R	570	R9688A01G01
4	6	P P P P C-A C-A C-A	390	R714B325G24
4	6	P P P P C-B C-B C-B	789	R9666A46G01
4	6	P P P P C-C C-C C-C	338	R1586C42G05
4	6	P P P P C-C C-C C-C	119	R670B197G18
4	6	P P P P C-C C-C C-C	253	R1586C42G37

*P	*C	CONFIGURATION	CODE	STYLE
4	6	P P P P P P C-C C-C	122	R670B197G23
4	6	P P P P R-R R-R R-R	267	R9660A85G01
4	6	P P P R-R R-R R-R P	288	R1586C42G03
4	6	P P P R-R R-R R-R W	596	R9688A38G01
4	6	P P P T C-C C-C C-C	A38	R991AA38G01
4	6	P P R-R 8-8 7-7 P P	A36	R991AA36G01
4	6	P P T C-C C-C C-C T	265	R1586C42G48
4	6	P R-R P R-R P R-R P	454	R9676A17G01
4	6	P T W Z S S S S S S	A27	R991AA27G01
4	6	P T Z C-7 8-7 7-C P	469	R9676A55G01
4	6	P T Z C-8 R-8 7-8 W	474	R9676A68G01
4	6	P T Z W 6-5 8-5 9-5	716	R9689A53G01
4	6	P Y Y P C-C C-C C-C	798	R9666A55G01
4	6	P Y Z R-R 6-6 7-6 P	806	R9666A63G01
4	6	P Y Z R-R 6-6 7-7 P	810	R9666A67G01
4	6	R P R P R P G 8-8-8	A29	R991AA29G01
4	6	R-B R-B R-B T T T T	386	R714B325G20
4	6	R-R 7-7 C-C G Y T P	769	R9664A89G01
4	6	R-R 7-7 C-C G Y W O	761	R9664A81G01
4	6	R-R 7-7 C-C T G O G	767	R9664A87G01
4	6	R-R 7-7 C-C T T T P	941	R991A941G01
4	6	R-R 7-7 C-C T Z P O	766	R9664A86G01
4	6	R-R 7-7 C-C W P O G	826	R9666A88G01
4	6	R-R 7-7 C-C W P T G	765	R9664A85G01
4	6	R-R 7-7 C-C Y W T G	822	R9666A84G01
4	6	R-R R-R R-R P P P P	702	R9689A33G01
4	6	R-R R-R R-R T T T T	578	R9688A11G01
4	6	R-R R-R R-R Y Y Y Y	982	R991A982G01
4	6	T 5-A T 5-A T 5-A T	698	R9689A28G01
4	6	T C-C C-C C-C P P P	471	R9676A60G01
4	6	T C-C C-C C-C P P T	A43	R991AA43G01
4	6	T C-C C-C C-C T P T	A42	R991AA42G01
4	6	T C-C T C-C T C-C T	056	R188A523G01
4	6	T C-C T C-C T C-C Y	748	R9689A84G01
4	6	T O G W R-R 9-9 5-5	812	R9666A72G01
4	6	T P C-C C-C C-C P P	207	R1586C42G18
4	6	T P P C-C C-C C-C P	868	R9682A53G01
4	6	T P P P C-C C-C C-C	760	R9664A80G01
4	6	T P P P C-C C-R C-C	752	R9689A89G01
4	6	T P T P C-C C-C C-C	837	R9666A94G01
4	6	T P Z W R-R C-C 7-7	661	R9688A87G01
4	6	T T C-C C-C C-C T T	294	R9667A22G01
4	6	T T P C-C C-C C-C P	678	R9689A07G01
4	6	T T P C-C C-C C-C T	298	R9667A80G01
4	6	T T P P C-C C-C C-C	437	R9672A90G01
4	6	T T T 5-5 5-5 5-5 T	899	R9682A84G01
4	6	T T T 5-A 5-A 5-A T	699	R9689A29G01
4	6	T T T 6-6 6-6 6-6 T	948	R991A948G01
4	6	T T T C-C C-C C-C G	802	R9666A59G01
4	6	T T T C-C C-C C-C P	296	R9667A69G01

Switch Selection Guide - Sorted by Configuration

\*P=potential, \*C=current

*P	*C	CONFIGURATION	CODE	STYLE
4	6	T T T C-C C-C C-C T	137	R714B325G32
4	6	T T T C-C C-C C-C W	464	R9676A35G01
4	6	T T T C-C C-C C-C Z	993	R991A993G01
4	6	T T T G C-C C-C C-C	635	R9647A23G01
4	6	T T T P C-C C-C C-C	482	R9676A80G01
4	6	T T T R-R R-R R-R T	165	R774B430G13
4	6	T T T T C-C C-C C-C	065	R498A010G01
4	6	T T T T C-C C-C C-C	450	R9676A10G01
4	6	T T T T R-R 8-8 7-7	884	R9682A69G01
4	6	T T T T R-R R-R R-R	854	R9682A39G01
4	6	T W Z G R-R 7-7 8-8	598	R9688A41G01
4	6	T W Z G R-R 8-8 7-7	505	R9683A07G01
4	6	T W Z P R-R 8-8 7-7	234	R991A234G01
4	6	T W Z R-R 8-8 7-7 P	502	R9683A04G01
4	6	T Y P G R-R 6-6 C-C	901	R9682A86G01
4	6	T Y Z 8-C P R-6-7-C	708	R9689A41G01
4	6	T Y Z R-R 6-6 7-7 P	787	R9666A44G01
4	6	T Y Z W C-C C-C C-C	677	R9689A06G01
4	6	W W O O C-C C-C C-C	797	R9666A54G01
4	6	W W O Y C-C C-C C-C	721	R9666A21G01
4	6	W W W 9-C 9-C 9-C W	832	R9652A25G01
4	6	W W W W 8-8 8-8 8-8	908	R9682A93G01
4	6	W W W W 9-9 9-9 9-9	624	R991A624G01
4	6	W W W W C-C C-C C-C	571	R9688A02G01
4	6	W W Y O C-C C-C C-C	632	R9647A20G01
4	6	W Y Y O C-C C-C C-C	835	R9652A28G01
4	6	Y T G 6-6 R-R 5-5 W	809	R9666A66G01
4	6	Y Y Y C-C C-C C-C Y	236	R991A236G01
4	6	Y Y Y R-R R-R R-R Y	915	R9669A30G01
4	6	Z R-R Z R-R Z R-R P	781	R9666A38G01
4	6	Z Z O O C-C C-C C-C	690	R9689A19G01
4	6	Z Z Z 6-6 6-6 6-6 Z	945	R991A945G01
4	6	Z Z Z C-C C-C C-C Z	325	R9672A01G01
4	6	Z Z Z R-R R-R R-R G	897	R9682A82G01
4	6	Z Z Z R-R R-R R-R Z	240	R991A240G01
4	6	Z Z Z W R-R 6-6 5-5	749	R9689A85G01
4	6	Z Z Z Z C-C C-C C-C	494	R9676A95G01
3	7	9-C 6-C 7-C 8 P G P	566	R9683A96G01
3	7	C Y Y Y C-C C-C C-C	912	R9682A97G01
3	7	C-C C-C C-C C P P P	260	R1586C42G43
3	7	C-C P C-C P C-C P C	388	R714B325G22
3	7	L L L U C-E C-E C-E	176	R1485B70G10
3	7	P G T C-C 5-5 R-R 8	480	R9676A76G01
3	7	P P C C-C C C-C C P	397	R716B562G12
3	7	P P C C-C C-C C-C P	033	R129A535G01
3	7	P P C C-C C-C C-C T	433	R9672A86G01
3	7	P P P C C C C C C C	205	R1586C42G17
3	7	P P P C C-C C-C C-C	318	R9671A26G01
3	7	P P P C-B C-B C-B S	149	R716B562G30
3	7	P P P C-C C-C C-C C	208	R1586C42G19

*P	*C	CONFIGURATION	CODE	STYLE
3	7	P P P C-C C-C C-C C	381	R714B325G11
3	7	P P P C-C C-C C-C C	135	R714B325G25
3	7	P P P S C-C C-C C-C	167	R774B430G16
3	7	P P P U C U C U C U	175	R1485B70G09
3	7	P T C C-C C-C C-C T	121	R670B197G22
3	7	R-R 7-7 C-C C Y W O	827	R9666A89G01
3	7	T O Y S C-8 7-8 5-8	799	R9666A56G01
3	7	T T C C-C C-C C-C T	180	R670B197G35
3	7	T T C-C C-C C-C C T	660	R9688A86G01
3	7	T T T C-C 5-5 R-R 8	711	R9689A45G01
3	7	T T T C-C C-C C-C C	281	R9663A59G01
3	7	T T T C-C C-C C-C N	114	R291B961G25
3	7	T T T C-C C-C C-C U	177	R1485B70G11
3	7	T T T R-R R-R R-R R	605	R9688A50G01
3	7	T T T S C-C C-C C-C	951	R991A951G01
2	8	5-5 5-5 5-5 5-5 G G	559	R9683A87G01
2	8	6-6 R-R 5-5 8-8 Z W	807	R9666A64G01
2	8	6-C 5-C 4-C 7-C W W	985	R991A985G01
2	8	7-7 7-7 7-7 7-7 P P	A40	R991AA40G01
2	8	7-7 7-7 7-7 7-7 W W	862	R9682A47G01
2	8	7-7 7-7 7-7 7-7 Z Z	561	R9683A89G01
2	8	8-C 8-C 8-C 8-C P P	237	R991A237G01
2	8	8-C R-C 5-C 9-C T T	659	R9688A85G01
2	8	9-9 9-9 9-9 9-9 G G	920	R9669A35G01
2	8	9-C 6-C 7-C C-C T T	630	R9647A18G01
2	8	C C C C C C C C P P	674	R9689A02G01
2	8	C-5-3-9 C-5-3-9 P P	A22	R991AA22G01
2	8	C-A P P C C-C C C-C	387	R714B325G21
2	8	C-B C-B C-B C-B P P	942	R991A942G01
2	8	C-C C-C C-C C-C P P	083	R837A407G01
2	8	C-C C-C C-C C-C P T	439	R9672A95G01
2	8	C-C C-C C-C C-C T P	451	R9676A11G01
2	8	C-C C-C C-C C-C T T	173	R774B430G22
2	8	C-C C-C C-C C-C W W	509	R9683A16G01
2	8	C-C C-C C-C C-C Z Z	994	R991A994G01
2	8	C-C C-C P C C C C P	420	R837A664G01
2	8	C-C P P C C-C C C-C	404	R716B562G24
2	8	C-C T C-C C-C C-C P	668	R9688A94G01
2	8	C-C T C-C C-C C-C T	295	R9667A68G01
2	8	C-C-C-B C-C-C-B P P	376	R498A031G01
2	8	C-C-C-C C C C-C P P	153	R716B562G38
2	8	C-C-C-C C-C C-C P P	131	R714B325G15
2	8	C-C-C-C C-C-C-B P P	082	R837A101G01
2	8	C-C-C-C C-C-C-B T T	259	R1586C42G42
2	8	C-C-C-C C-C-C-C P P	163	R774B430G11
2	8	C-C-C-C C-C-C-C P T	188	R1586C42G09
2	8	C-C-C-C C-C-C-C T P	316	R9671A22G01
2	8	C-C-C-C C-C-C-C T T	618	R9642A36G01
2	8	C-C-C-C P C-C-C-C P	438	R9672A94G01
2	8	C-C-C-C T C-C-C-C T	443	R9676A01G01

Switch Selection Guide - Sorted by Configuration

\*P=potential, \*C=current

*P	*C	CONFIGURATION	CODE	STYLE
2	8	C-C-C-D C-C-C-B P P	079	R498A032G01
2	8	C-C-C-D C-C-C-D P P	383	R714B325G13
2	8	C-C-C-D C-C-C-D P P	164	R774B430G12
2	8	C-C-C-E C-C-C-E T T	329	R9672A23G01
2	8	C-C-C-E T C-C-C-E T	435	R9672A88G01
2	8	C-C-E C C-C C-C P P	154	R716B562G39
2	8	L C-E C-E C-E C-E L	722	R9666A23G01
2	8	O O C-C C-C C-C C-C	877	R9682A61G01
2	8	P 8-8 8-8 8-8 8-8 P	841	R9682A24G01
2	8	P C C C C C C C P	019	R129A519G01
2	8	P C C C C P C C C C	146	R716B562G27
2	8	P C-C C-C C-C C-C P	018	R129A518G01
2	8	P C-C C-C C-C C-C T	340	R1586C42G08
2	8	P C-C C-C C-C C-C T	186	R837A616G01
2	8	P P 5-5 R-R 6-6 C-C	902	R9682A87G01
2	8	P P 9-9 9-9 9-9 9-9	625	R991A625G01
2	8	P P C-C C-C C-C C-C	184	R716B562G25
2	8	P P C-C-C-C C-C-C-C	495	R9676A96G01
2	8	P P R-8-7-9 R-8-7-9	A34	R991AA34G01
2	8	P R-R 8-8 7-7 C-C P	233	R991A233G01
2	8	P R-R R-R R-R R-R P	569	R9683A99G01
2	8	P S P R-R R-R R-R C	484	R9676A83G01
2	8	R-6-7-C R-6-7-C O O	778	R9666A35G01
2	8	R-B R-B R-B R-B T T	382	R714B325G12
2	8	R-C R-C R-C R-C T T	396	R716B562G11
2	8	R-R 7-7 C-C 9-9 T G	763	R9664A83G01
2	8	R-R 7-7 C-C 9-9 T P	762	R9664A82G01
2	8	R-R R-R R-R R-R P P	665	R9688A91G01
2	8	R-R R-R R-R R-R T T	791	R9666A48G01
2	8	T 5-5 6-6 7-7 5-5 T	724	R9666A26G01
2	8	T C C C C C C C P	312	R9671A04G01
2	8	T C C C C C C C T	314	R9671A12G01
2	8	T C C C-C C-C C-C T	425	R876A157G01
2	8	T C-C C-C C-C C-C P	200	R670B197G38
2	8	T C-C C-C C-C C-C T	084	R849A513G01
2	8	T C-C C-C C-C C-C Y	479	R9676A75G01
2	8	T C-C-C-C C-C C-C P	723	R9666A24G01
2	8	T C-C-C-C C-C-C-C P	703	R9689A34G01
2	8	T R-R R-R R-R R-R T	147	R716B562G28
2	8	T T 5-5 R-R 8-8 7-7	883	R9682A68G01
2	8	T T 9-9 9-9 9-9 9-9	925	R9669A40G01
2	8	T T C-C C-C C-C C-C	204	R1586C42G16
2	8	T T C-C C-C C-C C-C	201	R774B430G28
2	8	T T R-R 8-8 7-7 5-5	935	R991A935G01
2	8	W D D D D D D D W	986	R991A986G01
2	8	W W C-C C-C C-C C-C	794	R9666A51G01
2	8	Z C-C C-C C-C C-C Z	741	R9689A77G01
1	9	6-C 5-C 4-C 7-C D H	988	R991A988G01
1	9	C C C C C C C C P	037	R129A541G01
1	9	C C C C C C C C T	280	R188A286G01

*P	*C	CONFIGURATION	CODE	STYLE
1	9	C C C C-C C-C C-C P	117	R670B197G16
1	9	C-C C C-C C-C C-C P	959	R991A959G01
1	9	C-C C-C C-C C C-C P	257	R1586C42G40
1	9	C-C C-C C-C C C-C T	251	R1586C42G35
1	9	P C-C C C-C C C-C C	389	R714B325G23
1	9	P C-C-C-B C C-C-C-B	078	R498A030G01
1	9	T 8-8 C-C 5-5 R-R 8	604	R9688A48G01
0	10	5-A 5-A 5-A 5-A 5-A	696	R9689A26G01
0	10	6-6 6-6 6-6 6-6 6-6	772	R9664A94G01
0	10	8-8 8-8 8-8 8-8 8-8	909	R9682A94G01
0	10	9-9 9-9 9-9 9-9 9-9	A46	R991AA46G01
0	10	C C C C C C C C C C	027	R129A529G01
0	10	C C C C C C C C C C	168	R774B430G17
0	10	C C C C C-C-C-C-C C	A20	R991AA20G01
0	10	C C C C-C C-C C-C C	455	R9676A18G01
0	10	C C C C-C-C-C-C C C	649	R9688A75G01
0	10	C C-B C C-B C C-B C	141	R716B562G14
0	10	C C-C C-C C-C C-C C	398	R716B562G13
0	10	C-A C-A C-A C-A C-A	675	R9689A03G01
0	10	C-C 5-5 3-3 9-9 C-C	A24	R991AA24G01
0	10	C-C 5-5 R-R 8-8 8-8	682	R9689A11G01
0	10	C-C C-C C C C-C C-C	391	R714B325G26
0	10	C-C C-C C-C 8-8 8-8	907	R9682A92G01
0	10	C-C C-C C-C C-C 8-8	906	R9682A91G01
0	10	C-C C-C C-C C-C C C	166	R774B430G15
0	10	C-C C-C C-C C-C C-C	073	R498A020G01
0	10	C-C C-C C-C C-C R R	458	R9676A23G01
0	10	C-C C-C C-C C-C S S	A08	R991AA08G01
0	10	C-C C-C C-C C-C-C-C	457	R9676A20G01
0	10	C-C-C-A C-A C-A C-A	562	R9683A92G01
0	10	C-C-C-A C-C C-C C-A	414	R774B430G14
0	10	C-C-C-A C-C-C-A C-C	337	R1586C42G02
0	10	C-C-C-B C-C C-C-C-B	060	R498A001G01
0	10	C-C-C-C C-C C-C C-C	384	R714B325G14
0	10	C-C-C-C C-C C-C-C-C	783	R9666A40G01
0	10	C-C-C-C C-C-C-C C-C	174	R774B430G23
0	10	C-C-C-C C-C-C-C R-R	784	R9666A41G01
0	10	C-D C-D C-D C-D C-D	447	R9676A07G01
0	10	C-E C-E C-E C-E C-E	129	R714B325G09
0	10	J J J J J J J J J J	367	R291B962G31
0	10	R R R R R R R R R R	869	R9682A54G01
0	10	R-6-7-C R-6-7-C 8-C	710	R9689A43G01
0	10	R-A R-A R-A R-A R-A	688	R9689A17G01
0	10	R-B R-B R-B R-B R-B	130	R714B325G10
0	10	R-C R-C R-C R-C R-C	139	R716B562G09
0	10	R-R 6-6 7-7 8-8 C-C	606	R9688A51G01
0	10	R-R R-R R-R R-R R-R	276	R9663A33G01

Switch Selection Guide - Sorted by Ascending Style Number

\*P=potential, \*C=current

*P	*C	STYLE	CODE	*P	*C	STYLE	CODE	*P	*C	STYLE	CODE	*P	*C	STYLE	CODE	*P	*C	STYLE	CODE
10	0	129A501G01	001	7	3	129A553G01	048	10	0	1586C42G45	262	5	2	291B959G27	356	2	8	498A031G01	376
8	0	129A502G01	002	0	5	129A555G01	049	10	0	1586C42G46	263	7	0	291B959G28	357	2	8	498A032G01	079
7	0	129A503G01	003	3	7	1485B70G09	175	8	2	1586C42G47	264	0	7	291B959G29	105	4	4	629A315G01	080
6	0	129A504G01	004	3	7	1485B70G10	176	4	6	1586C42G48	265	7	0	291B959G30	106	6	3	629A483G01	081
5	0	129A505G01	005	3	7	1485B70G11	177	0	8	188A229G01	050	3	4	291B959G32	108	6	0	629A568G01	377
4	0	129A506G01	006	4	0	1586C39G01	336	5	2	188A261G01	051	7	0	291B959G33	109	6	4	629A735G01	378
2	2	129A507G01	007	4	0	1586C39G02	203	1	9	188A286G01	280	0	8	291B960G20	358	1	9	670B197G16	117
3	2	129A508G01	008	6	0	1586C40G01	206	0	6	188A304G01	052	6	2	291B960G26	110	8	2	670B197G17	118
4	2	129A509G01	009	0	8	1586C41G01	278	6	0	188A416G01	053	3	5	291B960G27	359	4	6	670B197G18	119
5	2	129A510G01	010	0	10	1586C42G02	337	0	6	188A454G01	054	0	8	291B960G33	360	6	4	670B197G19	379
3	4	129A511G01	011	4	6	1586C42G03	288	4	3	188A477G01	055	6	2	291B960G36	111	5	5	670B197G20	120
4	4	129A512G01	012	4	6	1586C42G05	338	4	6	188A523G01	056	8	0	291B960G37	187	10	0	670B197G21	380
6	4	129A513G01	013	10	0	1586C42G06	317	3	4	188A618G01	057	2	6	291B960G38	361	3	7	670B197G22	121
4	6	129A514G01	014	2	8	1586C42G08	340	5	2	188A622G01	341	8	0	291B960G39	112	4	6	670B197G23	122
3	6	129A515G01	015	2	8	1586C42G09	188	6	2	188A632G01	058	5	4	291B961G22	362	10	0	670B197G24	123
0	6	129A516G01	016	4	6	1586C42G10	189	5	4	188A633G01	059	6	3	291B961G23	113	6	4	670B197G25	124
0	8	129A517G01	017	6	4	1586C42G11	190	0	2	291B954G12	088	3	7	291B961G25	114	10	0	670B197G26	185
2	8	129A518G01	018	6	4	1586C42G12	191	2	0	291B954G13	089	2	7	291B961G26	115	4	6	670B197G27	125
2	8	129A519G01	019	6	4	1586C42G13	192	2	0	291B954G14	342	3	6	291B961G27	364	6	4	670B197G28	126
6	4	129A520G01	020	6	4	1586C42G14	243	2	0	291B954G15	343	5	4	291B961G28	365	10	0	670B197G31	127
2	6	129A521G01	021	10	0	1586C42G15	242	2	0	291B954G16	090	3	6	291B961G29	366	4	6	670B197G32	128
0	6	129A523G01	022	2	8	1586C42G16	204	0	4	291B956G13	091	6	3	291B961G30	116	8	2	670B197G33	178
4	0	129A524G01	023	3	7	1586C42G17	205	2	2	291B956G18	092	0	10	291B962G31	367	6	4	670B197G34	179
2	6	129A525G01	024	4	6	1586C42G18	207	0	4	291B956G23	093	0	10	498A001G01	060	3	7	670B197G35	180
7	0	129A526G01	025	3	7	1586C42G19	208	4	0	291B956G24	344	1	4	498A002G01	061	10	0	670B197G36	181
4	6	129A528G01	026	8	2	1586C42G20	209	4	0	291B956G25	345	1	6	498A003G01	368	6	4	670B197G37	182
0	10	129A529G01	027	4	6	1586C42G21	210	3	1	291B956G26	346	0	8	498A004G01	062	2	8	670B197G38	200
4	4	129A530G01	028	6	4	1586C42G22	211	0	4	291B956G27	195	3	4	498A008G01	063	0	10	714B325G09	129
0	2	129A531G01	029	10	0	1586C42G23	212	1	3	291B956G28	347	1	8	498A009G01	064	0	10	714B325G10	130
6	4	129A532G01	030	10	0	1586C42G24	213	0	4	291B956G29	094	4	6	498A010G01	065	3	7	714B325G11	381
3	2	129A533G01	031	10	0	1586C42G25	214	2	2	291B956G30	095	9	1	498A011G01	066	2	8	714B325G12	382
2	0	129A534G01	032	8	2	1586C42G26	215	4	0	291B956G31	193	4	0	498A012G01	067	2	8	714B325G13	383
3	7	129A535G01	033	6	4	1586C42G27	217	4	0	291B956G32	196	7	0	498A013G01	068	0	10	714B325G14	384
8	0	129A536G01	331	10	0	1586C42G28	244	3	2	291B957G09	348	0	6	498A014G01	069	2	8	714B325G15	131
2	4	129A537G01	034	10	0	1586C42G29	245	5	0	291B957G15	096	6	4	498A015G01	070	6	4	714B325G16	132
4	0	129A538G01	035	10	0	1586C42G30	246	3	2	291B957G16	349	4	4	498A016G01	071	4	6	714B325G17	133
10	0	129A539G01	036	10	0	1586C42G31	247	3	2	291B957G17	350	0	6	498A017G01	369	6	4	714B325G18	134
1	6	129A540G01	332	8	2	1586C42G32	248	3	3	291B958G24	351	1	7	498A018G01	370	4	6	714B325G19	385
1	9	129A541G01	037	8	2	1586C42G33	249	6	0	291B958G25	216	1	7	498A019G01	072	4	6	714B325G20	386
8	2	129A542G01	038	4	6	1586C42G34	250	0	6	291B958G26	352	0	10	498A020G01	073	2	8	714B325G21	387
3	3	129A543G01	039	1	9	1586C42G35	251	2	4	291B958G27	353	0	9	498A021G01	074	3	7	714B325G22	388
4	4	129A544G01	040	4	6	1586C42G36	252	0	6	291B958G28	270	4	0	498A022G01	075	1	9	714B325G23	389
5	4	129A545G01	041	4	6	1586C42G37	253	0	6	291B958G29	098	0	9	498A023G01	371	4	6	714B325G24	390
8	0	129A546G01	042	8	2	1586C42G38	254	2	4	291B958G30	099	3	6	498A024G01	372	3	7	714B325G25	135
7	0	129A547G01	043	9	1	1586C42G39	255	2	4	291B958G31	100	0	8	498A025G01	373	0	10	714B325G26	391
9	0	129A548G01	044	1	9	1586C42G40	257	6	0	291B958G33	102	0	2	498A026G01	076	6	4	714B325G27	392
8	0	129A549G01	045	10	0	1586C42G41	258	5	2	291B959G18	103	0	4	498A027G01	077	6	4	714B325G28	393
6	0	129A550G01	046	2	8	1586C42G42	259	7	0	291B959G19	104	4	5	498A028G01	374	6	4	714B325G29	394
9	0	129A551G01	047	3	7	1586C42G43	260	3	4	291B959G20	354	0	8	498A029G01	375	8	2	714B325G30	136
6	3	129A552G01	333	10	0	1586C42G44	261	3	4	291B959G26	355	1	9	498A030G01	078	8	2	714B325G31	395

Switch Selection Guide - Sorted by Ascending Style Number

\*P=potential, \*C=current

*P	*C	STYLE	CODE	*P	*C	STYLE	CODE	*P	*C	STYLE	CODE	*P	*C	STYLE	CODE
4	6	714B325G32	137	4	6	774B430G20	171	10	0	9663A25G01	274	4	6	9666A46G01	789
0	10	716B562G09	139	4	6	774B430G21	172	6	4	9663A31G01	275	10	0	9666A47G01	790
10	0	716B562G10	140	2	8	774B430G22	173	0	10	9663A33G01	276	2	8	9666A48G01	791
2	8	716B562G11	396	0	10	774B430G23	174	3	6	9663A34G01	277	10	0	9666A49G01	792
3	7	716B562G12	397	4	6	774B430G24	183	10	0	9663A41G01	279	10	0	9666A50G01	793
0	10	716B562G13	398	2	8	774B430G28	201	3	7	9663A59G01	281	2	8	9666A51G01	794
0	10	716B562G14	141	1	0	774B542G09	415	8	2	9663A60G01	282	10	0	9666A52G01	795
6	4	716B562G15	142	6	4	836A867G01	416	3	6	9663A74G01	283	10	0	9666A53G01	796
4	6	716B562G16	399	0	4	837A087G01	417	1	6	9663A77G01	284	4	6	9666A54G01	797
6	4	716B562G17	400	0	8	837A098G01	418	1	2	9663A78G01	285	4	6	9666A55G01	798
4	6	716B562G18	401	0	8	837A099G01	419	7	0	9663A79G01	286	3	7	9666A56G01	799
6	4	716B562G19	143	2	8	837A101G01	082	4	0	9663A80G01	287	10	0	9666A58G01	801
6	4	716B562G20	402	2	8	837A407G01	083	10	0	9664A78G01	758	4	6	9666A59G01	802
8	2	716B562G21	403	2	8	837A616G01	186	10	0	9664A79G01	759	4	6	9666A60G01	803
2	8	716B562G24	404	2	8	837A664G01	420	4	6	9664A80G01	760	10	0	9666A61G01	804
2	8	716B562G25	184	8	2	837A665G01	202	4	6	9664A81G01	761	10	0	9666A62G01	805
8	2	716B562G26	145	6	0	837A889G01	421	2	8	9664A82G01	762	4	6	9666A63G01	806
2	8	716B562G27	146	6	4	849A307G01	422	2	8	9664A83G01	763	2	8	9666A64G01	807
2	8	716B562G28	147	2	8	849A513G01	084	10	0	9664A84G01	764	10	0	9666A65G01	808
3	7	716B562G30	149	3	6	861A551G01	423	4	6	9664A85G01	765	4	6	9666A66G01	809
8	2	716B562G35	152	6	4	861A670G01	085	4	6	9664A86G01	766	4	6	9666A67G01	810
6	4	716B562G36	256	4	0	862A584G01	086	4	6	9664A87G01	767	8	2	9666A69G01	811
4	6	716B562G37	144	2	8	876A157G01	425	10	0	9664A88G01	768	4	6	9666A72G01	812
2	8	716B562G38	153	6	4	877A077G01	087	4	6	9664A89G01	769	10	0	9666A73G01	813
2	8	716B562G39	154	10	0	9641A64G01	619	10	0	9664A92G01	770	10	0	9666A76G01	815
3	0	716B871G09	155	2	8	9642A36G01	618	4	6	9664A93G01	771	10	0	9666A77G01	816
0	3	716B871G10	405	10	0	9646A77G01	620	0	10	9664A94G01	772	0	8	9666A78G01	817
3	0	716B871G11	156	8	2	9647A11G01	627	10	0	9664A97G01	775	10	0	9666A79G01	818
3	0	716B871G12	157	8	2	9647A12G01	628	10	0	9664A98G01	776	10	0	9666A80G01	819
8	0	719B591G09	406	4	0	9647A17G01	629	0	4	9666A12G01	616	8	2	9666A82G01	820
8	0	719B591G10	407	2	8	9647A18G01	630	10	0	9666A13G01	617	0	6	9666A83G01	821
4	4	719B591G11	408	9	1	9647A19G01	631	4	6	9666A20G01	720	4	6	9666A84G01	822
8	0	719B591G12	158	4	6	9647A20G01	632	4	6	9666A21G01	721	0	8	9666A85G01	823
4	4	719B591G13	159	10	0	9647A21G01	633	2	8	9666A23G01	722	10	0	9666A86G01	824
8	0	719B591G14	160	10	0	9647A22G01	634	2	8	9666A24G01	723	10	0	9666A87G01	825
0	4	763A109G01	410	4	6	9647A23G01	635	2	8	9666A26G01	724	4	6	9666A88G01	826
4	0	763A166G01	411	8	2	9647A98G01	636	6	4	9666A27G01	725	3	7	9666A89G01	827
6	2	763A167G01	412	10	0	9649A37G01	637	8	2	9666A28G01	726	10	0	9666A90G01	828
7	0	763A168G01	413	4	6	9652A25G01	832	8	2	9666A34G01	777	4	6	9666A91G01	829
4	6	774B430G09	161	10	0	9652A26G01	833	2	8	9666A35G01	778	10	0	9666A92G01	831
4	6	774B430G10	162	10	0	9652A27G01	834	10	0	9666A36G01	779	10	0	9666A93G01	836
2	8	774B430G11	163	4	6	9652A28G01	835	6	4	9666A37G01	780	4	6	9666A94G01	837
2	8	774B430G12	164	10	0	9652A29G01	870	4	6	9666A38G01	781	3	2	9666A95G01	838
4	6	774B430G13	165	6	4	9652A30G01	871	6	0	9666A39G01	782	8	2	9666A96G01	839
0	10	774B430G14	414	0	8	9660A84G01	266	0	10	9666A40G01	783	6	4	9666A97G01	840
0	10	774B430G15	166	4	6	9660A85G01	267	0	10	9666A41G01	784	4	2	9667A02G01	289
3	7	774B430G16	167	6	4	9660A91G01	268	8	2	9666A42G01	785	10	0	9667A03G01	290
0	10	774B430G17	168	10	0	9660A92G01	269	10	0	9666A43G01	786	10	0	9667A06G01	291
4	6	774B430G18	169	4	6	9660A96G01	272	4	6	9666A44G01	787	5	2	9667A17G01	292
10	0	774B430G19	170	0	6	9660A97G01	273	10	0	9666A45G01	788	2	6	9667A21G01	293
4	6	9667A22G01	294	2	8	9667A68G01	295	4	6	9667A69G01	296	10	0	9667A78G01	297
2	8	9667A68G01	295	4	6	9667A69G01	296	10	0	9667A78G01	297	4	6	9667A80G01	298
4	6	9667A69G01	296	10	0	9667A80G01	298	10	0	9667A86G01	299	10	0	9667A93G01	300
10	0	9667A78G01	297	10	0	9667A86G01	299	10	0	9667A93G01	300	10	0	9668A27G01	301
4	6	9667A80G01	298	10	0	9668A27G01	301	10	0	9668A27G01	301	10	0	9668A54G01	304
10	0	9667A86G01	299	10	0	9668A54G01	304	10	0	9668A54G01	304	10	0	9668A54G01	304
10	0	9667A93G01	300	2	6	9668A69G01	305	2	6	9668A69G01	305	2	6	9668A69G01	305
10	0	9668A27G01	301	1	8	9668A70G01	306	1	8	9668A70G01	306	1	8	9668A70G01	306
10	0	9668A54G01	304	4	6	9669A30G01	915	4	6	9669A30G01	915	4	6	9669A30G01	915
10	0	9668A54G01	304	6	0	9669A31G01	916	6	0	9669A31G01	916	6	0	9669A31G01	916
2	6	9668A69G01	305	4	4	9669A32G01	917	4	4	9669A32G01	917	4	4	9669A32G01	917
1	8	9668A70G01	306	10	0	9669A33G01	918	10	0	9669A33G01	918	10	0	9669A33G01	918
4	6	9669A30G01	915	10	0	9669A34G01	919	10	0	9669A34G01	919	10	0	9669A34G01	919
6	0	9669A31G01	916	2	8	9669A35G01	920	2	8	9669A35G01	920	2	8	9669A35G01	920
4	4	9669A32G01	917	4	6	9669A36G01	921	4	6	9669A36G01	921	4	6	9669A36G01	921
10	0	9669A33G01	918	10	0	9669A37G01	922	10	0	9669A37G01	922	10	0	9669A37G01	922
10	0	9669A34G01	919	10	0	9669A38G01	923	10	0	9669A38G01	923	10	0	9669A38G01	923
2	8	9669A35G01	920	10	0	9669A39G01	924	10	0	9669A39G01	924	10	0	9669A39G01	924
4	6	9669A36G01	921	2	8	9669A40G01	925	2	8	9669A40G01	925	2	8	9669A40G01	925
10	0	9669A37G01	922	10	0	9669A41G01	926	10	0	9669A41G01	926	10	0	9669A41G01	926
10	0	9669A38G01	923	4	6	9669A42G01	927	4	6	9669A42G01	927	4	6	9669A42G01	927
10	0	9669A39G01	924	4	6	9669A43G01	928	4	6	9669A43G01	928	4	6	9669A43G01	928
2	8	9669A40G01	925	4	6	9670A05G01	307	4	6	9670A05G01	307	4	6	9670A05G01	307
10	0	9669A41G01	926	10	0	9670A05G01	307	10	0	9670A05G01	307	10	0	9670A05G01	307
4	6	9669A42G01	927	10	0	9670A34G01	308	10	0	9670A34G01	308	10	0	9670A34G01	308
10	0	9669A43G01	928	10	0	9670A35G01	309	10	0	9670A35G01	309	10	0	9670A35G01	309
2	8	9669A44G01	929	10	0	9670A97G01	310	10	0	9670A97G01	310	10	0	9670A97G01	310
10	0	9669A45G01	929	10	0	9670A98G01	311	10	0	9670A98G01	311	10	0	9670A98G01	311
10	0	9669A46G01	930	8	2	9670A99G01	312	8	2	9670A99G01	312	8	2	9670A99G01	312
10	0	9669A47G01	931	2	8	9671A04G01	312	2	8	9671A04G01	312	2	8	9671A04G01	312
10	0	9669A48G01	932	2	2	9671A05G01	313	2	2	9671A05G01	313	2	2	9671A05G01	313
10	0	9669A49G01	933	2	8	9671A12G01	314	2	8	9671A12G01	314	2	8	9671A12G01	314
10	0	9669A50G01	934												

Switch Selection Guide - Sorted by Ascending Style Number

\*P=potential, \*C=current

*P	*C	STYLE	CODE	*P	*C	STYLE	CODE	*P	*C	STYLE	CODE	*P	*C	STYLE	CODE	*P	*C	STYLE	CODE
10	0	9672A74G01	428	2	8	9676A75G01	479	10	0	9682A62G01	878	10	0	9683A69G01	550	10	0	9688A44G01	601
10	0	9672A75G01	429	3	7	9676A76G01	480	10	0	9682A64G01	879	10	0	9683A70G01	551	9	0	9688A45G01	602
10	0	9672A77G01	430	3	4	9676A79G01	481	10	0	9682A65G01	880	6	2	9683A71G01	552	2	0	9688A46G01	603
6	4	9672A80G01	431	4	6	9676A80G01	482	10	0	9682A66G01	881	8	2	9683A72G01	553	1	9	9688A48G01	604
8	2	9672A83G01	432	10	0	9676A81G01	483	10	0	9682A67G01	882	4	6	9683A73G01	554	3	7	9688A50G01	605
3	7	9672A86G01	433	2	8	9676A83G01	484	2	8	9682A68G01	883	10	0	9683A75G01	555	0	10	9688A51G01	606
6	4	9672A87G01	434	10	0	9676A84G01	485	4	6	9682A69G01	884	0	6	9683A76G01	556	10	0	9688A52G01	607
2	8	9672A88G01	435	8	2	9676A86G01	486	10	0	9682A70G01	885	8	0	9683A80G01	557	10	0	9688A53G01	608
8	2	9672A89G01	436	10	0	9676A87G01	487	10	0	9682A71G01	886	6	0	9683A81G01	558	10	0	9688A54G01	609
4	6	9672A90G01	437	10	0	9676A88G01	488	10	0	9682A72G01	887	2	8	9683A87G01	559	5	0	9688A55G01	610
2	8	9672A94G01	438	10	0	9676A89G01	489	10	0	9682A73G01	888	10	0	9683A88G01	560	10	0	9688A56G01	611
2	8	9672A95G01	439	10	0	9676A90G01	490	8	2	9682A74G01	889	2	8	9683A89G01	561	10	0	9688A57G01	612
10	0	9672A97G01	440	10	0	9676A91G01	491	10	0	9682A76G01	891	0	10	9683A92G01	562	10	0	9688A58G01	613
10	0	9672A98G01	441	10	0	9676A93G01	492	10	0	9682A77G01	892	0	8	9683A93G01	563	10	0	9688A59G01	614
6	4	9672A99G01	442	10	0	9676A94G01	493	10	0	9682A78G01	893	6	4	9683A94G01	564	8	2	9688A62G01	615
2	8	9676A01G01	443	4	6	9676A95G01	494	10	0	9682A79G01	894	10	0	9683A95G01	565	3	0	9688A63G01	639
8	2	9676A04G01	444	2	8	9676A96G01	495	8	2	9682A80G01	895	3	7	9683A96G01	566	4	0	9688A64G01	640
6	4	9676A05G01	445	10	0	9676A97G01	496	4	6	9682A82G01	897	10	0	9683A97G01	567	2	6	9688A65G01	641
6	4	9676A06G01	446	4	6	9676A98G01	497	10	0	9682A83G01	898	4	6	9683A98G01	568	10	0	9688A66G01	642
0	10	9676A07G01	447	4	6	9676A99G01	498	4	6	9682A84G01	899	2	8	9683A99G01	569	3	1	9688A67G01	643
10	0	9676A08G01	448	10	0	9682A19G01	830	8	2	9682A85G01	900	4	6	9688A01G01	570	0	8	9688A70G01	644
6	4	9676A09G01	449	2	8	9682A24G01	841	4	6	9682A86G01	901	4	6	9688A02G01	571	10	0	9688A71G01	645
4	6	9676A10G01	450	8	2	9682A25G01	842	2	8	9682A87G01	902	2	2	9688A03G01	572	10	0	9688A72G01	646
2	8	9676A11G01	451	10	0	9682A29G01	846	10	0	9682A89G01	904	6	0	9688A04G01	573	10	0	9688A73G01	647
10	0	9676A14G01	452	10	0	9682A30G01	847	10	0	9682A90G01	905	8	2	9688A07G01	574	10	0	9688A74G01	648
8	2	9676A15G01	453	10	0	9682A31G01	848	0	10	9682A91G01	906	10	0	9688A08G01	575	0	10	9688A75G01	649
4	6	9676A17G01	454	10	0	9682A32G01	849	0	10	9682A92G01	907	10	0	9688A09G01	576	10	0	9688A76G01	650
0	10	9676A18G01	455	10	0	9682A35G01	850	4	6	9682A93G01	908	10	0	9688A10G01	577	10	0	9688A77G01	651
3	3	9676A19G01	456	6	4	9682A36G01	851	0	10	9682A94G01	909	4	6	9688A11G01	578	10	0	9688A78G01	652
0	10	9676A20G01	457	10	0	9682A37G01	852	10	0	9682A96G01	911	10	0	9688A12G01	579	4	0	9688A79G01	653
0	10	9676A23G01	458	10	0	9682A38G01	853	3	7	9682A97G01	912	10	0	9688A13G01	580	10	0	9688A80G01	654
0	7	9676A24G01	459	4	6	9682A39G01	854	6	4	9682A98G01	913	10	0	9688A14G01	581	10	0	9688A81G01	655
0	9	9676A25G01	460	10	0	9682A41G01	856	10	0	9682A99G01	914	10	0	9688A15G01	582	10	0	9688A82G01	656
4	0	9676A26G01	461	10	0	9682A42G01	857	10	0	9683A01G01	499	10	0	9688A16G01	583	3	4	9688A83G01	657
4	0	9676A27G01	462	2	5	9682A43G01	858	10	0	9683A02G01	500	10	0	9688A17G01	584	10	0	9688A84G01	658
10	0	9676A34G01	463	9	0	9682A44G01	859	10	0	9683A03G01	501	10	0	9688A18G01	585	2	8	9688A85G01	659
4	6	9676A35G01	464	10	0	9682A45G01	860	4	6	9683A04G01	502	10	0	9688A19G01	586	3	7	9688A86G01	660
2	2	9676A36G01	465	10	0	9682A46G01	861	4	6	9683A05G01	503	10	0	9688A20G01	587	4	6	9688A87G01	661
5	0	9676A37G01	466	2	8	9682A47G01	862	10	0	9683A06G01	504	4	6	9688A22G01	588	10	0	9688A88G01	662
2	0	9676A38G01	467	4	6	9682A48G01	863	4	6	9683A07G01	505	10	0	9688A23G01	589	10	0	9688A89G01	663
10	0	9676A53G01	468	4	6	9682A49G01	864	8	0	9683A10G01	507	10	0	9688A24G01	590	10	0	9688A90G01	664
4	6	9676A55G01	469	4	6	9682A50G01	865	4	6	9683A15G01	508	2	2	9688A25G01	591	2	8	9688A91G01	665
4	6	9676A58G01	470	4	6	9682A51G01	866	2	8	9683A16G01	509	10	0	9688A26G01	592	10	0	9688A92G01	666
4	6	9676A60G01	471	10	0	9682A52G01	867	10	0	9683A17G01	510	10	0	9688A28G01	594	10	0	9688A93G01	667
6	0	9676A65G01	473	4	6	9682A53G01	868	10	0	9683A18G01	511	0	6	9688A30G01	595	2	8	9688A94G01	668
4	6	9676A68G01	474	0	10	9682A54G01	869	10	0	9683A19G01	512	4	6	9688A38G01	596	10	0	9688A95G01	669
6	4	9676A71G01	475	10	0	9682A57G01	874	4	6	9683A20G01	513	6	0	9688A40G01	597	10	0	9688A96G01	670
10	0	9676A72G01	476	10	0	9682A59G01	875	4	6	9683A21G01	514	4	6	9688A41G01	598	8	2	9688A98G01	671
10	0	9676A73G01	477	10	0	9682A60G01	876	2	6	9683A22G01	515	0	8	9688A42G01	599	7	0	9688A99G01	672
10	0	9676A74G01	478	2	8	9682A61G01	877	10	0	9683A61G01	549	0	6	9688A43G01	600	6	4	9689A01G01	673

Switch Selection Guide - Sorted by Ascending Style Number

\*P=potential, \*C=current

*P	*C	STYLE	CODE	*P	*C	STYLE	CODE	*P	*C	STYLE	CODE	*P	*C	STYLE	CODE				
2	8	9689A02G01	674	10	0	9689A65G01	732	6	4	991A335G01	335	6	4	991A970G01	970	6	4	991AA21G01	A21
0	10	9689A03G01	675	10	0	9689A69G01	734	6	4	991A506G01	506	10	0	991A971G01	971	2	8	991AA22G01	A22
4	6	9689A04G01	676	10	0	9689A70G01	735	10	0	991A621G01	621	10	0	991A972G01	972	6	4	991AA23G01	A23
4	6	9689A06G01	677	8	2	9689A72G01	736	6	4	991A622G01	622	10	0	991A973G01	973	0	10	991AA24G01	A24
4	6	9689A07G01	678	6	4	9689A73G01	737	10	0	991A623G01	623	10	0	991A974G01	974	10	0	991AA25G01	A25
10	0	9689A08G01	679	0	2	9689A74G01	738	4	6	991A624G01	624	10	0	991A975G01	975	10	0	991AA26G01	A26
10	0	9689A09G01	680	3	0	9689A75G01	739	2	8	991A625G01	625	10	0	991A976G01	976	4	6	991AA27G01	A27
4	5	9689A10G01	681	8	0	9689A76G01	740	0	4	991A626G01	626	10	0	991A977G01	977	10	0	991AA28G01	A28
0	10	9689A11G01	682	2	8	9689A77G01	741	10	0	991A814G01	814	10	0	991A978G01	978	4	6	991AA29G01	A29
0	4	9689A12G01	683	0	6	9689A78G01	742	10	0	991A929G01	929	10	0	991A979G01	979	10	0	991AA30G01	A30
10	0	9689A13G01	684	10	0	9689A79G01	743	10	0	991A930G01	930	10	0	991A980G01	980	10	0	991AA31G01	A31
4	6	9689A14G01	685	4	0	9689A80G01	744	10	0	991A931G01	931	10	0	991A981G01	981	10	0	991AA32G01	A32
10	0	9689A15G01	686	6	4	9689A81G01	745	4	0	991A932G01	932	4	6	991A982G01	982	4	6	991AA33G01	A33
6	2	9689A16G01	687	4	6	9689A84G01	748	8	2	991A933G01	933	8	2	991A983G01	983	2	8	991AA34G01	A34
0	10	9689A17G01	688	4	6	9689A85G01	749	8	2	991A934G01	934	10	0	991A984G01	984	6	4	991AA35G01	A35
6	4	9689A18G01	689	8	2	9689A87G01	750	2	8	991A935G01	935	2	8	991A985G01	985	4	6	991AA36G01	A36
4	6	9689A19G01	690	8	2	9689A88G01	751	1	6	991A936G01	936	2	8	991A986G01	986	0	8	991AA37G01	A37
0	8	9689A20G01	691	4	6	9689A89G01	752	8	0	991A937G01	937	10	0	991A987G01	987	4	6	991AA38G01	A38
9	0	9689A21G01	692	8	0	9689A90G01	753	2	6	991A938G01	938	1	9	991A988G01	988	4	6	991AA39G01	A39
8	0	9689A22G01	693	10	0	9689A91G01	754	3	0	991A939G01	939	5	5	991A989G01	989	2	8	991AA40G01	A40
0	6	9689A23G01	694	8	0	9689A95G01	755	9	0	991A940G01	940	2	6	991A990G01	990	4	6	991AA41G01	A41
8	2	9689A25G01	695	10	0	9689A97G01	756	4	6	991A941G01	941	0	6	991A991G01	991	4	6	991AA42G01	A42
0	10	9689A26G01	696	10	0	9689A99G01	757	2	8	991A942G01	942	8	2	991A992G01	992	4	6	991AA43G01	A43
0	8	9689A27G01	697	6	4	991A218G01	218	10	0	991A943G01	943	4	6	991A993G01	993	10	0	991AA44G01	A44
4	6	9689A28G01	698	1	3	991A219G01	219	8	2	991A944G01	944	2	8	991A994G01	994	10	0	991AA45G01	A45
4	6	9689A29G01	699	10	0	991A220G01	220	4	6	991A945G01	945	0	5	991A995G01	995	0	10	991AA46G01	A46
10	0	9689A31G01	700	10	0	991A221G01	221	4	6	991A946G01	946	10	0	991A996G01	996	4	6	991AA47G01	A47
10	0	9689A32G01	701	10	0	991A222G01	222	8	2	991A947G01	947	4	6	991A997G01	997	4	6	991AA48G01	A48
4	6	9689A33G01	702	10	0	991A223G01	223	4	6	991A948G01	948	10	0	991A998G01	998	4	6	991AA49G01	A49
2	8	9689A34G01	703	10	0	991A224G01	224	8	2	991A949G01	949	10	0	991A999G01	999	10	0	991AA50G01	A50
10	0	9689A36G01	704	10	0	991A225G01	225	8	2	991A950G01	950	10	0	991AA01G01	A01	10	0	991AA51G01	A51
10	0	9689A37G01	705	8	2	991A226G01	226	3	7	991A951G01	951	6	4	991AA02G01	A02	10	0	991AA52G01	A52
6	4	9689A38G01	706	10	0	991A227G01	227	0	6	991A952G01	952	10	0	991AA03G01	A03	0	6	991AA53G01	A53
10	0	9689A40G01	707	10	0	991A228G01	228	10	0	991A953G01	953	0	8	991AA04G01	A04	10	0	991AA54G01	A54
4	6	9689A41G01	708	10	0	991A229G01	229	10	0	991A954G01	954	10	0	991AA05G01	A05	4	0	991AA55G01	A55
6	4	9689A42G01	709	10	0	991A230G01	230	10	0	991A955G01	955	10	0	991AA06G01	A06	10	0	991AA56G01	A56
0	10	9689A43G01	710	6	4	991A231G01	231	10	0	991A956G01	956	10	0	991AA07G01	A07	6	0	991AA57G01	A57
3	7	9689A45G01	711	10	0	991A232G01	232	10	0	991A957G01	957	0	10	991AA08G01	A08				
10	0	9689A47G01	712	2	8	991A233G01	233	6	4	991A958G01	958	10	0	991AA09G01	A09				
10	0	9689A49G01	713	4	6	991A234G01	234	1	9	991A959G01	959	10	0	991AA10G01	A10				
10	0	9689A50G01	714	6	4	991A235G01	235	8	2	991A960G01	960	10	0	991AA11G01	A11				
4	6	9689A53G01	716	4	6	991A236G01	236	10	0	991A961G01	961	4	6	991AA12G01	A12				
1	4	9689A54G01	717	2	8	991A237G01	237	10	0	991A962G01	962	8	2	991AA13G01	A13				
3	6	9689A56G01	718	4	6	991A238G01	238	10	0	991A963G01	963	10	0	991AA14G01	A14				
3	6	9689A57G01	719	4	6	991A239G01	239	10	0	991A964G01	964	10	0	991AA15G01	A15				
10	0	9689A59G01	727	4	6	991A240G01	240	10	0	991A965G01	965	10	0	991AA16G01	A16				
10	0	9689A60G01	728	8	2	991A241G01	241	10	0	991A966G01	966	10	0	991AA17G01	A17				
10	0	9689A61G01	729	10	0	991A302G01	302	8	2	991A967G01	967	10	0	991AA18G01	A18				
10	0	9689A62G01	730	10	0	991A303G01	303	10	0	991A968G01	968	10	0	991AA19G01	A19				
10	0	9689A63G01	731	6	4	991A334G01	334	6	4	991A969G01	969	0	10	991AA20G01	A20				

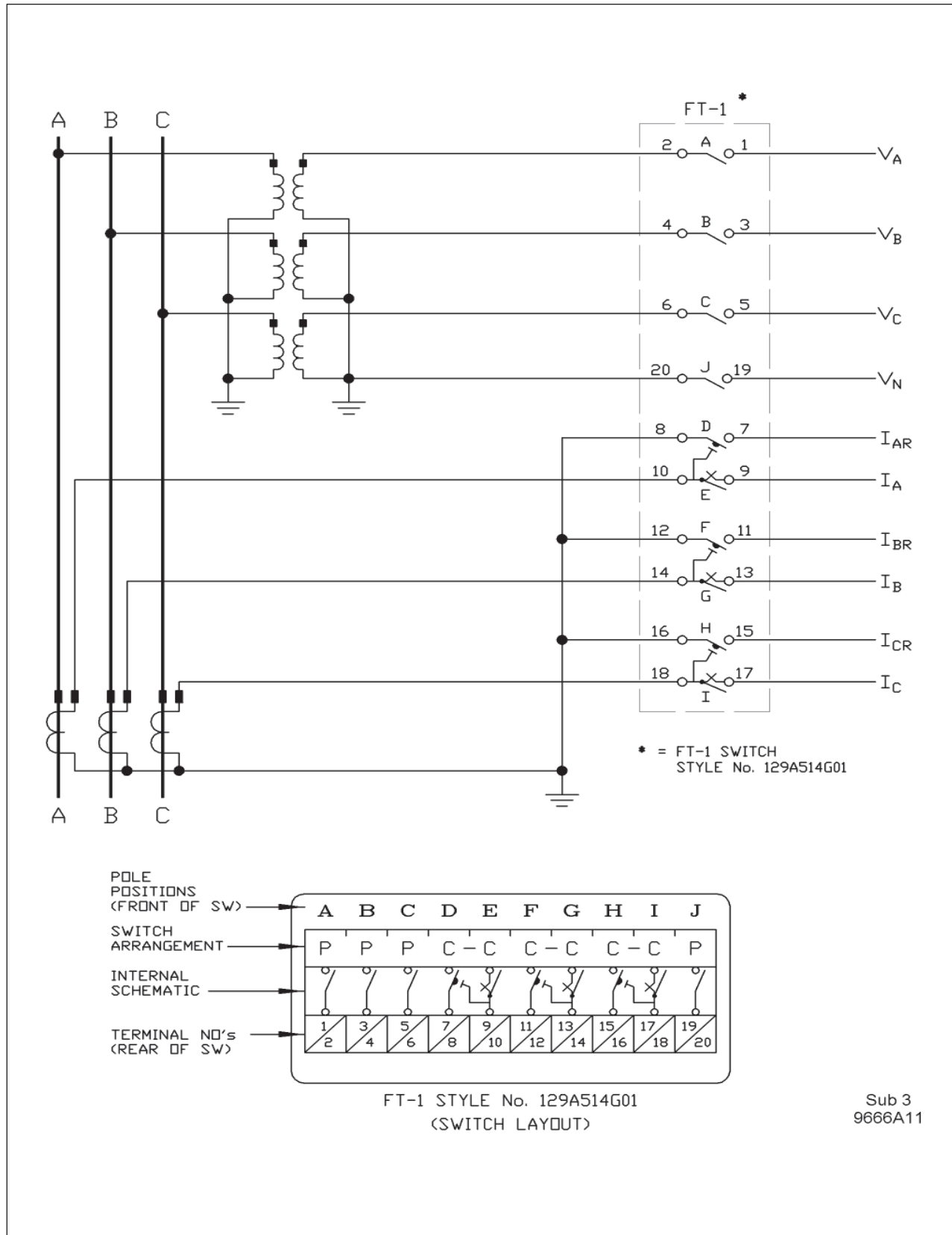

Figure 1: Typical FT-1 connection diagram



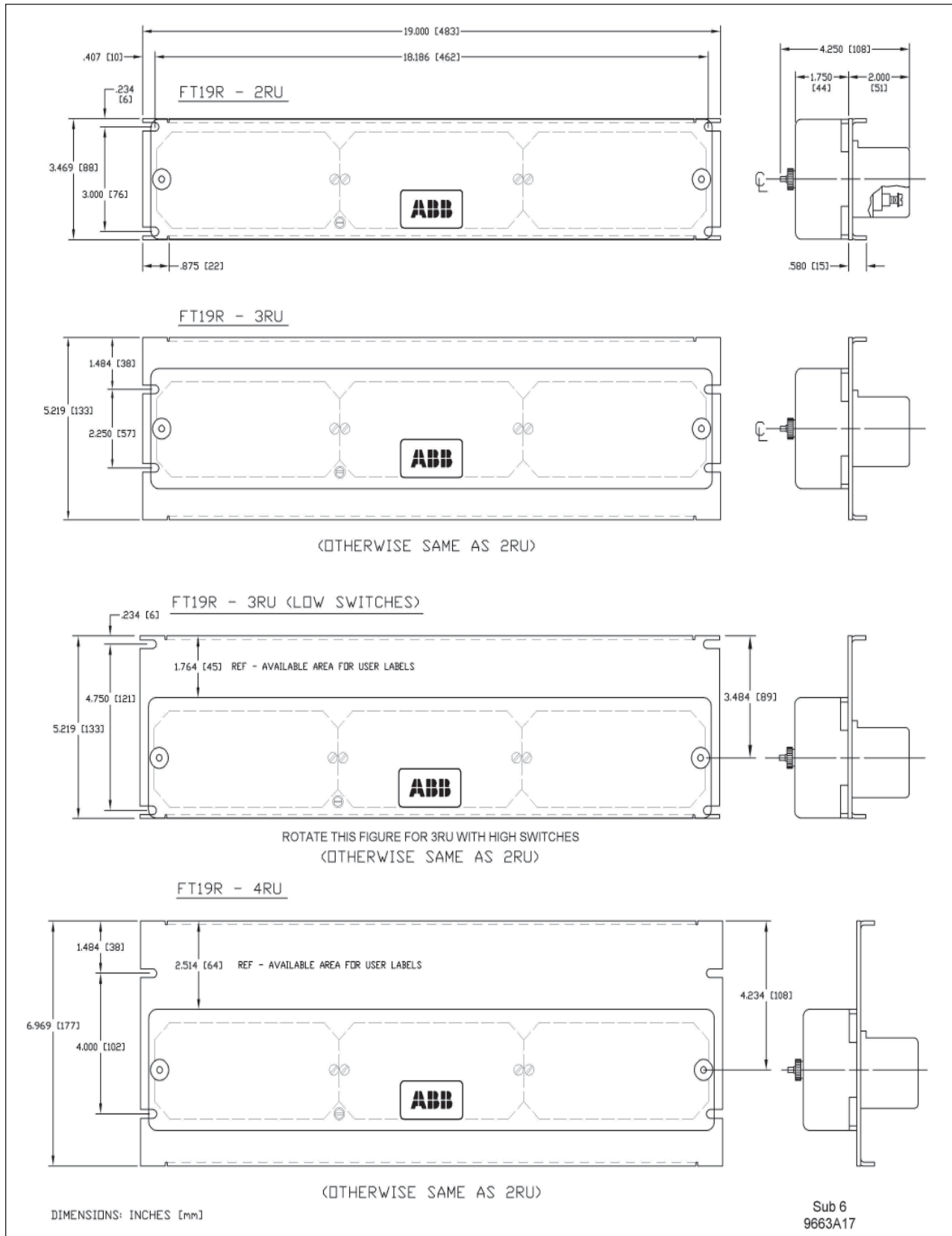

Figure 2: FT-19R dimensions and layout for rack mounting

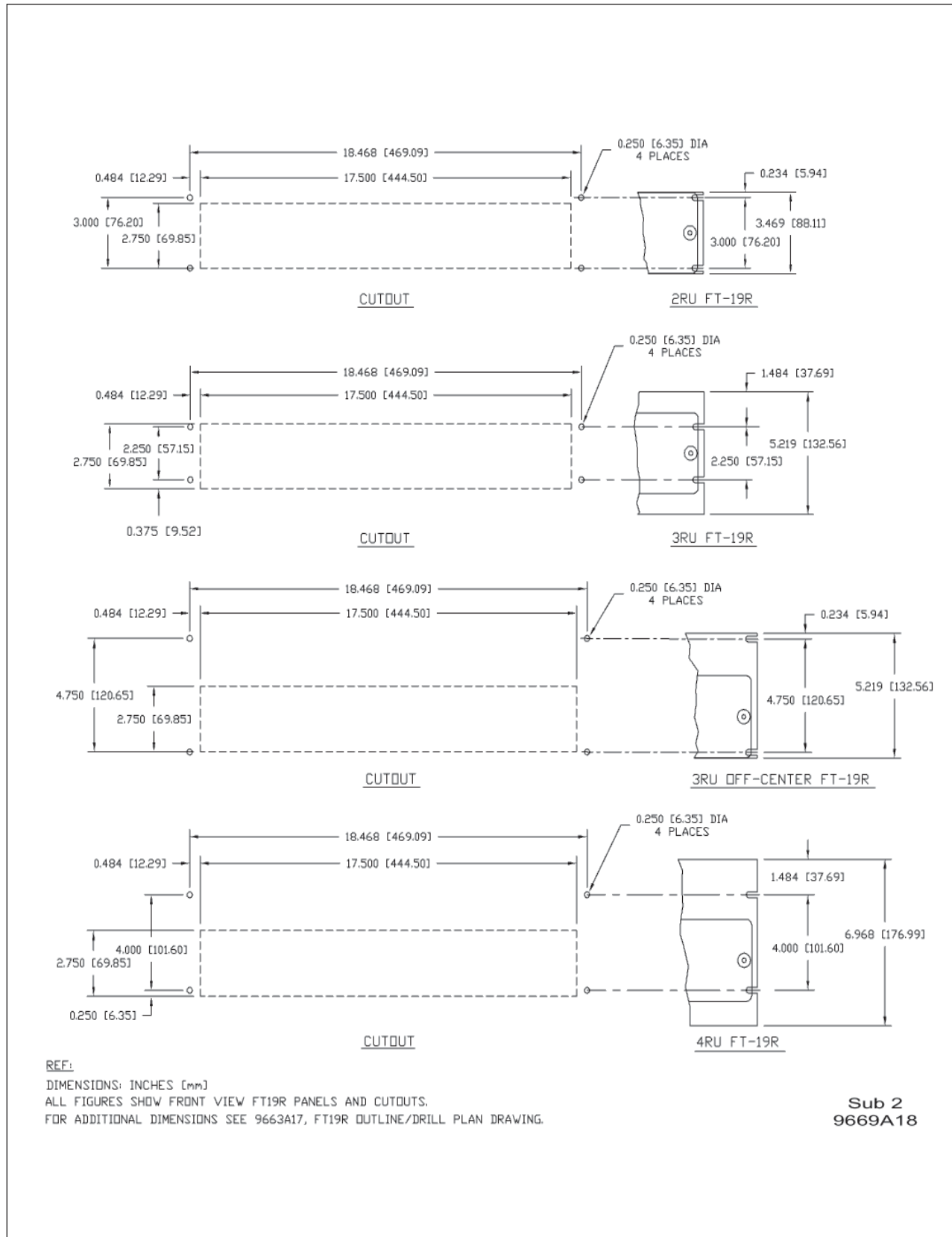

Figure 3: Outline and drilling plan for FT-19R with flat panels (no rolled edges), rack or flush mounting for panels or cabinets

**WEIGHT**

<b>FT Product</b>	<b>Net Lbs. (kg)</b>	<b>Shipping Lbs. (kg)</b>
FT-19R all 3 Switches Installed on Steel Plate	7.0 (3.18)	9.0 (4.08)
FT-1 Switch	1.75 (.79)	3.25 (1.47)
FT-1 Extended	2.75 (1.25)	3.75 (1.7)
In Service Series Test Plug	1.5 (.68)	3.0 (1.4)
Separate Source Test Plug	1.5 (.68)	3.0 (1.4)
Individual Current Circuit Test Plug	.1 (.045)	1.0 (.45)

**REFERENCE**

For more information on FT-1 Switches, Test Plugs, and related accessories, see Descriptive bulletin 41-077, Flexitest Switch Type FT-1 and FT-1X.

# Contact us

## **ABB Inc.**

### **Distribution Automation**

4300 Coral Ridge Drive

Coral Springs, Florida 33065

Telephone: +1 954-752-6700

Fax: +1 954-345-5329

[www.abb.com/substationautomation](http://www.abb.com/substationautomation)

All sales are subject to ABB Inc.  
General Terms and Conditions of Sale.

While every effort has been made to  
assure accuracy, the information in this  
document is subject to change without  
notice.

© Copyright 2008, 2009 ABB Inc. All  
rights reserved.

