



Type
<b>T2</b>

<b>I<sub>max</sub> : 40 kA</b>

<b>U<sub>p</sub> : 1,4 kV</b>
System
<b>TN-S: 230/400 V</b>

<b>IEC 61643-11</b> <b>EN 61643-11</b>

Type 2 SPD's are designed to discharge the currents generated by indirect lightning strikes causing induced or conducted overvoltages on the power distribution network.

They are characterized by an 8/20µs waveform (I<sub>max</sub>). Higher is the I<sub>max</sub>, more powerful they are.

They are installed in the main distribution switchboard but also in sub-distribution board.

They have a low residual voltage U<sub>p</sub> often compatible with the withstand voltage of the equipment to protect.

Thanks to the patented Safety Reserve system, you can extend the lifespan of the installation plan maintenance to reduce downtime risk.





- Patented QuickSafe® technology
- Safety Reserve system
- Din rail mounting
- Pluggable
- Improved safety
- Back up protection up to 160 A Fuse or 125 A Mcb

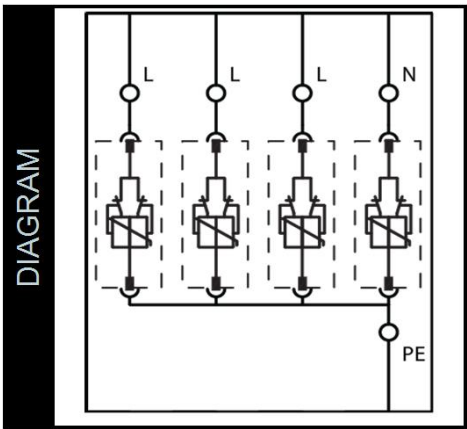
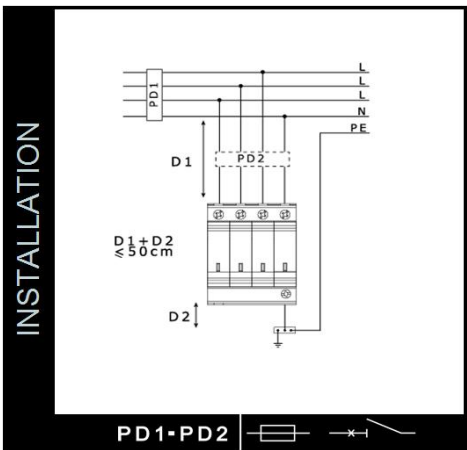

Key characteristics			
Protection mode	L-N/L-PE/N-PE		
Number of protected lines	4		
Test class	II		
Integrated thermal disconnecter	Yes		
End of life indicator	Yes		
Safety reserve	Yes		
Electrical characteristics			
Nominal discharge current	I <sub>n</sub> (8/20)	kA	20
Maximal discharge current	I <sub>max</sub> (8/20)	kA	40
Impulse current	I <sub>imp</sub> (10/350)	kA	2
Maximal continuous operating voltage	U <sub>C</sub>	V	275
Maximal continuous operating voltage d.c.	U <sub>C d.c.</sub>	V	350
Type of current / frequency		Hz	a.c. 47-63
Voltage protection level at I <sub>n</sub>	U <sub>p</sub> (L-PE)	kV	1,4
Voltage protection level at I <sub>n</sub>	U <sub>p</sub> (L-N)	kV	2,8
Voltage protection level at I <sub>n</sub>	U <sub>p</sub> (N-PE)	kV	1,4
Short circuit withstand	I <sub>SCCR</sub>	kA	100
Total current	I <sub>TOTAL</sub>	kA	160
Follow current interrupted	I <sub>fi</sub>	kA	- / -
Ground residual current	I <sub>PE</sub>	µA	<1000
TOV withstand (L-N : 5s / N-PE : 200 ms)	U <sub>T</sub>	V	337 / -
Voltage Combination Wave	U <sub>OC</sub>	kV	-
Required thermal/back up protection			
Curve B or C Circuit breaker	A		≤ 125
gG - gL fuse	A		≤ 160
Comments			
Mechanical characteristics			
Dimensions	H x W x D	mm	88x71.2x69.4
Wire range : Solid wire		mm <sup>2</sup>	2.5 ... 35
Wire range : Stranded wire		mm <sup>2</sup>	2.5 ... 25
Stripping length		mm	12.5
Packing quantities		piece	Per 1
Miscellaneous characteristics			
Maximal altitude	m		2 000
Weight	g		600
Response time	ns		<25
Fire resistance according to UL 94			V-0
Replacement cartridges			
Phase / Product ID	OVR T2 40-275s C QS		2CTB815704R2600
Neutral / Product ID	OVR T2 40-275s C QS		2CTB815704R2600

CHARACTERISTICS

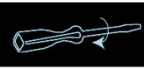

	 - 40 to +80 °C	 2,8 N.m	
	 93 %		

