Auxiliary, signaling and tripping relays RXMA 1, RXMA 2, RXMM 1, RXMS 1, RXSF 1, RXME 1, RXME 18, RXMH 2 and RXMT 1

**RXMA 1****RXMS 1****RXSF 1****RXMM 1****RXMH 2****RXME 1**

Contents

1. Features.....	3
2. Application.....	3
3. Functions which can be obtained with additional components.....	4
4. Design.....	10
5. Technical data.....	17
6. Diagrams and ordering.....	20
7. References.....	28
8. Document revision history.....	28

1. Features

- Suitable for tripping, blocking, interlocking, signaling etc. in protection, control and industrial systems
- Various ratings and contact configurations
- High voltage insulation
- Screen protected and dust-proof with a transparent plastic cover
- Low power consumption
- Heavy-, medium or light duty operation and long mechanical life
- Indication flags
- High resistance to shock and vibration
- Ultra high and high speed operation, down to 1,5 ms
- Up to 15 contacts in one relay

2. Application

The relays are intended for installations where high operating requirements exist, on operating time, contact rating (heavy breaking duty) or else where normal relays of industrial type are not suitable.

The relays are especially suitable in protection and control circuits. Models exist that are very suitable for high corrosive atmosphere or seismic areas. Tripping, interlocking and multiplying functions are easily achieved with single relays or combinations of relays.

Special requirements can be met by using different contact types, twin contacts, bridge contacts or dry-reed contacts.

Types RXMA 1, RXMA 2 and RXMM 1 are used as position repeat relays, as interposing relays in control equipment and as output relay in protection relays.

Type RXMM 1 is a space saving relay with two coils, each with 3 contacts for applications where few contacts are needed.

Type RXMS 1 is particularly suitable as tripping relay due to its extremely short operate time. A special variant, which is not influenced by capacitive discharges at earth fault and which also has improved insulation across open contact, is available for heavy applications where high disturbance immunity is required.

RXMS 1, in combination with heavy-duty relays, is used in high speed tripping assemblies as accessories to protection relays.

Type RXSF 1 is a signal flag relay intended for use as operation indicator. A zero voltage type is available and can be used to supervise dc supply voltages.

Types RXME 1 and RXME 18 are used where a low number of heavy duty contacts are required e.g. as trip relay. RXME 18 is a RXME 1 with an operating flag indicator.

Type RXMH 2 is used when many heavy duty contacts are required. It can be provided with an operating flag indicator, as an option.

3. Functions which can be obtained with additional components

Auxiliary relays can be used in a number of ways with different accessories to obtain a variety of types of operation. A few typical circuits are shown below.

Plug-in units with e.g., diodes, resistors and capacitors are shown in other documents (see [Section 7](#)). Connection blocks type RTXE for attachment to the pocket of the rear side of the terminal bases can be ordered from the same catalogue.

Drop-out time-lag with a diode

To obtain a dropout delay of a dc relay or to protect an electronic circuit against transients, a diode unit across the relay coil (R) can be used. Diode unit, type RXTDA 1, or terminal base mounted type RTXE can be selected.

If the dropout time (t) in the table is too long it can be reduced with a resistor (r) connected in series with the diode.

Type	Typical dropout time, t, with diode ¹⁾
RXMA 1	100-125 ms
RXMA 2	20 ms
RXMM 1	40 ms
RXMS 1 ²⁾	10 ms
RXME 1 RXME 18	35 ms
RXMH 2	60 ms

1) The deviation in dropout time from the values in the table can be considerable, due to numbers of contacts, inductance in the coil, depending on operating voltage etc.

2) The diode is to be connected to terminals 21-28.

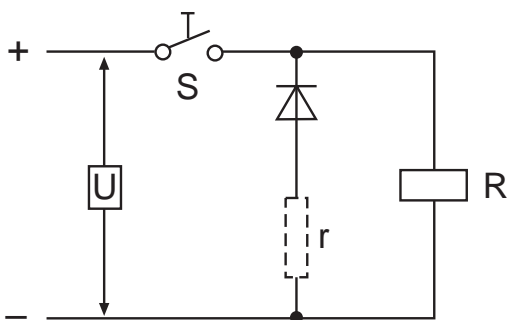

Drop-out delay can be achieved by connecting a parallel diode across the relay coil as shown. Please observe the polarities of the dc voltage and the diode.

When S makes the relay picks up instantaneously. When S breaks the relay drops out with a time lag caused by the diode.

Inductive transient protection

The diode also provides transient protection of the relay and also for the parallel connected devices by reducing the induced overvoltages (many kV's) caused by the inductance of the auxiliary relay upon disconnection from the dc supply when the energizing contact opens.

Transient protection (and shorter drop-out delays) may also be achieved by using a parallel connected resistor, thermistor or varistor across the relay instead of the diode. These components are available for mounting directly in the rear pocket of the terminal base using type RTXE component blocks.

Pick-up time-lag using a thermistor

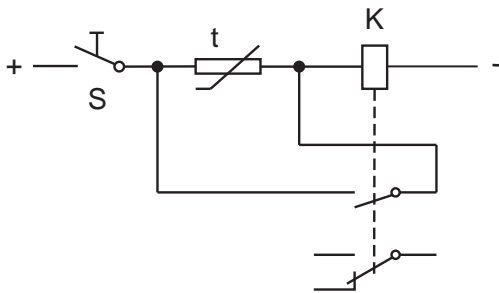

When S makes, the current heats the thermistor t and its resistance drops as its temperature increases. When the current through K reaches the pick-up value, the relay picks up and the thermistor is short-circuited by a make contact on the relay.

Pick-up and drop-out time-lag using a capacitor

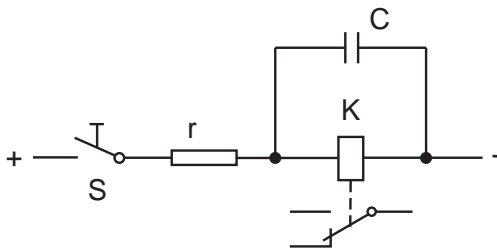

When S makes, the pick-up time is determined by the values r, K and C. The relay picks up when C is sufficiently charged and the time lag upon drop-out is caused by C discharging through K after S breaks.

Pick-up time-lag using a capacitor (normal drop-out)

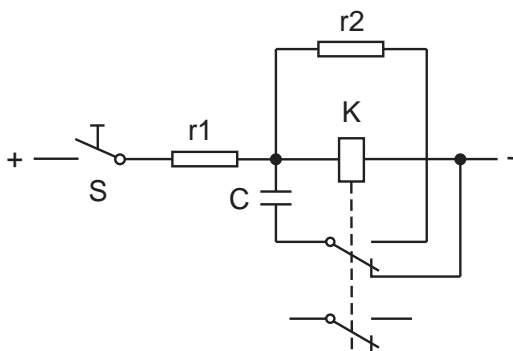

The pick-up time is determined by the values of r1, K and C. When the relay has picked up C is discharged across r2 and normal drop-out is obtained.

Impulse storing circuit (impulse lengthening)

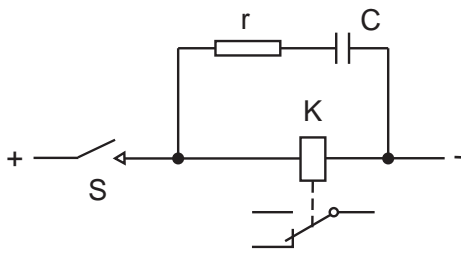

When the impulse contact S momentarily makes, the relay picks up and remains picked up for a period the length of which is determined by r, K and C.

Impulse shortening circuit

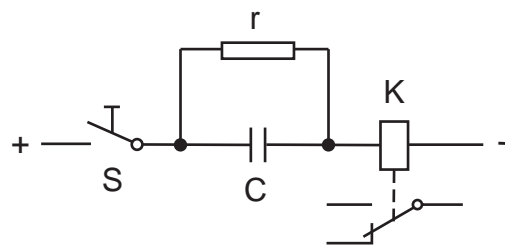

When S makes, the relay K picks up instantaneously and remain a picked up until C is sufficiently charged. The relay then drops out, since the current through r and K falls below the relay drop-out value. (S remains closed all the time).

RTXV Control unit

High-speed auxiliary relays can at earth-fault in unearthed DC voltage systems give unwanted operation.

To avoid the risk that the voltage caused by the earth-fault causes unwanted operation on auxiliary relays, we have designed a control unit, type designated RTXV, to be connected in series with the terminal of the relay coil.

The control unit connects applied voltage to the relay only if the voltage is larger than 60-80% of the rated voltage of the unit. The voltage drop in the control unit is about 2 V.

The control unit is mounted in a component box, which in its turn can be mounted on the rear of the terminal base of COMBIFLEX relays.

For more information, see [Section 7](#).

Shorter pick-up times with separate series connected resistor

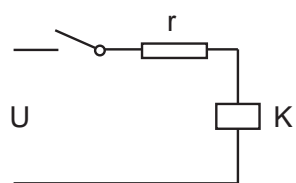

The operating time can be reduced for auxiliary relays by connecting a separate resistor – r in the diagram – in series with the relay coil K.

The connection reduces the L/R ratio, i.e. the time constant for the drawn relay coil operating current.

The pick-up time and characteristics of the series resistor for a number of types of relays are listed in the table 1. The dispersion of the pick-up time is about $\pm 20\%$ at rated voltages and up to $\pm 50\%$ if considering voltage range variations.

The drop-out time of the relay will be approximately the same as for a relay without the series resistor.

Table 1. Dimensioning the series resistor for obtaining shorter pick-up times

D.c. supplied auxiliary relays with supply voltage U = 110, 125, 220 and 250 V.

(The table contains information also for some non-standard voltages for relays available on request.)

Relay		Pick-up time ¹⁾		U = 110 V				Max. permitted connection time
type	operating value group	Break contact ms	Make contact ms	Relay with rated voltage V	Series resistance , r Ω	Wattage of r W	Wattage of r + R W	
RXME 1		10 7	20 15	24 12	630 400	9 21	13 25	5 min. 5 min.
RXMH 2		10 6	25 15	24 12	500 160	14 48	19 60	Cont. 5 min.
RXMA 1	1-3	5	10	12	2000	5	6	Cont.
RXMA 2	6	8	13	12	330	25	30	Cont.
Relay		Pick-up time ¹⁾		U = 125 V				Max. permitted connection time
type	operating value group	Break contact ms	Make contact ms	Relay with rated voltage V	Series resistance , r Ω	Wattage of r W	Wattage of r + R W	
RXME 1		10 7	20 15	24 12	750 450	11 25	15 30	5 min. 5 min.
RXMH 2		10 6	25 15	24 12	600 200	17 54	21 65	Cont. 5 min.
RXMA 1	1-3	5	10	12	2250	6	7	Cont.
RXMA 2	6	8	13	12	400	28	33	Cont.
Relay		Pick-up time ¹⁾		U = 220 V				Max. permitted connection time
type	operating value group	Break contact ms	Make contact ms	Relay with rated voltage V	Series resistance , r Ω	Wattage of r W	Wattage of r + R W	
RXME 1		10 7	20 15	48-55 24	2500 1600	9 21	13 25	5 min. 5 min.
RXMH 2		10 6	25 15	48 24	2000 630	15 50	19 62	Cont. 5 min.
RXMA 1	1-3	5	10	24	8000	5	6	Cont.
RXMA 2	6	8	13	24	1600	22	26	Cont.

Relay		Pick-up time ¹⁾		U = 250 V				Max. permitted connection time
type	operating value group	Break contact ms	Make contact ms	Relay with rated voltage V	Series resistance , r Ω	Wattage of r W	Wattage of r + R W	
RXME 1		10 7	20 15	48-55 24	3000 1800	11 26	15 30	5 min. 5 min.
RXMH 2		10 6	25 15	48 24	2300 750	18 57	22 69	Cont. 5 min.
RXMA 1	1-3	5	10	24	9000	6	7	Cont.
RXMA 2	6	8	13	24	1800	26	30	Cont.

1) The dispersion of the pick-up time is about $\pm 20\%$, $\pm 50\%$ if considering voltage range variations

Table 2. Coil resistance, relays with twin contacts

(The table contains information also for some non-standard voltages for relays available on request.)

Rated voltage V	Relays with twin contacts								
	RXMA 1	RXMA 2, dc	RXMM 1	RXMS 1, dc			RXMS 1, dc		
	dc op. v. gr. ¹⁾ 1-3	op. v. gr. ¹⁾ 6	dc	Variant A, E			Variant B		
	Coil resistance Ω			Coil resistance Ω	Series resistance Ω	Total resistance Ω	Coil resistance Ω	Series resistance Ω	Total resistance Ω
12	110	70	140	6,3	18	23,3	21	27	48
24	460	270	460	21	72	93	82	110	192
30-36	625	375	735	-	-	-	-	-	-
36	-	-	-	40	156	196	210	240	450
48	-	-	-	108	320	428	360	410	770
48-55	2020	1070	2050	-	-	-	-	-	-
55	-	-	-	108	360	468	465	570	1035
110	-	-	-	380	1430	1810	1920	2070	3990
110-125	9680	6120	10800	-	-	-	-	-	-
125	-	-	-	610	2000	2610	2450	2900	5370
220	-	-	-	1520	5700	7220	6090	8420	14510
220-250	39200	19300	40000	-	-	-	-	-	-
250	-	-	-	1920	8000	9920	8670	10700	19370

1) op. v. gr. = Operating value group

Table 3. Coil resistance, relays with bridge contacts

Rated voltage	Relays with bridge contacts		
	RXME 1 RXME 18		RXMH 2
	dc	dc	ac 50 and 60 Hz
	Coil resistance Ω		
12	78	39	-
24	301	155	39
48	-	564	-
48-55	1130	-	-
55	-	700	194
110	-	2930	700
110-125	5780	-	-
125	-	3610	-
127	-	-	890
220	-	10600	2930
220-250	23300	-	-
250	-	13500	-
380	-	-	8520

Table 4. Coil resistance, relays with single contacts

Rated voltage V	Relays with single contacts, RXMT 1					
	Symbol No.110		Symbol No. 111		Symbol No. 112	
	Terminal marks of coils					
	11-12	21-22	11-12	21-22	11-12	21-22
	Coil resistance Ω					
12-15	670	670	670	670	670	670
24	2600	2600	2600	2600	2600	2600
48-60	6800	6800	6800	6800	6800	6800
110-125	16800	16800	16800	16800	16800	16800

4. Design

The auxiliary relays in the COMBIFLEX system permit interchanging between various types of relays chiefly because the coil terminals are always connected to the same terminal on the plug-in base of the relay. Relays having the same contact symbol can be interchanged without alteration of the connection.

The contact elements are made of silver, however, gold elements on the contacts can sometimes be necessary, for example in sulfuric atmospheres or when the voltage in the contact circuit is lower than 10 V and the current lower than 10 mA.

Each relay has a dust-tight cover, except the RXMS variants A and E, and is intended to be mounted on a terminal base. Terminal bases are available in four sizes. The relays are fixed to the terminal bases with two or four Phillips No. 2 cross-head screws. Each relay cover has a hole covered by a removable plastic plug with the exception of RXME 18, RXSF 1 and RXMT 1. Through the hole the armature of the relay can be activated. Relays with indicating flags have a resetting knob accessed from the outside of the cover.

The relays are marked with the type designation, Ordering No., rated voltage, and where applicable, the symbol of the relay is also shown.

All dc supplied relays, with the exception of RXMS 1 and RXMT 1, can be supplied with full-wave or half-wave rectified ac.

For supply with full-wave rectified ac, select relays with a rated voltage equivalent to the supply voltage.

For supply with half-wave rectified ac, a diode in addition to the series diode is to be connected in parallel across the coil and the rated voltage of the relay is to be equivalent to half the supply voltage. If transients are expected in the supply voltage, these determine the choice of matching diodes.

Smoothing capacitors are unnecessary in both cases.

The auxiliary relays will operate within a range of 80-110% of the rated voltage. If the rated voltage is given as a voltage range, e.g. 110-125 V, the relays will operate within a range of 80-110 % of each rated voltage between 110 and 125 V. Permissible temperature range is given in the data table.

Relays with twin contacts

Auxiliary relays used in automatic equipment for control and regulation must have a very high degree of contact reliability even at lower voltages. Auxiliary relays with twin contacts fulfil this requirement. A twin contact has two contact elements on each contact member and each of these makes independent and simultaneous contact with the corresponding element on the other contact member. This gives two parallel current paths and greatly reduces the risk of contact failures. The contact sets have contact levellers of wear-resistant material with a low coefficient of expansion. This means that the correct contact force is always obtained even in contact units containing numerous contact springs. Type RXMA, RXMM, RXMS and RXSF contain twin contacts.

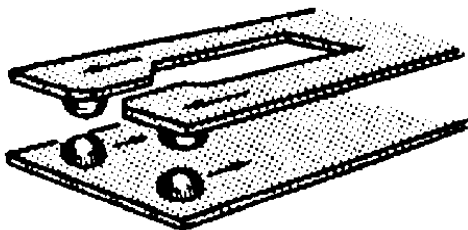

Figure 1. Twin contact

RXMA 1

This relay is designed for dc supply. The outstanding features of this relay are its low power consumption and long mechanical life.

A few variants of RXMA 1 is ac operated with a valid frequency between 50-60 Hz and rated voltage of 115 or 230 V. A half-wave rectifier is built in, connected in parallel across the coil.

RXMA 2

This relay is a variant of RXMA 1, with a larger terminal plug-in plate, and a greater number of contacts.

The relay occupies two seats.

RXMA 1 and RXMA 2 have one, two or three sets of contact stacks. The system voltage across one stack of contacts must not exceed 300 V dc or 250 V ac. The corresponding voltage between contact stacks must not exceed 600 V dc or 500 V ac.



RXMM 1

The relay is designed for dc supply. Two smaller type relays are included in RXMM 1. These relays can each have up to 3 contacts (6 contact springs). Relay RXMM 1 with different rated voltages for the two relays is also available as an option.

RXSF 1

The unit contains one or two smaller relays with three contacts and red indicating flags. The flags are reset manually with an external knob or automatically when the dc is switched off.

The RXSF 1 is also available as loss-of-voltage relay. The indicating flag is always automatically reset in this variant.

There are DC voltage and DC current operated versions of the RXSF 1 relay. See [Section 6](#). The current operated relay may e.g. be used to indicate that breaker trip coil current has flown, i.e. as a series trip current flag (target).

SCADA Interposing Relay type RXSF 1

Interposing relays for SCADA equipment must not misoperate due to induced AC overvoltages that may occur as a result of a relatively long distance between the RTU and the remote control panel. Such a misoperation may lead to maloperation of breaker or isolator open / close commands.

There is a variant of the well proven relay RXSF 1 that may be used to reduce the risk of such a misoperation. The RXSF 1 is designed to reject induced AC voltages. The SCADA interposing version of RXSF 1 is in addition designed to provide a higher operating current in order to even further increase security against maloperation due to induced AC voltage interference.

RXMS 1

This relay is designed for dc supply. It has a very short pick-up time, down to 4 ms for a make contact (variant A, 7 W). Variant B is a low power variant (3 W) with 1,5 ms longer pick-up time.

Variant E (7 W) is safe for capacitive discharge through the coil at dc earth faults. It has also a larger contact gap, which can withstand 2 kV test voltage.

Because of the high power consumption in variants A and E these variants should not be continuously energized.

The relay has an additional terminal (28) brought out between the coil and the series resistor. This terminal is intended for dropout delay by connecting a diode across the coil.

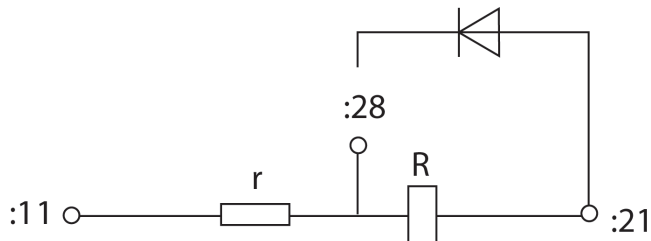

Figure 2. RXMS 1

Relays with bridge contacts

Auxiliary relays which are to be used as tripping relays or as operating relays should have a high breaking capacity, good contact reliability and be free from risk of contact welding. These qualities are possessed by relays with bridge contacts.

The contacts have two fixed contact members and a moving bridge-shaped member. This design with two breaking points in series gives high breaking capacity.

The moving contact member is designed so that a considerable sliding motion is obtained between the contact elements during closing; this increases contact reliability and reduces the risk of welding.

Types RXME 1, RXME 18 and RXMH 2 contain bridge contacts.

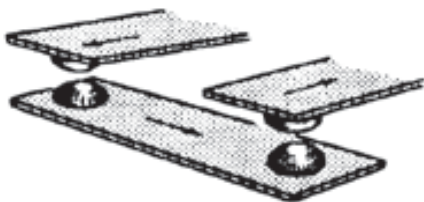

Figure 3. Bridge contact

RXME 1

This relay is designed for dc supply. It has two or four contacts.



RXME 18

The relay consists of an RXME 1 relay fitted with a red indicating flag. The flag becomes visible when the armature picks-up and remains visible after drop-out. The flag is manually reset by means of a resetting knob in the cover. The relay has two contacts.



RXMH 2

This relay has eight heavy duty contacts and can be fitted with an indicating flag which becomes visible when the armature picks-up and remains visible after drop-out. The flag is manually reset by means of a resetting knob in the cover. For checking the operation the relay has a push-button which is accessible through a hole in the cover. The relay occupies two seats.

Relays with single contacts (dry-reed relays)

In certain cases auxiliary relays are used in a highly corrosive atmosphere or under other conditions where special contacts are required, e.g. for low voltages and currents such as in automatic control circuits with static components. For such applications, auxiliary relays with built-in special contacts, e.g. dry-reed elements should be used. A dry-reed element has one fixed and one moving contact of magnetic material. If the coil, which encircles a dry-reed element with a make contact, is energized, magnetic flux flows through the contact which then closes. When the coil is de-energized the contact opens.

In dry-reed relays with break contacts the coil also encircles a permanent magnet of which the flux holds the contact closed. When the coil is energized the flux of the permanent magnet is counter-balanced and the contact opens. When the coil is de-energized the contact is reclosed by the permanent magnet. This implies that dry-reed relays with break contacts are dependent on polarity, and the coil must be connected in accordance with the symbols in the ordering table.

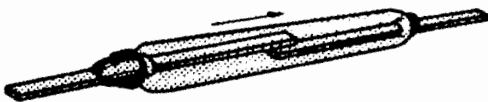

Figure 4. Single contact

RXMT 1

RXMT 1 has 2 dc-supplied dry-reed relays, each with one make or break contact (dryreed element). The relay is very fast and has a pick-up time of < 1,5 ms.

RXMT 1 should not be positioned alongside relays which have powerful magnets as they may cause RXMT 1 to remain in the pickedup position.



Tripping assemblies

Single auxiliary or flag relays of any model may be used in tripping circuits, depending on requirements. Specially designed combinations of relays mounted on terminal bases and apparatus bars are available. These tripping units combine an ultra-high speed relay, type RXMS1 and a heavy duty relay for carrying and breaking high currents. Combinations with latching relays or time relays for prolonged trip pulse and delayed resetting are available.

Trip and indication module

An auxiliary trip module for tripping from transformer protection device, e.g. Buchholz, temperature, etc., is available. It contains up to 10 inputs and the inputs are safe for capacitive discharge. A timer provides the required pulse length.

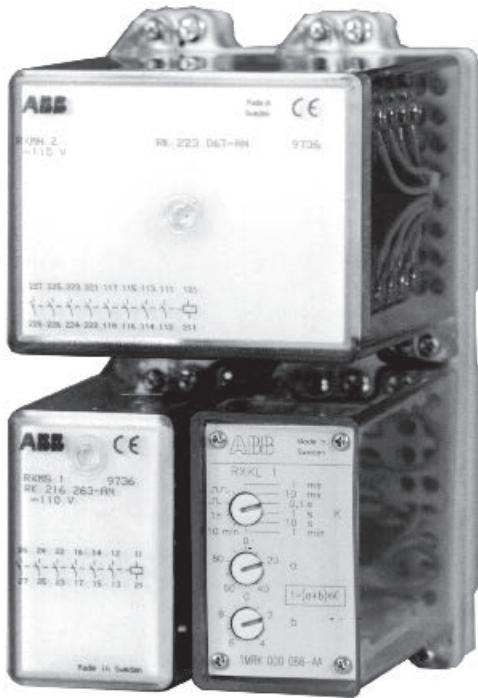

5. Technical data

Rated voltage U_r	see ordering table
Duty range in % of U_r RXMA 1	80-125%
other types	80-110% 1)

Operate values and times

Relay type	Pick-up value	Drop-out value	Pick-up time, typical values, make/break contact	Drop-out time, typical values, make/break contact
	% of Ur	% of Ur	ms	ms
RXMA 1, variant 025 dc	<23	>5	25/-	15/-
RXMA 1, variant 063, 064, 066, 072, 073, 074 dc	< 50	> 12	40/30	15/20
RXMA 1, variant 37 and 52 dc	< 40	> 10	25/15	15/20
RXMA 1, variant 37 and 52 ac	< 70	> 30	50/35	80/80
RXMA 2	< 80	> 15	30/20	5/10
RXME 1	< 80	> 10	35/25	5/15
RXMH 2 dc	< 80	> 20	60/35	25/35
RXMH 2 ac	< 80	> 20	60/35	60/60
RXMM 1	< 80	> 5	30/20	5/10
RXMS 1 var. A	< 80	> 5	4/3,5	2,5/5
RXMS 1 var. B	< 80	> 5	5,5/5	2,5/5
RXMS 1 var. E	55-80	> 10	8/6	3/5
RXMT 1	< 80	> 10	1,5/1,5	1,5/1,5
RXSF 1	< 80	> 5	30/20	5/10

Salient features of SCADA interposing relay type RXSF 1

- Immune to AC induced voltages across coil up to 150 V AC
- Higher burden than its counterparts
 - Minimum pickup current >25mA
 - Drop-off current >15mA
- Pickup voltage is 30% - 50% of Un
- Maximum permitted energizing time is 10 seconds every 2 minutes
- Drop-out voltage is more than 60% of Pickup voltage
- Self reset flag indicator
- 2 NO + 1 NC contacts

Technical data for current relay RXSF 1 is identical as for voltage relay except for following:

Operating time (closing contact) 2 xlr 4 xlr	< 14ms < 10ms
Minimum pulse time for the flag	50 ms
Operate value, % of Ir Thermal capacity, % of Ir Continuous with both relays energized	80-100 250 250%
Power consumption at I = Ir	0,1 W

Power consumption at U = Ur

RXMA 1 dc	1,1-1,3 W
RXMA 1 ac	appr 2 VA
RXMA 2	2,0-2,5 W
RXMM	1,1-1,3 W
RXSF	1,1-1,3 W
RXMS var. A ¹⁾	6-7 W
RXMS var. B	2,9-3,3 W
RXMS var. E ¹⁾	6-7 W
RXME	1,9-2,1 W
RXMH dc	3,7-4,6 W
RXMH ac	appr. 8 VA
RXMT	0,2-0,7 W

1) The RXMS variants A and E can be energized for max five minutes per interval of ten minutes

Contact data

Relay type	Max. system voltage dc/ac within a contact set	Current-carrying capacity (for already closed contact) 200 ms/1 s/cont.	Making and conducting capacity L/R > 10 ms 200 ms/1 s/ two contacts in parallel 1 s	Breaking capacity ac Cos ϕ > 0,1 max. 250 V	Breaking capacity dc L/R < 40 ms 24/48/110/220 V
	V	A	A	A	A
RXMA 1	300/250 (600/500 ¹⁾)	90/50/5	30/10/15	10	4/1,5/0,4/0,2
RXMA 2	300/250 (600/500 ¹⁾)	90/50/5	30/10/15	10	4/1,5/0,4/0,2
RXME 1	450/400	55/30/6	30/20/30	20 ²⁾	20/18/3/1 ³⁾
RXMH 2	600/500	135/75/10	30/20/30	20	20/20/6/1,2
RXMM 1	300/250	90/50/5	30/10/15	10	4/1,5/0,4/0,2
RXMS 1 var. A, B var. E	300/250 300/250	35/20/4 35/20/4	30/10/15 30/10/15	10 10	2,3/1,2/0,3/0,15 2,7/1,4/0,35/0,17
RXMT 1	250/250	3/2,5/2	2/2/-	0,6	1/0,5/0,2/0,1
RXSF 1	300/250	90/50/5	30/10/15	10	4/1,5/0,4/0,2

1) between sets of contacts

2) 10 A for RXME 1 with four contacts

3) 15/6/0,9/0,3 A for RXME 1 with four contacts

Permitted ambient temperature		-25°C – +55°C	
Dimensions	RXMA 1, RXME 1, RXMM 1, RXMS 1, RXMT 1, RXSF 1	2U 6C	
	RXMA 2, RXMH 2	2U 12C	
Weight	RXMA 2	0,5 kg	
	RXMH 2	0,7 kg	
	Other types	0,4 kg	
Insulation tests:	Dielectric test, 50 Hz, 1 min		
		RXME, RXMH	2,5 kV
		Other types	2,0 kV
	Impulse voltage test		
	1,2/50 μs, 0,5 J	5,0 kV	

6. Diagrams and ordering

Specify:

- Type
- Quantity
- Ordering No.
 - consists of a number and letters for the rated voltage, example RK 211 052-AN, see tables below.
- Ordering No. for flag and reset knob when applicable

Ordering number selection table RXMA 1

RK 211 025-..

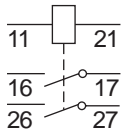

RK 211 037-..

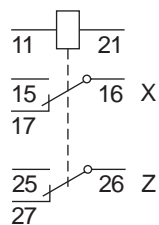

RK 211 052-..

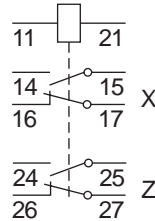

RK 211 063-..

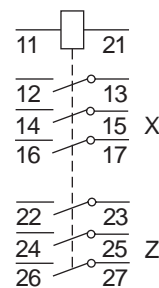

RK 211 064-..

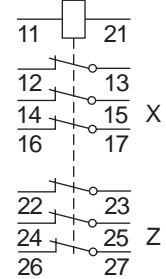

RK 211 066-..

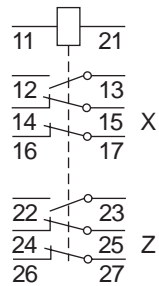

RK 211 072-..

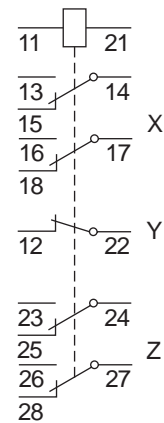

RK 211 073-..

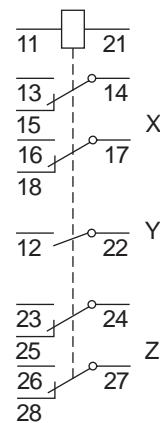

RK 211 074-..

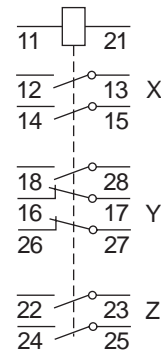

Letter selection table, DC rated voltage V

24	48-55	110-125	220-250
AD	AH	AN	AS

RK 211 037-..

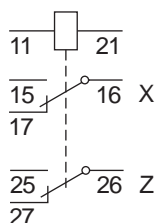

RK 211 052-..

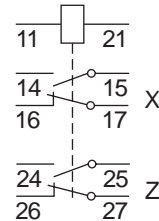

Letter selection table, AC rated voltage V, 50-60 Hz

115	230
BN	BS

Ordering number selection table RXMA 2

RK 211 185-..

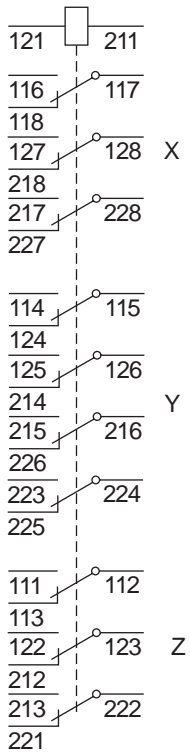

RK 211 186-..

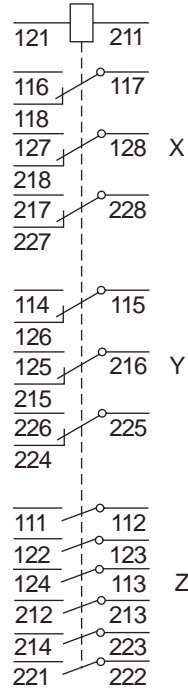

RK 211 188-..

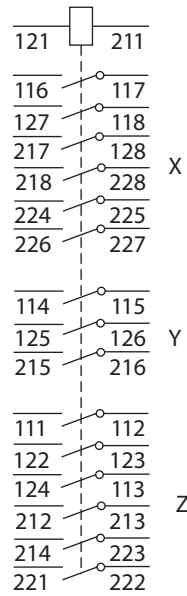

RK 211 189-..

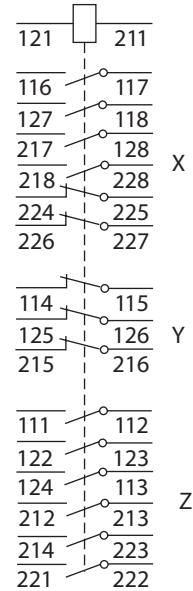

Letter selection table, DC rated voltage V

24	48-55	110-125	220-250
AD	AH	AN	AS

Ordering number selection table RXME 1

RK 221 025-..

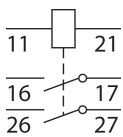

RK 221 026-..

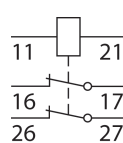

RK 221 027-..

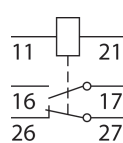

RK 221 052-..

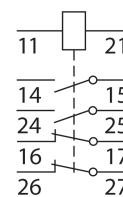

Ordering number selection table RXME 18

RK 221 825-..

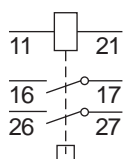

RK 221 826-..

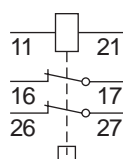

RK 221 827-..

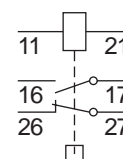

Letter selection table, DC rated voltage V

24	48-55	110	220-250
AD	AH	AN	AS

Ordering number selection table RXMH 2

RK 223 067-..

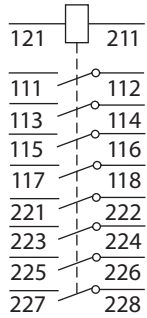

RK 223 068-..

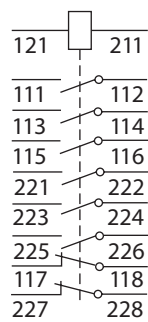

RK 223 069-..

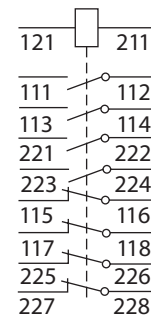

Letter selection table, rated voltage V

	24	48	110	120	125	127	220	250
DC	AD	AH	AN	-	AP	-	AS	AT
AC	-	-	EN	EC	-	EP	ES	-
15-60 Hz								

RXMH 2 with red flag and resetting knob
 Ordering No. for desired relay according to [Table 4](#).
 + RK 223 900-XA

No. selection table RXMM 1

RK 214 002-..

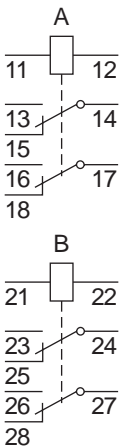

RK 214 003-..

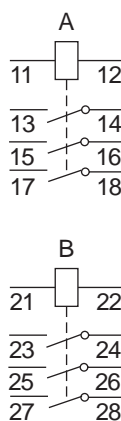

RK 214 004-..

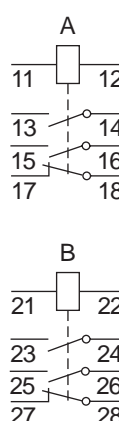

RK 214 005-..

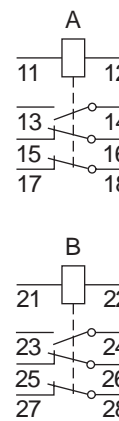

RK 214 006-..

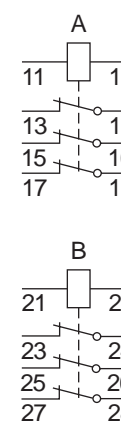

Letter selection table, DC rated voltage V

24	48-55	110-125	220-250
AD	AH	AN	AS

Ordering number selection table RXMS 1

Variant A: RK 216 237-.. RK 216 263-.. RK 216 265-.. RK 216 266-..
 Variant B: RK 216 037-.. RK 216 063-.. RK 216 065-.. RK 216 066-..
 Variant E: RK 216 463-.. RK 216 465-.. RK 216 466-..

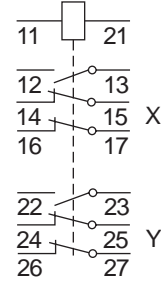
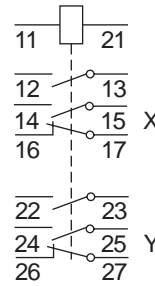
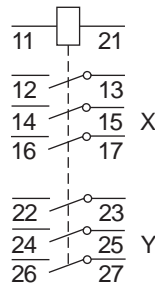
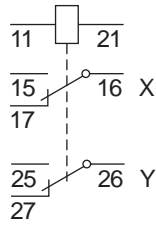

Letter selection table, DC rated voltage V

24	48	110	125	220	250
AD	AH	AN	AP	AS	AT

Ordering number selection table RXMT 1

RK 241 110-..

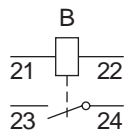
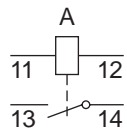

RK 241 111-..

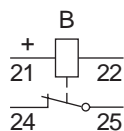
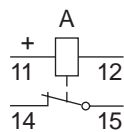

RK 241 112-..

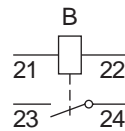
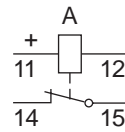

Letter selection table, DC rated voltage V

24	48-60	110-125
AD	AH	AN ¹⁾

1) This relay for 110-125 V can also be used at 220-250 V when it is connected via a resistor block type RTXE, RK 741 225-EF 18 kohm, 2W

Ordering number selection table RXSF 1

RK 271 006-..

RK 271 007-..

RK 271 016-..

RK 271 017-..

RK 271 018-..

RK 271 019-..

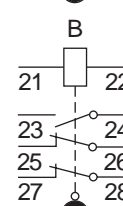
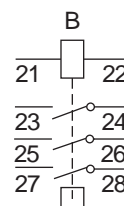
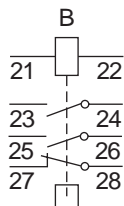
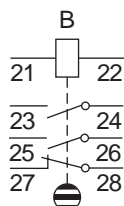
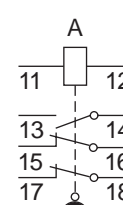
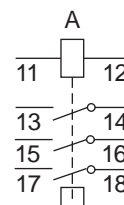
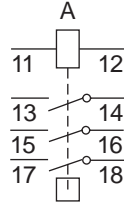
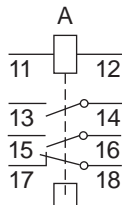
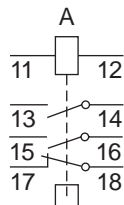
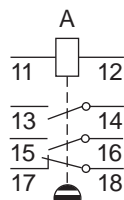

Flag is automatically reset when deenergizing the coil



Flag is to be reset



Loss of voltage relay

Voltage operated relay
Letter selection table, DC rated voltage V

24	48-55	110-125	220-250
AD	AH	AN	AS

Current operated relay
Letter selection table, DC rated Current A

0,2	1,0	2,0
HB	HF	HG

Other current operated variants on request

Scada interposing relay RXSF 1

Ordering Number: 1MRK 001 799-AP

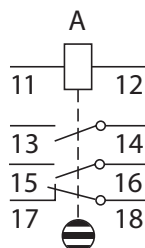

Rated voltage 125 V DC.

High-speed trip units

Specify:

- Ordering No.
- Auxiliary DC voltage

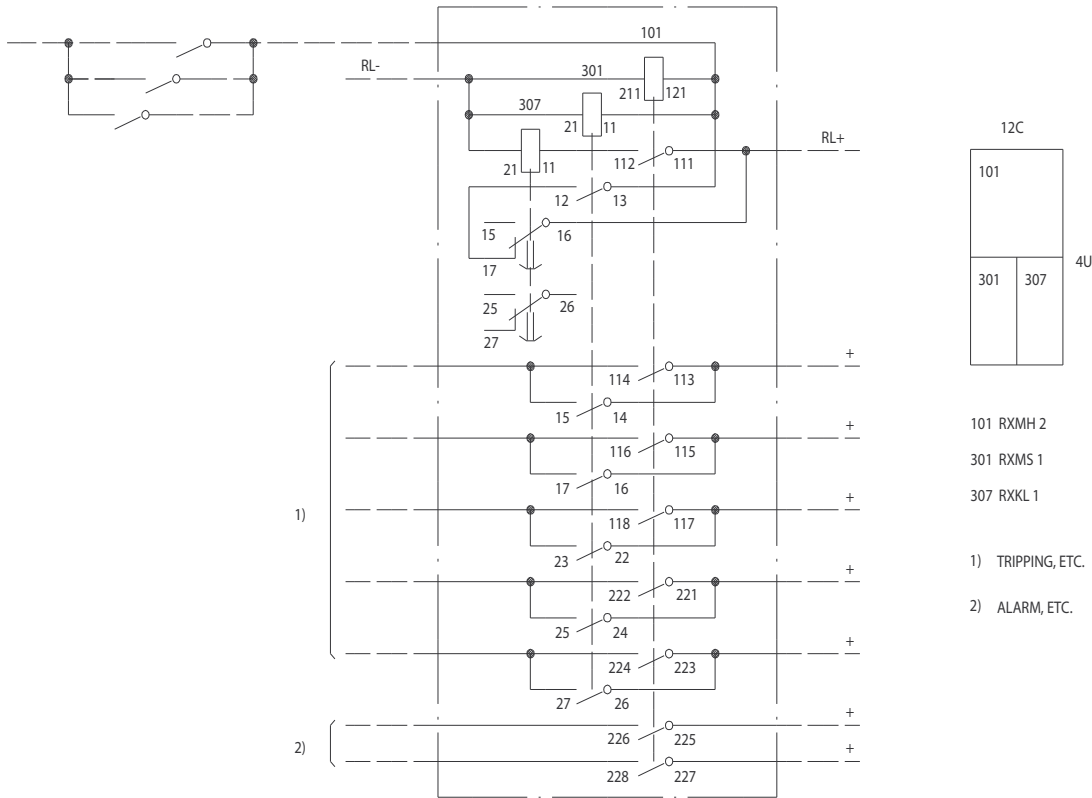

Figure 5. High-speed tripping assembly, RK 651 231-AB, Diagram No. 5651 109-AB

RXMS 1	RXME 1	RXMH 2	RXMVB 2	RXKL 1	Ordering No.	Diagram No.
1	1				5651 273-C	5651 273-CA
1		1			5651 260-F	5651 260-AA
1			1		5651 261-D	5651 261-AA
1		1		1	RK 651 231-AB	5651 109-AB
2		2			5651 260-G	5651 260-AA
2			2		5651 261-E	5651 261-AA

Auxiliary trip unit for transformer protection device

Specify:

- Ordering No.
- No. of inputs
- Auxiliary DC voltage

Function	Ordering No.	Diagrams
6 inputs (+ 4 alarm inputs)	RK 891 031-AA	5651 284-AA/ -AAA
4 inputs	RK 891 031-BA	5651 284-BA/ -BAA

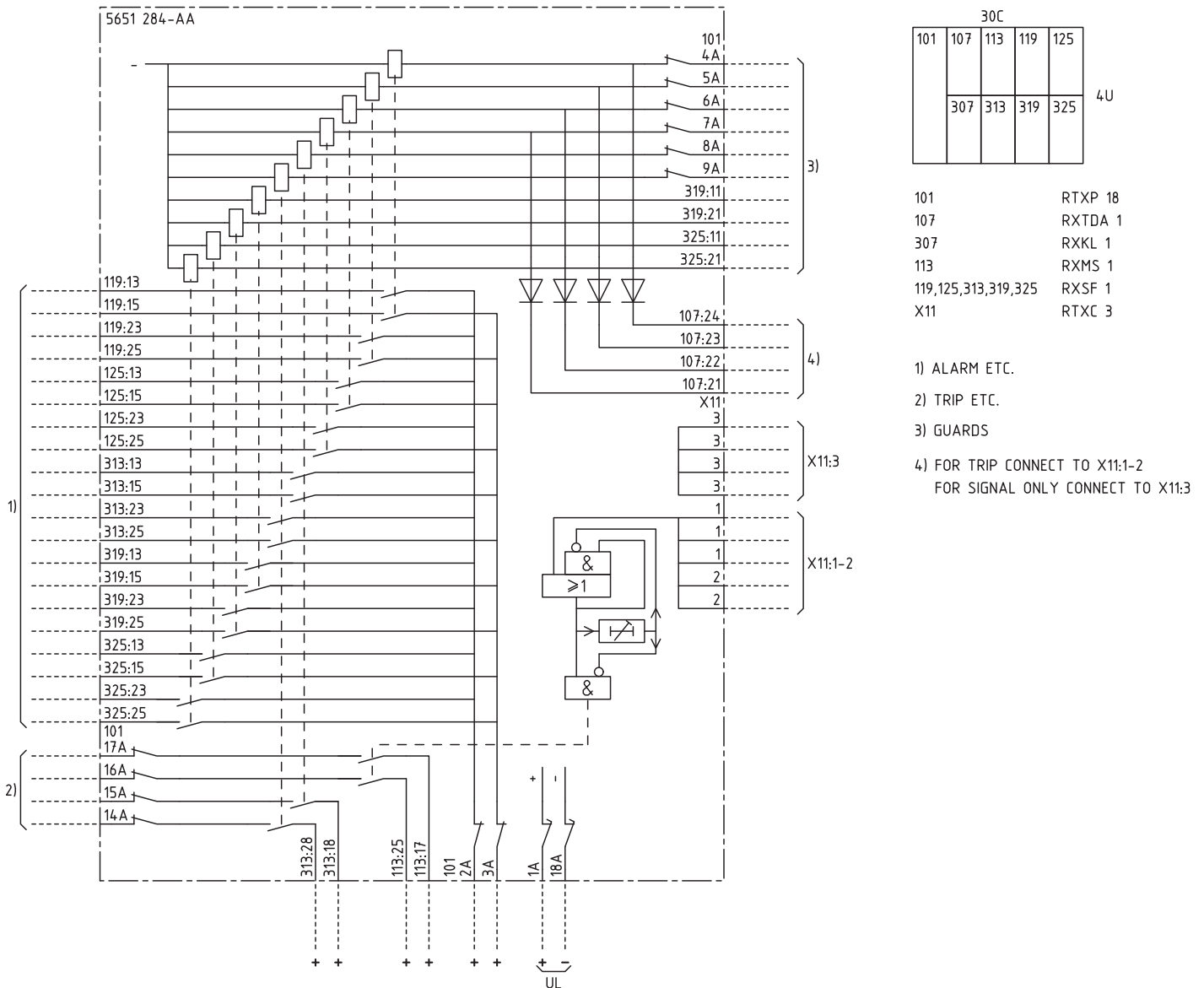

Figure 6. Auxiliary trip unit, RK 891 031-AA, Diagram No. 5651 284-AAA

7. References

COMBIFLEX	
Connection and installation components	1MRK 513 003-BEN
Relay mounting systems	1MRK 514 001-BEN
RTXE Component blocks	1MRK 513 019-BEN
RXT Plug-in component unit	1MRK 513 017-BEN
Time relay RXKL 1	1MRK 508 002-BEN
Voltage control unit RTXV	1MRK 513 007-BEN
Auxiliary relays, Self-reset and bistable	1MRK 508 015-UEN
Auxiliary relays RXMB 1 and RXMB 2	1MRK 508 006-BEN
Bistable relay RXMD 1 and RXMD 2	1MRK 508 017-BEN

8. Document revision history

Table 5. Document revision history

Document revision	Date	Product revision	History
E	2020-12	-	Not released.
F	2020-12	-	Migrated to latest template and stylesheet. Also, updated the technical data.

Disclaimer

The information in this document is subject to change without notice and should not be construed as a commitment by Hitachi Power Grids. Hitachi Power Grids assumes no responsibility for any errors that may appear in this document. Drawings and diagrams are not binding. ABB is a registered trademark of ABB Asea Brown Boveri Ltd. Manufactured by/for a Hitachi Power Grids company.

© 2013 - 2020 Hitachi Power Grids. All rights reserved.

Trademarks

ABB and Relion are registered trademarks of the ABB Group. All other brand or product names mentioned in this document may be trademarks or registered trademarks of their respective holders.

ABB Power Grids Sweden AB
Grid Automation Products
SE-721 59 Västerås, Sweden
Phone +46 (0) 10 738 00 00

ABB Power Products and Systems India Limited
#4A, 5 & 6
II Phase Peenya Industrial Area
Bengaluru - 560058, India
Phone +91 80 2294 9632

<https://www.abb.com/protection-control>



Scan this QR code to visit our website