

ABB INDUSTRIAL DRIVES

ACS880 IGBT supply control program

Firmware manual



List of related manuals

General manuals

ACS880 multidrive cabinets and modules safety instructions

Code (English)

[3AUA0000102301](#)

ACS880 liquid-cooled multidrive cabinets and modules safety instructions

[3AXD50000048633](#)

Cabinet-installed multidrive manuals

ACS880-107 inverter units hardware manual

[3AUA0000102519](#)

ACS880-107LC inverter units hardware manual

[3AXD50000196111](#)

ACS880 primary control program firmware manual

[3AUA0000085967](#)

ACS880 primary control program quick start-up guide

[3AUA0000098062](#)

ACS880-207 IGBT supply units hardware manual

[3AUA0000130644](#)

ACS880-207LC IGBT supply units hardware manual

[3AXD50000174782](#)

ACS880 IGBT supply control program firmware manual

[3AUA0000131562](#)

Optimal grid control of ACS880 IGBT supply control program supplement

[3AXD50000164745](#)

ACS880 multidrives, Optimal grid control (option +N8053) supplement

[3AXD50000220717](#)

ACS880-307 (+A003) diode supply units hardware manual

[3AUA0000102453](#)

ACS880-307 +A018 diode supply units hardware manual

[3AXD50000011408](#)

ACS880-307LC +A018 diode supply units hardware manual

[3AXD50000579662](#)

ACS880 diode supply control program firmware manual

[3AUA0000103295](#)

ACS880-607 1-phase brake units hardware manual

[3AUA0000102559](#)

ACS880-607 3-phase brake units hardware manual

[3AXD50000020967](#)

ACS880-607LC 1-phase brake units hardware manual

[3AXD50000481491](#)

ACS880-607LC 3-phase dynamic brake units hardware manual

[3AXD50000581627](#)

ACS880 (3-phase) brake control program firmware manual

[3AXD50000022034](#)

ACS880-907 regenerative rectifier units hardware manual

[3AXD50000020546](#)

ACS880 regenerative rectifier control program firmware manual

[3AXD50000020827](#)

ACS880-1607 DC/DC converter units hardware manual

[3AXD50000023644](#)

ACS880-1607LC DC/DC converter units hardware manual

[3AXD50000431342](#)

ACS880 DC/DC converter control program firmware manual

[3AXD50000024671](#)

Option manuals

ACS-AP-x assistant control panels user's manual

[3AUA0000085685](#)

Drive composer start-up and maintenance PC tool user's manual

[3AUA0000094606](#)

CIO-01 I/O module for distributed I/O bus control user's manual

[3AXD50000126880](#)

BAMU-12C auxiliary measurement unit hardware manual

[3AXD50000117840](#)

Manuals for I/O extension modules, fieldbus adapters, safety options etc.

You can find manuals and other product documents in PDF format on the Internet. See section Document library on the Internet on the inside of the back cover. For manuals not available in the Document library, contact your local ABB representative.

Firmware manual

ACS880 IGBT supply control program

Table of contents



2. Start-up



Table of contents

1. Introduction to the manual

What this chapter contains	11
Applicability	11
Safety instructions	11
Target audience	12
Contents of the manual	12
Related documents	12
Terms and abbreviations	13
Cybersecurity disclaimer	14
Usage of open source code and third party dependencies	14

2. Start-up

3. Using the control panel

4. Control locations and operating modes

What this chapter contains	19
Local control vs. external control	20
External control	20
Local control	20
Operating modes	21

5. Program features

What this chapter contains	23
Overview of the control program	23
Control program configuration and programming	24
Application programming	24
Programming via parameters	24
Adaptive programming	25
Run enable, Start/stop and Start enable control	26
Settings and diagnostics	26
Control interfaces	27
Programmable analog inputs	27
Programmable analog outputs	27
Programmable digital inputs and outputs	27
Programmable relay outputs	27
Programmable I/O extensions	28
Fieldbus control	28
External controller interface	29
Reference chains	31
DC voltage control	31
Active power control	31
Reactive power control	32
Net lost detection	33
Settings and diagnostics	33



Reduced run function	34
Air-cooled units	34
Liquid-cooled units	34
Activation of the reduced run function	35
Settings and diagnostics	35
Programmable protection functions	36
Emergency stop	36
External events	36
Earth fault detection	36
External earth leakage fault source selection	37
External earth leakage action selection	37
Local control loss detection	37
Automatic fault resets	37
Thermal switch monitoring	37
Power limiting due to heat rise in the supply module	38
Counting the number of charging attempts	38
DC overvoltage and undervoltage protections	39
Diagnostics	40
Maintenance timers and counters	40
Load analyzer	40
User parameter sets	41
Settings	41
User lock	42
Settings	42
Data storage parameters	42
Settings and diagnostics	42
Charging	43
Timing diagram	44
Settings and diagnostics	44
DDCS communication with inverter unit	45
Settings and diagnostics	45
Default I/O connection diagram (BCU)	46
Default I/O connection diagram (ZCU)	48
Parameters that define the use of relay outputs	49
Parameters that define the use of digital inputs	49
Power share with droop control	51
Master/follower link	52
Before start	52
Settings	52
Master/follower functionality	53
General	53
Communication	53
Construction of the master/follower link	54
Example parameter settings	56
Specifications of the fiber optic master/follower link	57
Settings and diagnostics	57
Router mode for BCU control unit	58
Settings	59
Distributed I/O bus	59
Settings	59
BAMU measurements	59
Main circuit configuration	59
Settings and diagnostics	60
Active damping	60



Settings	60
6. Parameters	
What this chapter contains	61
Terms and abbreviations	61
Reserved digital inputs and relay outputs	62
Summary of parameter groups	63
Parameter listing	65
101 Actual values	65
103 Input references	67
104 Warnings and faults	68
105 Diagnostics	73
106 Control and status words	74
107 System info	80
110 Standard DI, RO	81
111 Standard DIO, FI, FO	85
112 Standard AI	88
113 Standard AO	91
114 Extension I/O module 1	94
115 Extension I/O module 2	109
116 Extension I/O module 3	113
119 Operation mode	116
120 Start/stop	117
121 Start/stop mode	122
122 Power reference	122
123 DC voltage reference	124
124 Reactive power reference	125
130 Limits	129
131 Fault functions	133
133 Generic timer & counter	139
136 Load analyzer	144
146 Monitoring settings	147
147 Data storage	148
149 Panel port communication	150
150 FBA	150
151 FBA A settings	155
152 FBA A data in	156
153 FBA A data out	157
154 FBA B settings	157
155 FBA B data in	159
156 FBA B data out	159
160 DDCS communication	160
161 DDCS transmit	166
162 DDCS receive	170
190 BAMU measurements	177
191 BAMU configuration	178
195 HW configuration	180
196 System	184
197 Grid control	190
199 Off grid configuration	190
206 I/O bus configuration	191
207 I/O bus service	191
208 I/O bus diagnostics	191



<i>209 I/O bus fan identification</i>	191
---	-----

7. Additional parameter data

What this chapter contains	193
Terms and abbreviations	193
Fieldbus addresses	194
Parameter groups 101...107	195
Parameter groups 110...209	199

8. Fault tracing

What this chapter contains	223
Safety	223
Indications	224
Warnings and faults	224
Pure events	224
Editable messages	224
Warning/fault history and analysis	224
Event logs	224
Other data loggers	225
Parameters that contain warning/fault information	225
Fault and warning words	226
Warning messages	228
Fault messages	239

9. Fieldbus control through the embedded fieldbus interface (EFB)

10. Fieldbus control through a fieldbus adapter

What this chapter contains	255
System overview	256
Basics of the fieldbus control interface	257
Control word and Status word	257
References	257
Actual values	258
Fieldbus scaling diagram	259
Contents of the fieldbus Control word	260
Contents of the fieldbus Status word	261
The state diagram	262
Setting up the IGBT supply unit for fieldbus control	263
Setting up communication through inverter unit	264

11. Drive-to-drive link

12. Control chain diagrams

What this chapter contains	267
DC voltage reference chain	268
Power reference chain	269
Reactive power reference chain	270
Reactive power control overview	270
Reactive power control detail – Processing of the reference type AC voltage	271



Current limitation chain 272

Further information

Product and service inquiries 273
Product training 273
Providing feedback on ABB Drives manuals 273
Document library on the Internet 273





1

Introduction to the manual

What this chapter contains

This chapter describes the contents of the manual. It also contains information on the compatibility, safety and intended audience.

Applicability

This manual applies to ACS880 IGBT supply control program (AISLX v3.2x or later) and ACS880 IGBT supply control program 2Q (ALHLX v3.2x or later) used in ACS880 drives. The manual covers two versions of the control program: IGBT supply control program for the regenerative drives, and IGBT supply control program for the ultra-low harmonic drives (non-regenerative). The regenerative drives are ACS880 multidrive with IGBT supply unit (ACS880-204, ACS880-204LC, ACS880-207, ACS880-207LC), ACS880-11, ACS880-14, ACS880-17 and ACS880-17LC. The ultra-low harmonic drives are ACS880-31, ACS880-34, ACS880-37 and ACS880-37LC.

Safety instructions

Follow all safety instructions delivered with the drive.

- Read the **complete safety instructions** before you install, commission, or use the drive. See *ACS880 multidrive cabinets and modules safety instructions* (3AUA0000102301 [English]) for air-cooled units, and *ACS880 liquid-cooled multidrive cabinets and modules safety instructions* (3AXD50000048633) for liquid-cooled units.
 - Read the **firmware function-specific warnings and notes** before changing parameter values. These warnings and notes are included in the parameter descriptions presented in chapter [Parameters](#).
-

Target audience

This manual is intended for people who design, commission, or operate the drive system.

Contents of the manual

This manual consists of the following chapters:

- [Start-up](#) refers to where the start-up procedure of the supply unit is described.
- [Using the control panel](#) provides the basic instructions for use of the control panel.
- [Control locations and operating modes](#) describes the control locations and operating modes supported by the control program.
- [Program features](#) describes the features and I/O interface of the control program.
- [Parameters](#) describes the parameters of the control program.
- [Additional parameter data](#) contains further information on the parameters.
- [Fault tracing](#) lists the warning and fault messages with possible causes and remedies.
- [Fieldbus control through the embedded fieldbus interface \(EFB\)](#) describes the communication to and from a fieldbus network using the embedded fieldbus interface.
- [Fieldbus control through a fieldbus adapter](#) describes the communication to and from a fieldbus network using an optional fieldbus adapter module.
- [Drive-to-drive link](#) describes the communication between drives connected together by the drive-to-drive (D2D) link.
- [Control chain diagrams](#) presents the control chain diagrams of the control program.

Related documents

A list of related manuals is printed on the inside of the front cover.

Terms and abbreviations

Term/abbreviation	Definition
ACS-AP-I	Types of control panel used with ACS880 drives
ACS-AP-W	
AI	Analog input; interface for analog input signals
AO	Analog output; interface for analog output signals
BAMU	Auxiliary measurement unit
BCU	Type of control unit used in ACS880 drives.
BU	Branching unit
Control board	Circuit board in which the control program runs.
Control unit	Control board built in a rail-mountable housing
DC link	DC circuit between rectifier and inverter
DDCS	Distributed drives communication system; a protocol used in optical fiber communication
DI	Digital input; interface for digital input signals
DIO	Digital input/output; interface that can be used as a digital input or output
DO	Digital output; interface for digital output signals
EFB	Embedded fieldbus
FAIO-01	Optional analog I/O extension module
FBA	Fieldbus adapter
FIO-01	Optional digital I/O extension module
FIO-11	Optional analog I/O extension module
FCAN-0x	Optional CANopen® adapter
FCNA-0x	Optional ControlNet™ adapter
FDCO-0x	Optional DDCS communication module
FDIO-01	Optional digital I/O extension module
FDNA-0x	Optional DeviceNet™ adapter
FEA-03	Optional I/O extension adapter
FECA-01	Optional EtherCAT® adapter
FENA-11	Optional EtherNet/IP™, Modbus TCP® and PROFINET IO® adapter
FENA-21	Optional dual-port EtherNet/IP, Modbus TCP and PROFINET IO adapter
FEPL-0x	Optional Ethernet POWERLINK adapter
FPBA-0x	Optional PROFIBUS DP® adapter
FSCA-0x	Optional Modbus® adapter
IGBT	Insulated gate bipolar transistor; a voltage-controlled semiconductor type widely used in converters due to their easy controllability and high switching frequency
IGBT supply unit (ISU)	IGBT supply module(s) under control of one control board, and related components such as LCL filters, main contactor, fuses etc.
Inverter unit (INU)	Inverter module(s) under control of one control board, and related components. One inverter unit typically controls one motor.
I/O	Input/Output
LCL filter	Inductor-capacitor-inductor filter for attenuating harmonics
MCB	Main circuit breaker. Electrically-controlled main switching and protecting device. A withdrawable breaker can also be used as the main disconnecter.
MSW	Main status word
Parameter	User-adjustable operation instruction to the drive, or signal measured or calculated by the drive
PLC	Programmable logic controller
RDCO-0x	DDCS communication module
RO	Relay output; interface for a digital output signal. Implemented with a relay.

Term/abbreviation	Definition
STO	Safe torque off
ZCU	Type of control unit used in ACS880 drives. The control unit may be fitted onto the power module, or installed separately.

Cybersecurity disclaimer

This product is designed to be connected to and to communicate information and data via a network interface. It is Customer's sole responsibility to provide and continuously ensure a secure connection between the product and Customer network or any other network (as the case may be). Customer shall establish and maintain any appropriate measures (such as but not limited to the installation of firewalls, application of authentication measures, encryption of data, installation of anti-virus programs, etc) to protect the product, the network, its system and the interface against any kind of security breaches, unauthorized access, interference, intrusion, leakage and/or theft of data or information. ABB and its affiliates are not liable for damages and/or losses related to such security breaches, any unauthorized access, interference, intrusion, leakage and/or theft of data or information.

See also section [User lock](#) (page 42).

Usage of open source code and third party dependencies

Certain open source software components may be used as identified below.

Fast Fourier Transform library (KISS FFT)

Copyright © 2003-2010, Mark Borgerding. All rights reserved.

Copyright © 2021 ABB. All rights reserved.

Redistribution and use in source and binary forms, with or without modification, are permitted provided that the following conditions are met:

1. Redistributions of source code must retain the above copyright notice, this list of conditions and the following disclaimer.
2. Redistributions in binary form must reproduce the above copyright notice, this list of conditions and the following disclaimer in the documentation and/or other materials provided with the distribution.
3. Neither the name of the copyright holder nor the names of its contributors may be used to endorse or promote products derived from this software without specific prior written permission.

THIS SOFTWARE IS PROVIDED BY THE COPYRIGHT HOLDERS AND CONTRIBUTORS "AS IS" AND ANY EXPRESS OR IMPLIED WARRANTIES, INCLUDING, BUT NOT LIMITED TO, THE IMPLIED WARRANTIES OF MERCHANTABILITY AND FITNESS FOR A PARTICULAR PURPOSE ARE DISCLAIMED. IN NO EVENT SHALL THE COPYRIGHT HOLDER OR CONTRIBUTORS BE LIABLE FOR ANY DIRECT, INDIRECT, INCIDENTAL, SPECIAL, EXEMPLARY, OR CONSEQUENTIAL DAMAGES (INCLUDING, BUT NOT LIMITED TO, PROCUREMENT OF SUBSTITUTE GOODS OR SERVICES; LOSS OF USE, DATA, OR PROFITS; OR BUSINESS INTERRUPTION) HOWEVER CAUSED AND ON ANY THEORY OF LIABILITY, WHETHER IN CONTRACT, STRICT LIABILITY, OR TORT (INCLUDING NEGLIGENCE OR OTHERWISE) ARISING IN ANY WAY OUT OF THE USE OF THIS SOFTWARE, EVEN IF ADVISED OF THE POSSIBILITY OF SUCH DAMAGE.

2

Start-up

See the appropriate hardware manual. See [List of related manuals](#) on page 2.







3

Using the control panel

See *ACX-AP-x assistant control panels user's manual* (3AUA0000085685 [English]).



4

Control locations and operating modes

What this chapter contains

This chapter describes the control locations and operating modes supported by the control program.

Local control vs. external control

The ACS880 has two main control locations: external and local. The control location is selected with the Loc/Rem key on the control panel or in the PC tool.

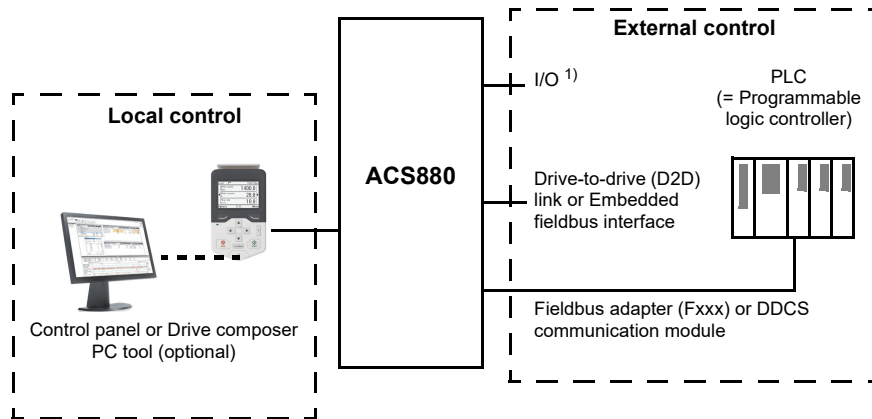

1) Extra inputs/outputs can be added by installing optional I/O extension modules (FIO-xx) in the option slots of the control unit.

■ External control

When the supply unit is in external control, control commands are given through

- the I/O terminals (digital and analog inputs), or optional I/O extension modules
- the embedded fieldbus interface or an optional fieldbus adapter module
- the external (DDCS) controller interface, and/or
- the drive-to-drive link.

External references are given through the fieldbus interface, analog inputs or drive-to-drive link.

Two external control locations, EXT1 and EXT2, are available. The user can select control signals (e.g. start and stop) and control modes for both external control locations. Depending on the user selection, either EXT1 or EXT2 is active at a time. Selection between EXT1/EXT2 is done via any binary source such as a digital input or fieldbus control word (see parameter [119.11 Ext1/Ext2 selection](#)).

Note: Typically, ABB wires essential external control signals and status monitoring signals of a supply unit of the cabinet-installed drive to its digital inputs and relay outputs at the factory. We also set the parameters related to the external control signals accordingly. The commission engineer must not change these settings or the external control does not operate as planned. See the delivery-specific circuit diagrams.

■ Local control

The control commands are given from the control panel keypad or from a PC equipped with Drive composer when the supply unit is in local control.

Local control is mainly used during commissioning and maintenance. The control panel always overrides the external control signal sources when used in local control. When switched to local control, the control panel Start and Stop keys override the external Start/Stop source defined for the control program. However, to control the supply unit on

and off by the panel, you must still have the external Run enable and Start enable signals switched on at the appropriate digital inputs of the supply unit. See section [Run enable, Start/stop and Start enable control](#) on page 26. Changing the control location to local can be disabled by parameter [119.17 Local control disable](#).

The user can select by a parameter ([149.05 Communication loss action](#)) how the supply unit reacts to a control panel loss or PC tool communication break.

Operating modes

The IGBT supply unit can operate in three operating modes with different types of reference:

- DC control
- power control
- AC voltage control (option +N8053).

In DC control and power control modes, the reactive power reference is possible simultaneously. The mode is selectable for each control location (Local, EXT1 and EXT2) in parameter group [119 Operation mode](#). For control chain diagrams of the DC control and power control modes, see chapter [Control chain diagrams](#). For further information and control chain diagram of the AC voltage control mode, see [Optimal grid control of ACS880 IGBT supply control program supplement \(3AXD50000164745 \[English\]\)](#).

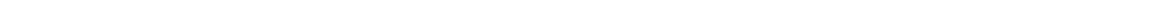

5

Program features

What this chapter contains

This chapter describes the features and I/O interface of the control program.

Overview of the control program

ACS880 IGBT supply control program controls the IGBT supply unit with an IGBT bridge type supply module. The main functions of the control program are:

- maintain DC or active power reference,
- maintain reactive power reference,
- control external charging circuit (when used),
- control main contactor.

In addition, the control program protects the unit against overtemperature, DC or AC overvoltage and DC undervoltage. See section [Charging](#) on page 43. The control program also limits the active and reactive power as a function of the external temperature, and the temperature of the IGBTs. See section [Power limiting due to heat rise in the supply module](#) on page 38.

Control program configuration and programming

The control program is divided into two parts:

- firmware program (forms the control program alone as standard)
- application program (addition by the customer, for special cases only).

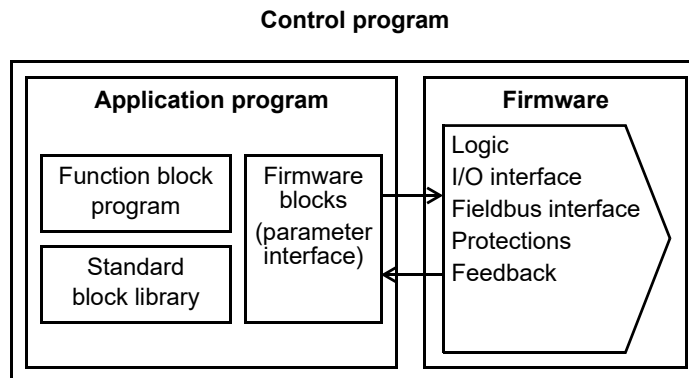

The firmware program performs the main control functions, including handling of DC voltage reference, reactive power reference, active power reference, supply unit logic (start/stop), I/O, feedback, communication and protection functions. Firmware functions are configured and programmed with parameters.

■ Application programming

The functions of the firmware program can be extended with application programming. (A standard delivery does not include an application program.) Application programs can be built out of function blocks based on the IEC 61131-3 standard using a PC tool available separately.

For more information, see *Programming manual: Drive application programming (IEC 61131-3)* (3AUA0000127808 [English]).

■ Programming via parameters

Parameters can be set via

- the control panel, as described in chapter [Using the control panel](#)
- the Drive composer PC tool, or
- the fieldbus interface, as described in chapters [Fieldbus control through the embedded fieldbus interface \(EFB\)](#) and [Fieldbus control through a fieldbus adapter](#).

All parameter settings are stored automatically to the permanent memory of the supply unit. However, if an external +24 V DC power supply is used for the control unit, it is highly recommended to force a save by using parameter [196.07 Parameter save manually](#) before powering down the control unit after any parameter changes.

If necessary, the default parameter values can be restored by parameter [196.06 Parameter restore](#).

■ Adaptive programming

Conventionally, the user can control the operation of the supply unit by parameters. However, the standard parameters have a fixed set of choices or a setting range. To further customize the operation of the supply unit, an adaptive program can be constructed out of a set of function blocks.

The Drive composer PC tool has an Adaptive programming feature with a graphical user interface for building the custom program. The function blocks include the usual arithmetic and logical functions, as well as eg. selection, comparison and timer blocks. The program can contain a maximum of 20 blocks. The adaptive program is executed on a 10 ms time level.

For selecting input to the program, the user interface has pre-selections for the physical inputs, common actual values, and other status information of the supply unit. Parameter values as well as constants can also be defined as inputs. The output of the program can be used eg. as a start signal, external event or reference, or connected to the drive outputs. Note that connecting the output of the adaptive program to a selection parameter will write-protect the parameter.

The status of the adaptive program is shown by parameter [107.30 Adaptive program status](#). The adaptive program can be disabled by [196.70 Disable adaptive program](#).

Please note that sequential programming is not supported.

For more information, see the *Adaptive programming application guide* (3AXD50000028574 [English]).

Run enable, Start/stop and Start enable control

The user controls the operation of the IGBT supply unit with the Run enable command, Start/Stop command and Start enable command. When all commands are on in the control program, it controls the main contactor of the supply unit on with a relay output (relay output RO3 by default), and the charging contactor/relay (relay output RO1 by default). The main contactor connects the supply unit to the power line and the supply unit starts rectifying. If the Start/stop command or the Run enable command is off, the control program de-energizes the relay output and the main contactor switches off.

Note: If all supply and inverter modules connected to the common DC link have internal charging circuits of their own, no common charging circuit in the supply unit is needed, and the supply unit can start without doing the charging first. For more information, see section [Charging](#) on page 43. If any of the commands is off, the control program de-energizes the relay output and the main contactor switches off.

There is a parameter in the control program for defining the value or source for each of the commands. By default, the parameters define the command values or sources as follows:

- Control program reads the Run enable command from digital input DI2.
- Control program reads the Start/Stop command from digital input DI2.
- Start enable is set on constantly.

Typically, DI2 is connected to the operating switch installed on the cabinet door. When the switch is on, the control program receives both the Run enable and Start/Stop commands via DI2.

Note: When you switch the control panel to local control, the control program starts reading the Start/Stop from the panel (Start and Stop keys). The parameter-defined Start/Stop source is not valid until you switch the panel back to remote control. The Loc/Rem key of the panel selects between local and remote control.

Note: Despite of the Local/Remote mode selection by the panel, the program reads the Run enable and Start enable from the interface defined by the appropriate parameters.

Note: Do not change the parameter settings related to Run enable, Start/Stop or Start enable unless you are absolutely sure what you are doing. The parameters settings and I/O wirings of the cabinet-installed unit are done at the factory according to the application requirements.

■ Settings and diagnostics

Control panel key: Loc/Rem

Parameters: parameter group [119 Operation mode](#), [120.01 Ext1 commands...](#) [120.09 Ext2 in2 source](#), [120.12 Run enable 1 source](#), [120.19 Enable start command](#)

Warnings: [AE5A Enable start signal missing](#), [AE5B Run enable missing](#)

Faults: [5E06 Main contactor Fault](#), [3E08 LSU charging](#)

Control interfaces

■ Programmable analog inputs

The control unit has two programmable analog inputs. Each of the inputs can be independently set as a voltage (0/2...10 V or -10...10 V) or current (0/4...20 mA) input by a jumper or switch on the control unit. Each input can be filtered, inverted and scaled. The number of analog inputs can be increased by using FIO-11 or FAIO-01 I/O extensions.

Settings and diagnostics

Parameters: parameter group [112 Standard AI](#)

Warnings: [AE27 AI parameterization](#)

■ Programmable analog outputs

The control unit has two current (0...20 mA) analog outputs. Each output can be filtered, inverted and scaled. The number of analog outputs can be increased by using FIO-11 or FAIO-01 I/O extensions.

Settings and diagnostics

Parameters: parameter group [113 Standard AO](#)

■ Programmable digital inputs and outputs

The control unit has six digital inputs, a digital start interlock input, and two digital input/outputs.

Digital input/output DIO1 can be used as a frequency input, DIO2 as a frequency output.

The number of digital inputs/outputs can be increased by installing FIO-01, FIO-11 or FDIO-01 I/O extensions (see [Programmable I/O extensions](#) below).

Note: Do not change the settings of the reserved digital inputs (or outputs, if any). See subsection [Reserved digital inputs and relay outputs](#) on page 62.

Settings and diagnostics

Parameters: parameter groups [110 Standard DI, RO](#) and [111 Standard DIO, FI, FO](#)

■ Programmable relay outputs

The control unit has three relay outputs. The signal to be indicated by the outputs can be selected by parameters. Relay outputs can be added by installing FIO-01 or FDIO-01 I/O extensions.

Note: Do not change the settings of the reserved relay outputs. See subsection [Reserved digital inputs and relay outputs](#) on page 62.

Settings and diagnostics

Parameters: parameter group [110 Standard DI, RO](#)

■ Programmable I/O extensions

The number of inputs and outputs can be increased by using I/O extension modules. The I/O configuration parameters include the maximum number of DI, DIO, AI, AO and RO that can be in use with different I/O extension module combinations. Slots can be added by connecting an FEA-03 I/O extension adapter.

The table below shows the possible I/O combinations:

Location	Digital inputs (DI)	Digital I/Os (DIO)	Analog inputs (AI)	Analog outputs (AO)	Relay outputs (RO)
Control unit	7	2	2	2	3
FIO-01	-	4	-	-	2
FIO-11	-	2	3	1	-
FAIO-01	-	-	2	2	-
FDIO-01	3	-	-	-	2

Note: Not all the FIO-xx I/O extensions are supported by the current firmware version. (FIO-11 is supported.)

Settings and diagnostics

Parameters: parameter groups [110 Standard DI, RO](#), [111 Standard DIO, FI, FO](#), [112 Standard AI](#), [113 Standard AO](#), [114 Extension I/O module 1](#), [115 Extension I/O module 2](#), [116 Extension I/O module 3](#)

Warnings: [AE2E Extension AI parameterization](#), [AE2F Extension I/O configuration failure](#)

Faults: [7E00 Option module comm loss](#)

■ Fieldbus control

The supply unit can be connected to an overriding control system via an optional fieldbus adapter. See chapter [Fieldbus control through a fieldbus adapter](#) (page 255).

Settings and diagnostics

Parameters: parameter groups [150 FBA](#), [151 FBA A settings](#), [152 FBA A data in](#), [153 FBA A data out](#), [154 FBA B settings](#), [155 FBA B data in](#), [156 FBA B data out](#)

Warnings: [AE25 FBA A parameter conflict](#), [AE26 FBA B parameter conflict](#), [AE30 FBA A communication](#), [AE31 FBA B communication](#)

Faults: [6E01 FBA A mapping file](#), [6E02 FBA B mapping file](#), [6E0D FBA A parameter conflict](#), [6E0E FBA B parameter conflict](#), [7E0B FBA A communication](#), [7E0C FBA B communication](#)

■ External controller interface

General

The IGBT supply unit can be connected to an external controller (such as the ABB AC 800M) using either fiber optic or twisted-pair cable. The ACS880 is compatible with both the ModuleBus and DriveBus connections. Note that some features of DriveBus (such as BusManager) are not supported.

Topology

An example connection with either a ZCU-based or BCU-based IGBT supply unit using fiber optic cables is shown below.

IGBT supply units with a **ZCU** control unit require an additional FDCO DDCCS communication module; IGBT supply units with a **BCU** control unit require an RDCO or FDCO module. The BCU has a dedicated slot for the RDCO – an FDCO module can also be used with a BCU control unit but it will reserve one of the three universal option module slots. Ring and star configurations are also possible much in the same way as with the master/follower link; the notable difference is that the external controller connects to channel CH0 on the RDCO module instead of CH2. The channel on the FDCO communication module can be freely selected.

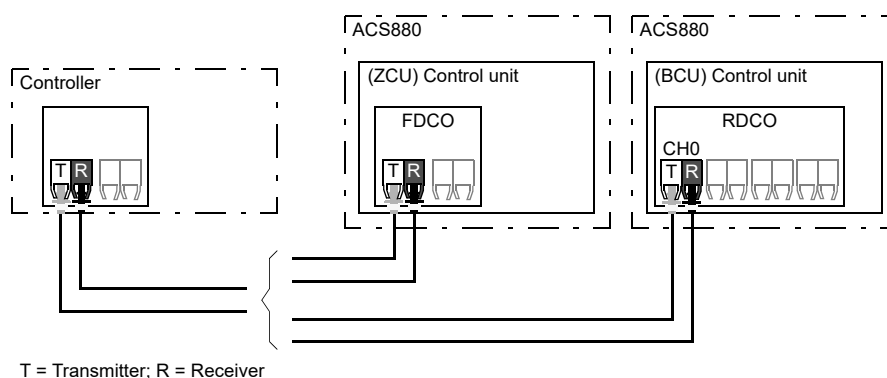

Communication

The communication between the controller and the IGBT supply unit consists of data sets of three 16-bit words each. The controller sends a data set to the IGBT supply unit, which returns the next data set to the controller.

The communication uses data sets 10...33. The contents of the data sets are freely configurable, but data set 10 typically contains the control word, while data set 11 returns the status word and selected actual values.

The word that is defined as the control word is internally connected to the logic; the coding of the bits is as presented in section [Contents of the fieldbus Control word](#) (page 260). Likewise, the coding of the status word is as shown in section [Contents of the fieldbus Status word](#) (page 261).

By default, data sets 32 and 33 are dedicated for the mailbox service, which enables the setting or inquiry of parameter values as follows:

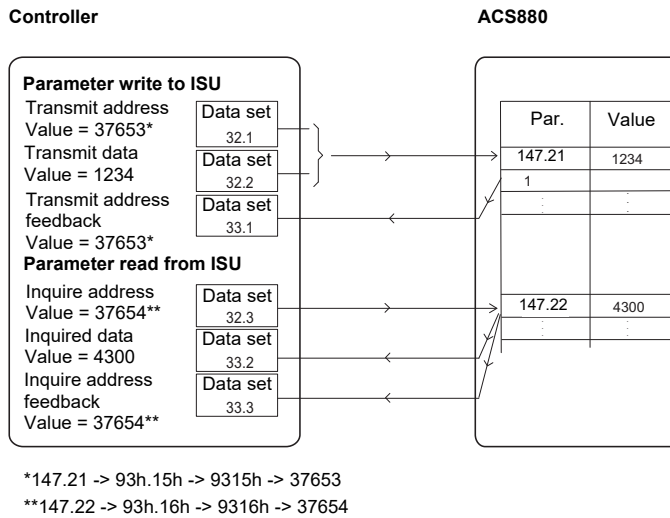

By parameter [160.64 Mailbox dataset selection](#), data sets 24 and 25 can be selected instead of data sets 32 and 33.

The update intervals of the data sets are as follows:

- Data sets 10...11: 2 ms
- Data sets 12...13: 4 ms
- Data sets 14...17: 10 ms
- Data sets 18...25, 32, 33: 100 ms.

Settings

Parameter groups [160 DDCS communication](#) (page 160), [161 DDCS transmit](#) (page 166) and [162 DDCS receive](#) (page 170).

Reference chains

Reference chains of the control program are

- DC voltage reference chain,
- active power reference chain, and
- reactive power reference chain.

Tasks of the reference chains are reference source and type selection, limitation and ramping. The active power, DC voltage and reactive power reference chains are controlled by reference chain control. All of the reference chains are controlled by the bits of limit word ([130.01](#)).

■ DC voltage control

DC voltage is controlled by the DC voltage reference chain. DC voltage control is the default control mode of the supply unit. It is also the alternative control mode for the active power control. DC voltage control includes DC voltage reference selection, limitation and ramping. Incoming DC reference is limited between maximum and minimum of the DC limits. If the incoming reference exceeds the defined limits, the limit word is updated. DC reference is ramped according to DC ramp up and DC ramp down times.

Control chain diagram

See page [268](#).

Internal DC voltage reference

Lowest possible DC voltage level in IGBT supply unit is defined by AC voltage level. If DC voltage reference is lower than what the IGBT supply unit can achieve with control, reference is limited internally to the lowest possible value. Minimum DC voltage reference is filtered with 10 second time constant to prevent immediate drop in DC voltage reference while AC voltage level drops. See also the table on page [51](#).

Settings and diagnostics

Parameters: parameter groups [123 DC voltage reference](#) and [130 Limits](#)

■ Active power control

Active power is controlled by the power reference chain. Active power control is an alternative main control mode for the IGBT supply unit with the DC voltage control (which is the default control mode of the supply unit). Power reference chain includes reference selection, limitation and ramping.

The power reference modifies the input reference to active current reference for the ramp function. Possible input reference types are:

- Active current reference in Amperes
- Active current reference in percent of the nominal current
- Power reference in kW
- Power reference in percent of the nominal power.

Main tasks of active current ramping are:

- Active current reference limitation
- Active current reference ramping.

The control program contains a limitation feature for limiting the active power based on ambient temperature or the temperature of the IGBTs. The user can tune the limitation parameters.

Control chain diagram

See page [269](#).

Settings and diagnostics

Parameters: parameter groups [122 Power reference](#) and [130 Limits](#)

■ Reactive power control

Reactive power is controlled by the reactive power reference chain. Primarily, active power is controlled, and if there is reserve for reactive power, it can be controlled according to its reference. If a request for reactive power cannot be met, the control program indicates it with following parameters:

- [130.03 Limit word 3](#)
 - bit 5 (Reactive current limit)
 - bit 13 (Q act pos) *
 - bit 14 (Q act neg) *
- [106.17 Drive status word 2](#)
 - bit 7 (Internal reactive power reference)
- [130.02 Limit word 2](#)
 - bit 0 (Q user ref max)
 - bit 1 (Q user ref min)

* According to the polarity: positive = capacitive, negative = inductive.

If the IGBT supply unit is at its current limit, reactive power is limited before active power. Reactive power reference chain includes reference selection, limitation and ramping.

The reactive power reference modifies the input reference to reactive current reference. Possible input reference types are:

- Reactive current reference in Amperes
- Reactive current reference in percent of the nominal current
- Reactive power reference in kVAr
- Reactive power reference in percent of the nominal power
- Reactive power reference angle in degrees
- Reactive power reference in cosphi
- Voltage reference for the AC voltage control in Volts
- Voltage reference for the AC voltage control in percent.

The type of the reactive power reference is selected with parameter.

Main tasks of the reactive current ramping are:

- Reactive current reference limitation
- Reactive current reference ramping
- Ramp bypass in case of AC voltage control.

In reactive current reference limiting the incoming reference is limited between maximum and minimum of the reactive current limits. If the incoming reference exceeds the defined limits, the limit word is updated. The limited output is the input signal for the ramping function.

The control program also contains a limitation feature for limiting the reactive power based on ambient temperature or the temperature of the IGBTs. The user can tune the limitation parameters.

Control chain diagram

See page [270](#).

Settings and diagnostics

Parameters: parameter groups [124 Reactive power reference](#) and [130 Limits](#)

Net lost detection

The IGBT supply unit recognizes the loss of supply AC voltage and recovers automatically when the AC voltage is connected again. The supply AC lost detection is based on fast (about 0.2 s, 10 Hz) change of the grid frequency estimate. When the frequency goes outside the frequency limits (± 10 Hz of the nominal frequency), the control program activates the net lost state and generates a warning ([AE78 Net lost](#)). When the net lost is detected, there are two options:

- If the grid voltage measurements are available, the IGBT supply unit tries to resynchronize to the grid when the grid voltages are connected again, and the frequency has been estimated to be between allowed limits. If the maximum duration of the net lost is exceeded (default 5 s), the IGBT supply unit trips to a fault ([8E07 Net lost](#)).
- If the measurements are not available, the IGBT supply unit tries to resynchronize to the grid at regular time intervals (default 0.1 s). If the resynchronization is not successful and the net lost lasts too long (default 5 s), the IGBT supply unit trips to a fault ([8E07 Net lost](#)).

■ Settings and diagnostics

Warnings: [AE78 Net lost](#)

Faults: [3E05 DC link undervoltage](#), [8E07 Net lost](#)

Reduced run function

Reduced run function is available for IGBT supply units consisting of parallel-connected IGBT supply modules of frame size R8i. The function makes it possible to continue operation with limited current even if one (or more) module is out of service, for example, because of maintenance work. In principle, reduced run is possible with only one module, but in practice, the modules in service must be able to provide enough current for running the inverter modules.

Note: Reduced run is not supported in AC control mode.

The number of removed IGBT supply modules and LCL filter modules is restricted. The following tables list the allowed configurations.

Note: When IGBT supply modules and LCL filter modules are removed, the corresponding AC fuses need to be removed too.

Air-cooled units

Original configuration	Allowed configurations when using reduced run function
$2 \times R8i + 1 \times LCL$	$1 \times R8i + 1 \times LCL$
$3 \times R8i + 2 \times LCL$	$2 \times R8i + 2 \times LCL$
$4 \times R8i + 2 \times LCL$	$2 \times R8i + 1 \times LCL$ or $1 \times R8i + 1 \times LCL$
$6 \times R8i + 3 \times LCL$	$4 \times R8i + 2 \times LCL$ or $2 \times R8i + 1 \times LCL$ or $1 \times R8i + 1 \times LCL$
$8 \times R8i + 4 \times LCL$	$6 \times R8i + 3 \times LCL$ or $4 \times R8i + 2 \times LCL$ or $2 \times R8i + 1 \times LCL$ or $1 \times R8i + 1 \times LCL$
$10 \times R8i + 5 \times LCL$	$8 \times R8i + 4 \times LCL$ or $6 \times R8i + 3 \times LCL$ or $4 \times R8i + 2 \times LCL$ or $2 \times R8i + 1 \times LCL$ or $1 \times R8i + 1 \times LCL$

Liquid-cooled units

Original configuration	Allowed configurations when using reduced run function
$2 \times R8i + 1 \times LCL$	$1 \times R8i + 1 \times LCL$
$3 \times R8i + 2 \times LCL$	$2 \times R8i + 2 \times LCL$
$4 \times R8i + 2 \times LCL$	$3 \times R8i + 2 \times LCL$ or $2 \times R8i + 2 \times LCL$
$5 \times R8i + 3 \times LCL$	$4 \times R8i + 3 \times LCL$ or $3 \times R8i + 3 \times LCL$
$(2 \times LCL + 3 \times R8i) + (2 \times LCL + 3 \times R8i)$	$(2 \times LCL + 2 \times R8i) + (2 \times LCL + 2 \times R8i)$
$(2 \times LCL + 4 \times R8i) + (2 \times LCL + 4 \times R8i)$	$(2 \times LCL + 3 \times R8i) + (2 \times LCL + 3 \times R8i)$ or $(2 \times LCL + 2 \times R8i) + (2 \times LCL + 2 \times R8i)$

■ Activation of the reduced run function

Note: For cabinet-built drives, the wiring accessories and the air baffle needed during the procedure are available from ABB, and are included in the delivery.



WARNING! Follow the safety instructions provided for the IGBT supply unit in question.

1. Disconnect the supply voltage and all other sources that can supply the DC bus (eg. DC/DC converter) from the IGBT supply unit.
2. If the control unit of the IGBT supply unit is powered from the faulty module, install an extension to the wiring and connect it to one of the remaining modules.
3. Remove the module to be serviced from its bay. See the appropriate hardware manual for instructions.
4. Install an air baffle to the top module guide to block the airflow through the empty module bay.
5. Switch on the power to the IGBT supply unit.
6. Enter the number of IGBT supply modules present into parameter [195.13 Reduced run mode](#).
7. Reset all faults and start the IGBT supply unit. The maximum current is now automatically limited according to the new configuration. A mismatch between the number of detected modules and the value set in [195.13](#) will generate a fault ([5E0E Reduced run](#)).

After all modules have been reinstalled, parameter [195.13 Reduced run mode](#) must be reset to 0 to disable the reduced run function.

■ Settings and diagnostics

Parameters: [195.13 Reduced run mode](#), [195.14 Connected modules](#)

Faults: [5E0E Reduced run](#)

Programmable protection functions

■ Emergency stop

The emergency stop signal is connected to the input selected by parameter [121.05 Emergency stop source](#). An emergency stop can also be generated through fieldbus (parameter [106.01 Main control word](#), bits 1...2).

The way the IGBT supply unit is stopped when an emergency stop command is received, is selected with parameter [121.04 Emergency stop mode](#). The following selections are available:

- stop and warning,
- warning,
- fault.

Notes:

- The installer of the equipment is responsible for installing the emergency stop devices and all additional devices needed for the emergency stop function to fulfill the required emergency stop categories. For more information, contact your local ABB representative.
- After an emergency stop signal is detected, the emergency stop function cannot be canceled even though the signal is canceled.

Settings and diagnostics

Parameters: [121.04 Emergency stop mode](#), [121.05 Emergency stop source](#)

Warnings: [AE68 Emergency stop warning](#)

Faults: [6E1C Emergency stop fault](#)

■ External events

An external event signal can be connected to a selectable input which is not used for other purposes. When the signal is lost, an external event (fault, warning, or a mere log entry) is generated.

Settings and diagnostics

Parameters: [131.01 External event 1 source](#)...[131.10 External event 5 type](#)

Warnings: [AE51 External warning 1](#)...[AE55 External warning 5](#)

Faults: [9E01 External fault 1](#)...[9E05 External fault 5](#)

■ Earth fault detection

The earth fault detection function is based on sum current measurement. Note that

- in a grounded supply, the protection activates in 200 ms,
- in an ungrounded supply, the supply network capacitance should be 1 μ F or more,
- the protection is deactivated when the supply unit is stopped.

Settings and diagnostics

Parameters: [131.20 Earth fault](#)

Warnings: [AE02 Earth leakage](#)

Faults: [2E01 Earth leakage](#)

■ External earth leakage fault source selection

The parameter selects in which digital input or digital input/output external earth leakage fault is connected.

Parameters: [131.28 Ext earth leakage signal source](#)

Faults: [2E08 External earth fault](#)

■ External earth leakage action selection

The parameter selects how the IGBT supply unit reacts when an external earth leakage is detected.

Parameters: [131.29 Ext earth leakage action](#)

Faults: [2E08 External earth fault](#)

Warnings: [AE87 Ext earth leakage](#)

■ Local control loss detection

The parameter selects how the supply unit reacts to a control panel or PC tool communication break.

Settings and diagnostics

Parameters: [149.05 Communication loss action](#)

Faults: [7E01 Panel loss](#)

■ Automatic fault resets

The supply unit can automatically reset itself after overcurrent, DC overvoltage, DC undervoltage, and external faults. The user can also specify a fault that is automatically reset.

By default, automatic resets are off and must be specifically activated by the user.

Settings and diagnostics

Parameters: [131.12 Autoreset selection...](#) [131.16 Delay time](#)

Warnings: [AE57 Autoreset](#)

■ Thermal switch monitoring

The control program has a thermal switch monitoring function. The function monitors the status of the switch through a digital input typically. By default, digital input DI1 is used for monitoring the status of the thermal switch. Multiple switches must be connected in series. The commissioning engineer can activate the function and define the monitored input by a parameter. If the function receives an overtemperature indication (DI1 = 0), it trips the supply unit to a fault.

Settings and diagnostics

Parameters: [131.33 Cabinet temperature fault source](#), [131.34 Cabinet temperature supervision](#)

Faults: [4E06 Cabinet or LCL overtemperature](#)

■ Power limiting due to heat rise in the supply module

The control program has a supply module temperature monitoring function. The commissioning engineer can define:

- the source for the coolant temperature measurement
- active and reactive power profile vs. temperature value
- warning and fault trip limits.

The function monitors the temperature of the coolant exiting the module. When the value reaches the limit defined for the power limiting profile, the control program starts limiting the power. If the temperature keeps rising despite of the power limiting, the control program generates first a warning (at warning limit), and then trips to a fault (at fault limit). User can activate and tune limitation in parameter group [130 Limits](#).

Example

Set parameter [130.50 Ext Tmp1 input selection](#) with selection *Other* to [114.26 AI1 actual value](#). Set parameter [114.77 AO1 source](#) with selection *Other* to [130.54 Pt current](#). It is possible to use groups 115 or 116 also.

Settings and diagnostics

Parameter groups: [130 Limits](#), [114 Extension I/O module 1...116 Extension I/O module 3](#)

Warnings: [AE10 Ext Tmp1 warning](#), [AE11 Ext Tmp2 warning](#)

■ Counting the number of charging attempts

The control program monitors charging attempts to prevent charging circuit overheating.

Settings and diagnostics

Parameters: [120.50 Charging overload event sel](#)

Warnings: [AE85 Charging count](#)

Faults: [3E09 Charging count](#)

■ DC overvoltage and undervoltage protections

The control program defines the DC overvoltage and undervoltage limits on basis of the supply voltage range given by the user with a parameter (195.01). The program monitors the actual voltage level with an internal voltage measurement. When the measured value exceeds the overvoltage limit or falls below the undervoltage limit, the control program trips to a fault.

Trip limits

The trip limits of the intermediate DC link voltage are relative to the supply voltage range selected with parameter 195.01 *Supply voltage* as well as supply unit type. The DC voltage is displayed by parameter 101.01 *DC voltage*. The following table shows the values of selected DC voltage levels in Volts.

Fault limit type	Supply voltage range (195.01)				
	380...415 V	440...480 V	500 V	525...600 V	660...690 V
Overvoltage fault limit (R1i...R6i, xxxxA-3)	844	-	-	-	-
Overvoltage fault limit (R1i...R6i, xxxxA-5)	880	880	880	-	-
Overvoltage fault limit (R8i, xxxxA-3)	859.5	-	-	-	-
Overvoltage fault limit (R8i, xxxxA-5)	859.5	895.5	895.5	-	-
Overvoltage fault limit (R8i, xxxxA-7)	-	-	-	1293	1293
Undervoltage fault limit (all types)	308	357	405	425	535

Boost limits

Boost limit depends on the maximum voltage of the power module. Boost limits for DC voltage are given in the table below.

IGBT supply module type	DC voltage reference range	
	Minimum [V]	Maximum [V]
xxxxA-3	1)	663 2)
xxxxA-5	1)	799 2)
xxxxA-7	1)	1102 2)

1) The control program limits the minimum value to $\sqrt{2} \times U_{ac} \times (1.03...1.08)$.

2) The maximum value is limited by parameter 123.06 *DC voltage ref max*.

Settings and diagnostics

Parameters: 101.01 *DC voltage*, 123.06 *DC voltage ref max*, 195.01 *Supply voltage*

Warnings: AE09 *DC link overvoltage*, AE0A *DC link undervoltage*

Faults: 3E04 *DC link overvoltage*, 3E05 *DC link undervoltage*

Diagnostics

Maintenance timers and counters

The program has six different maintenance timers or counters that can be configured to generate a warning when a pre-defined limit is reached. The contents of the message can be edited on the control panel by selecting **Settings - Edit texts**.

The timer/counter can be set to monitor any parameter. This feature is especially useful as a service reminder.

There are three types of counters:

- On-time timers. Measures the time a binary source (for example, a bit in a status word) is on.
- Signal edge counters. The counter is incremented whenever the monitored binary source changes state.
- Value counters. The counter measures, by integration, the monitored parameter. A warning is given when the calculated area below the signal exceeds a user-defined limit.

Settings and diagnostics

Parameters: parameter group [133 Generic timer & counter](#)

Load analyzer

Peak value logger

The user can select a signal to be monitored by a peak value logger. The logger records the peak value of the signal along with the time the peak occurred, as well as supply unit current, DC voltage and power at the time of the peak.

Amplitude loggers

The control program has two amplitude loggers.

For amplitude logger 2, the user can select a signal to be sampled at 200 ms intervals when the IGBT supply unit is running, and specify a value that corresponds to 100%. The collected samples are sorted into 10 read-only parameters according to their amplitude. Each parameter represents an amplitude range 10 percentage points wide, and displays the percentage of the collected samples that fall within that range.

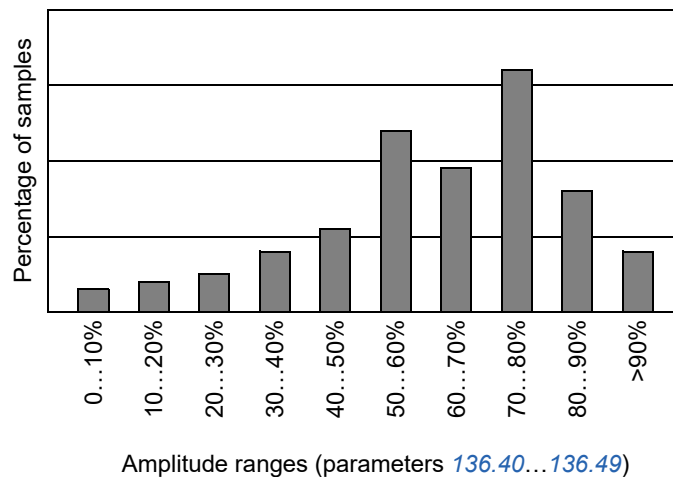

Amplitude logger 1 is fixed to monitor the converter current, and cannot be reset. With amplitude logger 1, 100% corresponds to the maximum output current (I_{\max}). The distribution of samples is shown by parameters [136.20...136.29](#).

Settings

Parameters: parameter group [136 Load analyzer](#)

User parameter sets

The IGBT supply unit supports four user parameter sets that can be saved to the permanent memory and recalled using parameters. It is also possible to use digital inputs to switch between user parameter sets.

A user parameter set contains all editable values in parameter groups 110...199 except

- forced I/O values such as parameters [110.03 DI force selection](#) and [110.04 DI force data](#)
- I/O extension module settings (groups 114...116)
- fieldbus communication enable parameters ([150.01 FBA A enable](#) and [150.31 FBA B enable](#))
- other fieldbus communication settings (groups 151...156)
- some hardware settings in parameter group [195 HW configuration](#), and
- user set selection parameters [196.11...196.13](#).

If no parameter sets have been saved, attempting to load a set will create all sets from the currently active parameter settings.

Switching between user parameter sets is only possible with the supply unit stopped.

Example: Generator power control between two settings: user parameter sets are used, and switching between them is done with DI5.

The parameter settings are:

- User set 1: [130.49](#) is set to -200% (braking power is 100%)
- User set 2: [130.49](#) is set to 0% (braking power is 0%)

User set 1:

- [130.49](#) is set to -200% (the default value)
- [196.11](#) is set to [Save to set 1](#)

User set 2:

- [130.49](#) is set to 0%
- [196.11](#) is set to [Save to set 2](#)

The final settings are:

- [196.11](#) is set to [IO mode](#)
- [196.12](#) is set to [DI5](#).

Note: Switching between user parameter sets must be done with the supply unit stopped.

■ Settings

Parameters [196.10...196.13](#) (page [185](#)).

User lock

For better cybersecurity, it is highly recommended that you set a master pass code to prevent eg. the changing of parameter values and/or the loading of firmware and other files.



WARNING! ABB will not be liable for damages or losses caused by the failure to activate the user lock using a new pass code. See [Cybersecurity disclaimer](#) (page 14).

To activate the user lock for the first time, enter the default pass code, 10000000, into [196.02 Pass code](#). This will make parameters [196.100...196.102](#) visible. Then enter a new pass code into [196.100 Change user pass code](#), and confirm the code in [196.101 Confirm user pass code](#). In [196.102 User lock functionality](#), define the actions that you want to prevent (we recommend you select all the actions unless otherwise required by the application).

To close the user lock, enter an invalid pass code into [196.02 Pass code](#), activate [196.08 Control board boot](#), or cycle the power. With the lock closed, parameters [196.100...196.102](#) are hidden.

To reopen the lock, enter your pass code into [196.02 Pass code](#). This will again make parameters [196.100...196.102](#) visible.

■ Settings

Parameters [196.02](#) (page 184) and [196.100...196.102](#) (page 189).

Data storage parameters

Twenty-four (sixteen 32-bit, eight 16-bit) parameters are reserved for data storage. These parameters are unconnected and can be used for linking, testing and commissioning purposes. They can be written to and read from using other parameters' source or target selections.

■ Settings and diagnostics

Parameters: parameter group [147 Data storage](#)

Charging

The charging is always needed to power up the DC link capacitors smoothly. In other words: you may not connect the discharged capacitors to full supply voltage but you must increase the voltage gradually until the capacitors are charged and ready for normal use.

The control program has a function for controlling an additional charging circuit in the IGBT supply unit. The charging function is active as standard, since the cabinet-installed ABB drive which uses IGBT supply unit, needs the additional charging circuit typically.

Note: Some ABB supply and inverter module sizes have internal charging circuit as standard. (Check from the appropriate supply and inverter module hardware manuals.) If all supply and inverter modules connected to the common DC link of the drive have the internal charging circuit, you do not need the common, additional circuit in the supply unit. Then you can also inactivate the charging function of the supply unit (a parameter setting).

When the control program receives the start command (and Run enable and Start enable are on), the control program controls the charging contactor on by a relay output. The contactor connects the input power line to the drive DC link via charging resistors. The DC capacitor charging starts. The DC voltage level in the DC link increases as the charging continues. The charging resistors limit the charging current.

Charging is completed when:

- the actual DC voltage exceeds the predefined level (parameter [120.25 MCB closing level](#))
- the actual DC voltage change rate is below the predefined level (parameter [120.26 Maximum dU/dt](#)), and
- the pre-defined delay time has passed (parameter [120.27 Start delay](#)).

The control program monitors the charging time. If charging takes more time than defined by a parameter, the supply unit trips to a fault.

If the IGBT supply unit is used in a drive system where the charging must be done by the IGBT supply unit, you must install an additional charging circuit, and activate and tune the charging function in the IGBT supply control program. Consult ABB for more information on tuning the parameters, and the components and wirings needed.

The control program checks that voltage rises after the charging contactor is closed. If the voltage does not rise and the current stays below the level defined with parameter [120.22 Max current for MCB closing](#), the supply unit trips on fault [3E08 LSU charging](#) (auxiliary code 5). If the current is higher, the supply unit trips on fault [2E09 DC short circuit](#).

The control program monitors charging attempts to prevent charging circuit overheating. If there are more than two attempts in five minutes to charge the DC link externally, start inhibit is set ([106.18 Start inhibit status word](#), bit 9). After five minutes from the first charging attempt the start inhibit is removed. The supply unit also generates an event selected with parameter [120.50 Charging overload event sel](#).

■ Timing diagram

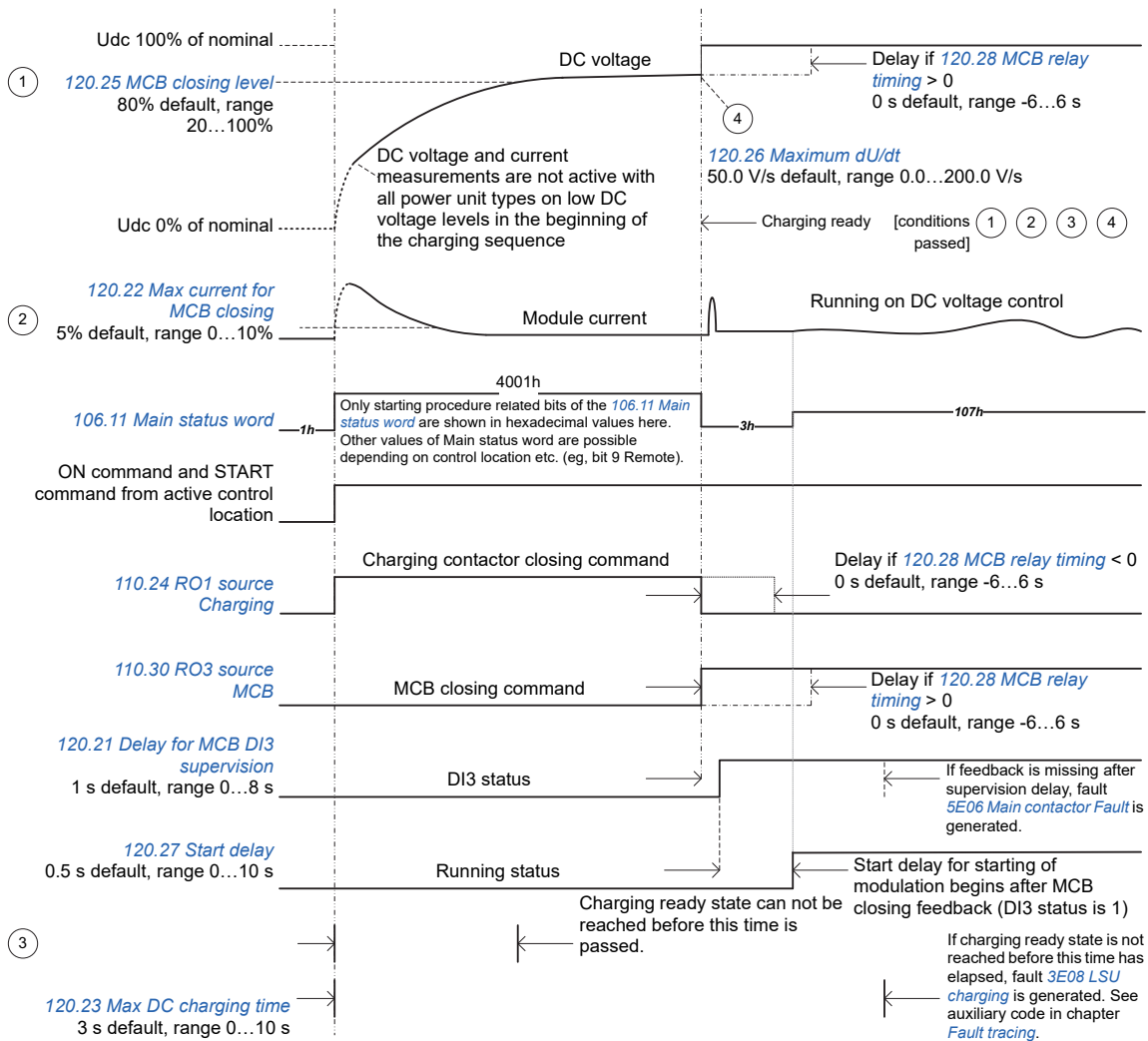

■ Settings and diagnostics

Signals: [101.01 DC voltage](#)

Parameters: [106.18 Start inhibit status word](#), [110.24 RO1 source](#), [120.22 Max current for MCB closing](#), [120.23 Max DC charging time](#), [120.25 MCB closing level](#), [120.26 Maximum dU/dt](#), [120.27 Start delay](#), [120.28 MCB relay timing](#), [120.29 Diode mode](#), [120.30 External charge enable](#), [120.50 Charging overload event sel](#)

Warnings: [AE85 Charging count](#)

Faults: [2E09 DC short circuit](#), [3E08 LSU charging](#), [3E09 Charging count](#), [5E06 Main contactor Fault](#)

DDCS communication with inverter unit

DDCS communication can be used for transferring data between IGBT supply unit and inverter unit. The DDCS communication and the related transfer media (fiber optic link) are in use in the single drives which consist of one supply unit and one inverter unit. The DDCS link is not in use in multidrives, typically.

You can use the DDCS communication for these purposes:

- You can show and adjust the supply unit parameters in the inverter control program (one interface for the control panel and commissioning engineer).
- You can show supply unit warnings and faults in the inverter control program.
- You can control both the inverter unit and the supply unit through one control interface (for example one fieldbus adapter) in the inverter unit, and transfer the supply unit control commands and references via the link to the supply unit.

For information on using DDCS communication, see section [Setting up communication through inverter unit](#) on page 264.





■ Settings and diagnostics

Parameters: parameter groups [160 DDCS communication](#), [161 DDCS transmit](#), [162 DDCS receive](#)

Warnings: [AE56 INU-LSU comm loss](#)

Faults: [7E0D FA2FA DDCS Com loss](#)

Default I/O connection diagram (BCU)

XD2D		Drive-to-drive link
1	B	Drive-to-drive link (not in use by default)
2	A	
3	BGND	
4	Shield	
D2D.TERM		Drive-to-drive link termination ¹⁾
X485		RS485 connection
5	B	Not in use (not in use by default)
6	A	
7	BGND	
8	Shield	
XRO1...XRO3		Relay outputs
11	NC	 XRO1: Charging ²⁾ (Energized = Closes charging contactor.) 250 V AC / 30 V DC / 2 A
12	COM	
13	NO	
21	NC	 XRO2: Fault(-1) ³⁾ (Energized = Indicates no fault.) 250 V AC / 30 V DC / 2 A
22	COM	
23	NO	
31	NC	 XRO3: MCB ctrl ²⁾ (Energized = Closes main contactor/breaker.) 250 V AC / 30 V DC / 2 A
32	COM	
33	NO	
XSTO		XSTO connector
1	OUT	 XSTO connector. Both circuits (power module, control unit) must be closed for the supply unit to start. (IN1 and IN2 must be connected to OUT.) ⁴⁾
2	SGND	
3	IN1	
4	IN2	
5	IN1	Not in use
6	SGND	
7	IN2	
8	SGND	
XDI		Digital inputs
1	DI1	Temp fault ³⁾ (0 = overtemperature)
2	DI2	Run / enable ³⁾ (1 = run / enable)
3	DI3	MCB fb ²⁾ (0 = main contactor/breaker open)
4	DI4	Not in use by default. Can be used for eg. auxiliary circuit breaker fault
5	DI5	Not in use by default. Can be used for eg. earth fault monitoring.
6	DI6	Reset ³⁾ (0 -> 1 = fault reset)
7	DIIL	Not in use by default. Can be used for eg. emergency stop.
XDIO		Digital input/outputs
1	DIO1	Not in use by default
2	DIO2	Not in use by default
3	DIOGND	Digital input/output ground
4	DIOGND	Digital input/output ground
XD24		Auxiliary voltage output
5	+24VD	+24 V DC 200 mA ⁵⁾
6	DICOM	Digital input ground
7	+24VD	+24 V DC 200 mA ⁵⁾
8	DIOGND	Digital input/output ground
DICOM=DIOGND		Ground selection switch ⁶⁾
XAI		Analog inputs, reference voltage output
1	+VREF	10 V DC, R_L 1...10 kohm
2	-VREF	-10 V DC, R_L 1...10 kohm
3	AGND	Ground
4	AI1+	Not in use by default.
5	AI1-	0(2)...10 V, $R_{in} > 200$ kohm ⁷⁾
6	AI2+	Not in use by default.
7	AI2-	0(4)...20 mA, $R_{in} = 100$ ohm ⁸⁾
XAO		Analog outputs
1	AO1	Zero ³⁾ 0...20 mA, $R_L < 500$ ohm
2	AGND	
3	AO2	Zero ³⁾ 0...20 mA, $R_L < 500$ ohm
4	AGND	
XPOW		External power input
1	+24VI	24 V DC, 2.05 A
2	GND	
3	+24VI	
4	GND	
X12		Safety functions module connection (not in use in supply units)
X13		Control panel connection
X205		Memory unit connection









The table above shows the control connections of the IGBT supply unit, and the default meaning or use of the signals in the control program. Most I/O connections are reserved and wired for the internal use at the factory. Do not change the connections.

Wire sizes and tightening torques: 0.5 ... 2.5 mm² (24...12 AWG) and 0.5 N·m (5 lbf·in) for both stranded and solid wiring.

Notes:

- 1) Switch D2D.TERM. Must be set to ON when the supply unit is the first or last unit on the drive-to-drive (D2D) link. On intermediate supply units, set termination to OFF.
 - 2) Use of the signal in the control program. When parameter [120.30 External charge enable](#) has value *Yes* (default setting), the control program reserves this I/O terminal for external charging circuit control and monitoring, and parameters [110.24 RO1 source](#) and [110.30 RO3 source](#) are write-protected. If the value is *No*, you can use the I/O terminal for other purposes.
 - 3) Default use of the signal in the control program. The use can be changed by a parameter. For the delivery-specific use, see the delivery-specific circuit diagrams.
 - 4) The Safe torque off (STO) function is only implemented in the inverter units. When the control board is used in the supply or brake unit, de-energizing IN1 or IN2 of XSTO connector only stops the operation of the supply or brake unit. This stopping is not safety related and can not be used in safety purposes.
 - 5) Total load capacity of these outputs is 4.8 W (200 mA at 24 V) minus the power taken by DIO1 and DIO2.
 - 6) Determines whether DICOM is separated from DIOGND (ie. common reference for digital inputs floats).
DICOM=DIOGND ON: DICOM connected to DIOGND. OFF: DICOM and DIOGND separate.
 - 7) Current [0(4)...20 mA, $R_{in} = 100 \text{ ohm}$] or voltage [0(2)...10 V, $R_{in} > 200 \text{ kohm}$] input selected by switch AI1. Change of setting requires reboot of control unit.
 - 8) Current [0(4)...20 mA, $R_{in} = 100 \text{ ohm}$] or voltage [0(2)...10 V, $R_{in} > 200 \text{ kohm}$] input selected by switch AI2. Change of setting requires reboot of control unit.
-

Default I/O connection diagram (ZCU)

Relay outputs		XRO1...XRO3	
XRO1: Charging ¹⁾ (Energized = Closes charging contactor.) 250 V AC / 30 V DC 2 A		NO	3
		COM	2
		NC	1
XRO2: Fault (-1) ²⁾ (Energized = Indicates no fault) 250 V AC / 30 V DC 2 A		NO	3
		COM	2
		NC	1
XRO3: MCB ctrl ¹⁾ (Energized = Closes main contactor/breaker.) 250 V AC / 30 V DC 2 A		NO	3
		COM	2
		NC	1
Power supply		XPOW	
24 V DC, 2 A	GND		2
	+24VI		1
Reference voltage and analog inputs		J1, J2, XAI	
AI1/AI2 current/voltage selection	AI1: U	AI2: U	
	AI1: I	AI2: I	
Not in use by default 0(4) ... 20 mA, $R_{in} > 100 \text{ ohm}$ ³⁾	AI2-	7	
	AI2+	6	
Not in use by default 0(4) ... 20 mA, $R_{in} > 100 \text{ ohm}$ ⁴⁾	AI1-	5	
	AI1+	4	
Ground	AGND	3	
-10 V DC, $R_L 1 \dots 10 \text{ kohm}$	-VREF	2	
10 V DC, $R_L 1 \dots 10 \text{ kohm}$	+VREF	1	
Analog outputs		XAO	
Zero ²⁾ 0 ... 20 mA, $R_L < 500 \text{ ohm}$	AGND	4	
	AO2	3	
Zero ²⁾ 0 ... 20 mA, $R_L < 500 \text{ ohm}$	AGND	2	
	AO1	1	
Drive-to-drive link (not connected by default)		XD2D	
Drive-to-drive link	Shield	4	
	BGND	3	
	A	2	
	B	1	
Drive-to-drive link termination ⁵⁾			J3
XSTO circuit		XSTO	
Both circuits (power module, control unit) must be closed for the supply unit to start. (IN1 and IN2 must be connected to out.) ⁶⁾	IN2	4	
	IN1	3	
	SGND	2	
	OUT	1	
Digital inputs		XDI	
Reset ²⁾ (0 -> 1 = fault reset)	DI6	6	
Not in use by default. Can be used for eg. earth fault monitoring.	DI5	5	
Not in use by default. Can be used for eg. auxiliary circuit breaker fault.	DI4	4	
MCB fb ¹⁾ (0 = main contactor/breaker open)	DI3	3	
Run / enable ²⁾ (1 = run / enable)	DI2	2	
Temp fault ²⁾ (0 = overtemperature)	DI1	1	
Digital input/outputs		XDIO	
Not in use by default	DIO2	2	
Not in use by default	DIO1	1	
Ground selection ⁷⁾			J6
Auxiliary voltage output, digital input interlock		XD24	
Digital input/output ground	DIOGND	5	
+24 V DC 200 mA ⁸⁾	+24VD	4	
Digital input ground (common)	DICOM	3	
+24 V DC 200 mA ⁸⁾	+24VD	2	
Not in use by default	DIIL	1	
Safety functions module connection (not connected by default)		X12	
Control panel connection (connected to control panel by default)		X13	
Memory unit connection		X205	

The table above shows the control connections of the IGBT supply unit, and the default meaning or use of the signals in the control program. Most I/O connections are reserved and wired for the internal use at the factory. Do not change the connections.

Wire sizes and tightening torques: 0.5 ... 2.5 mm² (24...12 AWG) and 0.5 N·m (5 lbf·in) for both stranded and solid wiring.

Notes:

- 1) Use of the signal in the control program. When parameter [120.30 External charge enable](#) has value *Yes* (default setting), the control program reserves this I/O terminal for external charging circuit control and monitoring, and parameters [110.24 RO1 source](#) and [110.30 RO3 source](#) are write-protected. If the value is *No*, you can use the I/O terminal for other purposes
- 2) Default use of the signal in the control program. The use can be changed by a parameter. For the delivery-specific use, see the delivery-specific circuit diagrams.
- 3) Current [0(4)...20 mA, $R_{in} > 100 \text{ ohm}$] or voltage [0(2)...10 V, $R_{in} > 200 \text{ kohm}$] input selected by jumper J2. Change of setting requires reboot of control unit.
- 4) Current [0(4)...20 mA, $R_{in} > 100 \text{ ohm}$] or voltage [0(2)...10 V, $R_{in} > 200 \text{ kohm}$] input selected by jumper J1. Change of setting requires reboot of control unit.
- 5) Jumper/switch J3. Enable bus termination on the supply units at the ends of the drive-to-drive (D2D) link. On intermediate supply units, disable bus termination.
ZCU-14: Termination disabled. Termination enabled.
- 6) The Safe torque off (STO) function is only implemented in the inverter units. When the control board is used in the supply or brake unit, de-energizing IN1 or IN2 of XSTO connector only stops the operation of the supply or brake unit. This stopping is not safety related and can not be used in safety purposes.
- 7) Jumper/switch J6. Determines whether DICOM is separated from DIOGND (ie. common reference for digital inputs floats).
ZCU-14: DICOM connected to DIOGND. DICOM and DIOGND separate.
- 8) Total load capacity of these outputs is 4.8 W (200 mA at 24 V) minus the power taken by DIO1 and DIO2.

■ Parameters that define the use of relay outputs

The table below shows the relay outputs and the parameters and that define their use by default.

Output	Parameter	Default value
RO1	110.24 RO1 source	<i>Charging</i>
RO2	110.27 RO2 source	<i>Fault (-1)</i>
RO3	110.30 RO3 source	<i>MCB</i>

■ Parameters that define the use of digital inputs

The table below shows the default use of digital inputs by parameters.

Input	Parameter	Additional information
DI1	131.33 Cabinet temperature fault source	0 = overtemperature Typically this is used for monitoring the status of cabinet temperature fault.
DI2	120.12 Run enable 1 source 120.03 Ext1 in1 source	1 = run enable 1 = on
DI6	131.11 Fault reset selection	0 -> 1 = fault reset

The table below shows the common use of the remaining digital inputs in the cabinet installed drives by ABB. Note that these are no default parameters settings in the control program.

Input	Parameter	Additional information
DI4	131.32 Aux circuit breaker fault source	0 = auxiliary circuit breaker or switch open Typically this is used for monitoring the status of auxiliary circuit breaker.
DI5	131.28 Ext earth leakage signal source	0 = earth leakage current monitoring tripped
DIIL	121.05 Emergency stop source	0 = emergency stop active

For the rest of the parameters that can use digital inputs as signal source, see chapter [Parameters](#).

Power share with droop control

If two supply units that are fed from separate transformers are connected to the same DC link, you must make sure that the power share is controlled and the system remains stable. Always use the same DC voltage reference for all units. Use also the droop function in all units.

The droop function stabilizes the load sharing between the units. It automatically tunes the external DC voltage reference slightly as the actual load of the unit varies: it changes the reference in the generating mode and in the motoring mode. See the diagram below. When the droop is active in all units, their reference corrections help in finding the right load balance and remain it automatically.

With the droop control enabled, two supply units can control the same DC link voltage. DC voltage reference droop is implemented by modifying the DC link voltage reference depending on actual power with droop rate. The droop increases the DC link voltage in generator-side and decreases it in motoring side. Droop control is defined by parameters [123.30 Udc-ctrl droop](#) and [123.31 Udc-ctrl drooping rate](#). The default drooping rate is 5% of **nominal phase peak voltage**. With nominal motor-side power the DC link reference is decreased:

$$0.05 \cdot \sqrt{2/3} \cdot 500 \text{ V} \approx 20 \text{ V}$$

Some examples of needed marginal for DC reference with 5% drooping rate are given in the table below. See also the diagram below.

AC line voltage	DC voltage	Minimum DC voltage	Droop marginal	DC reference (see parameter 123.01)
415 V	616 V	$\sqrt{2} \cdot 415 \cdot 1.05$	17 V	616 V + 17 V = 633 V
500 V	742 V	$\sqrt{2} \cdot 500 \cdot 1.05$	20 V	742 V + 20 V = 762 V
690 V	1025 V	$\sqrt{2} \cdot 690 \cdot 1.05$	28 V	1025 V + 28 V = 1053 V

If the AC grid voltage is higher, more marginal is needed since phase-to-phase peak grid voltage is the lowest DC voltage that the supply unit can produce. Producing capacitive reactive power requires DC voltage and DC voltage marginal that are higher than usual default values. See also section [Reactive power control](#) on page [32](#).

The following figure shows an example of drooping.

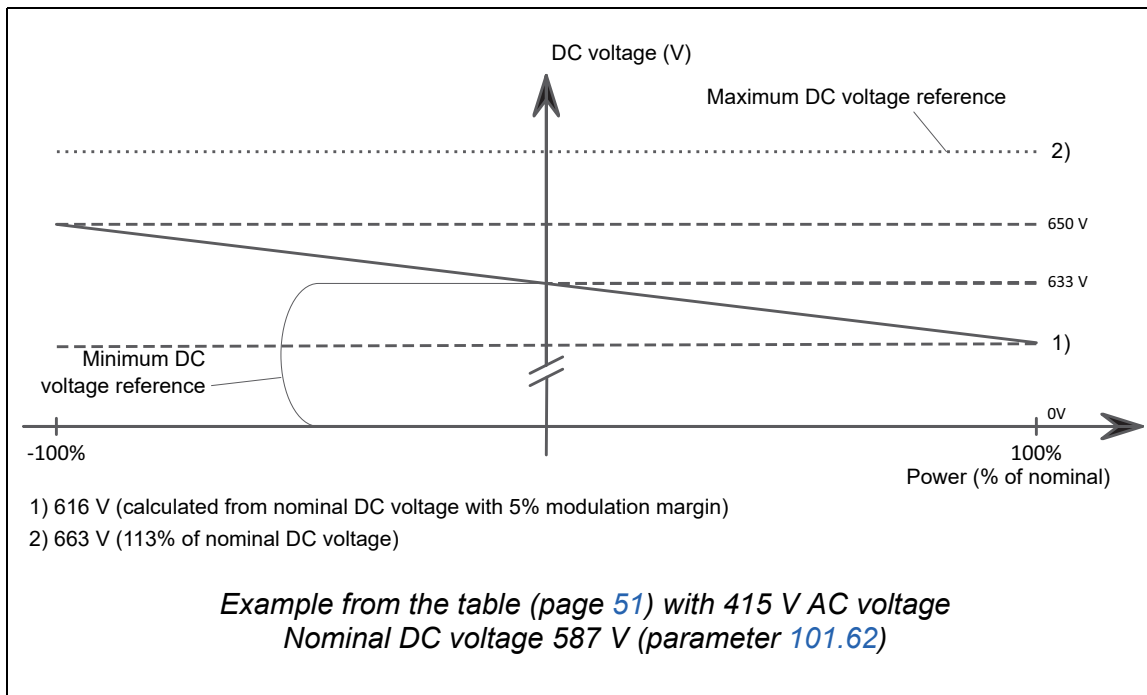

Difference in voltage measurements of the IGBT supply units causes error in power share between the units. This error can be corrected with parameter [123.13 DC voltage ref add](#). Then check with the load also. In master/follower communication the correction is done automatically when the master sends the actual value of the power to the follower.
Example: Increase the reference by 0.25 V in that IGBT supply unit that takes less power or vice versa.

See also *Parallel-connected ACS880-207 IGBT supply units system description* (3AXD50000032517 [English]).

■ Master/follower link

The supply units have a master/follower link between them. The link is built by connecting the units together with fiber optic cables. The communication on the link is based on the DDCS protocol, and there are RDCO communication modules on the BCU control units of both supply units to organize DDCS communication.

■ Before start

Droop must be enabled from all supply units feeding the same DC link. See parameter [123.30 Udc-ctrl droop](#). When drooping is used, the user-given DC voltage reference (source [123.02 DC voltage ref selection](#)) needs to be increased from internally calculated default value so that the droop control can decrease the DC voltage.

■ Settings

Parameters: [123.13 DC voltage ref add](#), [123.30 Udc-ctrl droop](#), [123.31 Udc-ctrl drooping rate](#)

Master/follower functionality

■ General

The master/follower functionality can be used to link several supply units together so that the load can be evenly distributed between them.

The external control signals are typically connected to one supply unit only which acts as the master. The master controls up to 10 followers by sending broadcast messages over an electrical cable or fiber optic link. The master can read feedback signals from up to 3 selected followers.

The operating mode can be selected by parameter ([119.12 Ext1 ctrl mode1](#) or [119.14 Ext2 ctrl mode1](#)). See chapter [Control locations and operating modes](#) (page 19).

If a supply unit needs to quickly switch between master and follower statuses, one user parameter set (see page 41) can be saved with the master settings, another with the follower settings. The suitable settings can then be activated using eg. digital inputs. For more information on redundant system, see [Parallel-connected ACS880-207 IGBT supply units system description](#) (3AXD50000032517 [English]).

■ Communication

A master/follower link can be built by connecting the units together with fiber optic cables (may require additional equipment depending on existing hardware), or by wiring together the XD2D connectors of the units. The medium is selected by parameter [160.01 M/F communication port](#). Parameter [160.03 M/F mode](#) defines whether the unit is the master or a follower on the communication link.

The communication on the master/follower link is based on the DDCS protocol, which employs data sets (specifically, data set 41). One data set contains three 16-bit words. The contents of the data set are freely configurable using parameters [161.01...161.03](#). The data set broadcast by the master typically contains the control word and the references, while the followers return a status word with two actual values.

The default setting of parameter [161.01 M/F data 1 selection](#) is *Follower CW*. With this setting in the master, a word consisting of bits 0...11 of [106.01 Main control word](#) is broadcast to the followers. However, bit 3 of the follower control word is modified so that it remains on as long as the master is modulating, and its switching to 0 causes the follower to stop modulating. This is to synchronize the stopping of both master and follower.

Three words of additional data can optionally be read from each follower. The followers from which data is read are selected by parameter [160.14 M/F follower selection](#) in the master. In each follower, the data to be sent is selected by parameters [161.01...161.03](#). The data is transferred in integer format over the link, and displayed by parameters [162.28...162.36](#) in the master. The data can then be forwarded to other parameters using [162.04...162.12](#).

To indicate faults in the followers, each follower must be configured to transmit its status word as one of the above-mentioned data words. In the master, the corresponding target parameter must be set to *Follower SW*. The action to be taken when a follower is faulted is selected by [160.17 Follower fault action](#). External events (see parameter group [131 Fault functions](#)) can be used to indicate the status of other bits of the status word.

■ Construction of the master/follower link

The master/follower link is formed by connecting the units together using either

- shielded twisted-pair cable between the XD2D terminals*, or
- fiber optic cables. Supply units with a **ZCU** control unit require an additional FDCO DDCCS communication module; supply units with a **BCU** control unit require an RDCO module.

*This connection cannot co-exist, and is not to be confused with, drive-to-drive (D2D) communication implemented by application programming (detailed in *Drive application programming manual (IEC 61131-3)*, 3AUA0000127808 [English]).

Connection examples are shown below. Note that a star configuration using fiber optic cables requires an NDBU-95C DDCCS branching unit.

Master/follower wiring with electrical cable

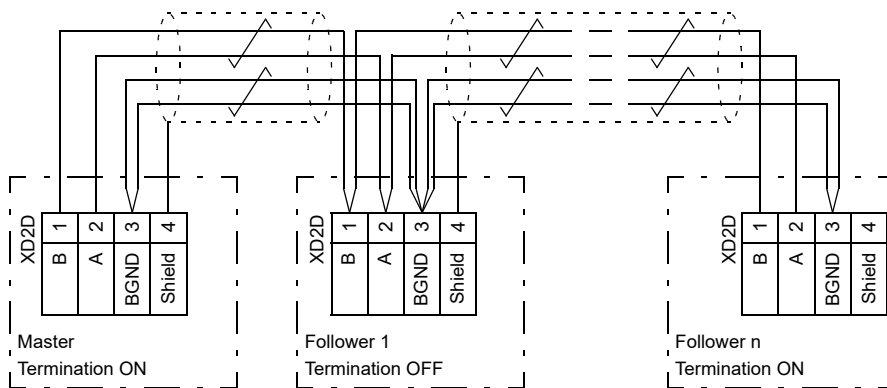

See the hardware manual for wiring and termination details.

Ring configuration with fiber optic cables

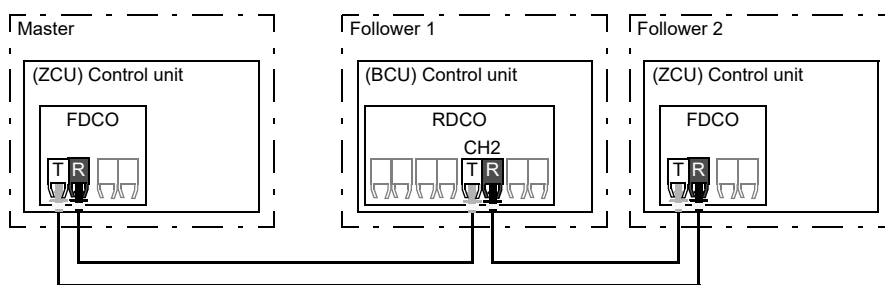

T = Transmitter; R = Receiver

Star configuration with fiber optic cables (1)

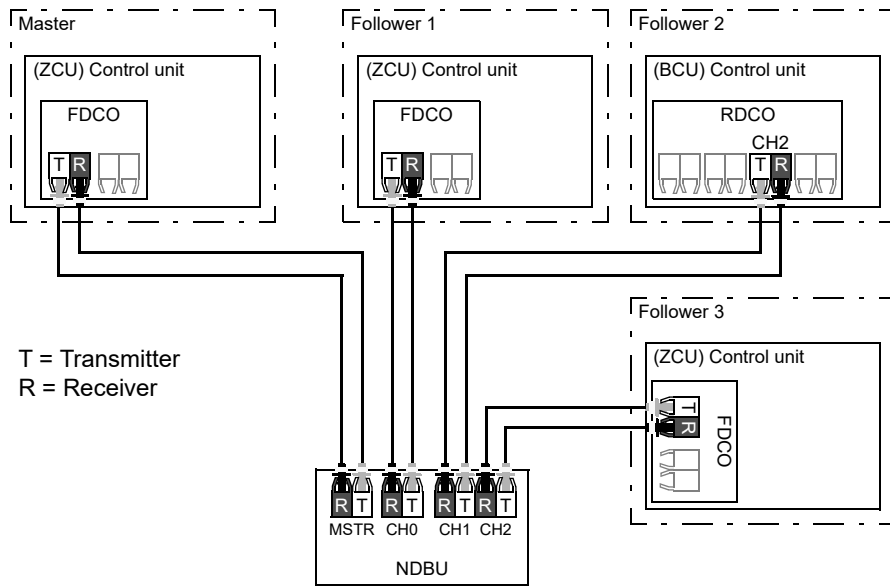

Star configuration with fiber optic cables (2)

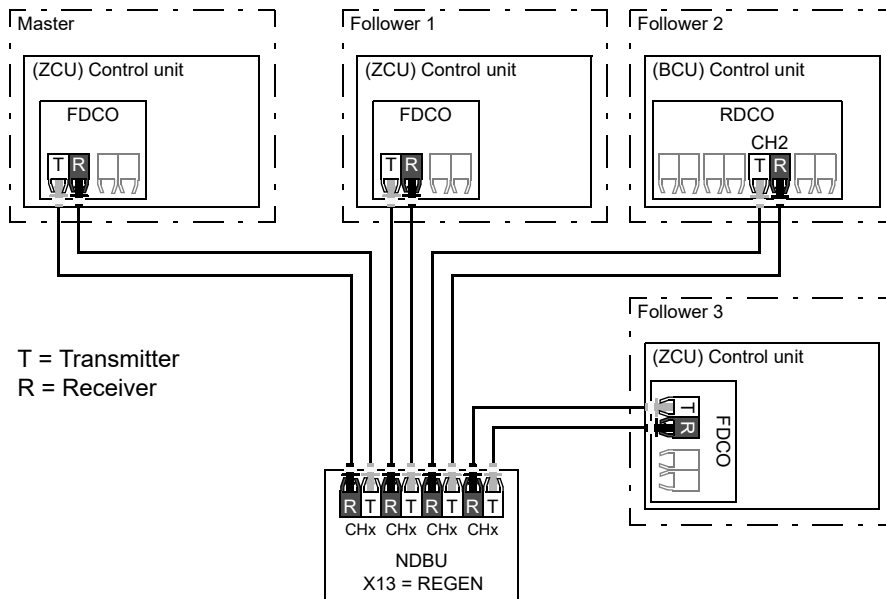

■ Example parameter settings

The following is a checklist of parameters that need to be set when configuring the master/follower link. In this example, the master broadcasts the Follower control word and the references. The follower returns a status word and two actual values (this is not compulsory but is shown for clarity).

Master settings:

- Master/follower link activation
 - *160.01 M/F communication port* (fiber optic channel or XD2D selection)
 - (*160.02 M/F node address* = 1)
 - *160.03 M/F mode* = *DDCS master* (for both fiber optic and wire connection)
 - *160.05 M/F HW connection* (*Ring* or *Star* for fiber optic, *Star* for wire)
- Data to be broadcast to the followers
 - *161.01 M/F data 1 selection* = *Follower CW* (Follower control word)
 - *161.02 M/F data 2 selection* = *Master power*
- Data to be read from the followers (optional)
 - *160.14 M/F follower selection* (selection of followers that data is read from)
 - *162.04 Follower node 2 data 1 sel ... 162.12 Follower node 4 data 3 sel* (mapping of data received from followers)

Follower settings:

- Master/follower link activation
 - *160.01 M/F communication port* (fiber optic channel or XD2D selection)
 - *160.02 M/F node address* = 2...60
 - *160.03 M/F mode* = *DDCS follower* (for both fiber optic and wire connection)
 - *160.05 M/F HW connection* (*Ring* or *Star* for fiber optic, *Star* for wire)
 - Mapping of data received from master
 - *162.01 M/F data 1 selection* = *CW 16bit*
 - *162.02 M/F data 2 selection* = *Ref1 16bit*
 - *162.03 M/F data 3 selection* = *Ref2 16bit*
 - Selection of operating mode
 - *119.12 Ext1 ctrl mode1* = *DC control*
 - Selection of data to be sent to master (optional)
 - *161.01 M/F data 1 selection* = *SW 16bit*
 - *161.02 M/F data 2 selection* = *Act1 16bit*
 - *161.03 M/F data 3 selection* = *Act2 16bit*
-

■ Specifications of the fiber optic master/follower link

- Maximum fiber optic cable length:
 - FDCO-01/02 or RDCO-04 with POF (Plastic Optic Fiber): 30 m
 - FDCO-01/02 or RDCO-04 with HCS (Hard-clad Silica Fiber): 200 m
 - For distances up to 1000 m, use two NOCR-01 optical converter/repeaters with glass optic cable (GOF, 62.5 micrometers, Multi-Mode)
- Maximum shielded twisted-pair cable length: 50 m
- Transmission rate: 4 Mbit/s
- Total performance of the link: < 5 ms to transfer references between the master and followers.
- Protocol: DDCS (Distributed Drives Communication System)

■ Settings and diagnostics

Parameter groups [160 DDCS communication](#) (page 160), [161 DDCS transmit](#) (page 166) and [162 DDCS receive](#) (page 170)

Warnings: [AE81 MF comm loss](#), [AE82 Follower](#)

Faults: [FE06 MF communication loss](#), [FE07 Follower drive failure](#)

Router mode for BCU control unit

The BCU control unit of a supply unit can be set to a “router mode” to allow the control of locally-connected power units (for example, IGBT supply modules) by another BCU. Using the router mode and some hardware switching, it is possible to have the same modules alternate between supply and, for example, inverter use.

The router mode involves connecting the two BCUs together by their PSL2 channels. When router mode is active, the channels coming from the other BCU are forwarded to the local modules.

Notes:

- The local modules must be connected to successive channels starting from CH1. The immediately following channels are connected to the other BCU and routed to the local modules. The number of local modules does not have to be the same between two BCUs, but if BAMU board is used, equal number of power units must be connected to both BCUs. Example configurations are shown below.

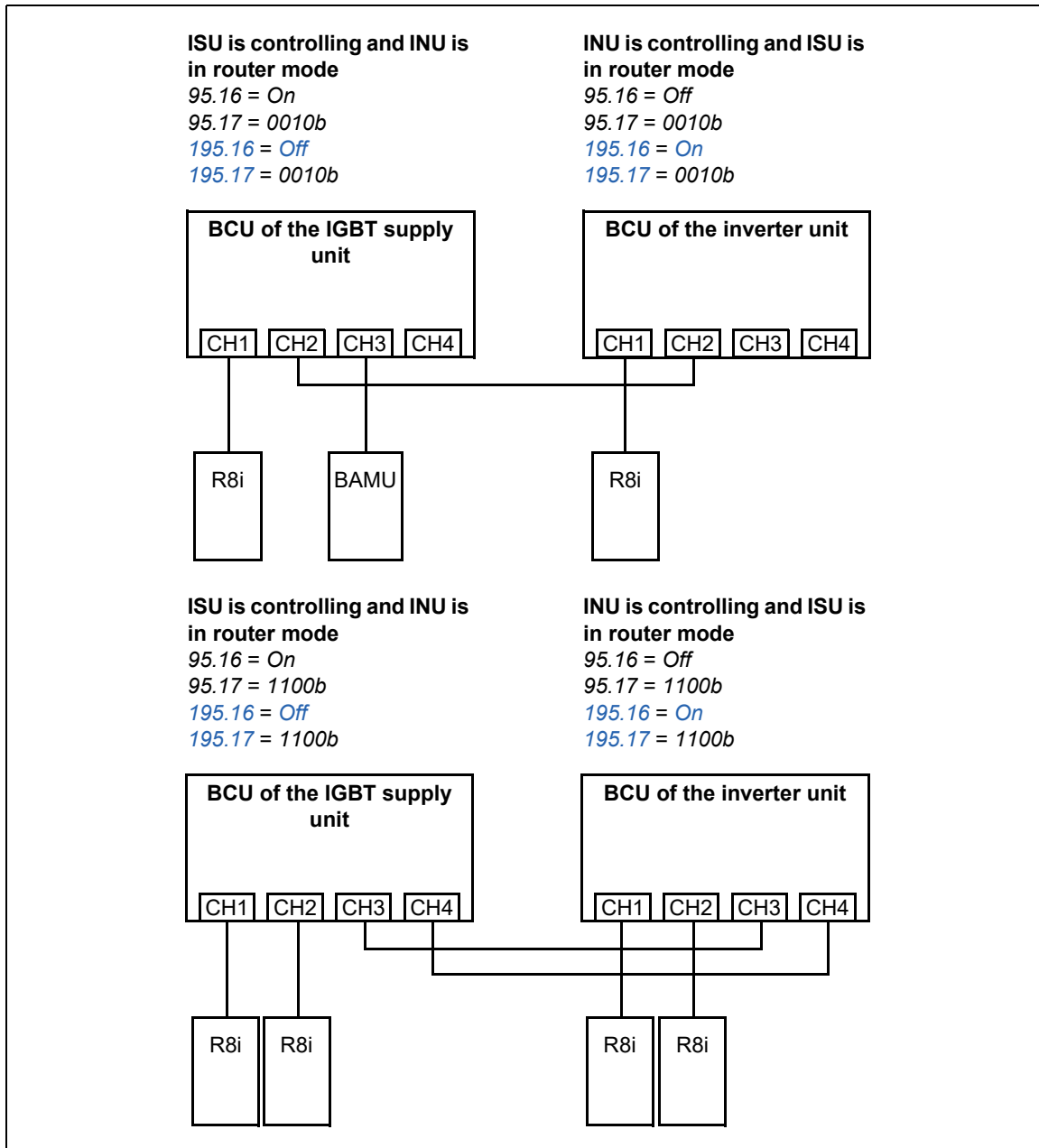

- When BAMU board is used, it must be connected to the last channel of the BCU of the IGBT supply unit.
- The maximum number of channels is 10, and it does not increase when router mode is used.
- In PLC control, any switchovers must be done in stopped state, and so that at least one BCU is in router mode at any given time.

■ Settings

Parameters [195.16 Router mode](#) and [195.17 Router channel config](#) (page 181).

Distributed I/O bus

Distributed I/O bus controls and supervises each cabinet fan separately. It detects malfunctioning fans and indicates them with warning or fault messages. The distributed I/O bus is controlled by CIO-01 I/O module. For more information, see *CIO-01 I/O module for distributed I/O bus control user's manual* (3AXD50000126880 [English]).

■ Settings

Parameter groups [206 I/O bus configuration](#), [207 I/O bus service](#), [208 I/O bus diagnostics](#) and [209 I/O bus fan identification](#) (page 191).

Similar supervisions to the ones activated from parameters [131.38 Fuse trip fault source](#) and [131.39 Brake chopper fault source](#) (page 137) via standard I/O can be activated also via distributed I/O.

Distributed I/O is available for liquid-cooled units only.

BAMU measurements

BAMU auxiliary measurement unit is a multipurpose measurement unit for voltage and current measurement. Measurement settings for BAMU unit are configured with parameters of parameter group [191 BAMU configuration](#), and the grid signals measured by it are visible in parameter group [190 BAMU measurements](#).

Optimal grid control functionality is typical application that requires BAMU unit measurements. For more information, see *Optimal grid control of ACS880 IGBT supply control program supplement* (3AXD50000164745 [English]).

■ Main circuit configuration

To use BAMU unit measurements in all operation modes, user needs to define measurement locations for transformer and circuit breaker. The control program determines allowed configurations and trips the supply unit on fault in case of incorrect configuration. User can define used main circuit configuration with parameters [191.40](#) and [191.41](#).

Voltage U1 measurement is used in optimal grid control functionality to synchronize to grid and to close the main circuit breaker while converter is started. U1 measurement is also used for voltage feedback for converter. While converter is started and there is an existing grid in optimal grid converter output, voltage U2 measurement can be used for external grid synchronization between grid and external grid. User can define measurement locations for voltages U1 and U2 with parameters [191.42](#) and [191.43](#).

General rules for the settings

- If optimal grid control functionality is in use, voltage U1 measurement must be enabled with parameter [191.01 U1 measurement](#).
- If parameter [191.01 U1 measurement](#) or [191.10 U2 measurement](#) is enabled, parameters [191.40...191.43](#) must be set to other value than *Not set*.
- In optimal grid control functionality, voltage U1 measurement must be on the grid-side of the circuit breaker.
- Voltage U2 measurement cannot be on the converter-side of voltage U1 measurement.

■ Settings and diagnostics

Parameters: parameter groups [190 BAMU measurements](#) and [191 BAMU configuration](#)

Faults: [5E12 BAMU configuration](#)

Warnings: [5E1C BAMU meas settings](#)

Active damping

Active damping functionality improves control stability in weak grids and when the converter is supplied by a generator. When grid voltage magnitude or angle changes quickly, active damping functionality slows down DC voltage control. Active damping is used in transient situations but it does not affect normal operation in steady operating conditions.

■ Settings

Parameter [197.20 Dc-ctrl active damping](#) (page [190](#)).

6

Parameters

What this chapter contains

The chapter describes the parameters, including actual signals, of the control program.

Terms and abbreviations

Term	Definition
Actual signal	Type of <i>parameter</i> that is the result of a measurement or calculation by the IGBT supply unit, or contains status information. Most actual signals are read-only, but some (especially counter-type actual signals) can be reset.
Def	(In the following table, shown on the same row as the parameter name) The default value of a <i>parameter</i> .
FbEq16	(In the following table, shown on the same row as the parameter range, or for each selection) 16-bit fieldbus equivalent: The scaling between the integer used in communication and the value shown on the panel when a 16-bit value is selected for transmission to an external system. A dash (-) indicates that the parameter is not accessible in 16-bit format. The corresponding 32-bit scalings are listed in chapter <i>Additional parameter data</i> (page 193).
Other	The value is taken from another source.
Parameter	Either an user-adjustable operating instruction for the IGBT supply unit, or an <i>actual signal</i> .
p.u.	Per unit

Reserved digital inputs and relay outputs

For the cabinet-installed unit, digital inputs and relay outputs are typically defined in use and connected to the appropriate control circuits already at the factory. Do not change the settings of the reserved digital inputs or relay outputs. See the delivery-specific circuit diagrams and subsections *Default I/O connection diagram (BCU)* on page 46, and *Default I/O connection diagram (ZCU)* on page 48.

Summary of parameter groups

Group	Contents	Page
101 Actual values	Basic signals for monitoring of the IGBT supply unit.	65
103 Input references	Values of references received from various sources.	67
104 Warnings and faults	Information on warnings and faults that occurred last.	68
105 Diagnostics	Various run-time-type counters and measurements related to IGBT supply unit maintenance.	73
106 Control and status words	Control and status words.	74
107 System info	Hardware and firmware information.	80
110 Standard DI, RO	Configuration of digital inputs and relay outputs.	81
111 Standard DIO, FI, FO	Configuration of digital input/outputs and frequency inputs/outputs.	85
112 Standard AI	Configuration of standard analog inputs.	88
113 Standard AO	Configuration of analog outputs.	91
114 Extension I/O module 1	Configuration of I/O extension module 1.	94
115 Extension I/O module 2	Configuration of I/O extension module 2.	109
116 Extension I/O module 3	Configuration of I/O extension module 3.	113
119 Operation mode	Selection of external control location sources and operating modes.	116
120 Start/stop	Start/stop and run/start enable signal source selection; charging settings.	117
121 Start/stop mode	Emergency stop settings.	122
122 Power reference	Settings of the active power reference chain.	122
123 DC voltage reference	Settings of the DC voltage reference chain.	124
124 Reactive power reference	Settings of the reactive power reference chain.	125
130 Limits	Operation limits of the IGBT supply unit.	129
131 Fault functions	Settings that define the behavior of the IGBT supply unit upon fault situations.	133
133 Generic timer & counter	Configuration of maintenance timers/counters.	139
136 Load analyzer	Peak value and amplitude logger settings.	144
146 Monitoring settings	Scaling settings.	147
147 Data storage	Parameters that can be written to and read from by using source and target settings of other parameters.	148
149 Panel port communication	Communication settings for the control panel port.	150
150 FBA	General settings for fieldbus communication configuration.	150
151 FBA A settings	Fieldbus adapter A configuration.	155
152 FBA A data in	Selection of data to be transferred from IGBT supply unit to fieldbus controller through fieldbus adapter A.	156
153 FBA A data out	Selection of data to be transferred from fieldbus controller to IGBT supply unit through fieldbus adapter A.	157
154 FBA B settings	Fieldbus adapter B configuration.	157
155 FBA B data in	Selection of data to be transferred from IGBT supply unit to fieldbus controller through fieldbus adapter B.	159
156 FBA B data out	Selection of data to be transferred from fieldbus controller to IGBT supply unit through fieldbus adapter B.	159
160 DDCS communication	DDCS communication configuration.	160
161 DDCS transmit	Defines the data sent to the DDCS link.	166
162 DDCS receive	Mapping of data received through the DDCS link.	170
190 BAMU measurements	Grid measurement signals from BAMU measurement unit.	177
191 BAMU configuration	Settings for BAMU measurement unit.	178
195 HW configuration	Various hardware-related settings.	180

64 Parameters

Group	Contents	Page
<i>196 System</i>	Language selection; parameter save and restore; control unit reboot; user lock.	<i>184</i>
<i>197 Grid control</i>	Configuration of the active damping functionality.	<i>190</i>
<i>199 Off grid configuration</i>	Configuration of the optimal grid control functionality.	<i>190</i>
<i>206 I/O bus configuration</i> <i>207 I/O bus service</i> <i>208 I/O bus diagnostics</i> <i>209 I/O bus fan identification</i>	Distributed I/O bus settings.	<i>191</i>

Parameter listing

No.	Name/Value	Description	Def/FbEq16
<i>101 Actual values</i>		Basic signals for monitoring of the IGBT supply unit. All parameters in this group are read-only unless otherwise noted.	
<i>101.01</i>	<i>DC voltage</i>	Measured intermediate circuit voltage in Volts.	-
	0.00 ... 2000.00 V	Measured intermediate circuit voltage.	See par. 146.04
<i>101.02</i>	<i>Line current</i>	Estimated line current in Amperes.	-
	-	Estimated line current.	1 = 1 A
<i>101.03</i>	<i>Line current %</i>	Estimated line current in percent of the nominal value.	
	0.0 ... 1000.0%	Estimated line current in percent of the nominal value.	1 = 1%
<i>101.04</i>	<i>Active current</i>	Estimated fundamental frequency active current in Amperes.	-
	-	Estimated fundamental frequency active current.	See par. 146.01
<i>101.05</i>	<i>Active current %</i>	Estimated active current in percent of the nominal value.	-
	-1000.0 ... 1000.0%	Estimated active current in percent of the nominal value.	1 = 1%
<i>101.06</i>	<i>Reactive current</i>	Estimated reactive current in Amperes.	-
	-	Estimated reactive current.	See par. 146.02
<i>101.07</i>	<i>Reactive current %</i>	Estimated reactive current in percent of the nominal value.	-
	-1000.0 ... 1000.0%	Estimated reactive current in percent of the nominal value.	1 = 1%
<i>101.08</i>	<i>Frequency</i>	Estimated frequency of power supply network.	-
	0.00...100.00 Hz	Estimated frequency of power supply network.	100 = 1 Hz
<i>101.09</i>	<i>Grid voltage</i>	Estimated voltage of power supply network in Volts.	-
	0.00...1000.00 V	Estimated voltage of power supply network.	1 = 1 V
<i>101.10</i>	<i>Apparent power</i>	Estimated apparent power in kVA.	-
	-	Estimated apparent power.	1 = 1 kVA
<i>101.11</i>	<i>Apparent power %</i>	Estimated apparent power in percent of the nominal value.	-
	-1000.0 ... 1000.0%	Estimated apparent power in percent of the nominal value.	1 = 1%
<i>101.12</i>	<i>Power</i>	Estimated IGBT supply unit fundamental frequency power in kW. Sign can be changed with parameter 130.47 Power sign change . (positive = power flow from power supply network to intermediate circuit, negative = power flow from intermediate circuit to power supply network)	-
	-	Estimated IGBT supply unit fundamental frequency power.	See par. 146.01
<i>101.13</i>	<i>Power %</i>	Estimated fundamental frequency input power in percent of the nominal value.	-
	-1000.0 ... 1000.0%	Estimated fundamental frequency input power in percent of the nominal value.	1 = 1%
<i>101.14</i>	<i>Reactive power</i>	Estimated reactive power in kVA. (positive = capacitive, negative = inductive)	-
	-	Estimated reactive power.	See par. 146.02
<i>101.15</i>	<i>Reactive power %</i>	Estimated reactive power in percent.	-
	-1000.0 ... 1000.0%	Estimated reactive power in percent.	1 = 1%
<i>101.16</i>	<i>CosPhi</i>	Cos phi.	-
	-1.00 ... 1.00	Cos phi.	100 = 1

66 Parameters

No.	Name/Value	Description	Def/FbEq16
101.20	<i>Converter current</i>	Measured converter module current in Amperes.	-
	-	Measured converter module current.	1 = 1 A
101.21	<i>Converter current %</i>	Measured converter module current in percent.	-
	0.0...1000.0%	Measured converter module current in percent.	1 = 1%
101.22	<i>kWh supply</i>	Counts the net kWh. Motoring side minus generating side.	-
	0...1000 kWh	kWh value.	10 = 1 kWh
101.23	<i>MWh supply</i>	Counts the net MWh. Motoring side minus generating side.	-
	0...1000 MWh	MWh value.	1 = 1 MWh
101.24	<i>GWh supply</i>	Counts the net GWh. Motoring side minus generating side.	-
	-32768... 32767 GWh	GWh value.	1 = 1 GWh
101.25	<i>kWh motoring</i>	Counts kWh for motoring side.	-
	0...1000 kWh	kWh value.	10 = 1 kWh
101.26	<i>MWh motoring</i>	Counts MWh for motoring side.	-
	0...1000 MWh	MWh value.	1 = 1 MWh
101.27	<i>GWh motoring</i>	Counts the motoring side GWh.	-
	0...32767 GWh	GWh value.	1 = 1 GWh
101.28	<i>kWh generating</i>	Counts kWh for generating side.	-
	0...1000 kWh	kWh value.	10 = 1 kWh
101.29	<i>MWh generating</i>	Counts MWh for generating side.	-
	0...1000 MWh	MWh value.	1 = 1 MWh
101.30	<i>GWh generating</i>	Counts the generating side GWh.	-
	0...32767 GWh	GWh value.	1 = 1 GWh
101.31	<i>Ambient temperature</i>	Temperature of module incoming air [°C].	-
	0...100 °C	Ambient temperature.	1 = 1 °C
101.33	<i>Reactive power reserve</i>	<p>Calculates reactive power reserve based on nominal power and active power. Maximum reserve in no-load situation is 80% of nominal power The figure below shows the capacity to produce reactive power relative to nominal power.</p> <p>The graph plots Relative reactive power on the y-axis (0 to 90) against Relative active power on the x-axis (0 to 110). The curve starts at 80% reactive power when active power is 0% and decreases as active power increases, reaching 0% reactive power at 100% active power.</p>	-
	-30000.00... 30000.00 kVAr	Reactive power.	1 = 1 kVAr
101.61	<i>Nominal supply voltage</i>	Nominal supply voltage of the converter [V].	-
	0...2000 V	Nominal supply voltage.	1 = 1 V

No.	Name/Value	Description	Def/FbEq16
101.62	<i>Nominal DC voltage</i>	Nominal DC voltage of the converter [V].	-
	0...2000 V	Nominal DC voltage.	1 = 1 V
101.63	<i>Nominal current</i>	Nominal current from the supply modules before LCL filter [A].	-
	0...30000 A	Nominal current.	1 = 1 A
101.64	<i>Nominal power</i>	Nominal power of the converter [V].	-
	0...30000 kW	Nominal power.	1 = 1 kW
101.70	<i>Ambient temperature %</i>	Ambient temperature of supply unit in percent. 0...100% corresponds to 0...60 °C or 32...140 °F. See also 101.31 Ambient temperature .	-
	-200.00...200.00%	Ambient temperature in percent.	100 = 1%
<i>103 Input references</i>		Values of references received from various sources. All parameters in this group are read-only unless otherwise noted.	
103.01	<i>Panel reference</i>	Reference 1 given from the control panel.	-
	-100000.00 ... 100000.00	Control panel reference.	1 = 10
103.05	<i>FB A reference 1</i>	Scaled fieldbus A reference 1.	-
	-100000.00 ... 100000.00	Fieldbus A reference 1.	1 = 10
103.06	<i>FB A reference 2</i>	Scaled fieldbus A reference 2.	-
	-100000.00 ... 100000.00	Fieldbus A reference 2.	1 = 10
103.07	<i>FB B reference 1</i>	Scaled fieldbus B reference 1.	-
	-100000.00 ... 100000.00	Fieldbus B reference 1.	1 = 10
103.08	<i>FB B reference 2</i>	Scaled fieldbus B reference 2.	-
	-100000.00 ... 100000.00	Fieldbus B reference 2.	1 = 10
103.11	<i>DDCS controller ref 1</i>	Reference 1 received from the external (DDCS) controller. The value has been scaled according to parameter 160.60 DDCS controller ref1 type . See also section Setting up communication through inverter unit on page 264.	-
	-30000.00 ... 30000.00	Scaled reference 1 received from external controller.	1 = 10
103.12	<i>DDCS controller ref 2</i>	Reference 2 received from the external (DDCS) controller. The value has been scaled according to parameter 160.61 DDCS controller ref2 type . See also section Setting up communication through inverter unit on page 264.	-
	-30000.00 ... 30000.00	Scaled reference 2 received from external controller.	1 = 10
103.13	<i>M/F or D2D ref1</i>	Master/follower reference 1 received from the master. The value has been scaled according to parameter 160.10 M/F ref1 type . See also section Master/follower functionality (page 53).	1 = 10
	-30000.00 ... 30000.00	Scaled reference 1 received from master.	1 = 10
103.14	<i>M/F or D2D ref2</i>	Master/follower reference 2 received from the master. The value has been scaled according to parameter 160.11 M/F ref2 type .	1 = 10
	-30000.00 ... 30000.00	Scaled reference 2 received from master.	1 = 10

No.	Name/Value	Description	Def/FbEq16
<i>104 Warnings and faults</i>		Information on warnings and faults that occurred last. For explanations of individual warning and fault codes, see chapter <i>Fault tracing</i> . All parameters in this group are read-only unless otherwise noted.	
<i>104.01</i>	<i>Tripping fault</i>	Code of the 1st active fault (the fault that caused the current trip).	-
	0000h...FFFFh	1st active fault.	1 = 1
<i>104.02</i>	<i>Active fault 2</i>	Code of the 2nd active fault.	-
	0000h...FFFFh	2nd active fault.	1 = 1
<i>104.03</i>	<i>Active fault 3</i>	Code of the 3rd active fault.	-
	0000h...FFFFh	3rd active fault.	1 = 1
<i>104.04</i>	<i>Active fault 4</i>	Code of the 4th active fault.	-
	0000h...FFFFh	4th active fault.	1 = 1
<i>104.05</i>	<i>Active fault 5</i>	Code of the 5th active fault.	-
	0000h...FFFFh	5th active fault.	1 = 1
<i>104.06</i>	<i>Active warning 1</i>	Code of the 1st active warning.	-
	0000h...FFFFh	1st active warning.	1 = 1
<i>104.07</i>	<i>Active warning 2</i>	Code of the 2nd active warning.	-
	0000h...FFFFh	2nd active warning.	1 = 1
<i>104.08</i>	<i>Active warning 3</i>	Code of the 3rd active warning.	-
	0000h...FFFFh	3rd active warning.	1 = 1
<i>104.09</i>	<i>Active warning 4</i>	Code of the 4th active warning.	-
	0000h...FFFFh	4th active warning.	1 = 1
<i>104.10</i>	<i>Active warning 5</i>	Code of the 5th active warning.	-
	0000h...FFFFh	5th active warning.	1 = 1
<i>104.11</i>	<i>Latest fault</i>	Code of the 1st stored (non-active) fault.	-
	0000h...FFFFh	1st stored fault.	1 = 1
<i>104.12</i>	<i>2nd latest fault</i>	Code of the 2nd stored (non-active) fault.	-
	0000h...FFFFh	2nd stored fault.	1 = 1
<i>104.13</i>	<i>3rd latest fault</i>	Code of the 3rd stored (non-active) fault.	-
	0000h...FFFFh	3rd stored fault.	1 = 1
<i>104.14</i>	<i>4th latest fault</i>	Code of the 4th stored (non-active) fault.	-
	0000h...FFFFh	4th stored fault.	1 = 1
<i>104.15</i>	<i>5th latest fault</i>	Code of the 5th stored (non-active) fault.	-
	0000h...FFFFh	5th stored fault.	1 = 1
<i>104.16</i>	<i>Latest warning</i>	Code of the 1st stored (non-active) warning.	-
	0000h...FFFFh	1st stored warning.	1 = 1
<i>104.17</i>	<i>2nd latest warning</i>	Code of the 2nd stored (non-active) warning.	-
	0000h...FFFFh	2nd stored warning.	1 = 1
<i>104.18</i>	<i>3rd latest warning</i>	Code of the 3rd stored (non-active) warning.	-
	0000h...FFFFh	3rd stored warning.	1 = 1
<i>104.19</i>	<i>4th latest warning</i>	Code of the 4th stored (non-active) warning.	-
	0000h...FFFFh	4th stored warning.	1 = 1
<i>104.20</i>	<i>5th latest warning</i>	Code of the 5th stored (non-active) warning.	-
	0000h...FFFFh	5th stored warning.	1 = 1

No.	Name/Value	Description	Def/FbEq16																																		
104.21	<i>Fault word 1</i>	A 16-bit unsigned data word indicating predefined events. See section <i>Fault and warning words</i> on page 226.																																			
<table border="1"> <thead> <tr> <th>Bit</th> <th>Name</th> </tr> </thead> <tbody> <tr><td>0</td><td>LSU charging (3E08)</td></tr> <tr><td>1</td><td>Overcurrent (2E00)</td></tr> <tr><td>2</td><td>External earth leakage (2E08)</td></tr> <tr><td>3</td><td>Power unit temperature (several events, see page 226)</td></tr> <tr><td>4</td><td>Auxiliary circuit Breaker (5E13)</td></tr> <tr><td>5</td><td>Fan failure (4E06)</td></tr> <tr><td>6</td><td>Main contactor (5E06)</td></tr> <tr><td>7</td><td>Short circuit (2E02)</td></tr> <tr><td>8</td><td>Internal system fault (several events, see page 226)</td></tr> <tr><td>9</td><td>Net lost (8E07)</td></tr> <tr><td>10</td><td>Field bus comm (several events, see page 226)</td></tr> <tr><td>11</td><td>External fault 1 (9E01)</td></tr> <tr><td>12</td><td>Earth leakage (2E01)</td></tr> <tr><td>13</td><td>Synchronization fault (6E19)</td></tr> <tr><td>14</td><td>Undervoltage (3E05)</td></tr> <tr><td>15</td><td>Overvoltage (3E04)</td></tr> </tbody> </table>				Bit	Name	0	LSU charging (3E08)	1	Overcurrent (2E00)	2	External earth leakage (2E08)	3	Power unit temperature (several events, see page 226)	4	Auxiliary circuit Breaker (5E13)	5	Fan failure (4E06)	6	Main contactor (5E06)	7	Short circuit (2E02)	8	Internal system fault (several events, see page 226)	9	Net lost (8E07)	10	Field bus comm (several events, see page 226)	11	External fault 1 (9E01)	12	Earth leakage (2E01)	13	Synchronization fault (6E19)	14	Undervoltage (3E05)	15	Overvoltage (3E04)
Bit	Name																																				
0	LSU charging (3E08)																																				
1	Overcurrent (2E00)																																				
2	External earth leakage (2E08)																																				
3	Power unit temperature (several events, see page 226)																																				
4	Auxiliary circuit Breaker (5E13)																																				
5	Fan failure (4E06)																																				
6	Main contactor (5E06)																																				
7	Short circuit (2E02)																																				
8	Internal system fault (several events, see page 226)																																				
9	Net lost (8E07)																																				
10	Field bus comm (several events, see page 226)																																				
11	External fault 1 (9E01)																																				
12	Earth leakage (2E01)																																				
13	Synchronization fault (6E19)																																				
14	Undervoltage (3E05)																																				
15	Overvoltage (3E04)																																				
0000h...FFFFh		Fault word 1.	1 = 1																																		
104.31	<i>Warning word 1</i>	A 16-bit unsigned data word indicating predefined events. See section <i>Fault and warning words</i> on page 226.																																			
<table border="1"> <thead> <tr> <th>Bit</th> <th>Name</th> </tr> </thead> <tbody> <tr><td>0</td><td>Field bus comm (several events, see page 226)</td></tr> <tr><td>1</td><td>Panel loss (AE3E)</td></tr> <tr><td>2</td><td>Fan (AE73)</td></tr> <tr><td>3</td><td>Not in use.</td></tr> <tr><td>4</td><td>Power unit temperature (several events, see page 226)</td></tr> <tr><td>5</td><td>External warning 5 (AE55)</td></tr> <tr><td>6...9</td><td>Not in use.</td></tr> <tr><td>10</td><td>Net lost (AE78)</td></tr> <tr><td>11</td><td>External warning 2 (AE52)</td></tr> <tr><td>12</td><td>Not in use.</td></tr> <tr><td>13</td><td>Earth leakage (AE02)</td></tr> <tr><td>14</td><td>External warning 3 (AE53)</td></tr> <tr><td>15</td><td>External warning 4 (AE54)</td></tr> </tbody> </table>				Bit	Name	0	Field bus comm (several events, see page 226)	1	Panel loss (AE3E)	2	Fan (AE73)	3	Not in use.	4	Power unit temperature (several events, see page 226)	5	External warning 5 (AE55)	6...9	Not in use.	10	Net lost (AE78)	11	External warning 2 (AE52)	12	Not in use.	13	Earth leakage (AE02)	14	External warning 3 (AE53)	15	External warning 4 (AE54)						
Bit	Name																																				
0	Field bus comm (several events, see page 226)																																				
1	Panel loss (AE3E)																																				
2	Fan (AE73)																																				
3	Not in use.																																				
4	Power unit temperature (several events, see page 226)																																				
5	External warning 5 (AE55)																																				
6...9	Not in use.																																				
10	Net lost (AE78)																																				
11	External warning 2 (AE52)																																				
12	Not in use.																																				
13	Earth leakage (AE02)																																				
14	External warning 3 (AE53)																																				
15	External warning 4 (AE54)																																				
0000h...FFFFh		Warning word 1.	1 = 1																																		

70 Parameters

No.	Name/Value	Description	Def/FbEq16																																																																				
104.40	<i>Event word 1</i>	A 16-bit unsigned data word indicating customer-selected events. For each bit, there are two programming parameters which event code and optionally auxiliary code activates the bit. Bit value false = no fault or warning Bit value true = selected event fault or warning is active																																																																					
		<table border="1"> <thead> <tr> <th>Bit</th> <th>Name</th> <th>Parameter for event code</th> <th>Parameter for auxiliary code</th> </tr> </thead> <tbody> <tr><td>0</td><td>User bit 0</td><td>104.41 Event word 1 bit 0 code</td><td>104.42 Event word 1 bit 0 aux code</td></tr> <tr><td>1</td><td>User bit 1</td><td>104.43 Event word 1 bit 1 code</td><td>104.44 Event word 1 bit 1 aux code</td></tr> <tr><td>2</td><td>User bit 2</td><td>104.45 Event word 1 bit 2 code</td><td>104.46 Event word 1 bit 2 aux code</td></tr> <tr><td>3</td><td>User bit 3</td><td>104.47 Event word 1 bit 3 code</td><td>104.48 Event word 1 bit 3 aux code</td></tr> <tr><td>4</td><td>User bit 4</td><td>104.49 Event word 1 bit 4 code</td><td>104.50 Event word 1 bit 4 aux code</td></tr> <tr><td>5</td><td>User bit 5</td><td>104.51 Event word 1 bit 5 code</td><td>104.52 Event word 1 bit 5 aux code</td></tr> <tr><td>6</td><td>User bit 6</td><td>104.53 Event word 1 bit 6 code</td><td>104.54 Event word 1 bit 6 aux code</td></tr> <tr><td>7</td><td>User bit 7</td><td>104.55 Event word 1 bit 7 code</td><td>104.56 Event word 1 bit 7 aux code</td></tr> <tr><td>8</td><td>User bit 8</td><td>104.57 Event word 1 bit 8 code</td><td>104.58 Event word 1 bit 8 aux code</td></tr> <tr><td>9</td><td>User bit 9</td><td>104.59 Event word 1 bit 9 code</td><td>104.60 Event word 1 bit 9 aux code</td></tr> <tr><td>10</td><td>User bit 10</td><td>104.61 Event word 1 bit 10 code</td><td>104.62 Event word 1 bit 10 aux code</td></tr> <tr><td>11</td><td>User bit 11</td><td>104.63 Event word 1 bit 11 code</td><td>104.64 Event word 1 bit 11 aux code</td></tr> <tr><td>12</td><td>User bit 12</td><td>104.65 Event word 1 bit 12 code</td><td>104.66 Event word 1 bit 12 aux code</td></tr> <tr><td>13</td><td>User bit 13</td><td>104.67 Event word 1 bit 13 code</td><td>104.68 Event word 1 bit 13 aux code</td></tr> <tr><td>14</td><td>User bit 14</td><td>104.69 Event word 1 bit 14 code</td><td>104.70 Event word 1 bit 14 aux code</td></tr> <tr><td>15</td><td>User bit 15</td><td>104.71 Event word 1 bit 15 code</td><td>104.72 Event word 1 bit 15 aux code</td></tr> </tbody> </table>	Bit	Name	Parameter for event code	Parameter for auxiliary code	0	User bit 0	104.41 Event word 1 bit 0 code	104.42 Event word 1 bit 0 aux code	1	User bit 1	104.43 Event word 1 bit 1 code	104.44 Event word 1 bit 1 aux code	2	User bit 2	104.45 Event word 1 bit 2 code	104.46 Event word 1 bit 2 aux code	3	User bit 3	104.47 Event word 1 bit 3 code	104.48 Event word 1 bit 3 aux code	4	User bit 4	104.49 Event word 1 bit 4 code	104.50 Event word 1 bit 4 aux code	5	User bit 5	104.51 Event word 1 bit 5 code	104.52 Event word 1 bit 5 aux code	6	User bit 6	104.53 Event word 1 bit 6 code	104.54 Event word 1 bit 6 aux code	7	User bit 7	104.55 Event word 1 bit 7 code	104.56 Event word 1 bit 7 aux code	8	User bit 8	104.57 Event word 1 bit 8 code	104.58 Event word 1 bit 8 aux code	9	User bit 9	104.59 Event word 1 bit 9 code	104.60 Event word 1 bit 9 aux code	10	User bit 10	104.61 Event word 1 bit 10 code	104.62 Event word 1 bit 10 aux code	11	User bit 11	104.63 Event word 1 bit 11 code	104.64 Event word 1 bit 11 aux code	12	User bit 12	104.65 Event word 1 bit 12 code	104.66 Event word 1 bit 12 aux code	13	User bit 13	104.67 Event word 1 bit 13 code	104.68 Event word 1 bit 13 aux code	14	User bit 14	104.69 Event word 1 bit 14 code	104.70 Event word 1 bit 14 aux code	15	User bit 15	104.71 Event word 1 bit 15 code	104.72 Event word 1 bit 15 aux code	
Bit	Name	Parameter for event code	Parameter for auxiliary code																																																																				
0	User bit 0	104.41 Event word 1 bit 0 code	104.42 Event word 1 bit 0 aux code																																																																				
1	User bit 1	104.43 Event word 1 bit 1 code	104.44 Event word 1 bit 1 aux code																																																																				
2	User bit 2	104.45 Event word 1 bit 2 code	104.46 Event word 1 bit 2 aux code																																																																				
3	User bit 3	104.47 Event word 1 bit 3 code	104.48 Event word 1 bit 3 aux code																																																																				
4	User bit 4	104.49 Event word 1 bit 4 code	104.50 Event word 1 bit 4 aux code																																																																				
5	User bit 5	104.51 Event word 1 bit 5 code	104.52 Event word 1 bit 5 aux code																																																																				
6	User bit 6	104.53 Event word 1 bit 6 code	104.54 Event word 1 bit 6 aux code																																																																				
7	User bit 7	104.55 Event word 1 bit 7 code	104.56 Event word 1 bit 7 aux code																																																																				
8	User bit 8	104.57 Event word 1 bit 8 code	104.58 Event word 1 bit 8 aux code																																																																				
9	User bit 9	104.59 Event word 1 bit 9 code	104.60 Event word 1 bit 9 aux code																																																																				
10	User bit 10	104.61 Event word 1 bit 10 code	104.62 Event word 1 bit 10 aux code																																																																				
11	User bit 11	104.63 Event word 1 bit 11 code	104.64 Event word 1 bit 11 aux code																																																																				
12	User bit 12	104.65 Event word 1 bit 12 code	104.66 Event word 1 bit 12 aux code																																																																				
13	User bit 13	104.67 Event word 1 bit 13 code	104.68 Event word 1 bit 13 aux code																																																																				
14	User bit 14	104.69 Event word 1 bit 14 code	104.70 Event word 1 bit 14 aux code																																																																				
15	User bit 15	104.71 Event word 1 bit 15 code	104.72 Event word 1 bit 15 aux code																																																																				
	0000h...FFFFh	Event word 1.	1 = 1																																																																				
104.41	<i>Event word 1 bit 0 code</i>	Defines a user-selected event code that activates bit 0 in parameter 104.40 Event word 1 if the event is active.	-																																																																				
	0000h...FFFFh	Event code.	1 = 1																																																																				
104.42	<i>Event word 1 bit 0 aux code</i>	Defines a user-selected auxiliary code for the event code defined with parameter 104.41 Event word 1 bit 0 code . Parameter 104.41 Event word 1 bit 0 code activates bit 0 in parameter 104.40 Event word 1 if the event with defined auxiliary code is active. Value 0h means that the auxiliary code is not defined.	-																																																																				
	0000h...FFFFh	Auxiliary code.	1 = 1																																																																				
104.43	<i>Event word 1 bit 1 code</i>	Defines a user-selected event code that activates bit 1 in parameter 104.40 Event word 1 if the event is active.	-																																																																				
	0000h...FFFFh	Event code.	1 = 1																																																																				
104.44	<i>Event word 1 bit 1 aux code</i>	Defines a user-selected auxiliary code for the event code defined with parameter 104.43 Event word 1 bit 1 code . Parameter 104.43 Event word 1 bit 1 code activates bit 1 in parameter 104.40 Event word 1 if the event with defined auxiliary code is active. Value 0h means that the auxiliary code is not defined.	-																																																																				
	0000h...FFFFh	Auxiliary code.	1 = 1																																																																				
104.45	<i>Event word 1 bit 2 code</i>	Defines a user-selected event code that activates bit 2 in parameter 104.40 Event word 1 if the event is active.	-																																																																				
	0000h...FFFFh	Event code.	1 = 1																																																																				
104.46	<i>Event word 1 bit 2 aux code</i>	Defines a user-selected auxiliary code for the event code defined with parameter 104.45 Event word 1 bit 2 code . Parameter 104.45 Event word 1 bit 2 code activates bit 2 in parameter 104.40 Event word 1 if the event with defined auxiliary code is active. Value 0h means that the auxiliary code is not defined.	-																																																																				
	0000h...FFFFh	Auxiliary code.	1 = 1																																																																				

No.	Name/Value	Description	Def/FbEq16
104.47	<i>Event word 1 bit 3 code</i>	Defines a user-selected event code that activates bit 3 in parameter <i>104.40 Event word 1</i> if the event is active.	-
	0000h...FFFFh	Event code.	1 = 1
104.48	<i>Event word 1 bit 3 aux code</i>	Defines a user-selected auxiliary code for the event code defined with parameter <i>104.47 Event word 1 bit 3 code</i> . Parameter <i>104.47 Event word 1 bit 3 code</i> activates bit 3 in parameter <i>104.40 Event word 1</i> if the event with defined auxiliary code is active. Value 0h means that the auxiliary code is not defined.	-
	0000h...FFFFh	Auxiliary code.	1 = 1
104.49	<i>Event word 1 bit 4 code</i>	Defines a user-selected event code that activates bit 4 in parameter <i>104.40 Event word 1</i> if the event is active.	-
	0000h...FFFFh	Event code.	1 = 1
104.50	<i>Event word 1 bit 4 aux code</i>	Defines a user-selected auxiliary code for the event code defined with parameter <i>104.49 Event word 1 bit 4 code</i> . Parameter <i>104.49 Event word 1 bit 4 code</i> activates bit 4 in parameter <i>104.40 Event word 1</i> if the event with defined auxiliary code is active. Value 0h means that the auxiliary code is not defined.	-
	0000h...FFFFh	Auxiliary code.	1 = 1
104.51	<i>Event word 1 bit 5 code</i>	Defines a user-selected event code that activates bit 5 in parameter <i>104.40 Event word 1</i> if the event is active.	-
	0000h...FFFFh	Event code.	1 = 1
104.52	<i>Event word 1 bit 5 aux code</i>	Defines a user-selected auxiliary code for the event code defined with parameter <i>104.51 Event word 1 bit 5 code</i> . Parameter <i>104.51 Event word 1 bit 5 code</i> activates bit 5 in parameter <i>104.40 Event word 1</i> if the event with defined auxiliary code is active. Value 0h means that the auxiliary code is not defined.	-
	0000h...FFFFh	Auxiliary code.	1 = 1
104.53	<i>Event word 1 bit 6 code</i>	Defines a user-selected event code that activates bit 6 in parameter <i>104.40 Event word 1</i> if the event is active.	-
	0000h...FFFFh	Event code.	1 = 1
104.54	<i>Event word 1 bit 6 aux code</i>	Defines a user-selected auxiliary code for the event code defined with parameter <i>104.53 Event word 1 bit 6 code</i> . Parameter <i>104.53 Event word 1 bit 6 code</i> activates bit 6 in parameter <i>104.40 Event word 1</i> if the event with defined auxiliary code is active. Value 0h means that the auxiliary code is not defined.	-
	0000h...FFFFh	Auxiliary code.	1 = 1
104.55	<i>Event word 1 bit 7 code</i>	Defines a user-selected event code that activates bit 7 in parameter <i>104.40 Event word 1</i> if the event is active.	-
	0000h...FFFFh	Event code.	1 = 1
104.56	<i>Event word 1 bit 7 aux code</i>	Defines a user-selected auxiliary code for the event code defined with parameter <i>104.55 Event word 1 bit 7 code</i> . Parameter <i>104.55 Event word 1 bit 7 code</i> activates bit 7 in parameter <i>104.40 Event word 1</i> if the event with defined auxiliary code is active. Value 0h means that the auxiliary code is not defined.	-
	0000h...FFFFh	Auxiliary code.	1 = 1
104.57	<i>Event word 1 bit 8 code</i>	Defines a user-selected event code that activates bit 8 in parameter <i>104.40 Event word 1</i> if the event is active.	-
	0000h...FFFFh	Event code.	1 = 1

72 Parameters

No.	Name/Value	Description	Def/FbEq16
104.58	<i>Event word 1 bit 8 aux code</i>	Defines a user-selected auxiliary code for the event code defined with parameter <i>104.57 Event word 1 bit 8 code</i> . Parameter <i>104.57 Event word 1 bit 8 code</i> activates bit 8 in parameter <i>104.40 Event word 1</i> if the event with defined auxiliary code is active. Value 0h means that the auxiliary code is not defined.	-
	0000h...FFFFh	Auxiliary code.	1 = 1
104.59	<i>Event word 1 bit 9 code</i>	Defines a user-selected event code that activates bit 9 in parameter <i>104.40 Event word 1</i> if the event is active.	-
	0000h...FFFFh	Event code.	1 = 1
104.60	<i>Event word 1 bit 9 aux code</i>	Defines a user-selected auxiliary code for the event code defined with parameter <i>104.59 Event word 1 bit 9 code</i> . Parameter <i>104.59 Event word 1 bit 9 code</i> activates bit 9 in parameter <i>104.40 Event word 1</i> if the event with defined auxiliary code is active. Value 0h means that the auxiliary code is not defined.	-
	0000h...FFFFh	Auxiliary code.	1 = 1
104.61	<i>Event word 1 bit 10 code</i>	Defines a user-selected event code that activates bit 10 in parameter <i>104.40 Event word 1</i> if the event is active.	-
	0000h...FFFFh	Event code.	1 = 1
104.62	<i>Event word 1 bit 10 aux code</i>	Defines a user-selected auxiliary code for the event code defined with parameter <i>104.61 Event word 1 bit 10 code</i> . Parameter <i>104.61 Event word 1 bit 10 code</i> activates bit 10 in parameter <i>104.40 Event word 1</i> if the event with defined auxiliary code is active. Value 0h means that the auxiliary code is not defined.	-
	0000h...FFFFh	Auxiliary code.	1 = 1
104.63	<i>Event word 1 bit 11 code</i>	Defines a user-selected event code that activates bit 11 in parameter <i>104.40 Event word 1</i> if the event is active.	-
	0000h...FFFFh	Event code.	1 = 1
104.64	<i>Event word 1 bit 11 aux code</i>	Defines a user-selected auxiliary code for the event code defined with parameter <i>104.63 Event word 1 bit 11 code</i> . Parameter <i>104.63 Event word 1 bit 11 code</i> activates bit 11 in parameter <i>104.40 Event word 1</i> if the event with defined auxiliary code is active. Value 0h means that the auxiliary code is not defined.	-
	0000h...FFFFh	Auxiliary code.	1 = 1
104.65	<i>Event word 1 bit 12 code</i>	Defines a user-selected event code that activates bit 12 in parameter <i>104.40 Event word 1</i> if the event is active.	-
	0000h...FFFFh	Event code.	1 = 1
104.66	<i>Event word 1 bit 12 aux code</i>	Defines a user-selected auxiliary code for the event code defined with parameter <i>104.65 Event word 1 bit 12 code</i> . Parameter <i>104.65 Event word 1 bit 12 code</i> activates bit 12 in parameter <i>104.40 Event word 1</i> if the event with defined auxiliary code is active. Value 0h means that the auxiliary code is not defined.	-
	0000h...FFFFh	Auxiliary code.	1 = 1
104.67	<i>Event word 1 bit 13 code</i>	Defines a user-selected event code that activates bit 13 in parameter <i>104.40 Event word 1</i> if the event is active.	-
	0000h...FFFFh	Event code.	1 = 1

No.	Name/Value	Description	Def/FbEq16
104.68	<i>Event word 1 bit 13 aux code</i>	Defines a user-selected auxiliary code for the event code defined with parameter <i>104.67 Event word 1 bit 13 code</i> . Parameter <i>104.67 Event word 1 bit 13 code</i> activates bit 13 in parameter <i>104.40 Event word 1</i> if the event with defined auxiliary code is active. Value 0h means that the auxiliary code is not defined.	-
	0000h...FFFFh	Auxiliary code.	1 = 1
104.69	<i>Event word 1 bit 14 code</i>	Defines a user-selected event code that activates bit 14 in parameter <i>104.40 Event word 1</i> if the event is active.	-
	0000h...FFFFh	Event code.	1 = 1
104.70	<i>Event word 1 bit 14 aux code</i>	Defines a user-selected auxiliary code for the event code defined with parameter <i>104.69 Event word 1 bit 14 code</i> . Parameter <i>104.69 Event word 1 bit 14 code</i> activates bit 14 in parameter <i>104.40 Event word 1</i> if the event with defined auxiliary code is active. Value 0h means that the auxiliary code is not defined.	-
	0000h...FFFFh	Auxiliary code.	1 = 1
104.71	<i>Event word 1 bit 15 code</i>	Defines a user-selected event code that activates bit 15 in parameter <i>104.40 Event word 1</i> if the event is active.	-
	0000h...FFFFh	Event code.	1 = 1
104.72	<i>Event word 1 bit 15 aux code</i>	Defines a user-selected auxiliary code for the event code defined with parameter <i>104.71 Event word 1 bit 15 code</i> . Parameter <i>104.71 Event word 1 bit 15 code</i> activates bit 15 in parameter <i>104.40 Event word 1</i> if the event with defined auxiliary code is active. Value 0h means that the auxiliary code is not defined.	-
	0000h...FFFFh	Auxiliary code.	1 = 1
<i>105 Diagnostics</i>		Various run-time-type counters and measurements related to IGBT supply unit maintenance. All parameters in this group are read-only unless otherwise noted.	
105.01	<i>On-time counter</i>	On-time counter. The counter runs when the IGBT supply unit is powered.	-
	0...65535 d	On-time counter.	1 = 1 d
105.02	<i>Run-time counter</i>	Run-time counter. The counter runs when the IGBT supply unit modulates.	-
	0...65535 d	Run-time counter.	1 = 1 d
105.04	<i>Fan on-time counter</i>	Running time of the cooling fan. Can be reset on the control panel by keeping Reset depressed for over 3 seconds. After reset, a new fan ID run is performed.	-
	0...65535 d	Cooling fan run-time counter.	1 = 1 d
105.09	<i>Time from power-up</i>	500-microsecond ticks elapsed since the last boot of the control unit.	-
	0...4294967295	500-microsecond ticks since last boot.	1 = 1
105.11	<i>Converter temperature %</i>	Converter temperature in percent of the fault limit.	-
	-40.0 ... 160.0%	Converter temperature in percent.	1 = 1%
105.21	<i>MCB closing time counter</i>	Counts the closures of the main circuit breaker (MCB). This parameter can be used for maintenance purposes. Depending on application, the maintenance interval of the main circuit breaker may vary. See the maintenance instructions of the main circuit breaker.	-
	0...4294967295	Count of closures of main circuit breaker.	1 = 1

74 Parameters

No.	Name/Value	Description	Def/FbEq16																																		
105.22	<i>Charging relay operation counter</i>	Counts the closures of charging relay. This parameter can be used for maintenance purposes. Depending on application, the maintenance interval of the charging relay may vary.	-																																		
	0...4294967295	Count of closures of charging relay.	1 = 1																																		
105.41	<i>Main fan service counter</i>	Displays the age of the main cooling fan as a percentage of its estimated lifetime. The estimate is based on the duty, operating conditions and other operating parameters of the fan. When the counter reaches 100%, a warning (<i>AE84 Fan service counter</i>) is generated. Can be reset from the control panel by keeping Reset depressed for over 3 seconds.	-																																		
	0...150%	Main cooling fan age.	1 = 1%																																		
105.42	<i>Aux. fan service counter</i>	Displays the age of the auxiliary cooling fan as a percentage of its estimated lifetime. The estimate is based on the duty, operating conditions and other operating parameters of the fan. When the counter reaches 100%, a warning (<i>AE84 Fan service counter</i>) is generated. Can be reset from the control panel by keeping Reset depressed for over 3 seconds.	-																																		
	0...150%	Auxiliary cooling fan age.	1 = 1%																																		
<i>106 Control and status words</i>		Control and status words.																																			
106.01	<i>Main control word</i>	The main control word of the IGBT supply unit. This parameter shows the control signals as received from the selected sources (such as digital inputs, the fieldbus interface and the application program). This parameter is read-only. The bit assignments are shown in the table below. For detailed bit descriptions, see page 260.	-																																		
		<table border="1"> <thead> <tr> <th>Bit</th> <th>Name</th> </tr> </thead> <tbody> <tr><td>0</td><td>On/Off</td></tr> <tr><td>1</td><td>Off 2</td></tr> <tr><td>2</td><td>Off 3</td></tr> <tr><td>3</td><td>Start</td></tr> <tr><td>4</td><td>-</td></tr> <tr><td>5</td><td>-</td></tr> <tr><td>6</td><td>-</td></tr> <tr><td>7</td><td>Reset</td></tr> <tr><td>8</td><td>-</td></tr> <tr><td>9</td><td>-</td></tr> <tr><td>10</td><td>Remote cmd</td></tr> <tr><td>11</td><td>Ext ctrl loc</td></tr> <tr><td>12</td><td>User bit 0</td></tr> <tr><td>13</td><td>User bit 1</td></tr> <tr><td>14</td><td>User bit 2</td></tr> <tr><td>15</td><td>User bit 3</td></tr> </tbody> </table>	Bit	Name	0	On/Off	1	Off 2	2	Off 3	3	Start	4	-	5	-	6	-	7	Reset	8	-	9	-	10	Remote cmd	11	Ext ctrl loc	12	User bit 0	13	User bit 1	14	User bit 2	15	User bit 3	
Bit	Name																																				
0	On/Off																																				
1	Off 2																																				
2	Off 3																																				
3	Start																																				
4	-																																				
5	-																																				
6	-																																				
7	Reset																																				
8	-																																				
9	-																																				
10	Remote cmd																																				
11	Ext ctrl loc																																				
12	User bit 0																																				
13	User bit 1																																				
14	User bit 2																																				
15	User bit 3																																				
	0000h...FFFFh	Main control word.	1 = 1																																		
106.02	<i>Application control word</i>	The control word received from the application program (if any). This parameter is read-only. The bit assignments of the word are as described on page 260.	-																																		
	0000h...FFFFh	Application program control word.	1 = 1																																		

No.	Name/Value	Description	Def/FbEq16																																																
106.03	<i>FBA A transparent control word</i>	The control word from fieldbus A, when transparent profile is used.	-																																																
	0...4294967295	The control word from fieldbus A.	1 = 1																																																
106.04	<i>FBA B transparent control word</i>	Displays the unaltered control word received from the PLC through fieldbus adapter B when a transparent communication profile is selected eg. by parameter group 154 FBA B settings . See section Control word and Status word (page 257). This parameter is read-only.	-																																																
	00000000h ... FFFFFFFFh	Control word received through fieldbus adapter B.	1 = 1																																																
106.11	<i>Main status word</i>	Main status word of the IGBT supply unit. This parameter is read-only. The bit assignments are shown in the table below. For detailed bit descriptions, see page 261 . <table border="1" data-bbox="678 779 1136 1335"> <thead> <tr> <th>Bit</th> <th>Name</th> </tr> </thead> <tbody> <tr><td>0</td><td>Ready to switch ON</td></tr> <tr><td>1</td><td>Ready run</td></tr> <tr><td>2</td><td>Ready ref</td></tr> <tr><td>3</td><td>Tripped</td></tr> <tr><td>4</td><td>-</td></tr> <tr><td>5</td><td>-</td></tr> <tr><td>6</td><td>-</td></tr> <tr><td>7</td><td>Warning</td></tr> <tr><td>8</td><td>Modulating</td></tr> <tr><td>9</td><td>Remote</td></tr> <tr><td>10</td><td>Net OK</td></tr> <tr><td>11</td><td>User bit 0</td></tr> <tr><td>12</td><td>User bit 1</td></tr> <tr><td>13</td><td>User bit 2</td></tr> <tr><td>14</td><td>Charging</td></tr> <tr><td>15</td><td>User bit 3</td></tr> </tbody> </table>	Bit	Name	0	Ready to switch ON	1	Ready run	2	Ready ref	3	Tripped	4	-	5	-	6	-	7	Warning	8	Modulating	9	Remote	10	Net OK	11	User bit 0	12	User bit 1	13	User bit 2	14	Charging	15	User bit 3	-														
Bit	Name																																																		
0	Ready to switch ON																																																		
1	Ready run																																																		
2	Ready ref																																																		
3	Tripped																																																		
4	-																																																		
5	-																																																		
6	-																																																		
7	Warning																																																		
8	Modulating																																																		
9	Remote																																																		
10	Net OK																																																		
11	User bit 0																																																		
12	User bit 1																																																		
13	User bit 2																																																		
14	Charging																																																		
15	User bit 3																																																		
	0000h...FFFFh	Main status word.	1 = 1																																																
106.16	<i>Drive status word 1</i>	Drive status word 1. This parameter is read-only.	-																																																
		<table border="1" data-bbox="418 1523 1426 2033"> <thead> <tr> <th>Bit</th> <th>Name</th> <th>Description</th> </tr> </thead> <tbody> <tr><td>0</td><td>Enabled</td><td>1 = Run enable and start enable signals are present</td></tr> <tr><td>1</td><td>Inhibited</td><td>1 = Start inhibited</td></tr> <tr><td>2</td><td>Operation allowed</td><td>1 = Drive is ready to operate</td></tr> <tr><td>3</td><td>Ready to start</td><td>1 = Drive is ready to receive a start command</td></tr> <tr><td>4</td><td>Running</td><td>1 = Drive is ready to follow given reference</td></tr> <tr><td>5</td><td>Started</td><td>1 = Drive has been started</td></tr> <tr><td>6</td><td>Modulating</td><td>1 = Drive is modulating (output stage is being controlled)</td></tr> <tr><td>7</td><td>Limiting</td><td>1 = Any operating limit is active</td></tr> <tr><td>8</td><td>Local control</td><td>1 = Drive is in local control</td></tr> <tr><td>9</td><td>Network control</td><td>1 = Drive is in network control</td></tr> <tr><td>10</td><td>Ext1 active</td><td>1 = Control location Ext1 active</td></tr> <tr><td>11</td><td>Ext2 active</td><td>1 = Control location Ext2 active</td></tr> <tr><td>12</td><td>Charging relay</td><td>1 = Charging contactor is energized, actual state depends on the hardware topology (NO or NC).</td></tr> <tr><td>13</td><td>MCB relay</td><td>1 = MCB relay is closed</td></tr> <tr><td>14...15</td><td>Reserved</td><td></td></tr> </tbody> </table>	Bit	Name	Description	0	Enabled	1 = Run enable and start enable signals are present	1	Inhibited	1 = Start inhibited	2	Operation allowed	1 = Drive is ready to operate	3	Ready to start	1 = Drive is ready to receive a start command	4	Running	1 = Drive is ready to follow given reference	5	Started	1 = Drive has been started	6	Modulating	1 = Drive is modulating (output stage is being controlled)	7	Limiting	1 = Any operating limit is active	8	Local control	1 = Drive is in local control	9	Network control	1 = Drive is in network control	10	Ext1 active	1 = Control location Ext1 active	11	Ext2 active	1 = Control location Ext2 active	12	Charging relay	1 = Charging contactor is energized, actual state depends on the hardware topology (NO or NC).	13	MCB relay	1 = MCB relay is closed	14...15	Reserved		
Bit	Name	Description																																																	
0	Enabled	1 = Run enable and start enable signals are present																																																	
1	Inhibited	1 = Start inhibited																																																	
2	Operation allowed	1 = Drive is ready to operate																																																	
3	Ready to start	1 = Drive is ready to receive a start command																																																	
4	Running	1 = Drive is ready to follow given reference																																																	
5	Started	1 = Drive has been started																																																	
6	Modulating	1 = Drive is modulating (output stage is being controlled)																																																	
7	Limiting	1 = Any operating limit is active																																																	
8	Local control	1 = Drive is in local control																																																	
9	Network control	1 = Drive is in network control																																																	
10	Ext1 active	1 = Control location Ext1 active																																																	
11	Ext2 active	1 = Control location Ext2 active																																																	
12	Charging relay	1 = Charging contactor is energized, actual state depends on the hardware topology (NO or NC).																																																	
13	MCB relay	1 = MCB relay is closed																																																	
14...15	Reserved																																																		
	0000h...FFFFh	Drive status word 1.	1 = 1																																																

76 Parameters

No.	Name/Value	Description	Def/FbEq16																																											
106.17	<i>Drive status word 2</i>	Drive status word 2. This parameter is read-only.	-																																											
<table border="1"> <thead> <tr> <th>Bit</th> <th>Name</th> <th>Description</th> </tr> </thead> <tbody> <tr> <td>0</td> <td>Start req final</td> <td></td> </tr> <tr> <td>1</td> <td>Supply phase order UVW</td> <td>Phase order UVW is detected and the grid is rotating on expected direction.</td> </tr> <tr> <td>2</td> <td>Supply phase order UWV</td> <td>Phase order UWV is detected and the grid is rotating on unexpected direction.</td> </tr> <tr> <td>3</td> <td>Reserved</td> <td></td> </tr> <tr> <td>4</td> <td>Power control</td> <td>Power control.</td> </tr> <tr> <td>5</td> <td>Internal UDC reference</td> <td rowspan="3">When the bit is set, the drive is not able to fulfill user reference and follows its internally calculated reference. The bits are updated only when the drive is modulating.</td> </tr> <tr> <td>6</td> <td>Internal power reference</td> </tr> <tr> <td>7</td> <td>Internal reactive power reference</td> </tr> <tr> <td>8</td> <td>Reserved</td> <td></td> </tr> <tr> <td>9</td> <td>Reserved</td> <td></td> </tr> <tr> <td>10</td> <td>Reserved</td> <td></td> </tr> <tr> <td>11</td> <td>Emergency stop active</td> <td>1 = An emergency stop command signal is active, or the drive is stopping after receiving an emergency stop command.</td> </tr> <tr> <td>12</td> <td>Reduced run</td> <td>1 = Reduced run active (see section <i>Reduced run function</i> on page 34)</td> </tr> <tr> <td>13...15</td> <td>Reserved</td> <td></td> </tr> </tbody> </table>				Bit	Name	Description	0	Start req final		1	Supply phase order UVW	Phase order UVW is detected and the grid is rotating on expected direction.	2	Supply phase order UWV	Phase order UWV is detected and the grid is rotating on unexpected direction.	3	Reserved		4	Power control	Power control.	5	Internal UDC reference	When the bit is set, the drive is not able to fulfill user reference and follows its internally calculated reference. The bits are updated only when the drive is modulating.	6	Internal power reference	7	Internal reactive power reference	8	Reserved		9	Reserved		10	Reserved		11	Emergency stop active	1 = An emergency stop command signal is active, or the drive is stopping after receiving an emergency stop command.	12	Reduced run	1 = Reduced run active (see section <i>Reduced run function</i> on page 34)	13...15	Reserved	
Bit	Name	Description																																												
0	Start req final																																													
1	Supply phase order UVW	Phase order UVW is detected and the grid is rotating on expected direction.																																												
2	Supply phase order UWV	Phase order UWV is detected and the grid is rotating on unexpected direction.																																												
3	Reserved																																													
4	Power control	Power control.																																												
5	Internal UDC reference	When the bit is set, the drive is not able to fulfill user reference and follows its internally calculated reference. The bits are updated only when the drive is modulating.																																												
6	Internal power reference																																													
7	Internal reactive power reference																																													
8	Reserved																																													
9	Reserved																																													
10	Reserved																																													
11	Emergency stop active	1 = An emergency stop command signal is active, or the drive is stopping after receiving an emergency stop command.																																												
12	Reduced run	1 = Reduced run active (see section <i>Reduced run function</i> on page 34)																																												
13...15	Reserved																																													
0000h...FFFFh		Drive status word 2.	1 = 1																																											
106.18	<i>Start inhibit status word</i>	Start inhibit status word.	-																																											
<table border="1"> <thead> <tr> <th>Bit</th> <th>Name</th> </tr> </thead> <tbody> <tr> <td>0</td> <td>Not ready run</td> </tr> <tr> <td>1</td> <td>Ctrl location changed</td> </tr> <tr> <td>2</td> <td>SSW inhibit</td> </tr> <tr> <td>3</td> <td>Fault</td> </tr> <tr> <td>4</td> <td>Lost start enable</td> </tr> <tr> <td>5</td> <td>Lost run enable</td> </tr> <tr> <td>6</td> <td>Reserved</td> </tr> <tr> <td>7</td> <td>Reserved</td> </tr> <tr> <td>8</td> <td>Reserved</td> </tr> <tr> <td>9</td> <td>Charging overload</td> </tr> <tr> <td>10</td> <td>Reserved</td> </tr> <tr> <td>11</td> <td>Reserved</td> </tr> <tr> <td>12</td> <td>Em Off2</td> </tr> <tr> <td>13</td> <td>Em Off3</td> </tr> <tr> <td>14</td> <td>Auto reset inhibit</td> </tr> <tr> <td>15</td> <td>Off grid configuration</td> </tr> </tbody> </table>				Bit	Name	0	Not ready run	1	Ctrl location changed	2	SSW inhibit	3	Fault	4	Lost start enable	5	Lost run enable	6	Reserved	7	Reserved	8	Reserved	9	Charging overload	10	Reserved	11	Reserved	12	Em Off2	13	Em Off3	14	Auto reset inhibit	15	Off grid configuration									
Bit	Name																																													
0	Not ready run																																													
1	Ctrl location changed																																													
2	SSW inhibit																																													
3	Fault																																													
4	Lost start enable																																													
5	Lost run enable																																													
6	Reserved																																													
7	Reserved																																													
8	Reserved																																													
9	Charging overload																																													
10	Reserved																																													
11	Reserved																																													
12	Em Off2																																													
13	Em Off3																																													
14	Auto reset inhibit																																													
15	Off grid configuration																																													
0000h...FFFFh		Start inhibit status word.	1 = 1																																											

No.	Name/Value	Description	Def/FbEq16																																																			
106.25	<i>Drive inhibit status word 2</i>	Drive inhibit status word 2. This word specifies the source of the inhibiting signal that is preventing the unit from starting. See also parameter <i>106.18 Start inhibit status word</i> , and <i>106.16 Drive status word 1</i> , bit 1. This parameter is read-only.	-																																																			
<table border="1"> <thead> <tr> <th>Bit</th> <th>Name</th> <th>Description</th> </tr> </thead> <tbody> <tr> <td>0</td> <td>Follower drive</td> <td>1 = A follower is preventing the master from starting.</td> </tr> <tr> <td>1</td> <td>Application</td> <td>1 = The application program is preventing the drive from starting.</td> </tr> <tr> <td>2</td> <td>Aux. power failure</td> <td>1 = A control unit auxiliary power failure is preventing the drive from starting.</td> </tr> <tr> <td>3</td> <td>Reserved</td> <td></td> </tr> <tr> <td>4</td> <td>Ref source parametrization</td> <td>1 = A reference source parametrization conflict is preventing the drive from starting.</td> </tr> <tr> <td>5...15</td> <td>Reserved</td> <td></td> </tr> </tbody> </table>				Bit	Name	Description	0	Follower drive	1 = A follower is preventing the master from starting.	1	Application	1 = The application program is preventing the drive from starting.	2	Aux. power failure	1 = A control unit auxiliary power failure is preventing the drive from starting.	3	Reserved		4	Ref source parametrization	1 = A reference source parametrization conflict is preventing the drive from starting.	5...15	Reserved																															
Bit	Name	Description																																																				
0	Follower drive	1 = A follower is preventing the master from starting.																																																				
1	Application	1 = The application program is preventing the drive from starting.																																																				
2	Aux. power failure	1 = A control unit auxiliary power failure is preventing the drive from starting.																																																				
3	Reserved																																																					
4	Ref source parametrization	1 = A reference source parametrization conflict is preventing the drive from starting.																																																				
5...15	Reserved																																																					
	0000h...FFFFh	Drive inhibit status word 2.	1 = 1																																																			
106.30	<i>MSW bit 11 sel</i>	Selects source for the User bit 0 of <i>106.11 Main status word</i> .	<i>False</i>																																																			
	False	0.	1																																																			
	True	1.	2																																																			
	<i>Other</i>	A specific bit in another parameter.	3																																																			
106.31	<i>MSW bit 12 sel</i>	Selects source for the User bit 1 of <i>106.11 Main status word</i> .	<i>False</i>																																																			
	False	0.	1																																																			
	True	1.	2																																																			
	<i>Other</i>	A specific bit in another parameter.	3																																																			
106.32	<i>MSW bit 13 sel</i>	Selects source for the User bit 2 of <i>106.11 Main status word</i> .	<i>False</i>																																																			
	False	0.	1																																																			
	True	1.	2																																																			
	<i>Other</i>	A specific bit in another parameter.	3																																																			
106.33	<i>MSW bit 15 sel</i>	Selects source for the User bit 3 of <i>106.11 Main status word</i> .	<i>False</i>																																																			
	False	0.	1																																																			
	True	1.	2																																																			
	<i>Other</i>	A specific bit in another parameter.	3																																																			
106.50	<i>User status word1</i>	User status word 1.																																																				
<table border="1"> <thead> <tr> <th>Bit</th> <th>Name</th> <th>Description</th> </tr> </thead> <tbody> <tr> <td>0</td> <td>User status bit 0</td> <td>See <i>106.60 User status word 1 bit 0 sel</i>.</td> </tr> <tr> <td>1</td> <td>User status bit 1</td> <td>See <i>106.61 User status word 1 bit 1 sel</i>.</td> </tr> <tr> <td>2</td> <td>User status bit 2</td> <td>See <i>106.62 User status word 1 bit 2 sel</i>.</td> </tr> <tr> <td>3</td> <td>User status bit 3</td> <td>See <i>106.63 User status word 1 bit 3 sel</i>.</td> </tr> <tr> <td>4</td> <td>User status bit 4</td> <td>See <i>106.64 User status word 1 bit 4 sel</i>.</td> </tr> <tr> <td>5</td> <td>User status bit 5</td> <td>See <i>106.65 User status word 1 bit 5 sel</i>.</td> </tr> <tr> <td>6</td> <td>User status bit 6</td> <td>See <i>106.66 User status word 1 bit 6 sel</i>.</td> </tr> <tr> <td>7</td> <td>User status bit 7</td> <td>See <i>106.67 User status word 1 bit 7 sel</i>.</td> </tr> <tr> <td>8</td> <td>User status bit 8</td> <td>See <i>106.68 User status word 1 bit 8 sel</i>.</td> </tr> <tr> <td>9</td> <td>User status bit 9</td> <td>See <i>106.69 User status word 1 bit 9 sel</i>.</td> </tr> <tr> <td>10</td> <td>User status bit 10</td> <td>See <i>106.70 User status word 1 bit 10 sel</i>.</td> </tr> <tr> <td>11</td> <td>User status bit 11</td> <td>See <i>106.71 User status word 1 bit 11 sel</i>.</td> </tr> <tr> <td>12</td> <td>User status bit 12</td> <td>See <i>106.72 User status word 1 bit 12 sel</i>.</td> </tr> <tr> <td>13</td> <td>User status bit 13</td> <td>See <i>106.73 User status word 1 bit 13 sel</i>.</td> </tr> <tr> <td>14</td> <td>User status bit 14</td> <td>See <i>106.74 User status word 1 bit 14 sel</i>.</td> </tr> <tr> <td>15</td> <td>User status bit 15</td> <td>See <i>106.75 User status word 1 bit 15 sel</i>.</td> </tr> </tbody> </table>				Bit	Name	Description	0	User status bit 0	See <i>106.60 User status word 1 bit 0 sel</i> .	1	User status bit 1	See <i>106.61 User status word 1 bit 1 sel</i> .	2	User status bit 2	See <i>106.62 User status word 1 bit 2 sel</i> .	3	User status bit 3	See <i>106.63 User status word 1 bit 3 sel</i> .	4	User status bit 4	See <i>106.64 User status word 1 bit 4 sel</i> .	5	User status bit 5	See <i>106.65 User status word 1 bit 5 sel</i> .	6	User status bit 6	See <i>106.66 User status word 1 bit 6 sel</i> .	7	User status bit 7	See <i>106.67 User status word 1 bit 7 sel</i> .	8	User status bit 8	See <i>106.68 User status word 1 bit 8 sel</i> .	9	User status bit 9	See <i>106.69 User status word 1 bit 9 sel</i> .	10	User status bit 10	See <i>106.70 User status word 1 bit 10 sel</i> .	11	User status bit 11	See <i>106.71 User status word 1 bit 11 sel</i> .	12	User status bit 12	See <i>106.72 User status word 1 bit 12 sel</i> .	13	User status bit 13	See <i>106.73 User status word 1 bit 13 sel</i> .	14	User status bit 14	See <i>106.74 User status word 1 bit 14 sel</i> .	15	User status bit 15	See <i>106.75 User status word 1 bit 15 sel</i> .
Bit	Name	Description																																																				
0	User status bit 0	See <i>106.60 User status word 1 bit 0 sel</i> .																																																				
1	User status bit 1	See <i>106.61 User status word 1 bit 1 sel</i> .																																																				
2	User status bit 2	See <i>106.62 User status word 1 bit 2 sel</i> .																																																				
3	User status bit 3	See <i>106.63 User status word 1 bit 3 sel</i> .																																																				
4	User status bit 4	See <i>106.64 User status word 1 bit 4 sel</i> .																																																				
5	User status bit 5	See <i>106.65 User status word 1 bit 5 sel</i> .																																																				
6	User status bit 6	See <i>106.66 User status word 1 bit 6 sel</i> .																																																				
7	User status bit 7	See <i>106.67 User status word 1 bit 7 sel</i> .																																																				
8	User status bit 8	See <i>106.68 User status word 1 bit 8 sel</i> .																																																				
9	User status bit 9	See <i>106.69 User status word 1 bit 9 sel</i> .																																																				
10	User status bit 10	See <i>106.70 User status word 1 bit 10 sel</i> .																																																				
11	User status bit 11	See <i>106.71 User status word 1 bit 11 sel</i> .																																																				
12	User status bit 12	See <i>106.72 User status word 1 bit 12 sel</i> .																																																				
13	User status bit 13	See <i>106.73 User status word 1 bit 13 sel</i> .																																																				
14	User status bit 14	See <i>106.74 User status word 1 bit 14 sel</i> .																																																				
15	User status bit 15	See <i>106.75 User status word 1 bit 15 sel</i> .																																																				
	0000h...FFFFh	User-defined status word.	1 = 1																																																			

78 Parameters

No.	Name/Value	Description	Def/FbEq16
106.60	<i>User status word 1 bit 0 sel</i>	Selects a binary source whose status is transmitted as bit 0 of <i>106.50 User status word1</i> .	<i>False</i>
	False	0.	1
	True	1.	2
	<i>Other</i>	A specific bit in another parameter.	3
106.61	<i>User status word 1 bit 1 sel</i>	Selects a binary source whose status is transmitted as bit 1 of <i>106.50 User status word1</i> .	<i>False</i>
	False	0.	1
	True	1.	2
	<i>Other</i>	A specific bit in another parameter.	3
106.62	<i>User status word 1 bit 2 sel</i>	Selects a binary source whose status is transmitted as bit 2 of <i>106.50 User status word1</i> .	<i>False</i>
	False	0.	1
	True	1.	2
	<i>Other</i>	A specific bit in another parameter.	3
106.63	<i>User status word 1 bit 3 sel</i>	Selects a binary source whose status is transmitted as bit 3 of <i>106.50 User status word1</i> .	<i>False</i>
	False	0.	1
	True	1.	2
	<i>Other</i>	A specific bit in another parameter.	3
106.64	<i>User status word 1 bit 4 sel</i>	Selects a binary source whose status is transmitted as bit 4 of <i>106.50 User status word1</i> .	<i>False</i>
	False	0.	1
	True	1.	2
	<i>Other</i>	A specific bit in another parameter.	3
106.65	<i>User status word 1 bit 5 sel</i>	Selects a binary source whose status is transmitted as bit 5 of <i>106.50 User status word1</i> .	<i>False</i>
	False	0.	1
	True	1.	2
	<i>Other</i>	A specific bit in another parameter.	3
106.66	<i>User status word 1 bit 6 sel</i>	Selects a binary source whose status is transmitted as bit 6 of <i>106.50 User status word1</i> .	<i>False</i>
	False	0.	1
	True	1.	2
	<i>Other</i>	A specific bit in another parameter.	3
106.67	<i>User status word 1 bit 7 sel</i>	Selects a binary source whose status is transmitted as bit 7 of <i>106.50 User status word1</i> .	<i>False</i>
	False	0.	1
	True	1.	2
	<i>Other</i>	A specific bit in another parameter.	3
106.68	<i>User status word 1 bit 8 sel</i>	Selects a binary source whose status is transmitted as bit 8 of <i>106.50 User status word1</i> .	<i>False</i>
	False	0.	1
	True	1.	2
	<i>Other</i>	A specific bit in another parameter.	3
106.69	<i>User status word 1 bit 9 sel</i>	Selects a binary source whose status is transmitted as bit 9 of <i>106.50 User status word1</i> .	<i>False</i>
	False	0.	1
	True	1.	2
	<i>Other</i>	A specific bit in another parameter.	3

No.	Name/Value	Description	Def/FbEq16																																		
106.70	<i>User status word 1 bit 10 sel</i>	Selects a binary source whose status is transmitted as bit 10 of <i>106.50 User status word1</i> .	<i>False</i>																																		
	False	0.	1																																		
	True	1.	2																																		
	<i>Other</i>	A specific bit in another parameter.	3																																		
106.71	<i>User status word 1 bit 11 sel</i>	Selects a binary source whose status is transmitted as bit 11 of <i>106.50 User status word1</i> .	<i>False</i>																																		
	False	0.	1																																		
	True	1.	2																																		
	<i>Other</i>	A specific bit in another parameter.	3																																		
106.72	<i>User status word 1 bit 12 sel</i>	Selects a binary source whose status is transmitted as bit 12 of <i>106.50 User status word1</i> .	<i>False</i>																																		
	False	0.	1																																		
	True	1.	2																																		
	<i>Other</i>	A specific bit in another parameter.	3																																		
106.73	<i>User status word 1 bit 13 sel</i>	Selects a binary source whose status is transmitted as bit 13 of <i>106.50 User status word1</i> .	<i>False</i>																																		
	False	0.	1																																		
	True	1.	2																																		
	<i>Other</i>	A specific bit in another parameter.	3																																		
106.74	<i>User status word 1 bit 14 sel</i>	Selects a binary source whose status is transmitted as bit 14 of <i>106.50 User status word1</i> .	<i>False</i>																																		
	False	0.	1																																		
	True	1.	2																																		
	<i>Other</i>	A specific bit in another parameter.	3																																		
106.75	<i>User status word 1 bit 15 sel</i>	Selects a binary source whose status is transmitted as bit 15 of <i>106.50 User status word1</i> .	<i>False</i>																																		
	False	0.	1																																		
	True	1.	2																																		
	<i>Other</i>	A specific bit in another parameter.	3																																		
106.100	<i>User control word 1</i>	User-defined control word 1.																																			
		<table border="1"> <thead> <tr> <th>Bit</th> <th>Name</th> </tr> </thead> <tbody> <tr><td>0</td><td>User control word 1 bit 0 sel</td></tr> <tr><td>1</td><td>User control word 1 bit 1 sel</td></tr> <tr><td>2</td><td>User control word 1 bit 2 sel</td></tr> <tr><td>3</td><td>User control word 1 bit 3 sel</td></tr> <tr><td>4</td><td>User control word 1 bit 4 sel</td></tr> <tr><td>5</td><td>User control word 1 bit 5 sel</td></tr> <tr><td>6</td><td>User control word 1 bit 6 sel</td></tr> <tr><td>7</td><td>User control word 1 bit 7 sel</td></tr> <tr><td>8</td><td>User control word 1 bit 8 sel</td></tr> <tr><td>9</td><td>User control word 1 bit 9 sel</td></tr> <tr><td>10</td><td>User control word 1 bit 10 sel</td></tr> <tr><td>11</td><td>User control word 1 bit 11 sel</td></tr> <tr><td>12</td><td>User control word 1 bit 12 sel</td></tr> <tr><td>13</td><td>User control word 1 bit 13 sel</td></tr> <tr><td>14</td><td>User control word 1 bit 14 sel</td></tr> <tr><td>15</td><td>User control word 1 bit 15 sel</td></tr> </tbody> </table>	Bit	Name	0	User control word 1 bit 0 sel	1	User control word 1 bit 1 sel	2	User control word 1 bit 2 sel	3	User control word 1 bit 3 sel	4	User control word 1 bit 4 sel	5	User control word 1 bit 5 sel	6	User control word 1 bit 6 sel	7	User control word 1 bit 7 sel	8	User control word 1 bit 8 sel	9	User control word 1 bit 9 sel	10	User control word 1 bit 10 sel	11	User control word 1 bit 11 sel	12	User control word 1 bit 12 sel	13	User control word 1 bit 13 sel	14	User control word 1 bit 14 sel	15	User control word 1 bit 15 sel	
Bit	Name																																				
0	User control word 1 bit 0 sel																																				
1	User control word 1 bit 1 sel																																				
2	User control word 1 bit 2 sel																																				
3	User control word 1 bit 3 sel																																				
4	User control word 1 bit 4 sel																																				
5	User control word 1 bit 5 sel																																				
6	User control word 1 bit 6 sel																																				
7	User control word 1 bit 7 sel																																				
8	User control word 1 bit 8 sel																																				
9	User control word 1 bit 9 sel																																				
10	User control word 1 bit 10 sel																																				
11	User control word 1 bit 11 sel																																				
12	User control word 1 bit 12 sel																																				
13	User control word 1 bit 13 sel																																				
14	User control word 1 bit 14 sel																																				
15	User control word 1 bit 15 sel																																				
	0000h...FFFFh	User-defined control word 1.	1 = 1																																		

80 Parameters

No.	Name/Value	Description	Def/FbEq16																																		
106.101	<i>User control word 2</i>	User-defined control word 2. <table border="1"> <thead> <tr> <th>Bit</th> <th>Name</th> </tr> </thead> <tbody> <tr><td>0</td><td>User control word 2 bit 0 sel</td></tr> <tr><td>1</td><td>User control word 2 bit 1 sel</td></tr> <tr><td>2</td><td>User control word 2 bit 2 sel</td></tr> <tr><td>3</td><td>User control word 2 bit 3 sel</td></tr> <tr><td>4</td><td>User control word 2 bit 4 sel</td></tr> <tr><td>5</td><td>User control word 2 bit 5 sel</td></tr> <tr><td>6</td><td>User control word 2 bit 6 sel</td></tr> <tr><td>7</td><td>User control word 2 bit 7 sel</td></tr> <tr><td>8</td><td>User control word 2 bit 8 sel</td></tr> <tr><td>9</td><td>User control word 2 bit 9 sel</td></tr> <tr><td>10</td><td>User control word 2 bit 10 sel</td></tr> <tr><td>11</td><td>User control word 2 bit 11 sel</td></tr> <tr><td>12</td><td>User control word 2 bit 12 sel</td></tr> <tr><td>13</td><td>User control word 2 bit 13 sel</td></tr> <tr><td>14</td><td>User control word 2 bit 14 sel</td></tr> <tr><td>15</td><td>User control word 2 bit 15 sel</td></tr> </tbody> </table>	Bit	Name	0	User control word 2 bit 0 sel	1	User control word 2 bit 1 sel	2	User control word 2 bit 2 sel	3	User control word 2 bit 3 sel	4	User control word 2 bit 4 sel	5	User control word 2 bit 5 sel	6	User control word 2 bit 6 sel	7	User control word 2 bit 7 sel	8	User control word 2 bit 8 sel	9	User control word 2 bit 9 sel	10	User control word 2 bit 10 sel	11	User control word 2 bit 11 sel	12	User control word 2 bit 12 sel	13	User control word 2 bit 13 sel	14	User control word 2 bit 14 sel	15	User control word 2 bit 15 sel	
Bit	Name																																				
0	User control word 2 bit 0 sel																																				
1	User control word 2 bit 1 sel																																				
2	User control word 2 bit 2 sel																																				
3	User control word 2 bit 3 sel																																				
4	User control word 2 bit 4 sel																																				
5	User control word 2 bit 5 sel																																				
6	User control word 2 bit 6 sel																																				
7	User control word 2 bit 7 sel																																				
8	User control word 2 bit 8 sel																																				
9	User control word 2 bit 9 sel																																				
10	User control word 2 bit 10 sel																																				
11	User control word 2 bit 11 sel																																				
12	User control word 2 bit 12 sel																																				
13	User control word 2 bit 13 sel																																				
14	User control word 2 bit 14 sel																																				
15	User control word 2 bit 15 sel																																				
	0000h...FFFFh	User-defined control word 2.	1 = 1																																		
107 System info		Hardware and firmware information. All parameters in this group are read-only.																																			
107.03	<i>Drive rating id</i>	Type of the unit.	-																																		
	0...999	Type of the unit.	-																																		
107.04	<i>Firmware name</i>	Firmware identification.	-																																		
107.05	<i>Firmware version</i>	Version number of the firmware.	-																																		
107.06	<i>Loading package name</i>	Name of the firmware loading package.	-																																		
107.07	<i>Loading package version</i>	Version number of the firmware loading package.	-																																		
107.08	<i>Bootloader version</i>	Version number of the firmware bootloader.	-																																		
107.11	<i>Cpu usage</i>	Microprocessor load in percent.	-																																		
	0...100%	Microprocessor load.	1 = 1%																																		
107.13	<i>PU logic version number</i>	The version number of the power unit FPGA logic.	-																																		
107.23	<i>Application name</i>	First five ASCII letters of the name given to the application program in the programming tool. The full name is visible under System info on the control panel or the Drive composer PC tool. _N/A_ = None.	-																																		
107.24	<i>Application version</i>	Application program version number given to the application program in the programming tool. Also visible under System info on the control panel or the Drive composer PC tool.	-																																		
107.25	<i>Customization package name</i>	First five ASCII letters of the name given to the customization package. The full name is visible under System info on the control panel or the Drive composer PC tool. _N/A_ = None.	-																																		
107.26	<i>Customization package version</i>	Customization package version number. Also visible under System info on the control panel or the Drive composer PC tool.	-																																		

No.	Name/Value	Description	Def/FbEq16																								
107.30	<i>Adaptive program status</i>	Shows the status of the adaptive program. See section <i>Adaptive programming</i> (page 25).	-																								
		<table border="1"> <thead> <tr> <th>Bit</th> <th>Name</th> <th>Description</th> </tr> </thead> <tbody> <tr> <td>0</td> <td>Initialized</td> <td>1 = Adaptive program initialized</td> </tr> <tr> <td>1</td> <td>Editing</td> <td>1 = Adaptive program is being edited</td> </tr> <tr> <td>2</td> <td>Edit done</td> <td>1 = Editing of adaptive program finished</td> </tr> <tr> <td>3</td> <td>Running</td> <td>1 = Adaptive program running</td> </tr> <tr> <td>4...13</td> <td>Reserved</td> <td></td> </tr> <tr> <td>14</td> <td>State changing</td> <td>Reserved</td> </tr> <tr> <td>15</td> <td>Faulted</td> <td>1 = Error in adaptive program</td> </tr> </tbody> </table>	Bit	Name	Description	0	Initialized	1 = Adaptive program initialized	1	Editing	1 = Adaptive program is being edited	2	Edit done	1 = Editing of adaptive program finished	3	Running	1 = Adaptive program running	4...13	Reserved		14	State changing	Reserved	15	Faulted	1 = Error in adaptive program	
Bit	Name	Description																									
0	Initialized	1 = Adaptive program initialized																									
1	Editing	1 = Adaptive program is being edited																									
2	Edit done	1 = Editing of adaptive program finished																									
3	Running	1 = Adaptive program running																									
4...13	Reserved																										
14	State changing	Reserved																									
15	Faulted	1 = Error in adaptive program																									
	0000h...FFFFh	Adaptive program status.	1 = 1																								
110 Standard DI, RO		Configuration of digital inputs and relay outputs.																									
110.01	<i>DI status</i>	Displays the electrical status of digital inputs DI1L and DI6...DI1. The activation/deactivation delays of the inputs (if any are specified) are ignored. Bits 0...5 reflect the status of DI1...DI6; bit 15 reflects the status of the DI1L input. This parameter is read-only.	-																								
	0000h...FFFFh	Status of digital inputs.	1 = 1																								
110.02	<i>DI delayed status</i>	Displays the status of digital inputs DI1L and DI6...DI1. This word is updated only after activation/deactivation delays. Bits 0...5 reflect the delayed status of DI1...DI6; bit 15 reflects the delayed status of the DI1L input. This parameter is read-only.	-																								
	0000h...FFFFh	Delayed status of digital inputs.	1 = 1																								
110.03	<i>DI force selection</i>	Selects if the electrical statuses of digital inputs will be overridden by bits on signal <i>110.04 DI force data</i> . These values overrides the electrical statuses of the digital inputs in eg. testing purposes. A bit in parameter <i>110.04 DI force data</i> is provided for each digital input, and its value is applied whenever the corresponding bit in this parameter is 1.	0000h																								
		<table border="1"> <thead> <tr> <th>Bit</th> <th>Value</th> </tr> </thead> <tbody> <tr> <td>0</td> <td>1 = Force DI1 to value of bit 0 of parameter <i>110.04 DI force data</i>.</td> </tr> <tr> <td>1</td> <td>1 = Force DI2 to value of bit 1 of parameter <i>110.04 DI force data</i>.</td> </tr> <tr> <td>2</td> <td>1 = Force DI3 to value of bit 2 of parameter <i>110.04 DI force data</i>.</td> </tr> <tr> <td>3</td> <td>1 = Force DI4 to value of bit 3 of parameter <i>110.04 DI force data</i>.</td> </tr> <tr> <td>4</td> <td>1 = Force DI5 to value of bit 4 of parameter <i>110.04 DI force data</i>.</td> </tr> <tr> <td>5</td> <td>1 = Force DI6 to value of bit 5 of parameter <i>110.04 DI force data</i>.</td> </tr> <tr> <td>6...14</td> <td>Reserved</td> </tr> <tr> <td>15</td> <td>1 = Force DI1L to value of bit 15 of parameter <i>110.04 DI force data</i>.</td> </tr> </tbody> </table>	Bit	Value	0	1 = Force DI1 to value of bit 0 of parameter <i>110.04 DI force data</i> .	1	1 = Force DI2 to value of bit 1 of parameter <i>110.04 DI force data</i> .	2	1 = Force DI3 to value of bit 2 of parameter <i>110.04 DI force data</i> .	3	1 = Force DI4 to value of bit 3 of parameter <i>110.04 DI force data</i> .	4	1 = Force DI5 to value of bit 4 of parameter <i>110.04 DI force data</i> .	5	1 = Force DI6 to value of bit 5 of parameter <i>110.04 DI force data</i> .	6...14	Reserved	15	1 = Force DI1L to value of bit 15 of parameter <i>110.04 DI force data</i> .							
Bit	Value																										
0	1 = Force DI1 to value of bit 0 of parameter <i>110.04 DI force data</i> .																										
1	1 = Force DI2 to value of bit 1 of parameter <i>110.04 DI force data</i> .																										
2	1 = Force DI3 to value of bit 2 of parameter <i>110.04 DI force data</i> .																										
3	1 = Force DI4 to value of bit 3 of parameter <i>110.04 DI force data</i> .																										
4	1 = Force DI5 to value of bit 4 of parameter <i>110.04 DI force data</i> .																										
5	1 = Force DI6 to value of bit 5 of parameter <i>110.04 DI force data</i> .																										
6...14	Reserved																										
15	1 = Force DI1L to value of bit 15 of parameter <i>110.04 DI force data</i> .																										
	0000h...FFFFh	Override selection for digital inputs.	1 = 1																								
110.04	<i>DI force data</i>	Defines the values of digital inputs that are used instead of the electrical statuses if selected in parameter <i>110.03 DI force selection</i> . Bit 0 is the forced value for DI1; bit 15 is the forced value for the DI1L input.	0000h																								
	0000h...FFFFh	Forced values of digital inputs.	1 = 1																								

82 Parameters

No.	Name/Value	Description	Def/FbEq16
110.05	<i>DI1 ON delay</i>	Defines the activation delay for digital input DI1.	0.0 s
<p><i>t_{On}</i> = 110.05 DI1 ON delay <i>t_{Off}</i> = 110.06 DI1 OFF delay *Electrical status of digital input. Indicated by 110.01 DI status. **Indicated by 110.02 DI delayed status.</p>			
	0.0 ... 3000.0 s	Activation delay for DI1.	10 = 1 s
110.06	<i>DI1 OFF delay</i>	Defines the deactivation delay for digital input DI1. See parameter 110.05 DI1 ON delay.	0.0 s
	0.0 ... 3000.0 s	Deactivation delay for DI1.	10 = 1 s
110.07	<i>DI2 ON delay</i>	Defines the activation delay for digital input DI2.	0.0 s
<p><i>t_{On}</i> = 110.07 DI2 ON delay <i>t_{Off}</i> = 110.08 DI2 OFF delay *Electrical status of digital input. Indicated by 110.01 DI status. **Indicated by 110.02 DI delayed status.</p>			
	0.0 ... 3000.0 s	Activation delay for DI2.	10 = 1 s
110.08	<i>DI2 OFF delay</i>	Defines the deactivation delay for digital input DI2. See parameter 110.07 DI2 ON delay.	0.0 s
	0.0 ... 3000.0 s	Deactivation delay for DI2.	10 = 1 s
110.09	<i>DI3 ON delay</i>	Defines the activation delay for digital input DI3.	0.0 s
<p><i>t_{On}</i> = 110.09 DI3 ON delay <i>t_{Off}</i> = 110.10 DI3 OFF delay *Electrical status of digital input. Indicated by 110.01 DI status. **Indicated by 110.02 DI delayed status.</p>			
	0.0 ... 3000.0 s	Activation delay for DI3.	10 = 1 s
110.10	<i>DI3 OFF delay</i>	Defines the deactivation delay for digital input DI3. See parameter 110.09 DI3 ON delay.	0.0 s
	0.0 ... 3000.0 s	Deactivation delay for DI3.	10 = 1 s

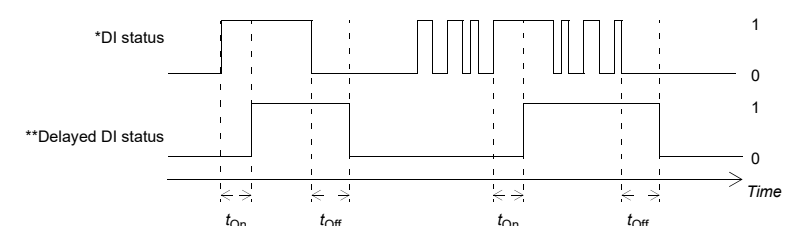
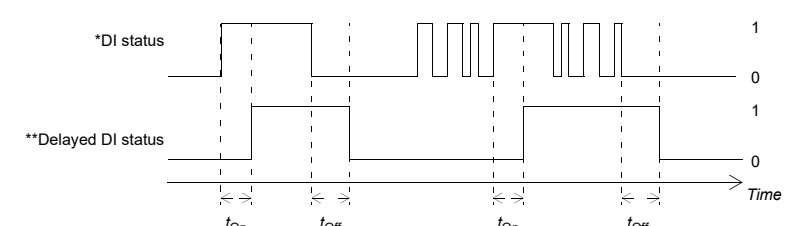
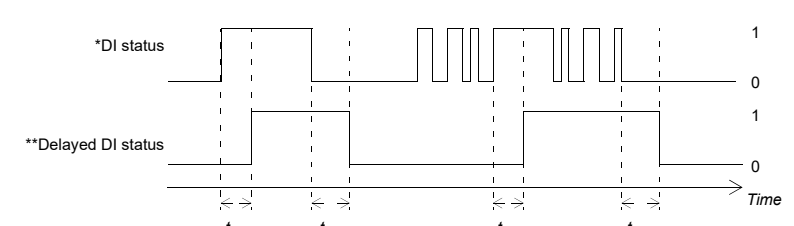
No.	Name/Value	Description	Def/FbEq16
110.11	<i>DI4 ON delay</i>	Defines the activation delay for digital input DI4.	0.0 s
 <p><i>t_{On}</i> = 110.11 <i>DI4 ON delay</i> <i>t_{Off}</i> = 110.12 <i>DI4 OFF delay</i> *Electrical status of digital input. Indicated by 110.01 <i>DI status</i>. **Indicated by 110.02 <i>DI delayed status</i>.</p>			
	0.0 ... 3000.0 s	Activation delay for DI4.	10 = 1 s
110.12	<i>DI4 OFF delay</i>	Defines the deactivation delay for digital input DI4. See parameter 110.11 <i>DI4 ON delay</i> .	0.0 s
	0.0 ... 3000.0 s	Deactivation delay for DI4.	10 = 1 s
110.13	<i>DI5 ON delay</i>	Defines the activation delay for digital input DI5.	0.0 s
 <p><i>t_{On}</i> = 110.13 <i>DI5 ON delay</i> <i>t_{Off}</i> = 110.14 <i>DI5 OFF delay</i> *Electrical status of digital input. Indicated by 110.01 <i>DI status</i>. **Indicated by 110.02 <i>DI delayed status</i>.</p>			
	0.0 ... 3000.0 s	Activation delay for DI5.	10 = 1 s
110.14	<i>DI5 OFF delay</i>	Defines the deactivation delay for digital input DI5. See parameter 110.13 <i>DI5 ON delay</i> .	0.0 s
	0.0 ... 3000.0 s	Deactivation delay for DI5.	10 = 1 s
110.15	<i>DI6 ON delay</i>	Defines the activation delay for digital input DI6.	0.0 s
 <p><i>t_{On}</i> = 110.15 <i>DI6 ON delay</i> <i>t_{Off}</i> = 110.16 <i>DI6 OFF delay</i> *Electrical status of digital input. Indicated by 110.01 <i>DI status</i>. **Indicated by 110.02 <i>DI delayed status</i>.</p>			
	0.0 ... 3000.0 s	Activation delay for DI6.	10 = 1 s
110.16	<i>DI6 OFF delay</i>	Defines the deactivation delay for digital input DI6. See parameter 110.15 <i>DI6 ON delay</i> .	0.0 s
	0.0 ... 3000.0 s	Deactivation delay for DI6.	10 = 1 s
110.21	<i>RO status</i>	Status of relay outputs RO3...RO1.	-
	0000h...FFFFh	Status of relay outputs.	1 = 1

84 Parameters

No.	Name/Value	Description	Def/FbEq16
110.24	<i>RO1 source</i>	Selects a signal to be connected to relay output RO1. Note: This parameter is write-protected if parameter 120.30 External charge enable is set to <i>Yes</i> .	<i>Charging</i>
	Not energized	Relay output is not energized.	0
	Energized	Relay output is energized.	1
	Ready	Bit 0 of 106.11 Main status word (see page 75). Relay is energized when the IGBT supply unit is ready.	2
	Enabled	Bit 0 of 106.16 Drive status word 1 (see page 75). Relay is energized when the IGBT supply unit is enabled.	3
	Started	Bit 5 of 106.16 Drive status word 1 (see page 75). Relay is energized when the IGBT supply unit is started.	4
	Running	Bit 4 of 106.16 Drive status word 1 (see page 75). Relay is energized when the IGBT supply unit is running.	5
	Warning	Bit 7 of 106.11 Main status word (see page 75). Relay is energized when a warning is active.	6
	Fault	Bit 3 of 106.11 Main status word (see page 75). Relay is energized when a fault is active.	7
	Fault (-1)	Inverted bit 3 of 106.11 Main status word (see page 75).	8
	MCB	Bit 13 of 106.16 Drive status word 1 (see page 75). Relay is energized when MCB closing command is given.	9
	Charging	Bit 12 of 106.16 Drive status word 1 (see page 75). Relay is energized when the external charging has charged the IGBT supply unit.	10
	Start req final	Bit 0 of 106.17 Drive status word 2 (see page 76).	11
	<i>Other</i>	A specific bit in another parameter.	-
110.25	<i>RO1 ON delay</i>	Defines the activation delay for relay output RO1.	0.0 s
<p>$t_{On} = 110.25 \text{ RO1 ON delay}$ $t_{Off} = 110.26 \text{ RO1 OFF delay}$</p>			
	0.0 ... 3000.0 s	Activation delay for RO1.	10 = 1 s
110.26	<i>RO1 OFF delay</i>	Defines the deactivation delay for relay output RO1. See parameter 110.25 RO1 ON delay .	0.0 s
	0.0 ... 3000.0 s	Deactivation delay for RO1.	10 = 1 s
110.27	<i>RO2 source</i>	Selects a signal to be connected to relay output RO2. For the selections, see parameter 110.24 RO1 source .	<i>Fault (-1)</i>
110.28	<i>RO2 ON delay</i>	Defines the activation delay for relay output RO2.	0.0 s
<p>$t_{On} = 110.28 \text{ RO2 ON delay}$ $t_{Off} = 110.29 \text{ RO2 OFF delay}$</p>			
	0.0 ... 3000.0 s	Activation delay for RO2.	10 = 1 s

No.	Name/Value	Description	Def/FbEq16																					
110.29	<i>RO2 OFF delay</i>	Defines the deactivation delay for relay output RO2. See parameter 110.28 RO2 ON delay .	0.0 s																					
	0.0 ... 3000.0 s	Deactivation delay for RO2.	10 = 1 s																					
110.30	<i>RO3 source</i>	Selects a signal to be connected to relay output RO3. For the selections, see parameter 110.24 RO1 source . Note: This parameter is write-protected if parameter 120.30 External charge enable is set to <i>Yes</i> .	MCB																					
110.31	<i>RO3 ON delay</i>	Defines the activation delay for relay output RO3.	0.0 s																					
	<p>$t_{On} = 110.31$ RO3 ON delay $t_{Off} = 110.32$ RO3 OFF delay</p>																							
	0.0 ... 3000.0 s	Activation delay for RO3.	10 = 1 s																					
110.32	<i>RO3 OFF delay</i>	Defines the deactivation delay for relay output RO3. See parameter 110.31 RO3 ON delay .	0.0 s																					
	0.0 ... 3000.0 s	Deactivation delay for RO3.	10 = 1 s																					
110.51	<i>DI filter time</i>	Defines a filtering time for parameter 110.01 DI status .	10.0 ms																					
	0.3 ... 100.0 ms	Filtering time for 110.01 .	10 = 1 ms																					
110.99	<i>RO/DIO control word</i>	Storage parameter for controlling the relay outputs and digital input/outputs. To control the relay outputs (RO) and the digital input/outputs (DIO), send a control word with the bit assignments shown below as Modbus I/O data. Set the target selection parameter of that particular data. In the source selection parameter of the desired output, select the appropriate bit of this word.	0000h																					
	<table border="1"> <thead> <tr> <th>Bit</th> <th>Name</th> <th>Description</th> </tr> </thead> <tbody> <tr> <td>0</td> <td>RO1</td> <td rowspan="3">Source bits for relay outputs RO1...RO3 (see parameters 110.24, 110.27 and 110.30).</td> </tr> <tr> <td>1</td> <td>RO2</td> </tr> <tr> <td>2</td> <td>RO3</td> </tr> <tr> <td>3...7</td> <td colspan="2">Reserved</td> </tr> <tr> <td>8</td> <td>DIO1</td> <td rowspan="2">Source bits for digital input/outputs DIO1...DIO3 (see parameters 111.06 and 111.10).</td> </tr> <tr> <td>9</td> <td>DIO2</td> </tr> <tr> <td>10...15</td> <td colspan="2">Reserved</td> </tr> </tbody> </table>		Bit	Name	Description	0	RO1	Source bits for relay outputs RO1...RO3 (see parameters 110.24 , 110.27 and 110.30).	1	RO2	2	RO3	3...7	Reserved		8	DIO1	Source bits for digital input/outputs DIO1...DIO3 (see parameters 111.06 and 111.10).	9	DIO2	10...15	Reserved		
Bit	Name	Description																						
0	RO1	Source bits for relay outputs RO1...RO3 (see parameters 110.24 , 110.27 and 110.30).																						
1	RO2																							
2	RO3																							
3...7	Reserved																							
8	DIO1	Source bits for digital input/outputs DIO1...DIO3 (see parameters 111.06 and 111.10).																						
9	DIO2																							
10...15	Reserved																							
	0000h...FFFFh	RO/DIO control word.	1 = 1																					
111 Standard DIO, FI, FO		Configuration of digital input/outputs and frequency inputs/outputs.																						
111.01	<i>DIO status</i>	Displays the electrical status of digital input/outputs DIO2...DIO1. The activation/deactivation delays (if any are specified) are ignored. This parameter is read-only.	-																					
	0000h...FFFFh	Status of digital input/outputs.	1 = 1																					

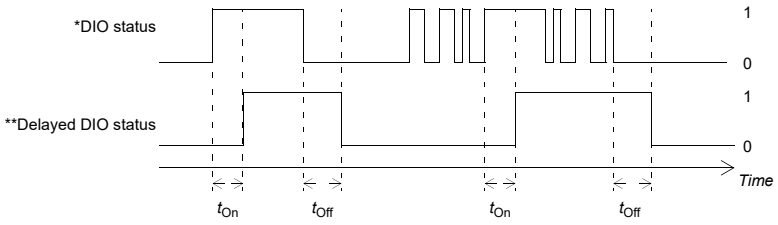
No.	Name/Value	Description	Def/FbEq16
111.02	<i>DIO delayed status</i>	Displays the status of digital input/outputs DIO2...DIO1. This word is updated only after activation/deactivation (if any) delays. This parameter is read-only.	-
	0000h...FFFFh	Delayed status of digital input/outputs.	1 = 1
111.05	<i>DIO1 function</i>	Selects whether DIO1 is used as a digital output or input, or a frequency input.	<i>Output</i>
	Output	DIO1 is used as a digital output.	0
	Input	DIO1 is used as a digital input.	1
	Frequency	DIO1 is used as a frequency input.	2
111.06	<i>DIO1 output source</i>	Selects a signal to be connected to digital input/output DIO1 when parameter <i>111.05 DIO1 function</i> is set to <i>Output</i> .	<i>Charging</i>
	Not energized	Output is not energized.	0
	Energized	Output is energized.	1
	Ready	Bit 0 of <i>106.11 Main status word</i> (see page 75). Output is energized when the IGBT supply unit is ready.	2
	Charge ready	Bit 1 of <i>106.11 Main status word</i> (see page 75). Output is energized when the intermediate circuit DC charging is ready.	3
	Enabled	Bit 0 of <i>106.16 Drive status word 1</i> (see page 75). Output is energized when the IGBT supply unit is enabled.	4
	Started	Bit 5 of <i>106.16 Drive status word 1</i> (see page 75). Output is energized when the IGBT supply unit is started.	5
	Running	Bit 4 of <i>106.16 Drive status word 1</i> (see page 75). Output is energized when the IGBT supply unit is running.	6
	Warning	Bit 7 of <i>106.11 Main status word</i> (see page 75). Output is energized when a warning is active.	7
	Fault	Bit 3 of <i>106.11 Main status word</i> (see page 75). Output is energized when a fault is active.	8
	MCB	Bit 13 of <i>106.16 Drive status word 1</i> (see page 75). Output is energized when MCB closing command is given.	9
	Charging	Bit 12 of <i>106.16 Drive status word 1</i> (see page 75). Output is energized when the external charging has charged the IGBT supply unit.	10
	Start req final	Bit 0 of <i>106.17 Drive status word 2</i> (see page 76).	11
	<i>Other</i>	A specific bit in another parameter.	-
111.07	<i>DIO1 ON delay</i>	Defines the activation delay for digital input/output DIO1 (when used as a digital output or digital input).	0.0 s
	 <p>$t_{On} = 111.07 \text{ DIO1 ON delay}$ $t_{Off} = 111.08 \text{ DIO1 OFF delay}$ *Electrical status of DIO (in input mode) or status of selected source (in output mode). Indicated by <i>111.01 DIO status</i>. **Indicated by <i>111.02 DIO delayed status</i>.</p>		
	0.0 ... 3000.0 s	Activation delay for DIO1.	10 = 1 s
111.08	<i>DIO1 OFF delay</i>	Defines the deactivation delay for digital input/output DIO1 (when used as a digital output or digital input). See parameter <i>111.07 DIO1 ON delay</i> .	0.0 s
	0.0 ... 3000.0 s	Deactivation delay for DIO1.	10 = 1 s

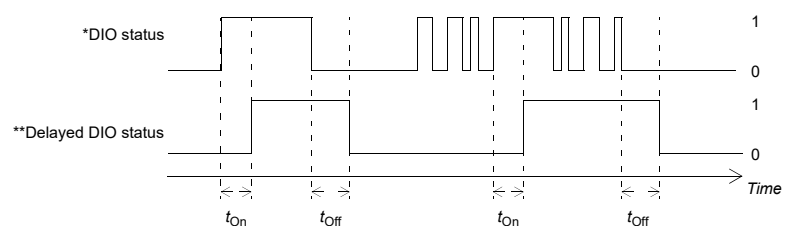
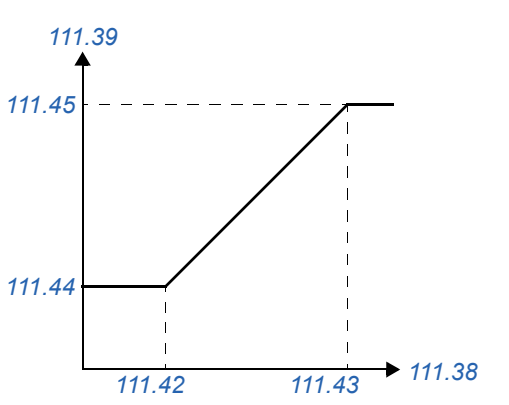
No.	Name/Value	Description	Def/FbEq16
111.09	<i>DIO2 function</i>	Selects whether DIO2 is used as a digital output or input, or a frequency output.	<i>Output</i>
	Output	DIO2 is used as a digital output.	0
	Input	DIO2 is used as a digital input.	1
111.10	<i>DIO2 output source</i>	Selects a signal to be connected to digital input/output DIO2 when parameter <i>111.09 DIO2 function</i> is set to <i>Output</i> . For selections, see parameter <i>111.06 DIO1 output source</i> .	<i>MCB</i>
111.11	<i>DIO2 ON delay</i>	Defines the activation delay for digital input/output DIO2 (when used as a digital output or digital input).	0.0 s
	 <p> $t_{On} = 111.11$ <i>DIO2 ON delay</i> $t_{Off} = 111.12$ <i>DIO2 OFF delay</i> *Electrical status of DIO (in input mode) or status of selected source (in output mode). Indicated by <i>111.01 DIO status</i>. **Indicated by <i>111.02 DIO delayed status</i>. </p>		
	0.0 ... 3000.0 s	Activation delay for DIO2.	10 = 1 s
111.12	<i>DIO2 OFF delay</i>	Defines the deactivation delay for digital input/output DIO2 (when used as a digital output or digital input). See parameter <i>111.11 DIO2 ON delay</i> .	0.0 s
	0.0 ... 3000.0 s	Deactivation delay for DIO2.	10 = 1 s
111.38	<i>Freq in 1 actual value</i>	Displays the value of frequency input 1 before scaling. See parameter <i>111.42 Freq in 1 min</i> . This parameter is read-only.	-
	0 ... 16000 Hz	Unscaled value of frequency input 1.	1 = 1 Hz
111.39	<i>Freq in 1 scaled</i>	Displays the value of frequency input 1 after scaling. See parameter <i>111.42 Freq in 1 min</i> . This parameter is read-only.	-
	-32768.000 ... 32767.000	Scaled value of frequency input 1.	1 = 1
111.42	<i>Freq in 1 min</i>	Defines the minimum input frequency for frequency input 1 (DIO1 when it is used as a frequency input). The incoming frequency signal (<i>111.38 Freq in 1 actual value</i>) is scaled into an internal signal (<i>111.39 Freq in 1 scaled</i>) by parameters <i>111.42...111.45</i> as follows:	0 Hz
			
	0 ... 16000 Hz	Minimum frequency of frequency input 1 (DIO1).	1 = 1 Hz

88 Parameters

No.	Name/Value	Description	Def/FbEq16																		
111.43	<i>Freq in 1 max</i>	Defines the maximum input frequency for frequency input 1 (DIO1 when it is used as a frequency input). See parameter <i>111.42 Freq in 1 min</i> .	16000 Hz																		
	0 ... 16000 Hz	Maximum frequency for frequency input 1 (DIO1).	1 = 1 Hz																		
111.44	<i>Freq in 1 at scaled min</i>	Defines the value that corresponds to the minimum input frequency defined by parameter <i>111.42 Freq in 1 min</i> . See diagram at parameter <i>111.42 Freq in 1 min</i> .	0.000																		
	-32768.000 ... 32767.000	Value corresponding to minimum of frequency input 1.	1 = 1																		
111.45	<i>Freq in 1 at scaled max</i>	Defines the value that corresponds to the maximum input frequency defined by parameter <i>111.43 Freq in 1 max</i> . See diagram at parameter <i>111.42 Freq in 1 min</i> .	1500.000																		
	-32768.000 ... 32767.000	Value corresponding to maximum of frequency input 1.	1 = 1																		
111.81	<i>DIO filter time</i>	Defines a filtering time for parameter <i>111.01 DIO status</i> . The filtering time will only affect the DIOs that are in input mode.	10.0 ms																		
	0.3 ... 100.0 ms	Filtering time for <i>111.01</i> .	10 = 1 ms																		
112 Standard AI		Configuration of standard analog inputs.																			
112.01	<i>AI tune</i>	Triggers the analog input tuning function. Connect the signal to the input and select the appropriate tuning function.	<i>No action</i>																		
	No action	AI tune is not activated.	0																		
	AI1 min tune	Current analog input AI1 signal value is set as minimum value of AI1 into parameter <i>112.17 AI1 min</i> . The value reverts back to <i>No action</i> automatically.	1																		
	AI1 max tune	Current analog input AI1 signal value is set as maximum value of AI1 into parameter <i>112.18 AI1 max</i> . The value reverts back to <i>No action</i> automatically.	2																		
	AI2 min tune	Current analog input AI2 signal value is set as minimum value of AI2 into parameter <i>112.27 AI2 min</i> . The value reverts back to <i>No action</i> automatically.	3																		
	AI2 max tune	Current analog input AI2 signal value is set as maximum value of AI2 into parameter <i>112.28 AI2 max</i> . The value reverts back to <i>No action</i> automatically.	4																		
112.03	<i>AI supervision function</i>	Selects how the supply unit reacts when an analog input signal moves out of the minimum and/or maximum limits specified for the input. The inputs and the limits to be observed are selected by parameter <i>112.04 AI supervision selection</i> .	<i>No action</i>																		
	No action	No action taken.	0																		
	Fault	Drive trips on <i>8E06 AI supervision</i> .	1																		
	Warning	Drive generates an <i>AE67 AI supervision</i> warning.	2																		
112.04	<i>AI supervision selection</i>	Specifies the analog input limits to be supervised. See parameter <i>112.03 AI supervision function</i> .	0000b																		
		<table border="1"> <thead> <tr> <th>Bit</th> <th>Name</th> <th>Description</th> </tr> </thead> <tbody> <tr> <td>0</td> <td>AI1 < MIN</td> <td>1 = Minimum limit supervision of AI1 active.</td> </tr> <tr> <td>1</td> <td>AI1 > MAX</td> <td>1 = Maximum limit supervision of AI1 active.</td> </tr> <tr> <td>2</td> <td>AI2 < MIN</td> <td>1 = Minimum limit supervision of AI2 active.</td> </tr> <tr> <td>3</td> <td>AI2 > MAX</td> <td>1 = Maximum limit supervision of AI2 active.</td> </tr> <tr> <td>4...15</td> <td>Reserved</td> <td></td> </tr> </tbody> </table>	Bit	Name	Description	0	AI1 < MIN	1 = Minimum limit supervision of AI1 active.	1	AI1 > MAX	1 = Maximum limit supervision of AI1 active.	2	AI2 < MIN	1 = Minimum limit supervision of AI2 active.	3	AI2 > MAX	1 = Maximum limit supervision of AI2 active.	4...15	Reserved		
Bit	Name	Description																			
0	AI1 < MIN	1 = Minimum limit supervision of AI1 active.																			
1	AI1 > MAX	1 = Maximum limit supervision of AI1 active.																			
2	AI2 < MIN	1 = Minimum limit supervision of AI2 active.																			
3	AI2 > MAX	1 = Maximum limit supervision of AI2 active.																			
4...15	Reserved																				
	0000b...1111b	Activation of analog input supervision.	1 = 1																		

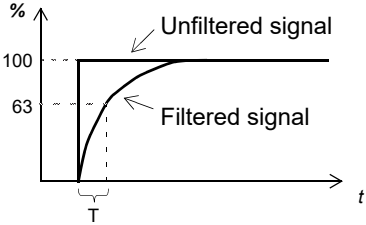
No.	Name/Value	Description	Def/FbEq16
112.11	<i>AI1 actual value</i>	Displays the value of analog input AI1 in mA or V (depending on whether the input is set to current or voltage by jumper J1). This parameter is read-only.	-
	-22.000 ... 22.000 mA or V	Value of analog input AI1.	1000 = 1 mA or V
112.12	<i>AI1 scaled value</i>	Displays the value of analog input AI1 after scaling. See parameters <i>112.19 AI1 scaled at AI1 min</i> and <i>112.20 AI1 scaled at AI1 max</i> . This parameter is read-only.	-
	-32768.000 ... 32767.000	Scaled value of analog input AI1.	1 = 1
112.15	<i>AI1 unit selection</i>	Selects the unit for readings and settings related to analog input AI1. Note: This setting must match the corresponding jumper setting on the control unit (see the appropriate hardware manual). Control board reboot (either by cycling the power or through parameter <i>196.08 Control board boot</i>) is required to validate any changes in the jumper settings.	V
	V	Volts.	2
	mA	Milliamperes.	10
112.16	<i>AI1 filter time</i>	Defines the filter time constant for analog input AI1.  $O = I \times (1 - e^{-t/T})$ I = filter input (step) O = filter output t = time T = filter time constant Note: The signal is also filtered due to the signal interface hardware (approximately 0.25 ms time constant). This cannot be changed by any parameter.	0.000 s
	0.000 ... 30.000 s	Filter time constant.	1000 = 1 s
112.17	<i>AI1 min</i>	Defines the minimum value for analog input AI1.	0.000 mA
	-22.000 ... 22.000 mA or V	Minimum value of AI1.	1000 = 1 mA or V
112.18	<i>AI1 max</i>	Defines the maximum value for analog input AI1.	10.000 mA
	-22.000 ... 22.000 mA	Maximum value of AI1.	1000 = 1 mA

90 Parameters

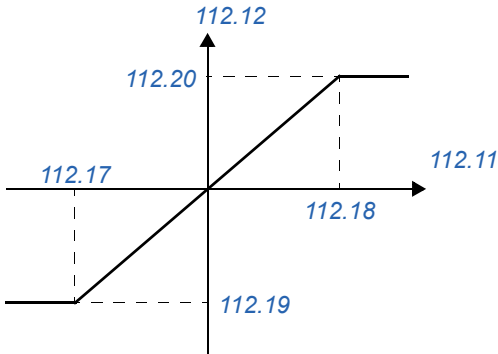
No.	Name/Value	Description	Def/FbEq16
112.19	<i>AI1 scaled at AI1 min</i>	Defines the real value that corresponds to the minimum analog input AI1 value defined by parameter <i>112.17 AI1 min</i> . 	0.000
	-32768.000 ... 32767.000	Real value corresponding to minimum AI1 value.	1 = 1
112.20	<i>AI1 scaled at AI1 max</i>	Defines the real value that corresponds to the maximum analog input AI1 value defined by parameter <i>112.18 AI1 max</i> . See the drawing at parameter <i>112.19 AI1 scaled at AI1 min</i> .	1500.000
	-32768.000 ... 32767.000	Real value corresponding to maximum AI1 value.	1 = 1
112.21	<i>AI2 actual value</i>	Displays the value of analog input AI2 in mA or V (depending on whether the input is set to current or voltage by jumper J2). This parameter is read-only.	-
	-22.000 ... 22.000 mA	Value of analog input AI2.	1000 = 1 mA or V
112.22	<i>AI2 scaled value</i>	Displays the value of analog input AI2 after scaling. See parameters <i>112.29 AI2 scaled at AI2 min</i> and <i>112.30 AI2 scaled at AI2 max</i> . This parameter is read-only.	-
	-32768.000 ... 32767.000	Scaled value of analog input AI2.	1 = 1
112.25	<i>AI2 unit selection</i>	Selects the unit for readings and settings related to analog input AI2. Note: This setting must match the corresponding jumper setting on the control unit (see the appropriate hardware manual). Control board reboot (either by cycling the power or through parameter <i>196.08 Control board boot</i>) is required to validate any changes in the jumper settings.	<i>mA</i>
	V	Volts.	2
	mA	Milliamperes.	10
112.26	<i>AI2 filter time</i>	Defines the filter time constant for analog input AI2. See parameter <i>112.16 AI1 filter time</i> .	0.000 s
	0.000 ... 30.000 s	Filter time constant.	1000 = 1 s
112.27	<i>AI2 min</i>	Defines the minimum value for analog input AI2.	0.000 mA
	-22.000 ... 22.000 mA or V	Minimum value of AI2.	1000 = 1 mA or V
112.28	<i>AI2 max</i>	Defines the maximum value for analog input AI2.	20.000 mA
	-22.000 ... 22.000 mA or V	Maximum value of AI2.	1000 = 1 mA or V

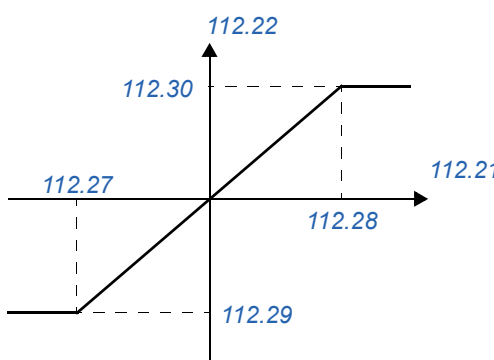
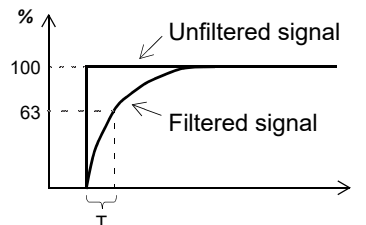
No.	Name/Value	Description	Def/FbEq16
112.29	<i>AI2 scaled at AI2 min</i>	Defines the real value that corresponds to the minimum analog input AI2 value defined by parameter 112.27 AI2 min . 	0.000
	-32768.000 ... 32767.000	Real value corresponding to minimum AI2 value.	1 = 1
112.30	<i>AI2 scaled at AI2 max</i>	Defines the real value that corresponds to the maximum analog input AI2 value defined by parameter 112.28 AI2 max . See the drawing at parameter 112.29 AI2 scaled at AI2 min .	1500.000
	-32768.000 ... 32767.000	Real value corresponding to maximum AI2 value.	1 = 1
113 Standard AO		Configuration of analog outputs.	
113.11	<i>AO1 actual value</i>	Displays the value of AO1 in mA. This parameter is read-only.	-
	0.000 ... 22.000 mA	Value of AO1.	1000 = 1 mA
113.12	<i>AO1 source</i>	Selects a signal to be connected to analog output AO1.	<i>Zero</i>
	Zero	None.	0
	DC voltage	101.01 DC voltage	1
	Line current	101.02 Line current	2
	AO1 data storage	113.91 AO1 data storage (page 93).	37
	AO2 data storage	113.92 AO2 data storage (page 93).	38
	Other	The value is taken from another parameter.	-
113.16	<i>AO1 filter time</i>	Defines the filtering time constant for analog output AO1.  $O = I \times (1 - e^{-t/T})$ I = filter input (step) O = filter output t = time T = filter time constant	0.100 s
	0.000 ... 30.000 s	Filter time constant.	1000 = 1 s

92 Parameters

No.	Name/Value	Description	Def/FbEq16
113.17	AO1 source min	<p>Defines the real value of the signal (selected by parameter 113.12 AO1 source) that corresponds to the minimum AO1 output value (defined by parameter 113.19 AO1 out at AO1 src min).</p> <p>The figure consists of two graphs. Both graphs have I_{AO1} (mA) on the vertical axis and 'Signal (real) selected by par. 113.12' on the horizontal axis. The top graph shows a signal value increasing from 113.17 to 113.18. The output current I_{AO1} starts at 113.19 mA for a signal of 113.17, remains constant until the signal reaches 113.18, then increases linearly to 113.20 mA at signal 113.18, and remains constant thereafter. The bottom graph shows a signal value decreasing from 113.18 to 113.17. The output current I_{AO1} starts at 113.20 mA for a signal of 113.18, remains constant until the signal reaches 113.17, then decreases linearly to 113.19 mA at signal 113.17, and remains constant thereafter.</p>	0.0
	-32768.0 ... 32767.0	Real signal value corresponding to minimum AO1 output value.	1 = 1
113.18	AO1 source max	<p>Defines the real value of the signal (selected by parameter 113.12 AO1 source) that corresponds to the maximum AO1 output value (defined by parameter 113.20 AO1 out at AO1 src max). See parameter 113.17 AO1 source min.</p>	100.0
	-32768.0 ... 32767.0	Real signal value corresponding to maximum AO1 output value.	1 = 1
113.19	AO1 out at AO1 src min	<p>Defines the minimum output value for analog output AO1. See also drawing at parameter 113.17 AO1 source min.</p>	4.000 mA
	0.000 ... 22.000 mA	Minimum AO1 output value.	1000 = 1 mA
113.20	AO1 out at AO1 src max	<p>Defines the maximum output value for analog output AO1. See also drawing at parameter 113.17 AO1 source min.</p>	20.000 mA
	0.000 ... 22.000 mA	Maximum AO1 output value.	1000 = 1 mA
113.21	AO2 actual value	<p>Displays the value of AO2 in mA. This parameter is read-only.</p>	-
	0.000 ... 22.000 mA	Value of AO2.	1000 = 1 mA
113.22	AO2 source	<p>Selects a signal to be connected to analog output AO2. For the selections, see parameter 113.12 AO1 source.</p>	Zero
113.26	AO2 filter time	<p>Defines the filtering time constant for analog output AO2. See parameter 113.16 AO1 filter time.</p>	0.100 s
	0.000 ... 30.000 s	Filter time constant.	1000 = 1 s

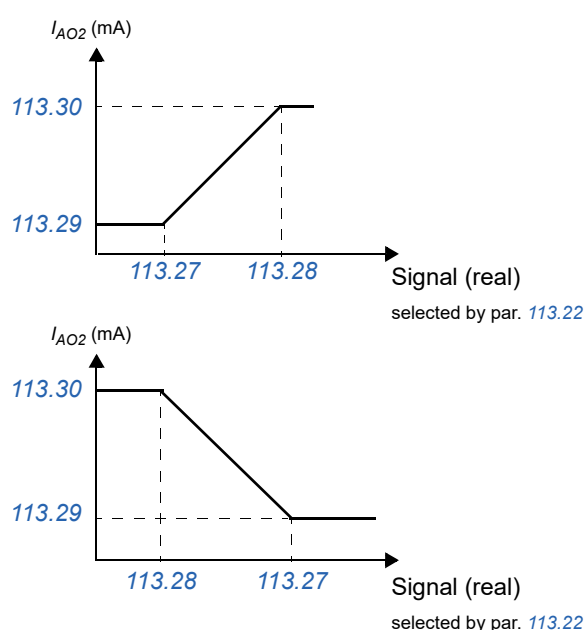
No.	Name/Value	Description	Def/FbEq16
113.27	<i>AO2 source min</i>	<p>Defines the real value of the signal (selected by parameter 113.22 AO2 source) that corresponds to the minimum AO2 output value (defined by parameter 113.29 AO2 out at AO2 src min).</p>  <p>The figure contains two graphs. Both graphs have I_{AO2} (mA) on the vertical axis and 'Signal (real) selected by par. 113.22' on the horizontal axis. The top graph shows a signal value of 113.27 on the x-axis corresponding to an output of 113.29 mA on the y-axis, and a signal value of 113.28 on the x-axis corresponding to an output of 113.30 mA on the y-axis. The bottom graph shows a signal value of 113.28 on the x-axis corresponding to an output of 113.30 mA on the y-axis, and a signal value of 113.27 on the x-axis corresponding to an output of 113.29 mA on the y-axis.</p>	0.0
	-32768.0 ... 32767.0	Real signal value corresponding to minimum AO2 output value.	1 = 1
113.28	<i>AO2 source max</i>	<p>Defines the real value of the signal (selected by parameter 113.22 AO2 source) that corresponds to the maximum AO2 output value (defined by parameter 113.30 AO2 out at AO2 src max). See parameter 113.27 AO2 source min.</p>	100.0
	-32768.0 ... 32767.0	Real signal value corresponding to maximum AO2 output value.	1 = 1
113.29	<i>AO2 out at AO2 src min</i>	<p>Defines the minimum output value for analog output AO2. See also drawing at parameter 113.27 AO2 source min.</p>	4.000 mA
	0.000 ... 22.000 mA	Minimum AO2 output value.	1000 = 1 mA
113.30	<i>AO2 out at AO2 src max</i>	<p>Defines the maximum output value for analog output AO2. See also drawing at parameter 113.27 AO2 source min.</p>	20.000 mA
	0.000 ... 22.000 mA	Maximum AO2 output value.	1000 = 1 mA
113.91	<i>AO1 data storage</i>	<p>Storage parameter for controlling analog output AO1 eg. through fieldbus. In 113.12 AO1 source, select AO1 data storage. Then set this parameter as the target of the incoming value data.</p>	0.00
	-327.68 ... 327.67	Storage parameter for AO1.	100 = 1
113.92	<i>AO2 data storage</i>	<p>Storage parameter for controlling analog output AO2 eg. through fieldbus. In 113.22 AO2 source, select AO2 data storage. Then set this parameter as the target of the incoming value data.</p>	0.00
	-327.68 ... 327.67	Storage parameter for AO2.	100 = 1

94 Parameters

No.	Name/Value	Description	Def/FbEq16
	<i>114 Extension I/O module 1</i>	Configuration of I/O extension module 1. See also section <i>Programmable I/O extensions</i> (page 28). Note: The contents of the parameter group vary according to the selected I/O extension module type.	
<i>114.01</i>	<i>Module 1 type</i>	Activates (and specifies the type of) I/O extension module 1.	<i>None</i>
	None	Inactive.	0
	FIO-01	FIO-01.	1
	FIO-11	FIO-11.	2
	FDIO-01	FDIO-01.	3
	FAIO-01	FAIO-01.	4
<i>114.02</i>	<i>Module 1 location</i>	Specifies the node number (1...3) on the control unit into which the I/O extension module is installed. (Node 1 = slot 1, node 2 = slot 2, node 3 = slot 3) Alternatively, specifies the node ID of the slot on an FEA-0x extension adapter.	<i>Slot 1</i>
	Slot 1	Slot 1.	1
	Slot 2	Slot 2.	2
	Slot 3	Slot 3.	3
	4...254	Node ID of the slot on the FEA-03 extension adapter.	1 = 1
<i>114.03</i>	<i>Module 1 status</i>	Displays the status of I/O extension module 1.	<i>No option</i>
	No option	No module detected in the specified slot.	0
	No communication	A module has been detected but cannot be communicated with.	1
	Unknown	The module type is unknown.	2
	FIO-01	An FIO-01 module has been detected and is active.	3
	FIO-11	An FIO-11 module has been detected and is active.	4
	FAIO-01	An FAIO-01 module has been detected and is active.	24
	FDIO-01	An FDIO-01 module has been detected and is active.	25
<i>114.05</i>	<i>DI status</i>	<i>(Visible when 114.01 Module 1 type = FDIO-01)</i> Displays the status of the digital inputs on the extension module. The activation/deactivation delays (if any are specified) are ignored. A filtering time (for input mode) can be defined by parameter <i>114.08 DI filter time</i> . Bit 0 indicates the status of DI1. Note: The number of active bits in this parameter depends on the number of digital input/outputs on the extension module. Example: 0101b = DI1 and DI3 are on, remainder are off. This parameter is read-only.	-
	0000b...1111b	Status of digital inputs.	1 = 1
<i>114.05</i>	<i>DIO status</i>	<i>(Visible when 114.01 Module 1 type = FIO-01 or FIO-11)</i> Displays the electrical status of the digital input/outputs on the extension module. The activation/deactivation delays (if any are specified) are ignored. Bit 0 indicates the status of DIO1. Note: The number of active bits in this parameter depends on the number of digital input/outputs on the extension module. Example: 1001b = DIO1 and DIO4 are on, remainder are off. This parameter is read-only.	-
	0000b...1111b	Status of digital input/outputs.	1 = 1

No.	Name/Value	Description	Def/FbEq16
114.06	<i>DI delayed status</i>	(Visible when 114.01 Module 1 type = <i>FDIO-01</i>) Displays the delayed status of the digital inputs on the extension module. The word is updated only after activation/deactivation delays (if any are specified). Bit 0 indicates the status of DI1. Note: The number of active bits in this parameter depends on the number of digital inputs on the extension module. Example: 0101b = DI1 and DI3 are on, remainder are off. This parameter is read-only.	-
	0000b...1111b	Delayed status of digital inputs.	1 = 1
114.06	<i>DIO delayed status</i>	(Visible when 114.01 Module 1 type = <i>FIO-01</i> or <i>FIO-11</i>) Displays the status of the digital input/outputs on the extension module. This word is updated only after activation/deactivation delays (if any are specified). Bit 0 indicates the status of DIO1. Note: The number of active bits in this parameter depends on the number of digital input/outputs on the extension module. Example: 1001b = DIO1 and DIO4 are on, remainder are off. This parameter is read-only.	-
	0000b...1111b	Delayed status of digital input/outputs.	1 = 1
114.08	<i>DI filter time</i>	(Visible when 114.01 Module 1 type = <i>FDIO-01</i>) Defines a filtering time for parameter 114.05 <i>DI status</i> .	10.0 ms
	0.8 ... 100.0 ms	Filtering time for 114.05.	10 = 1 ms
114.08	<i>DIO filter time</i>	(Visible when 114.01 Module 1 type = <i>FIO-01</i> or <i>FIO-11</i>) Defines a filtering time for parameter 114.05 <i>DIO status</i> . The filtering time will only affect the DIOs that are in input mode.	10.0 ms
	0.8 ... 100.0 ms	Filtering time for 114.05.	10 = 1 ms
114.09	<i>DIO1 configuration</i>	(Visible when 114.01 Module 1 type = <i>FIO-01</i> or <i>FIO-11</i>) Selects whether DIO1 of the extension module is used as a digital input or output.	<i>Input</i>
	Input	DIO1 is used as a digital input.	0
	Output	DIO1 is used as a digital output.	1
114.11	<i>DIO1 output source</i>	(Visible when 114.01 Module 1 type = <i>FIO-01</i> or <i>FIO-11</i>) Selects a signal to be connected to digital input/output DIO1 when parameter 114.09 <i>DIO1 configuration</i> is set to <i>Output</i> .	<i>Not energized</i>
	Not energized	Output is not energized.	0
	Energized	Output is energized.	1
	Ready	Bit 0 of 106.11 <i>Main status word</i> (see page 75). Output is energized when the IGBT supply unit is ready.	2
	Charge ready	Bit 1 of 106.11 <i>Main status word</i> (see page 75). Output is energized when the intermediate circuit DC charging is ready.	3
	Enabled	Bit 0 of 106.16 <i>Drive status word 1</i> (see page 75). Output is energized when the IGBT supply unit is enabled.	4
	Started	Bit 5 of 106.16 <i>Drive status word 1</i> (see page 75). Output is energized when the IGBT supply unit is started.	5
	Running	Bit 4 of 106.16 <i>Drive status word 1</i> (see page 75). Output is energized when the IGBT supply unit is running.	6
	Warning	Bit 7 of 106.11 <i>Main status word</i> (see page 75). Output is energized when a warning is active.	13
	Fault	Bit 3 of 106.11 <i>Main status word</i> (see page 75). Output is energized when a fault is active.	14
	MCB	Bit 13 of 106.16 <i>Drive status word 1</i> (see page 75). Output is energized when MCB closing command is given.	15

No.	Name/Value	Description	Def/FbEq16
	Charging	Bit 12 of <i>106.16 Drive status word 1</i> (see page 75). Output is energized when the external charging has charged the IGBT supply unit.	16
	<i>Other</i>	A specific bit in another parameter.	-
114.12	<i>DI1 ON delay</i>	(Visible when <i>114.01 Module 1 type = FDIO-01</i>) Defines the activation delay for digital input DI1.	0.00 s
<p> $t_{On} = 114.12$ <i>DI1 ON delay</i> $t_{Off} = 114.13$ <i>DI1 OFF delay</i> *Electrical status of DI or status of selected source (in output mode). Indicated by <i>114.05 DI status</i>. **Indicated by <i>114.06 DI delayed status</i>. </p>			
	0.00 ... 3000.00 s	Activation delay for DI1.	10 = 1 s
114.12	<i>DIO1 ON delay</i>	(Visible when <i>114.01 Module 1 type = FIO-01</i> or <i>FIO-11</i>) Defines the activation delay for digital input/output DIO1.	0.0 s
<p> $t_{On} = 114.12$ <i>DIO1 ON delay</i> $t_{Off} = 114.13$ <i>DIO1 OFF delay</i> *Electrical status of DIO (in input mode) or status of selected source (in output mode). Indicated by <i>114.05 DIO status</i>. **Indicated by <i>114.06 DIO delayed status</i>. </p>			
	0.0 ... 3000.0 s	Activation delay for DIO1.	10 = 1 s
114.13	<i>DI1 OFF delay</i>	(Visible when <i>114.01 Module 1 type = FDIO-01</i>) Defines the deactivation delay for digital input DI1. See parameter <i>114.12 DI1 ON delay</i> .	0.00 s
	0.00 ... 3000.00 s	Deactivation delay for DI1.	10 = 1 s
114.13	<i>DIO1 OFF delay</i>	(Visible when <i>114.01 Module 1 type = FIO-01</i> or <i>FIO-11</i>) Defines the deactivation delay for digital input/output DIO1. See parameter <i>114.12 DIO1 ON delay</i> .	0.0 s
	0.0 ... 3000.0 s	Deactivation delay for DIO1.	10 = 1 s
114.14	<i>DIO2 configuration</i>	(Visible when <i>114.01 Module 1 type = FIO-01</i> or <i>FIO-11</i>) Selects whether DIO2 of the extension module is used as a digital input or output.	<i>Input</i>
	Input	DIO2 is used as a digital input.	0
	Output	DIO2 is used as a digital output.	1
114.16	<i>DIO2 output source</i>	(Visible when <i>114.01 Module 1 type = FIO-01</i> or <i>FIO-11</i>) Selects a signal to be connected to digital input/output DIO2 when parameter <i>114.14 DIO2 configuration</i> is set to <i>Output</i> . For the available selections, see parameter <i>114.11 DIO1 output source</i> .	<i>Not energized</i>

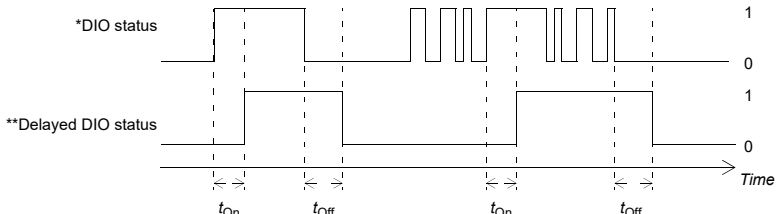
No.	Name/Value	Description	Def/FbEq16
114.17	<i>DI2 ON delay</i>	(Visible when 114.01 Module 1 type = FDIO-01) Defines the activation delay for digital input DI2. See parameter 114.12 DI1 ON delay.	0.00 s
	0.00 ... 3000.00 s	Activation delay for DI2.	10 = 1 s
114.17	<i>DIO2 ON delay</i>	(Visible when 114.01 Module 1 type = FIO-01 or FIO-11) Defines the activation delay for digital input/output DIO2.	0.0 s
	 <p>t_{On} = 114.17 DIO2 ON delay t_{Off} = 114.18 DIO2 OFF delay *Electrical status of DIO (in input mode) or status of selected source (in output mode). Indicated by 114.05 DIO status. **Indicated by 114.06 DIO delayed status.</p>		
	0.0 ... 3000.0 s	Activation delay for DIO2.	10 = 1 s
114.18	<i>DI2 OFF delay</i>	(Visible when 114.01 Module 1 type = FDIO-01) Defines the deactivation delay for digital input DI2. See parameter 114.12 DI1 ON delay.	0.00 s
	0.00 ... 3000.00 s	Deactivation delay for DI2.	10 = 1 s
114.18	<i>DIO2 OFF delay</i>	(Visible when 114.01 Module 1 type = FIO-01 or FIO-11) Defines the deactivation delay for digital input/output DIO2. See parameter 114.17 DIO2 ON delay.	0.0 s
	0.0 ... 3000.0 s	Deactivation delay for DIO2.	10 = 1 s
114.19	<i>DIO3 configuration</i>	(Visible when 114.01 Module 1 type = FIO-01) Selects whether DIO3 of the extension module is used as a digital input or output.	Input
	Input	DIO3 is used as a digital input.	0
	Output	DIO3 is used as a digital output.	1
114.19	<i>AI supervision function</i>	(Visible when 114.01 Module 1 type = FIO-11 or FAIO-01) Selects how the IGBT supply unit reacts when an analog input signal moves out of the minimum and/or maximum limits specified for the input. The inputs and the limits to be observed are selected by parameter 114.20 AI supervision selection.	No action
	No action	No action taken.	0
	Fault	IGBT supply unit trips on 8E06 AI supervision.	1
	Warning	IGBT supply unit generates an AE67 AI supervision warning.	2

No.	Name/Value	Description	Def/FbEq16																								
114.20	<i>AI supervision selection</i>	(Visible when 114.01 Module 1 type = FIO-11 or FAIO-01) Specifies the analog input limits to be supervised. See parameter 114.19 AI supervision function.	0000h																								
<table border="1"> <thead> <tr> <th>Bit</th> <th>Name</th> <th>Description</th> </tr> </thead> <tbody> <tr> <td>0</td> <td>AI1 < MIN</td> <td>1 = Minimum limit supervision of AI1 active.</td> </tr> <tr> <td>1</td> <td>AI1 > MAX</td> <td>1 = Maximum limit supervision of AI1 active.</td> </tr> <tr> <td>2</td> <td>AI2 < MIN</td> <td>1 = Minimum limit supervision of AI2 active.</td> </tr> <tr> <td>3</td> <td>AI2 > MAX</td> <td>1 = Maximum limit supervision of AI2 active.</td> </tr> <tr> <td>4</td> <td>AI3 < MIN</td> <td>1 = Minimum limit supervision of AI3 active.</td> </tr> <tr> <td>5</td> <td>AI3 > MAX</td> <td>1 = Maximum limit supervision of AI3 active.</td> </tr> <tr> <td>6...15</td> <td>Reserved</td> <td></td> </tr> </tbody> </table>				Bit	Name	Description	0	AI1 < MIN	1 = Minimum limit supervision of AI1 active.	1	AI1 > MAX	1 = Maximum limit supervision of AI1 active.	2	AI2 < MIN	1 = Minimum limit supervision of AI2 active.	3	AI2 > MAX	1 = Maximum limit supervision of AI2 active.	4	AI3 < MIN	1 = Minimum limit supervision of AI3 active.	5	AI3 > MAX	1 = Maximum limit supervision of AI3 active.	6...15	Reserved	
Bit	Name	Description																									
0	AI1 < MIN	1 = Minimum limit supervision of AI1 active.																									
1	AI1 > MAX	1 = Maximum limit supervision of AI1 active.																									
2	AI2 < MIN	1 = Minimum limit supervision of AI2 active.																									
3	AI2 > MAX	1 = Maximum limit supervision of AI2 active.																									
4	AI3 < MIN	1 = Minimum limit supervision of AI3 active.																									
5	AI3 > MAX	1 = Maximum limit supervision of AI3 active.																									
6...15	Reserved																										
0000h...FFFFh		Activation of analog input supervision.	1 = 1																								
114.21	<i>DIO3 output source</i>	(Visible when 114.01 Module 1 type = FIO-01) Selects a signal to be connected to digital input/output DIO3 when parameter 114.19 DIO3 configuration is set to <i>Output</i> . For the available selections, see parameter 114.11 DIO1 output source.	<i>Not energized</i>																								
114.22	<i>DI3 ON delay</i>	(Visible when 114.01 Module 1 type = FDIO-01) Defines the activation delay for digital input DI3. See parameter 114.12 DI1 ON delay.	0.00 s																								
0.00 ... 3000.00 s		Activation delay for DI3.	10 = 1 s																								
114.22	<i>DIO3 ON delay</i>	(Visible when 114.01 Module 1 type = FIO-01) Defines the activation delay for digital input/output DIO3.	0.0 s																								
<p><i>t_{On}</i> = 114.22 DIO3 ON delay <i>t_{Off}</i> = 114.23 DIO3 OFF delay *Electrical status of DIO (in input mode) or status of selected source (in output mode). Indicated by 114.05 DIO status. **Indicated by 114.06 DIO delayed status.</p>																											
0.0 ... 3000.0 s		Activation delay for DIO3.	10 = 1 s																								
114.22	<i>AI force sel</i>	(Visible when 114.01 Module 1 type = FIO-11 or FAIO-01) The true readings of the analog inputs can be overridden for eg. testing purposes. A forced value parameter is provided for each analog input, and its value is applied whenever the corresponding bit in this parameter is 1.	00000000h																								
<table border="1"> <thead> <tr> <th>Bit</th> <th>Value</th> </tr> </thead> <tbody> <tr> <td>0</td> <td>1 = Force AI1 to value of parameter 114.28 AI1 force data.</td> </tr> <tr> <td>1</td> <td>1 = Force AI2 to value of parameter 114.43 AI2 force data.</td> </tr> <tr> <td>2</td> <td>1 = Force AI3 to value of parameter 114.58 AI3 force data.</td> </tr> <tr> <td>3...31</td> <td>Reserved.</td> </tr> </tbody> </table>				Bit	Value	0	1 = Force AI1 to value of parameter 114.28 AI1 force data.	1	1 = Force AI2 to value of parameter 114.43 AI2 force data.	2	1 = Force AI3 to value of parameter 114.58 AI3 force data.	3...31	Reserved.														
Bit	Value																										
0	1 = Force AI1 to value of parameter 114.28 AI1 force data.																										
1	1 = Force AI2 to value of parameter 114.43 AI2 force data.																										
2	1 = Force AI3 to value of parameter 114.58 AI3 force data.																										
3...31	Reserved.																										
00000000h ... FFFFFFFFh		Forced values selector for analog inputs.	1 = 1																								

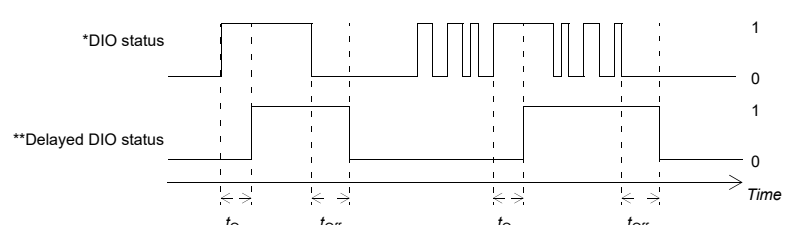
No.	Name/Value	Description	Def/FbEq16
114.23	<i>D13 OFF delay</i>	(Visible when 114.01 Module 1 type = FDIO-01) Defines the deactivation delay for digital input DI3. See parameter 114.12 DI1 ON delay.	0.00 s
	0.00 ... 3000.00 s	Deactivation delay for DI3.	10 = 1 s
114.23	<i>DIO3 OFF delay</i>	(Visible when 114.01 Module 1 type = FIO-01) Defines the deactivation delay for digital input/output DIO3. See parameter 114.22 DIO3 ON delay.	0.0 s
	0.0 ... 3000.0 s	Deactivation delay for DIO3.	10 = 1 s
114.24	<i>DIO4 configuration</i>	(Visible when 114.01 Module 1 type = FIO-01) Selects whether DIO4 of the I/O extension module is used as a digital input or output.	Input
	Input	DIO4 is used as a digital input.	0
	Output	DIO4 is used as a digital output.	1
114.26	<i>DIO4 output source</i>	(Visible when 114.01 Module 1 type = FIO-01) Selects a signal to be connected to digital input/output DIO4 when parameter 114.24 DIO4 configuration is set to Output. For the available selections, see parameter 114.11 DIO1 output source.	Not energized
114.26	<i>AI1 actual value</i>	(Visible when 114.01 Module 1 type = FIO-11 or FAIO-01) Displays the value of analog input AI1 in mA or V (depending on whether the input is set to current or voltage). This parameter is read-only.	-
	-22.000 ... 22.000 mA or V	Value of analog input AI1.	1000 = 1 mA or V
114.27	<i>DIO4 ON delay</i>	(Visible when 114.01 Module 1 type = FIO-01) Defines the activation delay for digital input/output DIO4.	0.0 s
	 <p>$t_{On} = 114.27$ DIO4 ON delay $t_{Off} = 114.28$ DIO4 OFF delay *Electrical status of DIO (in input mode) or status of selected source (in output mode). Indicated by 114.05 DIO status. **Indicated by 114.06 DIO delayed status.</p>		
	0.0 ... 3000.0 s	Activation delay for DIO4.	10 = 1 s
114.27	<i>AI1 scaled value</i>	(Visible when 114.01 Module 1 type = FIO-11 or FAIO-01) Displays the value of analog input AI1 after scaling. See parameter 114.35 AI1 scaled at AI1 min. This parameter is read-only.	-
	-32768.000 ... 32767.000	Scaled value of analog input AI1.	1 = 1
114.28	<i>DIO4 OFF delay</i>	(Visible when 114.01 Module 1 type = FIO-01) Defines the deactivation delay for digital input/output DIO4. See parameter 114.27 DIO4 ON delay.	0.0 s
	0.0 ... 3000.0 s	Deactivation delay for DIO4.	10 = 1 s
114.28	<i>AI1 force data</i>	(Visible when 114.01 Module 1 type = FIO-11 or FAIO-01) Forced value that can be used instead of the true reading of the input. See parameter 114.22 AI force sel.	-
	-22.000 ... 22.000 mA or V	Forced value of analog input AI1.	1000 = 1 mA or V

100 Parameters

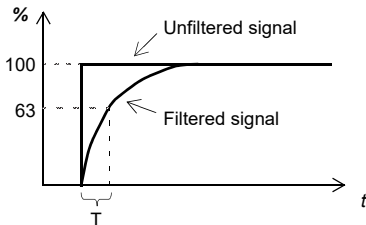
No.	Name/Value	Description	Def/FbEq16
114.29	AI1 HW switch pos	(Visible when 114.01 Module 1 type = FIO-11 or FAIO-01) Shows the position of the hardware current/voltage selector on the I/O extension module. Note: The setting of the current/voltage selector must match the unit selection made in parameter 114.30 AI1 unit selection.	-
	V	Volts.	2
	mA	Milliamperes.	10
114.30	AI1 unit selection	(Visible when 114.01 Module 1 type = FIO-11 or FAIO-01) Selects the unit for readings and settings related to analog input AI1. Note: This setting must match the corresponding hardware setting on the I/O extension module (see the manual of the I/O extension module). The hardware setting is shown by parameter 114.29 AI1 HW switch pos.	mA
	V	Volts.	2
	mA	Milliamperes.	10
114.31	RO status	(Visible when 114.01 Module 1 type = FIO-01 or FDIO-01) Status of relay outputs on the I/O extension module. Example: 00000001b = RO1 is energized, RO2 is de-energized.	-
	0000h...FFFFh	Status of relay outputs.	1 = 1
114.31	AI1 filter gain	(Visible when 114.01 Module 1 type = FIO-11 or FAIO-01) Selects a hardware filtering time for AI1. See also parameter 114.32 AI1 filter time.	No filtering
	No filtering	No filtering.	0
	125 us	125 microseconds.	1
	250 us	250 microseconds.	2
	500 us	500 microseconds.	3
	1 ms	1 millisecond.	4
	2 ms	2 milliseconds.	5
	4 ms	4 milliseconds.	6
	7.9375 ms	7.9375 milliseconds.	7
114.32	AI1 filter time	(Visible when 114.01 Module 1 type = FIO-11 or FAIO-01) Defines the filter time constant for analog input AI1.  $O = I \times (1 - e^{-t/T})$ <p>I = filter input (step) O = filter output t = time T = filter time constant</p> Note: The signal is also filtered due to the signal interface hardware. See parameter 114.31 AI1 filter gain.	0.040 s
	0.000 ... 30.000 s	Filter time constant.	1000 = 1 s

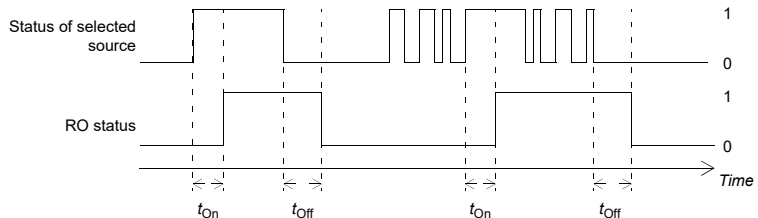
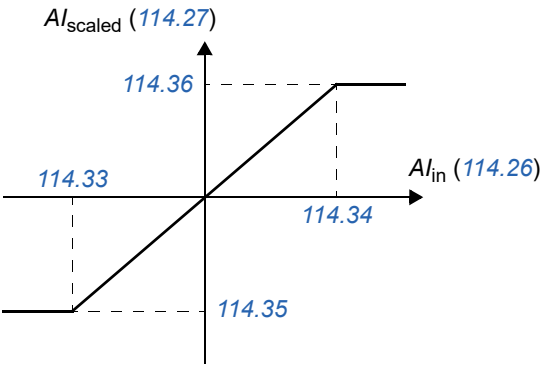
No.	Name/Value	Description	Def/FbEq16
114.33	<i>AI1 min</i>	(Visible when 114.01 Module 1 type = FIO-11 or FAIO-01) Defines the minimum value for analog input AI1.	0.000 mA or V
	-22.000 ... 22.000 mA or V	Minimum value of AI1.	1000 = 1 mA or V
114.34	<i>RO1 source</i>	(Visible when 114.01 Module 1 type = FIO-01 or FDIO-01) Selects a signal to be connected to relay output RO1. For the available selections, see parameter 114.11 DIO1 output source.	Not energized
114.34	<i>AI1 max</i>	(Visible when 114.01 Module 1 type = FIO-11 or FAIO-01) Defines the maximum value for analog input AI1.	10.000 mA or V
	-22.000 ... 22.000 mA or V	Maximum value of AI1.	1000 = 1 mA or V
114.35	<i>RO1 ON delay</i>	(Visible when 114.01 Module 1 type = FIO-01 or FDIO-01) Defines the activation delay for relay output RO1.	0.0 s
		 <p>$t_{On} = 114.35$ RO1 ON delay $t_{Off} = 114.36$ RO1 OFF delay</p>	
	0.0 ... 3000.0 s	Activation delay for RO1.	10 = 1 s
114.35	<i>AI1 scaled at AI1 min</i>	(Visible when 114.01 Module 1 type = FIO-11 or FAIO-01) Defines the real value that corresponds to the minimum analog input AI1 value defined by parameter 114.33 AI1 min.	0.000
			
	-32768.000 ... 32767.000	Real value corresponding to minimum AI1 value.	1 = 1
114.36	<i>RO1 OFF delay</i>	(Visible when 114.01 Module 1 type = FIO-01 or FDIO-01) Defines the deactivation delay for relay output RO1. See parameter 114.35 RO1 ON delay.	0.0 s
	0.0 ... 3000.0 s	Deactivation delay for RO1.	10 = 1 s
114.36	<i>AI1 scaled at AI1 max</i>	(Visible when 114.01 Module 1 type = FIO-11 or FAIO-01) Defines the real value that corresponds to the maximum analog input AI1 value defined by parameter 114.34 AI1 max. See the drawing at parameter 114.35 AI1 scaled at AI1 min.	1500.0
	-32768.000 ... 32767.000	Real value corresponding to maximum AI1 value.	1 = 1

102 Parameters

No.	Name/Value	Description	Def/FbEq16
114.37	RO2 source	(Visible when 114.01 Module 1 type = FIO-01 or FDIO-01) Selects a signal to be connected to relay output RO2. For the available selections, see parameter 114.11 DIO1 output source.	Not energized
114.38	RO2 ON delay	(Visible when 114.01 Module 1 type = FIO-01 or FDIO-01) Defines the activation delay for relay output RO2.	0.0 s
<p>The diagram shows two waveforms: 'Status of selected source' and 'RO status'. The source signal transitions between 0 and 1. The RO status transitions between 0 and 1 with a delay. The activation delay is labeled t_{On} and the deactivation delay is labeled t_{Off}.</p> <p>t_{On} = 114.38 RO2 ON delay t_{Off} = 114.39 RO2 OFF delay</p>			
	0.0 ... 3000.0 s	Activation delay for RO2.	10 = 1 s
114.39	RO2 OFF delay	(Visible when 114.01 Module 1 type = FIO-01 or FDIO-01) Defines the deactivation delay for relay output RO1. See parameter 114.35 RO1 ON delay.	0.0 s
	0.0 ... 3000.0 s	Deactivation delay for RO2.	10 = 1 s
114.41	AI2 actual value	(Visible when 114.01 Module 1 type = FIO-11 or FAIO-01) Displays the value of analog input AI2 in mA or V (depending on whether the input is set to current or voltage). This parameter is read-only.	-
	-22.000 ... 22.000 mA or V	Value of analog input AI2.	1000 = 1 mA or V
114.42	AI2 scaled value	(Visible when 114.01 Module 1 type = FIO-11 or FAIO-01) Displays the value of analog input AI2 after scaling. See parameter 114.50 AI2 scaled at AI2 min. This parameter is read-only.	-
	-32768.000 ... 32767.000	Scaled value of analog input AI2.	1 = 1
114.43	AI2 force data	(Visible when 114.01 Module 1 type = FIO-11 or FAIO-01) Forced value that can be used instead of the true reading of the input. See parameter 114.22 AI force sel.	0.000 mA
	-22.000 ... 22.000 mA or V	Forced value of analog input AI2.	1000 = 1 mA or V
114.44	AI2 HW switch pos	(Visible when 114.01 Module 1 type = FIO-11 or FAIO-01) Shows the position of the hardware current/voltage selector on the I/O extension module. Note: The setting of the current/voltage selector must match the unit selection made in parameter 114.45 AI2 unit selection.	-
	V	Volts.	2
	mA	Milliamperes.	10
114.45	AI2 unit selection	(Visible when 114.01 Module 1 type = FIO-11 or FAIO-01) Selects the unit for readings and settings related to analog input AI2. Note: This setting must match the corresponding hardware setting on the I/O extension module (see the manual of the I/O extension module). The hardware setting is shown by parameter 114.44 AI2 HW switch pos.	mA
	V	Volts.	2
	mA	Milliamperes.	10

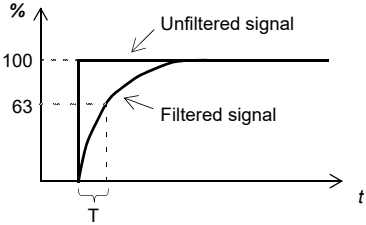
No.	Name/Value	Description	Def/FbEq16
114.46	<i>A12 filter gain</i>	(Visible when 114.01 Module 1 type = FIO-11 or FAIO-01) Selects a hardware filtering time for AI2. See also parameter 114.47 <i>A12 filter time</i> .	No filtering
	No filtering	No filtering.	0
	125 us	125 microseconds.	1
	250 us	250 microseconds.	2
	500 us	500 microseconds.	3
	1 ms	1 millisecond.	4
	2 ms	2 milliseconds.	5
	4 ms	4 milliseconds.	6
	7.9375 ms	7.9375 milliseconds.	7
114.47	<i>A12 filter time</i>	(Visible when 114.01 Module 1 type = FIO-11 or FAIO-01) Defines the filter time constant for analog input AI2.  $O = I \times (1 - e^{-t/T})$ I = filter input (step) O = filter output t = time T = filter time constant Note: The signal is also filtered due to the signal interface hardware. See parameter 114.46 <i>A12 filter gain</i> .	0.100 s
	0.000 ... 30.000 s	Filter time constant.	1000 = 1 s
114.48	<i>A12 min</i>	(Visible when 114.01 Module 1 type = FIO-11 or FAIO-01) Defines the minimum value for analog input AI2.	0.000 mA or V
	-22.000 ... 22.000 mA or V	Minimum value of AI2.	1000 = 1 mA or V
114.49	<i>A12 max</i>	(Visible when 114.01 Module 1 type = FIO-11 or FAIO-01) Defines the maximum value for analog input AI2.	10.000 mA or V
	-22.000 ... 22.000 mA or V	Maximum value of AI2.	1000 = 1 mA or V

104 Parameters

No.	Name/Value	Description	Def/FbEq16
114.50	<i>AI2 scaled at AI2 min</i>	<p>(Visible when 114.01 Module 1 type = FIO-11 or FAIO-01)</p> <p>Defines the real value that corresponds to the minimum analog input AI2 value defined by parameter 114.48 AI2 min.</p>	0.000
	-32768.000 ... 32767.000	Real value corresponding to minimum AI2 value.	1 = 1
114.51	<i>AI2 scaled at AI2 max</i>	<p>(Visible when 114.01 Module 1 type = FIO-11 or FAIO-01)</p> <p>Defines the real value that corresponds to the maximum analog input AI2 value defined by parameter 114.49 AI2 max. See the drawing at parameter 114.50 AI2 scaled at AI2 min.</p>	1500.0
	-32768.000 ... 32767.000	Real value corresponding to maximum AI2 value.	1 = 1
114.56	<i>AI3 actual value</i>	<p>(Visible when 114.01 Module 1 type = FIO-11)</p> <p>Displays the value of analog input AI3 in mA or V (depending on whether the input is set to current or voltage). This parameter is read-only.</p>	-
	-22.000 ... 22.000 mA or V	Value of analog input AI3.	1000 = 1 mA or V
114.57	<i>AI3 scaled value</i>	<p>(Visible when 114.01 Module 1 type = FIO-11)</p> <p>Displays the value of analog input AI3 after scaling. See parameter 114.65 AI3 scaled at AI3 min. This parameter is read-only.</p>	-
	-32768.000 ... 32767.000	Scaled value of analog input AI3.	1 = 1
114.58	<i>AI3 force data</i>	<p>(Visible when 114.01 Module 1 type = FIO-11)</p> <p>Forced value that can be used instead of the true reading of the input. See parameter 114.22 AI force sel.</p>	0.000 mA
	-22.000 ... 22.000 mA or V	Forced value of analog input AI3.	1000 = 1 mA or V
114.59	<i>AI3 HW switch pos</i>	<p>(Visible when 114.01 Module 1 type = FIO-11)</p> <p>Shows the position of the hardware current/voltage selector on the I/O extension module. Note: The setting of the current/voltage selector must match the unit selection made in parameter 114.60 AI3 unit selection.</p>	-
	V	Volts.	2
	mA	Milliamperes.	10

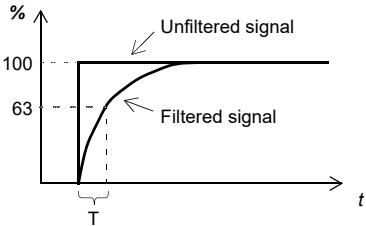
No.	Name/Value	Description	Def/FbEq16
114.60	<i>AI3 unit selection</i>	(Visible when 114.01 Module 1 type = FIO-11) Selects the unit for readings and settings related to analog input AI3. Note: This setting must match the corresponding hardware setting on the I/O extension module (see the manual of the I/O extension module). The hardware setting is shown by parameter 114.59 AI3 HW switch pos.	<i>mA</i>
	V	Volts.	2
	mA	Milliamperes.	10
114.61	<i>AI3 filter gain</i>	(Visible when 114.01 Module 1 type = FIO-11) Selects a hardware filtering time for AI3. See also parameter 114.62 AI3 filter time.	<i>No filtering</i>
	No filtering	No filtering.	0
	125 us	125 microseconds.	1
	250 us	250 microseconds.	2
	500 us	500 microseconds.	3
	1 ms	1 millisecond.	4
	2 ms	2 milliseconds.	5
	4 ms	4 milliseconds.	6
	7.9375 ms	7.9375 milliseconds.	7
114.62	<i>AI3 filter time</i>	(Visible when 114.01 Module 1 type = FIO-11) Defines the filter time constant for analog input AI3.  $O = I \times (1 - e^{-t/T})$ I = filter input (step) O = filter output t = time T = filter time constant Note: The signal is also filtered due to the signal interface hardware. See parameter 114.61 AI3 filter gain.	0.100 s
	0.000 ... 30.000 s	Filter time constant.	1000 = 1 s
114.63	<i>AI3 min</i>	(Visible when 114.01 Module 1 type = FIO-11) Defines the minimum value for analog input AI3.	0.000 mA or V
	-22.000 ... 22.000 mA or V	Minimum value of AI3.	1000 = 1 mA or V
114.64	<i>AI3 max</i>	(Visible when 114.01 Module 1 type = FIO-11) Defines the maximum value for analog input AI3.	10.000 mA or V
	-22.000 ... 22.000 mA or V	Maximum value of AI3.	1000 = 1 mA or V

No.	Name/Value	Description	Def/FbEq16						
114.65	<i>AI3 scaled at AI3 min</i>	<p>(Visible when 114.01 Module 1 type = FIO-11)</p> <p>Defines the real value that corresponds to the minimum analog input AI3 value defined by parameter 114.63 AI3 min.</p>	0.000						
	-32768.000 ... 32767.000	Real value corresponding to minimum AI3 value.	1 = 1						
114.66	<i>AI3 scaled at AI3 max</i>	<p>(Visible when 114.01 Module 1 type = FIO-11)</p> <p>Defines the real value that corresponds to the maximum analog input AI3 value defined by parameter 114.64 AI3 max. See the drawing at parameter 114.65 AI3 scaled at AI3 min.</p>	1500.0						
	-32768.000 ... 32767.000	Real value corresponding to maximum AI3 value.	1 = 1						
114.71	<i>AO force selection</i>	<p>(Visible when 114.01 Module 1 type = FIO-11 or FAIO-01)</p> <p>The value of the analog output can be overridden for eg. testing purposes. A forced value parameter (114.78 AO1 force data) is provided for the analog output, and its value is applied whenever the corresponding bit in this parameter is 1.</p>	00000000h						
<table border="1"> <thead> <tr> <th>Bit</th> <th>Value</th> </tr> </thead> <tbody> <tr> <td>0</td> <td>1 = Force AO1 to value of parameter 114.78 AO1 force data.</td> </tr> <tr> <td>1...31</td> <td>Reserved.</td> </tr> </tbody> </table>				Bit	Value	0	1 = Force AO1 to value of parameter 114.78 AO1 force data.	1...31	Reserved.
Bit	Value								
0	1 = Force AO1 to value of parameter 114.78 AO1 force data.								
1...31	Reserved.								
	00000000h ... FFFFFFFFh	Forced values selector for analog outputs.	1 = 1						
114.76	<i>AO1 actual value</i>	<p>(Visible when 114.01 Module 1 type = FIO-11 or FAIO-01)</p> <p>Displays the value of AO1 in mA. This parameter is read-only.</p>	-						
	0.000 ... 22.000 mA	Value of AO1.	1000 = 1 mA						
114.77	<i>AO1 source</i>	<p>(Visible when 114.01 Module 1 type = FIO-11 or FAIO-01)</p> <p>Selects a signal to be connected to analog output AO1. Alternatively, sets the output to excitation mode to feed a constant current to a temperature sensor.</p>	Zero						
	Zero	None.	0						
	DC voltage	101.01 DC voltage	1						
	Line current	101.02 Line current	2						
	Other	The value is taken from another parameter.	-						
114.78	<i>AO1 force data</i>	<p>(Visible when 114.01 Module 1 type = FIO-11 or FAIO-01)</p> <p>Forced value that can be used instead of the selected output signal. See parameter 114.71 AO force selection.</p>	0.000 mA						
	0.000 ... 22.000 mA	Forced value of analog output AI1.	1000 = 1 mA						

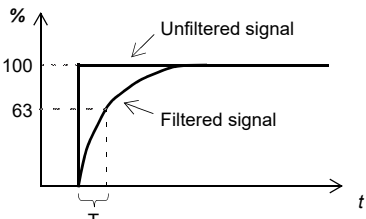
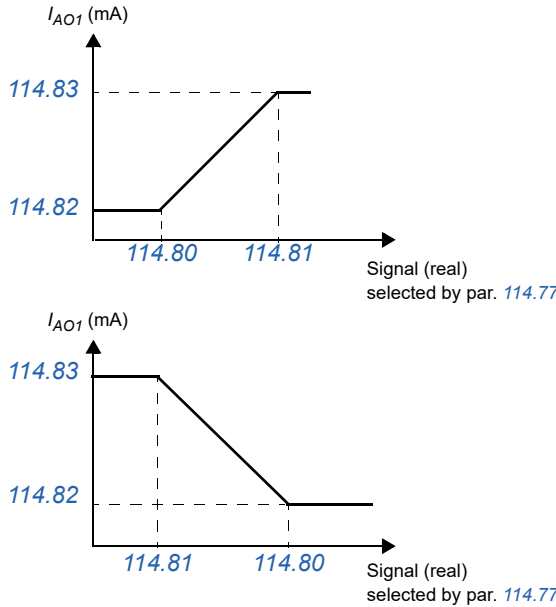
No.	Name/Value	Description	Def/FbEq16
114.79	AO1 filter time	<p>(Visible when 114.01 Module 1 type = FIO-11 or FAIO-01)</p> <p>Defines the filtering time constant for analog output AO1.</p>  <p>$O = I \times (1 - e^{-t/T})$</p> <p>I = filter input (step) O = filter output t = time T = filter time constant</p>	0.100 s
	0.000 ... 30.000 s	Filter time constant.	1000 = 1 s
114.80	AO1 source min	<p>(Visible when 114.01 Module 1 type = FIO-11 or FAIO-01)</p> <p>Defines the real value of the signal (selected by parameter 114.77 AO1 source) that corresponds to the minimum AO1 output value (defined by parameter 114.82 AO1 out at AO1 src min).</p> 	0.0
	-32768.0 ... 32767.0	Real signal value corresponding to minimum AO1 output value.	1 = 1
114.81	AO1 source max	<p>(Visible when 114.01 Module 1 type = FIO-11 or FAIO-01)</p> <p>Defines the real value of the signal (selected by parameter 114.77 AO1 source) that corresponds to the maximum AO1 output value (defined by parameter 114.83 AO1 out at AO1 src max). See parameter 114.80 AO1 source min.</p>	1500.0
	-32768.0 ... 32767.0	Real signal value corresponding to maximum AO1 output value.	1 = 1
114.82	AO1 out at AO1 src min	<p>(Visible when 114.01 Module 1 type = FIO-11 or FAIO-01)</p> <p>Defines the minimum output value for analog output AO1. See also drawing at parameter 114.80 AO1 source min.</p>	0.000 mA
	0.000 ... 22.000 mA	Minimum AO1 output value.	1000 = 1 mA

108 Parameters

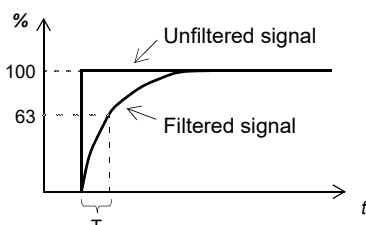
No.	Name/Value	Description	Def/FbEq16
114.83	AO1 out at AO1 src max	(Visible when 114.01 Module 1 type = FIO-11 or FAIO-01) Defines the maximum output value for analog output AO1. See also drawing at parameter 114.80 AO1 source min.	20.000 mA
	0.000 ... 22.000 mA	Maximum AO1 output value.	1000 = 1 mA
114.86	AO2 actual value	(Visible when 114.01 Module 1 type = FAIO-01) Displays the value of AO2 in mA. This parameter is read-only.	-
	0.000 ... 22.000 mA	Value of AO2.	1000 = 1 mA
114.87	AO2 source	(Visible when 114.01 Module 1 type = FAIO-01) Selects a signal to be connected to analog output AO2. Alternatively, sets the output to excitation mode to feed a constant current to a temperature sensor. For the selections, see parameter 114.77 AO1 source.	Zero
114.88	AO2 force data	(Visible when 114.01 Module 1 type = FAIO-01) Forced value that can be used instead of the selected output signal. See parameter 114.71 AO force selection.	0.000 mA
	0.000 ... 22.000 mA	Forced value of analog output AO2.	1000 = 1 mA
114.89	AO2 filter time	(Visible when 114.01 Module 1 type = FAIO-01) Defines the filtering time constant for analog output AO2.  $O = I \times (1 - e^{-t/T})$ I = filter input (step) O = filter output t = time T = filter time constant	0.100 s
	0.000 ... 30.000 s	Filter time constant.	1000 = 1 s

No.	Name/Value	Description	Def/FbEq16
114.90	<i>AO2 source min</i>	<p>(Visible when 114.01 Module 1 type = FAIO-01)</p> <p>Defines the real value of the signal (selected by parameter 114.87 AO2 source) that corresponds to the minimum AO2 output value (defined by parameter 114.92 AO2 out at AO2 src min).</p> <p style="text-align: center;">Signal (real) selected by par. 114.87</p>	0.0
	-32768.0 ... 32767.0	Real signal value corresponding to minimum AO2 output value.	1 = 1
114.91	<i>AO2 source max</i>	<p>(Visible when 114.01 Module 1 type = FAIO-01)</p> <p>Defines the real value of the signal (selected by parameter 114.87 AO2 source) that corresponds to the maximum AO2 output value (defined by parameter 114.93 AO2 out at AO2 src max). See parameter 114.90 AO2 source min.</p>	100.0
	-32768.0 ... 32767.0	Real signal value corresponding to maximum AO2 output value.	1 = 1
114.92	<i>AO2 out at AO2 src min</i>	<p>(Visible when 114.01 Module 1 type = FAIO-01)</p> <p>Defines the minimum output value for analog output AO2. See also drawing at parameter 114.90 AO2 source min.</p>	0.000 mA
	0.000 ... 22.000 mA	Minimum AO2 output value.	1000 = 1 mA
114.93	<i>AO2 out at AO2 src max</i>	<p>(Visible when 114.01 Module 1 type = FAIO-01)</p> <p>Defines the maximum output value for analog output AO2. See also drawing at parameter 114.90 AO2 source min.</p>	10.000 mA
	0.000 ... 22.000 mA	Maximum AO2 output value.	1000 = 1 mA
115 Extension I/O module 2		<p>Configuration of I/O extension module 2. See also section <i>Programmable I/O extensions</i> (page 28).</p> <p>Note: The contents of the parameter group vary according to the selected I/O extension module type.</p>	
115.01	<i>Module 2 type</i>	See parameter 114.01 Module 1 type.	None
115.02	<i>Module 2 location</i>	See parameter 114.02 Module 1 location.	1 (Slot 1)
115.03	<i>Module 2 status</i>	See parameter 114.03 Module 1 status.	No option
115.05	<i>DI status</i>	<p>(Visible when 115.01 Module 2 type = FDIO-01)</p> <p>See parameter 114.05 DI status.</p>	-

110 Parameters

No.	Name/Value	Description	Def/FbEq16
115.05	<i>DIO status</i>	(Visible when 115.01 Module 2 type = FIO-01 or FIO-11) See parameter 114.05 DIO status.	-
115.06	<i>DI delayed status</i>	(Visible when 115.01 Module 2 type = FDIO-01) See parameter 114.06 DI delayed status.	-
115.06	<i>DIO delayed status</i>	(Visible when 115.01 Module 2 type = FIO-01 or FIO-11) See parameter 114.06 DIO delayed status.	-
115.08	<i>DI filter time</i>	(Visible when 115.01 Module 2 type = FDIO-01) See parameter 114.08 DI filter time.	10.0 ms
115.08	<i>DIO filter time</i>	(Visible when 115.01 Module 2 type = FIO-01 or FIO-11) See parameter 114.08 DIO filter time.	10.0 ms
115.09	<i>DIO1 configuration</i>	(Visible when 115.01 Module 2 type = FIO-01 or FIO-11) See parameter 114.09 DIO1 configuration.	Input
115.11	<i>DIO1 output source</i>	(Visible when 115.01 Module 2 type = FIO-01 or FIO-11) See parameter 114.11 DIO1 output source.	Not energized
115.12	<i>DI1 ON delay</i>	(Visible when 115.01 Module 2 type = FDIO-01) See parameter 114.12 DI1 ON delay.	0.00 s
115.12	<i>DIO1 ON delay</i>	(Visible when 115.01 Module 2 type = FIO-01 or FIO-11) See parameter 114.12 DIO1 ON delay.	0.0 s
115.13	<i>DI1 OFF delay</i>	(Visible when 115.01 Module 2 type = FDIO-01) See parameter 114.13 DI1 OFF delay.	0.00 s
115.13	<i>DIO1 OFF delay</i>	(Visible when 115.01 Module 2 type = FIO-01 or FIO-11) See parameter 114.13 DIO1 OFF delay.	0.0 s
115.14	<i>DIO2 configuration</i>	(Visible when 115.01 Module 2 type = FIO-01 or FIO-11) See parameter 114.14 DIO2 configuration.	Input
115.16	<i>DIO2 output source</i>	(Visible when 115.01 Module 2 type = FIO-01 or FIO-11) See parameter 114.16 DIO2 output source.	Not energized
115.17	<i>DI2 ON delay</i>	(Visible when 115.01 Module 2 type = FDIO-01) See parameter 114.17 DI2 ON delay.	0.00 s
115.17	<i>DIO2 ON delay</i>	(Visible when 115.01 Module 2 type = FIO-01 or FIO-11) See parameter 114.17 DIO2 ON delay.	0.0 s
115.18	<i>DI2 OFF delay</i>	(Visible when 115.01 Module 2 type = FDIO-01) See parameter 114.18 DI2 OFF delay.	0.00 s
115.18	<i>DIO2 OFF delay</i>	(Visible when 115.01 Module 2 type = FIO-01 or FIO-11) See parameter 114.18 DIO2 OFF delay.	0.0 s
115.19	<i>DIO3 configuration</i>	(Visible when 115.01 Module 2 type = FIO-01) See parameter 114.19 DIO3 configuration.	Input
115.19	<i>AI supervision function</i>	(Visible when 115.01 Module 2 type = FIO-11 or FAIO-01) See parameter 114.19 AI supervision function.	No action
115.20	<i>AI supervision selection</i>	(Visible when 115.01 Module 2 type = FIO-11 or FAIO-01) See parameter 114.20 AI supervision selection.	0000h
115.21	<i>DIO3 output source</i>	(Visible when 115.01 Module 2 type = FIO-01) See parameter 114.21 DIO3 output source.	Not energized
115.22	<i>DI3 ON delay</i>	(Visible when 115.01 Module 2 type = FDIO-01) See parameter 114.22 DI3 ON delay.	0.00 s
115.22	<i>DIO3 ON delay</i>	(Visible when 115.01 Module 2 type = FIO-01) See parameter 114.22 DIO3 ON delay.	0.0 s
115.22	<i>AI force sel</i>	(Visible when 115.01 Module 2 type = FIO-11 or FAIO-01) See parameter 114.22 AI force sel.	00000000h
115.23	<i>DI3 OFF delay</i>	(Visible when 115.01 Module 2 type = FDIO-01) See parameter 114.23 DI3 OFF delay.	0.00 s
115.23	<i>DIO3 OFF delay</i>	(Visible when 115.01 Module 2 type = FIO-01) See parameter 114.23 DIO3 OFF delay.	0.0 s

No.	Name/Value	Description	Def/FbEq16
115.24	DIO4 configuration	(Visible when 115.01 Module 2 type = FIO-01) See parameter 114.24 DIO4 configuration.	Input
115.26	DIO4 output source	(Visible when 115.01 Module 2 type = FIO-01) See parameter 114.26 DIO4 output source.	Not energized
115.26	AI1 actual value	(Visible when 115.01 Module 2 type = FIO-11 or FAIO-01) See parameter 114.26 AI1 actual value.	-
115.27	DIO4 ON delay	(Visible when 115.01 Module 2 type = FIO-01) See parameter 114.27 DIO4 ON delay.	0.0 s
115.27	AI1 scaled value	(Visible when 115.01 Module 2 type = FIO-11 or FAIO-01) See parameter 114.27 AI1 scaled value.	-
115.28	DIO4 OFF delay	(Visible when 115.01 Module 2 type = FIO-01) See parameter 114.28 DIO4 OFF delay.	0.0 s
115.28	AI1 force data	(Visible when 115.01 Module 2 type = FIO-11 or FAIO-01) See parameter 114.28 AI1 force data.	-
115.29	AI1 HW switch pos	(Visible when 115.01 Module 2 type = FIO-11 or FAIO-01) See parameter 114.29 AI1 HW switch pos.	-
115.30	AI1 unit selection	(Visible when 115.01 Module 2 type = FIO-11 or FAIO-01) See parameter 114.30 AI1 unit selection.	mA
115.31	RO status	(Visible when 115.01 Module 2 type = FIO-01 or FDIO-01) See parameter 114.31 RO status.	-
115.31	AI1 filter gain	(Visible when 115.01 Module 2 type = FIO-11 or FAIO-01) See parameter 114.31 AI1 filter gain.	No filtering
115.32	AI1 filter time	(Visible when 115.01 Module 2 type = FIO-11 or FAIO-01) See parameter 114.32 AI1 filter time.	0.040 s
115.33	AI1 min	(Visible when 115.01 Module 2 type = FIO-11 or FAIO-01) See parameter 114.33 AI1 min.	0.000 mA or V
115.34	RO1 source	(Visible when 115.01 Module 2 type = FIO-01 or FDIO-01) See parameter 114.34 RO1 source.	Not energized
115.34	AI1 max	(Visible when 115.01 Module 2 type = FIO-11 or FAIO-01) See parameter 114.34 AI1 max.	10.000 mA or V
115.35	RO1 ON delay	(Visible when 115.01 Module 2 type = FIO-01 or FDIO-01) See parameter 114.35 RO1 ON delay.	0.0 s
115.35	AI1 scaled at AI1 min	(Visible when 115.01 Module 2 type = FIO-11 or FAIO-01) See parameter 114.35 AI1 scaled at AI1 min.	0.000
115.36	RO1 OFF delay	(Visible when 115.01 Module 2 type = FIO-01 or FDIO-01) See parameter 114.36 RO1 OFF delay.	0.0 s
115.36	AI1 scaled at AI1 max	(Visible when 115.01 Module 2 type = FIO-11 or FAIO-01) See parameter 114.36 AI1 scaled at AI1 max.	1500.0
115.37	RO2 source	(Visible when 115.01 Module 2 type = FIO-01 or FDIO-01) See parameter 114.37 RO2 source.	Not energized
115.38	RO2 ON delay	(Visible when 115.01 Module 2 type = FIO-01 or FDIO-01) See parameter 114.38 RO2 ON delay.	0.0 s
115.39	RO2 OFF delay	(Visible when 115.01 Module 2 type = FIO-01 or FDIO-01) See parameter 114.39 RO2 OFF delay.	0.0 s
115.41	AI2 actual value	(Visible when 115.01 Module 2 type = FIO-11 or FAIO-01) See parameter 114.41 AI2 actual value.	-
115.42	AI2 scaled value	(Visible when 115.01 Module 2 type = FIO-11 or FAIO-01) See parameter 114.42 AI2 scaled value.	-
115.43	AI2 force data	(Visible when 115.01 Module 2 type = FIO-11 or FAIO-01) See parameter 114.43 AI2 force data.	0.000 mA
115.44	AI2 HW switch pos	(Visible when 115.01 Module 2 type = FIO-11 or FAIO-01) See parameter 114.44 AI2 HW switch pos.	-

112 Parameters

No.	Name/Value	Description	Def/FbEq16
115.45	<i>AI2 unit selection</i>	(Visible when 115.01 Module 2 type = FIO-11 or FAIO-01) See parameter 114.45 AI2 unit selection.	<i>mA</i>
115.46	<i>AI2 filter gain</i>	(Visible when 115.01 Module 2 type = FIO-11 or FAIO-01) See parameter 114.46 AI2 filter gain.	<i>No filtering</i>
115.47	<i>AI2 filter time</i>	(Visible when 115.01 Module 2 type = FIO-11 or FAIO-01) See parameter 114.47 AI2 filter time.	0.100 s
115.48	<i>AI2 min</i>	(Visible when 115.01 Module 2 type = FIO-11 or FAIO-01) See parameter 114.48 AI2 min.	0.000 mA or V
115.49	<i>AI2 max</i>	(Visible when 115.01 Module 2 type = FIO-11 or FAIO-01) See parameter 114.49 AI2 max.	10.000 mA or V
115.50	<i>AI2 scaled at AI2 min</i>	(Visible when 115.01 Module 2 type = FIO-11 or FAIO-01) See parameter 114.50 AI2 scaled at AI2 min.	0.000
115.51	<i>AI2 scaled at AI2 max</i>	(Visible when 115.01 Module 2 type = FIO-11 or FAIO-01) See parameter 114.51 AI2 scaled at AI2 max.	1500.0
115.56	<i>AI3 actual value</i>	(Visible when 115.01 Module 2 type = FIO-11) See parameter 114.56 AI3 actual value.	-
115.57	<i>AI3 scaled value</i>	(Visible when 115.01 Module 2 type = FIO-11) See parameter 114.57 AI3 scaled value.	-
115.58	<i>AI3 force data</i>	(Visible when 115.01 Module 2 type = FIO-11) See parameter 114.58 AI3 force data.	0.000 mA
115.59	<i>AI3 HW switch pos</i>	(Visible when 115.01 Module 2 type = FIO-11) See parameter 114.59 AI3 HW switch pos.	-
115.60	<i>AI3 unit selection</i>	(Visible when 115.01 Module 2 type = FIO-11) See parameter 114.60 AI3 unit selection.	<i>mA</i>
115.61	<i>AI3 filter gain</i>	(Visible when 115.01 Module 2 type = FIO-11) See parameter 114.61 AI3 filter gain.	<i>No filtering</i>
115.62	<i>AI3 filter time</i>	(Visible when 115.01 Module 2 type = FIO-11) See parameter 114.62 AI3 filter time.	0.100 s
115.63	<i>AI3 min</i>	(Visible when 115.01 Module 2 type = FIO-11) See parameter 114.63 AI3 min.	0.000 mA or V
115.64	<i>AI3 max</i>	(Visible when 115.01 Module 2 type = FIO-11) See parameter 114.64 AI3 max.	10.000 mA or V
115.65	<i>AI3 scaled at AI3 min</i>	(Visible when 115.01 Module 2 type = FIO-11) See parameter 114.65 AI3 scaled at AI3 min.	0.000
115.66	<i>AI3 scaled at AI3 max</i>	(Visible when 115.01 Module 2 type = FIO-11) See parameter 114.66 AI3 scaled at AI3 max.	1500.0
115.71	<i>AO force selection</i>	(Visible when 115.01 Module 2 type = FIO-11 or FAIO-01) See parameter 114.71 AO force selection.	00000000h
115.76	<i>AO1 actual value</i>	(Visible when 115.01 Module 2 type = FIO-11 or FAIO-01) See parameter 114.76 AO1 actual value.	-
115.77	<i>AO1 source</i>	(Visible when 115.01 Module 2 type = FIO-11 or FAIO-01) See parameter 114.77 AO1 source.	<i>Zero</i>
115.78	<i>AO1 force data</i>	(Visible when 115.01 Module 2 type = FIO-11 or FAIO-01) See parameter 114.78 AO1 force data.	0.000 mA
115.79	<i>AO1 filter time</i>	(Visible when 115.01 Module 2 type = FIO-11 or FAIO-01) See parameter 114.79 AO1 filter time.	0.100 s
115.80	<i>AO1 source min</i>	(Visible when 115.01 Module 2 type = FIO-11 or FAIO-01) See parameter 114.80 AO1 source min.	0.0
115.81	<i>AO1 source max</i>	(Visible when 115.01 Module 2 type = FIO-11 or FAIO-01) See parameter 114.81 AO1 source max.	1500.0
115.82	<i>AO1 out at AO1 src min</i>	(Visible when 115.01 Module 2 type = FIO-11 or FAIO-01) See parameter 114.82 AO1 out at AO1 src min.	0.000 mA

No.	Name/Value	Description	Def/FbEq16
115.83	AO1 out at AO1 src max	(Visible when 115.01 Module 2 type = FIO-11 or FAIO-01) See parameter 114.83 AO1 out at AO1 src max.	20.000 mA
115.86	AO2 actual value	(Visible when 115.01 Module 2 type = FAIO-01) See parameter 114.86 AO2 actual value.	-
115.87	AO2 source	(Visible when 115.01 Module 2 type = FAIO-01) See parameter 114.87 AO2 source.	Zero
115.88	AO2 force data	(Visible when 115.01 Module 2 type = FAIO-01) See parameter 114.88 AO2 force data.	0.000 mA
115.89	AO2 filter time	(Visible when 115.01 Module 2 type = FAIO-01) See parameter 114.89 AO2 filter time.	0.100 s
115.90	AO2 source min	(Visible when 115.01 Module 2 type = FAIO-01) See parameter 114.90 AO2 source min.	0.0
115.91	AO2 source max	(Visible when 115.01 Module 2 type = FAIO-01) See parameter 114.91 AO2 source max.	100.0
115.92	AO2 out at AO2 src min	(Visible when 115.01 Module 2 type = FAIO-01) See parameter 114.92 AO2 out at AO2 src min.	0.000 mA
115.93	AO2 out at AO2 src max	(Visible when 115.01 Module 2 type = FAIO-01) See parameter 114.93 AO2 out at AO2 src max.	10.000 mA
116 Extension I/O module 3		Configuration of I/O extension module 3. See also section <i>Programmable I/O extensions</i> (page 28). Note: The contents of the parameter group vary according to the selected I/O extension module type.	
116.01	Module 3 type	See parameter 114.01 Module 1 type.	None
116.02	Module 3 location	See parameter 114.02 Module 1 location.	1 (Slot 1)
116.03	Module 3 status	See parameter 114.03 Module 1 status.	No option
116.05	DI status	(Visible when 116.01 Module 3 type = FDIO-01) See parameter 114.05 DI status.	-
116.05	DIO status	(Visible when 116.01 Module 3 type = FIO-01 or FIO-11) See parameter 114.05 DIO status.	-
116.06	DI delayed status	(Visible when 116.01 Module 3 type = FDIO-01) See parameter 114.06 DI delayed status.	-
116.06	DIO delayed status	(Visible when 116.01 Module 3 type = FIO-01 or FIO-11) See parameter 114.06 DIO delayed status.	-
116.08	DI filter time	(Visible when 116.01 Module 3 type = FDIO-01) See parameter 114.08 DI filter time.	10.0 ms
116.08	DIO filter time	(Visible when 116.01 Module 3 type = FIO-01 or FIO-11) See parameter 114.08 DIO filter time.	10.0 ms
116.09	DIO1 configuration	(Visible when 116.01 Module 3 type = FIO-01 or FIO-11) See parameter 114.09 DIO1 configuration.	Input
116.11	DIO1 output source	(Visible when 116.01 Module 3 type = FIO-01 or FIO-11) See parameter 114.11 DIO1 output source.	Not energized
116.12	DI1 ON delay	(Visible when 116.01 Module 3 type = FDIO-01) See parameter 114.12 DI1 ON delay.	0.00 s
116.12	DIO1 ON delay	(Visible when 116.01 Module 3 type = FIO-01 or FIO-11) See parameter 114.12 DIO1 ON delay.	0.0 s
116.13	DI1 OFF delay	(Visible when 116.01 Module 3 type = FDIO-01) See parameter 114.13 DI1 OFF delay.	0.00 s
116.13	DIO1 OFF delay	(Visible when 116.01 Module 3 type = FIO-01 or FIO-11) See parameter 114.13 DIO1 OFF delay.	0.0 s
116.14	DIO2 configuration	(Visible when 116.01 Module 3 type = FIO-01 or FIO-11) See parameter 114.14 DIO2 configuration.	Input

114 Parameters

No.	Name/Value	Description	Def/FbEq16
116.16	<i>DIO2 output source</i>	(Visible when 116.01 Module 3 type = FIO-01 or FIO-11) See parameter 114.16 DIO2 output source.	Not energized
116.17	<i>DI2 ON delay</i>	(Visible when 116.01 Module 3 type = FDIO-01) See parameter 114.17 DI2 ON delay.	0.00 s
116.17	<i>DIO2 ON delay</i>	(Visible when 116.01 Module 3 type = FIO-01 or FIO-11) See parameter 114.17 DIO2 ON delay.	0.0 s
116.18	<i>DI2 OFF delay</i>	(Visible when 116.01 Module 3 type = FDIO-01) See parameter 114.18 DI2 OFF delay.	0.00 s
116.18	<i>DIO2 OFF delay</i>	(Visible when 116.01 Module 3 type = FIO-01 or FIO-11) See parameter 114.18 DIO2 OFF delay.	0.0 s
116.19	<i>DIO3 configuration</i>	(Visible when 116.01 Module 3 type = FIO-01) See parameter 114.19 DIO3 configuration.	Input
116.19	<i>AI supervision function</i>	(Visible when 116.01 Module 3 type = FIO-11 or FAIO-01) See parameter 114.19 AI supervision function.	No action
116.20	<i>AI supervision selection</i>	(Visible when 116.01 Module 3 type = FIO-11 or FAIO-01) See parameter 114.20 AI supervision selection.	0000h
116.21	<i>DIO3 output source</i>	(Visible when 116.01 Module 3 type = FIO-01) See parameter 114.21 DIO3 output source.	Not energized
116.22	<i>DI3 ON delay</i>	(Visible when 116.01 Module 3 type = FDIO-01) See parameter 114.22 DI3 ON delay.	0.00 s
116.22	<i>DIO3 ON delay</i>	(Visible when 116.01 Module 3 type = FIO-01) See parameter 114.22 DIO3 ON delay.	0.0 s
116.22	<i>AI force sel</i>	(Visible when 116.01 Module 3 type = FIO-11 or FAIO-01) See parameter 114.22 AI force sel.	00000000h
116.23	<i>DI3 OFF delay</i>	(Visible when 116.01 Module 3 type = FDIO-01) See parameter 114.23 DI3 OFF delay.	0.00 s
116.23	<i>DIO3 OFF delay</i>	(Visible when 116.01 Module 3 type = FIO-01) See parameter 114.23 DIO3 OFF delay.	0.0 s
116.24	<i>DIO4 configuration</i>	(Visible when 116.01 Module 3 type = FIO-01) See parameter 114.24 DIO4 configuration.	Input
116.26	<i>DIO4 output source</i>	(Visible when 116.01 Module 3 type = FIO-01) See parameter 114.26 DIO4 output source.	Not energized
116.26	<i>AI1 actual value</i>	(Visible when 116.01 Module 3 type = FIO-11 or FAIO-01) See parameter 114.26 AI1 actual value.	-
116.27	<i>DIO4 ON delay</i>	(Visible when 116.01 Module 3 type = FIO-01) See parameter 114.27 DIO4 ON delay.	0.0 s
116.27	<i>AI1 scaled value</i>	(Visible when 116.01 Module 3 type = FIO-11 or FAIO-01) See parameter 114.27 AI1 scaled value.	-
116.28	<i>DIO4 OFF delay</i>	(Visible when 116.01 Module 3 type = FIO-01) See parameter 114.28 DIO4 OFF delay.	0.0 s
116.28	<i>AI1 force data</i>	(Visible when 116.01 Module 3 type = FIO-11 or FAIO-01) See parameter 114.28 AI1 force data.	-
116.29	<i>AI1 HW switch pos</i>	(Visible when 116.01 Module 3 type = FIO-11 or FAIO-01) See parameter 114.29 AI1 HW switch pos.	-
116.30	<i>AI1 unit selection</i>	(Visible when 116.01 Module 3 type = FIO-11 or FAIO-01) See parameter 114.30 AI1 unit selection.	mA
116.31	<i>RO status</i>	(Visible when 116.01 Module 3 type = FIO-01 or FDIO-01) See parameter 114.31 RO status.	-
116.31	<i>AI1 filter gain</i>	(Visible when 116.01 Module 3 type = FIO-11 or FAIO-01) See parameter 114.31 AI1 filter gain.	No filtering
116.32	<i>AI1 filter time</i>	(Visible when 116.01 Module 3 type = FIO-11 or FAIO-01) See parameter 114.32 AI1 filter time.	0.040 s

No.	Name/Value	Description	Def/FbEq16
116.33	AI1 min	(Visible when 116.01 Module 3 type = FIO-11 or FAIO-01) See parameter 114.33 AI1 min.	0.000 mA or V
116.34	RO1 source	(Visible when 116.01 Module 3 type = FIO-01 or FDIO-01) See parameter 114.34 RO1 source.	Not energized
116.34	AI1 max	(Visible when 116.01 Module 3 type = FIO-11 or FAIO-01) See parameter 114.34 AI1 max.	10.000 mA or V
116.35	RO1 ON delay	(Visible when 116.01 Module 3 type = FIO-01 or FDIO-01) See parameter 114.35 RO1 ON delay.	0.0 s
116.35	AI1 scaled at AI1 min	(Visible when 116.01 Module 3 type = FIO-11 or FAIO-01) See parameter 114.35 AI1 scaled at AI1 min.	0.000
116.36	RO1 OFF delay	(Visible when 116.01 Module 3 type = FIO-01 or FDIO-01) See parameter 114.36 RO1 OFF delay.	0.0 s
116.36	AI1 scaled at AI1 max	(Visible when 116.01 Module 3 type = FIO-11 or FAIO-01) See parameter 114.36 AI1 scaled at AI1 max.	1500.0
116.37	RO2 source	(Visible when 116.01 Module 3 type = FIO-01 or FDIO-01) See parameter 114.37 RO2 source.	Not energized
116.38	RO2 ON delay	(Visible when 116.01 Module 3 type = FIO-01 or FDIO-01) See parameter 114.38 RO2 ON delay.	0.0 s
116.39	RO2 OFF delay	(Visible when 116.01 Module 3 type = FIO-01 or FDIO-01) See parameter 114.39 RO2 OFF delay.	0.0 s
116.41	AI2 actual value	(Visible when 116.01 Module 3 type = FIO-11 or FAIO-01) See parameter 114.41 AI2 actual value.	-
116.42	AI2 scaled value	(Visible when 116.01 Module 3 type = FIO-11 or FAIO-01) See parameter 114.42 AI2 scaled value.	-
116.43	AI2 force data	(Visible when 116.01 Module 3 type = FIO-11 or FAIO-01) See parameter 114.43 AI2 force data.	0.000 mA
116.44	AI2 HW switch pos	(Visible when 116.01 Module 3 type = FIO-11 or FAIO-01) See parameter 114.44 AI2 HW switch pos.	-
116.45	AI2 unit selection	(Visible when 116.01 Module 3 type = FIO-11 or FAIO-01) See parameter 114.45 AI2 unit selection.	mA
116.46	AI2 filter gain	(Visible when 116.01 Module 3 type = FIO-11 or FAIO-01) See parameter 114.46 AI2 filter gain.	No filtering
116.47	AI2 filter time	(Visible when 116.01 Module 3 type = FIO-11 or FAIO-01) See parameter 114.47 AI2 filter time.	0.100 s
116.48	AI2 min	(Visible when 116.01 Module 3 type = FIO-11 or FAIO-01) See parameter 114.48 AI2 min.	0.000 mA or V
116.49	AI2 max	(Visible when 116.01 Module 3 type = FIO-11 or FAIO-01) See parameter 114.49 AI2 max.	10.000 mA or V
116.50	AI2 scaled at AI2 min	(Visible when 116.01 Module 3 type = FIO-11 or FAIO-01) See parameter 114.50 AI2 scaled at AI2 min.	0.000
116.51	AI2 scaled at AI2 max	(Visible when 116.01 Module 3 type = FIO-11 or FAIO-01) See parameter 114.51 AI2 scaled at AI2 max.	1500.0
116.56	AI3 actual value	(Visible when 116.01 Module 3 type = FIO-11) See parameter 114.56 AI3 actual value.	-
116.57	AI3 scaled value	(Visible when 116.01 Module 3 type = FIO-11) See parameter 114.57 AI3 scaled value.	-
116.58	AI3 force data	(Visible when 116.01 Module 3 type = FIO-11) See parameter 114.58 AI3 force data.	0.000 mA
116.59	AI3 HW switch pos	(Visible when 116.01 Module 3 type = FIO-11) See parameter 114.59 AI3 HW switch pos.	-
116.60	AI3 unit selection	(Visible when 116.01 Module 3 type = FIO-11) See parameter 114.60 AI3 unit selection.	mA

116 Parameters

No.	Name/Value	Description	Def/FbEq16
116.61	<i>AI3 filter gain</i>	(Visible when 116.01 Module 3 type = FIO-11) See parameter 114.61 AI3 filter gain.	No filtering
116.62	<i>AI3 filter time</i>	(Visible when 116.01 Module 3 type = FIO-11) See parameter 114.62 AI3 filter time.	0.100 s
116.63	<i>AI3 min</i>	(Visible when 116.01 Module 3 type = FIO-11) See parameter 114.63 AI3 min.	0.000 mA or V
116.64	<i>AI3 max</i>	(Visible when 116.01 Module 3 type = FIO-11) See parameter 114.64 AI3 max.	10.000 mA or V
116.65	<i>AI3 scaled at AI3 min</i>	(Visible when 116.01 Module 3 type = FIO-11) See parameter 114.65 AI3 scaled at AI3 min.	0.000
116.66	<i>AI3 scaled at AI3 max</i>	(Visible when 116.01 Module 3 type = FIO-11) See parameter 114.66 AI3 scaled at AI3 max.	1500.0
116.71	<i>AO force selection</i>	(Visible when 116.01 Module 3 type = FIO-11 or FAIO-01) See parameter 114.71 AO force selection.	00000000h
116.76	<i>AO1 actual value</i>	(Visible when 116.01 Module 3 type = FIO-11 or FAIO-01) See parameter 114.76 AO1 actual value.	-
116.77	<i>AO1 source</i>	(Visible when 116.01 Module 3 type = FIO-11 or FAIO-01) See parameter 114.77 AO1 source.	Zero
116.78	<i>AO1 force data</i>	(Visible when 116.01 Module 3 type = FIO-11 or FAIO-01) See parameter 114.78 AO1 force data.	0.000 mA
116.79	<i>AO1 filter time</i>	(Visible when 116.01 Module 3 type = FIO-11 or FAIO-01) See parameter 114.79 AO1 filter time.	0.100 s
116.80	<i>AO1 source min</i>	(Visible when 116.01 Module 3 type = FIO-11 or FAIO-01) See parameter 114.80 AO1 source min.	0.0
116.81	<i>AO1 source max</i>	(Visible when 116.01 Module 3 type = FIO-11 or FAIO-01) See parameter 114.81 AO1 source max.	1500.0
116.82	<i>AO1 out at AO1 src min</i>	(Visible when 116.01 Module 3 type = FIO-11 or FAIO-01) See parameter 114.82 AO1 out at AO1 src min.	0.000 mA
116.83	<i>AO1 out at AO1 src max</i>	(Visible when 116.01 Module 3 type = FIO-11 or FAIO-01) See parameter 114.83 AO1 out at AO1 src max.	20.000 mA
116.86	<i>AO2 actual value</i>	(Visible when 116.01 Module 3 type = FAIO-01) See parameter 114.86 AO2 actual value.	-
116.87	<i>AO2 source</i>	(Visible when 116.01 Module 3 type = FAIO-01) See parameter 114.87 AO2 source.	Zero
116.88	<i>AO2 force data</i>	(Visible when 116.01 Module 3 type = FAIO-01) See parameter 114.88 AO2 force data.	0.000 mA
116.89	<i>AO2 filter time</i>	(Visible when 116.01 Module 3 type = FAIO-01) See parameter 114.89 AO2 filter time.	0.100 s
116.90	<i>AO2 source min</i>	(Visible when 116.01 Module 3 type = FAIO-01) See parameter 114.90 AO2 source min.	0.0
116.91	<i>AO2 source max</i>	(Visible when 116.01 Module 3 type = FAIO-01) See parameter 114.91 AO2 source max.	100.0
116.92	<i>AO2 out at AO2 src min</i>	(Visible when 116.01 Module 3 type = FAIO-01) See parameter 114.92 AO2 out at AO2 src min.	0.000 mA
116.93	<i>AO2 out at AO2 src max</i>	(Visible when 116.01 Module 3 type = FAIO-01) See parameter 114.93 AO2 out at AO2 src max.	10.000 mA
119 Operation mode		Selection of external control location sources and operating modes.	
119.01	<i>Actual operation mode</i>	Displays the operation mode currently in use. This parameter is read-only.	<i>DC control</i>
	DC control	DC control.	1
	Power control	Active power control.	2

No.	Name/Value	Description	Def/FbEq16
	AC control	AC voltage control.	3
119.11	<i>Ext1/Ext2 selection</i>	Selects the source for external control location EXT1/EXT2 selection. 0 = EXT1 1 = EXT2	<i>EXT1</i>
	EXT1	EXT1.	0
	EXT2	EXT2.	1
	MCW bit11: Ext ctrl loc	<i>106.01 Main control word</i> (page 74), bit 11.	2
	DI1	Digital input DI1 (<i>110.02 DI delayed status</i> , bit 0).	3
	DI2	Digital input DI2 (<i>110.02 DI delayed status</i> , bit 1).	4
	DI3	Digital input DI3 (<i>110.02 DI delayed status</i> , bit 2).	5
	DI4	Digital input DI4 (<i>110.02 DI delayed status</i> , bit 3).	6
	DI5	Digital input DI5 (<i>110.02 DI delayed status</i> , bit 4).	7
	DI6	Digital input DI6 (<i>110.02 DI delayed status</i> , bit 5).	8
	DIO1	Digital input/output DIO1 (<i>111.02 DIO delayed status</i> , bit 0).	11
	<i>Other</i>	Source selection (see <i>Terms and abbreviations</i> on page 61).	-
119.12	<i>Ext1 ctrl mode1</i>	Selects the operating mode 1 for external control location EXT1.	<i>DC control</i>
	DC control	DC control.	1
	Power control	Active power control.	2
	AC control	AC voltage control.	3
119.14	<i>Ext2 ctrl mode1</i>	Selects the operating mode 1 for external control location EXT2. For the selections, see parameter <i>119.12 Ext1 ctrl mode1</i> .	<i>DC control</i>
119.16	<i>Local ctrl mode</i>	Selects the control mode for local control. Note: This parameter cannot be changed while the IGBT supply unit is running.	<i>DC control</i>
	DC control	DC control.	1
	Power control	Active power control.	2
	AC control	AC voltage control.	3
119.17	<i>Local control disable</i>	Enables/disables local control. If you disable the local control, you can not use the Loc/Rem key of the panel for changing to local control.  WARNING! Before disabling local control, ensure that the control panel is not needed for stopping the IGBT supply unit.	<i>No</i>
	No	Local control enabled.	0
	Yes	Local control disabled.	1
<i>120 Start/stop</i>		Start/stop and run/start enable signal source selection; charging settings. For information on control locations, see section <i>Local control vs. external control</i> (page 20).	
120.01	<i>Ext1 commands</i>	Selects the source of start and stop commands for external control location 1 (EXT1). Note: This parameter can not be changed while the IGBT supply unit is running. See also parameters <i>120.02...120.04</i> .	<i>In1 Start</i>
	Not sel	No start or stop command sources selected.	0

No.	Name/Value	Description	Def/FbEq16									
	In1 Start	The source of the start and stop commands is selected by parameter 120.03 Ext1 in1 source . The state transitions of the source bits are interpreted as follows: <table border="1" data-bbox="518 369 1040 497"> <thead> <tr> <th>State of source 1 (120.03)</th> <th>Command</th> </tr> </thead> <tbody> <tr> <td>0 -> 1 (120.02 = Edge)</td> <td>Start</td> </tr> <tr> <td>1 (120.02 = Level)</td> <td>Stop</td> </tr> <tr> <td>0</td> <td>Stop</td> </tr> </tbody> </table>	State of source 1 (120.03)	Command	0 -> 1 (120.02 = Edge)	Start	1 (120.02 = Level)	Stop	0	Stop	1	
State of source 1 (120.03)	Command											
0 -> 1 (120.02 = Edge)	Start											
1 (120.02 = Level)	Stop											
0	Stop											
	In1P Start; In2 Stop	The sources of the start and stop commands are selected by parameters 120.03 Ext1 in1 source and 120.04 Ext1 in2 source . The state transitions of the source bits are interpreted as follows: <table border="1" data-bbox="501 663 1123 786"> <thead> <tr> <th>State of source 1 (120.03)</th> <th>State of source 2 (120.04)</th> <th>Command</th> </tr> </thead> <tbody> <tr> <td>0 -> 1</td> <td>1</td> <td>Start</td> </tr> <tr> <td>Any</td> <td>0</td> <td>Stop</td> </tr> </tbody> </table> <p>Notes:</p> <ul style="list-style-type: none"> Parameter 120.02 Ext1 start trigger type has no effect with this setting. When source 2 is 0, the Start and Stop keys on the control panel are disabled. 	State of source 1 (120.03)	State of source 2 (120.04)	Command	0 -> 1	1	Start	Any	0	Stop	4
State of source 1 (120.03)	State of source 2 (120.04)	Command										
0 -> 1	1	Start										
Any	0	Stop										
	Fieldbus A	The start and stop commands are taken from fieldbus adapter A.	12									
	D2D link	The start and stop commands are taken from another drive through the D2D (Drive-to-drive) link.	15									
	DDCS controller	The start and stop commands are taken from an external (DDCS) controller.	16									
	Application Program	The start and stop commands are taken from the application program control word.	21									
	ATF	Reserved.	22									
120.02	Ext1 start trigger type	Defines whether the start signal for external control location EXT1 is edge-triggered or level-triggered. Note: This parameter is not effective if a pulse-type start signal is selected. See the descriptions of the selections of parameter 120.01 Ext1 commands .	Edge									
	Edge	The start signal is edge-triggered.	0									
	Level	The start signal is level-triggered.	1									
120.03	Ext1 in1 source	Selects source 1 for parameter 120.01 Ext1 commands .	DI2									
	Off	0.	0									
	On	1.	1									
	DI1	Digital input DI1 (110.02 DI delayed status , bit 0).	2									
	DI2	Digital input DI2 (110.02 DI delayed status , bit 1).	3									
	DI3	Digital input DI3 (110.02 DI delayed status , bit 2).	4									
	DI4	Digital input DI4 (110.02 DI delayed status , bit 3).	5									
	DI5	Digital input DI5 (110.02 DI delayed status , bit 4).	6									
	DI6	Digital input DI6 (110.02 DI delayed status , bit 5).	7									
	DIO1	Digital input/output DIO1 (111.02 DIO delayed status , bit 0).	10									
	DIO2	Digital input/output DIO2 (111.02 DIO delayed status , bit 1).	11									
	Other	Source selection (see Terms and abbreviations on page 61).	-									
120.04	Ext1 in2 source	Selects source 2 for parameter 120.01 Ext1 commands . For the available selections, see parameter 120.03 Ext1 in1 source .	Off									

No.	Name/Value	Description	Def/FbEq16									
120.06	<i>Ext2 commands</i>	Selects the source of start and stop commands for external control location 2 (EXT2). See also parameters <i>120.07...120.09</i> .	<i>Not sel</i>									
	Not sel	No start or stop command sources selected.	0									
	In1 Start	The source of the start and stop commands is selected by parameter <i>120.08 Ext2 in1 source</i> . The state transitions of the source bits are interpreted as follows: <table border="1" data-bbox="694 504 1232 638"> <thead> <tr> <th>State of source 1 (<i>120.08</i>)</th> <th>Command</th> </tr> </thead> <tbody> <tr> <td>0 -> 1 (<i>120.07 = Edge</i>)</td> <td>Start</td> </tr> <tr> <td>1 (<i>120.07 = Level</i>)</td> <td>Stop</td> </tr> <tr> <td>0</td> <td>Stop</td> </tr> </tbody> </table>	State of source 1 (<i>120.08</i>)	Command	0 -> 1 (<i>120.07 = Edge</i>)	Start	1 (<i>120.07 = Level</i>)	Stop	0	Stop	1	
State of source 1 (<i>120.08</i>)	Command											
0 -> 1 (<i>120.07 = Edge</i>)	Start											
1 (<i>120.07 = Level</i>)	Stop											
0	Stop											
	In1P Start; In2 Stop	The sources of the start and stop commands are selected by parameters <i>120.08 Ext2 in1 source</i> and <i>120.09 Ext2 in2 source</i> . The state transitions of the source bits are interpreted as follows: <table border="1" data-bbox="667 801 1262 929"> <thead> <tr> <th>State of source 1 (<i>120.08</i>)</th> <th>State of source 2 (<i>120.09</i>)</th> <th>Command</th> </tr> </thead> <tbody> <tr> <td>0 -> 1</td> <td>1</td> <td>Start</td> </tr> <tr> <td>Any</td> <td>0</td> <td>Stop</td> </tr> </tbody> </table> Notes: <ul style="list-style-type: none">Parameter <i>120.07 Ext2 start trigger type</i> has no effect with this setting.When source 2 is 0, the Start and Stop keys on the control panel are disabled.	State of source 1 (<i>120.08</i>)	State of source 2 (<i>120.09</i>)	Command	0 -> 1	1	Start	Any	0	Stop	4
State of source 1 (<i>120.08</i>)	State of source 2 (<i>120.09</i>)	Command										
0 -> 1	1	Start										
Any	0	Stop										
	Keypad	The start and stop commands are taken from the control panel (or PC connected to the control panel).	11									
	Fieldbus A	The start and stop commands are taken from fieldbus adapter A.	12									
	D2D link	The start and stop commands are taken from another drive through the D2D (Drive-to-drive) link.	15									
	DDCS controller	The start and stop commands are taken from an external (DDCS) controller.	16									
	Application Program	The start and stop commands are taken from the application program control word.	21									
	ATF	Reserved.	22									
120.07	<i>Ext2 start trigger type</i>	Defines whether the start signal for external control location EXT2 is edge-triggered or level-triggered. Note: In case the settings of parameters <i>120.06</i> and <i>120.07</i> are in conflict, the setting of parameter <i>120.06</i> takes preference.	<i>Edge</i>									
	Edge	The start signal is edge-triggered.	0									
	Level	The start signal is level-triggered.	1									
120.08	<i>Ext2 in1 source</i>	Selects source 1 for parameter <i>120.06 Ext2 commands</i> . For the available selections, see parameter <i>120.03 Ext1 in1 source</i> .	<i>Off</i>									
120.09	<i>Ext2 in2 source</i>	Selects source 2 for parameter <i>120.06 Ext2 commands</i> . For the available selections, see parameter <i>120.03 Ext1 in1 source</i> .	<i>Off</i>									

120 Parameters

No.	Name/Value	Description	Def/FbEq16
120.12	<i>Run enable 1 source</i>	Selects the source of the external run enable signal. If the run enable signal is switched off, the IGBT supply unit will not start, or stops if running. 1 = Run enable. Note: This parameter cannot be changed while the IGBT supply unit is running.	<i>DI2</i>
	Off	0 (off).	0
	On	1 (on).	1
	DI1	Digital input DI1 (<i>110.02 DI delayed status</i> , bit 0).	2
	DI2	Digital input DI2 (<i>110.02 DI delayed status</i> , bit 1).	3
	DI3	Digital input DI3 (<i>110.02 DI delayed status</i> , bit 2).	4
	DI4	Digital input DI4 (<i>110.02 DI delayed status</i> , bit 3).	5
	DI5	Digital input DI5 (<i>110.02 DI delayed status</i> , bit 4).	6
	DI6	Digital input DI6 (<i>110.02 DI delayed status</i> , bit 5).	7
	DIO1	Digital input/output DIO1 (<i>111.02 DIO delayed status</i> , bit 0).	10
	DIO2	Digital input/output DIO2 (<i>111.02 DIO delayed status</i> , bit 1).	11
	<i>Other</i>	Source selection (see <i>Terms and abbreviations</i> on page 61).	-
120.19	<i>Enable start command</i>	Selects the source for the start enable signal. 1 = Start enable. With the signal switched off, the IGBT supply unit will not start. (Switching the signal off while the IGBT supply unit is running will not stop the IGBT supply unit.)	<i>On</i>
	Off	0 (off).	0
	On	1 (on).	1
	DI1	Digital input DI1 (<i>110.02 DI delayed status</i> , bit 0).	2
	DI2	Digital input DI2 (<i>110.02 DI delayed status</i> , bit 1).	3
	DI3	Digital input DI3 (<i>110.02 DI delayed status</i> , bit 2).	4
	DI4	Digital input DI4 (<i>110.02 DI delayed status</i> , bit 3).	5
	DI5	Digital input DI5 (<i>110.02 DI delayed status</i> , bit 4).	6
	DI6	Digital input DI6 (<i>110.02 DI delayed status</i> , bit 5).	7
	DIO1	Digital input/output DIO1 (<i>111.02 DIO delayed status</i> , bit 0).	10
	DIO2	Digital input/output DIO2 (<i>111.02 DIO delayed status</i> , bit 1).	11
	<i>Other</i>	Source selection (see <i>Terms and abbreviations</i> on page 61).	-
120.21	<i>Delay for MCB DI3 supervision</i>	Start and stop delay for supervision of main circuit breaker DI3 feedback in external charging. After the delay a fault is given in start and stop states if the command and the feedback do not match.	1.00 s
	0.00...8.00 s	Start and stop delay for supervision of main circuit breaker DI3 feedback.	100 = 1 s
120.22	<i>Max current for MCB closing</i>	Defines the maximum charging current for the charging function. When the charging current is below the value defined with this parameter, the main circuit breaker can be closed. (It will be closed only if also the remaining criteria is met.) The limit is given as a percent value of the nominal current of the supply unit. See also section <i>Charging</i> on page 43. 10% = 10% of the nominal current.	5%
	0...10%	Current value in percent.	1 = 1%
120.23	<i>Max DC charging time</i>	Defines the maximum charging time for the charging function. See section <i>Charging</i> on page 43.	6.00 s
	0.00...10.00 s	Maximum charging time	100 = 1 s

No.	Name/Value	Description	Def/FbEq16
120.25	<i>MCB closing level</i>	Defines the DC link voltage level for the charging function. When the measured DC link voltage exceeds the level, the main contactor/breaker can be closed. 100% equals to the value of parameter <i>101.62 Nominal DC voltage</i> . See section <i>Charging</i> on page 43.	80%
	20...100%	Intermediate circuit DC voltage level in percent of the nominal	1 = 1%
120.26	<i>Maximum dU/dt</i>	Defines the maximum DC link voltage change rate (dU/dt) for the charging function. When the change rate falls below this maximum change rate limit, the control program can close the main contactor/breaker. The change rate is measured in 10 ms sample interval. See section <i>Charging</i> on page 43.	50.0 V/s
	0.0...200.0 V/s	Maximum dU/dt change.	1 = 1 V/s
120.27	<i>Start delay</i>	Defines the start delay that delay the setting of the charged state after the main circuit breaker has closed. Without charged state the start command is blocked from the modulator.	0.50 s
	0.00...10.00 s	Start delay.	100 = 1 s
120.28	<i>MCB relay timing</i>	Defines the time for how long the MCB relay is closed/open in parallel with the charging relay. Positive time means that both relays are kept opened that time. Negative time means that both relays are kept closed at the same time. See picture in section <i>Charging</i> on page 43.	-0.20 s
	-6.00...6.00 s	Time between charging contactor opening and main circuit contactor closing.	100 = 1 s
120.29	<i>Diode mode</i>	Enables diode mode, when additional charging circuit is in use and the unit acts as a pure diode bridge. Diode mode blocks the start command for modulator after charging. In diode mode, the modulation is stopped and the main contactor is closed. Using diode mode reduces the number of main contactor operations.	Off
	Off	Diode mode is disabled.	0
	On	Diode mode is enabled.	1
	DI1	Digital input DI1 (<i>110.02 DI delayed status</i> , bit 0).	2
	DI2	Digital input DI2 (<i>110.02 DI delayed status</i> , bit 1).	3
	DI3	Digital input DI3 (<i>110.02 DI delayed status</i> , bit 2). Note: DI3 is reserved for main breaker/contactor fault in the control program. Do not select it for any other use.	4
	DI4	Digital input DI4 (<i>110.02 DI delayed status</i> , bit 3).	5
	DI5	Digital input DI5 (<i>110.02 DI delayed status</i> , bit 4).	6
	DI6	Digital input DI6 (<i>110.02 DI delayed status</i> , bit 5).	7
	DIO1	Digital input/output DIO1 (<i>111.02 DIO delayed status</i> , bit 0).	10
	DIO2	Digital input/output DIO2 (<i>111.02 DIO delayed status</i> , bit 1).	11
	MCW bit 14	<i>106.01 Main control word</i> , bit 14 (User bit 2).	12
	<i>Other</i>	Source selection (see <i>Terms and abbreviations</i> on page 61).	-
120.30	<i>External charge enable</i>	Enables the charging function. See section <i>Charging</i> on page 43.	Yes
	No	External charging disabled.	0
	Yes	External charging enabled.	1
120.50	<i>Charging overload event sel</i>	Selects the event type for charging overload event. See section <i>Charging</i> on page 43.	Fault
	Fault	The supply unit trips on fault <i>3E09 Charging count</i> .	0
	Warning	The supply unit generates a warning <i>AE85 Charging count</i> .	1
	No action	No action taken.	2

122 Parameters

No.	Name/Value	Description	Def/FbEq16
121 Start/stop mode		Emergency stop settings.	
121.04	Emergency stop mode	Selects the way the IGBT supply unit is stopped when an emergency stop command is received. The source of the emergency stop signal is selected with parameter 121.05 Emergency stop source .	<i>Stop and warning</i>
	Stop and warning	Stop IGBT supply unit and show emergency stop warning.	0
	Warning	Show emergency stop warning but do not stop IGBT supply unit.	1
	Fault	Stop IGBT supply unit and create an emergency stop fault.	2
121.05	Emergency stop source	Selects the source of the emergency stop signal. 0 = Emergency stop active 1 = Emergency stop command is off, normal operation Note: This parameter cannot be changed while the IGBT supply unit is running.	<i>Inactive (true)</i>
	Active (false)	0 (emergency stop command is on).	0
	Inactive (true)	1 (emergency stop command is off).	1
	DIIL	DIIL input (110.02 DI delayed status , bit 15).	2
	DI1	Digital input DI1 (110.02 DI delayed status , bit 0).	3
	DI2	Digital input DI2 (110.02 DI delayed status , bit 1).	4
	DI3	Digital input DI3 (110.02 DI delayed status , bit 2). Note: DI3 is reserved for main breaker/contactors fault in the control program. Do not select it for any other use.	5
	DI4	Digital input DI4 (110.02 DI delayed status , bit 3).	6
	DI5	Digital input DI5 (110.02 DI delayed status , bit 4).	7
	DI6	Digital input DI6 (110.02 DI delayed status , bit 5).	8
	DIO1	Digital input/output DIO1 (111.02 DIO delayed status , bit 0).	11
	DIO2	Digital input/output DIO2 (111.02 DIO delayed status , bit 1).	12
	<i>Other</i>	Source selection (see <i>Terms and abbreviations</i> on page 61).	-
122 Power reference		Settings of the active power reference chain. See the control chain diagrams in chapter <i>Control chain diagrams</i> (page 267).	
122.01	User Power ref	Defines the active power reference value for selection <i>User ref</i> of the parameter 122.02 Power ref sel . The unit is selected with parameter 122.06 Power ref type . See the diagram <i>Power reference chain</i> (page 269).	-
	-	The active power reference value.	1 = 1
122.02	Power ref sel	Selects the source for active power reference. See the diagram <i>Power reference chain</i> (page 269).	<i>User ref</i>
	User ref	122.01 User Power ref .	0
	AI1 scaled	112.12 AI1 scaled value (see page 89).	1
	AI2 scaled	112.22 AI2 scaled value (see page 90).	2
	Panel	Control panel.	3
	FB A ref1	Fieldbus adapter A reference 1.	4
	FB A ref2	Fieldbus adapter A reference 2.	5
	DDCS ctrl ref1	103.11 DDCS controller ref 1 (see page 67).	10
	DDCS ctrl ref2	103.12 DDCS controller ref 2 (see page 67).	11
	<i>Other</i>	The value is taken from another parameter. (See <i>Terms and abbreviations</i> on page 61.)	-

No.	Name/Value	Description	Def/FbEq16
122.03	<i>Power ref 1</i>	Shows the unscaled power reference value selected by <i>122.02 Power ref sel</i> . See the diagram <i>Power reference chain</i> (page 269).	-
	-	The unscaled power reference value.	1 = 1
122.04	<i>Power ref scale</i>	Defines the scaling factor for <i>122.03 Power ref 1</i> . See the diagram <i>Power reference chain</i> (page 269).	1.00
	-1000.00 ... 1000.00	The scaling factor.	1 = 1
122.05	<i>Power ref 2</i>	Shows the scaled power reference value: the value selected by parameter <i>122.02 Power ref sel</i> and multiplied by parameter <i>122.04 Power ref scale</i> . See the diagram <i>Power reference chain</i> (page 269).	1 = 1
122.06	<i>Power ref type</i>	Selects the active power reference type for the scaled reference value (parameter <i>122.05 Power ref 2</i>). See the diagram <i>Power reference chain</i> (page 269).	<i>Ipow ref [A]</i>
	Ipow ref [A]	Active current reference in Amperes.	0
	Ipow ref [%]	Active current reference in percent of the nominal current.	1
	Pow ref kW	Active power reference in kW.	2
	Pow ref %	Active power reference in percent of the nominal power.	3
122.07	<i>Ipow ref %</i>	Shows the active current reference in percent of the nominal current of the converter. See the diagram <i>Power reference chain</i> (page 269).	-
	-1000.0 ... 1000.0 %	Power reference in percent.	1 = 1%
122.08	<i>Ipow ref</i>	Shows the active current reference in Amperes. See the diagram <i>Power reference chain</i> (page 269).	-
	-	Active current reference.	1 = 1 A
122.09	<i>Power ref %</i>	Shows the power reference in percent of the nominal power. See the diagram <i>Power reference chain</i> (page 269).	-
	-1000.0 ... 1000.0 %	Power reference in percent.	1 = 1%
122.10	<i>Power ref</i>	Shows the power reference in kW. See the diagram <i>Power reference chain</i> (page 269).	-
	-	Power reference in kW.	1 = 1 kW
122.11	<i>Ipow ref max %</i>	Defines the maximum limit for the active current reference in percent. See the diagram <i>Power reference chain</i> (page 269).	100.0%
	0.0 ... 200.0%	Maximum active current reference in percent.	1 = 1%
122.12	<i>Ipow ref min %</i>	Defines the minimum limit for the active current reference in percent. See the diagram <i>Power reference chain</i> (page 269).	-100.0%
	-200.0...0.0%	Minimum active current reference in percent.	1 = 1%
122.13	<i>Ipow ref lim %</i>	Shows the limited active current reference. Limitation is based on <i>122.11 Ipow ref max %</i> and <i>122.12 Ipow ref min %</i> values. See the diagram <i>Power reference chain</i> (page 269).	-
	-200.0...200.0%	Output value of active power reference limitation.	1 = 1%
122.14	<i>Ipow ref ramp up</i>	Defines the active current ramp up time (time from zero to nominal) in ms. See the diagram <i>Power reference chain</i> (page 269).	1000 ms
	0...30000 ms	Active current ramp up time.	1 = 1 ms
122.15	<i>Ipow ref ramp down</i>	Defines the active current ramp down time (time from nominal to zero) in ms. See the diagram <i>Power reference chain</i> (page 269).	1000 ms
	0...30000 ms	Active current ramp down time.	1 = 1 ms
122.16	<i>Ipow ref out %</i>	Shows the output value of active current reference in percent for the controller. See the diagram <i>Power reference chain</i> (page 269).	-
	-200.0...200.0%	Output value of active current reference.	1 = 1%

124 Parameters

No.	Name/Value	Description	Def/FbEq16
122.17	<i>Ipwr ref out</i>	Shows the output value of active current reference in Amperes for the controller. If the reference can not be met, an actual value is used in the signal instead of ramped value. See the diagram <i>Power reference chain</i> (page 269).	-
-	-	Output value of active current reference.	1 = 1 A
122.18	<i>Power ref out %</i>	Shows the output value of active power reference in percent of the nominal power for the controller. See the diagram <i>Power reference chain</i> (page 269).	-
-	-200.0...200.0%	Output value of active power reference.	1 = 1%
122.19	<i>Power ref out</i>	Shows the output value of active power reference in kW for the controller. See the diagram <i>Power reference chain</i> (page 269).	-
-	-	Output value of active power reference.	1 = 1 kW
123 DC voltage reference		Settings of the DC voltage reference chain. See the control chain diagrams in chapter <i>Control chain diagrams</i> (page 267).	
123.01	<i>User DC voltage ref</i>	Defines the DC voltage reference value for selection <i>User ref</i> of the parameter <i>123.02 DC voltage ref selection</i> . See the diagram <i>DC voltage reference chain</i> (page 268).	-
-	0.00 ... 2000.00 V	DC voltage reference value.	0 = 1 V
123.02	<i>DC voltage ref selection</i>	Selects the control location for DC voltage reference. See the diagram <i>DC voltage reference chain</i> (page 268).	<i>User ref</i>
-	User ref	<i>123.01 User DC voltage ref.</i>	0
-	AI1 scaled	<i>112.12 AI1 scaled value</i> (see page 89).	1
-	AI2 scaled	<i>112.22 AI2 scaled value</i> (see page 90).	2
-	Panel	Control panel.	3
-	FB A ref1	Fieldbus adapter A reference 1.	4
-	FB A ref2	Fieldbus adapter A reference 2.	5
-	DDCS ctrl ref1	<i>103.11 DDCS controller ref 1</i> (see page 67).	10
-	DDCS ctrl ref2	<i>103.12 DDCS controller ref 2</i> (see page 67).	11
-	<i>Other</i>	The value is taken from another parameter. (See <i>Terms and abbreviations</i> on page 61.)	-
123.03	<i>DC voltage ref 1</i>	Shows the unscaled DC voltage reference value selected by <i>123.02 DC voltage ref selection</i> . See the diagram <i>DC voltage reference chain</i> (page 268).	-
-	0.00 ... 2000.00 V	Value of the DC voltage reference.	1 = 1 V
123.05	<i>DC voltage ref 2</i>	Shows the scaled DC reference value (<i>123.03 DC voltage ref 1</i> × <i>123.12 DC voltage ref scale</i>). See the diagram <i>DC voltage reference chain</i> (page 268).	-
-	0.00 ... 2000.00 V	Limitation of DC voltage reference.	1 = 1 V
123.06	<i>DC voltage ref max</i>	Maximum value of DC voltage reference in Volts. The maximum DC voltage reference is approximately 113% × sqrt(2) × <i>195.01 Supply voltage</i> (the high value). This parameter is an overvoltage controller activation limit in power control mode (maximum value <i>123.50 Overvoltage trip limit</i> - 50 V). See the diagram <i>DC voltage reference chain</i> (page 268), and section <i>Boost limits</i> on page 39.	1200 V
-	0 ... 2000 V	Maximum DC voltage reference.	1 = 1 V

No.	Name/Value	Description	Def/FbEq16
123.07	<i>DC voltage ref min</i>	Minimum value of DC voltage reference in Volts. This parameter is an undervoltage controller activation limit in power control mode. See the diagram <i>DC voltage reference chain</i> (page 268).	200 V
	0 ... 1100 V	Minimum DC voltage reference.	1 = 1 V
123.08	<i>DC voltage ref lim</i>	Output value of DC voltage reference limitation. Limitation is based on <i>123.06 DC voltage ref max</i> and <i>123.07 DC voltage ref min</i> values. If the reference and minimum limit cannot be met (diodes keep the DC voltage level higher), an actual value is used in the signal instead of minimum limit value. See the diagram <i>DC voltage reference chain</i> (page 268).	-
	0.00 ... 2000.00 V	Output value of DC voltage reference limitation.	1 = 1 V
123.09	<i>DC voltage ref ramp up</i>	DC voltage reference ramp up time (time from zero to nominal DC level) in ms. See the diagram <i>DC voltage reference chain</i> (page 268).	1000 ms
	0...10000 ms	DC voltage reference ramp up time.	1 = 1 ms
123.10	<i>DC voltage ref ramp down</i>	DC voltage reference ramp down time (time from nominal DC level to zero) in ms. See the diagram <i>DC voltage reference chain</i> (page 268).	1000 ms
	0...10000 ms	DC voltage reference ramp down time.	1 = 1 ms
123.11	<i>DC voltage ref out</i>	Output value of DC voltage reference ramping in Volts for the controller. If the reference can not be met, an actual value is used in the signal instead of ramped value. See the diagram <i>DC voltage reference chain</i> (page 268).	-
	0.00 ... 2000.00 V	Output value of DC voltage reference ramping.	1 = 1 V
123.12	<i>DC voltage ref scale</i>	DC voltage reference scaling factor. See the diagram <i>DC voltage reference chain</i> (page 268).	1.00
	-100.00...100.00	DC voltage reference scaling factor.	
123.13	<i>DC voltage ref add</i>	Defines the addition value to DC voltage reference (parameter <i>123.03 DC voltage ref 1</i>). See the diagram <i>DC voltage reference chain</i> (page 268).	0.000 V
	-30.000...30.000 V	Addition value.	1000 = 1 V
123.30	<i>Udc-ctrl droop</i>	Disables/enables the power share between two supply units that are fed from separate transformers but are connected to same DC bus. See section <i>Power share with droop control</i> on page 51.	<i>Disabled</i>
	Disabled	Disabled.	0
	Enabled	Enabled.	1
123.31	<i>Udc-ctrl drooping rate</i>	Defines the drooping rate in percent. See parameter <i>123.30 Udc-ctrl droop</i> , and section <i>Power share with droop control</i> on page 51.	5.0%
	0.0...100.0%	Drooping rate.	1 = 1%
123.32	<i>Master power</i>	Defines the power of the master unit in master/follower set-up.	0.00
	-2000.00...2000.00	Power of the master unit.	1 = 10
<i>124 Reactive power reference</i>		Settings of the reactive power reference chain. See the control chain diagrams in chapter <i>Control chain diagrams</i> (page 267).	
124.01	<i>User Qref</i>	Defines the reactive power reference value for the selection <i>User ref</i> of parameter <i>124.02 Q power ref selection</i> . The unit is selected with parameter <i>124.06 Q power ref type</i> . See the diagram <i>Reactive power reference chain</i> (page 270).	0
	-	Reactive power reference value	1 = 1

126 Parameters

No.	Name/Value	Description	Def/FbEq16
124.02	<i>Q power ref selection</i>	Selects the control location for reactive power reference. See the diagram <i>Reactive power reference chain</i> (page 270).	-
	User ref	Value of parameter <i>124.01 User Qref</i> .	0
	AI1 scaled	<i>112.12 AI1 scaled value</i> (see page 89).	1
	AI2 scaled	<i>112.22 AI2 scaled value</i> (see page 90).	2
	Panel	Control panel.	3
	FB A ref1	Fieldbus adapter A reference 1.	4
	FB A ref2	Fieldbus adapter A reference 2.	5
	ABB ctrl ref2	Reserved.	10
	D2D or M/F (IDL) ref1	Reserved.	11
	<i>Other</i>	The value is taken from another parameter. (See <i>Terms and abbreviations</i> on page 61.)	-
124.03	<i>Qref 1</i>	Shows the reference value selected by <i>124.01 User Qref</i> or <i>124.02 Q power ref selection</i> . See the diagram <i>Reactive power reference chain</i> (page 270).	1 = 1
124.04	<i>Q ref scale</i>	Defines the scaling factor for <i>124.03 Qref 1</i> . See the diagram <i>Reactive power reference chain</i> (page 270).	1.00
	-1000.00 ... 1000.00	The scaling factor.	1 = 1
124.05	<i>Qref 2</i>	Shows the reference value (<i>124.03 Qref 1</i>) after scaling. See the diagram <i>Reactive power reference chain</i> (page 270).	1
	-	The scaled value.	1 = 1
124.06	<i>Q power ref type</i>	Selects the reactive power reference type and unit. See the diagram <i>Reactive power reference chain</i> (page 270).	<i>Ireact ref [A]</i>
	Ireact ref [A]	Reactive current reference in Amperes.	0
	Ireact ref [%]	Reactive current reference in % of the nominal current.	1
	Qref [kVAr]	Reactive power reference in kVAr.	2
	Qref [%]	Reactive power reference in % of nominal power.	3
	Phi	Reactive power reference angle in degrees 1 = 1degree. The range is limited to -30° ... 30°.	4
	CosPhi	Reactive power reference in cosphi 0.9 = 0.9 capacitive. The range is limited to -0.86 ... -1 and 0.86 ... 1.	5
	Q(x) regulation curve	Q(x) regulation curve.	8
124.07	<i>Ireact ref %</i>	Shows the reactive current reference in percent. See the diagram <i>Reactive power reference chain</i> (page 270).	-
	-1000.0 ... 1000.0 %	Reactive current reference in percent.	1 = 1%
124.08	<i>Ireact ref</i>	Shows the reactive current reference in Amperes. See the diagram <i>Reactive power reference chain</i> (page 270).	-
	-	Reactive current reference.	1 = 1 A
124.09	<i>Q power ref %</i>	Shows the reactive power reference in percent of the nominal power. See the diagram <i>Reactive power reference chain</i> (page 270).	-
	-1000.0 ... 1000.0 %	Reactive power reference in percent.	1 = 1%
124.10	<i>Q power ref</i>	Shows the reactive power reference in kVAr. See the diagram <i>Reactive power reference chain</i> (page 270).	-
	-	Reactive power reference in kVAr.	1 = 1 kVAr
124.11	<i>Ireact ref max %</i>	Defines the maximum limit for the reactive power reference in percent. See the diagram <i>Reactive power reference chain</i> (page 270).	80.0%
	0.0 ... 200.0%	Maximum reactive current reference in percent.	1 = 1%

No.	Name/Value	Description	Def/FbEq16
124.12	<i>Ireact ref min %</i>	Defines the minimum limit for the reactive power reference in percent. See the diagram <i>Reactive power reference chain</i> (page 270).	-80.0%
	-200.0...0.0%	Minimum reactive current reference in percent.	1 = 1%
124.13	<i>Ireact ref lim %</i>	Output value of reactive power reference limitation. Limitation is based on <i>124.11 Ireact ref max %</i> and <i>124.12 Ireact ref min %</i> values. See the diagram <i>Reactive power reference chain</i> (page 270).	-
	-200.0...200.0%	Output value of reactive power reference limitation.	1 = 1%
124.14	<i>Ireact ref ramp up</i>	Defines the reactive current ramp up time (time from zero to nominal current) in ms. See the diagram <i>Reactive power reference chain</i> (page 270).	1000 ms
	0...30000 ms	Reactive current ramp up time.	1 = 1 ms
124.15	<i>Ireact ref ramp down</i>	Defines the reactive current ramp down time (time from nominal current to zero) in ms. See the diagram <i>Reactive power reference chain</i> (page 270).	1000 ms
	0...30000 ms	Reactive current ramp down time.	1 = 1 ms
124.16	<i>Ireact ref out %</i>	Shows the output value of reactive current reference in percent for the controller. See the diagram <i>Reactive power reference chain</i> (page 270).	-
	-200.0...200.0%	Output value of reactive current reference.	1 = 1%
124.17	<i>Ireact ref out</i>	Shows the output value of reactive current reference in Amperes for the controller. If the reference can not be met, an actual value is used in the signal instead of ramped value. See the diagram <i>Reactive power reference chain</i> (page 270).	-
	-	Output value of reactive current reference.	1 = 1 A
124.18	<i>Q power ref out %</i>	Shows the output value of reactive power reference in percent of the nominal power for the controller. See the diagram <i>Reactive power reference chain</i> (page 270).	-
	-200.0...200.0%	Output value of reactive power reference.	1 = 1%
124.19	<i>Q power ref out</i>	Shows the output value of reactive power reference in kVAr for the controller. See the diagram <i>Reactive power reference chain</i> (page 270).	-
	-	Output value of reactive power reference.	1 = 1 kVAr
124.20	<i>AC control gain</i>	Defines the relative gain of the AC voltage controller used in the reactive power reference chain. See the diagram <i>Reactive power reference chain</i> (page 270).	10.0
	0.0...100.0	Relative gain of the AC voltage controller.	10 = 1
124.21	<i>AC control integ time</i>	Defines the integration time of the AC voltage controller used in the reactive power reference chain. See the diagram <i>Reactive power reference chain</i> (page 270).	100 ms
	0...30000 ms	Integration time of the AC voltage controller.	1 = 1 ms
124.22	<i>AC diff max %</i>	Defines the maximum limit for AC voltage difference (reference - actual) used in the reactive power reference chain. See the diagram <i>Reactive power reference chain</i> (page 270).	10.0%
	0.0...30.0%	Maximum limit of AC control input.	1 = 1%
124.23	<i>AC diff min %</i>	Defines the minimum limit for the AC voltage difference (reference - actual) used in the reactive power reference chain. See the diagram <i>Reactive power reference chain</i> (page 270).	-10.0%
	-30.0...0.0%	Minimum limit of AC control input.	1 = 1%

128 Parameters

No.	Name/Value	Description	Def/FbEq16
124.27	<i>AC control base grid voltage</i>	Defines the AC control base value for grid voltage estimate. The value of this parameter is used to convert voltages to power unit. See the diagram <i>Reactive power reference chain</i> (page 270).	400 V
	100...1000 V	AC control base value for grid voltage estimate.	1 = 1 V
124.30	<i>Q(x) input signal</i>	Selects the input signal used in Q(x) regulation curve.	<i>Uac voltage</i>
	Uac voltage	Input: grid AC voltage; output: reactive power reference	0
	Power	Input: actual power; output: reactive power reference	1
	Power to cos phi	Input: actual power; output: cos phi	2
124.31	<i>Lock-in level</i>	Defines the lock-in level above which the Q(x) regulation curve is activated.	20.0%
	0.0...200.0%	Lock-in level.	1 = 1%
124.32	<i>Lock-out level</i>	Defines the lock-out level. In case below the lock-out level, the reactive power reference is reset to zero until the lock-in level is exceeded.	5.0%
	0.0...200.0%	Lock-out level.	1 = 1%
124.33	<i>Q(x) input level 1</i>	Defines the first input value for the Q(x) regulation curve. When the selected input signal reaches this value, the reactive power reference is set to the value defined by parameter <i>124.39 Q(x) output level 1</i> .	0.0%
	-	The first input value for the Q(x) regulation curve.	1 = 1%
124.34	<i>Q(x) input level 2</i>	Defines the 2nd input value for the Q(x) regulation curve.	0.0%
	-	The 2nd input value for the Q(x) regulation curve.	1 = 1%
124.35	<i>Q(x) input level 3</i>	Defines the 3rd input value for the Q(x) regulation curve.	0.0%
	-	The 3rd input value for the Q(x) regulation curve.	1 = 1%
124.36	<i>Q(x) input level 4</i>	Defines the 4th input value for the Q(x) regulation curve.	0.0%
	-	The 4th input value for the Q(x) regulation curve.	1 = 1%
124.37	<i>Q(x) input level 5</i>	Defines the 5th input value for the Q(x) regulation curve.	0.0%
	-	The 5th input value for the Q(x) regulation curve.	1 = 1%
124.38	<i>Q(x) input level 6</i>	Defines the 6th input value for the Q(x) regulation curve.	0.0%
	-	The 6th input value for the Q(x) regulation curve.	1 = 1%
124.39	<i>Q(x) output level 1</i>	Defines the first reference output value for the Q(x) regulation curve. When the selected input signal reaches the value defined by parameter <i>124.33 Q(x) input level 1</i> , the reactive power reference is set to the value defined by this parameter.	0.00
	-	The first reference output value for the Q(x) regulation curve.	1 = 1
124.40	<i>Q(x) output level 2</i>	Defines the 2nd reference output value for the Q(x) regulation curve.	0.00
	-	The 2nd reference output value for the Q(x) regulation curve.	1 = 1
124.41	<i>Q(x) output level 3</i>	Defines the 3rd reference output value for the Q(x) regulation curve.	0.00
	-	The 3rd reference output value for the Q(x) regulation curve.	1 = 1
124.42	<i>Q(x) output level 4</i>	Defines the 4th reference output value for the Q(x) regulation curve.	0.00
	-	The 4th reference output value for the Q(x) regulation curve.	1 = 1
124.43	<i>Q(x) output level 5</i>	Defines the 5th reference output value for the Q(x) regulation curve.	0.00
	-	The 5th reference output value for the Q(x) regulation curve.	1 = 1
124.44	<i>Q(x) output level 6</i>	Defines the 6th reference output value for the Q(x) regulation curve.	0.00
	-	The 6th reference output value for the Q(x) regulation curve.	1 = 1

No.	Name/Value	Description	Def/FbEq16																																										
130 Limits		Operation limits of the IGBT supply unit.																																											
130.01	<i>Limit word 1</i>	Shows limit word 1. This parameter is read-only.	-																																										
<table border="1"> <thead> <tr> <th>Bit</th> <th>Name</th> <th>Description</th> </tr> </thead> <tbody> <tr> <td>0</td> <td>P user ref max</td> <td>1 = Power reference is being limited by 122.11 Ipower ref max %.</td> </tr> <tr> <td>1</td> <td>P user ref min</td> <td>1 = Power reference is being limited by 122.12 Ipower ref min %.</td> </tr> <tr> <td>2</td> <td>P user max</td> <td>1 = 130.48 User power limit max % is limiting.</td> </tr> <tr> <td>3</td> <td>P user min</td> <td>1 = 130.49 User power limit min % is limiting.</td> </tr> <tr> <td>4</td> <td>P cooling overtemp</td> <td>1 = Power reference is limited if coolant temperature exceeds given limits.</td> </tr> <tr> <td>5</td> <td>P power unit overtemp</td> <td>1 = Power reference is limited if power unit temperature exceeds given limits.</td> </tr> <tr> <td>6</td> <td colspan="2">Reserved.</td> </tr> <tr> <td>7</td> <td>P/f limitation</td> <td>Not in use.</td> </tr> <tr> <td>8</td> <td>Grid fault limitation</td> <td>Not in use.</td> </tr> <tr> <td>9</td> <td>Connect limitation</td> <td>Not in use.</td> </tr> <tr> <td>10</td> <td>External limit</td> <td>Not in use.</td> </tr> <tr> <td>11</td> <td>Frt recovery limit</td> <td>Not in use.</td> </tr> <tr> <td>12...15</td> <td colspan="2">Reserved.</td> </tr> </tbody> </table>				Bit	Name	Description	0	P user ref max	1 = Power reference is being limited by 122.11 Ipower ref max % .	1	P user ref min	1 = Power reference is being limited by 122.12 Ipower ref min % .	2	P user max	1 = 130.48 User power limit max % is limiting.	3	P user min	1 = 130.49 User power limit min % is limiting.	4	P cooling overtemp	1 = Power reference is limited if coolant temperature exceeds given limits.	5	P power unit overtemp	1 = Power reference is limited if power unit temperature exceeds given limits.	6	Reserved.		7	P/f limitation	Not in use.	8	Grid fault limitation	Not in use.	9	Connect limitation	Not in use.	10	External limit	Not in use.	11	Frt recovery limit	Not in use.	12...15	Reserved.	
Bit	Name	Description																																											
0	P user ref max	1 = Power reference is being limited by 122.11 Ipower ref max % .																																											
1	P user ref min	1 = Power reference is being limited by 122.12 Ipower ref min % .																																											
2	P user max	1 = 130.48 User power limit max % is limiting.																																											
3	P user min	1 = 130.49 User power limit min % is limiting.																																											
4	P cooling overtemp	1 = Power reference is limited if coolant temperature exceeds given limits.																																											
5	P power unit overtemp	1 = Power reference is limited if power unit temperature exceeds given limits.																																											
6	Reserved.																																												
7	P/f limitation	Not in use.																																											
8	Grid fault limitation	Not in use.																																											
9	Connect limitation	Not in use.																																											
10	External limit	Not in use.																																											
11	Frt recovery limit	Not in use.																																											
12...15	Reserved.																																												
0000h...FFFFh		Limit word 1.	1 = 1																																										
130.02	<i>Limit word 2</i>	Shows limit word 2. This parameter is read-only.	-																																										
<table border="1"> <thead> <tr> <th>Bit</th> <th>Name</th> <th>Description</th> </tr> </thead> <tbody> <tr> <td>0</td> <td>Q user ref max</td> <td>1 = Reactive power reference is limited by 124.11 Ireact ref max %.</td> </tr> <tr> <td>1</td> <td>Q user ref min</td> <td>1 = Reactive power reference is limited by 124.12 Ireact ref min %.</td> </tr> <tr> <td>2</td> <td>Q cooling overtemp</td> <td>1 = Reactive power reference is limited if coolant temperature exceeds given limits. See parameter 130.16 Q cooling overtemp limit.</td> </tr> <tr> <td>3</td> <td>Q power unit overtemp</td> <td>1 = Reactive power reference is limited if power unit temperature exceeds given limits. See parameter 130.22 Q power unit overtemp limit.</td> </tr> <tr> <td>4</td> <td>AC overvoltage</td> <td>1 = AC overvoltage protection.</td> </tr> <tr> <td>5...6</td> <td colspan="2">Reserved.</td> </tr> <tr> <td>7</td> <td>AC diff max</td> <td>The input of AC control is limited to maximum value by parameter 124.22 AC diff max %.</td> </tr> <tr> <td>8</td> <td>AC diff min</td> <td>The input of AC control is limited to minimum value by parameter 124.23 AC diff min %.</td> </tr> <tr> <td>9...15</td> <td colspan="2">Reserved.</td> </tr> </tbody> </table>				Bit	Name	Description	0	Q user ref max	1 = Reactive power reference is limited by 124.11 Ireact ref max % .	1	Q user ref min	1 = Reactive power reference is limited by 124.12 Ireact ref min % .	2	Q cooling overtemp	1 = Reactive power reference is limited if coolant temperature exceeds given limits. See parameter 130.16 Q cooling overtemp limit .	3	Q power unit overtemp	1 = Reactive power reference is limited if power unit temperature exceeds given limits. See parameter 130.22 Q power unit overtemp limit .	4	AC overvoltage	1 = AC overvoltage protection.	5...6	Reserved.		7	AC diff max	The input of AC control is limited to maximum value by parameter 124.22 AC diff max % .	8	AC diff min	The input of AC control is limited to minimum value by parameter 124.23 AC diff min % .	9...15	Reserved.													
Bit	Name	Description																																											
0	Q user ref max	1 = Reactive power reference is limited by 124.11 Ireact ref max % .																																											
1	Q user ref min	1 = Reactive power reference is limited by 124.12 Ireact ref min % .																																											
2	Q cooling overtemp	1 = Reactive power reference is limited if coolant temperature exceeds given limits. See parameter 130.16 Q cooling overtemp limit .																																											
3	Q power unit overtemp	1 = Reactive power reference is limited if power unit temperature exceeds given limits. See parameter 130.22 Q power unit overtemp limit .																																											
4	AC overvoltage	1 = AC overvoltage protection.																																											
5...6	Reserved.																																												
7	AC diff max	The input of AC control is limited to maximum value by parameter 124.22 AC diff max % .																																											
8	AC diff min	The input of AC control is limited to minimum value by parameter 124.23 AC diff min % .																																											
9...15	Reserved.																																												
0000h...FFFFh		Limit word 2.	1 = 1																																										

130 Parameters

No.	Name/Value	Description	Def/FbEq16																																																
130.03	<i>Limit word 3</i>	Shows limit word 3. This parameter is read-only. See the diagram <i>Current limitation chain</i> (page 272).	-																																																
<table border="1"> <thead> <tr> <th>Bit</th> <th>Name</th> <th>Description</th> </tr> </thead> <tbody> <tr> <td>0</td> <td>undervoltage limit</td> <td>Undervoltage controller limits the power.</td> </tr> <tr> <td>1</td> <td>overvoltage limit</td> <td>Overvoltage controller limits the power.</td> </tr> <tr> <td>2</td> <td>Motoring power</td> <td>Power is limited by user limit or temperature limit. See parameters 130.47...130.49.</td> </tr> <tr> <td>3</td> <td>Generating power</td> <td>Power is limited by user limit or temperature limit. See parameters 130.47...130.49.</td> </tr> <tr> <td>4</td> <td>Active current limit</td> <td>Active current is limited. For details, see bits 6...9 and 14...15.</td> </tr> <tr> <td>5</td> <td>Reactive current limit</td> <td>Reactive current is limited. For details, see bits 12...13.</td> </tr> <tr> <td>6</td> <td>thermal limit</td> <td>Current is limited by main circuit thermal limit (this internal limit can not be changed by the user).</td> </tr> <tr> <td>7</td> <td>SOA limit</td> <td>Current is limited by the safe operation area (SOA) limit (this internal limit can not be changed by the user).</td> </tr> <tr> <td>8</td> <td>user current limit</td> <td>Current is limited by 130.46 Current limit %.</td> </tr> <tr> <td>9</td> <td>thermal igbt</td> <td>Current is limited by maximum thermal IGBT stress (this internal limit can not be changed by the user).</td> </tr> <tr> <td>10...11</td> <td colspan="2">Reserved.</td> </tr> <tr> <td>12</td> <td>Q act neg</td> <td>Total current limitation limits negative reactive current.</td> </tr> <tr> <td>13</td> <td>Q act pos</td> <td>Total current limitation limits positive reactive current.</td> </tr> <tr> <td>14</td> <td>P act neg</td> <td>Total current limitation limits negative active current.</td> </tr> <tr> <td>15</td> <td>P act pos</td> <td>Total current limitation limits positive active current.</td> </tr> </tbody> </table>				Bit	Name	Description	0	undervoltage limit	Undervoltage controller limits the power.	1	overvoltage limit	Overvoltage controller limits the power.	2	Motoring power	Power is limited by user limit or temperature limit. See parameters 130.47...130.49 .	3	Generating power	Power is limited by user limit or temperature limit. See parameters 130.47...130.49 .	4	Active current limit	Active current is limited. For details, see bits 6...9 and 14...15.	5	Reactive current limit	Reactive current is limited. For details, see bits 12...13.	6	thermal limit	Current is limited by main circuit thermal limit (this internal limit can not be changed by the user).	7	SOA limit	Current is limited by the safe operation area (SOA) limit (this internal limit can not be changed by the user).	8	user current limit	Current is limited by 130.46 Current limit % .	9	thermal igbt	Current is limited by maximum thermal IGBT stress (this internal limit can not be changed by the user).	10...11	Reserved.		12	Q act neg	Total current limitation limits negative reactive current.	13	Q act pos	Total current limitation limits positive reactive current.	14	P act neg	Total current limitation limits negative active current.	15	P act pos	Total current limitation limits positive active current.
Bit	Name	Description																																																	
0	undervoltage limit	Undervoltage controller limits the power.																																																	
1	overvoltage limit	Overvoltage controller limits the power.																																																	
2	Motoring power	Power is limited by user limit or temperature limit. See parameters 130.47...130.49 .																																																	
3	Generating power	Power is limited by user limit or temperature limit. See parameters 130.47...130.49 .																																																	
4	Active current limit	Active current is limited. For details, see bits 6...9 and 14...15.																																																	
5	Reactive current limit	Reactive current is limited. For details, see bits 12...13.																																																	
6	thermal limit	Current is limited by main circuit thermal limit (this internal limit can not be changed by the user).																																																	
7	SOA limit	Current is limited by the safe operation area (SOA) limit (this internal limit can not be changed by the user).																																																	
8	user current limit	Current is limited by 130.46 Current limit % .																																																	
9	thermal igbt	Current is limited by maximum thermal IGBT stress (this internal limit can not be changed by the user).																																																	
10...11	Reserved.																																																		
12	Q act neg	Total current limitation limits negative reactive current.																																																	
13	Q act pos	Total current limitation limits positive reactive current.																																																	
14	P act neg	Total current limitation limits negative active current.																																																	
15	P act pos	Total current limitation limits positive active current.																																																	
0000h...FFFFh		Limit word 3.	1 = 1																																																
130.04	<i>Limit word 4</i>	Shows limit word 4. This parameter is read-only.	-																																																
<table border="1"> <thead> <tr> <th>Bit</th> <th>Name</th> <th>Description</th> </tr> </thead> <tbody> <tr> <td>0</td> <td>Udc ref max</td> <td>1 = U_{dc} reference is being limited by 123.06 DC voltage ref max.</td> </tr> <tr> <td>1</td> <td>Udc ref min</td> <td>1 = U_{dc} reference is being limited by 123.07 DC voltage ref min.</td> </tr> <tr> <td>2</td> <td>User I max</td> <td>Current is limited by 130.46 Current limit %.</td> </tr> <tr> <td>3</td> <td>Temp I max</td> <td>Current is limited by temperature-based current limit.</td> </tr> <tr> <td>4...15</td> <td colspan="2">Reserved.</td> </tr> </tbody> </table>				Bit	Name	Description	0	Udc ref max	1 = U_{dc} reference is being limited by 123.06 DC voltage ref max .	1	Udc ref min	1 = U_{dc} reference is being limited by 123.07 DC voltage ref min .	2	User I max	Current is limited by 130.46 Current limit % .	3	Temp I max	Current is limited by temperature-based current limit.	4...15	Reserved.																															
Bit	Name	Description																																																	
0	Udc ref max	1 = U_{dc} reference is being limited by 123.06 DC voltage ref max .																																																	
1	Udc ref min	1 = U_{dc} reference is being limited by 123.07 DC voltage ref min .																																																	
2	User I max	Current is limited by 130.46 Current limit % .																																																	
3	Temp I max	Current is limited by temperature-based current limit.																																																	
4...15	Reserved.																																																		
0000h...FFFFh		Limit word 4.	1 = 1																																																

No.	Name/Value	Description	Def/FbEq16
130.16	<i>Q cooling overtemp limit</i>	<p>Enables the reactive power limitation based on measured coolant temperature <i>130.52 Ext Tmp1</i> or <i>130.53 Ext Tmp2</i>. Parameters <i>130.52 Ext Tmp1</i> and <i>130.53 Ext Tmp2</i> define the measured external temperature. The coolant temperature can also be set by using the selection <i>Other</i>.</p> <p><u>Example:</u> Set parameter <i>130.50 Ext Tmp1 input selection</i> with selection <i>Other</i> to <i>114.26 AI1 actual value</i>. Set parameter <i>114.77 AO1 source</i> with selection <i>Other</i> to <i>130.54 Pt current</i>. It is possible to use groups 115 or 116 also.</p> <p>If the coolant temperature exceeds the given limit, the reactive power is limited according to the figure below.</p>	<i>No</i>
No		Limitation disabled.	0
Yes		Limitation enabled.	1
130.17	<i>Q cooling temp 1</i>	Defines the temperature level where limitation of reactive power starts.	53.00 °C
	0.00 ... 200.00 °C	Temperature level.	1 = 1 °C
130.18	<i>Q cooling temp 2</i>	Defines the temperature level where reactive power is limited to <i>130.20 Q cooling limit level 2</i> .	55.00 °C
	0.00 ... 200.00 °C	Temperature level.	1 = 1 °C
130.19	<i>Q cooling temp 3</i>	Defines the temperature level where reactive power is limited to <i>130.21 Q cooling limit level 3</i> .	56.00 °C
	0.00 ... 200.00 °C	Temperature level.	1 = 1 °C
130.20	<i>Q cooling limit level 2</i>	Defines the allowed percentage of reactive power reference at temperature <i>130.18 Q cooling temp 2</i> . 100% equals to nominal power.	0%
	0 ... 100%	Percentage value.	1 = 1%
130.21	<i>Q cooling limit level 3</i>	Defines the allowed percentage of reactive power reference at temperature <i>130.19 Q cooling temp 3</i> . 100% equals to nominal power.	0%
	0 ... 100%	Percentage value.	1 = 1%

132 Parameters

No.	Name/Value	Description	Def/FbEq16
130.22	<i>Q power unit overtemp limit</i>	Enables reactive power limitation based on parameter <i>105.11 Converter temperature %</i> . If the power unit temperature exceeds the given limit, the reactive power is limited according to the figure below.	No
	No	Limitation disabled.	0
	Yes	Limitation enabled.	1
130.23	<i>Q power unit temp 1</i>	Defines the temperature level where limitation of reactive power starts.	95.0%
	0.0 ... 100.0%	Temperature level.	1 = 1%
130.24	<i>Q power unit temp 2</i>	Defines the temperature level where reactive power is limited to <i>130.25 Q power unit limit level</i> .	99.0%
	0.0 ... 100.0%	Temperature level.	1 = 1%
130.25	<i>Q power unit limit level</i>	Defines the allowed percentage of reactive power reference at temperature <i>130.24 Q power unit temp 2</i> . 100% equals to nominal power.	0%
	0 ... 100%	Percentage value.	1 = 1%
130.30	<i>Ireact limit %</i>	Shows the output value of reactive power limitation in percent of the nominal.	-
	-200.0 ... 200.0%	Percentage value.	1 = 1%
130.31	<i>Ireact limit</i>	Shows the output value of limited reactive current in Amperes.	-
	-	Output value of limited reactive current.	1 = 1 A
130.32	<i>Q power limit %</i>	Shows the output value of limited reactive power in percent of the nominal.	-
	-200.0 ... 200.0%	Percentage value.	1 = 1%
130.33	<i>Q power limit</i>	Shows the output value of limited reactive power in kVAr.	-
	-	Output value of limited reactive power.	1 = 1 kVAr
130.46	<i>Current limit %</i>	Defines a customer limit for maximum line current in percent. Limits reactive current if line current exceeds the limit.	130%
	0 ... 200%	Customer limit for maximum line current.	1 = 1%
130.47	<i>Power sign change</i>	(Only visible with control program AISLX) Changes the sign of power signals. No = positive (motoring) power flows from AC to DC Yes = positive (generating) power flows from DC to AC	No
	No	Positive (motoring) power flow from AC to DC.	0

No.	Name/Value	Description	Def/FbEq16
	Yes	Positive (generating) power flow from DC to AC.	1
130.48	<i>User power limit max %</i>	Defines a customer limit for maximum power in percent. Power sign is selected with parameter 130.47 Power sign change . With default setting of parameter 130.47 Power sign change , this means maximum power from AC to DC.	130.0%
	0.0 ... 200.0%	Customer limit for maximum power.	1 = 1%
130.49	<i>User power limit min %</i>	Defines a customer limit for minimum power in percent. Power sign is selected with parameter 130.47 Power sign change . With default setting of parameter 130.47 Power sign change , this means minimum power from DC to AC. * In control program AISLX. ** In control program ALHLX.	-200.0% * 0.0% **
	-200.0 ... 0.0% * -10.0 ... 1.0% **	Customer limit for minimum power.	1 = 1%
130.50	<i>Ext Tmp1 input selection</i>	Defines the source for external temperature 1 measurement.	<i>Disabled</i>
	Disabled	No source.	0
	Other	The value is taken from another parameter.	-
130.51	<i>Ext Tmp2 input selection</i>	Defines the source for external temperature 1 measurement.	<i>Disabled</i>
	Disabled	No source.	0
	Other	The value is taken from another parameter.	-
130.52	<i>Ext Tmp1</i>	Defines the measured external temperature 1.	0
	-	Measured external temperature 1.	1 = 1 °C
130.53	<i>Ext Tmp2</i>	Defines the measured external temperature 2.	0
	-	Measured external temperature 2.	1 = 1 °C
130.54	<i>Pt current</i>	Defines the PT100 excitation current.	10.0 mA
	0.0...10.0 mA	PT100 excitation current.	1 = 1 mA
130.55	<i>Cyclic Pt current</i>	Defines the cyclic PT100 excitation current.	0
	-	PT100 excitation current.	1 = 1 mA
130.58	<i>Cooling temp source</i>	Selects the source for coolant temperature.	<i>Ext Tmp1</i>
	Disabled	Disabled.	0
	Ext Tmp1	Measured external temperature 1.	1
	Ext Tmp2	Measured external temperature 2.	2
131 Fault functions		Settings that define the behavior of the IGBT supply unit upon fault situations.	
131.01	<i>External event 1 source</i>	Selects the source of external event 1. See also parameter 131.02 External event 1 type . 0 = Trigger event 1 = Normal operation	<i>Inactive (true)</i>
	Active (false)	0.	0
	Inactive (true)	1.	1
	DIIL	DIIL input (110.02 DI delayed status , bit 15).	2
	DI1	Digital input DI1 (110.02 DI delayed status , bit 0).	3
	DI2	Digital input DI2 (110.02 DI delayed status , bit 1).	4
	DI3	Digital input DI3 (110.02 DI delayed status , bit 2). Note: DI3 is reserved for main breaker/contactors fault in the control program. Do not select it for any other use.	5
	DI4	Digital input DI4 (110.02 DI delayed status , bit 3).	6
	DI5	Digital input DI5 (110.02 DI delayed status , bit 4).	7
	DI6	Digital input DI6 (110.02 DI delayed status , bit 5).	8

134 Parameters

No.	Name/Value	Description	Def/FbEq16
	DIO1	Digital input/output DIO1 (<i>111.02 DIO delayed status</i> , bit 0).	11
	DIO2	Digital input/output DIO2 (<i>111.02 DIO delayed status</i> , bit 1).	12
	<i>Other</i>	Source selection (see <i>Terms and abbreviations</i> on page 61).	-
<i>131.02</i>	<i>External event 1 type</i>	Selects the type of external event 1.	<i>Fault</i>
	Fault	The external event generates a fault.	0
	Warning	The external event generates a warning.	1
	Warning/Fault	If the supply unit is modulating, the external event generates a fault. Otherwise, the event generates a warning.	3
<i>131.03</i>	<i>External event 2 source</i>	Defines the source of external event 2. See also parameter <i>131.04 External event 2 type</i> . For selections, see parameter <i>131.01 External event 1 source</i> .	<i>Inactive (true)</i>
<i>131.04</i>	<i>External event 2 type</i>	Selects the type of external event 2. For selections, see parameter <i>131.02 External event 1 type</i> .	<i>Fault</i>
<i>131.05</i>	<i>External event 3 source</i>	Defines the source of external event 3. See also parameter <i>131.06 External event 3 type</i> . For selections, see parameter <i>131.01 External event 1 source</i> .	<i>Inactive (true)</i>
<i>131.06</i>	<i>External event 3 type</i>	Selects the type of external event 3. For selections, see parameter <i>131.02 External event 1 type</i> .	<i>Fault</i>
<i>131.07</i>	<i>External event 4 source</i>	Defines the source of external event 4. See also parameter <i>131.08 External event 4 type</i> . For selections, see parameter <i>131.01 External event 1 source</i> .	<i>Inactive (true)</i>
<i>131.08</i>	<i>External event 4 type</i>	Selects the type of external event 4. For selections, see parameter <i>131.02 External event 1 type</i> .	<i>Fault</i>
<i>131.09</i>	<i>External event 5 source</i>	Defines the source of external event 5. See also parameter <i>131.10 External event 5 type</i> . For selections, see parameter <i>131.01 External event 1 source</i> .	<i>Inactive (true)</i>
<i>131.10</i>	<i>External event 5 type</i>	Selects the type of external event 5. For selections, see parameter <i>131.02 External event 1 type</i> .	<i>Fault</i>
<i>131.11</i>	<i>Fault reset selection</i>	Selects the source of an external fault reset signal. The signal resets the IGBT supply unit after a fault trip if the cause of the fault no longer exists. 0 -> 1 = Reset Note: A fault reset from the fieldbus interface is always observed regardless of this parameter.	<i>DI6</i>
	Off	Fault reset is off (0).	0
	On	Fault reset when you change the parameter from value Off to On (0->1).	1
	DI1	Digital input DI1 (<i>110.02 DI delayed status</i> , bit 0).	2
	DI2	Digital input DI2 (<i>110.02 DI delayed status</i> , bit 1).	3
	DI3	Digital input DI3 (<i>110.02 DI delayed status</i> , bit 2).	4
	DI4	Digital input DI4 (<i>110.02 DI delayed status</i> , bit 3).	5
	DI5	Digital input DI5 (<i>110.02 DI delayed status</i> , bit 4).	6
	DI6	Digital input DI6 (<i>110.02 DI delayed status</i> , bit 5).	7
	DIO1	Digital input/output DIO1 (<i>111.02 DIO delayed status</i> , bit 0).	10
	DIO2	Digital input/output DIO2 (<i>111.02 DIO delayed status</i> , bit 1).	11
	<i>Other</i>	Source selection (see <i>Terms and abbreviations</i> on page 61).	-

No.	Name/Value	Description	Def/FbEq16																						
131.12	<i>Autoreset selection</i>	<p>Selects faults that are automatically reset. The parameter is a 16-bit word with each bit corresponding to a fault type. Whenever a bit is set to 1, the corresponding fault is automatically reset.</p> <p>Note: The autoreset function is only available in external control; see section <i>Local control vs. external control</i> (page 20).</p> <p> WARNING! The supply unit starts automatically after the autoreset if Start, Run enable and Start enable signals are on and the control program detects no fault. Before you activate the function, make sure that no dangerous situations can occur. The function resets the supply unit automatically and continues operation after a fault. If you select an external source for the start command and it is on, the supply unit will start immediately after fault reset.</p> <p>The bits of the binary number correspond to the following faults:</p>	0000h																						
<table border="1"> <thead> <tr> <th>Bit</th> <th>Fault</th> </tr> </thead> <tbody> <tr> <td>0</td> <td>Overcurrent</td> </tr> <tr> <td>1</td> <td>DC overvoltage</td> </tr> <tr> <td>2</td> <td>DC undervoltage</td> </tr> <tr> <td>3...9</td> <td>Reserved</td> </tr> <tr> <td>10</td> <td>User fault (from source selected by parameter <i>131.13 User selectable fault</i>)</td> </tr> <tr> <td>11</td> <td>External fault 1 (from source selected by parameter <i>131.01 External event 1 source</i>)</td> </tr> <tr> <td>12</td> <td>External fault 2 (from source selected by parameter <i>131.03 External event 2 source</i>)</td> </tr> <tr> <td>13</td> <td>External fault 3 (from source selected by parameter <i>131.05 External event 3 source</i>)</td> </tr> <tr> <td>14</td> <td>External fault 4 (from source selected by parameter <i>131.07 External event 4 source</i>)</td> </tr> <tr> <td>15</td> <td>External fault 5 (from source selected by parameter <i>131.09 External event 5 source</i>)</td> </tr> </tbody> </table>				Bit	Fault	0	Overcurrent	1	DC overvoltage	2	DC undervoltage	3...9	Reserved	10	User fault (from source selected by parameter <i>131.13 User selectable fault</i>)	11	External fault 1 (from source selected by parameter <i>131.01 External event 1 source</i>)	12	External fault 2 (from source selected by parameter <i>131.03 External event 2 source</i>)	13	External fault 3 (from source selected by parameter <i>131.05 External event 3 source</i>)	14	External fault 4 (from source selected by parameter <i>131.07 External event 4 source</i>)	15	External fault 5 (from source selected by parameter <i>131.09 External event 5 source</i>)
Bit	Fault																								
0	Overcurrent																								
1	DC overvoltage																								
2	DC undervoltage																								
3...9	Reserved																								
10	User fault (from source selected by parameter <i>131.13 User selectable fault</i>)																								
11	External fault 1 (from source selected by parameter <i>131.01 External event 1 source</i>)																								
12	External fault 2 (from source selected by parameter <i>131.03 External event 2 source</i>)																								
13	External fault 3 (from source selected by parameter <i>131.05 External event 3 source</i>)																								
14	External fault 4 (from source selected by parameter <i>131.07 External event 4 source</i>)																								
15	External fault 5 (from source selected by parameter <i>131.09 External event 5 source</i>)																								
	0000h...FFFFh	Automatic reset configuration word.	1 = 1																						
131.13	<i>User selectable fault</i>	<p>Defines the fault that can be automatically reset using parameter <i>131.12 Autoreset selection</i>, bit 10 User fault. Give the fault code of the selected fault. The code is given in integer.</p> <p>The faults are listed in chapter <i>Fault tracing</i> (page 223).</p>	0																						
	0...65535	Fault code.	10 = 1																						
131.14	<i>Number of trials</i>	<p>Defines the number of automatic fault resets the supply unit performs within the time defined by parameter <i>131.15 Total trials time</i>.</p>	0																						
	0...5	Number of automatic resets.	-																						
131.15	<i>Total trials time</i>	<p>Defines the time for the automatic reset function. See parameter <i>131.14 Number of trials</i>.</p>	30.0 s																						
	1.0 ... 600.0 s	Time for automatic resets.	10 = 1 s																						
131.16	<i>Delay time</i>	<p>Defines the time that the supply unit will wait after each fault before attempting an automatic reset. See parameter <i>131.12 Autoreset selection</i>.</p>	0.0 s																						
	0.0 ... 120.0 s	Autoreset delay.	10 = 1 s																						
131.20	<i>Earth fault</i>	<p>Selects how the supply unit reacts when an earth fault or current unbalance is detected.</p>	<i>Fault</i>																						
	No	No action taken.	0																						
	Warning	The supply unit generates an <i>AE02 Earth leakage</i> warning.	1																						
	Fault	The supply unit trips on fault <i>2E01 Earth leakage</i> .	2																						

136 Parameters

No.	Name/Value	Description	Def/FbEq16
131.28	<i>Ext earth leakage signal source</i>	Defines the input for external earth fault (<i>2E08 External earth fault</i>). 1 = no fault 0 = external earth fault	<i>Inactive (true)</i>
	Active (false)	External earth fault.	0
	Inactive (true)	No fault.	1
	DIIL	Digital input DIIL (<i>110.02 DI delayed status</i> , bit 15).	2
	DI1	Digital input DI1 (<i>110.02 DI delayed status</i> , bit 0).	3
	DI2	Digital input DI2 (<i>110.02 DI delayed status</i> , bit 1).	4
	DI3	Digital input DI3 (<i>110.02 DI delayed status</i> , bit 2). Note: DI3 is reserved for main breaker/contactors fault in the control program. Do not select it for any other use.	5
	DI4	Digital input DI4 (<i>110.02 DI delayed status</i> , bit 3).	6
	DI5	Digital input DI5 (<i>110.02 DI delayed status</i> , bit 4).	7
	DI6	Digital input DI6 (<i>110.02 DI delayed status</i> , bit 5).	8
	DIO1	Digital input/output DIO1 (<i>111.02 DIO delayed status</i> , bit 0).	11
	DIO2	Digital input/output DIO2 (<i>111.02 DIO delayed status</i> , bit 1).	12
	<i>Other</i>	Source selection (see <i>Terms and abbreviations</i> on page 61).	-
131.29	<i>Ext earth leakage action</i>	Selects how the IGBT supply unit reacts when an external earth leakage is detected.	<i>Fault</i>
	Warning	The IGBT supply unit generates a warning <i>AE87 Ext earth leakage</i> .	0
	Fault	The IGBT supply unit trips on a fault <i>2E08 External earth fault</i>	1
131.32	<i>Aux circuit breaker fault source</i>	Activates/inactivates the status monitoring function of the auxiliary circuit switch/breaker(s), and defines the source for the monitored signal. If the function detects that the breaker(s) is open, it trips the supply unit to fault <i>5E13 Auxiliary Circuit breaker</i> . Status of the monitored signal and implication: 1 = Breaker is closed -> no fault 0 = Breaker is open -> fault trip Note: This parameter is not for main circuit breaker.	<i>Inactive (true)</i>
	Active (false)	Auxiliary circuit breaker fault.	0
	Inactive (true)	No fault.	1
	DIIL	Monitoring is active. DIIL is the source for the breaker status indication (<i>110.02 DI delayed status</i> , bit 15).	2
	DI1	Monitoring is active. DI1 is the source for the breaker status indication (<i>110.02 DI delayed status</i> , bit 0).	3
	DI2	Monitoring is active. DI2 is the source for the breaker status indication (<i>110.02 DI delayed status</i> , bit 1).	4
	DI3	Monitoring is active. DI3 is the source for the breaker status indication (<i>110.02 DI delayed status</i> , bit 2). Note: DI3 is reserved for main breaker/contactors fault in the control program. Do not select it for any other use.	5
	DI4	Monitoring is active. DI4 is the source for the breaker status indication (<i>110.02 DI delayed status</i> , bit 3).	6
	DI5	Monitoring is active. DI5 is the source for the breaker status indication (<i>110.02 DI delayed status</i> , bit 4).	7
	DI6	Monitoring is active. DI6 is the source for the breaker status indication (<i>110.02 DI delayed status</i> , bit 5).	8
	DIO1	Monitoring is active. DIO1 is the source for the breaker status indication (<i>111.02 DIO delayed status</i> , bit 0).	11

No.	Name/Value	Description	Def/FbEq16
	DIO2	Monitoring is active. DIO2 is the source for the breaker status indication (<i>111.02 DIO delayed status</i> , bit 1).	12
	<i>Other</i>	Source selection (see <i>Terms and abbreviations</i> on page 61).	-
<i>131.33</i>	<i>Cabinet temperature fault source</i>	Activates/inactivates the monitoring for the cabinet thermal switch, and defines the source for the monitored signal. If the monitoring detects an overtemperature, it trips the supply unit to fault <i>4E06 Cabinet or LCL overtemperature</i> . Status of the monitored signal and implication: 1 = Temperature is normal -> no fault 0 = Overtemperature -> fault trip	<i>D11</i>
	Active (false)	Monitoring function is active.	0
	Inactive (true)	Monitoring function is inactive.	1
	DIIL	Monitoring function is active and it reads the status indication through DIIL (<i>110.02 DI delayed status</i> , bit 15).	2
	DI1	Monitoring function is active and it reads the status indication through DI1 (<i>110.02 DI delayed status</i> , bit 0).	3
	DI2	Monitoring function is active and it reads the status indication through DI2 (<i>110.02 DI delayed status</i> , bit 1).	4
	DI3	Monitoring function is active and it reads the status indication through DI3 (<i>110.02 DI delayed status</i> , bit 2).	5
	DI4	Monitoring function is active and it reads the status indication through DI4 (<i>110.02 DI delayed status</i> , bit 3).	6
	DI5	Monitoring function is active and it reads the status indication through DI5 (<i>110.02 DI delayed status</i> , bit 4).	7
	DI6	Monitoring function is active and it reads the status indication through DI6 (<i>110.02 DI delayed status</i> , bit 5).	8
	DIO1	Monitoring function is active and it reads the status indication through DIO1 (<i>111.02 DIO delayed status</i> , bit 0).	11
	DIO2	Monitoring function is active and it reads the status indication through DIO2 (<i>111.02 DIO delayed status</i> , bit 1).	12
	<i>Other</i>	Source selection (see <i>Terms and abbreviations</i> on page 61).	-
<i>131.34</i>	<i>Cabinet temperature supervision</i>	Selects whether there is a delay in monitoring the parameter <i>131.33 Cabinet temperature fault source</i> . If this parameter is set to <i>When modulating</i> , the monitoring is started after the modulation has started. Otherwise there is no delay for the monitoring.	<i>When modulating</i>
	Always	There is no delay for the monitoring.	0
	When modulating	Cabinet temperature monitoring is started after the modulation has started.	1
<i>131.35</i>	<i>Main fan fault function</i>	Selects how the supply unit reacts when a main fan fault is detected.	<i>Fault</i>
	Fault	The supply unit trips on a fault <i>5E00 Fan</i> .	0
	Warning	The supply unit generates a warning <i>AE73 Fan</i> .	1
	No action	No action taken.	1
<i>131.38</i>	<i>Fuse trip fault source</i>	Activates/inactivates the monitoring for the fuse trip, and defines the source for the monitored signal.	<i>Inactive (true)</i>
	Active (false)	Monitoring function is active.	0
	Inactive (true)	Monitoring function is inactive.	1
	DIIL	Monitoring function is active and it reads the status indication through DIIL (<i>110.02 DI delayed status</i> , bit 15).	2
	DI1	Monitoring function is active and it reads the status indication through DI1 (<i>110.02 DI delayed status</i> , bit 0).	3
	DI2	Monitoring function is active and it reads the status indication through DI2 (<i>110.02 DI delayed status</i> , bit 1).	4

No.	Name/Value	Description	Def/FbEq16														
	DI3	Monitoring function is active and it reads the status indication through DI3 (<i>110.02 DI delayed status</i> , bit 2).	5														
	DI4	Monitoring function is active and it reads the status indication through DI4 (<i>110.02 DI delayed status</i> , bit 3).	6														
	DI5	Monitoring function is active and it reads the status indication through DI5 (<i>110.02 DI delayed status</i> , bit 4).	7														
	DI6	Monitoring function is active and it reads the status indication through DI6 (<i>110.02 DI delayed status</i> , bit 5).	8														
	DIO1	Monitoring function is active and it reads the status indication through DIO1 (<i>111.02 DIO delayed status</i> , bit 0).	11														
	DIO2	Monitoring function is active and it reads the status indication through DIO2 (<i>111.02 DIO delayed status</i> , bit 1).	12														
	<i>Other</i>	Source selection (see <i>Terms and abbreviations</i> on page 61).	-														
<i>131.39</i>	<i>Brake chopper fault source</i>	Activates/inactivates the monitoring for the brake chopper, and defines the source for the monitored signal.	<i>Inactive (true)</i>														
	Active (false)	Monitoring function is active.	0														
	Inactive (true)	Monitoring function is inactive.	1														
	DIIL	Monitoring function is active and it reads the status indication through DIIL (<i>110.02 DI delayed status</i> , bit 15).	2														
	DI1	Monitoring function is active and it reads the status indication through DI1 (<i>110.02 DI delayed status</i> , bit 0).	3														
	DI2	Monitoring function is active and it reads the status indication through DI2 (<i>110.02 DI delayed status</i> , bit 1).	4														
	DI3	Monitoring function is active and it reads the status indication through DI3 (<i>110.02 DI delayed status</i> , bit 2).	5														
	DI4	Monitoring function is active and it reads the status indication through DI4 (<i>110.02 DI delayed status</i> , bit 3).	6														
	DI5	Monitoring function is active and it reads the status indication through DI5 (<i>110.02 DI delayed status</i> , bit 4).	7														
	DI6	Monitoring function is active and it reads the status indication through DI6 (<i>110.02 DI delayed status</i> , bit 5).	8														
	DIO1	Monitoring function is active and it reads the status indication through DIO1 (<i>111.02 DIO delayed status</i> , bit 0).	11														
	DIO2	Monitoring function is active and it reads the status indication through DIO2 (<i>111.02 DIO delayed status</i> , bit 1).	12														
	<i>Other</i>	Source selection (see <i>Terms and abbreviations</i> on page 61).	-														
<i>131.40</i>	<i>Disable warning messages</i>	Selects warnings to be suppressed. The parameter is a 16-bit word with each bit corresponding to a warning. Whenever a bit is set to 1, the corresponding warning is suppressed. The bits of this binary number correspond to the following warnings:	0000b														
<table border="1"> <thead> <tr> <th>Bit</th> <th>Name</th> </tr> </thead> <tbody> <tr> <td>0</td> <td>Overvoltage</td> </tr> <tr> <td>1</td> <td>Phase order (BCU control units only)</td> </tr> <tr> <td>2</td> <td>Encoder 1</td> </tr> <tr> <td>3</td> <td>Encoder 2</td> </tr> <tr> <td>4</td> <td>CU (Control unit) battery</td> </tr> <tr> <td>5...15</td> <td>Reserved.</td> </tr> </tbody> </table>				Bit	Name	0	Overvoltage	1	Phase order (BCU control units only)	2	Encoder 1	3	Encoder 2	4	CU (Control unit) battery	5...15	Reserved.
Bit	Name																
0	Overvoltage																
1	Phase order (BCU control units only)																
2	Encoder 1																
3	Encoder 2																
4	CU (Control unit) battery																
5...15	Reserved.																
	0000h...FFFFh	Warning suppression word.	1 = 1														
<i>131.55</i>	<i>Ext I/O comm loss event</i>	Selects how the supply unit reacts when the communication to an I/O extension module fails.	<i>Fault</i>														
	No action	No action taken.	0														

No.	Name/Value	Description	Def/FbEq16																								
	Warning	The supply unit generates a warning.	1																								
	Fault	The supply unit trips on a fault <i>7E10 Ext I/O comm loss</i> .	2																								
133 Generic timer & counter		Configuration of maintenance timers/counters. See also section <i>Maintenance timers and counters</i> (page 40).																									
133.01	Counter status	Displays the maintenance timer/counter status word, indicating which maintenance timers/counters have exceeded their limits. This parameter is read-only.	-																								
<table border="1"> <thead> <tr> <th>Bit</th> <th>Name</th> <th>Description</th> </tr> </thead> <tbody> <tr> <td>0</td> <td>On-time1</td> <td>1 = On-time timer 1 has reached its preset limit.</td> </tr> <tr> <td>1</td> <td>On-time2</td> <td>1 = On-time timer 2 has reached its preset limit.</td> </tr> <tr> <td>2</td> <td>Edge 1</td> <td>1 = Signal edge counter 1 has reached its preset limit.</td> </tr> <tr> <td>3</td> <td>Edge 2</td> <td>1 = Signal edge counter 2 has reached its preset limit.</td> </tr> <tr> <td>4</td> <td>Value 1</td> <td>1 = Value counter 1 has reached its preset limit.</td> </tr> <tr> <td>5</td> <td>Value 2</td> <td>1 = Value counter 2 has reached its preset limit.</td> </tr> <tr> <td>6...15</td> <td>Reserved</td> <td></td> </tr> </tbody> </table>				Bit	Name	Description	0	On-time1	1 = On-time timer 1 has reached its preset limit.	1	On-time2	1 = On-time timer 2 has reached its preset limit.	2	Edge 1	1 = Signal edge counter 1 has reached its preset limit.	3	Edge 2	1 = Signal edge counter 2 has reached its preset limit.	4	Value 1	1 = Value counter 1 has reached its preset limit.	5	Value 2	1 = Value counter 2 has reached its preset limit.	6...15	Reserved	
Bit	Name	Description																									
0	On-time1	1 = On-time timer 1 has reached its preset limit.																									
1	On-time2	1 = On-time timer 2 has reached its preset limit.																									
2	Edge 1	1 = Signal edge counter 1 has reached its preset limit.																									
3	Edge 2	1 = Signal edge counter 2 has reached its preset limit.																									
4	Value 1	1 = Value counter 1 has reached its preset limit.																									
5	Value 2	1 = Value counter 2 has reached its preset limit.																									
6...15	Reserved																										
	0000h...FFFFh	Maintenance time/counter status word.	1 = 1																								
133.10	On-time 1 actual	Reading of on-time timer 1. Can be reset from the Drive composer PC tool, or from the control panel by keeping Reset depressed for over 3 seconds.	0																								
	0...4294967295 s	Reading of on-time timer 1.	-																								
133.11	On-time 1 limit	Sets the warning limit for on-time timer 1.	0 s																								
	0...4294967295 s	Warning limit for on-time counter 1.	-																								
133.12	On-time 1 function	Configures on-time timer 1. This timer runs whenever the signal selected by parameter 133.13 On-time 1 source is on. After the limit set by 133.11 On-time 1 limit is reached, the warning specified by 133.14 On-time 1 warning select is given (if enabled by this parameter), and the timer reset. The current value of the timer is readable from parameter 133.10 On-time 1 actual . Bit 0 of 133.01 Counter status indicates that the time has exceeded the limit.	00b																								
<table border="1"> <thead> <tr> <th>Bit</th> <th>Function</th> </tr> </thead> <tbody> <tr> <td>0</td> <td>Counter mode 0 = Loop: If warning is enabled by bit 1, it stays active only for 10 seconds 1 = Saturate: If warning is enabled by bit 1, it stays active until reset</td> </tr> <tr> <td>1</td> <td>Warning enable 0 = Disable: No warning is given when the limit is reached 1 = Enable: A warning is given when the limit is reached</td> </tr> <tr> <td>2...15</td> <td>Reserved</td> </tr> </tbody> </table>				Bit	Function	0	Counter mode 0 = Loop: If warning is enabled by bit 1, it stays active only for 10 seconds 1 = Saturate: If warning is enabled by bit 1, it stays active until reset	1	Warning enable 0 = Disable: No warning is given when the limit is reached 1 = Enable: A warning is given when the limit is reached	2...15	Reserved																
Bit	Function																										
0	Counter mode 0 = Loop: If warning is enabled by bit 1, it stays active only for 10 seconds 1 = Saturate: If warning is enabled by bit 1, it stays active until reset																										
1	Warning enable 0 = Disable: No warning is given when the limit is reached 1 = Enable: A warning is given when the limit is reached																										
2...15	Reserved																										
	0000h...FFFFh	On-time timer 1 configuration word.	1 = 1																								
133.13	On-time 1 source	Selects the signal to be monitored by on-time timer 1.	<i>False</i>																								
	False	Constant 0.	0																								
	True	Constant 1.	1																								
	RO1	Bit 0 of 110.21 RO status (page 83).	2																								
	<i>Other</i>	Source selection (see <i>Terms and abbreviations</i> on page 61).	-																								
133.14	On-time 1 warning select	Selects the warning message for on-time timer 1.	<i>On-time 1</i>																								
	On-time 1	<i>AE45 On-Time 1 warning</i> .	0																								
	Device clean	<i>AE4B Device clean warning</i> .	6																								

140 Parameters

No.	Name/Value	Description	Def/FbEq16								
	Additional cooling fan	AE4F Additional cooling fan warning.	7								
	Cabinet fan	AE4D Cabinet fan warning.	8								
	DC-capacitor	AE4C DC capacitor warning.	9								
133.20	On-time 2 actual	Reading of on-time timer 2. Can be reset from the Drive composer PC tool, or from the control panel by keeping Reset depressed for over 3 seconds.	-								
	0...4294967295 s	Reading of on-time timer 2.	-								
133.21	On-time 2 limit	Sets the warning limit for on-time timer 2.	0 s								
	0...4294967295 s	Warning limit for on-time counter 2.	-								
133.22	On-time 2 function	Configures on-time timer 2. This timer runs whenever the signal selected by parameter 133.23 On-time 2 source is on. After the limit set by 133.21 On-time 2 limit is reached, the warning specified by 133.24 On-time 2 warning select is given (if enabled by this parameter), and the timer reset. The current value of the timer is readable from parameter 133.20 On-time 2 actual . Bit 1 of 133.01 Counter status indicates that the time has exceeded the limit.	00b								
<table border="1"> <thead> <tr> <th>Bit</th> <th>Function</th> </tr> </thead> <tbody> <tr> <td>0</td> <td>Counter mode 0 = Loop: If warning is enabled by bit 1, it stays active only for 10 seconds 1 = Saturate: If warning is enabled by bit 1, it stays active until reset</td> </tr> <tr> <td>1</td> <td>Warning enable 0 = Disable: No warning is given when the limit is reached 1 = Enable: A warning is given when the limit is reached</td> </tr> <tr> <td>2...15</td> <td>Reserved</td> </tr> </tbody> </table>				Bit	Function	0	Counter mode 0 = Loop: If warning is enabled by bit 1, it stays active only for 10 seconds 1 = Saturate: If warning is enabled by bit 1, it stays active until reset	1	Warning enable 0 = Disable: No warning is given when the limit is reached 1 = Enable: A warning is given when the limit is reached	2...15	Reserved
Bit	Function										
0	Counter mode 0 = Loop: If warning is enabled by bit 1, it stays active only for 10 seconds 1 = Saturate: If warning is enabled by bit 1, it stays active until reset										
1	Warning enable 0 = Disable: No warning is given when the limit is reached 1 = Enable: A warning is given when the limit is reached										
2...15	Reserved										
	0000h...FFFFh	On-time timer 2 configuration word.	1 = 1								
133.23	On-time 2 source	Selects the signal to be monitored by on-time timer 2.	False								
	False	Constant 0.	0								
	True	Constant 1.	1								
	RO1	Bit 0 of 110.21 RO status (page 83).	2								
	Other	Source selection (see Terms and abbreviations on page 61).	-								
133.24	On-time 2 warning select	Selects the warning message for on-time timer 2.	On-time 2								
	On-time 2	AE46 On-Time 2 warning.	1								
	Device clean	AE4B Device clean warning.	6								
	Additional cool fan	AE4F Additional cooling fan warning.	7								
	Cabinet fan	AE4D Cabinet fan warning.	8								
	DC-capacitor	AE4C DC capacitor warning.	9								
133.30	Edge counter 1 actual	Reading of signal edge counter 1. Can be reset from the Drive composer PC tool, or from the control panel by keeping Reset depressed for over 3 seconds.	-								
	0...4294967295	Reading of signal edge counter 1.	-								
133.31	Edge counter 1 limit	Sets the warning limit for signal edge counter 1.	0								
	0...4294967295	Warning limit for signal edge counter 1.	-								

No.	Name/Value	Description	Def/FbEq16												
133.32	<i>Edge counter 1 func</i>	Configures signal edge counter 1. This counter is incremented every time the signal selected by parameter 133.33 Edge counter 1 source switches on or off (or either, depending on the setting of this parameter). A divisor may be applied to the count (see 133.34 Edge counter 1 divider). After the limit set by 133.31 Edge counter 1 limit is reached, the warning specified by 133.35 Edge counter 1 warning selection is given (if enabled by this parameter), and the counter reset. The current value of the counter is readable from parameter 133.30 Edge counter 1 actual . Bit 2 of 133.01 Counter status indicates that the count has exceeded the limit.	0000b												
<table border="1"> <thead> <tr> <th>Bit</th> <th>Function</th> </tr> </thead> <tbody> <tr> <td>0</td> <td>Counter mode 0 = Loop: If warning is enabled by bit 1, it stays active only for 10 seconds 1 = Saturate: If warning is enabled by bit 1, it stays active until reset</td> </tr> <tr> <td>1</td> <td>Warning enable 0 = Disable: No warning is given when the limit is reached 1 = Enable: A warning is given when the limit is reached</td> </tr> <tr> <td>2</td> <td>Count rising edges 0 = Disable: Rising edges are not counted 1 = Enable: Rising edges are counted</td> </tr> <tr> <td>3</td> <td>Count falling edges 0 = Disable: Falling edges are not counted 1 = Enable: Falling edges are counted</td> </tr> <tr> <td>4...15</td> <td>Reserved</td> </tr> </tbody> </table>				Bit	Function	0	Counter mode 0 = Loop: If warning is enabled by bit 1, it stays active only for 10 seconds 1 = Saturate: If warning is enabled by bit 1, it stays active until reset	1	Warning enable 0 = Disable: No warning is given when the limit is reached 1 = Enable: A warning is given when the limit is reached	2	Count rising edges 0 = Disable: Rising edges are not counted 1 = Enable: Rising edges are counted	3	Count falling edges 0 = Disable: Falling edges are not counted 1 = Enable: Falling edges are counted	4...15	Reserved
Bit	Function														
0	Counter mode 0 = Loop: If warning is enabled by bit 1, it stays active only for 10 seconds 1 = Saturate: If warning is enabled by bit 1, it stays active until reset														
1	Warning enable 0 = Disable: No warning is given when the limit is reached 1 = Enable: A warning is given when the limit is reached														
2	Count rising edges 0 = Disable: Rising edges are not counted 1 = Enable: Rising edges are counted														
3	Count falling edges 0 = Disable: Falling edges are not counted 1 = Enable: Falling edges are counted														
4...15	Reserved														
	0000h...FFFFh	Edge counter 1 configuration word.	1 = 1												
133.33	<i>Edge counter 1 source</i>	Selects the signal to be monitored by signal edge counter 1.	<i>False</i>												
	False	Constant 0.	0												
	True	Constant 1.	1												
	RO1	Bit 0 of 110.21 RO status (page 83).	2												
	<i>Other</i>	Source selection (see Terms and abbreviations on page 61).	-												
133.34	<i>Edge counter 1 divider</i>	Divisor for signal edge counter 1. Determines how many signal edges increment the counter by 1.	1												
	1...4294967295	Divisor for signal edge counter 1.	-												
133.35	<i>Edge counter 1 warning selection</i>	Selects the warning message for signal edge counter 1.	<i>Edge counter 1</i>												
	Edge counter 1	AE47 Edge counter 1 warning .	2												
	Main contactor	AE43 Main contactor warning .	11												
	Output relay	AE40 Output relay warning .	12												
	Supply unit starts	AE41 Supply unit starts warning .	13												
	Power ups	AE42 Power ups warning .	14												
	DC-charge	AE44 DC charge warning .	15												
133.40	<i>Edge counter 2 actual</i>	Reading of signal edge counter 2. Can be reset from the Drive composer PC tool, or from the control panel by keeping Reset depressed for over 3 seconds.	-												
	0...4294967295	Reading of signal edge counter 2.	-												
133.41	<i>Edge counter 2 limit</i>	Sets the warning limit for signal edge counter 2.	0												
	0...4294967295	Warning limit for signal edge counter 2.	-												

142 Parameters

No.	Name/Value	Description	Def/FbEq16												
133.42	<i>Edge counter 2 function</i>	Configures signal edge counter 2. This counter is incremented every time the signal selected by parameter 133.43 Edge counter 2 source switches on or off (or either, depending on the setting of this parameter). A divisor may be applied to the count (see 133.44 Edge counter 2 divider). After the limit set by 133.41 Edge counter 2 limit is reached, the warning specified by 133.45 Edge counter 2 warning selection is given (if enabled by this parameter), and the counter reset. The current value of the counter is readable from parameter 133.40 Edge counter 2 actual . Bit 3 of 133.01 Counter status indicates that the count has exceeded the limit.	0000b												
<table border="1"> <thead> <tr> <th>Bit</th> <th>Function</th> </tr> </thead> <tbody> <tr> <td>0</td> <td>Counter mode 0 = Loop: If warning is enabled by bit 1, it stays active only for 10 seconds 1 = Saturate: If warning is enabled by bit 1, it stays active until reset</td> </tr> <tr> <td>1</td> <td>Warning enable 0 = Disable: No warning is given when the limit is reached 1 = Enable: A warning is given when the limit is reached</td> </tr> <tr> <td>2</td> <td>Count rising edges 0 = Disable: Rising edges are not counted 1 = Enable: Rising edges are counted</td> </tr> <tr> <td>3</td> <td>Count falling edges 0 = Disable: Falling edges are not counted 1 = Enable: Falling edges are counted</td> </tr> <tr> <td>4...15</td> <td>Reserved</td> </tr> </tbody> </table>				Bit	Function	0	Counter mode 0 = Loop: If warning is enabled by bit 1, it stays active only for 10 seconds 1 = Saturate: If warning is enabled by bit 1, it stays active until reset	1	Warning enable 0 = Disable: No warning is given when the limit is reached 1 = Enable: A warning is given when the limit is reached	2	Count rising edges 0 = Disable: Rising edges are not counted 1 = Enable: Rising edges are counted	3	Count falling edges 0 = Disable: Falling edges are not counted 1 = Enable: Falling edges are counted	4...15	Reserved
Bit	Function														
0	Counter mode 0 = Loop: If warning is enabled by bit 1, it stays active only for 10 seconds 1 = Saturate: If warning is enabled by bit 1, it stays active until reset														
1	Warning enable 0 = Disable: No warning is given when the limit is reached 1 = Enable: A warning is given when the limit is reached														
2	Count rising edges 0 = Disable: Rising edges are not counted 1 = Enable: Rising edges are counted														
3	Count falling edges 0 = Disable: Falling edges are not counted 1 = Enable: Falling edges are counted														
4...15	Reserved														
	0000h...FFFFh	Edge counter 2 configuration word.	1 = 1												
133.43	<i>Edge counter 2 source</i>	Selects the signal to be monitored by signal edge counter 2.	<i>False</i>												
	False	0.	0												
	True	1.	1												
	RO1	Bit 0 of <i>RO status</i> (page 83).	2												
	<i>Other</i>	Source selection (see <i>Terms and abbreviations</i> on page 61).	-												
133.44	<i>Edge counter 2 divider</i>	Divisor for signal edge counter 2. Determines how many signal edges increment the counter by 1.	1												
	1...4294967295	Divisor for signal edge counter 2.	-												
133.45	<i>Edge counter 2 warning selection</i>	Selects the warning message for signal edge counter 2.	<i>Edge counter 2</i>												
	Edge counter 2	AE48 Edge counter 2 warning .	3												
	Main contactor	AE43 Main contactor warning .	11												
	Output relay	AE40 Output relay warning .	12												
	Supply unit starts	AE41 Supply unit starts warning .	13												
	Power ups	AE42 Power ups warning .	14												
	DC-charge	AE44 DC charge warning .	15												
133.50	<i>Value counter 1 actual</i>	Reading of value counter 1. Can be reset from the Drive composer PC tool, or from the control panel by keeping Reset depressed for over 3 seconds.	-												
	-2147483008 ... 2147483008	Reading of value counter 1.	-												
133.51	<i>Value counter 1 limit</i>	Sets the warning limit for value counter 1.	0												
	-2147483008 ... 2147483008	Warning limit for value counter 1.	-												

No.	Name/Value	Description	Def/FbEq16								
133.52	Value counter 1 function	<p>Configures value counter 1. This counter measures, by integration, the area below the signal selected by parameter 133.53 Value counter 1 source. A divisor may be applied to the count (see 133.54 Value counter 1 divider).</p> <p>When the total area exceeds the limit set by parameter 133.51 Value counter 1 limit, the warning specified by 133.55 Value counter 1 warning select is given (if enabled by this parameter).</p> <p>The signal is sampled at 1-second intervals. Note that the scaled (see the “Def/FbEq16” column at the signal in question) value is used.</p> <p>The current value of the counter is readable from parameter 133.50 Value counter 1 actual. Bit 4 of 133.01 Counter status indicates that the count has exceeded the limit.</p>	00b								
<table border="1"> <thead> <tr> <th>Bit</th> <th>Function</th> </tr> </thead> <tbody> <tr> <td>0</td> <td> Counter mode 0 = Loop: If warning is enabled by bit 1, it stays active only for 10 seconds 1 = Saturate: If warning is enabled by bit 1, it stays active until reset </td> </tr> <tr> <td>1</td> <td> Warning enable 0 = Disable: No warning is given when the limit is reached 1 = Enable: A warning is given when the limit is reached </td> </tr> <tr> <td>2...15</td> <td>Reserved</td> </tr> </tbody> </table>				Bit	Function	0	Counter mode 0 = Loop: If warning is enabled by bit 1, it stays active only for 10 seconds 1 = Saturate: If warning is enabled by bit 1, it stays active until reset	1	Warning enable 0 = Disable: No warning is given when the limit is reached 1 = Enable: A warning is given when the limit is reached	2...15	Reserved
Bit	Function										
0	Counter mode 0 = Loop: If warning is enabled by bit 1, it stays active only for 10 seconds 1 = Saturate: If warning is enabled by bit 1, it stays active until reset										
1	Warning enable 0 = Disable: No warning is given when the limit is reached 1 = Enable: A warning is given when the limit is reached										
2...15	Reserved										
	0000h...FFFFh	Value counter 1 configuration word.	1 = 1								
133.53	Value counter 1 source	Selects the signal to be monitored by value counter 1.	<i>Not selected</i>								
	Not selected	None.	0								
	Other	The value is taken from another parameter.	-								
133.54	Value counter 1 divider	Divisor for value counter 1. The value of the monitored signal is divided by this value before integration.	1.000								
	0.001 ... 2147483.647	Divisor for value counter 1.	-								
133.55	Value counter 1 warning select	Selects the warning message for value counter 1.	<i>Value 1</i>								
	Value 1	AE49 Value counter 1 warning .	4								
133.60	Value counter 2 actual	Reading of value counter 2. Can be reset from the Drive composer PC tool, or from the control panel by keeping Reset depressed for over 3 seconds.	-								
	-2147483008 ... 2147483008	Reading of value counter 2.	-								
133.61	Value counter 2 limit	Sets the warning limit for value counter 2.	0								
	-2147483008 ... 2147483008	Warning limit for value counter 2.	-								

No.	Name/Value	Description	Def/FbEq16								
133.62	<i>Value counter 2 function</i>	<p>Configures value counter 2. This counter measures, by integration, the area below the signal selected by parameter 133.63 Value counter 2 source. A divisor may be applied to the count (see 133.64 Value counter 2 divider).</p> <p>When the total area exceeds the limit set by parameter 133.61 Value counter 2 limit, the warning specified by 133.65 Value counter 2 warning selection is given (if enabled by this parameter).</p> <p>The signal is sampled at 1-second intervals. Note that the scaled (see the "FbEq" column at the signal in question) value is used.</p> <p>The current value of the counter is readable from parameter 133.60 Value counter 2 actual. Bit 5 of 133.01 Counter status indicates that the count has exceeded the limit.</p>	00b								
<table border="1"> <thead> <tr> <th>Bit</th> <th>Function</th> </tr> </thead> <tbody> <tr> <td>0</td> <td>Counter mode 0 = Loop: If warning is enabled by bit 1, it stays active only for 10 seconds 1 = Saturate: If warning is enabled by bit 1, it stays active until reset</td> </tr> <tr> <td>1</td> <td>Warning enable 0 = Disable: No warning is given when the limit is reached 1 = Enable: A warning is given when the limit is reached</td> </tr> <tr> <td>2...15</td> <td>Reserved</td> </tr> </tbody> </table>				Bit	Function	0	Counter mode 0 = Loop: If warning is enabled by bit 1, it stays active only for 10 seconds 1 = Saturate: If warning is enabled by bit 1, it stays active until reset	1	Warning enable 0 = Disable: No warning is given when the limit is reached 1 = Enable: A warning is given when the limit is reached	2...15	Reserved
Bit	Function										
0	Counter mode 0 = Loop: If warning is enabled by bit 1, it stays active only for 10 seconds 1 = Saturate: If warning is enabled by bit 1, it stays active until reset										
1	Warning enable 0 = Disable: No warning is given when the limit is reached 1 = Enable: A warning is given when the limit is reached										
2...15	Reserved										
	0000h...FFFFh	Value counter 2 configuration word.	1 = 1								
133.63	<i>Value counter 2 source</i>	Selects the signal to be monitored by value counter 2.	<i>Not selected</i>								
	Not selected	None.	0								
	Other	The value is taken from another parameter.	-								
133.64	<i>Value counter 2 divider</i>	Divisor for value counter 2. The value of the monitored signal is divided by this value before integration.	1.000								
	0.001 ... 2147483.647	Divisor for value counter 1.	-								
133.65	<i>Value counter 2 warning selection</i>	Selects the warning message for value counter 2.	<i>Value 2</i>								
	Value 2	AE4A Value counter 2 warning .	5								
136 Load analyzer		Peak value and amplitude logger settings. See also section Load analyzer (page 40).									
136.01	<i>PVL signal source</i>	<p>Selects the signal to be monitored by the peak value logger. The signal is filtered using the filtering time specified by parameter 136.02 PVL filter time.</p> <p>The peak value is stored, along with other pre-selected signals at the time, into parameters 136.10...136.15.</p> <p>The peak value logger can be reset using parameter 136.09 Reset loggers. The date and time of the last reset are stored into parameters 136.16 and 136.17 respectively.</p>	<i>Converter current</i>								
	Zero	None (peak value logger disabled).	0								
	DC voltage	101.01 DC voltage (page 65).	1								
	Frequency	101.08 Frequency (page 65).	2								
	Grid voltage	101.09 Grid voltage (page 65).	3								
	Power	101.12 Power (page 65).	4								
	Reactive power	101.14 Reactive power (page 65).	5								
	Converter current	101.20 Converter current (page 66).	6								
	Converter current %	101.21 Converter current % (page 66).	7								

No.	Name/Value	Description	Def/FbEq16
	Apparent power	101.10 Apparent power (page 65).	8
	Power %	101.13 Power % (page 65).	9
	Converter temperature %	105.11 Converter temperature % (page 73).	10
	CosPhi	101.16 CosPhi (page 65).	11
	Ambient temperature	101.70 Ambient temperature % (page 67).	14
	Reactive power %	101.15 Reactive power % (page 65).	17
	Other	The value is taken from another parameter.	-
136.02	PVL filter time	Peak value logger filtering time. See parameter 136.01 PVL signal source .	2.00 s
	0.00 ... 120.00 s	Peak value logger filtering time.	100 = 1 s
136.06	AL2 signal source	Selects the signal to be monitored by amplitude logger 2. The signal is sampled at 200-millisecond intervals when the IGBT supply unit is running. The results are displayed by parameters 136.40...136.49 . Each parameter represents an amplitude range, and shows what portion of the samples fall within that range. The signal value corresponding to 100% is defined by parameter 136.07 AL2 signal scaling . Amplitude logger 2 can be reset using parameter 136.09 Reset loggers . The date and time of the last reset are stored into parameters 136.50 and 136.51 respectively. For the selections, see parameter 136.01 PVL signal source .	Ambient temperature
136.07	AL2 signal scaling	Defines the signal value that corresponds to 100% amplitude.	100.00
	0.00 ... 32767.00	Signal value corresponding to 100%.	1 = 1
136.09	Reset loggers	Resets the peak value logger and/or amplitude logger 2. (Amplitude logger 1 cannot be reset.)	Done
	Done	Reset completed or not requested (normal operation).	0
	All	Reset both the peak value logger and amplitude logger 2.	1
	PVL	Reset the peak value logger.	2
	AL2	Reset amplitude logger 2.	3
136.10	PVL peak value	Peak value recorded by the peak value logger.	0.00
	-32768.00 ... 32767.00	Peak value.	1 = 1
136.11	PVL peak date	The date on which the peak value was recorded.	-
	-	Peak occurrence date.	-
136.12	PVL peak time	The time at which the peak value was recorded.	-
	-	Peak occurrence time.	-
136.13	PVL current at peak	Line current at the moment the peak value was recorded.	0.00 A
	-32768.00 ... 32767.00 A	Line current at peak.	1 = 1 A
136.14	PVL DC voltage at peak	Voltage in the intermediate DC circuit at the moment the peak value was recorded.	0.00 V
	0.00 ... 2000.00 V	DC voltage at peak.	10 = 1 V
136.15	PVL power at peak	Power at the moment the peak value was recorded.	0.00 kW
	-32768.00 ... 32767.00 kW	Power at peak.	1 = 1 kW
136.16	PVL reset date	The date on which the peak value logger was last reset.	-
	-	Last reset date of the peak value logger.	-
136.17	PVL reset time	The time at which the peak value logger was last reset.	-
	-	Last reset time of the peak value logger.	-

146 Parameters

No.	Name/Value	Description	Def/FbEq16
136.20	<i>AL1 below 10%</i>	Percentage of samples recorded by amplitude logger 1 that fall between 0 and 10%.	0.00%
	0.00 ... 100.00%	Amplitude logger 1 samples between 0 and 10%.	1 = 1%
136.21	<i>AL1 10 to 20%</i>	Percentage of samples recorded by amplitude logger 1 that fall between 10 and 20%.	0.00%
	0.00 ... 100.00%	Amplitude logger 1 samples between 10 and 20%.	1 = 1%
136.22	<i>AL1 20 to 30%</i>	Percentage of samples recorded by amplitude logger 1 that fall between 20 and 30%.	0.00%
	0.00 ... 100.00%	Amplitude logger 1 samples between 20 and 30%.	1 = 1%
136.23	<i>AL1 30 to 40%</i>	Percentage of samples recorded by amplitude logger 1 that fall between 30 and 40%.	0.00%
	0.00 ... 100.00%	Amplitude logger 1 samples between 30 and 40%.	1 = 1%
136.24	<i>AL1 40 to 50%</i>	Percentage of samples recorded by amplitude logger 1 that fall between 40 and 50%.	0.00%
	0.00 ... 100.00%	Amplitude logger 1 samples between 40 and 50%.	1 = 1%
136.25	<i>AL1 50 to 60%</i>	Percentage of samples recorded by amplitude logger 1 that fall between 50 and 60%.	0.00%
	0.00 ... 100.00%	Amplitude logger 1 samples between 50 and 60%.	1 = 1%
136.26	<i>AL1 60 to 70%</i>	Percentage of samples recorded by amplitude logger 1 that fall between 60 and 70%.	0.00%
	0.00 ... 100.00%	Amplitude logger 1 samples between 60 and 70%.	1 = 1%
136.27	<i>AL1 70 to 80%</i>	Percentage of samples recorded by amplitude logger 1 that fall between 70 and 80%.	0.00%
	0.00 ... 100.00%	Amplitude logger 1 samples between 70 and 80%.	1 = 1%
136.28	<i>AL1 80 to 90%</i>	Percentage of samples recorded by amplitude logger 1 that fall between 80 and 90%.	0.00%
	0.00 ... 100.00%	Amplitude logger 1 samples between 80 and 90%.	1 = 1%
136.29	<i>AL1 over 90%</i>	Percentage of samples recorded by amplitude logger 1 that exceed 90%.	0.00%
	0.00 ... 100.00%	Amplitude logger 1 samples over 90%.	1 = 1%
136.40	<i>AL2 below 10%</i>	Percentage of samples recorded by amplitude logger 2 that fall between 0 and 10%.	0.00%
	0.00 ... 100.00%	Amplitude logger 2 samples between 0 and 10%.	1 = 1%
136.41	<i>AL2 10 to 20%</i>	Percentage of samples recorded by amplitude logger 2 that fall between 10 and 20%.	0.00%
	0.00 ... 100.00%	Amplitude logger 2 samples between 10 and 20%.	1 = 1%
136.42	<i>AL2 20 to 30%</i>	Percentage of samples recorded by amplitude logger 2 that fall between 20 and 30%.	0.00%
	0.00 ... 100.00%	Amplitude logger 2 samples between 20 and 30%.	1 = 1%
136.43	<i>AL2 30 to 40%</i>	Percentage of samples recorded by amplitude logger 2 that fall between 30 and 40%.	0.00%
	0.00 ... 100.00%	Amplitude logger 2 samples between 30 and 40%.	1 = 1%
136.44	<i>AL2 40 to 50%</i>	Percentage of samples recorded by amplitude logger 2 that fall between 40 and 50%.	0.00%
	0.00 ... 100.00%	Amplitude logger 2 samples between 40 and 50%.	1 = 1%
136.45	<i>AL2 50 to 60%</i>	Percentage of samples recorded by amplitude logger 2 that fall between 50 and 60%.	0.00%
	0.00 ... 100.00%	Amplitude logger 2 samples between 50 and 60%.	1 = 1%
136.46	<i>AL2 60 to 70%</i>	Percentage of samples recorded by amplitude logger 2 that fall between 60 and 70%.	0.00%
	0.00 ... 100.00%	Amplitude logger 2 samples between 60 and 70%.	1 = 1%

No.	Name/Value	Description	Def/FbEq16
136.47	<i>AL2 70 to 80%</i>	Percentage of samples recorded by amplitude logger 2 that fall between 70 and 80%.	0.00%
	0.00 ... 100.00%	Amplitude logger 2 samples between 70 and 80%.	1 = 1%
136.48	<i>AL2 80 to 90%</i>	Percentage of samples recorded by amplitude logger 2 that fall between 80 and 90%.	0.00%
	0.00 ... 100.00%	Amplitude logger 2 samples between 80 and 90%.	1 = 1%
136.49	<i>AL2 over 90%</i>	Percentage of samples recorded by amplitude logger 2 that exceed 90%.	0.00%
	0.00 ... 100.00%	Amplitude logger 2 samples over 90%.	1 = 1%
136.50	<i>AL2 reset date</i>	The date on which amplitude logger 2 was last reset.	-
	-	Last reset date of amplitude logger 2.	-
136.51	<i>AL2 reset time</i>	The time at which amplitude logger 2 was last reset.	-
	-	Last reset time of amplitude logger 2.	-
146 Monitoring settings		Scaling settings.	
146.01	<i>Power scaling</i>	Defines the power and also active current and percent reference depending on parameter <i>122.06 Power ref type</i> , that corresponds to 10000 for fieldbus communication with Transparent 16 profile. Also defines the 16-bit scaling of <i>101.04 Active current</i> , <i>101.12 Power</i> , <i>122.01 User Power ref</i> , <i>122.03 Power ref 1</i> , <i>122.05 Power ref 2</i> and <i>122.10 Power ref</i> .	10000.0
	0.1...30000.0	Power, active current and percent reference.	1 = 1
146.02	<i>Reactive power scaling</i>	Defines the reactive power and also reactive current and percent reference depending on parameter <i>124.06 Q power ref type</i> , that corresponds to 10000 for fieldbus communication with Transparent 16 profile. Also defines the 16-bit scaling of <i>101.06 Reactive current</i> , <i>101.14 Reactive power</i> , <i>124.01 User Qref</i> , <i>124.03 Qref 1</i> , <i>124.05 Qref 2</i> and <i>124.10 Q power ref</i> .	10000.0
	0.1...30000.0	Reactive power, reactive current and percent reference.	1 = 1
146.03	<i>Current scaling</i>	Defines the 16-bit scaling of signals <i>101.02 Line current</i> and <i>101.20 Converter current</i> . The value is scaled by dividing the value of this parameter by 10000.	10000 A
	0...30000 A	Current scaling.	-
146.04	<i>DC voltage scaling</i>	Defines the DC voltage that corresponds to 10000 for fieldbus communication with Transparent 16 profile. Also defines the 16-bit scaling of <i>123.01 User DC voltage ref</i> , <i>123.03 DC voltage ref 1</i> , <i>123.05 DC voltage ref 2</i> , <i>123.08 DC voltage ref lim</i> and <i>123.11 DC voltage ref out</i> .	100.00 V
	0.10...30000.00 V	DC voltage.	1 = 1 V
146.15	<i>Filter time grid current</i>	Defines the filter time for signals <i>101.02 Line current</i> , <i>101.03 Line current %</i> , <i>101.04 Active current</i> , <i>101.05 Active current %</i> , <i>101.06 Reactive current</i> and <i>101.07 Reactive current %</i> .	40 ms
	20...20000 ms	Filter time.	1 = 1 ms
146.16	<i>Filter time grid voltage</i>	Defines the filter time for signal <i>101.09 Grid voltage</i> .	40 ms
	20...20000 ms	Filter time.	1 = 1 ms
146.17	<i>Filter time grid power</i>	Defines the filter time for signals <i>101.10 Apparent power</i> , <i>101.11 Apparent power %</i> , <i>101.12 Power</i> , <i>101.13 Power %</i> , <i>101.14 Reactive power</i> and <i>101.15 Reactive power %</i> .	40 ms
	20...20000 ms	Filter time.	1 = 1 ms

148 Parameters

No.	Name/Value	Description	Def/FbEq16
147 Data storage		Parameters that can be written to and read from by using source and target settings of other parameters. Note that there are different storage parameters for different data types. See also section Data storage parameters (page 42).	
147.01	Data storage 1 <i>real32</i>	Data storage parameter 1.	0.000
	-2147483.000 ...2147483.000	32-bit real type data.	-
147.02	Data storage 2 <i>real32</i>	Data storage parameter 2.	0.000
	-2147483.000 ...2147483.000	32-bit real type data.	-
147.03	Data storage 3 <i>real32</i>	Data storage parameter 3.	0.000
	-2147483.000 ...2147483.000	32-bit real type data.	-
147.04	Data storage 4 <i>real32</i>	Data storage parameter 4.	0.000
	-2147483.000 ...2147483.000	32-bit real type data.	-
147.05	Data storage 5 <i>real32</i>	Data storage parameter 5.	0.000
	-2147483.000 ...2147483.000	32-bit real type data.	-
147.06	Data storage 6 <i>real32</i>	Data storage parameter 6.	0.000
	-2147483.000 ...2147483.000	32-bit real type data.	-
147.07	Data storage 7 <i>real32</i>	Data storage parameter 7.	0.000
	-2147483.000 ...2147483.000	32-bit real type data.	-
147.08	Data storage 8 <i>real32</i>	Data storage parameter 8.	0.000
	-2147483.000 ...2147483.000	32-bit real type data.	-
147.11	Data storage 1 <i>int32</i>	Data storage parameter 9.	0
	-2147483648... 2147483647	32-bit integer type data.	-
147.12	Data storage 2 <i>int32</i>	Data storage parameter 10.	0
	-2147483648... 2147483647	32-bit integer type data.	-
147.13	Data storage 3 <i>int32</i>	Data storage parameter 11.	0
	-2147483648... 2147483647	32-bit integer type data.	-
147.14	Data storage 4 <i>int32</i>	Data storage parameter 12.	0
	-2147483648... 2147483647	32-bit integer type data.	-
147.15	Data storage 5 <i>int32</i>	Data storage parameter 13.	0
	-2147483648... 2147483647	32-bit integer type data.	-

No.	Name/Value	Description	Def/FbEq16
147.16	Data storage 6 int32	Data storage parameter 14.	0
	-2147483648... 2147483647	32-bit integer type data.	-
147.17	Data storage 7 int32	Data storage parameter 15.	0
	-2147483648... 2147483647	32-bit integer type data.	-
147.18	Data storage 8 int32	Data storage parameter 16.	0
	-2147483648... 2147483647	32-bit integer type data.	-
147.21	Data storage 1 int16	Data storage parameter 17.	0
	-32768...32767	16-bit integer type data.	1 = 1
147.22	Data storage 2 int16	Data storage parameter 18.	0
	-32768...32767	16-bit integer type data.	1 = 1
147.23	Data storage 3 int16	Data storage parameter 19.	0
	-32768...32767	16-bit integer type data.	1 = 1
147.24	Data storage 4 int16	Data storage parameter 20.	0
	-32768...32767	16-bit integer type data.	1 = 1
147.25	Data storage 5 int16	Data storage parameter 21.	0
	-32768...32767	16-bit integer type data.	1 = 1
147.26	Data storage 6 int16	Data storage parameter 22.	0
	-32768...32767	16-bit integer type data.	1 = 1
147.27	Data storage 7 int16	Data storage parameter 23.	0
	-32768...32767	16-bit integer type data.	1 = 1
147.28	Data storage 8 int16	Data storage parameter 24.	0
	-32768...32767	16-bit integer type data.	1 = 1
147.31	Data storage 1 real32 type	Defines the scaling of parameter 147.01 Data storage 1 real32 to and from 16-bit integer format. This scaling is used when the data storage parameter is the target of received 16-bit data (defined in parameter group 162 DDCS receive), or when the data storage parameter is the source of transmitted 16-bit data (defined in parameter group 161 DDCS transmit). The setting also defines the visible range of the storage parameter.	<i>Unscaled</i>
	Unscaled	Data storage only. Range: -2147483.264 ... 2147473.264.	0
	Transparent	Scaling: 1 = 1. Range: -32768 ... 32767.	1
	General	Scaling: 1 = 100. Range: -327.68 ... 327.67.	2
147.32	Data storage 2 real32 type	Defines the 16-bit scaling of parameter 147.02 Data storage 2 real32 . See parameter 147.31 Data storage 1 real32 type .	<i>Unscaled</i>
147.33	Data storage 3 real32 type	Defines the 16-bit scaling of parameter 147.03 Data storage 3 real32 . See parameter 147.31 Data storage 1 real32 type .	<i>Unscaled</i>
147.34	Data storage 4 real32 type	Defines the 16-bit scaling of parameter 147.04 Data storage 4 real32 . See parameter 147.31 Data storage 1 real32 type .	<i>Unscaled</i>
147.35	Data storage 5 real32 type	Defines the 16-bit scaling of parameter 147.05 Data storage 5 real32 . See parameter 147.31 Data storage 1 real32 type .	<i>Unscaled</i>
147.36	Data storage 6 real32 type	Defines the 16-bit scaling of parameter 147.06 Data storage 6 real32 . See parameter 147.31 Data storage 1 real32 type .	<i>Unscaled</i>

150 Parameters

No.	Name/Value	Description	Def/FbEq16
147.37	<i>Data storage 7 real32 type</i>	Defines the 16-bit scaling of parameter <i>147.07 Data storage 7 real32</i> . See parameter <i>147.31 Data storage 1 real32 type</i> .	<i>Unscaled</i>
147.38	<i>Data storage 8 real32 type</i>	Defines the 16-bit scaling of parameter <i>147.08 Data storage 8 real32</i> . See parameter <i>147.31 Data storage 1 real32 type</i> .	<i>Unscaled</i>
149 Panel port communication		Communication settings for the control panel port.	
149.01	<i>Node ID number</i>	Defines the node ID of the supply unit. All devices connected to the network must have a unique node ID. Note: After setting this parameter, validate the change by setting the parameter <i>149.06 Refresh settings</i> to <i>Configure</i> . Note: For networked converters, it is advisable to reserve ID 1 for spare/replacement converters.	2
	1...32	Node ID.	1 = 1
149.03	<i>Baud rate</i>	Selects the maximum transfer rate of the link. Note: Reliability of the communication may require lower setting, depending of the electrical characteristics of the wiring.	<i>230.4 kbps</i>
	9.6 kbps	9.6 kbit/s.	0
	38.4 kbps	38.4 kbit/s.	1
	57.6 kbps	57.6 kbit/s.	2
	86.4 kbps	86.4 kbit/s.	3
	115.2 kbps	115.2 kbit/s.	4
	230.4 kbps	230.4 kbit/s.	5
	460.8 kbps	460.8 kbit/s.	6
	921.6 kbps	921.6 kbit/s.	7
149.04	<i>Communication loss time</i>	Sets a timeout for control panel (or PC tool) communication. If a communication break lasts longer than the timeout, the action specified by parameter <i>149.05 Communication loss action</i> is taken.	10.0 s
	0.3...3000.0 s	Panel/PC tool communication timeout.	10 = 1 s
149.05	<i>Communication loss action</i>	Selects how the supply unit reacts to a control panel (or PC tool) communication break.	<i>Fault</i>
	No action	No action taken.	0
	Fault	Supply unit trips on <i>7E01 Panel loss</i> .	1
149.06	<i>Refresh settings</i>	Applies the settings of parameters <i>149.01...149.05</i> . Note: Refreshing may cause a communication break, so reconnecting may be required.	<i>Done</i>
	Done	Refresh done or not requested.	0
	Configure	Refresh parameters <i>149.01...149.05</i> . The value reverts automatically to <i>Done</i> .	1
150 FBA		General settings for fieldbus communication configuration.	
150.01	<i>FBA A enable</i>	Enables/disables communication between the IGBT supply unit and fieldbus adapter A, and specifies the slot the adapter is installed into.	<i>Disable</i>
	Disable	Communication between IGBT supply unit and fieldbus adapter A disabled.	0
	Option slot 1	Communication between IGBT supply unit and fieldbus adapter A enabled. The adapter is in slot 1.	1
	Option slot 2	Communication between IGBT supply unit and fieldbus adapter A enabled. The adapter is in slot 2.	2

No.	Name/Value	Description	Def/FbEq16
	Option slot 3	Communication between IGBT supply unit and fieldbus adapter A enabled. The adapter is in slot 3.	3
150.02	<i>FBA A comm loss func</i>	Selects how the IGBT supply unit reacts upon a fieldbus communication loss. The time delay is defined by parameter 150.03 FBA A comm loss t out .	<i>No action</i>
	No action	No action taken.	0
	Fault	Communication loss detection active. Upon a communication loss, the IGBT supply unit trips on a 7E0B FBA A communication fault and stops.	1
	Fault always	IGBT supply unit trips on 7E0B FBA A communication . This occurs even though no control is expected from the fieldbus.	2
	Warning	IGBT supply unit generates an AE30 FBA A communication warning. This occurs even though no control is expected from the fieldbus.  WARNING! Make sure that it is safe to continue operation in case of a communication break.	3
150.03	<i>FBA A comm loss t out</i>	Defines the time delay before the action defined by parameter 150.02 FBA A comm loss func is taken. Time count starts when the communication link fails to update the message.	0.3 s
	0.3 ... 6553.5 s	Time delay.	10 = 1 s
150.04	<i>FBA A ref1 type</i>	Selects the type and scaling of reference 1 received from fieldbus adapter A.	<i>Auto</i>
	Auto	Type and scaling is chosen automatically according to the currently active operation mode.	0
	Transparent	No scaling is applied.	1
	General	Generic reference without a specific unit.	2
	Frequency	Reserved.	5
	DC voltage	The scaling is defined by parameter 146.04 DC voltage scaling .	8
	Active power	The scaling is defined by parameter 146.01 Power scaling .	9
	Reactive power	The scaling is defined by parameter 146.02 Reactive power scaling .	10
	AC Voltage	Reserved.	13
150.05	<i>FBA A ref2 type</i>	Selects the type and scaling of reference 2 received from fieldbus adapter A. For the selections, see parameter 150.04 FBA A ref1 type .	<i>Auto</i>
150.07	<i>FBA A actual1 type</i>	Selects the type and scaling of actual value 1 transmitted to the fieldbus network through fieldbus adapter A. For the selections, see parameter 150.04 FBA A ref1 type .	<i>Auto</i>
150.08	<i>FBA A actual2 type</i>	Selects the type and scaling of actual value 2 transmitted to the fieldbus network through fieldbus adapter A. For the selections, see parameter 150.04 FBA A ref1 type .	<i>Auto</i>
150.10	<i>FBA A act1 transparent source</i>	Selects the type of actual value 1 transmitted to the fieldbus network through fieldbus adapter A.	<i>Not selected</i>
	Not selected	No source selected.	-
	<i>Other</i>	The value is taken from another parameter.	-
150.11	<i>FBA A act2 transparent source</i>	Selects the type of actual value 2 transmitted to the fieldbus network through fieldbus adapter A.	<i>Not selected</i>
	Not selected	No source selected.	-
	<i>Other</i>	The value is taken from another parameter.	-

152 Parameters

No.	Name/Value	Description	Def/FbEq16															
150.12	<i>FBA A debug mode</i>	Enables the display of raw (unmodified) data received from and sent to fieldbus adapter A in parameters 150.13...150.18 . Note that the changes made take effect only after reboot or setting the parameter 151.27 FBA A par refresh to <i>Configure</i> . This functionality should only be used for debugging.	<i>Disable</i>															
	Disable	Display of raw data from fieldbus adapter A disabled.	0															
	Fast	Debug mode is enabled. Cyclical data update is as fast as possible which increases the CPU load on the IGBT supply unit.	1															
150.13	<i>FBA A control word</i>	Displays the control word sent by the master (PLC) to fieldbus adapter A. For details of the contents, see page 260 . This parameter is read-only.	-															
	0000h...FFFFh	Control word sent by master to fieldbus adapter A.	-															
150.14	<i>FBA A reference 1</i>	Displays raw reference REF1 sent by the master (PLC) to fieldbus adapter A. This parameter is read-only.	-															
	-2147483648... 2147483647	Raw REF1 sent by master to fieldbus adapter A.	-															
150.15	<i>FBA A reference 2</i>	Displays raw reference REF2 sent by the master (PLC) to fieldbus adapter A. This parameter is read-only.	-															
	-2147483648... 2147483647	Raw REF2 sent by master to fieldbus adapter A.	-															
150.16	<i>FBA A status word</i>	Displays the status word sent by fieldbus adapter A to the master (PLC). For details of the contents, see page 261 . This parameter is read-only.	-															
	0000h...FFFFh	Status word sent by fieldbus adapter A to master.	-															
150.17	<i>FBA A actual value 1</i>	Displays raw actual value ACT1 sent by fieldbus adapter A to the master (PLC). This parameter is read-only.	-															
	-2147483648... 2147483647	Raw ACT1 sent by fieldbus adapter A to master.	-															
150.18	<i>FBA A actual value 2</i>	Displays raw actual value ACT2 sent by fieldbus adapter A to the master (PLC). This parameter is read-only.	-															
	-2147483648... 2147483647	Raw ACT2 sent by fieldbus adapter A to master.	-															
150.21	<i>FBA A timelevel sel</i>	Selects the communication speed. In general, lower speeds reduce CPU load. The table below shows the read/write intervals for cyclic and acyclic data with each parameter setting. <table border="1" data-bbox="512 1671 1107 1823"> <thead> <tr> <th>Selection</th> <th>Cyclic*</th> <th>Acyclic**</th> </tr> </thead> <tbody> <tr> <td><i>Monitoring</i></td> <td>10 ms</td> <td>10 ms</td> </tr> <tr> <td><i>Normal</i></td> <td>2 ms</td> <td>10 ms</td> </tr> <tr> <td><i>Fast</i></td> <td>500 µs</td> <td>2 ms</td> </tr> <tr> <td><i>Very fast</i></td> <td>250 µs</td> <td>500 µs</td> </tr> </tbody> </table> *Cyclic data consists of fieldbus Control and Status words, Ref1, Ref2, Act1 and Act2. **Acyclic data consists of the parameter data mapped to parameter groups 152 FBA A data in and 153 FBA A data out .	Selection	Cyclic*	Acyclic**	<i>Monitoring</i>	10 ms	10 ms	<i>Normal</i>	2 ms	10 ms	<i>Fast</i>	500 µs	2 ms	<i>Very fast</i>	250 µs	500 µs	<i>Normal</i>
Selection	Cyclic*	Acyclic**																
<i>Monitoring</i>	10 ms	10 ms																
<i>Normal</i>	2 ms	10 ms																
<i>Fast</i>	500 µs	2 ms																
<i>Very fast</i>	250 µs	500 µs																
	Normal	Normal speed.	0															
	Fast	Fast speed.	1															

No.	Name/Value	Description	Def/FbEq16
	Very fast	Very fast speed.	2
	Monitoring	Low speed. Optimized for PC tool communication and monitoring usage.	3
150.31	<i>FBA B enable</i>	Enables/disables communication between the IGBT supply unit and fieldbus adapter B, and specifies the slot the adapter is installed into.	<i>Disable</i>
	Disable	Communication between IGBT supply unit and fieldbus adapter B disabled.	0
	Option slot 1	Communication between IGBT supply unit and fieldbus adapter B enabled. The adapter is in slot 1.	1
	Option slot 2	Communication between IGBT supply unit and fieldbus adapter B enabled. The adapter is in slot 2.	2
	Option slot 3	Communication between IGBT supply unit and fieldbus adapter B enabled. The adapter is in slot 3.	3
150.32	<i>FBA B comm loss func</i>	Selects how the IGBT supply unit reacts upon a fieldbus communication break. The time delay is defined by parameter 150.33 FBA B comm loss timeout .	<i>No action</i>
	No action	No action taken.	0
	Fault	Communication loss detection active. Upon a communication loss, the IGBT supply unit trips on a 7E0C FBA B communication fault and stops.	1
	Fault always	IGBT supply unit trips on 7E0C FBA B communication . This occurs even though no control is expected from the fieldbus.	2
	Warning	IGBT supply unit generates an AE31 FBA B communication warning. This occurs even though no control is expected from the fieldbus.  WARNING! Make sure that it is safe to continue operation in case of a communication break.	3
150.33	<i>FBA B comm loss timeout</i>	Defines the time delay before the action defined by parameter 150.32 FBA B comm loss func is taken. Time count starts when the communication link fails to update the message.	0.3 s
	0.3 ... 6553.5 s	Time delay.	10 = 1 s
150.34	<i>FBA B ref1 type</i>	Selects the type and scaling of reference 1 received from fieldbus adapter B. For the selections, see parameter 150.04 FBA A ref1 type .	<i>Auto</i>
150.35	<i>FBA B ref2 type</i>	Selects the type and scaling of reference 2 received from fieldbus adapter B. For the selections, see parameter 150.05 FBA A ref2 type .	<i>Auto</i>
150.36	<i>FBA B SW sel</i>	Selects the source of the Status word to be sent to the fieldbus network through fieldbus adapter B.	<i>Auto</i>
	Auto	Source of the Status word is chosen automatically.	0
	Transparent mode	The source selected by parameter 150.39 FBA B SW transparent source is transmitted as the Status word to the fieldbus network through fieldbus adapter B.	1
150.37	<i>FBA B actual 1 type</i>	Selects the type and scaling of actual value 1 transmitted to the fieldbus network through fieldbus adapter B. For the selections, see parameter 150.07 FBA A actual1 type .	<i>Auto</i>
150.38	<i>FBA B actual 2 type</i>	Selects the type and scaling of actual value 2 transmitted to the fieldbus network through fieldbus adapter B. For the selections, see parameter 150.08 FBA A actual2 type .	<i>Auto</i>
150.39	<i>FBA B SW transparent source</i>	Selects the source of the fieldbus status word when parameter 150.36 FBA B SW sel is set to <i>Transparent mode</i> .	<i>Not selected</i>
	Not selected	No source selected.	-
	<i>Other</i>	The value is taken from another parameter.	-

154 Parameters

No.	Name/Value	Description	Def/FbEq16
150.40	<i>FBA B act1 transparent source</i>	When parameter 150.37 FBA B actual 1 type is set to <i>Transparent mode</i> , this parameter selects the type of actual value 1 transmitted to the fieldbus network through fieldbus adapter B.	<i>Not selected</i>
	Not selected	No source selected.	-
	<i>Other</i>	The value is taken from another parameter.	-
150.41	<i>FBA B act2 transparent source</i>	Selects the type of actual value 2 transmitted to the fieldbus network through fieldbus adapter B.	<i>Not selected</i>
	Not selected	No source selected.	-
	<i>Other</i>	The value is taken from another parameter.	-
150.42	<i>FBA B debug mode</i>	Enables the display of raw (unmodified) data received from and sent to fieldbus adapter B in parameters 150.43...150.48 . Note that the changes made take effect only after reboot or setting the parameter 154.27 FBA B par refresh to <i>Configure</i> . This functionality should only be used for debugging.	<i>Disable</i>
	Disable	Display of raw data from fieldbus adapter B disabled.	0
	Fast	Debug mode is enabled. Cyclical data update is as fast as possible which increases the CPU load on the IGBT supply unit.	1
150.43	<i>FBA B control word</i>	Displays the raw (unmodified) control word sent by the master (PLC) to fieldbus adapter B if debugging is enabled by parameter 150.42 FBA B debug mode . This parameter is read-only.	-
	00000000h ... FFFFFFFFh	Control word sent by master to fieldbus adapter B.	-
150.44	<i>FBA B reference 1</i>	Displays the raw (unmodified) reference REF1 sent by the master (PLC) to fieldbus adapter B if debugging is enabled by parameter 150.42 FBA B debug mode . This parameter is read-only.	-
	-2147483648... 2147483647	Raw REF1 sent by master to fieldbus adapter B.	-
150.45	<i>FBA B reference 2</i>	Displays the raw (unmodified) reference REF2 sent by the master (PLC) to fieldbus adapter B if debugging is enabled by parameter 150.42 FBA B debug mode . This parameter is read-only.	-
	-2147483648... 2147483647	Raw REF2 sent by master to fieldbus adapter B.	-
150.46	<i>FBA B status word</i>	Displays the raw (unmodified) status word sent by fieldbus adapter B to the master (PLC) if debugging is enabled by parameter 150.42 FBA B debug mode . This parameter is read-only.	-
	00000000h ... FFFFFFFFh	Status word sent by fieldbus adapter B to master.	-
150.47	<i>FBA B actual value 1</i>	Displays the raw (unmodified) actual value ACT1 sent by fieldbus adapter B to the master (PLC) if debugging is enabled by parameter 150.42 FBA B debug mode . This parameter is read-only.	-
	-2147483648 ... 2147483647	Raw ACT1 sent by fieldbus adapter B to master.	-

No.	Name/Value	Description	Def/FbEq16															
150.48	<i>FBA B actual value 2</i>	Displays the raw (unmodified) actual value ACT2 sent by fieldbus adapter B to the master (PLC) if debugging is enabled by parameter <i>150.42 FBA B debug mode</i> . This parameter is read-only.	-															
	-2147483648 ... 2147483647	Raw ACT2 sent by fieldbus adapter B to master.	-															
150.51	<i>FBA B timelevel sel</i>	Selects the communication speed. In general, lower speeds reduce CPU load. The table below shows the read/write intervals for cyclic and acyclic data with each parameter setting. <table border="1" data-bbox="683 607 1278 757"> <thead> <tr> <th>Selection</th> <th>Cyclic*</th> <th>Acyclic**</th> </tr> </thead> <tbody> <tr> <td><i>Monitoring</i></td> <td>10 ms</td> <td>10 ms</td> </tr> <tr> <td><i>Normal</i></td> <td>2 ms</td> <td>10 ms</td> </tr> <tr> <td><i>Fast</i></td> <td>500 µs</td> <td>2 ms</td> </tr> <tr> <td><i>Very fast</i></td> <td>250 µs</td> <td>500 µs</td> </tr> </tbody> </table> *Cyclic data consists of fieldbus Control and Status words, Ref1, Ref2, Act1 and Act2. **Acyclic data consists of the parameter data mapped to parameter groups <i>155 FBA B data in</i> and <i>156 FBA B data out</i> .	Selection	Cyclic*	Acyclic**	<i>Monitoring</i>	10 ms	10 ms	<i>Normal</i>	2 ms	10 ms	<i>Fast</i>	500 µs	2 ms	<i>Very fast</i>	250 µs	500 µs	<i>Normal</i>
Selection	Cyclic*	Acyclic**																
<i>Monitoring</i>	10 ms	10 ms																
<i>Normal</i>	2 ms	10 ms																
<i>Fast</i>	500 µs	2 ms																
<i>Very fast</i>	250 µs	500 µs																
	Normal	Normal speed.	0															
	Fast	Fast speed.	1															
	Very fast	Very fast speed.	2															
	Monitoring	Low speed. Optimized for PC tool communication and monitoring usage.	3															
<i>151 FBA A settings</i>		Fieldbus adapter A configuration.																
151.01	<i>FBA A type</i>	Displays the type of the connected fieldbus adapter module. 0 = Module is not found or is not properly connected, or is disabled by parameter <i>150.01 FBA A enable</i> ; 1 = FPBA; 32 = FCAN; 37 = FDNA; 101 = FCNA; 128 = FENA-11/21; 132 = FPNO; 135 = FECA; 136 = FEPL; 485 = FSCA; 502 = FMBT; 2222 = FEIP; 62944 = FSEA. Note: All types of the fieldbus adapter modules are not necessarily supported yet. This parameter is read-only.	-															
151.02	<i>FBA A Par2</i>	Parameters <i>151.02...151.26</i> are adapter module-specific. For more information, see the documentation of the fieldbus adapter module. Note that not all of these parameters are necessarily in use. Note: In supply units only <i>Trans16</i> profile is in use.	-															
...															
151.26	<i>FBA A Par26</i>	See parameter <i>151.02 FBA A Par2</i> .	-															
151.27	<i>FBA A par refresh</i>	Validates any changed fieldbus adapter module configuration settings. After refreshing, the value reverts automatically to <i>Done</i> . Note: This parameter cannot be changed while the IGBT supply unit is running.	<i>Done</i>															
	Done	Refreshing done.	0															
	Configure	Refreshing.	1															

156 Parameters

No.	Name/Value	Description	Def/FbEq16
151.28	<i>FBA A par table ver</i>	Displays the parameter table revision of the fieldbus adapter module mapping file stored in the memory of the IGBT supply unit. In format axyz, where a = major revision number; xy = minor revision number; z = correction number. This parameter is read-only.	-
		Parameter table revision of adapter module.	1 = 1
151.29	<i>FBA A drive type code</i>	Displays the IGBT supply unit type code of the fieldbus adapter module mapping file stored in the memory of the IGBT supply unit. This parameter is read-only.	-
	0...65535	IGBT supply unit type code of fieldbus adapter module mapping file.	1 = 1
151.30	<i>FBA A mapping file ver</i>	Displays the fieldbus adapter module mapping file revision stored in the memory of the IGBT supply unit in decimal format. Example: Integer 263 -> 0x107 = revision 1.07 This parameter is read-only.	-
	0...65535	Mapping file revision.	1 = 1
151.31	<i>D2FBA A comm status</i>	Displays the status of the fieldbus adapter module communication.	-
	Idle	Adapter is not configured.	0
	Exec.init	Adapter is initializing.	1
	Time out	A timeout has occurred in the communication between the adapter and the IGBT supply unit.	2
	Conf.err	Adapter configuration error: the major or minor revision code of the common program revision in the fieldbus adapter module is not the revision required by the module (see parameter 151.32 FBA A comm SW ver), or mapping file upload has failed more than three times. Check also parameter 150.03 FBA A comm loss t out .	3
	Off-line	Adapter is off-line.	4
	On-line	Adapter is on-line.	5
	Reset	Adapter is performing a hardware reset.	6
151.32	<i>FBA A comm SW ver</i>	Displays the common program revision of the adapter module in format axyz, where a = major revision number, xy = minor revision number, z = correction number. Example: 190A = revision 1.90A.	-
		Common program revision of adapter module.	-
151.33	<i>FBA A appl SW ver</i>	Displays the application program revision of the adapter module in format axyz, where a = major revision number, xy = minor revision number, z = correction number or letter. Example: 190A = revision 1.90A.	-
		Application program version of adapter module.	-
152 FBA A data in		Selection of data to be transferred from IGBT supply unit to fieldbus controller through fieldbus adapter A. Note: 32-bit values require two consecutive parameters. Whenever a 32-bit value is selected in a data parameter, the next parameter is automatically reserved.	
152.01	<i>FBA A data in1</i>	Parameters 152.01 ... select data to be transferred from the IGBT supply unit to the fieldbus controller through fieldbus adapter A.	<i>None</i>
	None	None.	0
	CW 16bit	Control Word (16 bits)	1

No.	Name/Value	Description	Def/FbEq16
	Ref1 16bit	Reference 1 (16 bits)	2
	Ref2 16bit	Reference 2 (16 bits)	3
	SW 16bit	Status Word (16 bits)	4
	Act1 16bit	Actual value Act1 (16 bits)	5
	Act2 16bit	Actual value Act2 (16 bits)	6
	CW 32bit	Control Word (32 bits)	11
	Ref1 32bit	Reference 1 (32 bits)	12
	Ref2 32bit	Reference 2 (32 bits)	13
	SW 32bit	Status Word (32 bits)	14
	Act1 32bit	Actual value ACT1 (32 bits)	15
	Act2 32bit	Actual value ACT2 (32 bits)	16
	SW2 16bit	Status Word 2 (16 bits)	24
...	
152.12	FBA A data in12	See parameter 152.01 FBA A data in1 .	<i>None</i>
153 FBA A data out		Selection of data to be transferred from fieldbus controller to IGBT supply unit through fieldbus adapter A. Note: 32-bit values require two consecutive parameters. Whenever a 32-bit value is selected in a data parameter, the next parameter is automatically reserved.	
153.01	FBA data out1	Parameters 153.01 ... select data to be transferred from the fieldbus controller to the IGBT supply unit through fieldbus adapter A. Transfer speed can be set with parameter 150.21 FBA A timelevel sel .	<i>None</i>
	None	None.	0
	CW 16bit	Control Word (16 bits)	1
	Ref1 16bit	Reference Ref1 (16 bits)	2
	Ref2 16bit	Reference Ref2 (16 bits)	3
	CW 32bit	Control Word (32 bits)	11
	Ref1 32bit	Reference Ref1 (32 bits)	12
	Ref2 32bit	Reference Ref2 (32 bits)	13
	CW2 16bit	Control Word 2 (16 bits)	21
...
153.12	FBA data out12	See parameter 153.01 FBA data out1 .	<i>None</i>
154 FBA B settings		Fieldbus adapter B configuration.	
154.01	FBA B type	Displays the type of the connected fieldbus adapter module. 0 = Module is not found or is not properly connected, or is disabled by parameter 150.31 FBA B enable ; 1 = FPBA; 32 = FCAN; 37 = FDNA; 101 = FCNA; 128 = FENA-11/21; 132 = FPNO; 135 = FECA; 136 = FEPL; 485 = FSCA; 502 = FMBT; 2222 = FEIP; 62944 = FSEA.	-
154.02	FBA B Par2	Parameters 154.02 ... 154.26 are adapter module-specific. For more information, see the documentation of the fieldbus adapter module. Note that not all of these parameters are necessarily in use.	-
...
154.26	FBA B Par26	See parameter 154.02 FBA B Par2 .	-

No.	Name/Value	Description	Def/FbEq16
154.27	<i>FBA B par refresh</i>	Validates any changed fieldbus adapter module configuration settings. After refreshing, the value reverts automatically to <i>Done</i> . Note: This parameter cannot be changed while the IGBT supply unit is running.	<i>Done</i>
	Done	Refreshing done.	0
	Configure	Refreshing.	1
154.28	<i>FBA B par table ver</i>	Displays the parameter table revision of the fieldbus adapter module mapping file stored in the memory of the IGBT supply unit. In format axyz, where a = major revision number; xy = minor revision number; z = correction number. This parameter is read-only.	-
		Parameter table revision of adapter module.	1 = 1
154.29	<i>FBA B drive type code</i>	Displays the IGBT supply unit type code of the fieldbus adapter module mapping file stored in the memory of the IGBT supply unit. This parameter is read-only.	-
	0...65535	IGBT supply unit type code of fieldbus adapter module mapping file.	1 = 1
154.30	<i>FBA B mapping file ver</i>	Displays the fieldbus adapter module mapping file revision stored in the memory of the IGBT supply unit in decimal format. Example: Integer 263 -> 0x107 = revision 1.07 This parameter is read-only.	-
	0...65535	Mapping file revision.	1 = 1
154.31	<i>D2FBA B comm sta</i>	Displays the status of the fieldbus adapter module communication.	-
	Idle	Adapter is not configured.	0
	Exec.init	Adapter is initializing.	1
	Time out	A timeout has occurred in the communication between the adapter and the IGBT supply unit.	2
	Conf.err	Adapter configuration error: the major or minor revision code of the common program revision in the fieldbus adapter module is not the revision required by the module (see parameter 154.32 FBA B comm SW ver), or mapping file upload has failed more than three times. Check also parameter 150.33 FBA B comm loss timeout .	3
	Off-line	Adapter is off-line.	4
	On-line	Adapter is on-line.	5
	Reset	Adapter is performing a hardware reset.	6
154.32	<i>FBA B comm SW ver</i>	Displays the common program revision of the adapter module in format axyz, where a = major revision number, xy = minor revision number, z = correction number. Example: 190A = revision 1.90A.	-
		Common program revision of adapter module.	-
154.33	<i>FBA B appl SW ver</i>	Displays the application program revision of the adapter module in format axyz, where a = major revision number, xy = minor revision number, z = correction number or letter. Example: 190A = revision 1.90A.	-
		Application program version of adapter module.	-

No.	Name/Value	Description	Def/FbEq16
<i>155 FBA B data in</i>		Selection of data to be transferred from IGBT supply unit to fieldbus controller through fieldbus adapter B. Note: 32-bit values require two consecutive parameters. Whenever a 32-bit value is selected in a data parameter, the next parameter is automatically reserved.	
<i>155.01</i>	<i>FBA B data in1</i>	Parameters <i>155.01...155.12</i> select data to be transferred from the IGBT supply unit to the fieldbus controller through fieldbus adapter B.	<i>None</i>
	None	None.	0
	CW 16bit	Control Word (16 bits)	1
	Ref1 16bit	Reference 1 (16 bits)	2
	Ref2 16bit	Reference 2 (16 bits)	3
	SW 16bit	Status Word (16 bits)	4
	Act1 16bit	Actual value Act1 (16 bits)	5
	Act2 16bit	Actual value Act2 (16 bits)	6
	CW 32bit	Control Word (32 bits)	11
	Ref1 32bit	Reference 1 (32 bits)	12
	Ref2 32bit	Reference 2 (32 bits)	13
	SW 32bit	Status Word (32 bits)	14
	Act1 32bit	Actual value ACT1 (32 bits)	15
	Act2 32bit	Actual value ACT2 (32 bits)	16
	SW2 16bit	Status Word 2 (16 bits)	24
...	
<i>155.12</i>	<i>FBA B data in12</i>	See parameter <i>155.01 FBA B data in1</i> .	<i>None</i>
<i>156 FBA B data out</i>		Selection of data to be transferred from fieldbus controller to IGBT supply unit through fieldbus adapter B. Note: 32-bit values require two consecutive parameters. Whenever a 32-bit value is selected in a data parameter, the next parameter is automatically reserved.	
<i>156.01</i>	<i>FBA B data out1</i>	Parameters <i>156.01...156.12</i> select data to be transferred from the fieldbus controller to the IGBT supply unit through fieldbus adapter B. Transfer speed can be set with parameter <i>150.51 FBA B timelevel sel</i> .	<i>None</i>
	None	None.	0
	CW 16bit	Control Word (16 bits)	1
	Ref1 16bit	Reference Ref1 (16 bits)	2
	Ref2 16bit	Reference Ref2 (16 bits)	3
	CW 32bit	Control Word (32 bits)	11
	Ref1 32bit	Reference Ref1 (32 bits)	12
	Ref2 32bit	Reference Ref2 (32 bits)	13
	CW2 16bit	Control Word 2 (16 bits)	21
...
<i>156.12</i>	<i>FBA B data out12</i>	See parameter <i>156.01 FBA B data out1</i> .	<i>None</i>

160 Parameters

No.	Name/Value	Description	Def/FbEq16
160 DDCS communication			
		DDCS communication configuration. Fiber optic links connected to DDCS channels can be used to <ul style="list-style-type: none"> connect units together to build a master/follower network connect the converter to an external controller such as the AC500 PLC. See also section <i>DDCS communication with inverter unit</i> on page 45.	
160.01	<i>M/F communication port</i>	Selects the connection used by the master/follower functionality.	<i>No connect</i>
	No connect	None (communication disabled).	0
	Slot 1A	Channel A on FDCO module in slot 1 (with ZCU control unit only).	1
	Slot 2A	Channel A on FDCO module in slot 2 (with ZCU control unit only).	2
	Slot 3A	Channel A on FDCO module in slot 3 (with ZCU control unit only).	3
	Slot 1B	Channel B on FDCO module in slot 1 (with ZCU control unit only).	4
	Slot 2B	Channel B on FDCO module in slot 2 (with ZCU control unit only).	5
	Slot 3B	Channel B on FDCO module in slot 3 (with ZCU control unit only).	6
	RDCO CH 2	Channel 2 on RDCO module (with BCU control unit only).	12
	XD2D	Connector XD2D. Note: This connection cannot co-exist, and is not to be confused with, drive-to-drive (D2D) communication implemented by application programming (detailed in <i>Drive application programming manual (IEC 61131-3)</i> , 3AUA0000127808 [English]).	7
160.02	<i>M/F node address</i>	Selects the node address for master/follower communication. No two nodes on-line may have the same address. Note: The allowable addresses for the master are 0 and 1. The allowable addresses for followers are 2...60.	1
	1...254	Node address.	
160.03	<i>M/F mode</i>	Defines the role of the supply unit on the master/follower or drive-to-drive link.	<i>Not in use</i>
	Not in use	Master/follower functionality not active.	0
	DDCS master	The supply unit is the master on the master/follower (DDCS) link.	1
	DDCS follower	The supply unit is a follower on the master/follower (DDCS) link.	2
160.05	<i>M/F HW connection</i>	Selects the topology of the master/follower link. Note: Use the setting <i>Star</i> if using the master/follower functionality through the XD2D connector (as opposed to a fiber optic link).	<i>Ring</i>
	Ring	The devices are connected in a ring topology. Forwarding of messages is enabled.	0
	Star	The devices are connected in a star topology (for example, through a branching unit). Forwarding of messages is disabled.	1

No.	Name/Value	Description	Def/FbEq16
160.07	<i>M/F link control</i>	Defines the light intensity of the transmission LED of RDCO module channel CH2. (This parameter is effective only when parameter <i>160.01 M/F communication port</i> is set to <i>RDCO CH 2</i> . FDCO modules have a hardware transmitter current selector.) In general, use higher values with longer fiber optic cables. The maximum setting is applicable to the maximum length of the fiber optic link.	10
	1...15	Light intensity.	
160.08	<i>M/F comm loss timeout</i>	Sets a timeout for master/follower (DDCS) communication. If a communication break lasts longer than the timeout, the action specified by parameter <i>160.09 M/F comm loss function</i> is taken. As a rule of thumb, this parameter should be set to at least 3 times the transmit interval of the master.	100 ms
	0...65535 ms	Master/follower communication timeout.	1 = 1
160.09	<i>M/F comm loss function</i>	Selects how the supply unit reacts to a master/follower communication break.	<i>Fault</i>
	No action	No action taken.	0
	Warning	The supply unit generates an <i>AE81 MF comm loss</i> warning. This only occurs if control is expected from the master/follower link.  WARNING! Make sure that it is safe to continue operation in case of a communication break.	1
	Fault	The supply unit trips on a fault (<i>FE06 MF communication loss</i>). This only occurs if control is expected from the master/follower link.	2
	Fault always	The supply unit trips on a fault (<i>FE06 MF communication loss</i>). This occurs even though no control is expected from the master/follower link.	3
160.10	<i>M/F ref1 type</i>	Selects the type and scaling of reference 1 received from the master/follower link. The resulting value is shown by <i>103.13 M/F or D2D ref1</i> .	<i>Transparent</i>
	Auto	Type and scaling are chosen automatically according to which reference chain the incoming reference is connected to. If the reference is not connected to any chain, no scaling is applied (as with setting <i>Transparent</i>).	0
	Transparent	No scaling is applied.	1
	General	Generic reference with a scaling of 100 = 1 (ie. integer and two decimals).	2
	Frequency	Reserved.	5
	DC voltage	The scaling is defined by parameter <i>146.04 DC voltage scaling</i> .	8
	Active power	The scaling is defined by parameter <i>146.01 Power scaling</i> .	9
	Reactive power	The scaling is defined by parameter <i>146.02 Reactive power scaling</i> .	10
	AC Voltage	Reserved.	13
160.11	<i>M/F ref2 type</i>	Selects the type and scaling of reference 2 received from the master/follower link. The resulting value is shown by <i>103.14 M/F or D2D ref2</i> . For the selections, see parameter <i>160.10 M/F ref1 type</i> .	<i>Transparent</i>

162 Parameters

No.	Name/Value	Description	Def/FbEq16
160.12	<i>M/F act1 type</i>	Selects the type/source and scaling of actual value ACT1 transmitted to the master/follower link.	<i>Transparent</i>
	Auto	Type and scaling are chosen automatically according to which reference chain the incoming reference is connected to. If the reference is not connected to any chain, no scaling is applied (as with setting <i>Transparent</i>).	0
	Transparent	No scaling is applied.	1
	General	Generic reference with a scaling of 100 = 1 (ie. integer and two decimals).	2
	Frequency	Reserved.	5
	DC voltage	The scaling is defined by parameter <i>146.04 DC voltage scaling</i> .	8
	Active power	The scaling is defined by parameter <i>146.01 Power scaling</i> .	9
	Reactive power	The scaling is defined by parameter <i>146.02 Reactive power scaling</i> .	10
	AC Voltage	Reserved.	13
160.13	<i>M/F act2 type</i>	Selects the type/source and scaling of actual value ACT2 transmitted to the master/follower link. For the selections, see parameter <i>160.12 M/F act1 type</i> .	<i>Transparent</i>
160.14	<i>M/F follower selection</i>	(Effective in the master only.) Defines the followers from which data is read. See also parameters <i>162.28...162.33</i> .	<i>None</i>
	Follower node 2	Data is read from the follower with node address 2.	2
	Follower node 3	Data is read from the follower with node address 3.	4
	Follower node 4	Data is read from the follower with node address 4.	8
	Follower nodes 2+3	Data is read from the followers with node addresses 2 and 3.	6
	Follower nodes 2+4	Data is read from the followers with node addresses 2 and 4.	10
	Follower nodes 3+4	Data is read from the followers with node addresses 3 and 4.	12
	Follower nodes 2+3+4	Data is read from the followers with node addresses 2, 3 and 4.	14
	None	None.	0
160.17	<i>Follower fault action</i>	(Effective in the master only.) Selects how the drive reacts to a fault in a follower. See also parameter <i>160.23 M/F status supervision sel 1</i> . Note: Each follower must be configured to transmit its status word as one of the three data words in parameters <i>161.01...161.03</i> . In the master, the corresponding target parameter (<i>162.04...162.12</i>) must be set to <i>Follower SW</i> .	<i>Fault</i>
	No action	No action taken. Unaffected units on the master/follower link will continue running.	0
	Warning	The drive generates a warning (<i>AE82 Follower</i>).	1
	Fault	Drive trips on <i>FE07 Follower drive failure</i> . All followers will be stopped.	2
160.18	<i>Follower enable</i>	Interlocks the starting of the master to the status of the followers. See also parameter <i>160.23 M/F status supervision sel 1</i> . Note: Each follower must be configured to transmit its status word as one of the three data words in parameters <i>161.01...161.03</i> . In the master, the corresponding target parameter (<i>162.04...162.12</i>) must be set to <i>Follower SW</i> .	<i>Always</i>
	MSW bit 0	The master can only be started if all followers are ready to switch on (bit 0 of <i>106.11 Main status word</i> in each follower is on).	0
	MSW bit 1	The master can only be started if all followers are ready to operate (bit 1 of <i>106.11 Main status word</i> in each follower is on).	1

No.	Name/Value	Description	Def/FbEq16															
	MSW bits 0 + 1	The master can only be started if all followers are ready to switch on and ready to operate (bits 0 and 1 of 106.11 Main status word in each follower are on).	2															
	Always	The starting of the master is not interlocked to the status of the followers.	3															
	MSW bit 12	The master can only be started if user-definable bit 12 of 106.11 Main status word in each follower is on. See parameter 106.31 MSW bit 12 sel .	4															
	MSW bits 0 + 12	The master can only be started if both bit 0 and bit 12 of 106.11 Main status word in each follower are on.	5															
	MSW bits 1 + 12	The master can only be started if both bit 1 and bit 12 of 106.11 Main status word in each follower are on.	6															
160.23	M/F status supervision sel 1	<p>(This parameter is only effective when the supply unit is the master on a D2D link. See parameters 160.01 M/F communication port and 160.03 M/F mode.)</p> <p>In the master, parameter 160.23 M/F status supervision sel 1 specifies the followers whose status word is monitored by the master.</p> <p>This parameter selects the followers (out of followers 1...16) whose status words are monitored by the master.</p> <p>If a follower reports a fault (bit 3 of the status word is on), the action specified in 160.17 Follower fault action is taken. Bits 0 and 1 of the status word (ready states) are handled as defined by 160.18 Follower enable.</p> <p>Using 160.27 M/F status supervision sel 2, it is possible to define whether any given follower is only monitored when it is stopped.</p> <p>Note: The status of communication is shown by 162.37 M/F communication status 1 and 162.38 M/F communication status 2.</p>	-															
<table border="1"> <thead> <tr> <th>Bit</th> <th>Name</th> <th>Description</th> </tr> </thead> <tbody> <tr> <td>0</td> <td>Follower 1</td> <td>1 = Status of follower 1 is monitored.</td> </tr> <tr> <td>1</td> <td>Follower 2</td> <td>1 = Status of follower 2 is monitored.</td> </tr> <tr> <td>...</td> <td>...</td> <td>...</td> </tr> <tr> <td>15</td> <td>Follower 16</td> <td>1 = Status of follower 16 is monitored.</td> </tr> </tbody> </table>				Bit	Name	Description	0	Follower 1	1 = Status of follower 1 is monitored.	1	Follower 2	1 = Status of follower 2 is monitored.	15	Follower 16	1 = Status of follower 16 is monitored.
Bit	Name	Description																
0	Follower 1	1 = Status of follower 1 is monitored.																
1	Follower 2	1 = Status of follower 2 is monitored.																
...																
15	Follower 16	1 = Status of follower 16 is monitored.																
	0000h...FFFFh	D2D follower status supervision selection (followers 1...16).	1 = 1															
160.27	M/F status supervision sel 2	<p>In the D2D master, parameter 160.27 M/F status supervision sel 2 specifies the mode of follower status word monitoring. Each follower can individually be set to be monitored continuously, or only when it is in stopped state.</p> <p>This parameter selects the mode of status word monitoring of followers 17...32.</p>	-															
<table border="1"> <thead> <tr> <th>Bit</th> <th>Name</th> <th>Description</th> </tr> </thead> <tbody> <tr> <td>0</td> <td>Follower 17</td> <td>0 = Status of follower 17 is monitored continuously. 1 = Status of follower 17 is monitored only when it is in stopped state.</td> </tr> <tr> <td>1</td> <td>Follower 18</td> <td>0 = Status of follower 18 is monitored continuously. 1 = Status of follower 18 is monitored only when it is in stopped state.</td> </tr> <tr> <td>...</td> <td>...</td> <td>...</td> </tr> <tr> <td>15</td> <td>Follower 32</td> <td>0 = Status of follower 32 is monitored continuously. 1 = Status of follower 32 is monitored only when it is in stopped state.</td> </tr> </tbody> </table>				Bit	Name	Description	0	Follower 17	0 = Status of follower 17 is monitored continuously. 1 = Status of follower 17 is monitored only when it is in stopped state.	1	Follower 18	0 = Status of follower 18 is monitored continuously. 1 = Status of follower 18 is monitored only when it is in stopped state.	15	Follower 32	0 = Status of follower 32 is monitored continuously. 1 = Status of follower 32 is monitored only when it is in stopped state.
Bit	Name	Description																
0	Follower 17	0 = Status of follower 17 is monitored continuously. 1 = Status of follower 17 is monitored only when it is in stopped state.																
1	Follower 18	0 = Status of follower 18 is monitored continuously. 1 = Status of follower 18 is monitored only when it is in stopped state.																
...																
15	Follower 32	0 = Status of follower 32 is monitored continuously. 1 = Status of follower 32 is monitored only when it is in stopped state.																
	0000h...FFFFh	D2D status supervision mode selection 1.	1 = 1															

164 Parameters

No.	Name/Value	Description	Def/FbEq16
160.31	<i>M/F wake up delay</i>	Defines a wake-up delay during which no master/follower communication faults or warnings are generated. This is to allow all drives on the master/follower link to power up. The master cannot be started until the delay elapses or all monitored followers are found to be ready.	60.0 s
	0.0 ... 180.0 s	Master/follower wake-up delay.	10 = 1 s
160.41	<i>Extension adapter com port</i>	Selects the channel used for connecting an optional FEA-xx extension adapter.	<i>No connect</i>
	No connect	None (communication disabled).	0
	Slot 1A	Channel A on FDCO module in slot 1 (with ZCU control unit only).	1
	Slot 2A	Channel A on FDCO module in slot 2 (with ZCU control unit only).	2
	Slot 3A	Channel A on FDCO module in slot 3 (with ZCU control unit only).	3
	Slot 1B	Channel B on FDCO module in slot 1 (with ZCU control unit only).	4
	Slot 2B	Channel B on FDCO module in slot 2 (with ZCU control unit only).	5
	Slot 3B	Channel B on FDCO module in slot 3 (with ZCU control unit only).	6
	RDCO CH 3	Channel 3 on RDCO module (with BCU control unit only).	13
160.51	<i>DDCS controller comm port</i>	Selects the DDCS channel used for connecting an external controller (such as an AC500 PLC).	<i>No connect</i>
	No connect	None (communication disabled).	0
	Slot 1A	Channel A on FDCO module in slot 1 (with ZCU control unit only).	1
	Slot 2A	Channel A on FDCO module in slot 2 (with ZCU control unit only).	2
	Slot 3A	Channel A on FDCO module in slot 3 (with ZCU control unit only).	3
	Slot 1B	Channel B on FDCO module in slot 1 (with ZCU control unit only).	4
	Slot 2B	Channel B on FDCO module in slot 2 (with ZCU control unit only).	5
	Slot 3B	Channel B on FDCO module in slot 3 (with ZCU control unit only).	6
	DDCS via BC	Communication to the inverter module active (with ZCU control unit only).	7
	RDCO CH 0	Channel 0 on RDCO module (with BCU control unit only).	11
160.52	<i>DDCS controller node address</i>	Selects the node address of the IGBT supply unit for communication with the external controller. No two nodes on-line may have the same address. With an AC 800M (CI858) DriveBus connection, IGBT supply units must be addressed 1...24. With an AC 80 DriveBus connection, IGBT supply units must be addressed 1...12. With optical ModuleBus, the address of the IGBT supply unit is set according to the position value as follows: Multiply the hundreds of the position value by 16. Add the tens and ones of the position value to the result. For example, if the position value is 101, this parameter must be set to $1 \times 16 + 1 = 17$.	1
	1...254	Node address.	

No.	Name/Value	Description	Def/FbEq16
160.55	<i>DDCS controller HW connection</i>	Selects the topology of the fiber optic link.	<i>Star</i>
	Ring	The devices are connected in a ring topology. Forwarding of messages is enabled.	0
	Star	The devices are connected in a star topology (for example, through a branching unit). Forwarding of messages is disabled.	1
160.56	<i>DDCS controller baud rate</i>	Defines the communication speed on the fiber optic link. This should be set to the same value on all devices on the link.	<i>4 Mbps</i>
	1 Mbps	1 Mbps.	1
	2 Mbps	2 Mbps.	2
	4 Mbps	4 Mbps.	4
	8 Mbps	8 Mbps.	8
160.57	<i>DDCS controller link control</i>	Defines the light intensity of the transmission LED of RDCO module channel CH0. (This parameter is effective only when parameter <i>160.51 DDCS controller comm port</i> is set to <i>RDCO CH 0</i> . FDCO modules have a hardware transmitter current selector.) In general, use higher values with longer fiber optic cables. The maximum setting is applicable to the maximum length of the fiber optic link.	10
	1...15	Light intensity.	1 = 1
160.58	<i>DDCS controller comm loss time</i>	Sets a timeout for communication with the external controller. If a communication break lasts longer than the timeout, the action specified by parameter <i>160.59 DDCS controller comm loss function</i> is taken. As a rule of thumb, this parameter should be set to at least 3 times the transmit interval of the controller. Notes: <ul style="list-style-type: none"> • There is a 60-second boot-up delay immediately after power-up. During the delay, the communication break monitoring is disabled (but communication itself can be active). • With an AC 800M controller, the controller detects a communication break immediately but re-establishing the communication is done at 9-second idle intervals. Also note that the sending interval of a data set is not the same as the execution interval of the application task. On ModuleBus, the sending interval is defined by controller parameter <i>Scan Cycle Time</i> (by default, 100 ms). 	100 ms
	0...60000 ms	Timeout for communication with external controller.	1 = 1 ms
160.59	<i>DDCS controller comm loss function</i>	Selects how the IGBT supply unit reacts to a communication break between it and the external controller.	<i>Fault</i>
	No action	No action taken.	0
	Fault	A fault is generated.	1
	Warning	A warning is generated.	2
160.60	<i>DDCS controller ref1 type</i>	Selects the type and scaling of reference 1 received from the external controller. The resulting value is shown by parameter <i>103.11 DDCS controller ref 1</i> .	<i>Auto</i>
	Auto	Type and scaling is chosen automatically according to the currently active control mode.	0
	Transparent	No scaling is applied.	1
	General	Generic reference without a specific unit.	2
	Frequency	Reserved.	5

No.	Name/Value	Description	Def/FbEq16
	DC voltage	The scaling is defined by parameter 146.04 DC voltage scaling .	8
	Active power	The scaling is defined by parameter 146.01 Power scaling .	9
	Reactive power	The scaling is defined by parameter 146.02 Reactive power scaling .	10
	AC Voltage	Reserved.	13
160.61	DDCS controller ref2 type	Selects the type and scaling of reference 2 received from the external controller. The resulting value is shown by parameter 103.12 DDCS controller ref 2 . For the selections, see parameter 160.60 DDCS controller ref1 type .	Auto
160.62	DDCS controller act1 type	Selects the type and scaling of actual value 1 transmitted to the external controller. For the selections, see parameter 160.60 DDCS controller ref1 type .	Auto
160.63	DDCS controller act2 type	Selects the type and scaling of actual value 2 transmitted to the external controller. For the selections, see parameter 160.60 DDCS controller ref1 type .	Auto
160.64	Mailbox dataset selection	Selects the pair of data sets used by the mailbox service in the drive/controller communication.	Dataset 32/33
	Dataset 32/33	Data sets 32 and 33.	0
	Dataset 24/25	Data sets 24 and 25.	1
160.77	INU-LSU link control	<i>(Only visible with a BCU control unit)</i> Defines the light intensity of the transmission LED of RDCO module channel CH1. In general, use higher values with longer fiber optic cables. The maximum setting is applicable to the maximum length of the fiber optic link.	10
	1...15	Light intensity.	
161 DDCS transmit		Defines the data sent to the DDCS link.	
161.01	M/F data 1 selection	Preselects the data to be sent as word 1 onto the master/follower link. See also parameter 161.25 M/F data 1 value .	Follower CW
	None	None.	0
	CW 16bit	Control Word (16 bits)	1
	SW 16bit	Status Word (16 bits)	4
	Act1 16bit	Actual value ACT1 (16 bits) Note: Using this setting to send a reference to the follower is not recommended as the source signal is filtered. Use the "reference" selections instead.	5
	Act2 16bit	Actual value ACT2 (16 bits) Note: Using this setting to send a reference to the follower is not recommended as the source signal is filtered. Use the "reference" selections instead.	6
	Follower CW	A word consisting of bits 0...11 of 106.01 Main control word . Note: Bit 3 of the follower control word is kept on as long as the master is modulating, and when it switches to 0, the follower coasts to a stop.	27
	Master power	123.32 Master power (page 125).	6145
	<i>Other</i>	Source selection (see Terms and abbreviations on page 61).	-
161.02	M/F data 2 selection	Preselects the data to be sent as word 2 onto the master/follower link. See also parameter 161.26 M/F data 2 value . For the selections, see parameter 161.01 M/F data 1 selection .	Master power

No.	Name/Value	Description	Def/FbEq16
161.03	<i>M/F data 3 selection</i>	Preselects the data to be sent as word 3 onto the master/follower link. See also parameter <i>161.27 M/F data 3 value</i> . For the selections, see parameter <i>161.01 M/F data 1 selection</i> .	<i>None</i>
161.25	<i>M/F data 1 value</i>	Displays the data to be sent onto the master/follower link as word 1 as an integer. If no data has been preselected by <i>161.01 M/F data 1 selection</i> , the value to be sent can be written directly into this parameter.	0
	0...65535	Data to be sent as word 1 in master/follower communication.	
161.26	<i>M/F data 2 value</i>	Displays the data to be sent onto the master/follower link as word 2 as an integer. If no data has been preselected by <i>161.02 M/F data 2 selection</i> , the value to be sent can be written directly into this parameter.	0
	0...65535	Data to be sent as word 2 in master/follower communication.	
161.27	<i>M/F data 3 value</i>	Displays the data to be sent onto the master/follower link as word 3 as an integer. If no data has been preselected by <i>161.03 M/F data 3 selection</i> , the value to be sent can be written directly into this parameter.	0
	0...65535	Data to be sent as word 3 in master/follower communication.	
161.51	<i>Data set 11 data 1 selection</i>	Selects the location where the value of data set 11 data word 1 is read from.	<i>None</i>
	None	None.	0
	CW 16bit	Virtual address for 16-bit control word.	1
	SW 16bit	Virtual address for 16-bit status word.	4
	Act1 16bit	Virtual address for 16-bit actual value 1.	5
	Act2 16bit	Virtual address for 16-bit actual value 2.	6
	<i>Other</i>	Source selection (see <i>Terms and abbreviations</i> on page 61).	-
161.52	<i>Data set 11 data 2 selection</i>	Selects the location where the value of data set 11 data word 2 is read from. For the selections, see parameter <i>161.51 Data set 11 data 1 selection</i> .	<i>None</i>
161.53	<i>Data set 11 data 3 selection</i>	Selects the location where the value of data set 11 data word 3 is read from. For the selections, see parameter <i>161.51 Data set 11 data 1 selection</i> .	<i>None</i>
161.54	<i>Data set 13 data 1 selection</i>	Selects the location where the value of data set 13 data word 1 is read from. For the selections, see parameter <i>161.51 Data set 11 data 1 selection</i> .	<i>None</i>
161.55	<i>Data set 13 data 2 selection</i>	Selects the location where the value of data set 13 data word 2 is read from. For the selections, see parameter <i>161.51 Data set 11 data 1 selection</i> .	<i>None</i>
161.56	<i>Data set 13 data 3 selection</i>	Selects the location where the value of data set 13 data word 3 is read from. For the selections, see parameter <i>161.51 Data set 11 data 1 selection</i> .	<i>None</i>
161.57	<i>Data set 15 data 1 selection</i>	Selects the location where the value of data set 15 data word 1 is read from. For the selections, see parameter <i>161.51 Data set 11 data 1 selection</i> .	<i>None</i>

168 Parameters

No.	Name/Value	Description	Def/FbEq16
161.58	<i>Data set 15 data 2 selection</i>	Selects the location where the value of data set 15 data word 2 is read from. For the selections, see parameter <i>161.51 Data set 11 data 1 selection</i> .	<i>None</i>
161.59	<i>Data set 15 data 3 selection</i>	Selects the location where the value of data set 15 data word 3 is read from. For the selections, see parameter <i>161.51 Data set 11 data 1 selection</i> .	<i>None</i>
161.60	<i>Data set 17 data 1 selection</i>	Selects the location where the value of data set 17 data word 1 is read from. For the selections, see parameter <i>161.51 Data set 11 data 1 selection</i> .	<i>None</i>
161.61	<i>Data set 17 data 2 selection</i>	Selects the location where the value of data set 17 data word 2 is read from. For the selections, see parameter <i>161.51 Data set 11 data 1 selection</i> .	<i>None</i>
161.62	<i>Data set 17 data 3 selection</i>	Selects the location where the value of data set 17 data word 3 is read from. For the selections, see parameter <i>161.51 Data set 11 data 1 selection</i> .	<i>None</i>
161.63	<i>Data set 19 data 1 selection</i>	Selects the location where the value of data set 19 data word 1 is read from. For the selections, see parameter <i>161.51 Data set 11 data 1 selection</i> .	<i>None</i>
161.64	<i>Data set 19 data 2 selection</i>	Selects the location where the value of data set 19 data word 2 is read from. For the selections, see parameter <i>161.51 Data set 11 data 1 selection</i> .	<i>None</i>
161.65	<i>Data set 19 data 3 selection</i>	Selects the location where the value of data set 19 data word 3 is read from. For the selections, see parameter <i>161.51 Data set 11 data 1 selection</i> .	<i>None</i>
161.66	<i>Data set 21 data 1 selection</i>	Selects the location where the value of data set 21 data word 1 is read from. For the selections, see parameter <i>161.51 Data set 11 data 1 selection</i> .	<i>None</i>
161.67	<i>Data set 21 data 2 selection</i>	Selects the location where the value of data set 21 data word 2 is read from. For the selections, see parameter <i>161.51 Data set 11 data 1 selection</i> .	<i>None</i>
161.68	<i>Data set 21 data 3 selection</i>	Selects the location where the value of data set 21 data word 3 is read from. For the selections, see parameter <i>161.51 Data set 11 data 1 selection</i> .	<i>None</i>
161.69	<i>Data set 23 data 1 selection</i>	Selects the location where the value of data set 23 data word 1 is read from. For the selections, see parameter <i>161.51 Data set 11 data 1 selection</i> .	<i>None</i>
161.70	<i>Data set 23 data 2 selection</i>	Selects the location where the value of data set 23 data word 2 is read from. For the selections, see parameter <i>161.51 Data set 11 data 1 selection</i> .	<i>None</i>

No.	Name/Value	Description	Def/FbEq16
161.71	Data set 23 data 3 selection	Selects the location where the value of data set 23 data word 3 is read from. For the selections, see parameter 161.51 Data set 11 data 1 selection .	None
161.72	Data set 25 data 1 selection	Selects the location where the value of data set 25 data word 1 is read from. For the selections, see parameter 161.51 Data set 11 data 1 selection .	None
161.73	Data set 25 data 2 selection	Selects the location where the value of data set 25 data word 2 is read from. For the selections, see parameter 161.51 Data set 11 data 1 selection .	None
161.74	Data set 25 data 3 selection	Selects the location where the value of data set 25 data word 3 is read from. For the selections, see parameter 161.51 Data set 11 data 1 selection .	None
161.101	Data set 11 data 1 value	Defines the raw data to be transmitted in data set 11 data word 1.	-
	0...65535	Raw data to be transmitted in data set 11 data word 1.	1 = 1
161.102	Data set 11 data 2 value	Defines the raw data to be transmitted in data set 11 data word 2.	-
	0...65535	Raw data to be transmitted in data set 11 data word 2.	1 = 1
161.103	Data set 11 data 3 value	Defines the raw data to be transmitted in data set 11 data word 3.	-
	0...65535	Raw data to be transmitted in data set 11 data word 3.	1 = 1
161.104	Data set 13 data 1 value	Defines the raw data to be transmitted in data set 13 data word 1.	-
	0...65535	Raw data to be transmitted in data set 13 data word 1.	1 = 1
161.105	Data set 13 data 2 value	Defines the raw data to be transmitted in data set 13 data word 2.	-
	0...65535	Raw data to be transmitted in data set 13 data word 2.	1 = 1
161.106	Data set 13 data 3 value	Defines the raw data to be transmitted in data set 13 data word 3.	-
	0...65535	Raw data to be transmitted in data set 13 data word 3.	1 = 1
161.107	Data set 15 data 1 value	Defines the raw data to be transmitted in data set 15 data word 1.	-
	0...65535	Raw data to be transmitted in data set 15 data word 1.	1 = 1
161.108	Data set 15 data 2 value	Defines the raw data to be transmitted in data set 15 data word 2.	-
	0...65535	Raw data to be transmitted in data set 15 data word 2.	1 = 1
161.109	Data set 15 data 3 value	Defines the raw data to be transmitted in data set 15 data word 3.	-
	0...65535	Raw data to be transmitted in data set 15 data word 3.	1 = 1
161.110	Data set 17 data 1 value	Defines the raw data to be transmitted in data set 17 data word 1.	-
	0...65535	Raw data to be transmitted in data set 17 data word 1.	1 = 1
161.111	Data set 17 data 2 value	Defines the raw data to be transmitted in data set 17 data word 2.	-
	0...65535	Raw data to be transmitted in data set 17 data word 2.	1 = 1
161.112	Data set 17 data 3 value	Defines the raw data to be transmitted in data set 17 data word 3.	-
	0...65535	Raw data to be transmitted in data set 17 data word 3.	1 = 1

170 Parameters

No.	Name/Value	Description	Def/FbEq16
161.113	Data set 19 data 1 value	Defines the raw data to be transmitted in data set 19 data word 1.	-
	0...65535	Raw data to be transmitted in data set 19 data word 1.	1 = 1
161.114	Data set 19 data 2 value	Defines the raw data to be transmitted in data set 19 data word 2.	-
	0...65535	Raw data to be transmitted in data set 19 data word 2.	1 = 1
161.115	Data set 19 data 3 value	Defines the raw data to be transmitted in data set 19 data word 3.	-
	0...65535	Raw data to be transmitted in data set 19 data word 3.	1 = 1
161.116	Data set 21 data 1 value	Defines the raw data to be transmitted in data set 21 data word 1.	-
	0...65535	Raw data to be transmitted in data set 21 data word 1.	1 = 1
161.117	Data set 21 data 2 value	Defines the raw data to be transmitted in data set 21 data word 2.	-
	0...65535	Raw data to be transmitted in data set 21 data word 2.	1 = 1
161.118	Data set 21 data 3 value	Defines the raw data to be transmitted in data set 21 data word 3.	-
	0...65535	Raw data to be transmitted in data set 21 data word 3.	1 = 1
161.119	Data set 23 data 1 value	Defines the raw data to be transmitted in data set 23 data word 1.	-
	0...65535	Raw data to be transmitted in data set 23 data word 1.	1 = 1
161.120	Data set 23 data 2 value	Defines the raw data to be transmitted in data set 23 data word 2.	-
	0...65535	Raw data to be transmitted in data set 23 data word 2.	1 = 1
161.121	Data set 23 data 3 value	Defines the raw data to be transmitted in data set 23 data word 3.	-
	0...65535	Raw data to be transmitted in data set 23 data word 3.	1 = 1
161.122	Data set 25 data 1 value	Defines the raw data to be transmitted in data set 25 data word 1.	-
	0...65535	Raw data to be transmitted in data set 25 data word 1.	1 = 1
161.123	Data set 25 data 2 value	Defines the raw data to be transmitted in data set 25 data word 2.	-
	0...65535	Raw data to be transmitted in data set 25 data word 2.	1 = 1
161.124	Data set 25 data 3 value	Defines the raw data to be transmitted in data set 25 data word 3.	-
	0...65535	Raw data to be transmitted in data set 25 data word 3.	1 = 1
162 DDCS receive		Mapping of data received through the DDCS link.	
162.01	M/F data 1 selection	(Follower only) Defines a target for the data received as word 1 from the master through the master/follower link. See also parameter 162.25 MF data 1 value .	<i>None</i>
	None	None.	0
	CW 16bit	Control Word (16 bits)	1
	Ref1 16bit	Reference REF1 (16 bits)	2
	Ref2 16bit	Reference REF2 (16 bits)	3
	Master power	123.32 Master power (page 125).	6145
	<i>Other</i>	Source selection (see Terms and abbreviations on page 61).	-
162.02	M/F data 2 selection	(Follower only) Defines a target for the data received as word 2 from the master through the master/follower link. See also parameter 162.26 MF data 2 value . For the selections, see parameter 162.01 M/F data 1 selection .	<i>None</i>

No.	Name/Value	Description	Def/FbEq16
162.03	<i>M/F data 3 selection</i>	(Follower only) Defines a target for the data received as word 3 from the master through the master/follower link. See also parameter 162.27 MF data 3 value . For the selections, see parameter 162.01 M/F data 1 selection .	<i>None</i>
162.04	<i>Follower node 2 data 1 sel</i>	Defines a target for the data received as word 1 from the first follower (ie. the follower with node address 2) through the master/follower link. See also parameter 162.28 Follower node 2 data 1 value .	<i>Follower SW</i>
	None	None.	0
	Follower SW	Status word of the follower. See also parameter 160.18 Follower enable .	26
	<i>Other</i>	Source selection (see Terms and abbreviations on page 61).	-
162.05	<i>Follower node 2 data 2 sel</i>	Defines a target for the data received as word 2 from the first follower (ie. the follower with node address 2) through the master/follower link. See also parameter 162.29 Follower node 2 data 2 value . For the selections, see parameter 162.04 Follower node 2 data 1 sel .	<i>None</i>
162.06	<i>Follower node 2 data 3 sel</i>	Defines a target for the data received as word 3 from the first follower (ie. the follower with node address 2) through the master/follower link. See also parameter 162.30 Follower node 2 data 3 value . For the selections, see parameter 162.04 Follower node 2 data 1 sel .	<i>None</i>
162.07	<i>Follower node 3 data 1 sel</i>	Defines a target for the data received as word 1 from the second follower (ie. the follower with node address 3) through the master/follower link. See also parameter 162.31 Follower node 3 data 1 value . For the selections, see parameter 162.04 Follower node 2 data 1 sel .	<i>Follower SW</i>
162.08	<i>Follower node 3 data 2 sel</i>	Defines a target for the data received as word 2 from the second follower (ie. the follower with node address 3) through the master/follower link. See also parameter 162.32 Follower node 3 data 2 value . For the selections, see parameter 162.04 Follower node 2 data 1 sel .	<i>None</i>
162.09	<i>Follower node 3 data 3 sel</i>	Defines a target for the data received as word 3 from the second follower (ie. the follower with node address 3) through the master/follower link. See also parameter 162.33 Follower node 3 data 3 value . For the selections, see parameter 162.04 Follower node 2 data 1 sel .	<i>None</i>
162.10	<i>Follower node 4 data 1 sel</i>	Defines a target for the data received as word 1 from the third follower (ie. the follower with node address 4) through the master/follower link. See also parameter 162.34 Follower node 4 data 1 value . For the selections, see parameter 162.04 Follower node 2 data 1 sel .	<i>Follower SW</i>
162.11	<i>Follower node 4 data 2 sel</i>	Defines a target for the data received as word 2 from the third follower (ie. the follower with node address 4) through the master/follower link. See also parameter 162.35 Follower node 4 data 2 value . For the selections, see parameter 162.04 Follower node 2 data 1 sel .	<i>None</i>

172 Parameters

No.	Name/Value	Description	Def/FbEq16
162.12	<i>Follower node 4 data 3 sel</i>	Defines a target for the data received as word 3 from the third follower (ie. the follower with node address 4) through the master/follower link. See also parameter <i>162.36 Follower node 4 data 3 value</i> . For the selections, see parameter <i>162.04 Follower node 2 data 1 sel</i> .	<i>None</i>
162.25	<i>MF data 1 value</i>	(Follower only) Displays, in integer format, the data received from the master as word 1. Parameter <i>162.01 M/F data 1 selection</i> can be used to select a target for the received data. This parameter can also be used as a signal source by other parameters.	0
	0...65535	Data received as word 1 in master/follower communication.	
162.26	<i>MF data 2 value</i>	(Follower only) Displays, in integer format, the data received from the master as word 2. Parameter <i>162.02 M/F data 2 selection</i> can be used to select a target for the received data. This parameter can also be used as a signal source by other parameters.	0
	0...65535	Data received as word 2 in master/follower communication.	
162.27	<i>MF data 3 value</i>	(Follower only) Displays, in integer format, the data received from the master as word 3. Parameter <i>162.03 M/F data 3 selection</i> can be used to select a target for the received data. This parameter can also be used as a signal source by other parameters.	0
	0...65535	Data received as word 3 in master/follower communication.	
162.28	<i>Follower node 2 data 1 value</i>	Displays, in integer format, the data received from the first follower (ie. follower with node address 2) as word 1. Parameter <i>162.04 Follower node 2 data 1 sel</i> can be used to select a target for the received data. This parameter can also be used as a signal source by other parameters.	0
	0...65535	Data received as word 1 from follower with node address 2.	
162.29	<i>Follower node 2 data 2 value</i>	Displays, in integer format, the data received from the first follower (ie. follower with node address 2) as word 2. Parameter <i>162.05 Follower node 2 data 2 sel</i> can be used to select a target for the received data. This parameter can also be used as a signal source by other parameters.	0
	0...65535	Data received as word 2 from follower with node address 2.	
162.30	<i>Follower node 2 data 3 value</i>	Displays, in integer format, the data received from the first follower (ie. follower with node address 2) as word 3. Parameter <i>162.06 Follower node 2 data 3 sel</i> can be used to select a target for the received data. This parameter can also be used as a signal source by other parameters.	0
	0...65535	Data received as word 3 from follower with node address 2.	
162.31	<i>Follower node 3 data 1 value</i>	Displays, in integer format, the data received from the second follower (ie. follower with node address 3) as word 1. Parameter <i>162.07 Follower node 3 data 1 sel</i> can be used to select a target for the received data. This parameter can also be used as a signal source by other parameters.	0
	0...65535	Data received as word 1 from follower with node address 3.	
162.32	<i>Follower node 3 data 2 value</i>	Displays, in integer format, the data received from the second follower (ie. follower with node address 3) as word 2. Parameter <i>162.08 Follower node 3 data 2 sel</i> can be used to select a target for the received data. This parameter can also be used as a signal source by other parameters.	0
	0...65535	Data received as word 2 from follower with node address 3.	

No.	Name/Value	Description	Def/FbEq16															
162.33	<i>Follower node 3 data 3 value</i>	Displays, in integer format, the data received from the second follower (ie. follower with node address 3) as word 3. Parameter <i>162.09 Follower node 3 data 3 sel</i> can be used to select a target for the received data. This parameter can also be used as a signal source by other parameters.	0															
	0...65535	Data received as word 3 from follower with node address 3.																
162.34	<i>Follower node 4 data 1 value</i>	Displays, in integer format, the data received from the third follower (ie. follower with node address 4) as word 1. Parameter <i>162.10 Follower node 4 data 1 sel</i> can be used to select a target for the received data. This parameter can also be used as a signal source by other parameters.	0															
	0...65535	Data received as word 1 from follower with node address 4.																
162.35	<i>Follower node 4 data 2 value</i>	Displays, in integer format, the data received from the third follower (ie. follower with node address 4) as word 2. Parameter <i>162.11 Follower node 4 data 2 sel</i> can be used to select a target for the received data. This parameter can also be used as a signal source by other parameters.	0															
	0...65535	Data received as word 2 from follower with node address 4.																
162.36	<i>Follower node 4 data 3 value</i>	Displays, in integer format, the data received from the third follower (ie. follower with node address 4) as word 3. Parameter <i>162.12 Follower node 4 data 3 sel</i> can be used to select a target for the received data. This parameter can also be used as a signal source by other parameters.	0															
	0...65535	Data received as word 3 from follower with node address 4.																
162.37	<i>M/F communication status 1</i>	In the master, displays the status of the communication with followers. In a follower, bit 0 indicates the status of the communication with the master.	-															
		<table border="1"> <thead> <tr> <th>Bit</th> <th>Name</th> <th>Description</th> </tr> </thead> <tbody> <tr> <td>0</td> <td>Follower 1</td> <td>1 (in the master) = Communication with follower 1 OK. 1 (in a follower) = Communication with master OK.</td> </tr> <tr> <td>1</td> <td>Follower 2</td> <td>1 = Communication with follower 2 OK.</td> </tr> <tr> <td>...</td> <td>...</td> <td>...</td> </tr> <tr> <td>15</td> <td>Follower 16</td> <td>1 = Communication with follower 16 OK.</td> </tr> </tbody> </table>	Bit	Name	Description	0	Follower 1	1 (in the master) = Communication with follower 1 OK. 1 (in a follower) = Communication with master OK.	1	Follower 2	1 = Communication with follower 2 OK.	15	Follower 16	1 = Communication with follower 16 OK.	
Bit	Name	Description																
0	Follower 1	1 (in the master) = Communication with follower 1 OK. 1 (in a follower) = Communication with master OK.																
1	Follower 2	1 = Communication with follower 2 OK.																
...																
15	Follower 16	1 = Communication with follower 16 OK.																
	0000h...FFFFh	M/F communication status (followers 1...16).	1 = 1															
162.38	<i>M/F communication status 2</i>	In the master, displays the status of the communication with followers.	-															
		<table border="1"> <thead> <tr> <th>Bit</th> <th>Name</th> <th>Description</th> </tr> </thead> <tbody> <tr> <td>0</td> <td>Follower 17</td> <td>1 = Communication with follower 17 OK.</td> </tr> <tr> <td>1</td> <td>Follower 18</td> <td>1 = Communication with follower 18 OK.</td> </tr> <tr> <td>...</td> <td>...</td> <td>...</td> </tr> <tr> <td>15</td> <td>Follower 32</td> <td>1 = Communication with follower 32 OK.</td> </tr> </tbody> </table>	Bit	Name	Description	0	Follower 17	1 = Communication with follower 17 OK.	1	Follower 18	1 = Communication with follower 18 OK.	15	Follower 32	1 = Communication with follower 32 OK.	
Bit	Name	Description																
0	Follower 17	1 = Communication with follower 17 OK.																
1	Follower 18	1 = Communication with follower 18 OK.																
...																
15	Follower 32	1 = Communication with follower 32 OK.																
	0000h...FFFFh	M/F communication status (followers 17...32).	1 = 1															

174 Parameters

No.	Name/Value	Description	Def/FbEq16															
162.41	<i>M/F follower ready status 1</i>	In the master, displays the ready status of the communication with followers specified by parameter 160.23 M/F status supervision sel 1 .	-															
<table border="1"> <thead> <tr> <th>Bit</th> <th>Name</th> <th>Description</th> </tr> </thead> <tbody> <tr> <td>0</td> <td>Follower 1</td> <td>1 = Follower 1 ready.</td> </tr> <tr> <td>1</td> <td>Follower 2</td> <td>1 = Follower 2 ready.</td> </tr> <tr> <td>...</td> <td>...</td> <td>...</td> </tr> <tr> <td>15</td> <td>Follower 16</td> <td>1 = Follower 16 ready.</td> </tr> </tbody> </table>				Bit	Name	Description	0	Follower 1	1 = Follower 1 ready.	1	Follower 2	1 = Follower 2 ready.	15	Follower 16	1 = Follower 16 ready.
Bit	Name	Description																
0	Follower 1	1 = Follower 1 ready.																
1	Follower 2	1 = Follower 2 ready.																
...																
15	Follower 16	1 = Follower 16 ready.																
0000h...FFFFh		Follower 1...16 ready status.	1 = 1															
162.42	<i>M/F follower ready status 2</i>	In the master, displays the ready status of the communication with followers.	-															
<table border="1"> <thead> <tr> <th>Bit</th> <th>Name</th> <th>Description</th> </tr> </thead> <tbody> <tr> <td>0</td> <td>Follower 17</td> <td>1 = Follower 17 ready.</td> </tr> <tr> <td>1</td> <td>Follower 18</td> <td>1 = Follower 18 ready.</td> </tr> <tr> <td>...</td> <td>...</td> <td>...</td> </tr> <tr> <td>15</td> <td>Follower 32</td> <td>1 = Follower 32 ready.</td> </tr> </tbody> </table>				Bit	Name	Description	0	Follower 17	1 = Follower 17 ready.	1	Follower 18	1 = Follower 18 ready.	15	Follower 32	1 = Follower 32 ready.
Bit	Name	Description																
0	Follower 17	1 = Follower 17 ready.																
1	Follower 18	1 = Follower 18 ready.																
...																
15	Follower 32	1 = Follower 32 ready.																
0000h...FFFFh		Follower 17...32 ready status.	1 = 1															
162.51	<i>Data set 10 data 1 selection</i>	Selects the location into which the value of data set 10 data word 1 is written.	<i>None</i>															
None		None.	0															
CW 16bit		Virtual address for 16-bit control word.	1															
Ref1 16bit		Virtual address for 16-bit reference 1.	2															
Ref2 16bit		Virtual address for 16-bit reference 2.	3															
<i>Other</i>		Source selection (see Terms and abbreviations on page 61).	-															
162.52	<i>Data set 10 data 2 selection</i>	Selects the location into which the value of data set 10 data word 2 is written. For the selections, see parameter 162.51 Data set 10 data 1 selection .	<i>None</i>															
162.53	<i>Data set 10 data 3 selection</i>	Selects the location into which the value of data set 10 data word 3 is written. For the selections, see parameter 162.51 Data set 10 data 1 selection .	<i>None</i>															
162.54	<i>Data set 12 data 1 selection</i>	Selects the location into which the value of data set 12 data word 1 is written. For the selections, see parameter 162.51 Data set 10 data 1 selection .	<i>None</i>															
162.55	<i>Data set 12 data 2 selection</i>	Selects the location into which the value of data set 12 data word 2 is written. For the selections, see parameter 162.51 Data set 10 data 1 selection .	<i>None</i>															
162.56	<i>Data set 12 data 3 selection</i>	Selects the location into which the value of data set 12 data word 3 is written. For the selections, see parameter 162.51 Data set 10 data 1 selection .	<i>None</i>															
162.57	<i>Data set 14 data 1 selection</i>	Selects the location into which the value of data set 14 data word 1 is written. For the selections, see parameter 162.51 Data set 10 data 1 selection .	<i>None</i>															

No.	Name/Value	Description	Def/FbEq16
162.58	<i>Data set 14 data 2 selection</i>	Selects the location into which the value of data set 14 data word 2 is written. For the selections, see parameter 162.51 Data set 10 data 1 selection .	<i>None</i>
162.59	<i>Data set 14 data 3 selection</i>	Selects the location into which the value of data set 14 data word 3 is written. For the selections, see parameter 162.51 Data set 10 data 1 selection .	<i>None</i>
162.60	<i>Data set 16 data 1 selection</i>	Selects the location into which the value of data set 16 data word 1 is written. For the selections, see parameter 162.51 Data set 10 data 1 selection .	<i>None</i>
162.61	<i>Data set 16 data 2 selection</i>	Selects the location into which the value of data set 16 data word 2 is written. For the selections, see parameter 162.51 Data set 10 data 1 selection .	<i>None</i>
162.62	<i>Data set 16 data 3 selection</i>	Selects the location into which the value of data set 16 data word 3 is written. For the selections, see parameter 162.51 Data set 10 data 1 selection .	<i>None</i>
162.63	<i>Data set 18 data 1 selection</i>	Selects the location into which the value of data set 18 data word 1 is written. For the selections, see parameter 162.51 Data set 10 data 1 selection .	<i>None</i>
162.64	<i>Data set 18 data 2 selection</i>	Selects the location into which the value of data set 18 data word 2 is written. For the selections, see parameter 162.51 Data set 10 data 1 selection .	<i>None</i>
162.65	<i>Data set 18 data 3 selection</i>	Selects the location into which the value of data set 18 data word 3 is written. For the selections, see parameter 162.51 Data set 10 data 1 selection .	<i>None</i>
162.66	<i>Data set 20 data 1 selection</i>	Selects the location into which the value of data set 20 data word 1 is written. For the selections, see parameter 162.51 Data set 10 data 1 selection .	<i>None</i>
162.67	<i>Data set 20 data 2 selection</i>	Selects the location into which the value of data set 20 data word 2 is written. For the selections, see parameter 162.51 Data set 10 data 1 selection .	<i>None</i>
162.68	<i>Data set 20 data 3 selection</i>	Selects the location into which the value of data set 20 data word 3 is written. For the selections, see parameter 162.51 Data set 10 data 1 selection .	<i>None</i>
162.69	<i>Data set 22 data 1 selection</i>	Selects the location into which the value of data set 22 data word 1 is written. For the selections, see parameter 162.51 Data set 10 data 1 selection .	<i>None</i>
162.70	<i>Data set 22 data 2 selection</i>	Selects the location into which the value of data set 22 data word 2 is written. For the selections, see parameter 162.51 Data set 10 data 1 selection .	<i>None</i>

176 Parameters

No.	Name/Value	Description	Def/FbEq16
162.71	Data set 22 data 3 selection	Selects the location into which the value of data set 22 data word 3 is written. For the selections, see parameter 162.51 Data set 10 data 1 selection .	None
162.72	Data set 24 data 1 selection	Selects the location into which the value of data set 24 data word 1 is written. For the selections, see parameter 162.51 Data set 10 data 1 selection .	None
162.73	Data set 24 data 2 selection	Selects the location into which the value of data set 24 data word 2 is written. For the selections, see parameter 162.51 Data set 10 data 1 selection .	None
162.74	Data set 24 data 3 selection	Selects the location into which the value of data set 24 data word 3 is written. For the selections, see parameter 162.51 Data set 10 data 1 selection .	None
162.101	Data set 10 data 1 value	Defines the raw data to be received in data set 10 data word 1.	-
	0...65535	Raw data to be received in data set 10 data word 1.	1 = 1
162.102	Data set 10 data 2 value	Defines the raw data to be received in data set 10 data word 2.	-
	0...65535	Raw data to be received in data set 10 data word 2.	1 = 1
162.103	Data set 10 data 3 value	Defines the raw data to be received in data set 10 data word 3.	-
	0...65535	Raw data to be received in data set 10 data word 3.	1 = 1
162.104	Data set 12 data 1 value	Defines the raw data to be received in data set 12 data word 1.	-
	0...65535	Raw data to be received in data set 12 data word 1.	1 = 1
162.105	Data set 12 data 2 value	Defines the raw data to be received in data set 12 data word 2.	-
	0...65535	Raw data to be received in data set 12 data word 2.	1 = 1
162.106	Data set 12 data 3 value	Defines the raw data to be received in data set 12 data word 3.	-
	0...65535	Raw data to be received in data set 12 data word 3.	1 = 1
162.107	Data set 14 data 1 value	Defines the raw data to be received in data set 14 data word 1.	-
	0...65535	Raw data to be received in data set 14 data word 1.	1 = 1
162.108	Data set 14 data 2 value	Defines the raw data to be received in data set 14 data word 2.	-
	0...65535	Raw data to be received in data set 14 data word 2.	1 = 1
162.109	Data set 14 data 3 value	Defines the raw data to be received in data set 14 data word 3.	-
	0...65535	Raw data to be received in data set 14 data word 3.	1 = 1
162.110	Data set 16 data 1 value	Defines the raw data to be received in data set 16 data word 1.	-
	0...65535	Raw data to be received in data set 16 data word 1.	1 = 1
162.111	Data set 16 data 2 value	Defines the raw data to be received in data set 16 data word 2.	-
	0...65535	Raw data to be received in data set 16 data word 2.	1 = 1
162.112	Data set 16 data 3 value	Defines the raw data to be received in data set 16 data word 3.	-
	0...65535	Raw data to be received in data set 16 data word 3.	1 = 1

No.	Name/Value	Description	Def/FbEq16
162.113	Data set 18 data 1 value	Defines the raw data to be received in data set 18 data word 1.	-
	0...65535	Raw data to be received in data set 18 data word 1.	1 = 1
162.114	Data set 18 data 2 value	Defines the raw data to be received in data set 18 data word 2.	-
	0...65535	Raw data to be received in data set 18 data word 2.	1 = 1
162.115	Data set 18 data 3 value	Defines the raw data to be received in data set 18 data word 3.	-
	0...65535	Raw data to be received in data set 18 data word 3.	1 = 1
162.116	Data set 20 data 1 value	Defines the raw data to be received in data set 20 data word 1.	-
	0...65535	Raw data to be received in data set 20 data word 1.	1 = 1
162.117	Data set 20 data 2 value	Defines the raw data to be received in data set 20 data word 2.	-
	0...65535	Raw data to be received in data set 20 data word 2.	1 = 1
162.118	Data set 20 data 3 value	Defines the raw data to be received in data set 20 data word 3.	-
	0...65535	Raw data to be received in data set 20 data word 3.	1 = 1
162.119	Data set 22 data 1 value	Defines the raw data to be received in data set 22 data word 1.	-
	0...65535	Raw data to be received in data set 22 data word 1.	1 = 1
162.120	Data set 22 data 2 value	Defines the raw data to be received in data set 22 data word 2.	-
	0...65535	Raw data to be received in data set 22 data word 2.	1 = 1
162.121	Data set 22 data 3 value	Defines the raw data to be received in data set 22 data word 3.	-
	0...65535	Raw data to be received in data set 22 data word 3.	1 = 1
162.122	Data set 24 data 1 value	Defines the raw data to be received in data set 24 data word 1.	-
	0...65535	Raw data to be received in data set 24 data word 1.	1 = 1
162.123	Data set 24 data 2 value	Defines the raw data to be received in data set 24 data word 2.	-
	0...65535	Raw data to be received in data set 24 data word 2.	1 = 1
162.124	Data set 24 data 3 value	Defines the raw data to be received in data set 24 data word 3.	-
	0...65535	Raw data to be received in data set 24 data word 3.	1 = 1
190 BAMU measurements		Grid measurement signals from BAMU measurement unit. BAMU measures voltages and currents configured in parameter group 191 BAMU configuration . All parameters in this group are read-only.	
190.01	Phase voltage U1	Shows the RMS value of phase voltage U1a.	-
	0.00...2000.00 V	RMS value of phase voltage U1a.	1 = 1 V
190.02	Phase voltage V1	Shows the RMS value of phase voltage U1b.	-
	0.00...2000.00 V	RMS value of phase voltage U1b.	1 = 1 V
190.03	Phase voltage W1	Shows the RMS value of phase voltage U1c.	-
	0.00...2000.00 V	RMS value of phase voltage U1c.	1 = 1 V
190.06	Mains voltage U1-V1	Shows the RMS value of line-to-line voltage U1ab.	-
	0.00...2000.00 V	RMS value of line-to-line voltage U1ab.	1 = 1 V
190.07	Mains voltage V1-W1	Shows the RMS value of line-to-line voltage U1bc.	-
	0.00...2000.00 V	RMS value of line-to-line voltage U1bc.	1 = 1 V

178 Parameters

No.	Name/Value	Description	Def/FbEq16
190.08	<i>Mains voltage W1-U1</i>	Shows the RMS value of line-to-line voltage U1ca.	-
	0.00...2000.00 V	RMS value of line-to-line voltage U1ca.	1 = 1 V
190.15	<i>Frequency 1</i>	Shows the frequency of the measured voltage U1.	-
	0.00...100.00 Hz	Frequency of the measured voltage U1.	1 = 1 Hz
190.20	<i>Phase voltage U2</i>	Shows the RMS value of phase voltage U2a.	-
	0.00...2000.00 V	RMS value of phase voltage U2a.	1 = 1 V
190.21	<i>Phase voltage V2</i>	Shows the RMS value of phase voltage U2b.	-
	0.00...2000.00 V	RMS value of phase voltage U2b.	1 = 1 V
190.22	<i>Phase voltage W2</i>	Shows the RMS value of phase voltage U2c.	-
	0.00...2000.00 V	RMS value of phase voltage U2c.	1 = 1 V
190.25	<i>Mains voltage U2-V2</i>	Shows the RMS value of line-to-line voltage U2ab.	-
	0.00...2000.00 V	RMS value of line-to-line voltage U2ab.	1 = 1 V
190.26	<i>Mains voltage V2-W2</i>	Shows the RMS value of line-to-line voltage U2bc.	-
	0.00...2000.00 V	RMS value of line-to-line voltage U2bc.	1 = 1 V
190.27	<i>Mains voltage W2-U2</i>	Shows the RMS value of line-to-line voltage U2ca.	-
	0.00...2000.00 V	RMS value of line-to-line voltage U2ca.	1 = 1 V
190.34	<i>Frequency 2</i>	Shows the frequency of the measured voltage U2.	-
	0.00...100.00 Hz	Frequency of the measured voltage U2.	1 = 1 Hz
190.40	<i>Phase current U1</i>	Shows the RMS value of phase current Ia.	-
	-	RMS value of phase current Ia.	1 = 1 A
190.41	<i>Phase current V1</i>	Shows the RMS value of phase current Ib.	-
	-	RMS value of phase current Ib.	1 = 1 A
190.42	<i>Phase current W1</i>	Shows the RMS value of phase current Ic.	-
	-	RMS value of phase current Ic.	1 = 1 A
191 BAMU configuration		Settings for BAMU measurement unit.	
191.01	<i>U1 measurement</i>	Enables U1 measurements.	<i>No</i>
	No	U1 measurements disabled.	0
	Yes	U1 measurements enabled.	1
191.02	<i>U1 meas type</i>	Selects U1 voltage measurement type. For more information on BAMU unit measurements, see <i>BAMU-12C auxiliary measurement unit hardware manual</i> (3AXD50000117840 [English]).	<i>Mains voltage</i>
	Mains voltage	Main voltage measurement.	1
	Phase voltage	Voltage measurement against phase ground.	2
	Phase voltage neutral	Voltage measurement against virtual ground.	3
191.10	<i>U2 measurement</i>	Enables U2 measurements.	<i>No</i>
	No	U2 measurements disabled.	0
	Yes	U2 measurements enabled.	1
191.11	<i>U2 meas type</i>	Selects U2 voltage measurement type. For more information on BAMU unit measurements, see <i>BAMU-12C auxiliary measurement unit hardware manual</i> (3AXD50000117840 [English]).	<i>Phase voltage</i>
	Mains voltage	Main voltage measurement.	1
	Phase voltage	Voltage measurement against phase ground.	2
	Phase voltage neutral	Voltage measurement against virtual ground.	3

No.	Name/Value	Description	Def/FbEq16
191.20	<i>I measurement</i>	Enables current measurements.	No
	No	Current measurements disabled.	0
	Yes	Current measurements enabled.	1
191.22	<i>Current transf. ratio</i>	Defines the transformation ratio of the current transformer. Example: If transformation ratio is 2000/1A, set the value of this parameter to 2000.	0
	-	Transformation ratio.	1 = 1
191.29	<i>Board type</i>	Displays the type of BAMU unit.	Not found
	BAMU-11	Not supported.	0
	BAMU-12	BAMU-12.	16
	Not found	No BAMU unit found.	65535
191.30	<i>BAMU 1 channel</i>	Defines the channel for BAMU unit measurements. Set BAMU channel to the first unused module channel. For example, if the unit already has five module channels in use, set number to six. Reboot the control unit after setting this parameter.	0
	0...12	BAMU channel.	1 = 1
191.40	<i>Transformer location</i>	Selects the transformer location in main circuit in measurements with BAMU measurement unit. The figure below shows the possible transformer and circuit breaker locations in main circuit (A and B), and possible measurement locations for voltages U1 and U2 (1, 2 and 3). Locations are set with parameters 191.40...191.43. In case of errors in measurement settings, warning <i>5E1C BAMU meas settings</i> is generated. See also section <i>BAMU measurements</i> on page 59.	Not set
<pre> graph LR C[Converter with LCL filter] --- 1((1)) 1 --- A[A] A --- 2((2)) 2 --- B[B] B --- 3((3)) 3 --- G[Grid] </pre>			
	Not set	Not set.	0
	Location A	Transformer is located in location A (on the converter-side).	1
	Location B	Transformer is located in location B (on the grid-side).	2
191.41	<i>Circuit breaker location</i>	Selects the circuit breaker location in main circuit in measurements with BAMU measurement unit. See the figure in parameter 191.40 <i>Transformer location</i> . See also section <i>BAMU measurements</i> on page 59.	Not set
	Not set	Not set.	0
	Location A	Circuit breaker is located in location A (on the converter-side).	1
	Location B	Circuit breaker is located in location B (on the grid-side).	2
191.42	<i>U1 meas location</i>	Selects the measurement location of voltage U1 in measurements with BAMU measurement unit. See the figure in parameter 191.40 <i>Transformer location</i> . See also section <i>BAMU measurements</i> on page 59.	Not set
	Not set	Not set.	0
	Other	Other.	1
	Location 1	Voltage U1 is measured from location 1 (from grid-side terminals of an LCL filter).	2
	Location 2	Voltage U1 is measured from location 2 (after a circuit breaker or transformer).	3

No.	Name/Value	Description	Def/FbEq16
	Location 3	Voltage U1 is measured from location 3 (from the grid-side of a transformer or circuit breaker).	4
191.43	<i>U2 meas location</i>	Selects the measurement location of voltage U2 in measurements with BAMU measurement unit. See the figure in parameter <i>191.40 Transformer location</i> . See also section <i>BAMU measurements</i> on page 59.	<i>Not set</i>
	Not set	Not set.	0
	Other	Other.	1
	Location 2	Voltage U2 is measured from location 2 (after a circuit breaker or transformer).	3
	Location 3	Voltage U2 is measured from location 3 (from the grid-side of a transformer or circuit breaker).	4
<i>195 HW configuration</i>		Various hardware-related settings.	
195.01	<i>Supply voltage</i>	Selects the supply voltage range. The value affects the DC voltage control, trip and brake chopper limits of the supply unit. Note: The current rating of the supply unit is also affected by the selected supply voltage.	<i>Not given</i>
	Not given	No voltage defined. The IGBT supply unit will not start modulating before another value is selected. The supply unit displays warning <i>AE24 Voltage category unselected</i> until you have defined the value.	0
	380...415 V	380...415 V	2
	440...480 V	440...480 V	3
	500 V	500 V	4
	525...600 V	525...600 V	5
	660...690 V	660...690 V	6
195.04	<i>Control board supply</i>	Specifies how the control unit of the IGBT supply unit is powered.	<i>External 24V</i>
	Internal 24V	The control unit is powered from the power unit it is connected to. This is the default setting.	0
	External 24V	The control unit is powered from an external power supply.	1
	Redundant external 24V	BCU control unit only: Redundant supervision of 24 V signal. A warning (<i>AE5C External power signal missing</i>) is generated if the power supply is missing.	2
195.09	<i>Switch fuse controller</i>	<i>(Only visible with a BCU control unit)</i> Activates communication to a xSFC charging controller. This setting is intended for use with modules that are connected to a DC bus through a DC switch/charging circuit controlled by a charging controller. On units without a DC switch, this parameter should be set to <i>Disable</i> . The charging controller monitors the charging of the unit, and sends an enable command when the charging has finished (ie. DC switch is closed after the 'charging OK' lamp lights, and charging switch opened). For more information, see xSFC documentation.	<i>PU Default</i>
	Disable	Communication with xSFC disabled.	0
	Enable	Communication with xSFC enabled.	1
	PU Default	Communication with xSFC enabled for liquid-cooled modules and disabled for air-cooled modules	2

No.	Name/Value	Description	Def/FbEq16																		
195.13	<i>Reduced run mode</i>	<p>(Only visible with a BCU control unit)</p> <p>Specifies the number of supply modules available.</p> <p>This parameter must be set if reduced run is required. A value other than 0 activates the reduced run function.</p> <p>If the control program cannot detect the number of modules specified by this parameter, a fault (<i>5E0E Reduced run</i>) is generated.</p> <p>See section <i>Reduced run function</i> (page 34).</p> <p>0 = Reduced run disabled 1...8 = Number of modules available</p>	0																		
	0...65535	Number of modules available.	-																		
195.14	<i>Connected modules</i>	Shows which power modules have been detected.	-																		
		<table border="1"> <thead> <tr> <th>Bit</th> <th>Name</th> <th>Description</th> </tr> </thead> <tbody> <tr> <td>0</td> <td>Module 1</td> <td>1 = Module 1 has been detected.</td> </tr> <tr> <td>1</td> <td>Module 2</td> <td>1 = Module 2 has been detected.</td> </tr> <tr> <td>...</td> <td>...</td> <td>...</td> </tr> <tr> <td>11</td> <td>Module 12</td> <td>1 = Module 12 has been detected.</td> </tr> <tr> <td>12...15</td> <td>Reserved.</td> <td></td> </tr> </tbody> </table>	Bit	Name	Description	0	Module 1	1 = Module 1 has been detected.	1	Module 2	1 = Module 2 has been detected.	11	Module 12	1 = Module 12 has been detected.	12...15	Reserved.		
Bit	Name	Description																			
0	Module 1	1 = Module 1 has been detected.																			
1	Module 2	1 = Module 2 has been detected.																			
...																			
11	Module 12	1 = Module 12 has been detected.																			
12...15	Reserved.																				
	0000h...FFFFh	Power modules connected.	1 = 1																		
195.16	<i>Router mode</i>	<p>(Only visible with a BCU control unit)</p> <p>Enables/disables router mode of the BCU control unit. When router mode is active, the PSL2 channels connected to another BCU (ie. those selected by <i>195.17 Router channel config</i>) are routed to the power units (IGBT supply modules) connected to this BCU.</p> <p>See section <i>Router mode for BCU control unit</i> (page 58).</p> <p>Note: This parameter cannot be changed while the supply unit is running.</p>	<i>Off</i>																		
	Off	Router mode inactive.	0																		
	On	Router mode active.	1																		
	<i>Other</i>	Source selection (see <i>Terms and abbreviations</i> on page 61).	-																		

No.	Name/Value	Description	Def/FbEq16																		
195.17	Router channel config	<p>(Only visible with a BCU control unit)</p> <p>Selects which PSL2 channels on the BCU control unit are connected to another BCU and routed to a local power unit.</p> <p>Notes:</p> <ul style="list-style-type: none"> The local power units are to be connected to successive channels starting from CH1. The other BCU is then connected to one or more successive channels starting from the first free channel. The lowest channel selected in this parameter is routed to the local power unit with the lowest number, etc. There must be at least as many local power modules as there are routed channels. This parameter cannot be changed while the supply unit is running. <p>See section Router mode for BCU control unit (page 58).</p>	0000h																		
<table border="1"> <thead> <tr> <th>Bit</th> <th>Name</th> <th>Description</th> </tr> </thead> <tbody> <tr> <td>0</td> <td>ch1</td> <td>0</td> </tr> <tr> <td>1</td> <td>ch2</td> <td>1 = Channel CH2 is routed to the local power unit (which is connected to CH1).</td> </tr> <tr> <td>...</td> <td>...</td> <td>...</td> </tr> <tr> <td>11</td> <td>ch12</td> <td>1 = Channel CH12 is routed to a local power unit.</td> </tr> <tr> <td>12...15</td> <td>Reserved</td> <td></td> </tr> </tbody> </table>				Bit	Name	Description	0	ch1	0	1	ch2	1 = Channel CH2 is routed to the local power unit (which is connected to CH1).	11	ch12	1 = Channel CH12 is routed to a local power unit.	12...15	Reserved	
Bit	Name	Description																			
0	ch1	0																			
1	ch2	1 = Channel CH2 is routed to the local power unit (which is connected to CH1).																			
...																			
11	ch12	1 = Channel CH12 is routed to a local power unit.																			
12...15	Reserved																				
0000h...FFFFh		Selection of routed BCU channels.	1 = 1																		

No.	Name/Value	Description	Def/FbEq16																																																			
195.20	<i>HW options word 1</i>	Specifies hardware-related options that require differentiated parameter defaults. Activating a bit in this parameter makes the necessary changes in other parameters.	-																																																			
		<table border="1"> <thead> <tr> <th>Bit</th> <th>Name</th> <th>Information</th> </tr> </thead> <tbody> <tr> <td>0</td> <td>Reserved.</td> <td></td> </tr> <tr> <td>1</td> <td>Reserved.</td> <td></td> </tr> <tr> <td>2</td> <td>Internally charged</td> <td><i>(Only visible with a ZCU control unit)</i> Internal charging in use. Reserved for future purposes, activating this bit may lead to hardware failure. Do not use!</td> </tr> <tr> <td>3</td> <td>RO2 for -07 cabinet cooling fan</td> <td>Configures RO2 for cabinet cooling fan. Sets parameters 110.27 RO2 source and 110.29 RO2 OFF delay write-protected.</td> </tr> <tr> <td>4</td> <td>Internally powered control unit</td> <td>1 = Yes. (Sets parameter 195.04 Control board supply to Internal 24V.)</td> </tr> <tr> <td>5</td> <td>Reserved.</td> <td></td> </tr> <tr> <td>6</td> <td>Off grid enable</td> <td>1 = Optimal grid control functionality active. For more information, see <i>Optimal grid control of ACS880 IGBT supply control program supplement</i> (3AXD50000164745 [English]).</td> </tr> <tr> <td>7</td> <td>Reserved.</td> <td></td> </tr> <tr> <td>8</td> <td>Service switch</td> <td>Service switch is wired to DI6. Sets parameter 131.01 External event 1 source to DI6.</td> </tr> <tr> <td>9</td> <td>Reserved.</td> <td></td> </tr> <tr> <td>10</td> <td>Brake resistor, IP54 fan</td> <td>Brake resistor Klixon from SAFUR and IP54 fan Klixon are connected in series to DI11. Sets parameter 120.12 Run enable 1 source to 110.01, bit 15.</td> </tr> <tr> <td>11</td> <td>INU-ISU communication via RDCO</td> <td>Enables DDCS communication with ACS880 inverter. Selects DDCS controller as the control source, enables the communication and configures required dataset parameters.</td> </tr> <tr> <td>12</td> <td>Reserved.</td> <td></td> </tr> <tr> <td>13</td> <td>DIO1 for brake chopper feedback</td> <td>Reserved.</td> </tr> <tr> <td>14</td> <td>DOL fan control</td> <td>Direct-on-line cooling fan is used.</td> </tr> <tr> <td>15</td> <td>ACS880LC</td> <td>Sets parameter 111.09 DIO2 function to Input, 131.38 Fuse trip fault source to DIO2, 131.32 Aux circuit breaker fault source to DI4 and 206.01 I/O bus enable to Yes.</td> </tr> </tbody> </table>	Bit	Name	Information	0	Reserved.		1	Reserved.		2	Internally charged	<i>(Only visible with a ZCU control unit)</i> Internal charging in use. Reserved for future purposes, activating this bit may lead to hardware failure. Do not use!	3	RO2 for -07 cabinet cooling fan	Configures RO2 for cabinet cooling fan. Sets parameters 110.27 RO2 source and 110.29 RO2 OFF delay write-protected.	4	Internally powered control unit	1 = Yes. (Sets parameter 195.04 Control board supply to Internal 24V.)	5	Reserved.		6	Off grid enable	1 = Optimal grid control functionality active. For more information, see <i>Optimal grid control of ACS880 IGBT supply control program supplement</i> (3AXD50000164745 [English]).	7	Reserved.		8	Service switch	Service switch is wired to DI6. Sets parameter 131.01 External event 1 source to DI6 .	9	Reserved.		10	Brake resistor, IP54 fan	Brake resistor Klixon from SAFUR and IP54 fan Klixon are connected in series to DI11. Sets parameter 120.12 Run enable 1 source to 110.01 , bit 15.	11	INU-ISU communication via RDCO	Enables DDCS communication with ACS880 inverter. Selects DDCS controller as the control source, enables the communication and configures required dataset parameters.	12	Reserved.		13	DIO1 for brake chopper feedback	Reserved.	14	DOL fan control	Direct-on-line cooling fan is used.	15	ACS880LC	Sets parameter 111.09 DIO2 function to Input , 131.38 Fuse trip fault source to DIO2 , 131.32 Aux circuit breaker fault source to DI4 and 206.01 I/O bus enable to Yes.	
Bit	Name	Information																																																				
0	Reserved.																																																					
1	Reserved.																																																					
2	Internally charged	<i>(Only visible with a ZCU control unit)</i> Internal charging in use. Reserved for future purposes, activating this bit may lead to hardware failure. Do not use!																																																				
3	RO2 for -07 cabinet cooling fan	Configures RO2 for cabinet cooling fan. Sets parameters 110.27 RO2 source and 110.29 RO2 OFF delay write-protected.																																																				
4	Internally powered control unit	1 = Yes. (Sets parameter 195.04 Control board supply to Internal 24V.)																																																				
5	Reserved.																																																					
6	Off grid enable	1 = Optimal grid control functionality active. For more information, see <i>Optimal grid control of ACS880 IGBT supply control program supplement</i> (3AXD50000164745 [English]).																																																				
7	Reserved.																																																					
8	Service switch	Service switch is wired to DI6. Sets parameter 131.01 External event 1 source to DI6 .																																																				
9	Reserved.																																																					
10	Brake resistor, IP54 fan	Brake resistor Klixon from SAFUR and IP54 fan Klixon are connected in series to DI11. Sets parameter 120.12 Run enable 1 source to 110.01 , bit 15.																																																				
11	INU-ISU communication via RDCO	Enables DDCS communication with ACS880 inverter. Selects DDCS controller as the control source, enables the communication and configures required dataset parameters.																																																				
12	Reserved.																																																					
13	DIO1 for brake chopper feedback	Reserved.																																																				
14	DOL fan control	Direct-on-line cooling fan is used.																																																				
15	ACS880LC	Sets parameter 111.09 DIO2 function to Input , 131.38 Fuse trip fault source to DIO2 , 131.32 Aux circuit breaker fault source to DI4 and 206.01 I/O bus enable to Yes.																																																				
	0000h...FFFFh	Hardware options configuration word.	1 = 1																																																			
195.30	<i>Parallel type list filter</i>	<i>(Only visible with a BCU control unit)</i> Filters the list of drive/supply unit types listed by parameter 195.31 Parallel connection rating id .	<i>No filter</i>																																																			
	No filter	All types listed.	1																																																			
	-3 (380-415V)	-3 (380...415 V) types listed.	2																																																			
	-5 (380-500V)	-5 (380...500 V) types listed.	3																																																			
	-7 (525-690V)	-7 (525...690 V) types listed.	4																																																			
195.31	<i>Parallel connection rating id</i>	<i>(Only visible with a BCU control unit)</i> Defines the drive/supply unit type if it consists of parallel-connected modules. If the drive/supply unit consists of a single module, leave the value at <i>Not selected</i> .	<i>Not selected</i>																																																			
	Not selected	The drive/supply unit does not consist of parallel-connected modules, or type not selected.	0																																																			
	[Drive/supply unit type]	Drive/supply unit type consisting of parallel-connected modules.	-																																																			

No.	Name/Value	Description	Def/FbEq16														
195.51	<i>Current offset calibration</i>	Disables/enables the current offset calibration. In calibration, the current is measured and averaged for 500 ms. Measured value is considered as current offset and it is reduced from actual measurement values. Automatic mode is strongly recommended if AC mode is used. Otherwise default selection <i>No</i> is recommended.	<i>No</i>														
	No	Disabled.	0														
	Automatic	Automatic current offset calibration is enabled.	1														
196 System		Language selection; parameter save and restore; control unit reboot; user lock.															
196.01	<i>Language</i>	Selects the language of the parameter interface and other displayed information.	<i>Not selected</i>														
	Not selected	None.	0														
	English	English.	1033														
196.02	<i>Pass code</i>	Pass codes can be entered into this parameter to activate further access levels (see parameter <i>196.03 Access levels active</i>) or to configure the user lock. Entering "358" toggles the parameter lock, which prevents the changing of all other parameters through the control panel or the Drive composer PC tool. Entering the user pass code (by default, "10000000") enables parameters <i>196.100...196.102</i> , which can be used to define a new user pass code and to select the actions that are to be prevented. Entering an invalid pass code will close the user lock if open, ie. hide parameters <i>196.100...196.102</i> . After entering the code, check that the parameters are in fact hidden. If they are not, enter another (random) pass code. Entering several invalid pass codes introduces a delay before a new attempt can be made. Entering further invalid codes will progressively lengthen the delay. Note: You must change the default user pass code to maintain a high level of cybersecurity. <u>Store the code in a safe place – the protection cannot be disabled even by ABB if the code is lost.</u> See also section <i>User lock</i> (page 42).	1														
	0...99999999	Pass code.	1 = 1														
196.03	<i>Access levels active</i>	Shows which access levels have been activated by pass codes entered into parameter <i>196.02 Pass code</i> . <table border="1" data-bbox="501 1565 1027 1794"> <thead> <tr> <th>Bit</th> <th>Name</th> </tr> </thead> <tbody> <tr> <td>0</td> <td>End user</td> </tr> <tr> <td>1</td> <td>Service</td> </tr> <tr> <td>2</td> <td>Advanced users</td> </tr> <tr> <td>3...13</td> <td>Reserved.</td> </tr> <tr> <td>14</td> <td>Parameter lock</td> </tr> <tr> <td>15</td> <td>Reserved.</td> </tr> </tbody> </table>	Bit	Name	0	End user	1	Service	2	Advanced users	3...13	Reserved.	14	Parameter lock	15	Reserved.	001b
Bit	Name																
0	End user																
1	Service																
2	Advanced users																
3...13	Reserved.																
14	Parameter lock																
15	Reserved.																
	000b...111b	Active access levels.	-														
196.06	<i>Parameter restore</i>	Restores the original settings of the control program, ie. parameter default values. Note: This parameter cannot be changed while the IGBT supply unit is running.	<i>Done</i>														
	Done	Restoring is completed.	0														

No.	Name/Value	Description	Def/FbEq16
	Restore defaults	All editable parameter values are restored to default values, except <ul style="list-style-type: none"> • I/O extension module settings • control panel/PC communication settings • fieldbus adapter settings • parameter 195.01 Supply voltage • parameter 195.20 HW options word 1 and the differentiated defaults implemented by it. 	8
	Clear all	All editable parameter values are restored to default values, except <ul style="list-style-type: none"> • control panel/PC communication settings • parameter 195.01 Supply voltage • parameter 195.20 HW options word 1 and the differentiated defaults implemented by it. PC tool communication is interrupted during the restoring.	62
	Reset all fieldbus settings	Fieldbus adapter settings (parameter groups 150...156) are restored to default values. This will also restore the default settings of the fieldbus adapter if one is connected.	32
196.07	Parameter save manually	Saves the valid parameter values to memory. Note: A new parameter value is saved automatically when changed from the PC tool or panel but not when altered through a fieldbus adapter connection.	Done
	Done	Save completed.	0
	Save	Save in progress.	1
196.08	Control board boot	Changing the value of this parameter to 1 reboots the control unit. The value reverts to 0 automatically.	0
	0...1	1 = Reboot control unit.	1 = 1
196.10	User set status	Shows the status of the user parameter sets. This parameter is read-only. See also section User parameter sets (page 41).	n/a
	n/a	No user parameter sets have been saved.	0
	Loading	A user set is being loaded.	1
	Saving	A user set is being saved.	2
	Faulted	Invalid or empty parameter set.	3
	User set 1	User set 1 has been loaded.	4
	User set 2	User set 2 has been loaded.	5
	User set 3	User set 3 has been loaded.	6
	User set 4	User set 4 has been loaded.	7

No.	Name/Value	Description	Def/FbEq16															
196.11	<i>User set save/load</i>	<p>Enables the saving and restoring of up to four custom sets of parameter settings. See section <i>User parameter sets</i> (page 41).</p> <p>The set that was in use before powering down the IGBT supply unit is in use after the next power-up.</p> <p>Notes:</p> <ul style="list-style-type: none"> Some hardware configuration settings, such as I/O extension module and fieldbus configuration parameters (groups 114...116 and 151...156), and parameters <i>150.01</i> and <i>150.31</i>, and forced input/output values (such as <i>110.03</i> and <i>110.04</i>) are not included in user parameter sets. Parameter changes made after loading a set are not automatically stored – they must be saved using this parameter. If no sets have been saved, attempting to load a set will create all sets from the currently active parameter settings. Switching between sets is only possible with the supply unit stopped. 	<i>No action</i>															
	No action	Load or save operation complete; normal operation.	0															
	IO mode	Load user parameter set using parameters <i>196.12 User set I/O mode in1</i> and <i>196.13 User set I/O mode in2</i> .	1															
	Load set 1	Load user parameter set 1.	2															
	Load set 2	Load user parameter set 2.	3															
	Load set 3	Load user parameter set 3.	4															
	Load set 4	Load user parameter set 4.	5															
	Save to set 1	Save user parameter set 1.	18															
	Save to set 2	Save user parameter set 2.	19															
	Save to set 3	Save user parameter set 3.	20															
	Save to set 4	Save user parameter set 4.	21															
196.12	<i>User set I/O mode in1</i>	<p>When parameter <i>196.11 User set save/load</i> is set to <i>IO mode</i>, selects the user parameter set together with parameter <i>196.13 User set I/O mode in2</i> as follows:</p> <table border="1" data-bbox="502 1377 1133 1646"> <thead> <tr> <th>Status of source defined by par. <i>196.12</i></th> <th>Status of source defined by par. <i>196.13</i></th> <th>User parameter set selected</th> </tr> </thead> <tbody> <tr> <td>0</td> <td>0</td> <td>Set 1</td> </tr> <tr> <td>1</td> <td>0</td> <td>Set 2</td> </tr> <tr> <td>0</td> <td>1</td> <td>Set 3</td> </tr> <tr> <td>1</td> <td>1</td> <td>Set 4</td> </tr> </tbody> </table>	Status of source defined by par. <i>196.12</i>	Status of source defined by par. <i>196.13</i>	User parameter set selected	0	0	Set 1	1	0	Set 2	0	1	Set 3	1	1	Set 4	<i>Off</i>
Status of source defined by par. <i>196.12</i>	Status of source defined by par. <i>196.13</i>	User parameter set selected																
0	0	Set 1																
1	0	Set 2																
0	1	Set 3																
1	1	Set 4																
	Off	0.	0															
	On	1.	1															
	DI1	Digital input DI1 (<i>110.02 DI delayed status</i> , bit 0).	2															
	DI2	Digital input DI2 (<i>110.02 DI delayed status</i> , bit 1).	3															
	DI3	Digital input DI3 (<i>110.02 DI delayed status</i> , bit 2).	4															
	DI4	Digital input DI4 (<i>110.02 DI delayed status</i> , bit 3).	5															
	DI5	Digital input DI5 (<i>110.02 DI delayed status</i> , bit 4).	6															
	DI6	Digital input DI6 (<i>110.02 DI delayed status</i> , bit 5).	7															
	DIO1	Digital input/output DIO1 (<i>111.02 DIO delayed status</i> , bit 0).	10															
	DIO2	Digital input/output DIO2 (<i>111.02 DIO delayed status</i> , bit 1).	11															
	<i>Other</i>	Source selection (see <i>Terms and abbreviations</i> on page 61).	-															

No.	Name/Value	Description	Def/FbEq16
196.13	<i>User set I/O mode in2</i>	See parameter <i>196.12 User set I/O mode in1</i> .	Off
196.20	<i>Time sync primary source</i>	Defines the 1st priority external source for synchronization of the unit's time and date.	DDCS Controller
	Internal	No external source selected.	0
	DDCS Controller	External controller.	1
	Fieldbus A or B	Fieldbus interface A or B.	2
	Fieldbus A	Fieldbus interface A.	3
	Fieldbus B	Fieldbus interface B.	4
	D2D or M/F	The master station on a master/follower or drive-to-drive link.	5
	Panel link	Control panel, or Drive composer PC tool connected to the control panel.	8
	Ethernet tool link	Drive composer PC tool through an FENA-xx module.	9
	FA2FA	Another control program.	10
196.24	<i>Full days since 1st Jan 1980</i>	Number of full days passed since beginning of the year 1980. This parameter, together with <i>196.25 Time in minutes within 24 h</i> and <i>196.26 Time in ms within one minute</i> makes it possible to set the date and time in the drive via the parameter interface from a fieldbus or application program. This may be necessary if the fieldbus protocol does not support time synchronization.	-
	1...59999	Days since beginning of 1980.	1 = 1
196.25	<i>Time in minutes within 24 h</i>	Number of full minutes passed since midnight. For example, the value 860 corresponds to 2:20 pm. See parameter <i>196.24 Full days since 1st Jan 1980</i> .	0 min
	1...1439	Minutes since midnight.	1 = 1
196.26	<i>Time in ms within one minute</i>	Number of milliseconds passed since last minute. See parameter <i>196.24 Full days since 1st Jan 1980</i> .	0 ms
	0...59999	Number of milliseconds since last minute.	1 = 1

No.	Name/Value	Description	Def/FbEq16																																																			
196.29	<i>Time sync source status</i>	Time source status word. This parameter is read-only.	-																																																			
<table border="1"> <thead> <tr> <th>Bit</th> <th>Name</th> <th>Description</th> </tr> </thead> <tbody> <tr> <td>0</td> <td>Time tick received</td> <td>1 = 1st priority tick received: Tick has been received from 1st priority source.</td> </tr> <tr> <td>1</td> <td>Aux Time tick received</td> <td>1 = 2nd priority tick received: Tick has been received from 2nd priority source.</td> </tr> <tr> <td>2</td> <td>Tick interval is too long</td> <td>1 = Yes: Tick interval too long (accuracy compromised).</td> </tr> <tr> <td>3</td> <td>DDCS controller</td> <td>1 = Tick received: Tick has been received from an external controller.</td> </tr> <tr> <td>4</td> <td>Master/Follower</td> <td>1 = Tick received: Tick has been received through the master/follower link.</td> </tr> <tr> <td>5</td> <td>Reserved.</td> <td></td> </tr> <tr> <td>6</td> <td>D2D</td> <td>1 = Tick received: Tick has been received through the drive-to-drive link.</td> </tr> <tr> <td>7</td> <td>FbusA</td> <td>1 = Tick received: Tick has been received through fieldbus interface A.</td> </tr> <tr> <td>8</td> <td>FbusB</td> <td>1 = Tick received: Tick has been received through fieldbus interface B.</td> </tr> <tr> <td>9</td> <td>EFB</td> <td>1 = Tick received: Tick has been received through the embedded fieldbus interface.</td> </tr> <tr> <td>10</td> <td>Reserved.</td> <td></td> </tr> <tr> <td>11</td> <td>Panel link</td> <td>1 = Tick received: Tick has been received from the control panel, or Drive composer PC tool connected to the control panel.</td> </tr> <tr> <td>12</td> <td>Ethernet tool link</td> <td>1 = Tick received: Tick has been received from Drive composer PC tool through an FENA-xx module.</td> </tr> <tr> <td>13</td> <td>Parameter setting</td> <td>1 = Tick received: Tick has been set by parameters 196.24...196.26.</td> </tr> <tr> <td>14</td> <td>RTC</td> <td>1 = RTC time in use: Time and date have been read from the real-time clock.</td> </tr> <tr> <td>15</td> <td>Drive On-Time</td> <td>1 = Drive on-time in use: Time and date are displaying drive on-time.</td> </tr> </tbody> </table>				Bit	Name	Description	0	Time tick received	1 = 1st priority tick received: Tick has been received from 1st priority source.	1	Aux Time tick received	1 = 2nd priority tick received: Tick has been received from 2nd priority source.	2	Tick interval is too long	1 = Yes: Tick interval too long (accuracy compromised).	3	DDCS controller	1 = Tick received: Tick has been received from an external controller.	4	Master/Follower	1 = Tick received: Tick has been received through the master/follower link.	5	Reserved.		6	D2D	1 = Tick received: Tick has been received through the drive-to-drive link.	7	FbusA	1 = Tick received: Tick has been received through fieldbus interface A.	8	FbusB	1 = Tick received: Tick has been received through fieldbus interface B.	9	EFB	1 = Tick received: Tick has been received through the embedded fieldbus interface.	10	Reserved.		11	Panel link	1 = Tick received: Tick has been received from the control panel, or Drive composer PC tool connected to the control panel.	12	Ethernet tool link	1 = Tick received: Tick has been received from Drive composer PC tool through an FENA-xx module.	13	Parameter setting	1 = Tick received: Tick has been set by parameters 196.24...196.26 .	14	RTC	1 = RTC time in use: Time and date have been read from the real-time clock.	15	Drive On-Time	1 = Drive on-time in use: Time and date are displaying drive on-time.
Bit	Name	Description																																																				
0	Time tick received	1 = 1st priority tick received: Tick has been received from 1st priority source.																																																				
1	Aux Time tick received	1 = 2nd priority tick received: Tick has been received from 2nd priority source.																																																				
2	Tick interval is too long	1 = Yes: Tick interval too long (accuracy compromised).																																																				
3	DDCS controller	1 = Tick received: Tick has been received from an external controller.																																																				
4	Master/Follower	1 = Tick received: Tick has been received through the master/follower link.																																																				
5	Reserved.																																																					
6	D2D	1 = Tick received: Tick has been received through the drive-to-drive link.																																																				
7	FbusA	1 = Tick received: Tick has been received through fieldbus interface A.																																																				
8	FbusB	1 = Tick received: Tick has been received through fieldbus interface B.																																																				
9	EFB	1 = Tick received: Tick has been received through the embedded fieldbus interface.																																																				
10	Reserved.																																																					
11	Panel link	1 = Tick received: Tick has been received from the control panel, or Drive composer PC tool connected to the control panel.																																																				
12	Ethernet tool link	1 = Tick received: Tick has been received from Drive composer PC tool through an FENA-xx module.																																																				
13	Parameter setting	1 = Tick received: Tick has been set by parameters 196.24...196.26 .																																																				
14	RTC	1 = RTC time in use: Time and date have been read from the real-time clock.																																																				
15	Drive On-Time	1 = Drive on-time in use: Time and date are displaying drive on-time.																																																				
0000h...FFFFh		Time source status word 1.	1 = 1																																																			
196.39	<i>Power up event logging</i>	Enables/disables power-up logging. When enabled, an event (<i>BE08 Power up</i>) is logged by the IGBT supply unit upon each power-up.	<i>Enable</i>																																																			
Disable		Power-up event logging disabled.	0																																																			
Enable		Power-up event logging enabled.	1																																																			
196.61	<i>User data logger status word</i>	Provides status information on the user data logger (see page 225).	0000b																																																			
<table border="1"> <thead> <tr> <th>Bit</th> <th>Name</th> <th>Description</th> </tr> </thead> <tbody> <tr> <td>0</td> <td>Running</td> <td>1 = The user data logger is running. The bit is cleared after the post-trigger time has passed.</td> </tr> <tr> <td>1</td> <td>Triggered</td> <td>1 = The user data logger has been triggered. The bit is cleared when the logger is restarted.</td> </tr> <tr> <td>2</td> <td>Data available</td> <td>1 = The user data logger contains data that can be read. Note that the bit is not cleared because the data is saved to the memory unit.</td> </tr> <tr> <td>3</td> <td>Configured</td> <td>1 = The user data logger has been configured. Note that the bit is not cleared because the configuration data is saved to the memory unit.</td> </tr> <tr> <td>4...15</td> <td>Reserved</td> <td></td> </tr> </tbody> </table>				Bit	Name	Description	0	Running	1 = The user data logger is running. The bit is cleared after the post-trigger time has passed.	1	Triggered	1 = The user data logger has been triggered. The bit is cleared when the logger is restarted.	2	Data available	1 = The user data logger contains data that can be read. Note that the bit is not cleared because the data is saved to the memory unit.	3	Configured	1 = The user data logger has been configured. Note that the bit is not cleared because the configuration data is saved to the memory unit.	4...15	Reserved																																		
Bit	Name	Description																																																				
0	Running	1 = The user data logger is running. The bit is cleared after the post-trigger time has passed.																																																				
1	Triggered	1 = The user data logger has been triggered. The bit is cleared when the logger is restarted.																																																				
2	Data available	1 = The user data logger contains data that can be read. Note that the bit is not cleared because the data is saved to the memory unit.																																																				
3	Configured	1 = The user data logger has been configured. Note that the bit is not cleared because the configuration data is saved to the memory unit.																																																				
4...15	Reserved																																																					
0000b...1111b		User data logger status word.	1 = 1																																																			

No.	Name/Value	Description	Def/FbEq16
196.63	<i>User data logger trigger</i>	Triggers, or selects a source that triggers, the user data logger.	<i>Off</i>
	Off	0.	0
	On	1.	1
	<i>Other</i>	Source selection (see <i>Terms and abbreviations</i> on page 61).	-
196.64	<i>User data logger start</i>	Starts, or selects a source that starts, the user data logger.	<i>Off</i>
	Off	0.	0
	On	1.	1
	<i>Other</i>	Source selection (see <i>Terms and abbreviations</i> on page 61).	-
196.65	<i>Factory data logger time level</i>	Selects the sampling interval for the factory data logger (see page 225).	<i>500us</i>
	500us	500 microseconds.	500
	2ms	2 milliseconds.	2000
	10ms	10 milliseconds.	10000
196.70	<i>Disable adaptive program</i>	Enables/disables the adaptive program (if present). See also section <i>Adaptive programming</i> (page 25).	<i>No</i>
	No	Adaptive program enabled.	0
	Yes	Adaptive program disabled.	1
196.100	<i>Change user pass code</i>	<i>(Visible when user lock is open)</i> To change the current user pass code, enter a new code into this parameter as well as <i>196.101 Confirm user pass code</i> . A warning will be active until the new pass code is confirmed. To cancel changing the pass code, close the user lock without confirming. To close the lock, enter an invalid pass code in parameter <i>196.02 Pass code</i> , activate parameter <i>196.08 Control board boot</i> , or cycle the power. See also section <i>User lock</i> (page 42).	10000000
	10000000... 99999999	New user pass code.	-
196.101	<i>Confirm user pass code</i>	<i>(Visible when user lock is open)</i> Confirms the new user pass code entered in <i>196.100 Change user pass code</i> .	
	10000000... 99999999	Confirmation of new user pass code.	-

No.	Name/Value	Description	Def/FbEq16																																							
196.102	<i>User lock functionality</i>	(Visible when user lock is open) Selects the actions or functionalities to be prevented by the user lock. Note that the changes made take effect only when the user lock is closed. See parameter 196.02 Pass code . Note: We recommend you select all the actions and functionalities unless otherwise required by the application.	1000b																																							
<table border="1"> <thead> <tr> <th>Bit</th> <th>Name</th> <th>Information</th> </tr> </thead> <tbody> <tr> <td>0</td> <td>Disable ABB access levels</td> <td>1 = ABB access levels (service, advanced programmer, etc.; see 196.03) disabled</td> </tr> <tr> <td>1</td> <td>Freeze parameter lock state</td> <td>1 = Changing the parameter lock state prevented, ie. pass code 358 has no effect</td> </tr> <tr> <td>2</td> <td>Disable file download</td> <td>1 = Loading of files to drive prevented. This applies to <ul style="list-style-type: none"> • firmware upgrades • safety functions module configuration • parameter restore • loading an adaptive program • loading and debugging an application program • changing home view of control panel • editing drive texts • editing the favorite parameters list on control panel • configuration settings made through control panel such as time/date formats and enabling/disabling clock display. </td> </tr> <tr> <td>3</td> <td>Disable FB write to hidden</td> <td>1 = Access to parameters on disabled access levels from fieldbus prevented.</td> </tr> <tr> <td>4...5</td> <td colspan="2">Reserved</td> </tr> <tr> <td>6</td> <td>Protect AP</td> <td>1 = Creating a backup and restoring from a backup prevented.</td> </tr> <tr> <td>7</td> <td>Disable panel Bluetooth</td> <td>1 = Bluetooth disabled on ACS-AP-W control panel. If the drive is part of a panel bus, Bluetooth is disabled on all panels.</td> </tr> <tr> <td>8...10</td> <td colspan="2">Reserved</td> </tr> <tr> <td>11</td> <td>Disable OEM access level 1</td> <td>1 = OEM access level 1 disabled</td> </tr> <tr> <td>12</td> <td>Disable OEM access level 2</td> <td>1 = OEM access level 2 disabled</td> </tr> <tr> <td>13</td> <td>Disable OEM access level 3</td> <td>1 = OEM access level 3 disabled</td> </tr> <tr> <td>14...15</td> <td colspan="2">Reserved</td> </tr> </tbody> </table>				Bit	Name	Information	0	Disable ABB access levels	1 = ABB access levels (service, advanced programmer, etc.; see 196.03) disabled	1	Freeze parameter lock state	1 = Changing the parameter lock state prevented, ie. pass code 358 has no effect	2	Disable file download	1 = Loading of files to drive prevented. This applies to <ul style="list-style-type: none"> • firmware upgrades • safety functions module configuration • parameter restore • loading an adaptive program • loading and debugging an application program • changing home view of control panel • editing drive texts • editing the favorite parameters list on control panel • configuration settings made through control panel such as time/date formats and enabling/disabling clock display. 	3	Disable FB write to hidden	1 = Access to parameters on disabled access levels from fieldbus prevented.	4...5	Reserved		6	Protect AP	1 = Creating a backup and restoring from a backup prevented.	7	Disable panel Bluetooth	1 = Bluetooth disabled on ACS-AP-W control panel. If the drive is part of a panel bus, Bluetooth is disabled on all panels.	8...10	Reserved		11	Disable OEM access level 1	1 = OEM access level 1 disabled	12	Disable OEM access level 2	1 = OEM access level 2 disabled	13	Disable OEM access level 3	1 = OEM access level 3 disabled	14...15	Reserved	
Bit	Name	Information																																								
0	Disable ABB access levels	1 = ABB access levels (service, advanced programmer, etc.; see 196.03) disabled																																								
1	Freeze parameter lock state	1 = Changing the parameter lock state prevented, ie. pass code 358 has no effect																																								
2	Disable file download	1 = Loading of files to drive prevented. This applies to <ul style="list-style-type: none"> • firmware upgrades • safety functions module configuration • parameter restore • loading an adaptive program • loading and debugging an application program • changing home view of control panel • editing drive texts • editing the favorite parameters list on control panel • configuration settings made through control panel such as time/date formats and enabling/disabling clock display. 																																								
3	Disable FB write to hidden	1 = Access to parameters on disabled access levels from fieldbus prevented.																																								
4...5	Reserved																																									
6	Protect AP	1 = Creating a backup and restoring from a backup prevented.																																								
7	Disable panel Bluetooth	1 = Bluetooth disabled on ACS-AP-W control panel. If the drive is part of a panel bus, Bluetooth is disabled on all panels.																																								
8...10	Reserved																																									
11	Disable OEM access level 1	1 = OEM access level 1 disabled																																								
12	Disable OEM access level 2	1 = OEM access level 2 disabled																																								
13	Disable OEM access level 3	1 = OEM access level 3 disabled																																								
14...15	Reserved																																									
0000h...FFFFh		Selection of actions to be prevented by user lock.	-																																							
197 Grid control		Configuration of the active damping functionality.																																								
197.20	<i>Dc-ctrl active damping</i>	Enables/disables the active damping functionality. See section Active damping on page 60.	Yes																																							
No		Active damping functionality disabled.	0																																							
Yes		Active damping functionality enabled. This is the default selection for BCU control units.	1																																							
199 Off grid configuration		Configuration of the optimal grid control functionality.																																								
This parameter group contains parameters related to configuration of the optimal grid control functionality (option +N8053). For details on the parameters in this group, see <i>Optimal grid control of ACS880 IGBT supply control program supplement</i> (3AXD50000164745 [English]).																																										

No.	Name/Value	Description	Def/FbEq16
	206 I/O bus configuration	Distributed I/O bus settings.	
	207 I/O bus service	Distributed I/O bus settings.	
	208 I/O bus diagnostics	Distributed I/O bus settings.	
	209 I/O bus fan identification	Distributed I/O bus settings.	
<p><i>(Groups only visible with a BCU control unit)</i> These groups contain parameters related to the distributed I/O bus, which is used with some drives for monitoring the cooling fans of the cabinet system. For details, see <i>CIO-01 I/O module for distributed I/O bus control user's manual</i> (3AXD50000126880 [English]).</p>			

7

Additional parameter data

What this chapter contains

This chapter lists the parameters with some additional data. For parameter descriptions, see chapter [Parameters](#) (page 61).

Terms and abbreviations

Term	Definition
Actual signal	Signal measured or calculated by the IGBT supply unit. Usually can only be monitored but not adjusted; some counter-type signals can however be reset.
Analog src	The parameter can be set to the value of another parameter by choosing “Other”, and selecting the source parameter from a list. In addition to the “Other” selection, the parameter may offer other pre-selected settings.
Binary src	The value of the parameter can be taken from a specific bit in another parameter value (“Other”). Sometimes the value can be fixed to 0 (false) or 1 (true). In addition, the parameter may offer other pre-selected settings.
Data	Data parameter.
FbEq32	32-bit fieldbus equivalent: The scaling between the integer used in communication and the value shown on the panel when a 32-bit value is selected for transmission to an external system. The corresponding 16-bit scalings are listed in chapter Parameters (page 61).
List	Selection list.
No.	Parameter number.
PB	Packed Boolean (bit list).
Real	Real number.

Term	Definition
Type	Parameter type. See Analog src , Binary src , List , PB , Real .

Fieldbus addresses

Refer to the *User's manual* of the fieldbus adapter.

Parameter groups 101...107

No.	Name	Type	Range	Unit	FbEq32
101 Actual values					
101.01	DC voltage	<i>Real</i>	0.00 ... 2000.00	V	100 = 1 V
101.02	Line current	<i>Real</i>	-	A	100 = 1 A
101.03	Line current %	<i>Real</i>	0.0 ... 1000.0	%	10 = 1%
101.04	Active current	<i>Real</i>	-	A	100 = 1 A
101.05	Active current %	<i>Real</i>	-1000.0 ... 1000.0	%	10 = 1%
101.06	Reactive current	<i>Real</i>	-	A	100 = 1 A
101.07	Reactive current %	<i>Real</i>	-1000.0 ... 1000.0	%	10 = 1%
101.08	Frequency	<i>Real</i>	0.00 ... 100.00	Hz	100 = 1 Hz
101.09	Grid voltage	<i>Real</i>	0.00...1000.00	V	100 = 1 V
101.10	Apparent power	<i>Real</i>	-	kVA	100 = 1 kVA
101.11	Apparent power %	<i>Real</i>	-1000.0 ... 1000.0	%	10 = 1%
101.12	Power	<i>Real</i>	-	kW	100 = 1 kW
101.13	Power %	<i>Real</i>	-1000.0 ... 1000.0	%	10 = 1%
101.14	Reactive power	<i>Real</i>	-	kVAr	100 = 1 kVAr
101.15	Reactive power %	<i>Real</i>	-1000.0 ... 1000.0	%	10 = 1%
101.16	CosPhi	<i>Real</i>	-1.00 ... 1.00	-	100 = 1
101.20	Converter current	<i>Real</i>	-	A	100 = 1 A
101.21	Converter current %	<i>Real</i>	0.0...1000.0	%	10 = 1%
101.22	kWh supply	<i>Real</i>	0...1000	kWh	1 = 1 kWh
101.23	MWh supply	<i>Real</i>	0...1000	MWh	1 = 1 MWh
101.24	GWh supply	<i>Real</i>	-32768...32767	GWh	1 = 1 GWh
101.25	kWh motoring	<i>Real</i>	0...1000	kWh	1 = 1 kWh
101.26	MWh motoring	<i>Real</i>	0...1000	MWh	1 = 1 MWh
101.27	GWh motoring	<i>Real</i>	0...32767	GWh	1 = 1 GWh
101.28	kWh generating	<i>Real</i>	0...1000	kWh	1 = 1 kWh
101.29	MWh generating	<i>Real</i>	0...1000	MWh	1 = 1 MWh
101.30	GWh generating	<i>Real</i>	0...32767	GWh	1 = 1 GWh
101.31	Ambient temperature	<i>Real</i>	0...100	°C	1 = 1°C
101.33	Reactive power reserve	<i>Real</i>	-30000.00...30000.00	kVAr	100 = 1 kVAr
101.61	Nominal supply voltage	<i>Real</i>	0...2000	V	1 = 1 V
101.62	Nominal DC voltage	<i>Real</i>	0...2000	V	1 = 1 V
101.63	Nominal current	<i>Real</i>	0...30000	A	1 = 1 A
101.64	Nominal power	<i>Real</i>	0...30000	kW	1 = 1 kW
101.70	Ambient temperature %	<i>Real</i>	-200.00...200.00	%	100 = 1%
103 Input references					
103.01	Panel reference	<i>Real</i>	-100000.00 ... 100000.00	-	100 = 1
103.05	FB A reference 1	<i>Real</i>	-100000.00 ... 100000.00	-	100 = 1
103.06	FB A reference 2	<i>Real</i>	-100000.00 ... 100000.00	-	100 = 1
103.07	FB B reference 1	<i>Real</i>	-100000.00 ... 100000.00	-	100 = 1
103.08	FB B reference 2	<i>Real</i>	-100000.00 ... 100000.00	-	100 = 1
103.11	DDCS controller ref 1	<i>Real</i>	-30000.00 ... 30000.00	-	100 = 1
103.12	DDCS controller ref 2	<i>Real</i>	-30000.00 ... 30000.00	-	100 = 1
103.13	M/F or D2D ref1	<i>Real</i>	-30000.00 ... 30000.00	-	100 = 1
103.14	M/F or D2D ref2	<i>Real</i>	-30000.00 ... 30000.00	-	100 = 1

No.	Name	Type	Range	Unit	FbEq32
104 Warnings and faults					
104.01	Tripping fault	<i>Data</i>	0000h...FFFFh	-	1 = 1
104.02	Active fault 2	<i>Data</i>	0000h...FFFFh	-	1 = 1
104.03	Active fault 3	<i>Data</i>	0000h...FFFFh	-	1 = 1
104.04	Active fault 4	<i>Data</i>	0000h...FFFFh	-	1 = 1
104.05	Active fault 5	<i>Data</i>	0000h...FFFFh	-	1 = 1
104.06	Active warning 1	<i>Data</i>	0000h...FFFFh	-	1 = 1
104.07	Active warning 2	<i>Data</i>	0000h...FFFFh	-	1 = 1
104.08	Active warning 3	<i>Data</i>	0000h...FFFFh	-	1 = 1
104.09	Active warning 4	<i>Data</i>	0000h...FFFFh	-	1 = 1
104.10	Active warning 5	<i>Data</i>	0000h...FFFFh	-	1 = 1
104.11	Latest fault	<i>Data</i>	0000h...FFFFh	-	1 = 1
104.12	2nd latest fault	<i>Data</i>	0000h...FFFFh	-	1 = 1
104.13	3rd latest fault	<i>Data</i>	0000h...FFFFh	-	1 = 1
104.14	4th latest fault	<i>Data</i>	0000h...FFFFh	-	1 = 1
104.15	5th latest fault	<i>Data</i>	0000h...FFFFh	-	1 = 1
104.16	Latest warning	<i>Data</i>	0000h...FFFFh	-	1 = 1
104.17	2nd latest warning	<i>Data</i>	0000h...FFFFh	-	1 = 1
104.18	3rd latest warning	<i>Data</i>	0000h...FFFFh	-	1 = 1
104.19	4th latest warning	<i>Data</i>	0000h...FFFFh	-	1 = 1
104.20	5th latest warning	<i>Data</i>	0000h...FFFFh	-	1 = 1
104.21	Fault word 1	<i>Data</i>	0000h...FFFFh	-	1 = 1
104.31	Warning word 1	<i>Data</i>	0000h...FFFFh	-	1 = 1
104.40	Event word 1	<i>Data</i>	0000h...FFFFh	-	1 = 1
104.41	Event word 1 bit 0 code	<i>Data</i>	0000h...FFFFh	-	1 = 1
104.42	Event word 1 bit 0 aux code	<i>Data</i>	0000h...FFFFh	-	1 = 1
104.43	Event word 1 bit 1 code	<i>Data</i>	0000h...FFFFh	-	1 = 1
104.44	Event word 1 bit 1 aux code	<i>Data</i>	0000h...FFFFh	-	1 = 1
104.45	Event word 1 bit 2 code	<i>Data</i>	0000h...FFFFh	-	1 = 1
104.46	Event word 1 bit 2 aux code	<i>Data</i>	0000h...FFFFh	-	1 = 1
104.47	Event word 1 bit 3 code	<i>Data</i>	0000h...FFFFh	-	1 = 1
104.48	Event word 1 bit 3 aux code	<i>Data</i>	0000h...FFFFh	-	1 = 1
104.49	Event word 1 bit 4 code	<i>Data</i>	0000h...FFFFh	-	1 = 1
104.50	Event word 1 bit 4 aux code	<i>Data</i>	0000h...FFFFh	-	1 = 1
104.51	Event word 1 bit 5 code	<i>Data</i>	0000h...FFFFh	-	1 = 1
104.52	Event word 1 bit 5 aux code	<i>Data</i>	0000h...FFFFh	-	1 = 1
104.53	Event word 1 bit 6 code	<i>Data</i>	0000h...FFFFh	-	1 = 1
104.54	Event word 1 bit 6 aux code	<i>Data</i>	0000h...FFFFh	-	1 = 1
104.55	Event word 1 bit 7 code	<i>Data</i>	0000h...FFFFh	-	1 = 1
104.56	Event word 1 bit 7 aux code	<i>Data</i>	0000h...FFFFh	-	1 = 1
104.57	Event word 1 bit 8 code	<i>Data</i>	0000h...FFFFh	-	1 = 1
104.58	Event word 1 bit 8 aux code	<i>Data</i>	0000h...FFFFh	-	1 = 1

No.	Name	Type	Range	Unit	FbEq32
104.59	Event word 1 bit 9 code	<i>Data</i>	0000h...FFFFh	-	1 = 1
104.60	Event word 1 bit 9 aux code	<i>Data</i>	0000h...FFFFh	-	1 = 1
104.61	Event word 1 bit 10 code	<i>Data</i>	0000h...FFFFh	-	1 = 1
104.62	Event word 1 bit 10 aux code	<i>Data</i>	0000h...FFFFh	-	1 = 1
104.63	Event word 1 bit 11 code	<i>Data</i>	0000h...FFFFh	-	1 = 1
104.64	Event word 1 bit 11 aux code	<i>Data</i>	0000h...FFFFh	-	1 = 1
104.65	Event word 1 bit 12 code	<i>Data</i>	0000h...FFFFh	-	1 = 1
104.66	Event word 1 bit 12 aux code	<i>Data</i>	0000h...FFFFh	-	1 = 1
104.67	Event word 1 bit 13 code	<i>Data</i>	0000h...FFFFh	-	1 = 1
104.68	Event word 1 bit 13 aux code	<i>Data</i>	0000h...FFFFh	-	1 = 1
104.69	Event word 1 bit 14 code	<i>Data</i>	0000h...FFFFh	-	1 = 1
104.70	Event word 1 bit 14 aux code	<i>Data</i>	0000h...FFFFh	-	1 = 1
104.71	Event word 1 bit 15 code	<i>Data</i>	0000h...FFFFh	-	1 = 1
104.72	Event word 1 bit 15 aux code	<i>Data</i>	0000h...FFFFh	-	1 = 1
105 Diagnostics					
105.01	On-time counter	<i>Real</i>	0...65535	d	1 = 1 d
105.02	Run-time counter	<i>Real</i>	0...65535	d	1 = 1 d
105.04	Fan on-time counter	<i>Real</i>	0...65535	d	1 = 1 d
105.09	Time from power-up	<i>Real</i>	0...4294967295	-	1 = 1
105.11	Converter temperature %	<i>Real</i>	-40.0 ... 160.0	%	10 = 1%
105.21	MCB closing time counter	<i>Real</i>	0...4294967295	-	1 = 1
105.22	Charging relay operation counter	<i>Real</i>	0...4294967295	-	1 = 1
105.41	Main fan service counter	<i>Real</i>	0...150	%	1 = 1%
105.42	Aux. fan service counter	<i>Real</i>	0...150	%	1 = 1%
106 Control and status words					
106.01	Main control word	<i>PB</i>	0000h...FFFFh	-	1 = 1
106.02	Application control word	<i>PB</i>	0000h...FFFFh	-	1 = 1
106.03	FBA A transparent control word	<i>PB</i>	0...4294967295	-	1 = 1
106.04	FBA B transparent control word	<i>PB</i>	00000000h...FFFFFFFFh	-	
106.11	Main status word	<i>PB</i>	0000h...FFFFh	-	1 = 1
106.16	Drive status word 1	<i>PB</i>	0000h...FFFFh	-	1 = 1
106.17	Drive status word 2	<i>PB</i>	0000h...FFFFh	-	1 = 1
106.18	Start inhibit status word	<i>PB</i>	0000h...FFFFh	-	1 = 1
106.25	Drive inhibit status word 2	<i>PB</i>	0000h...FFFFh	-	1 = 1
106.30	MSW bit 11 sel	<i>Binary src</i>	-	-	1 = 1
106.31	MSW bit 12 sel	<i>Binary src</i>	-	-	1 = 1
106.32	MSW bit 13 sel	<i>Binary src</i>	-	-	1 = 1
106.33	MSW bit 15 sel	<i>Binary src</i>	-	-	1 = 1
106.50	User status word1	<i>PB</i>	-	-	1 = 1
106.60	User status word 1 bit 0 sel	<i>PB</i>	-	-	1 = 1
106.61	User status word 1 bit 1 sel	<i>PB</i>	-	-	1 = 1

No.	Name	Type	Range	Unit	FbEq32
106.62	User status word 1 bit 2 sel	<i>PB</i>	-	-	1 = 1
106.63	User status word 1 bit 3 sel	<i>PB</i>	-	-	1 = 1
106.64	User status word 1 bit 4 sel	<i>PB</i>	-	-	1 = 1
106.65	User status word 1 bit 5 sel	<i>PB</i>	-	-	1 = 1
106.66	User status word 1 bit 6 sel	<i>PB</i>	-	-	1 = 1
106.67	User status word 1 bit 7 sel	<i>PB</i>	-	-	1 = 1
106.68	User status word 1 bit 8 sel	<i>PB</i>	-	-	1 = 1
106.69	User status word 1 bit 9 sel	<i>PB</i>	-	-	1 = 1
106.70	User status word 1 bit 10 sel	<i>PB</i>	-	-	1 = 1
106.71	User status word 1 bit 11 sel	<i>PB</i>	-	-	1 = 1
106.72	User status word 1 bit 12 sel	<i>PB</i>	-	-	1 = 1
106.73	User status word 1 bit 13 sel	<i>PB</i>	-	-	1 = 1
106.74	User status word 1 bit 14 sel	<i>PB</i>	-	-	1 = 1
106.75	User status word 1 bit 15 sel	<i>PB</i>	-	-	1 = 1
106.100	User control word 1	<i>PB</i>	-	-	1 = 1
106.101	User control word 2	<i>PB</i>	-	-	1 = 1
107 System info					
107.03	Drive rating id	<i>List</i>	0...999	-	1 = 1
107.04	Firmware name	<i>List</i>	-	-	1 = 1
107.05	Firmware version	<i>Data</i>	-	-	1 = 1
107.06	Loading package name	<i>List</i>	-	-	1 = 1
107.07	Loading package version	<i>Data</i>	-	-	1 = 1
107.08	Bootloader version	<i>Data</i>	-	-	1 = 1
107.11	Cpu usage	<i>Real</i>	0...100	%	1 = 1%
107.13	PU logic version number	<i>Data</i>	-	-	1 = 1
107.23	Application name	<i>Data</i>	-	-	1 = 1
107.24	Application version	<i>Data</i>	-	-	1 = 1
107.25	Customization package name	<i>Data</i>	-	-	1 = 1
107.26	Customization package version	<i>Data</i>	-	-	1 = 1
107.30	Adaptive program status	<i>Data</i>	0000h...FFFFh	-	1 = 1

Parameter groups 110...209

No.	Name	Type	Range	Unit	FbEq32
110 Standard DI, RO					
110.01	DI status	<i>PB</i>	0000h...FFFFh	-	1 = 1
110.02	DI delayed status	<i>PB</i>	0000h...FFFFh	-	1 = 1
110.03	DI force selection	<i>PB</i>	0000h...FFFFh	-	1 = 1
110.04	DI force data	<i>PB</i>	0000h...FFFFh	-	1 = 1
110.05	DI1 ON delay	<i>Real</i>	0.0 ... 3000.0	s	10 = 1 s
110.06	DI1 OFF delay	<i>Real</i>	0.0 ... 3000.0	s	10 = 1 s
110.07	DI2 ON delay	<i>Real</i>	0.0 ... 3000.0	s	10 = 1 s
110.08	DI2 OFF delay	<i>Real</i>	0.0 ... 3000.0	s	10 = 1 s
110.09	DI3 ON delay	<i>Real</i>	0.0 ... 3000.0	s	10 = 1 s
110.10	DI3 OFF delay	<i>Real</i>	0.0 ... 3000.0	s	10 = 1 s
110.11	DI4 ON delay	<i>Real</i>	0.0 ... 3000.0	s	10 = 1 s
110.12	DI4 OFF delay	<i>Real</i>	0.0 ... 3000.0	s	10 = 1 s
110.13	DI5 ON delay	<i>Real</i>	0.0 ... 3000.0	s	10 = 1 s
110.14	DI5 OFF delay	<i>Real</i>	0.0 ... 3000.0	s	10 = 1 s
110.15	DI6 ON delay	<i>Real</i>	0.0 ... 3000.0	s	10 = 1 s
110.16	DI6 OFF delay	<i>Real</i>	0.0 ... 3000.0	s	10 = 1 s
110.21	RO status	<i>PB</i>	0000h...FFFFh	-	1 = 1
110.24	RO1 source	<i>Binary src</i>	-	-	1 = 1
110.25	RO1 ON delay	<i>Real</i>	0.0 ... 3000.0	s	10 = 1 s
110.26	RO1 OFF delay	<i>Real</i>	0.0 ... 3000.0	s	10 = 1 s
110.27	RO2 source	<i>Binary src</i>	-	-	1 = 1
110.28	RO2 ON delay	<i>Real</i>	0.0 ... 3000.0	s	10 = 1 s
110.29	RO2 OFF delay	<i>Real</i>	0.0 ... 3000.0	s	10 = 1 s
110.30	RO3 source	<i>Binary src</i>	-	-	1 = 1
110.31	RO3 ON delay	<i>Real</i>	0.0 ... 3000.0	s	10 = 1 s
110.32	RO3 OFF delay	<i>Real</i>	0.0 ... 3000.0	s	10 = 1 s
110.51	DI filter time	<i>Real</i>	0.3 ... 100.0	ms	10 = 1 ms
110.99	RO/DIO control word	<i>PB</i>	0000h...FFFFh	-	1 = 1
111 Standard DIO, FI, FO					
111.01	DIO status	<i>PB</i>	0000h...FFFFh	-	1 = 1
111.02	DIO delayed status	<i>PB</i>	0000h...FFFFh	-	1 = 1
111.05	DIO1 function	<i>List</i>	0...2	-	1 = 1
111.06	DIO1 output source	<i>Binary src</i>	-	-	1 = 1
111.07	DIO1 ON delay	<i>Real</i>	0.0 ... 3000.0	s	10 = 1 s
111.08	DIO1 OFF delay	<i>Real</i>	0.0 ... 3000.0	s	10 = 1 s
111.09	DIO2 function	<i>List</i>	0...1	-	1 = 1
111.10	DIO2 output source	<i>Binary src</i>	-	-	1 = 1
111.11	DIO2 ON delay	<i>Real</i>	0.0 ... 3000.0	s	10 = 1 s
111.12	DIO2 OFF delay	<i>Real</i>	0.0 ... 3000.0	s	10 = 1 s
111.38	Freq in 1 actual value	<i>Real</i>	0...16000	Hz	1 = 1 Hz
111.39	Freq in 1 scaled	<i>Real</i>	-32768.000 ... 32767.000	-	1000 = 1
111.42	Freq in 1 min	<i>Real</i>	0...16000	Hz	1 = 1 Hz
111.43	Freq in 1 max	<i>Real</i>	0...16000	Hz	1 = 1 Hz
111.44	Freq in 1 at scaled min	<i>Real</i>	-32768.000 ... 32767.000	-	1000 = 1
111.45	Freq in 1 at scaled max	<i>Real</i>	-32768.000 ... 32767.000	-	1000 = 1
111.81	DIO filter time	<i>Real</i>	0.3 ... 100.0	ms	10 = 1 ms

No.	Name	Type	Range	Unit	FbEq32
112 Standard AI					
112.01	AI tune	List	0...4	-	1 = 1
112.03	AI supervision function	List	0...2	-	1 = 1
112.04	AI supervision selection	PB	0000h...FFFFh	-	1 = 1
112.11	AI1 actual value	Real	-22.000 ... 22.000	mA or V	1000 = 1 unit
112.12	AI1 scaled value	Real	-32768.000 ... 32767.000	-	1000 = 1
112.15	AI1 unit selection	List	2...10	-	1 = 1
112.16	AI1 filter time	Real	0.000 ... 30.000	s	1000 = 1 s
112.17	AI1 min	Real	-22.000 ... 22.000	mA or V	1000 = 1 mA or V
112.18	AI1 max	Real	-22.000 ... 22.000	mA or V	1000 = 1 mA or V
112.19	AI1 scaled at AI1 min	Real	-32768.000 ... 32767.000	-	1000 = 1
112.20	AI1 scaled at AI1 max	Real	-32768.000 ... 32767.000	-	1000 = 1
112.21	AI2 actual value	Real	-22.000 ... 22.000	mA or V	1000 = 1 mA or V
112.22	AI2 scaled value	Real	-32768.000 ... 32767.000	-	1000 = 1
112.25	AI2 unit selection	List	2...10	-	1 = 1
112.26	AI2 filter time	Real	0.000 ... 30.000	s	1000 = 1 s
112.27	AI2 min	Real	-22.000 ... 22.000	mA or V	1000 = 1 mA or V
112.28	AI2 max	Real	-22.000 ... 22.000	mA or V	1000 = 1 mA or V
112.29	AI2 scaled at AI2 min	Real	-32768.000 ... 32767.000	-	1000 = 1
112.30	AI2 scaled at AI2 max	Real	-32768.000 ... 32767.000	-	1000 = 1
113 Standard AO					
113.11	AO1 actual value	Real	0.000 ... 22.000	mA	1000 = 1 mA
113.12	AO1 source	Analog src	-	-	1 = 1
113.16	AO1 filter time	Real	0.000 ... 30.000	s	1000 = 1 s
113.17	AO1 source min	Real	-32768.0 ... 32767.0	-	10 = 1
113.18	AO1 source max	Real	-32768.0 ... 32767.0	-	10 = 1
113.19	AO1 out at AO1 src min	Real	0.000 ... 22.000	mA	1000 = 1 mA
113.20	AO1 out at AO1 src max	Real	0.000 ... 22.000	mA	1000 = 1 mA
113.21	AO2 actual value	Real	0.000 ... 22.000	mA	1000 = 1 mA
113.22	AO2 source	Analog src	-	-	1 = 1
113.26	AO2 filter time	Real	0.000 ... 30.000	s	1000 = 1 s
113.27	AO2 source min	Real	-32768.0 ... 32767.0	-	10 = 1
113.28	AO2 source max	Real	-32768.0 ... 32767.0	-	10 = 1
113.29	AO2 out at AO2 src min	Real	0.000 ... 22.000	mA	1000 = 1 mA
113.30	AO2 out at AO2 src max	Real	0.000 ... 22.000	mA	1000 = 1 mA
113.91	AO1 data storage	Real	-327.68 ... 327.67	-	100 = 1
113.92	AO2 data storage	Real	-327.68 ... 327.67	-	100 = 1
114 Extension I/O module 1					
114.01	Module 1 type	List	0...4	-	1 = 1
114.02	Module 1 location	Real	1...254	-	1 = 1
114.03	Module 1 status	List	0...25	-	1 = 1
<i>Dix (114.01 Module 1 type = FDIO-01)</i>					
114.05	DI status	PB	00000000h...FFFFFFFFh	-	1 = 1
114.06	DI delayed status	PB	00000000h...FFFFFFFFh	-	1 = 1
114.08	DI filter time	Real	0.8 ... 100.0	ms	10 = 1 ms
114.12	DI1 ON delay	Real	0.00 ... 3000.00	s	100 = 1 s
114.13	DI1 OFF delay	Real	0.00 ... 3000.00	s	100 = 1 s
114.17	DI2 ON delay	Real	0.00 ... 3000.00	s	100 = 1 s

No.	Name	Type	Range	Unit	FbEq32
114.18	DI2 OFF delay	<i>Real</i>	0.00 ... 3000.00	s	100 = 1 s
114.22	DI3 ON delay	<i>Real</i>	0.00 ... 3000.00	s	100 = 1 s
114.23	DI3 OFF delay	<i>Real</i>	0.00 ... 3000.00	s	100 = 1 s
<i>Common parameters for DIOx (114.01 Module 1 type = FIO-01 or FIO-11)</i>					
114.05	DIO status	<i>PB</i>	00000000h...FFFFFFFFh	-	1 = 1
114.06	DIO delayed status	<i>PB</i>	00000000h...FFFFFFFFh	-	1 = 1
<i>DIO1/DIO2 (114.01 Module 1 type = FIO-01 or FIO-11)</i>					
114.08	DIO filter time	<i>Real</i>	0.8 ... 100.0	ms	10 = 1 ms
114.09	DIO1 configuration	<i>List</i>	0...1	-	1 = 1
114.11	DIO1 output source	<i>Binary src</i>	-	-	1 = 1
114.12	DIO1 ON delay	<i>Real</i>	0.0 ... 3000.0	s	10 = 1 s
114.13	DIO1 OFF delay	<i>Real</i>	0.0 ... 3000.0	s	10 = 1 s
114.14	DIO2 configuration	<i>List</i>	0...1	-	1 = 1
114.16	DIO2 output source	<i>Binary src</i>	-	-	1 = 1
114.17	DIO2 ON delay	<i>Real</i>	0.0 ... 3000.0	s	10 = 1 s
114.18	DIO2 OFF delay	<i>Real</i>	0.0 ... 3000.0	s	10 = 1 s
<i>DIO3/DIO4 (114.01 Module 1 type = FIO-01)</i>					
114.19	DIO3 configuration	<i>List</i>	0...1	-	1 = 1
114.21	DIO3 output source	<i>Binary src</i>	-	-	1 = 1
114.22	DIO3 ON delay	<i>Real</i>	0.0 ... 3000.0	s	10 = 1 s
114.23	DIO3 OFF delay	<i>Real</i>	0.0 ... 3000.0	s	10 = 1 s
114.24	DIO4 configuration	<i>List</i>	0...1	-	1 = 1
114.26	DIO4 output source	<i>Binary src</i>	-	-	1 = 1
114.27	DIO4 ON delay	<i>Real</i>	0.0 ... 3000.0	s	10 = 1 s
114.28	DIO4 OFF delay	<i>Real</i>	0.0 ... 3000.0	s	10 = 1 s
<i>RO1/RO2 (114.01 Module 1 type = FIO-01 or FDIO-01)</i>					
114.31	RO status	<i>PB</i>	0000h...FFFFh	-	1 = 1
114.34	RO1 source	<i>Binary src</i>	-	-	1 = 1
114.35	RO1 ON delay	<i>Real</i>	0.0 ... 3000.0	s	10 = 1 s
114.36	RO1 OFF delay	<i>Real</i>	0.0 ... 3000.0	s	10 = 1 s
114.37	RO2 source	<i>Binary src</i>	-	-	1 = 1
114.38	RO2 ON delay	<i>Real</i>	0.0 ... 3000.0	s	10 = 1 s
114.39	RO2 OFF delay	<i>Real</i>	0.0 ... 3000.0	s	10 = 1 s
<i>Common parameters for AIx (114.01 Module 1 type = FIO-11 or FAIO-01)</i>					
114.19	AI supervision function	<i>List</i>	0...2	-	1 = 1
114.20	AI supervision selection	<i>PB</i>	0000h...FFFFh	-	1 = 1
114.22	AI force sel	<i>PB</i>	00000000h...FFFFFFFFh	-	1 = 1
<i>AI1/AI2 (114.01 Module 1 type = FIO-11 or FAIO-01)</i>					
114.26	AI1 actual value	<i>Real</i>	-22.000 ... 22.000	mA or V	1000 = 1 unit
114.27	AI1 scaled value	<i>Real</i>	-32768.000 ... 32767.000	-	1000 = 1
114.28	AI1 force data	<i>Real</i>	-22.000 ... 22.000	mA or V	1000 = 1 unit
114.29	AI1 HW switch pos	<i>List</i>	-	-	1 = 1
114.30	AI1 unit selection	<i>List</i>	-	-	1 = 1
114.31	AI1 filter gain	<i>List</i>	0...7	-	1 = 1
114.32	AI1 filter time	<i>Real</i>	0.000 ... 30.000	s	1000 = 1 s
114.33	AI1 min	<i>Real</i>	-22.000 ... 22.000	mA or V	1000 = 1 mA or V
114.34	AI1 max	<i>Real</i>	-22.000 ... 22.000	mA or V	1000 = 1 mA or V
114.35	AI1 scaled at AI1 min	<i>Real</i>	-32768.000 ... 32767.000	-	1000 = 1
114.36	AI1 scaled at AI1 max	<i>Real</i>	-32768.000 ... 32767.000	-	1000 = 1

202 Additional parameter data

No.	Name	Type	Range	Unit	FbEq32
114.41	AI2 actual value	<i>Real</i>	-22.000 ... 22.000	mA or V	1000 = 1 unit
114.42	AI2 scaled value	<i>Real</i>	-32768.000 ... 32767.000	-	1000 = 1
114.43	AI2 force data	<i>Real</i>	-22.000 ... 22.000	mA or V	1000 = 1 unit
114.44	AI2 HW switch pos	<i>List</i>	-	-	1 = 1
114.45	AI2 unit selection	<i>List</i>	-	-	1 = 1
114.46	AI2 filter gain	<i>List</i>	0...7	-	1 = 1
114.47	AI2 filter time	<i>Real</i>	0.000 ... 30.000	s	1000 = 1 s
114.48	AI2 min	<i>Real</i>	-22.000 ... 22.000	mA or V	1000 = 1 mA or V
114.49	AI2 max	<i>Real</i>	-22.000 ... 22.000	mA or V	1000 = 1 mA or V
114.50	AI2 scaled at AI2 min	<i>Real</i>	-32768.000 ... 32767.000	-	1000 = 1
114.51	AI2 scaled at AI2 max	<i>Real</i>	-32768.000 ... 32767.000	-	1000 = 1
<i>AI3 (114.01 Module 1 type = FIO-11)</i>					
114.56	AI3 actual value	<i>Real</i>	-22.000 ... 22.000	mA or V	1000 = 1 unit
114.57	AI3 scaled value	<i>Real</i>	-32768.000 ... 32767.000	-	1000 = 1
114.58	AI3 force data	<i>Real</i>	-22.000 ... 22.000	mA or V	1000 = 1 unit
114.59	AI3 HW switch pos	<i>List</i>	-	-	1 = 1
114.60	AI3 unit selection	<i>List</i>	-	-	1 = 1
114.61	AI3 filter gain	<i>List</i>	0...7	-	1 = 1
114.62	AI3 filter time	<i>Real</i>	0.000 ... 30.000	s	1000 = 1 s
114.63	AI3 min	<i>Real</i>	-22.000 ... 22.000	mA or V	1000 = 1 mA or V
114.64	AI3 max	<i>Real</i>	-22.000 ... 22.000	mA or V	1000 = 1 mA or V
114.65	AI3 scaled at AI3 min	<i>Real</i>	-32768.000 ... 32767.000	-	1000 = 1
114.66	AI3 scaled at AI3 max	<i>Real</i>	-32768.000 ... 32767.000	-	1000 = 1
<i>Common parameters for AOx (114.01 Module 1 type = FIO-11 or FAIO-01)</i>					
114.71	AO force selection	<i>PB</i>	00000000h...FFFFFFFFh	-	1 = 1
<i>AO1 (114.01 Module 1 type = FIO-11 or FAIO-01)</i>					
114.76	AO1 actual value	<i>Real</i>	0.000 ... 22.000	mA	1000 = 1 mA
114.77	AO1 source	<i>Analog src</i>	-	-	1 = 1
114.78	AO1 force data	<i>Real</i>	0.000 ... 22.000	mA	1000 = 1 mA
114.79	AO1 filter time	<i>Real</i>	0.000 ... 30.000	s	1000 = 1 s
114.80	AO1 source min	<i>Real</i>	-32768.0 ... 32767.0	-	10 = 1
114.81	AO1 source max	<i>Real</i>	-32768.0 ... 32767.0	-	10 = 1
114.82	AO1 out at AO1 src min	<i>Real</i>	0.000 ... 22.000	mA	1000 = 1 mA
114.83	AO1 out at AO1 src max	<i>Real</i>	0.000 ... 22.000	mA	1000 = 1 mA
<i>AO2 (114.01 Module 1 type = FAIO-01)</i>					
114.86	AO2 actual value	<i>Real</i>	0.000 ... 22.000	mA	1000 = 1 mA
114.87	AO2 source	<i>Analog src</i>	-	-	1 = 1
114.88	AO2 force data	<i>Real</i>	0.000 ... 22.000	mA	1000 = 1 mA
114.89	AO2 filter time	<i>Real</i>	0.000 ... 30.000	s	1000 = 1 s
114.90	AO2 source min	<i>Real</i>	-32768.0 ... 32767.0	-	10 = 1
114.91	AO2 source max	<i>Real</i>	-32768.0 ... 32767.0	-	10 = 1
114.92	AO2 out at AO2 src min	<i>Real</i>	0.000 ... 22.000	mA	1000 = 1 mA
114.93	AO2 out at AO2 src max	<i>Real</i>	0.000 ... 22.000	mA	1000 = 1 mA
115 Extension I/O module 2					
115.01	Module 2 type	<i>List</i>	0...4	-	1 = 1
115.02	Module 2 location	<i>Real</i>	1...254	-	1 = 1
115.03	Module 2 status	<i>List</i>	0...24	-	1 = 1
<i>DIx (115.01 Module 2 type = FDIO-01)</i>					
115.05	DI status	<i>PB</i>	00000000h...FFFFFFFFh	-	1 = 1

No.	Name	Type	Range	Unit	FbEq32
115.06	DI delayed status	<i>PB</i>	00000000h...FFFFFFFFh	-	1 = 1
115.08	DI filter time	<i>Real</i>	0.8 ... 100.0	ms	10 = 1 ms
115.12	DI1 ON delay	<i>Real</i>	0.00 ... 3000.00	s	100 = 1 s
115.13	DI1 OFF delay	<i>Real</i>	0.00 ... 3000.00	s	100 = 1 s
115.17	DI2 ON delay	<i>Real</i>	0.00 ... 3000.00	s	100 = 1 s
115.18	DI2 OFF delay	<i>Real</i>	0.00 ... 3000.00	s	100 = 1 s
115.22	DI3 ON delay	<i>Real</i>	0.00 ... 3000.00	s	100 = 1 s
115.23	DI3 OFF delay	<i>Real</i>	0.00 ... 3000.00	s	100 = 1 s
<i>Common parameters for DIOx (115.01 Module 2 type = FIO-01 or FIO-11)</i>					
115.05	DIO status	<i>PB</i>	00000000h...FFFFFFFFh	-	1 = 1
115.06	DIO delayed status	<i>PB</i>	00000000h...FFFFFFFFh	-	1 = 1
<i>DIO1/DIO2 (115.01 Module 2 type = FIO-01 or FIO-11)</i>					
115.08	DIO filter time	<i>Real</i>	0.8 ... 100.0	ms	10 = 1 ms
115.09	DIO1 configuration	<i>List</i>	0...1	-	1 = 1
115.11	DIO1 output source	<i>Binary src</i>	-	-	1 = 1
115.12	DIO1 ON delay	<i>Real</i>	0.0 ... 3000.0	s	10 = 1 s
115.13	DIO1 OFF delay	<i>Real</i>	0.0 ... 3000.0	s	10 = 1 s
115.14	DIO2 configuration	<i>List</i>	0...1	-	1 = 1
115.16	DIO2 output source	<i>Binary src</i>	-	-	1 = 1
115.17	DIO2 ON delay	<i>Real</i>	0.0 ... 3000.0	s	10 = 1 s
115.18	DIO2 OFF delay	<i>Real</i>	0.0 ... 3000.0	s	10 = 1 s
<i>DIO3/DIO4 (115.01 Module 2 type = FIO-01)</i>					
115.19	DIO3 configuration	<i>List</i>	0...1	-	1 = 1
115.21	DIO3 output source	<i>Binary src</i>	-	-	1 = 1
115.22	DIO3 ON delay	<i>Real</i>	0.0 ... 3000.0	s	10 = 1 s
115.23	DIO3 OFF delay	<i>Real</i>	0.0 ... 3000.0	s	10 = 1 s
115.24	DIO4 configuration	<i>List</i>	0...1	-	1 = 1
115.26	DIO4 output source	<i>Binary src</i>	-	-	1 = 1
115.27	DIO4 ON delay	<i>Real</i>	0.0 ... 3000.0	s	10 = 1 s
115.28	DIO4 OFF delay	<i>Real</i>	0.0 ... 3000.0	s	10 = 1 s
<i>RO1/RO2 (115.01 Module 2 type = FIO-01 or FDIO-01)</i>					
115.31	RO status	<i>PB</i>	0000h...FFFFh	-	1 = 1
115.34	RO1 source	<i>Binary src</i>	-	-	1 = 1
115.35	RO1 ON delay	<i>Real</i>	0.0 ... 3000.0	s	10 = 1 s
115.36	RO1 OFF delay	<i>Real</i>	0.0 ... 3000.0	s	10 = 1 s
115.37	RO2 source	<i>Binary src</i>	-	-	1 = 1
115.38	RO2 ON delay	<i>Real</i>	0.0 ... 3000.0	s	10 = 1 s
115.39	RO2 OFF delay	<i>Real</i>	0.0 ... 3000.0	s	10 = 1 s
<i>Common parameters for AIx (115.01 Module 2 type = FIO-11 or FAIO-01)</i>					
115.19	AI supervision function	<i>List</i>	0...2	-	1 = 1
115.20	AI supervision selection	<i>PB</i>	0000h...FFFFh	-	1 = 1
115.22	AI force sel	<i>PB</i>	00000000h...FFFFFFFFh	-	1 = 1
<i>AI1/AI2 (115.01 Module 2 type = FIO-11 or FAIO-01)</i>					
115.26	AI1 actual value	<i>Real</i>	-22.000 ... 22.000	mA or V	1000 = 1 unit
115.27	AI1 scaled value	<i>Real</i>	-32768.000 ... 32767.000	-	1000 = 1
115.28	AI1 force data	<i>Real</i>	-22.000 ... 22.000	mA or V	1000 = 1 unit
115.29	AI1 HW switch pos	<i>List</i>	-	-	1 = 1
115.30	AI1 unit selection	<i>List</i>	-	-	1 = 1
115.31	AI1 filter gain	<i>List</i>	0...7	-	1 = 1

204 Additional parameter data

No.	Name	Type	Range	Unit	FbEq32
115.32	AI1 filter time	<i>Real</i>	0.000 ... 30.000	s	1000 = 1 s
115.33	AI1 min	<i>Real</i>	-22.000 ... 22.000	mA or V	1000 = 1 mA or V
115.34	AI1 max	<i>Real</i>	-22.000 ... 22.000	mA or V	1000 = 1 mA or V
115.35	AI1 scaled at AI1 min	<i>Real</i>	-32768.000 ... 32767.000	-	1000 = 1
115.36	AI1 scaled at AI1 max	<i>Real</i>	-32768.000 ... 32767.000	-	1000 = 1
115.41	AI2 actual value	<i>Real</i>	-22.000 ... 22.000	mA or V	1000 = 1 unit
115.42	AI2 scaled value	<i>Real</i>	-32768.000 ... 32767.000	-	1000 = 1
115.43	AI2 force data	<i>Real</i>	-22.000 ... 22.000	mA or V	1000 = 1 unit
115.44	AI2 HW switch pos	<i>List</i>	-	-	1 = 1
115.45	AI2 unit selection	<i>List</i>	-	-	1 = 1
115.46	AI2 filter gain	<i>List</i>	0...7	-	1 = 1
115.47	AI2 filter time	<i>Real</i>	0.000 ... 30.000	s	1000 = 1 s
115.48	AI2 min	<i>Real</i>	-22.000 ... 22.000	mA or V	1000 = 1 mA or V
115.49	AI2 max	<i>Real</i>	-22.000 ... 22.000	mA or V	1000 = 1 mA or V
115.50	AI2 scaled at AI2 min	<i>Real</i>	-32768.000 ... 32767.000	-	1000 = 1
115.51	AI2 scaled at AI2 max	<i>Real</i>	-32768.000 ... 32767.000	-	1000 = 1
<i>AI3 (115.01 Module 2 type = FIO-11)</i>					
115.56	AI3 actual value	<i>Real</i>	-22.000 ... 22.000	mA or V	1000 = 1 unit
115.57	AI3 scaled value	<i>Real</i>	-32768.000 ... 32767.000	-	1000 = 1
115.58	AI3 force data	<i>Real</i>	-22.000 ... 22.000	mA or V	1000 = 1 unit
115.59	AI3 HW switch pos	<i>List</i>	-	-	1 = 1
115.60	AI3 unit selection	<i>List</i>	-	-	1 = 1
115.61	AI3 filter gain	<i>List</i>	0...7	-	1 = 1
115.62	AI3 filter time	<i>Real</i>	0.000 ... 30.000	s	1000 = 1 s
115.63	AI3 min	<i>Real</i>	-22.000 ... 22.000	mA or V	1000 = 1 mA or V
115.64	AI3 max	<i>Real</i>	-22.000 ... 22.000	mA or V	1000 = 1 mA or V
115.65	AI3 scaled at AI3 min	<i>Real</i>	-32768.000 ... 32767.000	-	1000 = 1
115.66	AI3 scaled at AI3 max	<i>Real</i>	-32768.000 ... 32767.000	-	1000 = 1
<i>Common parameters for AOx (115.01 Module 2 type = FIO-11 or FAIO-01)</i>					
115.71	AO force selection	<i>PB</i>	00000000h...FFFFFFFh	-	1 = 1
<i>AO1 (115.01 Module 2 type = FIO-11 or FAIO-01)</i>					
115.76	AO1 actual value	<i>Real</i>	0.000 ... 22.000	mA	1000 = 1 mA
115.77	AO1 source	<i>Analog src</i>	-	-	1 = 1
115.78	AO1 force data	<i>Real</i>	0.000 ... 22.000	mA	1000 = 1 mA
115.79	AO1 filter time	<i>Real</i>	0.000 ... 30.000	s	1000 = 1 s
115.80	AO1 source min	<i>Real</i>	-32768.0 ... 32767.0	-	10 = 1
115.81	AO1 source max	<i>Real</i>	-32768.0 ... 32767.0	-	10 = 1
115.82	AO1 out at AO1 src min	<i>Real</i>	0.000 ... 22.000	mA	1000 = 1 mA
115.83	AO1 out at AO1 src max	<i>Real</i>	0.000 ... 22.000	mA	1000 = 1 mA
<i>AO2 (115.01 Module 2 type = FAIO-01)</i>					
115.86	AO2 actual value	<i>Real</i>	0.000 ... 22.000	mA	1000 = 1 mA
115.87	AO2 source	<i>Analog src</i>	-	-	1 = 1
115.88	AO2 force data	<i>Real</i>	0.000 ... 22.000	mA	1000 = 1 mA
115.89	AO2 filter time	<i>Real</i>	0.000 ... 30.000	s	1000 = 1 s
115.90	AO2 source min	<i>Real</i>	-32768.0 ... 32767.0	-	10 = 1
115.91	AO2 source max	<i>Real</i>	-32768.0 ... 32767.0	-	10 = 1
115.92	AO2 out at AO2 src min	<i>Real</i>	0.000 ... 22.000	mA	1000 = 1 mA
115.93	AO2 out at AO2 src max	<i>Real</i>	0.000 ... 22.000	mA	1000 = 1 mA

No.	Name	Type	Range	Unit	FbEq32
116 Extension I/O module 3					
116.01	Module 3 type	List	0...4	-	1 = 1
116.02	Module 3 location	Real	1...254	-	1 = 1
116.03	Module 3 status	List	0...24	-	1 = 1
<i>Dlx (116.01 Module 3 type = FDIO-01)</i>					
116.05	DI status	PB	00000000h...FFFFFFFh	-	1 = 1
116.06	DI delayed status	PB	00000000h...FFFFFFFh	-	1 = 1
116.08	DI filter time	Real	0.8 ... 100.0	ms	10 = 1 ms
116.12	DI1 ON delay	Real	0.00 ... 3000.00	s	100 = 1 s
116.13	DI1 OFF delay	Real	0.00 ... 3000.00	s	100 = 1 s
116.17	DI2 ON delay	Real	0.00 ... 3000.00	s	100 = 1 s
116.18	DI2 OFF delay	Real	0.00 ... 3000.00	s	100 = 1 s
116.22	DI3 ON delay	Real	0.00 ... 3000.00	s	100 = 1 s
116.23	DI3 OFF delay	Real	0.00 ... 3000.00	s	100 = 1 s
<i>Common parameters for DIOx (116.01 Module 3 type = FIO-01 or FIO-11)</i>					
116.05	DIO status	PB	00000000h...FFFFFFFh	-	1 = 1
116.06	DIO delayed status	PB	00000000h...FFFFFFFh	-	1 = 1
<i>DIO1/DIO2 (116.01 Module 3 type = FIO-01 or FIO-11)</i>					
116.08	DIO filter time	Real	0.8 ... 100.0	ms	10 = 1 ms
116.09	DIO1 configuration	List	0...1	-	1 = 1
116.11	DIO1 output source	Binary src	-	-	1 = 1
116.12	DIO1 ON delay	Real	0.0 ... 3000.0	s	10 = 1 s
116.13	DIO1 OFF delay	Real	0.0 ... 3000.0	s	10 = 1 s
116.14	DIO2 configuration	List	0...1	-	1 = 1
116.16	DIO2 output source	Binary src	-	-	1 = 1
116.17	DIO2 ON delay	Real	0.0 ... 3000.0	s	10 = 1 s
116.18	DIO2 OFF delay	Real	0.0 ... 3000.0	s	10 = 1 s
<i>DIO3/DIO4 (116.01 Module 3 type = FIO-01)</i>					
116.19	DIO3 configuration	List	0...1	-	1 = 1
116.21	DIO3 output source	Binary src	-	-	1 = 1
116.22	DIO3 ON delay	Real	0.0 ... 3000.0	s	10 = 1 s
116.23	DIO3 OFF delay	Real	0.0 ... 3000.0	s	10 = 1 s
116.24	DIO4 configuration	List	0...1	-	1 = 1
116.26	DIO4 output source	Binary src	-	-	1 = 1
116.27	DIO4 ON delay	Real	0.0 ... 3000.0	s	10 = 1 s
116.28	DIO4 OFF delay	Real	0.0 ... 3000.0	s	10 = 1 s
<i>RO1/RO2 (116.01 Module 3 type = FIO-01 or FDIO-01)</i>					
116.31	RO status	PB	0000h...FFFFh	-	1 = 1
116.34	RO1 source	Binary src	-	-	1 = 1
116.35	RO1 ON delay	Real	0.0 ... 3000.0	s	10 = 1 s
116.36	RO1 OFF delay	Real	0.0 ... 3000.0	s	10 = 1 s
116.37	RO2 source	Binary src	-	-	1 = 1
116.38	RO2 ON delay	Real	0.0 ... 3000.0	s	10 = 1 s
116.39	RO2 OFF delay	Real	0.0 ... 3000.0	s	10 = 1 s
<i>Common parameters for AIx (116.01 Module 3 type = FIO-11 or FAIO-01)</i>					
116.19	AI supervision function	List	0...2	-	1 = 1
116.20	AI supervision selection	PB	0000h...FFFFh	-	1 = 1
116.22	AI force sel	PB	00000000h...FFFFFFFh	-	1 = 1

No.	Name	Type	Range	Unit	FbEq32
<i>AI1/AI2 (116.01 Module 3 type = FIO-11 or FAIO-01)</i>					
116.26	AI1 actual value	<i>Real</i>	-22.000 ... 22.000	mA or V	1000 = 1 unit
116.27	AI1 scaled value	<i>Real</i>	-32768.000 ... 32767.000	-	1000 = 1
116.28	AI1 force data	<i>Real</i>	-22.000 ... 22.000	mA or V	1000 = 1 unit
116.29	AI1 HW switch pos	<i>List</i>	-	-	1 = 1
116.30	AI1 unit selection	<i>List</i>	-	-	1 = 1
116.31	AI1 filter gain	<i>List</i>	0...7	-	1 = 1
116.32	AI1 filter time	<i>Real</i>	0.000 ... 30.000	s	1000 = 1 s
116.33	AI1 min	<i>Real</i>	-22.000 ... 22.000	mA or V	1000 = 1 mA or V
116.34	AI1 max	<i>Real</i>	-22.000 ... 22.000	mA or V	1000 = 1 mA or V
116.35	AI1 scaled at AI1 min	<i>Real</i>	-32768.000 ... 32767.000	-	1000 = 1
116.36	AI1 scaled at AI1 max	<i>Real</i>	-32768.000 ... 32767.000	-	1000 = 1
116.41	AI2 actual value	<i>Real</i>	-22.000 ... 22.000	mA or V	1000 = 1 unit
116.42	AI2 scaled value	<i>Real</i>	-32768.000 ... 32767.000	-	1000 = 1
116.43	AI2 force data	<i>Real</i>	-22.000 ... 22.000	mA or V	1000 = 1 unit
116.44	AI2 HW switch pos	<i>List</i>	-	-	1 = 1
116.45	AI2 unit selection	<i>List</i>	-	-	1 = 1
116.46	AI2 filter gain	<i>List</i>	0...7	-	1 = 1
116.47	AI2 filter time	<i>Real</i>	0.000 ... 30.000	s	1000 = 1 s
116.48	AI2 min	<i>Real</i>	-22.000 ... 22.000	mA or V	1000 = 1 mA or V
116.49	AI2 max	<i>Real</i>	-22.000 ... 22.000	mA or V	1000 = 1 mA or V
116.50	AI2 scaled at AI2 min	<i>Real</i>	-32768.000 ... 32767.000	-	1000 = 1
116.51	AI2 scaled at AI2 max	<i>Real</i>	-32768.000 ... 32767.000	-	1000 = 1
<i>AI3 (116.01 Module 3 type = FIO-11)</i>					
116.56	AI3 actual value	<i>Real</i>	-22.000 ... 22.000	mA or V	1000 = 1 unit
116.57	AI3 scaled value	<i>Real</i>	-32768.000 ... 32767.000	-	1000 = 1
116.58	AI3 force data	<i>Real</i>	-22.000 ... 22.000	mA or V	1000 = 1 unit
116.59	AI3 HW switch pos	<i>List</i>	-	-	1 = 1
116.60	AI3 unit selection	<i>List</i>	-	-	1 = 1
116.61	AI3 filter gain	<i>List</i>	0...7	-	1 = 1
116.62	AI3 filter time	<i>Real</i>	0.000 ... 30.000	s	1000 = 1 s
116.63	AI3 min	<i>Real</i>	-22.000 ... 22.000	mA or V	1000 = 1 mA or V
116.64	AI3 max	<i>Real</i>	-22.000 ... 22.000	mA or V	1000 = 1 mA or V
116.65	AI3 scaled at AI3 min	<i>Real</i>	-32768.000 ... 32767.000	-	1000 = 1
116.66	AI3 scaled at AI3 max	<i>Real</i>	-32768.000 ... 32767.000	-	1000 = 1
<i>Common parameters for AOx (116.01 Module 3 type = FIO-11 or FAIO-01)</i>					
116.71	AO force selection	<i>PB</i>	00000000h...FFFFFFFFh	-	1 = 1
<i>AO1 (116.01 Module 3 type = FIO-11 or FAIO-01)</i>					
116.76	AO1 actual value	<i>Real</i>	0.000 ... 22.000	mA	1000 = 1 mA
116.77	AO1 source	<i>Analog src</i>	-	-	1 = 1
116.78	AO1 force data	<i>Real</i>	0.000 ... 22.000	mA	1000 = 1 mA
116.79	AO1 filter time	<i>Real</i>	0.000 ... 30.000	s	1000 = 1 s
116.80	AO1 source min	<i>Real</i>	-32768.0 ... 32767.0	-	10 = 1
116.81	AO1 source max	<i>Real</i>	-32768.0 ... 32767.0	-	10 = 1
116.82	AO1 out at AO1 src min	<i>Real</i>	0.000 ... 22.000	mA	1000 = 1 mA
116.83	AO1 out at AO1 src max	<i>Real</i>	0.000 ... 22.000	mA	1000 = 1 mA
<i>AO2 (116.01 Module 3 type = FAIO-01)</i>					
116.86	AO2 actual value	<i>Real</i>	0.000 ... 22.000	mA	1000 = 1 mA
116.87	AO2 source	<i>Analog src</i>	-	-	1 = 1

No.	Name	Type	Range	Unit	FbEq32
116.88	AO2 force data	<i>Real</i>	0.000 ... 22.000	mA	1000 = 1 mA
116.89	AO2 filter time	<i>Real</i>	0.000 ... 30.000	s	1000 = 1 s
116.90	AO2 source min	<i>Real</i>	-32768.0 ... 32767.0	-	10 = 1
116.91	AO2 source max	<i>Real</i>	-32768.0 ... 32767.0	-	10 = 1
116.92	AO2 out at AO2 src min	<i>Real</i>	0.000 ... 22.000	mA	1000 = 1 mA
116.93	AO2 out at AO2 src max	<i>Real</i>	0.000 ... 22.000	mA	1000 = 1 mA
119 Operation mode					
119.01	Actual operation mode	<i>List</i>	1...3	-	1 = 1
119.11	Ext1/Ext2 selection	<i>Binary src</i>	-	-	1 = 1
119.12	Ext1 ctrl mode1	<i>List</i>	1...3	-	1 = 1
119.14	Ext2 ctrl mode1	<i>List</i>	1...3	-	1 = 1
119.16	Local ctrl mode	<i>List</i>	1...3	-	1 = 1
119.17	Local control disable	<i>List</i>	0...1	-	1 = 1
120 Start/stop					
120.01	Ext1 commands	<i>List</i>	0...22	-	1 = 1
120.02	Ext1 start trigger type	<i>List</i>	0...1	-	1 = 1
120.03	Ext1 in1 source	<i>Binary src</i>	-	-	1 = 1
120.04	Ext1 in2 source	<i>Binary src</i>	-	-	1 = 1
120.06	Ext2 commands	<i>List</i>	-	-	1 = 1
120.07	Ext2 start trigger type	<i>List</i>	0...1	-	1 = 1
120.08	Ext2 in1 source	<i>Binary src</i>	-	-	1 = 1
120.09	Ext2 in2 source	<i>Binary src</i>	-	-	1 = 1
120.12	Run enable 1 source	<i>Binary src</i>	-	-	1 = 1
120.19	Enable start command	<i>Binary src</i>	-	-	1 = 1
120.21	Delay for MCB DI3 supervision	<i>Real</i>	0.00...8.00	s	100 = 1 s
120.22	Max current for MCB closing	<i>Real</i>	0...10	%	1 = 1%
120.23	Max DC charging time	<i>Real</i>	0.00...10.00	s	100 = 1 s
120.25	MCB closing level	<i>Real</i>	20...100	%	1 = 1%
120.26	Maximum dU/dt	<i>Real</i>	0.0...200.0	V/s	1 = 1 V/s
120.27	Start delay	<i>Real</i>	0.00...10.00	s	100 = 1 s
120.28	MCB relay timing	<i>Real</i>	-6.00...6.00	s	100 = 1 s
120.29	Diode mode	<i>Binary src</i>	-	-	1 = 1
120.30	External charge enable	<i>List</i>	0...1	-	1 = 1
120.50	Charging overload event sel	<i>List</i>	0...2	-	1 = 1
121 Start/stop mode					
121.04	Emergency stop mode	<i>List</i>	0...2	-	1 = 1
121.05	Emergency stop source	<i>Binary src</i>	-	-	1 = 1
122 Power reference					
122.01	User Power ref	<i>Real</i>	-	-	100 = 1
122.02	Power ref sel	<i>List</i>	-	-	1 = 1
122.03	Power ref 1	<i>Real</i>	-	-	1 = 1
122.04	Power ref scale	<i>Real</i>	-1000.00 ... 1000.00	-	100 = 1
122.05	Power ref 2	<i>Real</i>	-	-	100 = 1
122.06	Power ref type	<i>List</i>	0...3	-	1 = 1
122.07	Ipower ref %	<i>Real</i>	-1000.0 ... 1000.0	%	10 = 1%
122.08	Ipower ref	<i>Real</i>	-	A	100 = 1 A

No.	Name	Type	Range	Unit	FbEq32
122.09	Power ref %	<i>Real</i>	-1000.0 ... 1000.0	%	10 = 1%
122.10	Power ref	<i>Real</i>	-	kW	100 = 1 kW
122.11	lpower ref max %	<i>Real</i>	0.0 ... 200.0	%	10 = 1%
122.12	lpower ref min %	<i>Real</i>	-200.0 ... 0.0	%	10 = 1%
122.13	lpower ref lim %	<i>Real</i>	-200.0 ... 200.0	%	10 = 1%
122.14	lpower ref ramp up	<i>Real</i>	0 ... 30000	ms	1 = 1 ms
122.15	lpower ref ramp down	<i>Real</i>	0 ... 30000	ms	1 = 1 ms
122.16	lpower ref out %	<i>Real</i>	-200.0 ... 200.0	%	10 = 1%
122.17	lpower ref out	<i>Real</i>	-	A	100 = 1 A
122.18	Power ref out %	<i>Real</i>	-200.0 ... 200.0	%	10 = 1%
122.19	Power ref out	<i>Real</i>	-	kW	100 = 1 kW
123 DC voltage reference					
123.01	User DC voltage ref	<i>Real</i>	0.00 ... 2000.00	V	100 = 1 V
123.02	DC voltage ref selection	<i>List</i>	-	-	1 = 1
123.03	DC voltage ref 1	<i>Real</i>	0.00 ... 2000.00	V	100 = 1 V
123.05	DC voltage ref 2	<i>Real</i>	0.00 ... 2000.00	V	100 = 1 V
123.06	DC voltage ref max	<i>Real</i>	0 ... 2000	V	1 = 1 V
123.07	DC voltage ref min	<i>Real</i>	0 ... 1100	V	1 = 1 V
123.08	DC voltage ref lim	<i>Real</i>	0.00 ... 2000.00	V	100 = 1 V
123.09	DC voltage ref ramp up	<i>Real</i>	0 ... 10000	ms	1 = 1 ms
123.10	DC voltage ref ramp down	<i>Real</i>	0 ... 10000	ms	1 = 1 ms
123.11	DC voltage ref out	<i>Real</i>	0.00 ... 2000.00	V	100 = 1 V
123.12	DC voltage ref scale	<i>Real</i>	-100.00 ... 100.00	-	100
123.13	DC voltage ref add	<i>Real</i>	-30.000 ... 30.000	V	1000 = 1 V
123.30	Udc-ctrl droop	<i>List</i>	0 ... 1	-	1 = 1
123.31	Udc-ctrl drooping rate	<i>Real</i>	0.0 ... 100.0	%	10 = 1%
123.32	Master power	<i>Real</i>	-2000.00 ... 2000.00	-	100 = 1
124 Reactive power reference					
124.01	User Qref	<i>Real</i>	-	p.u.	100 = 1 p.u.
124.02	Q power ref selection	<i>List</i>	-	-	1 = 1
124.03	Qref 1	<i>Real</i>	-	-	100 = 1
124.04	Q ref scale	<i>Real</i>	-1000.00 ... 1000.00	-	100 = 1
124.05	Qref 2	<i>Real</i>	-	-	100 = 1
124.06	Q power ref type	<i>List</i>	0 ... 8	-	1 = 1
124.07	lreact ref %	<i>Real</i>	-1000.0 ... 1000.0	%	10 = 1%
124.08	lreact ref	<i>Real</i>	-	A	100 = 1 A
124.09	Q power ref %	<i>Real</i>	-1000.0 ... 1000.0	%	10 = 1%
124.10	Q power ref	<i>Real</i>	-	kVAr	100 = 1 kVAr
124.11	lreact ref max %	<i>Real</i>	0.0 ... 200.0	%	10 = 1%
124.12	lreact ref min %	<i>Real</i>	-200.0 ... 0.0	%	10 = 1%
124.13	lreact ref lim %	<i>Real</i>	-200.0 ... 200.0	%	10 = 1%
124.14	lreact ref ramp up	<i>Real</i>	0 ... 30000	ms	1 = 1 ms
124.15	lreact ref ramp down	<i>Real</i>	0 ... 30000	ms	1 = 1 ms
124.16	lreact ref out %	<i>Real</i>	-200.0 ... 200.0	%	10 = 1%
124.17	lreact ref out	<i>Real</i>	-	A	100 = 1 A
124.18	Q power ref out %	<i>Real</i>	-200.0 ... 200.0	%	10 = 1%
124.19	Q power ref out	<i>Real</i>	-	kVAr	100 = 1 kVAr
124.20	AC control gain	<i>Real</i>	0.0 ... 100.0	-	10 = 1
124.21	AC control integ time	<i>Real</i>	0 ... 30000	ms	1 = 1 ms

No.	Name	Type	Range	Unit	FbEq32
124.22	AC diff max %	<i>Real</i>	0.0...30.0	%	10 = 1%
124.23	AC diff min %	<i>Real</i>	-30.0...0.0	%	10 = 1%
124.27	AC control base grid voltage	<i>Real</i>	100...1000	V	1 = 1 V
124.30	Q(x) input signal	<i>List</i>	0...2	-	1 = 1
124.31	Lock-in level	<i>Real</i>	0.0...200.0	%	10 = 1%
124.32	Lock-out level	<i>Real</i>	0.0...200.0	%	10 = 1%
124.33	Q(x) input level 1	<i>Real</i>	-	%	10 = 1%
124.34	Q(x) input level 2	<i>Real</i>	-	%	10 = 1%
124.35	Q(x) input level 3	<i>Real</i>	-	%	10 = 1%
124.36	Q(x) input level 4	<i>Real</i>	-	%	10 = 1%
124.37	Q(x) input level 5	<i>Real</i>	-	%	10 = 1%
124.38	Q(x) input level 6	<i>Real</i>	-	%	10 = 1%
124.39	Q(x) output level 1	<i>Real</i>	-	-	100 = 1
124.40	Q(x) output level 2	<i>Real</i>	-	-	100 = 1
124.41	Q(x) output level 3	<i>Real</i>	-	-	100 = 1
124.42	Q(x) output level 4	<i>Real</i>	-	-	100 = 1
124.43	Q(x) output level 5	<i>Real</i>	-	-	100 = 1
124.44	Q(x) output level 6	<i>Real</i>	-	-	100 = 1
130 Limits					
130.01	Limit word 1	<i>PB</i>	0000h...FFFFh	-	1 = 1
130.02	Limit word 2	<i>PB</i>	0000h...FFFFh	-	1 = 1
130.03	Limit word 3	<i>PB</i>	0000h...FFFFh	-	1 = 1
130.04	Limit word 4	<i>PB</i>	0000h...FFFFh	-	1 = 1
130.16	Q cooling overtemp limit	<i>List</i>	0...1	-	1 = 1
130.17	Q cooling temp 1	<i>Real</i>	0.00 ... 200.00	°C	100 = 1 °C
130.18	Q cooling temp 2	<i>Real</i>	0.00 ... 200.00	°C	100 = 1 °C
130.19	Q cooling temp 3	<i>Real</i>	0.00 ... 200.00	°C	100 = 1 °C
130.20	Q cooling limit level 2	<i>Real</i>	0 ... 100	%	1 = 1%
130.21	Q cooling limit level 3	<i>Real</i>	0 ... 100	%	1 = 1%
130.22	Q power unit overtemp limit	<i>List</i>	0...1	-	1 = 1
130.23	Q power unit temp 1	<i>Real</i>	0.0 ... 100.0	%	10 = 1%
130.24	Q power unit temp 2	<i>Real</i>	0.0 ... 100.0	%	10 = 1%
130.25	Q power unit limit level	<i>Real</i>	0 ... 100	%	1 = 1%
130.30	Ireact limit %	<i>Real</i>	-200.0 ... 200.0	%	10 = 1%
130.31	Ireact limit	<i>Real</i>	-	A	100 = 1 A
130.32	Q power limit %	<i>Real</i>	-200.0 ... 200.0	%	10 = 1%
130.33	Q power limit	<i>Real</i>	-	kVAr	100 = 1 kVAr
130.46	Current limit %	<i>Real</i>	0...200	%	1 = 1%
130.47	Power sign change	<i>List</i>	0...1	-	1 = 1
130.48	User power limit max %	<i>Real</i>	0.0...200.0	%	10 = 1%
130.49	User power limit min %	<i>Real</i>	-200.0...0.0	%	10 = 1%
130.50	Ext Tmp1 input selection	<i>List</i>	-	-	1 = 1
130.51	Ext Tmp2 input selection	<i>List</i>	-	-	1 = 1
130.52	Ext Tmp1	<i>Real</i>	-	°C	100 = 1 °C
130.53	Ext Tmp2	<i>Real</i>	-	°C	100 = 1 °C
130.54	Pt current	<i>Real</i>	0.0...10.0	mA	10 = 1 mA
130.55	Cyclic Pt current	<i>Real</i>	-	mA	10 = 1 mA

No.	Name	Type	Range	Unit	FbEq32
130.58	Cooling temp source	<i>List</i>	0...2	-	1 = 1
130.83	User DC voltage min limit	<i>Real</i>	0...2500	V	1 = 1 V
130.84	User DC voltage max limit	<i>Real</i>	0...2500	V	1 = 1 V
131 Fault functions					
131.01	External event 1 source	<i>Binary src</i>	-	-	1 = 1
131.02	External event 1 type	<i>List</i>	0...3	-	1 = 1
131.03	External event 2 source	<i>Binary src</i>	-	-	1 = 1
131.04	External event 2 type	<i>List</i>	0...1	-	1 = 1
131.05	External event 3 source	<i>Binary src</i>	-	-	1 = 1
131.06	External event 3 type	<i>List</i>	0...1	-	1 = 1
131.07	External event 4 source	<i>Binary src</i>	-	-	1 = 1
131.08	External event 4 type	<i>List</i>	0...1	-	1 = 1
131.09	External event 5 source	<i>Binary src</i>	-	-	1 = 1
131.10	External event 5 type	<i>List</i>	0...1	-	1 = 1
131.11	Fault reset selection	<i>Binary src</i>	-	-	1 = 1
131.12	Autoreset selection	<i>PB</i>	0000h...FFFFh	-	1 = 1
131.13	User selectable fault	<i>Real</i>	0...65535	-	1 = 1
131.14	Number of trials	<i>Real</i>	0...5	-	1 = 1
131.15	Total trials time	<i>Real</i>	1.0 ... 600.0	s	10 = 1 s
131.16	Delay time	<i>Real</i>	0.0 ... 120.0	s	10 = 1 s
131.20	Earth fault	<i>List</i>	0...2	-	1 = 1
131.28	Ext earth leakage signal source	<i>Binary src</i>	-	-	1 = 1
131.29	Ext earth leakage action	<i>List</i>	0...1	-	1 = 1
131.32	Aux circuit breaker fault source	<i>Binary src</i>	-	-	1 = 1
131.33	Cabinet temperature fault source	<i>Binary src</i>	-	-	1 = 1
131.34	Cabinet temperature supervision	<i>List</i>	0...1	-	1 = 1
131.35	Main fan fault function	<i>List</i>	0...2	-	1 = 1
131.38	Fuse trip fault source	<i>Binary src</i>	-	-	1 = 1
131.39	Brake chopper fault source	<i>Binary src</i>	-	-	1 = 1
131.40	Disable warning messages	<i>PB</i>	0000h...FFFFh	-	1 = 1
131.55	Ext I/O comm loss event	<i>List</i>	0...2	-	1 = 1
133 Generic timer & counter					
133.01	Counter status	<i>PB</i>	000000b...111111b	-	1 = 1
133.10	On-time 1 actual	<i>Real</i>	0...4294967295	s	1 = 1 s
133.11	On-time 1 limit	<i>Real</i>	0...4294967295	s	1 = 1 s
133.12	On-time 1 function	<i>PB</i>	00b...11b	-	1 = 1
133.13	On-time 1 source	<i>Binary src</i>	-	-	1 = 1
133.14	On-time 1 warning select	<i>List</i>	-	-	1 = 1
133.20	On-time 2 actual	<i>Real</i>	0...4294967295	s	1 = 1 s
133.21	On-time 2 limit	<i>Real</i>	0...4294967295	s	1 = 1 s
133.22	On-time 2 function	<i>PB</i>	00b...11b	-	1 = 1
133.23	On-time 2 source	<i>Binary src</i>	-	-	1 = 1
133.24	On-time 2 warning select	<i>List</i>	-	-	1 = 1
133.30	Edge counter 1 actual	<i>Real</i>	0...4294967295	-	1 = 1

No.	Name	Type	Range	Unit	FbEq32
133.31	Edge counter 1 limit	<i>Real</i>	0...4294967295	-	1 = 1
133.32	Edge counter 1 func	<i>PB</i>	0000b...1111b	-	1 = 1
133.33	Edge counter 1 source	<i>Binary src</i>	-	-	1 = 1
133.34	Edge counter 1 divider	<i>Real</i>	1...4294967295	-	1 = 1
133.35	Edge counter 1 warning selection	<i>List</i>	-	-	1 = 1
133.40	Edge counter 2 actual	<i>Real</i>	0...4294967295	-	1 = 1
133.41	Edge counter 2 limit	<i>Real</i>	0...4294967295	-	1 = 1
133.42	Edge counter 2 function	<i>PB</i>	0000b...1111b	-	1 = 1
133.43	Edge counter 2 source	<i>Binary src</i>	-	-	1 = 1
133.44	Edge counter 2 divider	<i>Real</i>	1...4294967295	-	1 = 1
133.45	Edge counter 2 warning selection	<i>List</i>	-	-	1 = 1
133.50	Value counter 1 actual	<i>Real</i>	-2147483008 ... 2147483008	-	1 = 1
133.51	Value counter 1 limit	<i>Real</i>	-2147483008 ... 2147483008	-	1 = 1
133.52	Value counter 1 function	<i>PB</i>	00b...11b	-	1 = 1
133.53	Value counter 1 source	<i>Analog src</i>	-	-	1 = 1
133.54	Value counter 1 divider	<i>Real</i>	0.001 ... 2147483.647	-	1000 = 1
133.55	Value counter 1 warning select	<i>List</i>	-	-	1 = 1
133.60	Value counter 2 actual	<i>Real</i>	-2147483008 ... 2147483008	-	1 = 1
133.61	Value counter 2 limit	<i>Real</i>	-2147483008 ... 2147483008	-	1 = 1
133.62	Value counter 2 function	<i>PB</i>	00b...11b	-	1 = 1
133.63	Value counter 2 source	<i>Analog src</i>	-	-	1 = 1
133.64	Value counter 2 divider	<i>Real</i>	0.001 ... 2147483.647	-	1000 = 1
133.65	Value counter 2 warning selection	<i>List</i>	-	-	1 = 1
136 Load analyzer					
136.01	PVL signal source	<i>Analog src</i>	-	-	1 = 1
136.02	PVL filter time	<i>Real</i>	0.00 ... 120.00	s	100 = 1 s
136.06	AL2 signal source	<i>Analog src</i>	-	-	1 = 1
136.07	AL2 signal scaling	<i>Real</i>	0.00 ... 32767.00	-	100 = 1
136.09	Reset loggers	<i>List</i>	0...3	-	1 = 1
136.10	PVL peak value	<i>Real</i>	-32768.00 ... 32767.00	-	100 = 1
136.11	PVL peak date	<i>Data</i>	-	-	1 = 1
136.12	PVL peak time	<i>Data</i>	-	-	1 = 1
136.13	PVL current at peak	<i>Real</i>	-32768.00 ... 32767.00	A	100 = 1 A
136.14	PVL DC voltage at peak	<i>Real</i>	0.00 ... 2000.00	V	100 = 1 V
136.15	PVL power at peak	<i>Real</i>	-32768.00 ... 32767.00	kW	100 = 1 kW
136.16	PVL reset date	<i>Data</i>	-	-	1 = 1
136.17	PVL reset time	<i>Data</i>	-	-	1 = 1
136.20	AL1 below 10%	<i>Real</i>	0.00 ... 100.00	%	100 = 1%
136.21	AL1 10 to 20%	<i>Real</i>	0.00 ... 100.00	%	100 = 1%
136.22	AL1 20 to 30%	<i>Real</i>	0.00 ... 100.00	%	100 = 1%
136.23	AL1 30 to 40%	<i>Real</i>	0.00 ... 100.00	%	100 = 1%
136.24	AL1 40 to 50%	<i>Real</i>	0.00 ... 100.00	%	100 = 1%
136.25	AL1 50 to 60%	<i>Real</i>	0.00 ... 100.00	%	100 = 1%
136.26	AL1 60 to 70%	<i>Real</i>	0.00 ... 100.00	%	100 = 1%
136.27	AL1 70 to 80%	<i>Real</i>	0.00 ... 100.00	%	100 = 1%

212 Additional parameter data

No.	Name	Type	Range	Unit	FbEq32
136.28	AL1 80 to 90%	<i>Real</i>	0.00 ... 100.00	%	100 = 1%
136.29	AL1 over 90%	<i>Real</i>	0.00 ... 100.00	%	100 = 1%
136.40	AL2 below 10%	<i>Real</i>	0.00 ... 100.00	%	100 = 1%
136.41	AL2 10 to 20%	<i>Real</i>	0.00 ... 100.00	%	100 = 1%
136.42	AL2 20 to 30%	<i>Real</i>	0.00 ... 100.00	%	100 = 1%
136.43	AL2 30 to 40%	<i>Real</i>	0.00 ... 100.00	%	100 = 1%
136.44	AL2 40 to 50%	<i>Real</i>	0.00 ... 100.00	%	100 = 1%
136.45	AL2 50 to 60%	<i>Real</i>	0.00 ... 100.00	%	100 = 1%
136.46	AL2 60 to 70%	<i>Real</i>	0.00 ... 100.00	%	100 = 1%
136.47	AL2 70 to 80%	<i>Real</i>	0.00 ... 100.00	%	100 = 1%
136.48	AL2 80 to 90%	<i>Real</i>	0.00 ... 100.00	%	100 = 1%
136.49	AL2 over 90%	<i>Real</i>	0.00 ... 100.00	%	100 = 1%
136.50	AL2 reset date	<i>Data</i>	-	-	1 = 1
136.51	AL2 reset time	<i>Data</i>	-	-	1 = 1
146 Monitoring settings					
146.01	Power scaling	<i>Real</i>	0.1...30000.0	-	10 = 1
146.02	Reactive power scaling	<i>Real</i>	0.1...30000.0	-	10 = 1
146.03	Current scaling	<i>Real</i>	0...30000	A	1 = 1 A
146.04	DC voltage scaling	<i>Real</i>	0.10...30000.00	V	100 = 1 V
146.15	Filter time grid current	<i>Real</i>	20...20000	ms	1 = 1 ms
146.16	Filter time grid voltage	<i>Real</i>	20...20000	ms	1 = 1 ms
146.17	Filter time grid power	<i>Real</i>	20...20000	ms	1 = 1 ms
147 Data storage					
147.01	Data storage 1 real32	<i>Real</i>	-2147483.000...2147483.000	-	1000 = 1
147.02	Data storage 2 real32	<i>Real</i>	-2147483.000...2147483.000	-	1000 = 1
147.03	Data storage 3 real32	<i>Real</i>	-2147483.000...2147483.000	-	1000 = 1
147.04	Data storage 4 real32	<i>Real</i>	-2147483.000...2147483.000	-	1000 = 1
147.05	Data storage 5 real32	<i>Real</i>	-2147483.000...2147483.000	-	1000 = 1
147.06	Data storage 6 real32	<i>Real</i>	-2147483.000...2147483.000	-	1000 = 1
147.07	Data storage 7 real32	<i>Real</i>	-2147483.000...2147483.000	-	1000 = 1
147.08	Data storage 8 real32	<i>Real</i>	-2147483.000...2147483.000	-	1000 = 1
147.11	Data storage 1 int32	<i>Real</i>	-2147483648...2147483647	-	1 = 1
147.12	Data storage 2 int32	<i>Real</i>	-2147483648...2147483647	-	1 = 1
147.13	Data storage 3 int32	<i>Real</i>	-2147483648...2147483647	-	1 = 1
147.14	Data storage 4 int32	<i>Real</i>	-2147483648...2147483647	-	1 = 1
147.15	Data storage 5 int32	<i>Real</i>	-2147483648...2147483647	-	1 = 1
147.16	Data storage 6 int32	<i>Real</i>	-2147483648...2147483647	-	1 = 1
147.17	Data storage 7 int32	<i>Real</i>	-2147483648...2147483647	-	1 = 1
147.18	Data storage 8 int32	<i>Real</i>	-2147483648...2147483647	-	1 = 1
147.21	Data storage 1 int16	<i>Real</i>	-32768...32767	-	1 = 1
147.22	Data storage 2 int16	<i>Real</i>	-32768...32767	-	1 = 1
147.23	Data storage 3 int16	<i>Real</i>	-32768...32767	-	1 = 1
147.24	Data storage 4 int16	<i>Real</i>	-32768...32767	-	1 = 1
147.25	Data storage 5 int16	<i>Real</i>	-32768...32767	-	1 = 1
147.26	Data storage 6 int16	<i>Real</i>	-32768...32767	-	1 = 1
147.27	Data storage 7 int16	<i>Real</i>	-32768...32767	-	1 = 1
147.28	Data storage 8 int16	<i>Real</i>	-32768...32767	-	1 = 1
147.31	Data storage 1 real32 type	<i>List</i>	0...2	-	1 = 1

No.	Name	Type	Range	Unit	FbEq32
147.32	Data storage 2 real32 type	List	0...2	-	1 = 1
147.33	Data storage 3 real32 type	List	0...2	-	1 = 1
147.34	Data storage 4 real32 type	List	0...2	-	1 = 1
147.35	Data storage 5 real32 type	List	0...2	-	1 = 1
147.36	Data storage 6 real32 type	List	0...2	-	1 = 1
147.37	Data storage 7 real32 type	List	0...2	-	1 = 1
147.38	Data storage 8 real32 type	List	0...2	-	1 = 1
149 Panel port communication					
149.01	Node ID number	Real	1...32	-	1 = 1
149.03	Baud rate	List	0...7	-	1 = 1
149.04	Communication loss time	Real	0.3...3000.0	s	10 = 1 s
149.05	Communication loss action	List	0...1	-	1 = 1
149.06	Refresh settings	List	0...1	-	1 = 1
150 FBA					
150.01	FBA A enable	List	0...3	-	1 = 1
150.02	FBA A comm loss func	List	0...3	-	1 = 1
150.03	FBA A comm loss t out	Real	0.3 ... 6553.5	s	10 = 1 s
150.04	FBA A ref1 type	List	0...13	-	1 = 1
150.05	FBA A ref2 type	List	0...10	-	1 = 1
150.07	FBA A actual1 type	List	0...10	-	1 = 1
150.08	FBA A actual2 type	List	0...10	-	1 = 1
150.10	FBA A act1 transparent source	Analog src	-	-	1 = 1
150.11	FBA A act2 transparent source	Analog src	-	-	1 = 1
150.12	FBA A debug mode	List	0...1	-	1 = 1
150.13	FBA A control word	Data	0000h...FFFFh	-	1 = 1
150.14	FBA A reference 1	Real	-2147483648...2147483647	-	1 = 1
150.15	FBA A reference 2	Real	-2147483648...2147483647	-	1 = 1
150.16	FBA A status word	Data	0000h...FFFFh	-	1 = 1
150.17	FBA A actual value 1	Real	-2147483648...2147483647	-	1 = 1
150.18	FBA A actual value 2	Real	-2147483648...2147483647	-	1 = 1
150.21	FBA A timelevel sel	List	0...3	-	1 = 1
150.31	FBA B enable	List	0...3	-	1 = 1
150.32	FBA B comm loss func	List	0...3	-	1 = 1
150.33	FBA B comm loss timeout	Real	0.3 ... 6553.5	s	10 = 1 s
150.34	FBA B ref1 type	List	0...13	-	1 = 1
150.35	FBA B ref2 type	List	0...10	-	1 = 1
150.36	FBA B SW sel	List	0...1	-	1 = 1
150.37	FBA B actual 1 type	List	0...10	-	1 = 1
150.38	FBA B actual 2 type	List	0...10	-	1 = 1
150.39	FBA B SW transparent source	Analog src	-	-	1 = 1

214 Additional parameter data

No.	Name	Type	Range	Unit	FbEq32
150.40	FBA B act1 transparent source	<i>Analog src</i>	-	-	1 = 1
150.41	FBA B act2 transparent source	<i>Analog src</i>	-	-	1 = 1
150.42	FBA B debug mode	<i>Data</i>	0...1	-	1 = 1
150.43	FBA B control word	<i>Real</i>	00000000h ... FFFFFFFFh	-	1 = 1
150.44	FBA B reference 1	<i>Real</i>	-2147483648...2147483647	-	1 = 1
150.45	FBA B reference 2	<i>Real</i>	-2147483648...2147483647	-	1 = 1
150.46	FBA B status word	<i>Data</i>	00000000h ... FFFFFFFFh	-	1 = 1
150.47	FBA B actual value 1	<i>Real</i>	-2147483648...2147483647	-	1 = 1
150.48	FBA B actual value 2	<i>Real</i>	-2147483648...2147483647	-	1 = 1
150.51	FBA B timelevel sel	<i>List</i>	0...3	-	1 = 1
151 FBA A settings					
151.01	FBA A type	<i>List</i>	-	-	1 = 1
151.02	FBA A Par2	<i>Real</i>	0...65535	-	1 = 1
...	
151.26	FBA A Par26	<i>Real</i>	0...65535	-	1 = 1
151.27	FBA A par refresh	<i>List</i>	0...1	-	1 = 1
151.28	FBA A par table ver	<i>Data</i>	-	-	1 = 1
151.29	FBA A drive type code	<i>Real</i>	0...65535	-	1 = 1
151.30	FBA A mapping file ver	<i>Real</i>	0...65535	-	1 = 1
151.31	D2FBA A comm status	<i>List</i>	0...6	-	1 = 1
151.32	FBA A comm SW ver	<i>Data</i>	-	-	1 = 1
151.33	FBA A appl SW ver	<i>Data</i>	-	-	1 = 1
152 FBA A data in					
152.01	FBA A data in1	<i>List</i>	-	-	1 = 1
...	
152.12	FBA A data in12	<i>List</i>	-	-	1 = 1
153 FBA A data out					
153.01	FBA data out1	<i>List</i>	-	-	1 = 1
...	
153.12	FBA data out12	<i>List</i>	-	-	1 = 1
154 FBA B settings					
154.01	FBA B type	<i>List</i>	-	-	1 = 1
154.02	FBA B Par2	<i>Real</i>	0...65535	-	1 = 1
...	
154.26	FBA B Par26	<i>Real</i>	0...65535	-	1 = 1
154.27	FBA B par refresh	<i>List</i>	0...1	-	1 = 1
154.28	FBA B par table ver	<i>Data</i>	-	-	1 = 1
154.29	FBA B drive type code	<i>Real</i>	0...65535	-	1 = 1
154.30	FBA B mapping file ver	<i>Real</i>	0...65535	-	1 = 1
154.31	D2FBA B comm sta	<i>List</i>	0...6	-	1 = 1
154.32	FBA B comm SW ver	<i>Data</i>	-	-	1 = 1
154.33	FBA B appl SW ver	<i>Data</i>	-	-	1 = 1
155 FBA B data in					
155.01	FBA B data in1	<i>List</i>	-	-	1 = 1
...	
155.12	FBA B data in12	<i>List</i>	-	-	1 = 1

No.	Name	Type	Range	Unit	FbEq32
156 FBA B data out					
156.01	FBA B data out1	List	-	-	1 = 1
...	
156.12	FBA B data out12	List	-	-	1 = 1
160 DDCS communication					
160.01	M/F communication port	List	-	-	-
160.02	M/F node address	Real	1...254	-	-
160.03	M/F mode	List	0...6	-	-
160.05	M/F HW connection	List	0...1	-	-
160.07	M/F link control	Real	1...15	-	-
160.08	M/F comm loss timeout	Real	0...65535	ms	-
160.09	M/F comm loss function	List	0...3	-	-
160.10	M/F ref1 type	List	0...13	-	-
160.11	M/F ref2 type	List	0...13	-	-
160.12	M/F act1 type	List	0...13	-	-
160.13	M/F act2 type	List	0...13	-	-
160.14	M/F follower selection	Real	0...14	-	-
160.17	Follower fault action	List	0...2	-	-
160.18	Follower enable	List	0...6	-	-
160.23	M/F status supervision sel 1	PB	0000h...FFFFh	-	1 = 1
160.27	M/F status supervision sel 2	PB	0000h...FFFFh	-	1 = 1
160.31	M/F wake up delay	Real	0.0 ... 180.0	s	10 = 1 s
160.41	Extension adapter com port	List	-	-	-
160.51	DDCS controller comm port	List	-	-	-
160.52	DDCS controller node address	Real	1...254	-	-
160.55	DDCS controller HW connection	List	0...1	-	-
160.56	DDCS controller baud rate	List	1...8	-	-
160.57	DDCS controller link control	Real	1...15	-	1 = 1
160.58	DDCS controller comm loss time	Real	0...60000	ms	1 = 1 ms
160.59	DDCS controller comm loss function	List	0...2	-	-
160.60	DDCS controller ref1 type	List	0...13	-	-
160.61	DDCS controller ref2 type	List	0...13	-	-
160.62	DDCS controller act1 type	List	0...13	-	-
160.63	DDCS controller act2 type	List	0...13	-	-
160.64	Mailbox dataset selection	List	0...1	-	-
160.77	INU-LSU link control	Real	1...15	-	-
161 DDCS transmit					
161.01	M/F data 1 selection	List	-	-	-
161.02	M/F data 2 selection	List	-	-	-
161.03	M/F data 3 selection	List	-	-	-
161.25	M/F data 1 value	Real	0...65535	-	-

216 Additional parameter data

No.	Name	Type	Range	Unit	FbEq32
161.26	M/F data 2 value	<i>Real</i>	0...65535	-	-
161.27	M/F data 3 value	<i>Real</i>	0...65535	-	-
161.51	Data set 11 data 1 selection	<i>List</i>	0...24	-	-
161.52	Data set 11 data 2 selection	<i>List</i>	0...24	-	-
161.53	Data set 11 data 3 selection	<i>List</i>	0...24	-	-
161.54	Data set 13 data 1 selection	<i>List</i>	0...24	-	-
161.55	Data set 13 data 2 selection	<i>List</i>	0...24	-	-
161.56	Data set 13 data 3 selection	<i>List</i>	0...24	-	-
161.57	Data set 15 data 1 selection	<i>List</i>	0...24	-	-
161.58	Data set 15 data 2 selection	<i>List</i>	0...24	-	-
161.59	Data set 15 data 3 selection	<i>List</i>	0...24	-	-
161.60	Data set 17 data 1 selection	<i>List</i>	0...24	-	-
161.61	Data set 17 data 2 selection	<i>List</i>	0...24	-	-
161.62	Data set 17 data 3 selection	<i>List</i>	0...24	-	-
161.63	Data set 19 data 1 selection	<i>List</i>	0...24	-	-
161.64	Data set 19 data 2 selection	<i>List</i>	0...24	-	-
161.65	Data set 19 data 3 selection	<i>List</i>	0...24	-	-
161.66	Data set 21 data 1 selection	<i>List</i>	0...24	-	-
161.67	Data set 21 data 2 selection	<i>List</i>	0...24	-	-
161.68	Data set 21 data 3 selection	<i>List</i>	0...24	-	-
161.69	Data set 23 data 1 selection	<i>List</i>	0...24	-	-
161.70	Data set 23 data 2 selection	<i>List</i>	0...24	-	-
161.71	Data set 23 data 3 selection	<i>List</i>	0...24	-	-
161.72	Data set 25 data 1 selection	<i>List</i>	0...24	-	-
161.73	Data set 25 data 2 selection	<i>List</i>	0...24	-	-
161.74	Data set 25 data 3 selection	<i>List</i>	0...24	-	-
161.101	Data set 11 data 1 value	<i>Real</i>	0...65535	-	1 = 1
161.102	Data set 11 data 2 value	<i>Real</i>	0...65535	-	1 = 1
161.103	Data set 11 data 3 value	<i>Real</i>	0...65535	-	1 = 1
161.104	Data set 13 data 1 value	<i>Real</i>	0...65535	-	1 = 1

No.	Name	Type	Range	Unit	FbEq32
161.105	Data set 13 data 2 value	<i>Real</i>	0...65535	-	1 = 1
161.106	Data set 13 data 3 value	<i>Real</i>	0...65535	-	1 = 1
161.107	Data set 15 data 1 value	<i>Real</i>	0...65535	-	1 = 1
161.108	Data set 15 data 2 value	<i>Real</i>	0...65535	-	1 = 1
161.109	Data set 15 data 3 value	<i>Real</i>	0...65535	-	1 = 1
161.110	Data set 17 data 1 value	<i>Real</i>	0...65535	-	1 = 1
161.111	Data set 17 data 2 value	<i>Real</i>	0...65535	-	1 = 1
161.112	Data set 17 data 3 value	<i>Real</i>	0...65535	-	1 = 1
161.113	Data set 19 data 1 value	<i>Real</i>	0...65535	-	1 = 1
161.114	Data set 19 data 2 value	<i>Real</i>	0...65535	-	1 = 1
161.115	Data set 19 data 3 value	<i>Real</i>	0...65535	-	1 = 1
161.116	Data set 21 data 1 value	<i>Real</i>	0...65535	-	1 = 1
161.117	Data set 21 data 2 value	<i>Real</i>	0...65535	-	1 = 1
161.118	Data set 21 data 3 value	<i>Real</i>	0...65535	-	1 = 1
161.119	Data set 23 data 1 value	<i>Real</i>	0...65535	-	1 = 1
161.120	Data set 23 data 2 value	<i>Real</i>	0...65535	-	1 = 1
161.121	Data set 23 data 3 value	<i>Real</i>	0...65535	-	1 = 1
161.122	Data set 25 data 1 value	<i>Real</i>	0...65535	-	1 = 1
161.123	Data set 25 data 2 value	<i>Real</i>	0...65535	-	1 = 1
161.124	Data set 25 data 3 value	<i>Real</i>	0...65535	-	1 = 1
162 DDCS receive					
162.01	M/F data 1 selection	<i>List</i>	-	-	-
162.02	M/F data 2 selection	<i>List</i>	-	-	-
162.03	M/F data 3 selection	<i>List</i>	-	-	-
162.04	Follower node 2 data 1 sel	<i>List</i>	-	-	-
162.05	Follower node 2 data 2 sel	<i>List</i>	-	-	-
162.06	Follower node 2 data 3 sel	<i>List</i>	-	-	-
162.07	Follower node 3 data 1 sel	<i>List</i>	-	-	-
162.08	Follower node 3 data 2 sel	<i>List</i>	-	-	-
162.09	Follower node 3 data 3 sel	<i>List</i>	-	-	-
162.10	Follower node 4 data 1 sel	<i>List</i>	-	-	-
162.11	Follower node 4 data 2 sel	<i>List</i>	-	-	-
162.12	Follower node 4 data 3 sel	<i>List</i>	-	-	-
162.25	MF data 1 value	<i>Real</i>	0...65535	-	-
162.26	MF data 2 value	<i>Real</i>	0...65535	-	-
162.27	MF data 3 value	<i>Real</i>	0...65535	-	-
162.28	Follower node 2 data 1 value	<i>Real</i>	0...65535	-	-
162.29	Follower node 2 data 2 value	<i>Real</i>	0...65535	-	-
162.30	Follower node 2 data 3 value	<i>Real</i>	0...65535	-	-
162.31	Follower node 3 data 1 value	<i>Real</i>	0...65535	-	-
162.32	Follower node 3 data 2 value	<i>Real</i>	0...65535	-	-
162.33	Follower node 3 data 3 value	<i>Real</i>	0...65535	-	-
162.34	Follower node 4 data 1 value	<i>Real</i>	0...65535	-	-

218 Additional parameter data

No.	Name	Type	Range	Unit	FbEq32
162.35	Follower node 4 data 2 value	<i>Real</i>	0...65535	-	-
162.36	Follower node 4 data 3 value	<i>Real</i>	0...65535	-	-
162.37	M/F communication status 1	<i>PB</i>	0000h...FFFFh	-	1 = 1
162.38	M/F communication status 2	<i>PB</i>	0000h...FFFFh	-	1 = 1
162.41	M/F follower ready status 1	<i>PB</i>	0000h...FFFFh	-	1 = 1
162.42	M/F follower ready status 2	<i>PB</i>	0000h...FFFFh	-	1 = 1
162.51	Data set 10 data 1 selection	<i>List</i>	0...21	-	-
162.52	Data set 10 data 2 selection	<i>List</i>	0...21	-	-
162.53	Data set 10 data 3 selection	<i>List</i>	0...21	-	-
162.54	Data set 12 data 1 selection	<i>List</i>	0...21	-	-
162.55	Data set 12 data 2 selection	<i>List</i>	0...21	-	-
162.56	Data set 12 data 3 selection	<i>List</i>	0...21	-	-
162.57	Data set 14 data 1 selection	<i>List</i>	0...21	-	-
162.58	Data set 14 data 2 selection	<i>List</i>	0...21	-	-
162.59	Data set 14 data 3 selection	<i>List</i>	0...21	-	-
162.60	Data set 16 data 1 selection	<i>List</i>	0...21	-	-
162.61	Data set 16 data 2 selection	<i>List</i>	0...21	-	-
162.62	Data set 16 data 3 selection	<i>List</i>	0...21	-	-
162.63	Data set 18 data 1 selection	<i>List</i>	0...21	-	-
162.64	Data set 18 data 2 selection	<i>List</i>	0...21	-	-
162.65	Data set 18 data 3 selection	<i>List</i>	0...21	-	-
162.66	Data set 20 data 1 selection	<i>List</i>	0...21	-	-
162.67	Data set 20 data 2 selection	<i>List</i>	0...21	-	-
162.68	Data set 20 data 3 selection	<i>List</i>	0...21	-	-
162.69	Data set 22 data 1 selection	<i>List</i>	0...21	-	-
162.70	Data set 22 data 2 selection	<i>List</i>	0...21	-	-
162.71	Data set 22 data 3 selection	<i>List</i>	0...21	-	-

No.	Name	Type	Range	Unit	FbEq32
162.72	Data set 24 data 1 selection	List	0...21	-	-
162.73	Data set 24 data 2 selection	List	0...21	-	-
162.74	Data set 24 data 3 selection	List	0...21	-	-
162.101	Data set 10 data 1 value	Real	0...65535	-	1 = 1
162.102	Data set 10 data 2 value	Real	0...65535	-	1 = 1
162.103	Data set 10 data 3 value	Real	0...65535	-	1 = 1
162.104	Data set 12 data 1 value	Real	0...65535	-	1 = 1
162.105	Data set 12 data 2 value	Real	0...65535	-	1 = 1
162.106	Data set 12 data 3 value	Real	0...65535	-	1 = 1
162.107	Data set 14 data 1 value	Real	0...65535	-	1 = 1
162.108	Data set 14 data 2 value	Real	0...65535	-	1 = 1
162.109	Data set 14 data 3 value	Real	0...65535	-	1 = 1
162.110	Data set 16 data 1 value	Real	0...65535	-	1 = 1
162.111	Data set 16 data 2 value	Real	0...65535	-	1 = 1
162.112	Data set 16 data 3 value	Real	0...65535	-	1 = 1
162.113	Data set 18 data 1 value	Real	0...65535	-	1 = 1
162.114	Data set 18 data 2 value	Real	0...65535	-	1 = 1
162.115	Data set 18 data 3 value	Real	0...65535	-	1 = 1
162.116	Data set 20 data 1 value	Real	0...65535	-	1 = 1
162.117	Data set 20 data 2 value	Real	0...65535	-	1 = 1
162.118	Data set 20 data 3 value	Real	0...65535	-	1 = 1
162.119	Data set 22 data 1 value	Real	0...65535	-	1 = 1
162.120	Data set 22 data 2 value	Real	0...65535	-	1 = 1
162.121	Data set 22 data 3 value	Real	0...65535	-	1 = 1
162.122	Data set 24 data 1 value	Real	0...65535	-	1 = 1
162.123	Data set 24 data 2 value	Real	0...65535	-	1 = 1
162.124	Data set 24 data 3 value	Real	0...65535	-	1 = 1
190 BAMU measurements					
190.01	Phase voltage U1	Real	0.00...2000.00	V	100 = 1 V
190.02	Phase voltage V1	Real	0.00...2000.00	V	100 = 1 V
190.03	Phase voltage W1	Real	0.00...2000.00	V	100 = 1 V
190.06	Mains voltage U1-V1	Real	0.00...2000.00	V	100 = 1 V
190.07	Mains voltage V1-W1	Real	0.00...2000.00	V	100 = 1 V
190.08	Mains voltage W1-U1	Real	0.00...2000.00	V	100 = 1 V
190.15	Frequency 1	Real	0.00...100.00	Hz	100 = 1 Hz
190.20	Phase voltage U2	Real	0.00...2000.00	V	100 = 1 V
190.21	Phase voltage V2	Real	0.00...2000.00	V	100 = 1 V
190.22	Phase voltage W2	Real	0.00...2000.00	V	100 = 1 V
190.25	Mains voltage U2-V2	Real	0.00...2000.00	V	100 = 1 V
190.26	Mains voltage V2-W2	Real	0.00...2000.00	V	100 = 1 V
190.27	Mains voltage W2-U2	Real	0.00...2000.00	V	100 = 1 V
190.34	Frequency 2	Real	0.00...100.00	Hz	100 = 1 Hz
190.40	Phase current U1	Real	-	A	100 = 1 A
190.41	Phase current V1	Real	-	A	100 = 1 A
190.42	Phase current W1	Real	-	A	100 = 1 A

No.	Name	Type	Range	Unit	FbEq32
191 BAMU configuration					
191.01	U1 measurement	List	0...1	-	1 = 1
191.02	U1 meas type	List	1...3	-	1 = 1
191.10	U2 measurement	List	0...1	-	1 = 1
191.11	U2 meas type	List	1...3	-	1 = 1
191.20	I measurement	List	0...1	-	1 = 1
191.22	Current transf. ratio	Real	-	-	1 = 1
191.29	Board type	List	0...65535	-	1 = 1
191.30	BAMU 1 channel	Real	0...12	-	1 = 1
191.40	Transformer location	List	0...2	-	1 = 1
191.41	Circuit breaker location	List	0...2	-	1 = 1
191.42	U1 meas location	List	0...4	-	1 = 1
191.43	U2 meas location	List	0...4	-	1 = 1
195 HW configuration					
195.01	Supply voltage	List	0...6	-	1 = 1
195.04	Control board supply	List	0...2	-	1 = 1
195.09	Switch fuse controller	List	0...2	-	1 = 1
195.13	Reduced run mode	List	0...65535	-	1 = 1
195.14	Connected modules	PB	0000h...FFFFh	-	1 = 1
195.16	Router mode	List	-	-	1 = 1
195.17	Router channel config	PB	0000h...FFFFh	-	1 = 1
195.20	HW options word 1	PB	0000h...FFFFh	-	1 = 1
195.30	Parallel type list filter	List	1...4	-	1 = 1
195.31	Parallel connection rating id	List	-	-	1 = 1
195.51	Current offset calibration	List	0...1	-	1 = 1
196 System					
196.01	Language	List	-	-	1 = 1
196.02	Pass code	Data	0	-	1 = 1
196.03	Access levels active	PB	0000h...FFFFh	-	1 = 1
196.06	Parameter restore	List	-	-	1 = 1
196.07	Parameter save manually	List	0...1	-	1 = 1
196.08	Control board boot	Real	0...1	-	1 = 1
196.10	User set status	List	-	-	1 = 1
196.11	User set save/load	List	-	-	1 = 1
196.12	User set I/O mode in1	Binary src	-	-	1 = 1
196.13	User set I/O mode in2	Binary src	-	-	1 = 1
196.20	Time sync primary source	List	0...10	-	1 = 1
196.24	Full days since 1st Jan 1980	Real	1...59999	-	1 = 1
196.25	Time in minutes within 24 h	Real	0...1439	-	1 = 1
196.26	Time in ms within one minute	Real	0...59999	-	1 = 1
196.29	Time sync source status	PB	0000h...FFFFh	-	1 = 1
196.39	Power up event logging	List	0...1	-	1 = 1
196.61	User data logger status word	PB	0000h...FFFFh	-	1 = 1
196.63	User data logger trigger	Binary src	-	-	-
196.64	User data logger start	Binary src	-	-	-

No.	Name	Type	Range	Unit	FbEq32
196.65	Factory data logger time level	List	-	-	1 = 1
196.70	Disable adaptive program	Data	0...1	-	1 = 1
<i>(Parameters 196.100...196.102 only visible when enabled by parameter 196.02)</i>					
196.100	Change user pass code	Data	10000000...99999999	-	1 = 1
196.101	Confirm user pass code	Data	10000000...99999999	-	1 = 1
196.102	User lock functionality	PB	0000h...FFFFh	-	1 = 1
197 Grid control					
197.20	Dc-ctrl active damping	List	0...1	-	1 = 1
199 Off grid configuration					
This parameter group contains parameters related to configuration of the optimal grid control functionality (option +N8053). For details on the parameters in this group, see <i>Optimal grid control of ACS880 IGBT supply control program supplement</i> (3AXD50000164745 [English]).					
206 I/O bus configuration					
207 I/O bus service					
208 I/O bus diagnostics					
209 I/O bus fan identification					
<i>(Groups only visible with a BCU control unit)</i> These groups contain parameters related to the distributed I/O bus, which is used with some drives for monitoring the cooling fans of the cabinet system. For details, see <i>CIO-01 I/O module for distributed I/O bus control user's manual</i> (3AXD50000126880 [English]).					

8

Fault tracing

What this chapter contains

The chapter lists the warning and fault messages including possible causes and corrective actions. The causes of most warnings and faults can be identified and corrected using the information in this chapter. If not, an ABB service representative should be contacted.

Warnings and faults are listed below in separate tables. Each table is sorted by warning/fault code.

Safety



WARNING! Only qualified electricians are allowed to service the IGBT supply unit. See *ACS880 multidrive cabinets and modules safety instructions* (3AUA0000102301 [English]) for air-cooled units, and *ACS880 liquid-cooled multidrive cabinets and modules safety instructions* (3AXD50000048633) for liquid-cooled units.

Indications

■ Warnings and faults

Warnings and faults indicate an abnormal status. The codes and names of active warnings/faults are displayed on the control panel as well as the Drive composer PC tool. Only the codes of warnings/faults are available over fieldbus.

Warnings do not need to be reset; they stop showing when the cause of the warning ceases. After the cause of the fault has been corrected, the active fault can be reset from the control panel or Drive composer PC tool. The control panel can be in local or remote (external) control mode. When the fault has been removed, the supply unit can be restarted. Faults can also be reset from an external source selected by parameter [131.11 Fault reset selection](#).

Warning and fault indications can be directed to a relay output or a digital input/output by selecting [Warning](#), [Fault](#) or [Fault \(-1\)](#) in the source selection parameter. See sections

- [Programmable digital inputs and outputs](#) (page 27)
- [Programmable relay outputs](#) (page 27), and
- [Programmable I/O extensions](#) (page 28).

■ Pure events

In addition to warnings and faults, there are pure events that are only recorded in the event logs. The codes of these events are included in the [Warning messages](#) table.

■ Editable messages

For some warnings and faults, the message text can be edited and instructions and contact information added. To edit these messages, choose **Menu - Settings - Edit texts** on the control panel or Drive composer pro PC tool.

Warning/fault history and analysis

■ Event logs

The IGBT supply unit has two event logs that can be accessed from the main Menu on the control panel. The logs can also be accessed (and reset) using the Drive composer PC tool.

One of the logs contains faults and fault resets. The other log lists warnings and pure events, as well as clearing entries. Both logs contain the 64 most recent events. All indications are stored in the event logs with a time stamp and other information.

Auxiliary codes

Some events generate an auxiliary code that often helps in pinpointing the problem. The auxiliary code is displayed on the control panel together with the message. It is also stored in the event log details. In the Drive composer PC tool, the auxiliary code (if any) is shown in the event listing.

Factory data logger

The supply unit has a data logger that samples preselected values at 500-microsecond (default; see parameter [196.65 Factory data logger time level](#)) intervals. By default, approximately 700 samples recorded immediately before and after a fault are saved to the memory unit of the supply unit. The fault data of the last five faults is accessible in the event log when viewed in the Drive composer pro PC tool. (The fault data is not accessible through the control panel.)

The values that are recorded in the factory data log are [101.01 DC voltage](#), [101.09 Grid voltage](#), [101.21 Converter current %](#), [101.12 Power](#), [101.15 Reactive power %](#), [106.01 Main control word](#), [130.01 Limit word 1](#), [130.03 Limit word 3](#) and [106.11 Main status word](#). The selection of parameters cannot be changed by the user.

■ Other data loggers

User data logger

A custom data logger can be configured using the Drive composer pro PC tool. This functionality enables the free selection of up to eight parameters to be sampled at selectable intervals. The triggering conditions and the length of the monitoring period can also be defined by the user within the limit of approximately 8000 samples. In addition to the PC tool, the status of the logger is shown by parameter [196.61 User data logger status word](#). The triggering sources can be selected by parameters [196.63 User data logger trigger](#) and [196.64 User data logger start](#)). The configuration, status and collected data is saved to the memory unit for later analysis.

PSL2 data logger

The BCU control unit used with certain supply unit types (especially those with parallel-connected supply modules) contains a data logger that collects data from the supply modules to help fault tracing and analysis. The data is saved onto the SD memory card attached to the BCU, and can be analyzed by ABB service personnel.

■ Parameters that contain warning/fault information

The codes of active warnings and faults (maximum five each), and five previously occurred warnings and faults are stored in the parameters [104.01](#)...[104.20](#).

Fault and warning words

With fault and warning words, it is possible to read status of multiple events simultaneously. 16-bit fault word [104.21 Fault word 1](#) shows activity of some predefined faults. 16-bit warning word [104.31 Warning word 1](#) shows activity of some predefined warnings. 16-bit event word [104.40 Event word 1](#) shows activity of user-configurable events. Each bit of [104.40 Event word 1](#) is configurable by event (basic) code, and optionally auxiliary code. If auxiliary code is set to zero, all auxiliary codes are accepted. Configuration of [104.40 Event word 1](#) is done by parameters [104.41...104.72](#).

Bits 3, 8 and 10 of [104.21 Fault word 1](#) can indicate several events as listed below. Also, bits 0 and 3 of [104.31 Warning word 1](#) can indicate several events as listed below. To use these bits, the user selects one of the codes listed below in that bit.

104.21 Fault word 1 , bit 3
Code and name
CFE0 Power unit temperature
<ul style="list-style-type: none"> • 2E04 IGBT overload • 4E02 IGBT temperature • 4E01 Cooling • 4E03 Excess temperature • 4E04 Excess temperature difference

104.21 Fault word 1 , bit 8
Code and name
CFE1 Internal system fault
<ul style="list-style-type: none"> • 6E03 Task overload • 6E04 Stack overflow • 6E05 Internal file load • 6E06 Internal record load • 6E07 Application loading • 6E09 Internal SSW fault • 6E0B Kernel overload • 6E15 Text data overflow • 6E16 Text 32-bit table overflow • 6E17 Text 64-bit table overflow • 6E18 Text file overflow • 6E1D Internal error

104.21 Fault word 1 , bit 10
Code and name
CFE3 Field bus comm
<ul style="list-style-type: none"> • 7E0B FBA A communication • 7E0C FBA B communication • 7E11 DDCCS controller comm loss

<p><i>104.31 Warning word 1, bit 0</i></p> <p>Code and name</p>
<p>CFE4 Field bus comm</p> <ul style="list-style-type: none"> • AE30 FBA A communication • AE31 FBA B communication • AE6D DDCS controller comm loss

<p><i>104.31 Warning word 1, bit 3</i></p> <p>Code and name</p>
<p>CFE2 Power unit temperature</p> <ul style="list-style-type: none"> • AE12 IGBT overtemperature • AE13 Cooling • AE14 Excess temperature • AE15 Excess temperature difference • AE16 IGBT temperature • AE04 IGBT overload

Warning messages

Code (hex)	Warning	Cause	What to do
AE00	Current calibration	Current offset and gain measurement calibration will occur at next start.	Informative warning.
AE01	Overcurrent	Output current has exceeded internal fault limit.	<p>Check supply voltage.</p> <p>Check that there are no power factor correction capacitors or surge absorbers in supply cable.</p> <p>Check motor load and acceleration times.</p> <p>Check power semiconductors (IGBTs) and current transducers.</p> <p>Check the auxiliary code (format XXXY YYZZ). With parallel-connected supply modules, "Y YY" specifies through which BCU control unit channel the fault was received. "ZZ" indicates the phase that triggered the fault (0: No detailed information available, 1: U-phase, 2: V-phase, 4: W-phase, 3/5/6/7: multiple phases).</p>
AE02	Earth leakage Programmable warning: <i>131.20 Earth fault</i>	IGBT supply has detected load unbalance.	<p>Check AC fuses.</p> <p>Check for earth leakages.</p> <p>Check supply cabling.</p> <p>Check power modules.</p> <p>Check there are no power factor correction capacitors or surge absorbers in supply cable.</p> <p>Check the auxiliary code (format XXXY YYZZ, where "Y YY" is the module channel number starting from 1). With parallel-connected modules, "Y YY" specifies through which BCU control unit channel the fault was received.</p>
AE03	Short circuit	IGBT supply has detected short circuit.	<p>Check supply cable.</p> <p>Check there are no power factor correction capacitors or surge absorbers in supply cable.</p>
AE04	IGBT overload	Excessive IGBT junction to case temperature.	Check supply cable.
AE05	BU current difference	Current difference detected by the branching unit (BU).	<p>Check converter fuses.</p> <p>Check converter(s).</p> <p>Check inverter(s).</p> <p>Check LCL filter.</p>
AE06	BU earth leakage	Earth leakage detected by the branching unit: sum of all currents exceeds the level.	<p>Check AC fuses.</p> <p>Check for earth leakages.</p> <p>Check supply cabling.</p> <p>Check power modules.</p> <p>Check there are no power factor correction capacitors or surge absorbers in supply cable.</p>

Code (hex)	Warning	Cause	What to do
AE09	DC link overvoltage	Excessive intermediate circuit DC voltage. Note: This warning can be shown only when the IGBT supply unit is not modulating.	Check that parameter 195.01 Supply voltage is set according to the supply voltage in use.
AE0A	DC link undervoltage	Intermediate circuit DC voltage is not sufficient due to missing phase in supply voltage, blown fuse or rectifier bridge internal fault. Note: This warning can be shown only when the IGBT supply unit is not modulating.	Check supply and fuses.
AE0B	DC not charged	The voltage of the intermediate DC circuit has not yet risen to operating level.	Check the input voltage setting in parameter 195.01 Supply voltage . Check the input voltage. If the problem persists, contact your local ABB representative.
AE0C	BU DC link difference	DC link voltage difference detected by the branching unit.	Check DC fuses. Check converter module connections to DC link.
AE0D	BU voltage difference	Main voltage difference detected by the branching unit.	Check AC fuses. Check supply cable.
AE0E	Incorrect temperature sensor setup	Sensor type mismatch or faulty wiring between an encoder interface module and the temperature sensor.	Check the wiring of the sensor. The auxiliary code (see the event log) identifies the interface module. (0 = Module 1, 1 = Module 2).
AE0F	External temperature	Measured temperature 1 or 2 has exceeded warning limit.	Check the cooling of the supply (or other equipment whose temperature is being measured).
AE10	Ext Tmp1 warning (Editable message text)	External temperature 1 warning detected by Pt100 sensor.	Check parameters 130.50 Ext Tmp1 input selection and 130.52 Ext Tmp1 . Check wiring of Pt100 sensor.
AE11	Ext Tmp2 warning (Editable message text)	External temperature 2 warning detected by Pt100 sensor.	Check parameters 130.51 Ext Tmp2 input selection and 130.53 Ext Tmp2 . Check wiring of Pt100 sensor.
AE14	Excess temperature	Power unit temperature is excessive.	See AE19 Measurement circuit temperature (page 231).

Code (hex)	Warning	Cause	What to do
AE15	Excess temperature difference	High temperature difference between the IGBTs of different phases.	<p>Check the cabling.</p> <p>Check cooling of power module(s).</p> <p>Check the auxiliary code (format XXXY YYZZ). "XXX" indicates the source of difference (0: Single module, difference between phase IGBTs, 1: parallel connected modules, minimum-maximum difference between all IGBTs of all modules, 2: parallel-connected modules, minimum-maximum difference between auxiliary power supply boards). With parallel-connected modules, "Y YY" specifies through which BCU control unit channel the highest temperature was measured. "ZZ" specifies the phase (0: single module, 1: U-phase [parallel connection], 2: V-phase [parallel connection], 3: W-phase [parallel connection]).</p>
AE16	IGBT temperature	IGBT temperature is excessive.	<p>Check ambient conditions.</p> <p>Check air flow and fan operation.</p> <p>Check heatsink fins for dust pick-up.</p> <p>Check motor power against IGBT supply unit power.</p>
AE17	PU communication	Communication errors detected between the control unit and the power unit.	<p>Check the connection between the control unit and the power unit.</p> <p>Check the auxiliary code (format XXXY YYZZ). With parallel-connected modules, "Y YY" specifies the affected BCU control unit channel (0: broadcast). "ZZ" specifies the error source (8: Transmission errors in PSL link [see "XXX"], 9: Transmitter FIFO warning limit hit). "XXX" specifies the transmission error direction and detailed warning code (0: Rx/communication error, 1: Tx/Reed-Solomon symbol error, 2: Tx/no synchronization error, 3: Tx/Reed-Solomon decoder failures, 4: Tx/Manchester coding errors).</p>
AE18	XSTO circuit open	Circuit connected to XSTO:IN1 and/or XSTO:IN2 is open.	<p>Check XSTO circuit connections.</p> <p>See sections Default I/O connection diagram (BCU) on page 46, and Default I/O connection diagram (ZCU) on page 48.</p> <p>For more information, see appropriate hardware manual.</p>

Code (hex)	Warning	Cause	What to do
AE19	Measurement circuit temperature	Problem with internal temperature measurement of the drive.	Check the auxiliary code (format XXXY YZZZ). "Y YY" specifies through which BCU control unit channel the fault was received ("0 00" with a ZCU control unit). "ZZ" specifies the location: <u>With control program version 3.0x and later:</u> 1: U-phase IGBT, 2: V-phase IGBT, 3: W-phase IGBT, 4: PCB compartment fan or power supply board, 5: Power unit INT board, 6: Brake chopper, 7: Air inlet (sensor connected to INT board X10), 8: du/dt filter, FAh: Ambient temperature. <u>With control program version up to and including 2.7x:</u> 1: U-phase IGBT, 2: V-phase IGBT, 3: W-phase IGBT, 4: Power unit INT board, 5: Brake chopper, 6: Air inlet (sensor connected to INT board X10), 7: PCB compartment fan or power supply board, 8: du/dt filter, FAh: Ambient temperature.
AE1A	PU board powerfail	Power unit power supply failure.	Contact your local ABB representative.
AE1B	PU communication internal	Communication errors detected between the control unit and the power unit.	Check the connections between the control unit and the power unit.
AE1C	Measurement circuit ADC	Measurement circuit analog-to-digital converter fault.	Contact your local ABB representative.
AE1D	Measurement circuit DFF	Problem with current or voltage measurement of the power unit.	Contact your local ABB representative.
AE1E	PU state feedback	State feedback from output phases does not match control signals.	Contact your local ABB representative.
AE1F	Charging feedback	Charging feedback signal missing.	Check the feedback signal coming from the charging system.
AE21	Flash erase speed exceeded	The flash memory (in the memory unit) has been erased too frequently, compromising the lifetime of the memory.	Avoid forcing unnecessary parameter saves by parameter 196.07 or cyclic parameter writes (such as user logger triggering through parameters). Check the auxiliary code (format XYYY YZZZ). "X" specifies the source of warning (1: generic flash erase supervision). "ZZZ" specifies the flash subsector number that generated the warning.
AE24	Voltage category unselected	The supply voltage range has not been defined.	Define the supply voltage range (parameter 195.01 Supply voltage).
AE25	FBA A parameter conflict	The supply unit does not have a functionality requested by PLC, or requested functionality has not been activated.	Check PLC programming. Check settings of parameter groups 150 FBA and 151 FBA A settings .
AE26	FBA B parameter conflict	The supply unit does not have a functionality requested by PLC, or requested functionality has not been activated.	Check PLC programming. Check settings of parameter groups 150 FBA and 151 FBA A settings .

Code (hex)	Warning	Cause	What to do
AE27	AI parameterization	The current/voltage jumper setting of an analog input does not correspond to parameter settings.	Adjust either the jumper setting (on the control unit) or parameter 112.15/112.25 . Note: Control board reboot (either by cycling the power or through parameter 196.08 Control board boot) is required to validate any changes in the jumper settings.
AE2E	Extension AI parameterization	The hardware current/voltage setting of an analog input (on an I/O extension module) does not correspond to parameter settings.	Check the auxiliary code (format XX00 00YY). "XX" specifies the number of the I/O extension module (01: parameter group 114 Extension I/O module 1 , 02: 115 Extension I/O module 2 , 03: 116 Extension I/O module 3). "YY" specifies the analog input on the module. For example, in case of I/O extension module 1, analog input AI1 (auxiliary code 0000 0101), the hardware current/voltage setting on the module is shown by parameter 114.29 . The corresponding parameter setting is 114.30 . Adjust either the hardware setting on the module or the parameter to solve the mismatch. Note: Control board reboot (either by cycling the power or through parameter 196.08 Control board boot) is required to validate any changes in the hardware settings.
AE2F	Extension I/O configuration failure	The I/O extension module types and locations specified by parameters do not match the detected configuration.	Check the event log for an auxiliary code. The code indicates which I/O extension module is affected. Check the type and location settings of the modules (parameters 114.01 , 114.02 , 115.01 , 115.02 , 116.01 and 116.02). Check that the modules are properly installed.
AE30	FBA A communication Programmable warning: 150.02 FBA A comm loss func	Cyclical communication between the supply unit and fieldbus adapter module A or between PLC and fieldbus adapter module A is lost.	Check status of fieldbus communication. See user documentation of fieldbus interface. Check settings of parameter groups 150 FBA , 151 FBA A settings , 152 FBA A data in and 153 FBA A data out . Check cable connections. Check if communication master is able to communicate.
AE31	FBA B communication Programmable warning: 150.32 FBA B comm loss func	Cyclical communication between supply unit and fieldbus adapter module B or between PLC and fieldbus adapter module B is lost.	Check status of fieldbus communication. See user documentation of fieldbus interface. Check settings of parameter group 150 FBA , 154 FBA B settings , 155 FBA B data in and 156 FBA B data out . Check cable connections. Check if communication master is able to communicate.
AE32	EFB comm loss	The embedded fieldbus (EFB) interface has detected a communication loss.	Contact your local ABB representative.

Code (hex)	Warning	Cause	What to do
AE3E	Panel loss Programmable warning: 149.05 Communication loss action	Control panel or PC tool selected as active control location has ceased communicating.	Check PC tool or control panel connection. Check control panel connector. Replace control panel in mounting platform.
AE40	Output relay warning	Warning generated by an edge counter. Programmable warnings: 133.35 Edge counter 1 warning selection 133.45 Edge counter 2 warning selection	Check the event log for an auxiliary code. Check the source of the warning corresponding to the code: 2: 133.33 Edge counter 1 source 3: 133.43 Edge counter 2 source .
AE41	Supply unit starts warning		
AE42	Power ups warning		
AE43	Main contactor warning		
AE44	DC charge warning		
AE45	On-Time 1 warning (Editable message text) Programmable warning: 133.14 On-time 1 warning select	Warning generated by on-time timer 1.	Check the source of the warning (parameter 133.13 On-time 1 source).
AE46	On-Time 2 warning (Editable message text) Programmable warning: 133.24 On-time 2 warning select	Warning generated by on-time timer 2.	Check the source of the warning (parameter 133.23 On-time 2 source).
AE47	Edge counter 1 warning (Editable message text) Programmable warning: 133.35 Edge counter 1 warning selection	Warning generated by edge counter 1.	Check the source of the warning (parameter 133.33 Edge counter 1 source).
AE48	Edge counter 2 warning (Editable message text) Programmable warning: 133.45 Edge counter 2 warning selection	Warning generated by edge counter 2.	Check the source of the warning (parameter 133.43 Edge counter 2 source).
AE49	Value counter 1 warning (Editable message text) Programmable warning: 133.55 Value counter 1 warning select	Warning generated by value counter 1.	Check the source of the warning (parameter 133.53 Value counter 1 source).
AE4A	Value counter 2 warning (Editable message text) Programmable warning: 133.65 Value counter 2 warning selection	Warning generated by value counter 2.	Check the source of the warning (parameter 133.63 Value counter 2 source).
AE4B	Device clean warning	Warning generated by an on-time timer. Programmable warnings: 133.14 On-time 1 warning select 133.24 On-time 2 warning select	Check the event log for an auxiliary code. Check the source of the warning corresponding to the code: 0: 133.13 On-time 1 source 1: 133.23 On-time 2 source 10: 105.04 Fan on-time counter .
AE4C	DC capacitor warning		
AE4D	Cabinet fan warning		
AE4E	Cooling fan warning		
AE4F	Additional cooling fan warning		
AE51	External warning 1 Programmable warning: 131.01 External event 1 source 131.02 External event 1 type	Warning generated by external device 1. (This information is configured through one of programmable digital inputs.)	Check external devices. Check the setting of parameter 131.01 External event 1 source .

Code (hex)	Warning	Cause	What to do
AE52	External warning 2 Programmable fault: 131.03 External event 2 source 131.04 External event 2 type	Warning generated by external device 2. (This information is configured through one of programmable digital inputs.)	Check external devices. Check the setting of parameter 131.03 External event 2 source .
AE53	External warning 3 Programmable fault: 131.05 External event 3 source 131.06 External event 3 type	Warning generated by external device 3. (This information is configured through one of programmable digital inputs.)	Check external devices. Check the setting of parameter 131.05 External event 3 source .
AE54	External warning 4 Programmable fault: 131.07 External event 4 source 131.08 External event 4 type	Warning generated by external device 4. (This information is configured through one of programmable digital inputs.)	Check external devices. Check the setting of parameter 131.07 External event 4 source .
AE55	External warning 5 Programmable fault: 131.09 External event 5 source 131.10 External event 5 type	Warning generated by external device 5. (This information is configured through one of programmable digital inputs.)	Check external devices. Check the setting of parameter 131.09 External event 5 source .
AE56	INU-LSU comm loss	DDCS (fiber optic) communication between converters (for example, the inverter unit and the supply unit) is lost.	Check settings of parameter group 160 DDCS communication . Check the corresponding settings in the control program of the other converter. Check the cable connections. If necessary, replace the cables.
AE57	Autoreset	A fault is about to be autoreset.	Informative warning. See the settings in parameter group 131 Fault functions .
AE58	Emergency stop (off2)	IGBT supply unit has received an emergency stop (mode selection off2) command.	Check that it is safe to continue operation. Return emergency stop push button to normal position.
AE59	Emergency stop (off1 or off3)	IGBT supply unit has received an emergency stop (mode selection off1 or off3) command.	Restart the IGBT supply unit.
AE5A	Enable start signal missing (Editable message text)	No enable start signal received.	Check the setting of (and the source selected by) parameter 120.19 Enable start command .
AE5B	Run enable missing	No run enable signal is received.	Check setting of parameter 120.12 Run enable 1 source . Switch signal on (e.g. in the fieldbus Control Word) or check wiring of selected source.
AE5C	External power signal missing	External power feedback signal is missing. The feedback differs from the parameter setting.	Check parameter 195.04 Control board supply .
AE5F	Temperature Warning	Supply module temperature is excessive due to eg, module overload or fan failure.	Check module cooling air flow and fan operation. Check ambient temperature. If it exceeds 40 °C (104 °F), ensure that load current does not exceed derated load capacity. See appropriate hardware manual. Check inside of cabinet and heatsink of supply module for dust pick-up. Clean whenever necessary.

Code (hex)	Warning	Cause	What to do
AE60	Control board temperature	Control board temperature is excessive.	Check the auxiliary code. See actions for each code below.
	(none)	Temperature above the warning limit.	Check the ambient conditions. Check air flow and fan operation. Check heatsink fins for dust pick-up.
	1	Thermistor broken.	Contact an ABB service representative for control unit replacement.
AE67	AI supervision	An analog signal is outside the limits specified for the analog input.	Check the event log for an auxiliary code (format XYY). "X" specifies the location of the input (0 : AI on control unit; 1 : I/O extension module 1, etc.), "YY" specifies the input and limit (01 : AI1 under minimum, 02 : AI1 over maximum, 03 : AI2 under minimum, 04 : AI2 over maximum). Check signal level at the analog input. Check the wiring connected to the input. Check the minimum and maximum limits of the input in parameter group 112 Standard AI .
AE68	Emergency stop warning	Emergency stop warning is activated.	Check that it is safe to continue operation.
AE6D	DDCS controller comm loss Programmable warning: 160.59 DDCS controller comm loss function	DDCS (fiber optic) communication between the supply unit and external controller is lost.	Check status of controller. See the user documentation of the controller. Check settings of parameter group 160 DDCS communication . Check cable connections. If necessary, replace cables.
AE6E	Internal SW error	Internal SW error	Contact your local ABB representative. Quote the auxiliary code (check the event details in the event log).
AE6F	Ambient temperature	Redundant measurement supervision has indicated a difference in the duplicated measurements that is outside the limits.	Contact your local ABB representative.
AE73	Fan	Cooling fan is stuck or disconnected.	Check the auxiliary code to identify the fan. Code 0 denotes main fan 1. Other codes (format XYZ): "X" specifies state code (1 : ID run, 2 : normal). "Y" specifies the index of the converter module connected to BCU (0...n , always 0 for ZCU control units). "Z" specifies the index of the fan (1 : Main fan 1, 2 : Main fan 2, 3 : Main fan 3, 4 : Auxiliary fan 1, 5 : Auxiliary fan 2, 6 : Auxiliary fan 3, 7 : Filter fan 1, 8 : Filter fan 2, 9 : Filter fan 3). Note that modules are coded starting from 0. For example, the code 101 means that Main fan 1 of module 1 (connected to BCU channel V1T/V1R) has faulted during its ID run. Check fan operation and connection. Replace fan if faulty.

Code (hex)	Warning	Cause	What to do
AE75	SD card	Error related to SD card used to store data (BCU control unit only).	Check the auxiliary code. See actions for each code below.
		1 No SD card	Insert a compatible, writable SD card into the SD CARD slot of the BCU control unit.
		2 SD card write-protected	
		3 SD card unreadable	
AE76	PCB space cooling	Temperature difference between ambient and drive module PCB space temperature difference has exceeded warning limit.	Check cooling fan inside the PCB space. With parallel-connected modules, check the auxiliary code (format XXXY YYZZ). "Y YY" specifies through which BCU control unit channel the fault was received.
AE78	Net lost	Net lost is detected.	Check AC grid supply and investigate reason for momentary net lost.
AE79	Power fail saving	Power fail saving is requested too frequently. Due to the limited saving interval some of the requests do not trigger the saving and power fail data may be lost. This may be caused by DC voltage oscillation.	Check the supply voltage.
AE80	Auxiliary fan missing	Auxiliary fan is not connected or it is broken.	Check the auxiliary fan connection or replace the fan.
AE81	MF comm loss Programmable warning: 160.09 M/F comm loss function	Master/follower communication is lost.	Check the auxiliary code. The code indicates which node address (defined by parameter 160.02 in each supply unit) on the master/follower link is affected. Check settings of parameter group 160 DDCS communication . On the FDCO module (if present), check that the DDCS link switch is not set to 0 (OFF). Check the cable connections. If necessary, replace the cables.
AE82	Follower Programmable warning: 160.17 Follower fault action	A follower drive has tripped.	Check the auxiliary code. Add 2 to the code to find out the node address of the faulted unit. Correct the fault in the follower drive.
AE84	Fan service counter	A cooling fan has reached the end of its estimated lifetime.	See parameters 105.41 and 105.42 . Check the auxiliary code. The code indicates which fan is to be replaced. 0: Main cooling fan 1: Auxiliary cooling fan 2: Auxiliary cooling fan 2 3: Cabinet cooling fan 4: PCB compartment fan Refer to the hardware manual of the drive for fan replacement instructions.
AE85	Charging count	There are too many DC link charging attempts.	Two attempts in five minutes is allowed to prevent charging circuit overheating.

Code (hex)	Warning	Cause	What to do
AE87	Ext earth leakage	External earth fault triggered by input selected with parameter 131.28 Ext earth leakage signal source .	Check external earth fault source. Usually only one device is allowed in the same network. Check AC fuses. Check for earth leakages. Check supply cabling. Check power modules. Check there are no power factor correction capacitors or surge absorbers in supply cable. If no earth fault can be detected, contact your local ABB representative.
AE88	Parameter map configuration	Too much data in parameter mapping table created in Drive customizer.	See <i>Drive customizer PC tool user's manual</i> (3AUA0000104167 [English]).
AE8A	User lock is open	The user lock is open, ie. user lock configuration parameters 196.100...196.102 are visible.	Close the user lock by entering an invalid pass code in parameter 196.02 Pass code . See section User lock (page 42).
AE8B	User pass code not confirmed	A new user pass code has been entered in parameter 196.100 but not confirmed in 196.101 .	Confirm the new pass code by entering the same code in 196.101 . To cancel, close the user lock without confirming the new code. See section User lock (page 42).
AE8C	Control unit battery	The battery of the control unit is low.	Replace control unit battery. This warning can be suppressed by using parameter 131.40 .
AEA0	Phase order	Supply unit has detected that phase order differs from expected (BCU control unit only).	Make sure that all direct-on-line fans in filters and power units are rotating in correct direction. This warning can be suppressed by using parameter 131.40 .
BE02	MCB maintenance notice	Main circuit breaker has worked 70000 times and it should be maintained according to the maintenance plan.	Maintain the main circuit breaker.
BE03	External pure event 1	Pure event generated by external device 1. (This information is configured through one of programmable digital inputs.)	Check external devices. Check setting of parameter 131.01 External event 1 source .
BE04	External pure event 2	Pure event generated by external device 2. (This information is configured through one of programmable digital inputs.)	Check external devices. Check setting of parameter 131.03 External event 2 source .
BE05	External pure event 3	Pure event generated by external device 3. (This information is configured through one of programmable digital inputs.)	Check external devices. Check setting of parameter 131.05 External event 3 source .
BE06	External pure event 4	Pure event generated by external device 4. (This information is configured through one of programmable digital inputs.)	Check external devices. Check setting of parameter 131.07 External event 4 source .

Code (hex)	Warning	Cause	What to do
BE07	External pure event 5	Pure event generated by external device 5. (This information is configured through one of programmable digital inputs.)	Check external devices. Check setting of parameter 131.09 External event 5 source .
BE08	Power up Programmable event: 196.39 Power up event logging	The IGBT supply unit has been powered up.	Informative event.
BE09	SW internal diagnostics	Control unit rebooted unexpectedly.	Informative event.
5E1C	BAMU meas settings	Error in settings (parameters 191.40...191.43) of BAMU measurement unit.	Check the settings of parameters 191.40...191.43 . Check the auxiliary code for details 1: Voltage U1 measurement location is not set (check parameter 191.42), 2: Either voltage U2 measurement location is not set or voltage U1 measurement location is after U2 (check parameters 191.42 and 191.43), 3: Transformer and circuit breaker are either not set or at the same location (check parameters 191.40 and 191.41), 4: Voltage U1 measurement location 1 or selection <i>Other</i> is not allowed in this configuration (check parameter 191.42), 5: Circuit breaker location B is not allowed in this configuration (check parameter 191.41), 6: Voltage U1 measurement is disabled (check parameter 191.01)).

Fault messages

Code (hex)	Fault	Cause	What to do
2E00	Overcurrent	Output current has exceeded internal fault limit.	<p>Check supply voltage.</p> <p>Check that there are no power factor correction capacitors or surge absorbers in supply cable.</p> <p>Check motor load and acceleration times.</p> <p>Check power semiconductors (IGBTs) and current transducers.</p> <p>Check the auxiliary code (format XXXY YYZZ). With parallel-connected modules, "Y YY" specifies through which BCU control unit channel the fault was received. "ZZ" indicates the phase that triggered the fault (0: No detailed information available, 1: U-phase, 2: V-phase, 4: W-phase, 3/5/6/7: multiple phases).</p>
2E01	Earth leakage Programmable fault: <i>131.20 Earth fault</i>	IGBT supply unit has detected an earth fault.	<p>Check AC fuses.</p> <p>Check for earth leakages.</p> <p>Check supply cabling.</p> <p>Check power modules.</p> <p>Check there are no power factor correction capacitors or surge absorbers in supply cable.</p> <p>If no earth fault can be detected, contact your local ABB representative.</p>
2E02	Short circuit	IGBT supply unit has detected short circuit.	<p>Check supply cable.</p> <p>Check there are no power factor correction capacitors or surge absorbers in supply cable.</p> <p>Check the auxiliary code (format XXXY YYZZ). With parallel-connected modules, "Y YY" specifies through which BCU control unit channel the fault was received. "ZZ" indicates the location of the short circuit (0: No detailed information available, 1: Upper branch of U-phase, 2: Lower branch of U-phase, 4: Upper branch of V-phase, 8: Lower branch of V-phase, 10: Upper branch of W-phase, 20: Lower branch of W-phase, other: combinations of the above).</p> <p>After correcting the cause of the fault, reboot the control unit (using parameter <i>196.08 Control board boot</i>) or by cycling power.</p>
2E04	IGBT overload	Excessive IGBT junction to case temperature.	Check the load.

Code (hex)	Fault	Cause	What to do
2E05	BU current difference	Current difference detected by the branching unit (BU).	<p>Check converter fuses.</p> <p>Check converter(s).</p> <p>Check inverter(s).</p> <p>Check LCL filter.</p> <p>Power off all boards.</p> <p>If the fault persists, contact your local ABB representative.</p> <p>Check the auxiliary code (format XXXY YYZZ). "XXX" specifies the source of the first error (see "YYY"). "YYY" specifies the module through which BCU control unit channel the fault was received (1: Channel 1, 2: Channel 2, 4: Channel 3, 8: Channel 4, ..., 800: Channel 12).</p>
2E06	BU earth leakage	Earth leakage detected by the branching unit: sum of all currents exceeds the level.	<p>Check AC fuses.</p> <p>Check for earth leakages.</p> <p>Check supply cabling.</p> <p>Check power modules.</p> <p>Check there are no power factor correction capacitors or surge absorbers in supply cable.</p> <p>If no earth fault can be detected, contact your local ABB representative.</p>
2E08	External earth fault	External earth fault triggered by input selected with parameter 131.28 Ext earth leakage signal source .	<p>Check external earth fault source.</p> <p>Usually only one device is allowed in the same network.</p>
2E09	DC short circuit	<p>After closing the charging contactor, the voltage did not rise above 10% from nominal voltage in 0.2 seconds (can be set in service level), but the current rose above level set by parameter 120.22 Max current for MCB closing.</p> <p>There is a short-circuit in DC busbar.</p>	Check DC busbar.
3E00	Input phase loss	Input phase loss detected by the IGBT bridge.	<p>Check the AC fuses.</p> <p>Check for input power supply imbalance.</p>
3E02	Charge relay lost	No acknowledgement received from charge relay.	Contact your local ABB representative.
3E04	DC link overvoltage	Excessive intermediate circuit DC voltage.	<p>Check that parameter 195.01 Supply voltage is set according to the supply voltage in use.</p> <p>With parallel-connected modules, check the auxiliary code (format XXXY YYZZ). "Y YY" specifies through which BCU control unit channel the fault was received.</p>
3E05	DC link undervoltage	Intermediate circuit DC voltage is not sufficient because of a missing supply phase or blown fuse.	Check supply cabling, fuses and switchgear.

Code (hex)	Fault	Cause	What to do
3E06	BU DC link difference	Difference in DC voltages between parallel-connected supply modules.	Check the DC fuses. Check the connection to the DC bus. If the problem persists, contact your local ABB representative. Check the auxiliary code (format XXXY YYZZ). "XXX" specifies the source of the first error (see "YYY"). "YYY" specifies the module through which BCU control unit channel the fault was received (1: Channel 1, 2: Channel 2, 4: Channel 3, 8: Channel 4, ..., 800: Channel 12).
3E07	BU voltage difference	Difference in main voltages between parallel-connected supply modules.	Check the supply network connections. Check the AC fuses. If the problem persists, contact your local ABB representative.
3E08	LSU charging	DC link voltage is not high enough after charging.	Check mains supply and fuses. Check the event log for an auxiliary code. The auxiliary code identifies the event (see below). Check external charging tuning parameters 120.22...120.30 . Check the connection from the relay output to the charging contactor. Check that the DC voltage measuring circuit is working correctly.
		1 Voltage rise is not acceptable.	Check parameter 120.26 Maximum dU/dt .
		2 DC voltage level is not acceptable.	Check supply connection. Check parameter 195.01 Supply voltage and parameter 120.25 MCB closing level .
		3 Charging current is too high.	Check parameter 120.22 Max current for MCB closing .
		4 Charging time is too high.	Check supply connections, voltage of power supply network and PSL2 link cable.
		5 After closing the charging contactor, the voltage did not rise above 10% from nominal voltage in 0.2 seconds (can be set in service level), and current was below the level set by parameter 120.22 Max current for MCB closing .	Check the supply connection, and power unit must be externally powered to measure voltage.
		8 Parameter 120.28 MCB relay timing is set too high. The DC voltage drops too low.	Check parameter 120.28 MCB relay timing .
3E09	Charging count	There are too many DC link charging attempts.	Two attempts in five minutes is allowed to prevent charging circuit overheating.
3E0A	LSU charging busbar fault	The DC voltage rise in 10 ms is not acceptable during charging. The level is below the value set in parameter 120.26 Maximum dU/dt , but DC voltage has not reached the level set in parameter 120.25 MCB closing level .	Check the connections of the DC capacitors in the power modules and parameters 120.25 MCB closing level and 120.26 Maximum dU/dt . Check that the input voltage is stable during start.

242 *Fault tracing*

Code (hex)	Fault	Cause	What to do
4E01	Cooling	Power module temperature is excessive.	Check ambient temperature. If it exceeds 40 °C (104 °F), ensure that load current does not exceed derated load capacity. See appropriate hardware manual. Check power module cooling air flow and fan operation. Check inside of cabinet and heatsink of power module for dust pick-up. Clean whenever necessary.
4E02	IGBT temperature	IGBT temperature is excessive.	Check ambient conditions. Check air flow and fan operation. Check heatsink fins for dust pick-up. Check motor power against IGBT supply unit power.
4E03	Excess temperature	Power unit module temperature is excessive.	See AE19 Measurement circuit temperature (page 231).
4E04	Excess temperature difference	High temperature difference between the IGBTs of different phases. The amount of available temperatures depends on the frame size.	See AE15 Excess temperature difference (page 230).
4E06	Cabinet or LCL overtemperature	Overtemperature detected either in cabinet, LCL filter or auxiliary transformer. A measurement device connected to supply unit digital input or DI1 has tripped to a fault. Input is selected with parameter 131.33 Cabinet temperature fault source .	Check parameter 131.34 Cabinet temperature supervision . Check the temperature source of the cabinet, LCL filter and auxiliary transformer.
4E07	Control board temperature	Control board temperature is excessive.	Check proper cooling of the cabinet.
4E09	Ambient temperature	Redundant measurement supervision has indicated a difference in the duplicated measurements that is outside the limits.	Contact your local ABB representative.
4E0A	PCB space cooling	Temperature difference between ambient and drive module PCB space has exceeded the fault limit.	Check the cooling fan inside the PCB space.
5E00	Fan	Cooling fan stuck or disconnected.	See AE73 Fan (page 235).
5E01	Auxiliary fan broken	Broken fan detected.	Replace the fan.
		1 Auxiliary fan 1 broken	Replace the fan 1.
		2 Auxiliary fan 2 broken	Replace the fan 2.
5E03	XSTO circuit open	Circuit connected to XSTO:IN1 and/or XSTO:IN2 is open.	Check XSTO circuit connections. See sections Default I/O connection diagram (BCU) on page 46, and Default I/O connection diagram (ZCU) on page 48. For more information, see appropriate hardware manual.

Code (hex)	Fault	Cause	What to do
5E04	PU logic error	Power unit memory has cleared.	Cycle the power to the supply unit. If the control unit is externally powered, also reboot the control unit (using parameter 196.08 Control board boot) or by cycling its power. If the problem persists, contact your local ABB representative.
5E05	Rating ID mismatch	The hardware of the supply unit does not match the information stored in the memory unit. This may occur eg. after a firmware update or memory unit replacement.	<p>Cycle the power to the supply unit. If the control unit is externally powered, reboot the control unit (using parameter 196.08 Control board boot) or by cycling its power.</p> <p>Check the auxiliary code. The auxiliary codes are as follows:</p> <p>1 = Ratings of the power unit and ZCU/BCU control unit are not the same. Rating ID has changed.</p> <p>2 = Parallel connection rating ID has changed.</p> <p>3 = Power unit types are not the same in all power units.</p> <p>4 = Parallel connection rating ID is active in a single power unit setup.</p> <p>5 = It is not possible to implement the selected rating with the current power units.</p> <p>6 = Power unit rating ID is 0.</p> <p>7 = Reading power unit rating ID or power unit type failed on connection.</p> <p>With parallel connection faults, the format of the auxiliary code is 0X0Y. "Y" indicates the auxiliary code, "X" indicates the first faulty power unit channel in hexadecimal (1...A).</p> <p>If the problem persists, contact your local ABB representative.</p>
5E06	Main contactor Fault	<p>Control program does not receive main contactor on (1) acknowledgement through digital input even control program has closed the contactor control circuit with relay output.</p> <p>Main contactor / main breaker is not functioning properly, or there is a loose / bad connection.</p>	<p>Check main contactor / main breaker control circuit wiring.</p> <p>Check the status of other switches connected to contactor control circuit. See the delivery-specific circuit diagrams.</p> <p>Check main contactor operating voltage level (should be 230 V).</p> <p>Check digital input DI3 connections.</p>

Code (hex)	Fault	Cause	What to do
5E07	PU communication	The way the control unit is powered does not correspond to parameter setting.	Check setting of 195.04 Control board supply .
		Communication errors detected between the control unit and the power unit.	Check the connection between the control unit and the power unit. Check the auxiliary code (format XXXY YYZZ). With parallel-connected modules, "Y YY" specifies the affected BCU control unit channel (0: broadcast). "ZZ" specifies the error source (1: Transmitter side [link error], 2: Transmitter side [no communication], 3: Receiver side [link error], 4: Receiver side [no communication], 5: Transmitter FIFO error [see "XXX"], 6: Module [x]INT board not found, 7: BAMU board not found). "XXX" specifies the transmitter FIFO error code (1: Internal error [invalid call parameter], 2: Internal error [configuration not supported], 3: Transmission buffer full).
5E08	Power unit lost	Connection between the control unit and the power unit is lost.	Check the connection between the control unit and the power unit.
5E09	PU communication internal	Internal communication error.	Contact your local ABB representative.
5E0A	Measurement circuit ADC	Measurement circuit analog-to-digital converter fault.	Contact your local ABB representative, quoting the auxiliary code.
5E0B	PU board powerfail	Power unit power supply failure.	Check the auxiliary code (format ZZZY YYXX). "YY Y" specifies the affected module (0...C, always 0 for ZCU control units). "XX" specifies the affected power supply (1: Power supply 1, 2: Power supply 2).
5E0D	PU communication configuration	Version check cannot find a matching power unit FPGA logic, or number of connected power modules differs from specified.	Check the auxiliary code (format ZZZY YYXX). "XX" specifies the configuration error cause (1: Found BAMU 1 configured in wrong channel, 2: Found BAMU 2 configured in wrong channel, 3: Found PUs configured in wrong channels, 4: Found PU configured in wrong channel, 5: Found too many PUs). Check settings of parameters 195.31 Parallel connection rating id and 191.30 BAMU 1 channel . Cycle the power to the drive. If the control unit is externally powered, also reboot the control unit (using parameter 196.08 Control board boot) or by cycling its power. If the number of connected power modules is correct, update the FPGA logic of the power unit. If the problem persists, contact your local ABB representative.

Code (hex)	Fault	Cause	What to do
5E0E	Reduced run	Number of supply modules detected does not match the value of parameter 195.13 Reduced run mode , or the value of parameter 195.13 Reduced run mode indicates a configuration that is not possible (Examples: 5×R8i, that is not available, or the number of remaining modules is 1 in 195.13 in case the original number of modules is 3 (ie. two modules out of three are removed, which is not allowed)). See section Reduced run function (page 34).	Check that the value of 195.13 Reduced run mode corresponds to the number of supply modules present. Check that the modules present are powered from the DC bus and connected by fiber optic cables to the BCU control unit. If all modules of the supply unit are in fact available (eg. maintenance work has been completed), check that parameter 195.13 is set to 0 (reduced run function disabled).
5E0F	PU state feedback	State feedback from output phases does not match control signals.	Contact your local ABB representative.
5E10	Charging feedback	Charging feedback signal missing.	Check the feedback signal coming from the charging system.
		Incorrect parameter setting	Check the setting of parameter 195.09 Switch fuse controller . Enable the parameter only if an xSFC charging controller is installed.
		The charging switch and DC switch were operated out of sequence, or a start command was issued before the unit was ready.	The normal power-up sequence is: 1. Close charging switch. 2. After charging finishes (charging OK lamp lights), close DC switch. 3. Open charging switch.
5E11	Unknown PU fault	Unidentified power unit logic fault.	Check the logic and firmware compatibility. Contact your local ABB representative.
5E12	BAMU configuration	Error in configuration of BAMU unit.	Check the parameter settings of parameter group 191 BAMU configuration . Check the auxiliary code. Lower 16 bits show the fault details on BAMU unit settings and upper 16 bits show the configuration details (format 0xWXYZ). "W" indicates the BAMU unit in question (1: BAMU1, 2: BAMU2). "X" specifies the type of BAMU unit (2: BAMU-12). "Y" specifies the BAMU channel (1...12). "Z" indicates the error type (1: False measurement range, 2: False filtering configuration, 3: Unsupported BAMU type, 4: Module not found, 5: Setting of parameter 191.42 U1 meas location when the optimal grid control functionality is enabled). Auxiliary code 0x0000: Wrong channel configuration.
5E13	Auxiliary Circuit breaker	Circuit breaker fault triggered by input selected with parameter 131.32 Aux circuit breaker fault source	By default, the feedback is connected to DI4.

Code (hex)	Fault	Cause	What to do
5E18	Charge contactor	Supply voltage is removed while the drive is running.	Reconnect the supply voltage.
5E14	Measurement circuit temperature	Problem with internal temperature measurement of the drive.	See AE19 Measurement circuit temperature (page 231).
6E00	FPGA version incompatible	Firmware and FPGA versions are incompatible.	Update power unit FPGA logic or firmware (whichever is older). Reboot the control unit (using parameter 196.08 Control board boot) or by cycling power. If the problem persists, contact your local ABB representative.
6E01	FBA A mapping file	Fieldbus adapter A mapping file read error.	Contact your local ABB representative.
6E02	FBA B mapping file	Fieldbus adapter B mapping file read error.	Contact your local ABB representative.
6E03	Task overload	Internal fault.	Reboot the control unit (using parameter 196.08 Control board boot) or by cycling power. If the problem persists, contact your local ABB representative.
6E04	Stack overflow	Internal fault.	Reboot the control unit (using parameter 196.08 Control board boot) or by cycling power. If the problem persists, contact your local ABB representative.
6E05	Internal file load	File read error.	Reboot the control unit (using parameter 196.08 Control board boot) or by cycling power. If the problem persists, contact your local ABB representative.
6E06	Internal record load	Internal record load error.	Contact your local ABB representative.
6E07	Application loading	Application file incompatible or corrupted.	Check the auxiliary code. See actions for each code below.
	8006	Not enough memory for the application.	Reduce the size of the application. Reduce the number of parameter mappings. See the drive-specific log generated by Automation Builder.
	8007	The application contains the wrong library version.	Update the system library or reinstall Automation Builder. See the drive-specific log generated by Automation Builder.
	800A	The application contains an unknown target (system) library function.	Update the system library or reinstall Automation Builder. See the drive-specific log generated by Automation Builder.
6E08	Memory Unit Detached	The memory unit was detached when the control unit was powered.	Switch off the power to the control unit and reinstall the memory unit. In case the memory unit was not actually removed when the fault occurred, check that the memory unit is properly inserted into its connector and its mounting screw is tight. Reboot the control unit (using parameter 196.08 Control board boot) or by cycling power. If the problem persists, contact your local ABB representative.

Code (hex)	Fault	Cause	What to do
6E09	Internal SSW fault	Internal fault.	Reboot the control unit (using parameter 196.08 Control board boot) or by cycling power. If the problem persists, contact your local ABB representative.
6E0A	User Set Fault	Loading of user parameter set failed because <ul style="list-style-type: none"> • requested set does not exist • set is not compatible with control program • IGBT supply unit was switched off during loading. 	Ensure that a valid user parameter set exists. Reload if uncertain.
6E0B	Kernel overload	Operating system error.	Reboot the control unit (using parameter 196.08 Control board boot) or by cycling power. If the problem persists, contact your local ABB representative.
6E0C	Parameter system	Parameter load or save failed.	Try forcing a save using parameter 196.07 Parameter save manually . Retry.
6E0D	FBA A parameter conflict	The supply unit does not have a functionality requested by PLC, or requested functionality has not been activated.	Check PLC programming. Check settings of parameter groups 150 FBA and 151 FBA A settings .
6E0E	FBA B parameter conflict	The supply unit does not have a functionality requested by PLC, or requested functionality has not been activated.	Check PLC programming. Check settings of parameter groups 150 FBA and 154 FBA B settings .
6E0F	EFB comm loss	The embedded fieldbus (EFB) interface has detected a communication loss.	Contact your local ABB representative.
6E10	EFB config file	Embedded fieldbus protocol is unable to access its config file.	Contact your local ABB representative.
6E11	EFB invalid parameterization	Invalid embedded fieldbus configuration.	Contact your local ABB representative.
6E12	EFB load fault	Unable to load protocol firmware or version mismatch between protocol and system firmware.	Contact your local ABB representative.
6E15	Text data overflow	Internal fault.	Reset the fault. Contact your local ABB representative if the fault persists.
6E16	Text 32-bit table overflow	Internal fault.	Reset the fault. Contact your local ABB representative if the fault persists.
6E17	Text 64-bit table overflow	Internal fault.	Reset the fault. Contact your local ABB representative if the fault persists.
6E18	Text file overflow	Internal fault.	Reset the fault. Contact your local ABB representative if the fault persists.
6E19	Synchronization fault	Synchronization to supply network has failed.	Monitor possible network transients.
6E1A	Rating ID fault	Rating ID load error.	Contact your local ABB representative.
6E1B	Backup/Restore Timeout	A control panel or PC tool fails to communicate with the drive during backup or restoring operation.	Check the control panel or PC tool communication, and if it is still in backup/restore state.

Code (hex)	Fault	Cause	What to do
6E1C	Emergency stop fault	Drive has received an emergency stop command.	Check that it is safe to continue operation. Return the emergency stop pushbutton to normal position. Restart the drive.
6E1D	Internal SW error	Internal error.	Contact your local ABB representative. Quote the auxiliary code (check the event details in the event log).
6E1E	Unrecoverable SW error	An unrecoverable error has occurred.	Record the fault code and the auxiliary fault code and report them to your local ABB representative. Cycle power to the unit to recover.
6E1F	Licensing fault	There are two types of licenses being used in ACS880 drives: licenses that need to be found from the unit which allow the firmware to be executed, and licenses that prevent the firmware from running. The license is indicated by the value of the auxiliary code field. The license is Nxxxx, where xxxx is indicated by the 4-digit value of the auxiliary code field.	Record the auxiliary codes of all active licensing faults and contact your product vendor for further instructions. This fault requires a reboot of the control unit either by switching the power off and on, or using parameter <i>196.08 Control board boot</i> .
	8201	A restrictive license is found from the unit. The firmware on this supply unit cannot be executed because a Low harmonic license is found from the unit. This unit is meant to be used with IGBT supply control program (2Q) only.	Contact your product vendor for further instructions.
6E20	Fault reset	Fault reset has been requested and done.	Informative fault.
6E27	Adaptive program	Error running the adaptive program.	Check the auxiliary code (format XXXX YYYY). "XXXX" specifies the number of the function block (0000 = generic error). "YYYY" indicates the problem (see actions for each code below).
	000A	Program corrupted or block non-existent	Restore the template program or download the program to the supply unit.
	000C	Required block input missing	Check the inputs of the block.
	000E	Program corrupted or block non-existent	Restore the template program or download the program to the supply unit.
	0011	Program too large.	Remove blocks until the error stops.
	0012	Program is empty.	Correct the program and download it to the supply unit.
	001C	A non-existing parameter or block is used in the program.	Edit the program to correct the parameter reference, or to use an existing block.
	001D	Parameter type invalid for selected pin.	Edit the program to correct the parameter reference.
	001E	Output to parameter failed because the parameter was write-protected.	Check the parameter reference in the program. Check for other sources affecting the target parameter.

Code (hex)	Fault	Cause	What to do
	0023	Program file incompatible with current firmware version.	Adapt the program to current block library and firmware version.
	0024		
	002A	Too many blocks.	Edit the program to reduce the number of blocks.
	Other	–	Contact your local ABB representative, quoting the auxiliary code.
7E00	Option module comm loss	Communication between the supply unit and option module (FIO-xx) is lost.	Check that the option modules are properly seated in their slots. Check that the option modules or slot connectors are not damaged. Try to install the modules into different slots.
7E01	Panel loss	Control panel or PC tool selected as active control location has ceased communicating.	Check PC tool or control panel connection. Check control panel connector. Replace control panel in mounting platform.
7E0B	FBA A communication Programmable fault: <i>150.02 FBA A comm loss func</i>	Cyclical communication between the supply unit and fieldbus adapter module A or between PLC and fieldbus adapter module A is lost.	Check status of fieldbus communication. See user documentation of fieldbus interface. Check settings of parameter groups <i>150 FBA</i> , <i>151 FBA A settings</i> , <i>152 FBA A data in</i> and <i>153 FBA A data out</i> . Check cable connections. Check if communication master is able to communicate.
7E0C	FBA B communication	Cyclical communication between supply unit and fieldbus adapter module B or between PLC and fieldbus adapter module B is lost.	Check status of fieldbus communication. See user documentation of fieldbus interface. Check settings of parameter groups <i>150 FBA</i> , <i>154 FBA B settings</i> , <i>155 FBA B data in</i> and <i>156 FBA B data out</i> . Check cable connections. Check if communication master is able to communicate.
7E0D	FA2FA DDCS Com loss	DDCS communication between units is lost. Data update took longer than timeout defined with parameter <i>160.58 DDCS controller comm loss time</i> .	Check the operation of optical fibers and FDCO adapters, and that they are connected correctly. Transmit to other end receive and vice versa. Both ends should be active.
7E10	Ext I/O comm loss	The I/O extension module types specified by parameters do not match the detected configuration.	Check the event log for an auxiliary code (format XXYY YYYY). “XX” specifies the number of the I/O extension module (01: parameter group <i>114 Extension I/O module 1</i> , 02: <i>115 Extension I/O module 2</i> , 03: <i>116 Extension I/O module 3</i>). “YY YYYY” indicates the problem (see actions for each code below).

Code (hex)	Fault	Cause	What to do
	00 0001	Communication with module failed.	Check that the module is properly seated in its slot. Check that the module and the slot connector is not damaged. Try installing the module into another slot.
	00 0002	Module not found.	Check the type and location settings of the modules (parameters 114.01/114.02 , 115.01/115.02 or 116.01/116.02). Check that the module is properly seated in its slot. Check that the module and the slot connector is not damaged. Try installing the module into another slot.
	00 0003	Configuration of module failed.	
	00 0004	Configuration of module failed.	
7E11	DDCS controller comm loss Programmable fault: 160.59 DDCS controller comm loss function	DDCS (fiber optic) communication between the supply unit and external controller is lost.	Check status of controller. See the user documentation of the controller. Check settings of parameter group 160 DDCS communication . Check cable connections. If necessary, replace cables.
8E06	AI supervision	An analog signal is outside the limits specified for the analog input.	Check the event log for an auxiliary code (format XXXX XYZZ). "Y" specifies the location of the input (0 : Control unit, 1 : I/O extension module 1, 2 : I/O extension module 2, 3 : I/O extension module 3). "ZZ" specifies the limit (01 : AI1 under minimum, 02 : AI1 above maximum, 03 : AI2 under minimum, 04 : AI2 above maximum). Check signal level at the analog input. Check the wiring connected to the input. Check the minimum and maximum limits of the input in parameter group 112 Standard AI .
8E07	Net lost	Net lost is detected. Duration of net lost is too long.	Check AC grid supply and investigate reason for net lost.
9E01	External fault 1 (Editable message text) Programmable fault: 131.01 External event 1 source 131.02 External event 1 type	Fault in external device 1. (This information is configured through one of programmable digital inputs.)	Check external devices for faults. Check the setting of parameter 131.01 External event 1 source .
9E02	External fault 2 (Editable message text) Programmable fault: 131.03 External event 2 source 131.04 External event 2 type	Fault in external device 2. (This information is configured through one of programmable digital inputs.)	Check external devices for faults. Check the setting of parameter 131.03 External event 2 source .
9E03	External fault 3 (Editable message text) Programmable fault: 131.05 External event 3 source 131.06 External event 3 type	Fault in external device 3. (This information is configured through one of programmable digital inputs.)	Check external devices for faults. Check the setting of parameter 131.05 External event 3 source .

Code (hex)	Fault	Cause	What to do
9E04	External fault 4 (Editable message text) Programmable fault: 131.07 External event 4 source 131.08 External event 4 type	Fault in external device 4. (This information is configured through one of programmable digital inputs.)	Check external devices for faults. Check the setting of parameter 131.07 External event 4 source .
9E05	External fault 5 (Editable message text) Programmable fault: 131.09 External event 5 source 131.10 External event 5 type	Fault in external device 5. (This information is configured through one of programmable digital inputs.)	Check external devices for faults. Check the setting of parameter 131.09 External event 5 source .
FE06	MF communication loss Programmable fault: 160.09 M/F comm loss function	Master/follower communication is lost.	See AE81 MF comm loss (page 236).
FE07	Follower drive failure Programmable fault: 160.17 Follower fault action	A follower has tripped.	Check the auxiliary code. Add 2 to the code to find out the node address of the faulted unit. Correct the fault in the follower.
FF81	FB A force trip	A fault trip command has been received through fieldbus adapter A.	Check the fault information provided by the PLC.
FF82	FB B force trip	A fault trip command has been received through fieldbus adapter B.	Check the fault information provided by the PLC.
FF8E	EFB force trip	A fault trip command has been received through the embedded fieldbus interface.	Contact your local ABB representative.



9

Fieldbus control through the embedded fieldbus interface (EFB)

This feature is not supported by the current firmware version.

10

Fieldbus control through a fieldbus adapter

What this chapter contains

This chapter describes how the IGBT supply unit can be controlled by external devices over a communication network (fieldbus) through an optional fieldbus adapter module.

System overview

The user can control the IGBT supply unit through a fieldbus interface if the unit is equipped with an optional fieldbus adapter (for example, option +K454). Then the supply unit can be connected to an external control system through a serial communication link. The fieldbus adapter can be installed into any free option slot of the control unit.

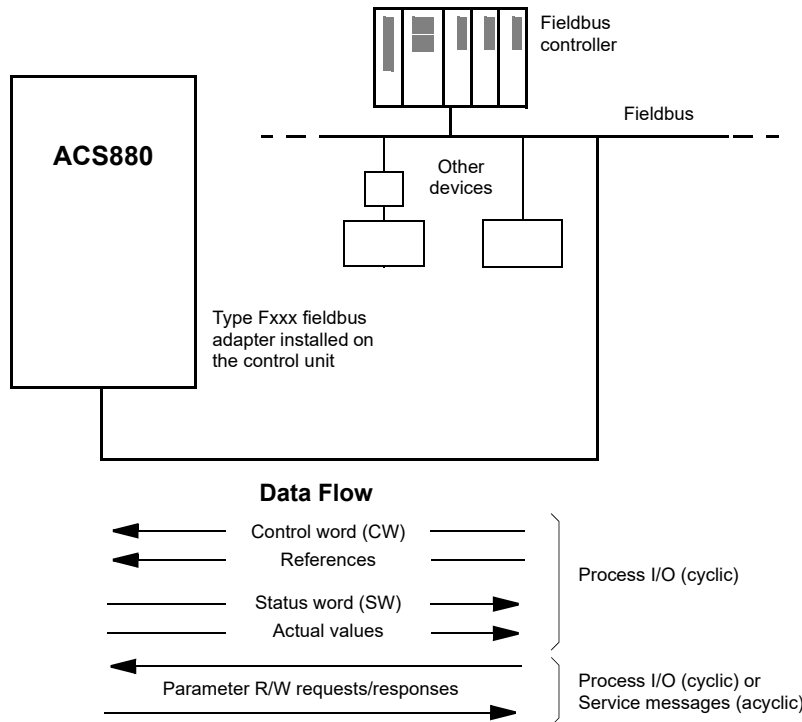

The supply unit can be set to receive all of its control information through the fieldbus interface, or the control can be distributed between the fieldbus interface and other available sources such as digital and analog inputs.

Fieldbus adapters are available for various serial communication systems and protocols, for example

- CANopen (FCAN-01 adapter)
- ControlNet (FCNA-01 adapter)
- DeviceNet (FDNA-01 adapter)
- EtherCAT (FECA-01 adapter)
- EtherNet/IP (FENA-11, FENA-21 or FEIP-21 adapter)
- Modbus/RTU (FSCA-01 adapter)
- Modbus TCP (FENA-11, FENA-21 or FMBT-21 adapter)
- POWERLINK (FEPL-02 adapter)
- PROFIBUS DP (FPBA-01 adapter)
- PROFINET IO (FENA-11, FENA-21 or FPNO-21 adapter).

Note: The text and examples in this chapter describe the configuration of one fieldbus adapter (FBA A) by parameters [150.01...150.21](#) and parameter groups 151...153. The second adapter (FBA B), if present, is configured in a similar fashion by parameters [150.31...150.51](#) and parameter groups 154...156.

Note: If FENA-xx Ethernet adapter is used for Ethernet tool network and Drive composer PC tool, use the FENA-xx adapter as fieldbus adapter B. Configure the FENA-xx adapter through parameters [150.31](#)...[150.51](#) and parameter groups 154...156. Normally, use the fieldbus adapter module as fieldbus adapter A. See *Ethernet tool network for ACS880 drives application guide* (3AUA0000125635 [English]), and *FENA-01/-11 Ethernet adapter module user's manual* (3AUA0000093568 [English]).

Basics of the fieldbus control interface

The cyclic communication between a fieldbus system and the IGBT supply unit consists of 16/32-bit input and output data words. The supply unit supports at the maximum the use of 12 data words (16 bits) in each direction.

Data transmitted from the IGBT supply unit to the fieldbus controller is defined by parameters [152.01 FBA A data in1](#) ... [152.12 FBA A data in12](#). The data transmitted from the fieldbus controller to the IGBT supply unit is defined by parameters [153.01 FBA data out1](#) ... [153.12 FBA data out12](#).

■ Control word and Status word

The Control word is the principal means for controlling the IGBT supply unit from a fieldbus system. It is sent by the fieldbus master station to the IGBT supply unit through the adapter module. The IGBT supply unit switches between its states according to the bit-coded instructions on the Control word, and returns status information to the master in the Status word.

The contents of the Control word and the Status word are detailed on pages [260](#) and [261](#) respectively.

If parameter [150.12 FBA A debug mode](#) is set to *Fast*, the Control word received from the fieldbus is shown by parameter [150.13 FBA A control word](#), and the Status word transmitted to the fieldbus network by [150.16 FBA A status word](#).

■ References

References are 16-bit words containing a sign bit and a 15-bit integer. A negative reference is formed by calculating the two's complement from the corresponding positive reference.

ABB drives can receive control information from multiple sources including analogue and digital inputs, the control panel and a fieldbus adapter module. In order to have the IGBT supply unit controlled through the fieldbus, the module must be defined as the source for control information, e.g. Reference.

If parameter [150.12 FBA A debug mode](#) is set to *Fast*, the references received from the fieldbus are displayed by [150.14 FBA A reference 1](#) and [150.15 FBA A reference 2](#).

Scaling of references

Note: The scalings described below are for the Transparent 16 profile. Fieldbus-specific communication profiles may use different scalings. For more information, see the manual of the fieldbus adapter.

The references are scaled as defined by parameters [146.01](#)...[146.04](#).

Example: PLC reference is 600. Parameter [152.02 FBA A data in1](#) is set to *Ref1 16bit*. Reference Ref1/Act1 is scaled first by parameter [151.06 T16 scale](#) since the supply units are identified automatically as Transparent 16 profile. After that the value is scaled in

parameter group *146 Monitoring settings*, for example using parameter *146.01 Power scaling*.

Example for PROFIBUS:

146.04 DC voltage scaling is set to 1000,

151.06 T16 scale is set to 99, which equals to coefficient 100. 0 equals to coefficient 1.

PLC reference is 105.

Scaled value is calculated as follows:

$105 \text{ [PLC reference]} \times 100 \text{ [T16 scale]} \times (1000 \text{ [par. 146.04]} / 10000) = 1050 \text{ V.}$

Since the value is in 16-bit format and if the reference is 900, parameter *151.06 T16 scale* causes the value to be 90000. This causes overflow. Then parameter *151.06 T16 scale* needs to be changed first to zero, before reference 900 is possible.

Parameter *151.06 T16 scale* is in use only in some of the fieldbus adapters and only for Ref1/Act1. For more information, see the manual of the fieldbus adapter.

■ **Actual values**

Actual values are 16-bit words containing information on the operation of the IGBT supply unit. The types of the monitored signals are selected by parameters *150.07 FBA A actual1 type* and *150.08 FBA A actual2 type*.

If parameter *150.12 FBA A debug mode* is set to *Fast*, the actual values sent to the fieldbus are displayed by *150.17 FBA A actual value 1* and *150.18 FBA A actual value 2*.

■ Fieldbus scaling diagram

The diagram below shows the fieldbus scaling principle.

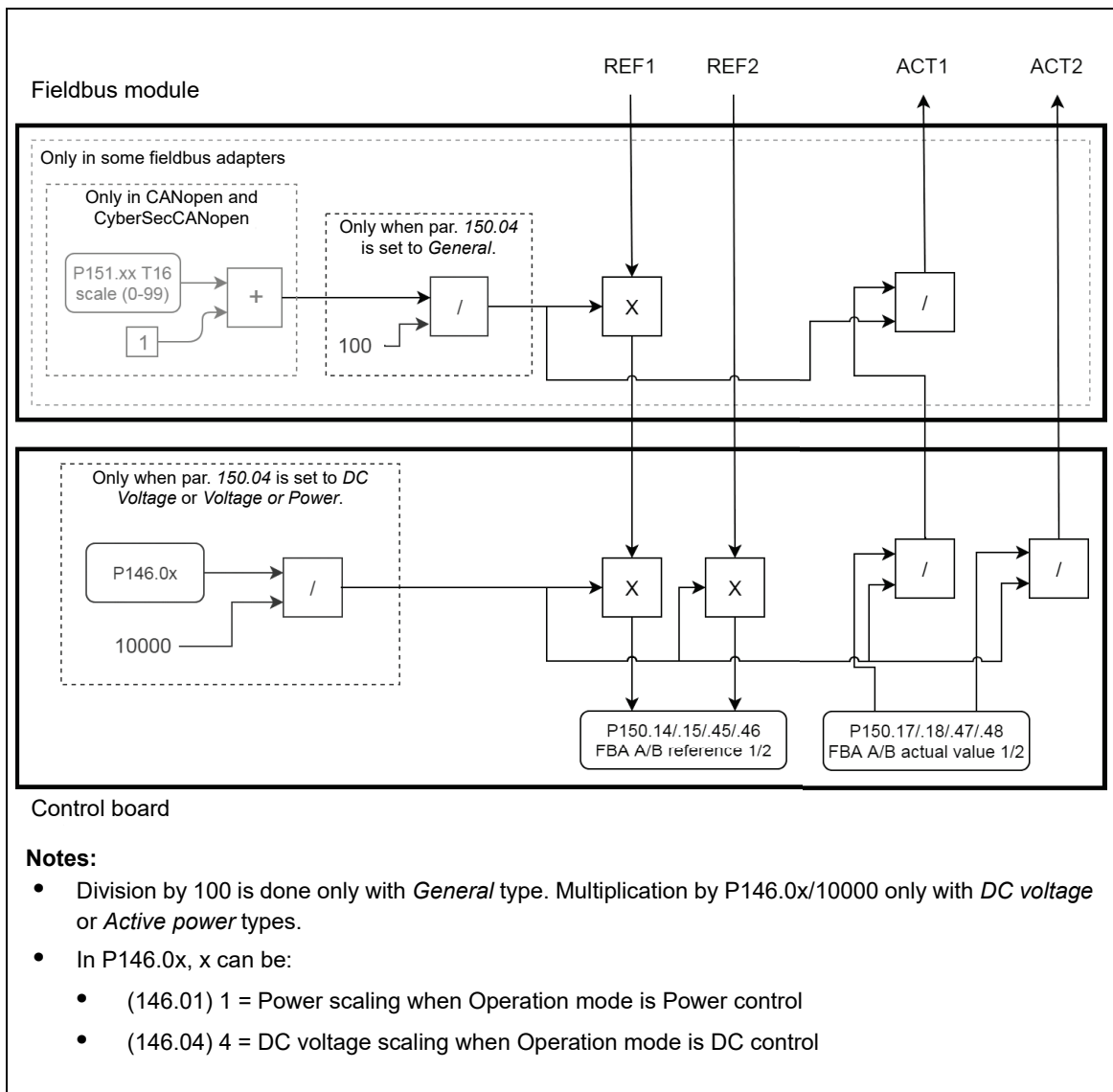

■ Contents of the fieldbus Control word

Bit	Name	Value	Description
0	On/Off	1	Start charging. Note: This bit affects only in external charge mode, ie. when the parameter <i>120.30 External charge enable</i> is set to <i>Yes</i> . In internal charge mode charging is handled automatically.
		0	Open main contactor (switch power off).
1	Off 2	1	Emergency stop bit 2
		0	Open main contactor
2	Off 3	1	Emergency stop bit 3
		0	Open main contactor
3	Start	1	Start modulating.
		0	Stop modulating.
4	-	1	Not in use
		0	Not in use
5	-	1	Not in use
		0	Not in use
6	-	1	Not in use
		0	Not in use
7	Reset	1	Fault reset (0 -> 1) if an active fault exists. Enter switch-on inhibited.
		0	Continue normal operation.
8	-	1	Not in use
		0	Not in use
9	-	1	Not in use
		0	Not in use
10	Remote cmd	1	Control location: REMOTE (EXT1 or EXT2).
		0	Control location: LOCAL.
11	Ext ctrl loc	1	Select External Control Location EXT2. Effective if control location is parameterized to be selected from fieldbus.
		0	Select External Control Location EXT1. Effective if control location is parameterized to be selected from fieldbus.
12	User bit 0	1	User bit 0 from external control location.
		0	User bit 0 from external control location.
13	User bit 1	1	User bit 1 from external control location.
		0	User bit 1 from external control location.
14	User bit 2	1	User bit 2 from external control location.
		0	User bit 2 from external control location.
15	User bit 3	1	User bit 3 from external control location.
		0	User bit 3 from external control location.

■ Contents of the fieldbus Status word

Bit	Name	Value	Description
0	Ready to switch ON	1	Ready to switch on.
		0	Not ready to switch on.
1	Ready run	1	Ready to operate, DC link charged.
		0	Not ready to operate, DC link not charged.
2	Ready ref	1	Operation enabled.
		0	Operation inhibited.
3	Tripped	1	Fault
		0	No fault
4	-	1	Not in use
		0	Not in use
5	-	1	Not in use
		0	Not in use
6	-	1	Not in use
		0	Not in use
7	Warning	1	Warning active.
		0	No warning active.
8	Modulating	1	Converter is modulating.
		0	Converter is not modulating.
9	Remote	1	Supply unit control location: REMOTE (EXT1 or EXT2).
		0	Supply unit control location: LOCAL.
10	Net OK	1	Network voltage is OK (Ready ref = operation is enabled).
		0	Network voltage is lost (Ready ref = operation is inhibited).
11	User bit 0	1	See parameter 106.30 MSW bit 11 sel.
		0	See parameter 106.30 MSW bit 11 sel.
12	User bit 1	1	See parameter 106.31 MSW bit 12 sel.
		0	See parameter 106.31 MSW bit 12 sel.
13	User bit 2	1	See parameter 106.32 MSW bit 13 sel.
		0	See parameter 106.32 MSW bit 13 sel.
14	Charging	1	Charging contactor closed.
		0	Charging contactor open.
15	User bit 3	1	See parameter 106.33 MSW bit 15 sel.
		0	See parameter 106.33 MSW bit 15 sel.

■ The state diagram

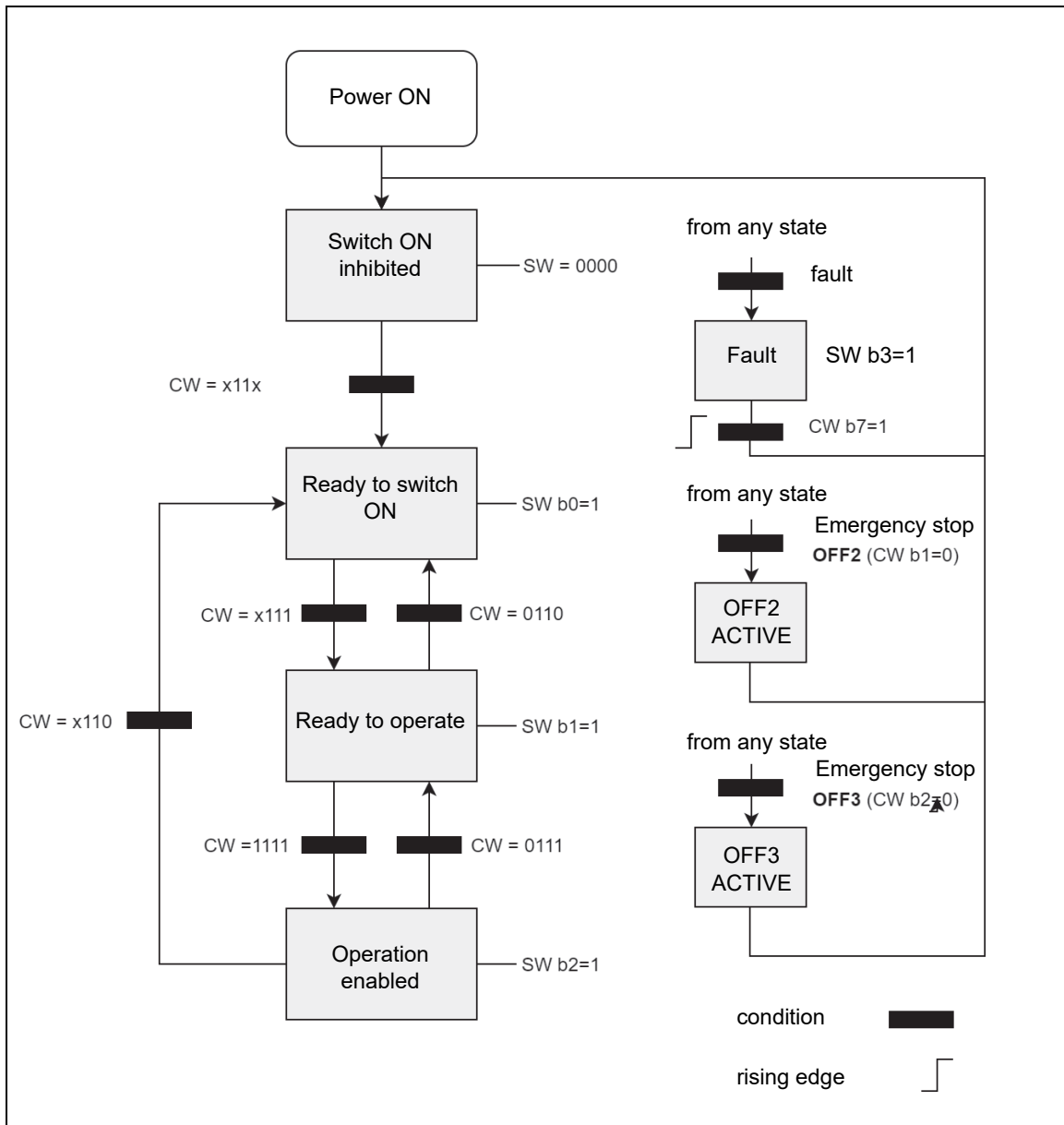

State	Status word (bits 0...3)	Description
Switch ON inhibited	0000	ISU interlocking prevents charging.
Ready to switch ON	0001	Main contactor open. No active interlocking that would prevent charging.
Ready to operate	0011	DC link charged. Not modulating.
Operation enabled	0111	Charged and modulating. Also when diode mode is active.
Fault	1000	Modulation stopped and main contactor opened.

Note: Main control word bit 10 (Remote cmd) must be set to 1 for the commands to take effect. Setting Main control word bit 10 (Remote cmd) to 0 stops the supply unit when controlled via fieldbus.

Setting up the IGBT supply unit for fieldbus control

Before configuring the IGBT supply unit for fieldbus control, the adapter module must be mechanically and electrically installed according to the instructions given in the user's manual of the appropriate fieldbus adapter module.

Note: To be able to switch the main contactor and the IGBT supply unit on and off through the fieldbus, the Run enable command at the digital input DI2 (by default) must be on (1).

1. Power up the IGBT supply unit.
 2. Enable the communication between the IGBT supply unit and the fieldbus adapter module by setting the parameter [150.01 FBA A enable](#).
 3. With [150.02 FBA A comm loss func](#), select how the IGBT supply unit should react to a fieldbus communication break.

Note: This function monitors both the communication between the fieldbus master and the adapter module and the communication between the adapter module and the IGBT supply unit.
 4. With [150.03 FBA A comm loss t out](#), define the time between communication break detection and the selected action.
 5. Select application-specific values for the rest of the parameters in group [150 FBA](#).
 6. Set the fieldbus adapter module configuration parameters in group [151 FBA A settings](#). At the minimum, set the required node address and the communication profile. Set profile to transparent 16 mode. **Note:** The parameter indexes and names vary as the way the different fieldbus adapters use these parameters. Example: For the FPBA adapter, set parameter [151.05 Profile](#) to mode *Trans16*.
 7. Define the process data transferred to and from the IGBT supply unit in parameter groups [152 FBA A data in](#) and [153 FBA A data out](#).

Note: The adapter module sets the Status word and Control word automatically into parameters [152.01](#) and [153.01](#) respectively.
 8. Save the valid parameter values to permanent memory by setting parameter [196.07 Parameter save manually](#) to *Save*.
 9. Validate the settings made in parameter groups 151, 152 and 153 by setting parameter [151.27 FBA A par refresh](#) to *Configure*.
 10. Select the fieldbus adapter A as the source of the start and stop commands for external control location EXT1 by setting parameter [120.01 Ext1 commands](#) to *Fieldbus A*.
 11. Set the relevant control parameters to control the IGBT supply unit according to the application.
-

Setting up communication through inverter unit

Communication port is selected with parameter 60.71 INU-LSU communication port in inverter unit and with parameter [160.51 DDCS controller comm port](#) in IGBT supply unit. Connect fiber optic cables between inverter unit and IGBT supply unit. Typically RDCO CH1 is used in inverter unit and RDCO CH0 is used in IGBT supply unit when BCU-x2 control unit is in use. When ZCU control unit is used, eg. channel A on FDCO module in slot 3 is used in IGBT supply unit. Setting the parameter [195.20 HW options word 1](#) bit 11 to Yes automatically sets all the communication parameters to their right values.

Set the parameters as follows:

IGBT supply unit parameter	Setting
120.01 Ext1 commands	<i>DDCS controller</i>
120.02 Ext1 start trigger type	<i>Level</i>
160.58 DDCS controller comm loss time	Set time, eg. 4 ms.
160.51 DDCS controller comm port	Set port to be used. Eg, slot 3A is used with ZCU control unit, and RDCO CH0 is used with BCU-x2 control unit.
161.51 Data set 11 data 1 selection	<i>SW 16bit</i>
162.51 Data set 10 data 1 selection	<i>CW 16bit</i>

Inverter unit parameter	Setting
94.01 LSU control	On
60.71 INU-LSU communication port	RDCO CH1
61.151 INU-LSU data set 10 data 1 sel	LSU CW
62.151 INU-LSU data set 11 data 1 sel	LSU SW

In IGBT supply unit, data transmitted from the IGBT supply unit is defined with parameters [161.51 Data set 11 data 1 selection](#)...[161.53 Data set 11 data 3 selection](#). Data is received using parameters [162.51 Data set 10 data 1 selection](#)...[162.53 Data set 10 data 3 selection](#).

In inverter unit, data transmitted to the IGBT supply unit is defined with parameters 61.151...61.153. Data is received using parameters 62.151...62.153.

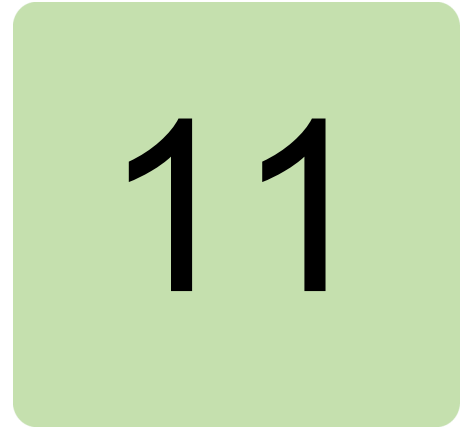

Drive-to-drive link

This feature is not supported by the current firmware version.

12

Control chain diagrams

What this chapter contains

The chapter presents the control chain diagrams of the control program.

DC voltage reference chain

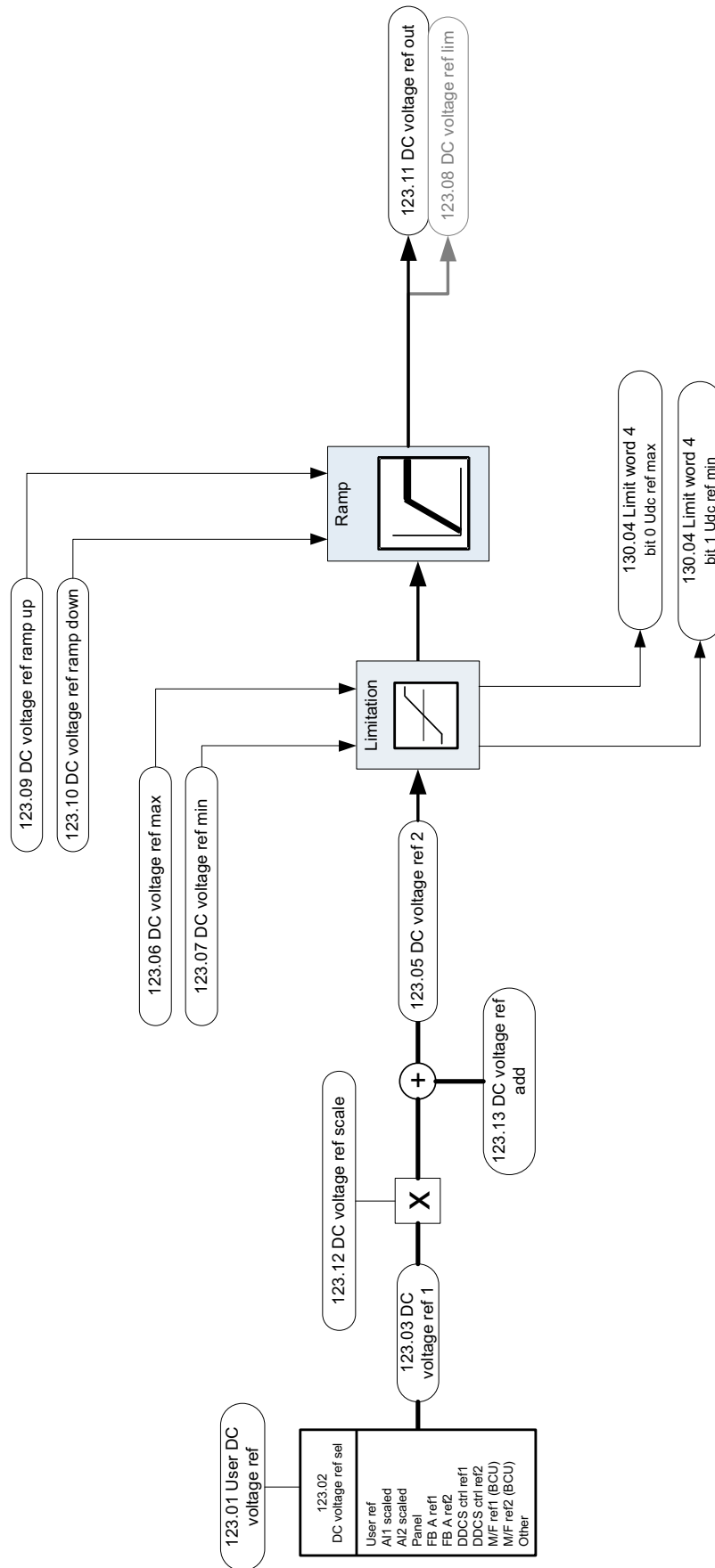

Power reference chain

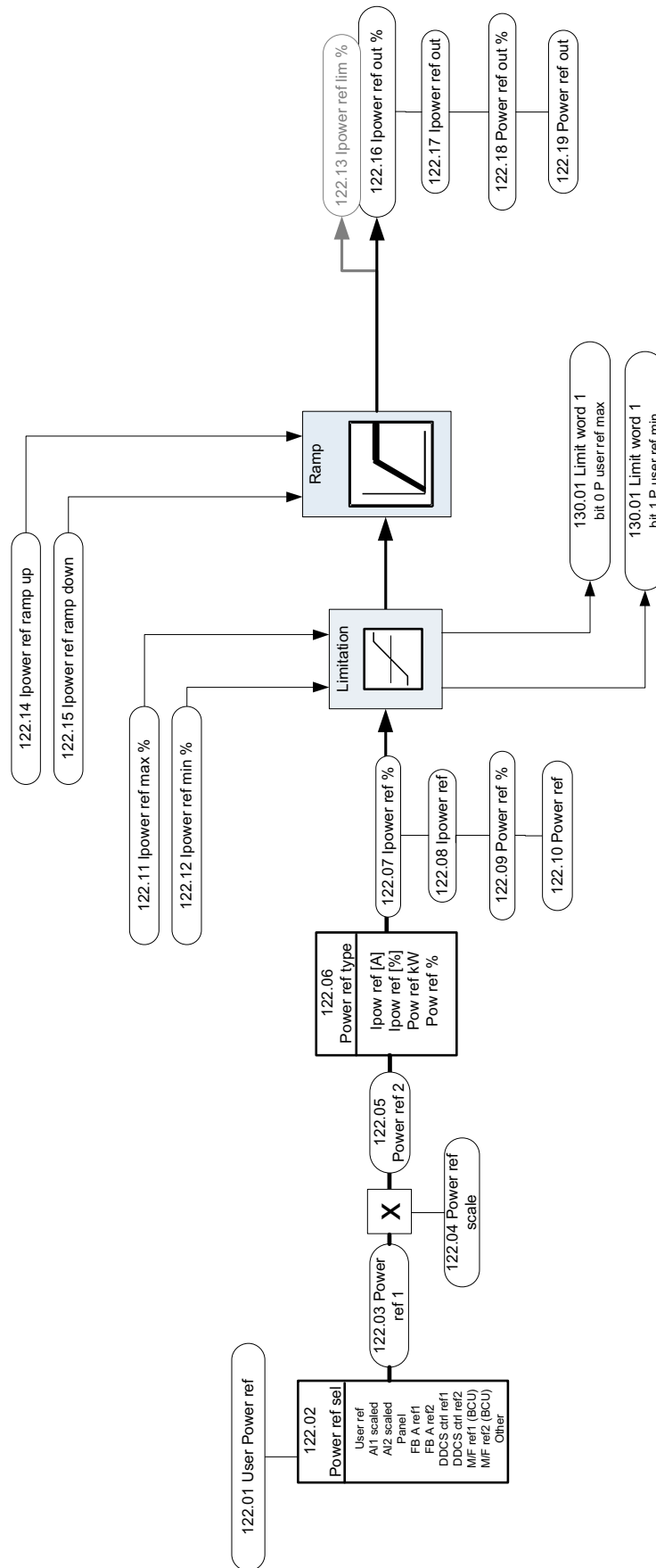

Reactive power reference chain

Reactive power control overview

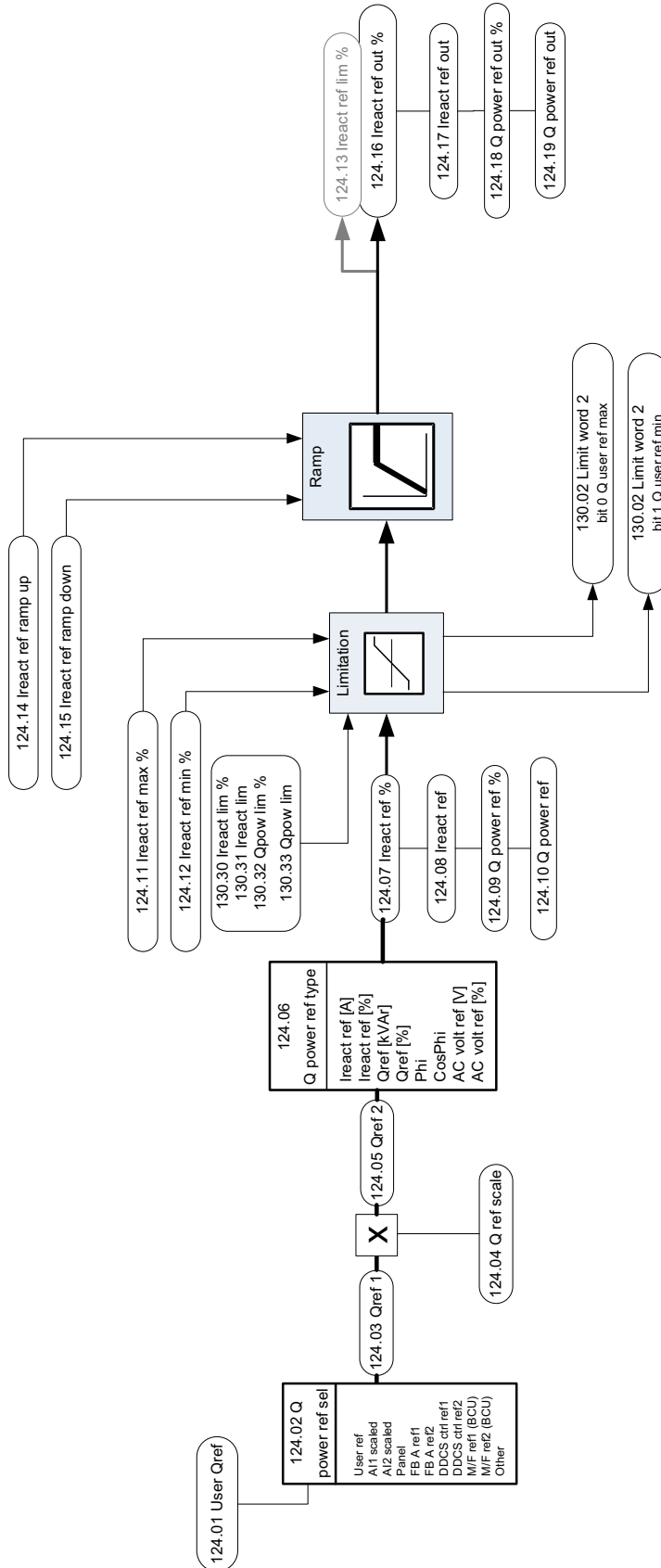

■ **Reactive power control detail – Processing of the reference type AC voltage**

This diagram is a detail of *Reactive power control overview* on page 270. It illustrates the conversion of the reference type AC voltage to the reactive current reference.

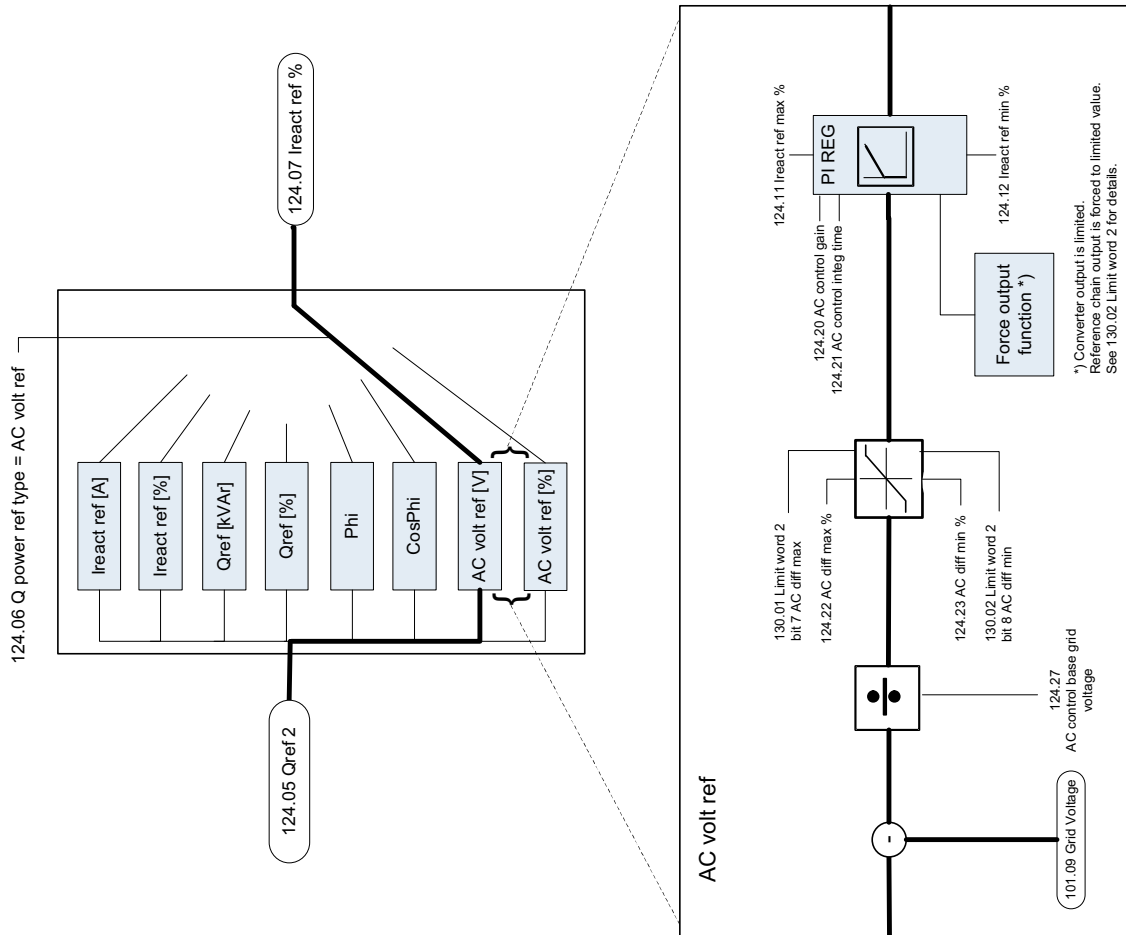

Current limitation chain

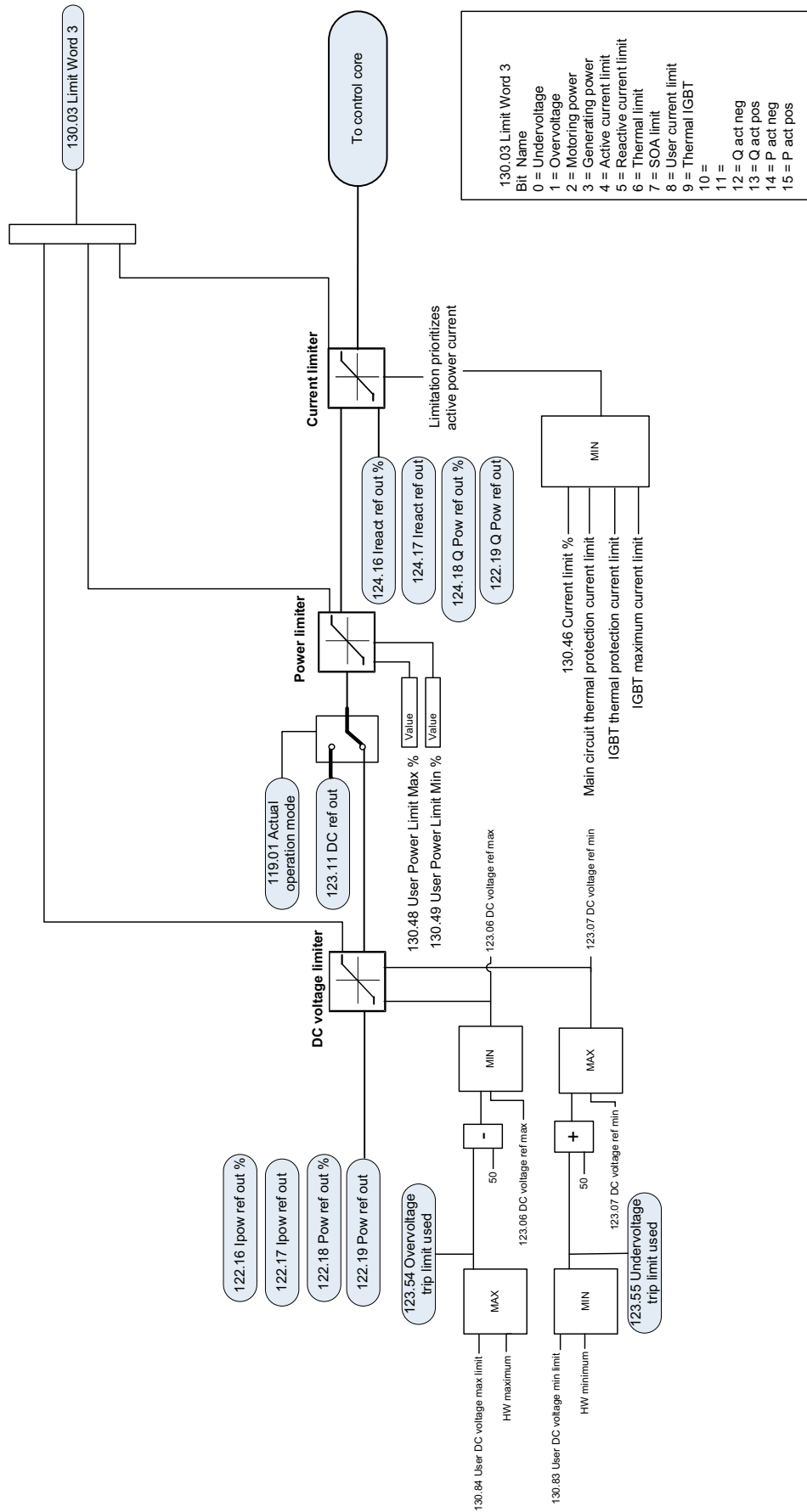

Further information

Product and service inquiries

Address any inquiries about the product to your local ABB representative, quoting the type designation and serial number of the unit in question. A listing of ABB sales, support and service contacts can be found by navigating to abb.com/searchchannels.

Product training

For information on ABB product training, navigate to new.abb.com/service/training.

Providing feedback on ABB Drives manuals

Your comments on our manuals are welcome. Navigate to new.abb.com/drives/manuals-feedback-form.

Document library on the Internet

You can find manuals and other product documents in PDF format on the Internet at abb.com/drives/documents.



abb.com/drives



3AUA0000131562H