



OPC Unified Architecture

The future standard for communication and information modeling in automation

Wolfgang Mahnke, Stefan-Helmut Leitner

OPC Unified Architecture (OPC UA) is the new standard specification for interconnectivity in state-of-the-art industrial automation technology, enabling rich information modeling capabilities, replacing existing OPC specifications. OPC UA provides a framework for interoperability to be used over the next 10 years and beyond (published also as IEC 62541).

ABB played a major role in creating OPC UA and has ensured the new standard meets process automation community requirements. After several years of work, a major segment of the specification was released in February 2009, and the first ABB product supporting OPC UA is already on the market.

OPC is a set of industrial standards for systems interconnectivity, providing a common interface for communications between different products from different vendors **Factbox 1**. There are over 22,000 products supplied by over 3,200 vendors. Process control systems must be able to communicate with all these products, accessing data or providing data access via a common communications platform. Classic OPC provides standard specifications for data access (DA), historical data access (HDA), and alarms and events (A&E). These OPC specifications are widely accepted by the automation industry. Classic OPC is based on aging Microsoft-COM/DCOM-technology,¹⁾ which has led to the development of new OPC Foundation specifications known as OPC UA (Unified Architecture). These specifications have been developed by more than 30 automation vendors, during a time period of five years. The main goal of OPC UA is to keep all the functionality of Classic OPC, while switching from Microsoft-COM/DCOM-technology to state-of-the-art Web services technology. By using web service technology OPC UA becomes platform-independent and can thus be applied in scenarios where Classic OPC is not used today. OPC UA can be seamlessly integrated into Manufacturing Execution Systems²⁾ (MES) and Enterprise Resource Planning³⁾ (ERP) systems, running not only on Unix/Linux systems using Java, but also on controllers and intelligent devices having specific real-time capable operation systems. Of course, compatibility with earlier OPC specifications was a requirement for OPC UA. It does not, therefore, preclude its use in Windows-based environments where Classic OPC already operates today – suiting Microsoft’s Windows Communication Foundation⁴⁾, which can also communicate using Web services **1**.

OPC UA has to fulfill and improve the non functional requirements of Classic OPC providing, for example, robust, reliable, high-performance communication suitable for automation. Learning from OPC XML-DA⁵⁾ (the first attempt made by the OPC Foundation to provide XML-based web services), OPC UA was designed to support binary encoding for high-performing data exchange. To provide reliable

1 OPC UA can be used for applications within the automation pyramid.

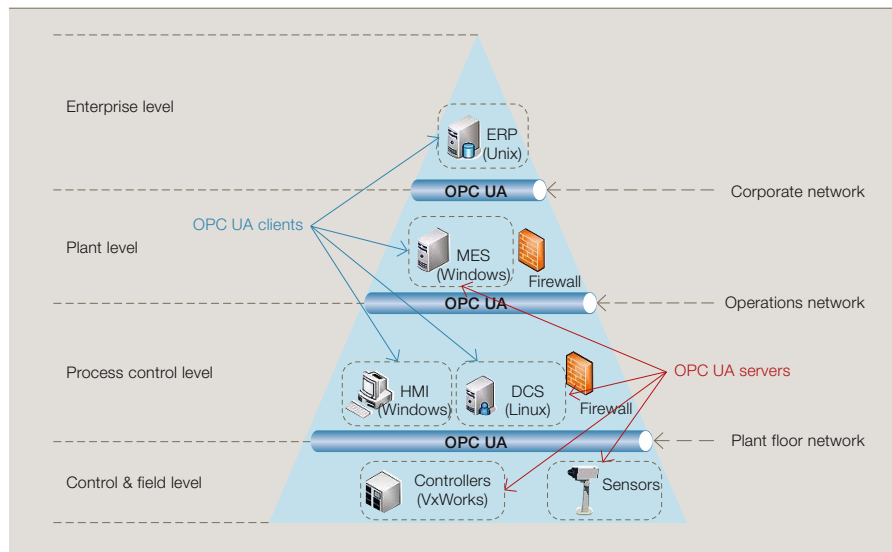

Factbox 1 OPC

OPC (OLE* for process control) was developed in 1996 by the automation industry as a standard specification that would allow the communication of real-time plant data between control devices produced by different manufacturers. The OPC Foundation was created to maintain the standard and has since overseen the introduction of a series of standard specifications (such as OPC data access). Today the OPC Foundation states that OPC UA is no longer an acronym for OLE for process control, but OPC UA is an acronym for OPen Connectivity Unified Architecture.

^{*)} Object Linking and Embedding (OLE) allows the visual display of data from other programs that the host program is not normally able to generate itself (eg, “embedding” a pie chart in a text document). The data in the file used to produce the embedded chart can change, “linking” the data so that the chart is updated within the embedded document.

Factbox 2 Meta model and information models

A meta model is a model to describe models. The meta model of an SQL (Structured Query Language) database defines the concept of a table, in an object-oriented programming language the concepts of a class and objects, and in IEC 61131-3 languages the concept of tasks, function blocks, programs, etc. In OPC UA the meta model defines the concepts of objects, their types, variables, data types, etc.

An information model is a model based on a meta model defining a specific semantic (meaning). In case of OPC UA this is mainly done by defining specific types of objects and variables, but also by defining specific objects and variables having a specific semantic (eg, entry points into the address space of a server). For example, based on the OPC UA meta model an information model for analyzer devices is defined by specifying specific types of analyzers. An OPC UA server can use this type of information to represent its data coming from an analyzer device.

Footnotes

- ¹⁾ Component Object Model (COM) was introduced by Microsoft in 1993 to allow component software to communicate between different applications. Distributed Component Object Model (DCOM) was also introduced by Microsoft allowing software components to communicate even when distributed across a network.
- ²⁾ Manufacturing Execution Systems (MES) manage and monitor work in progress on the factory floor.
- ³⁾ Enterprise resource planning (ERP) is a company-wide computer software system used to manage and coordinate all the resources, information, and functions of a business from shared data bases.
- ⁴⁾ Windows Communication Foundation (WCF) is a programming framework used to build applications that inter-communicate.
- ⁵⁾ OPC XML-DA builds on the existing OPC DA standard to deliver multi-vendor interoperability and connectivity to factory floor information via the Internet.

Efficiency and standards

2 Examples of OPC versus OPC UA models

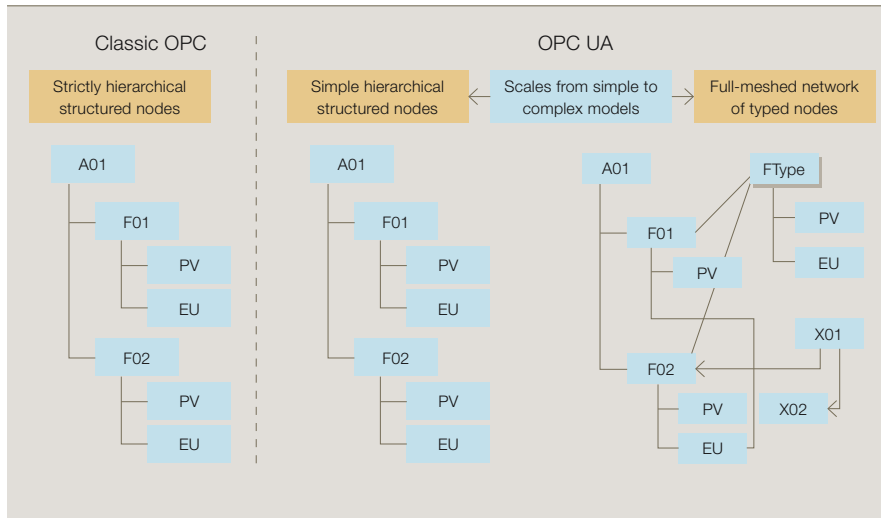

communication OPC UA has built-in mechanisms able to handle problems, such as lost messages. OPC UA has built-in security, a requirement that has become more and more important in environments where factory floor data must be accessed from the office network.

OPC UA can, in the long-term, drastically reduce engineering costs when integrating systems that use products from different vendors.

OPC UA brings together the different specifications of Classic OPC providing a single entry point into a system offering current data access, alarms and events, together with the history of both. In contrast to Classic OPC, OPC UA provides a single small set of generic services access to all information.

Whereas Classic OPC has a very simple meta model providing tags in a simple hierarchy, OPC UA provides a rich information model using object-oriented techniques [2]. It is not only possible to provide a measured value and its engineering unit using OPC UA, but also to identify the specific type of temperature sensor

used to obtain that measurement. This information is helpful in typical scenarios of Classic OPC, because the same graphics, ie, software component and configuration, displayed on an operator workstation can be used for each device of the same type, operating throughout the system. In addition, this information can also be utilized in a broader area of applications, like MES and ERP systems, helping to integrate data without the need to exchange tag lists that provide the semantics of the tags. OPC UA provides the flexibility to define and use rich information models, but does not require their use. An OPC UA server can still expose a simple information model, like OPC DA servers do today, but it can also provide much more information.

A major advantage of using OPC UA compared with Classic OPC, is that it

enables information modeling and facilitates many additional operations. OPC UA defines a simple set of base types that can be extended by information models (either application and vendor-specific models, or standardized models). The idea is that OPC UA specifies how data is exchanged, while standard information models specify what information is exchanged.

Intensive interest in information modeling has already created the impetus to standardize information models based on OPC UA. Common field devices could use a standardized information model to enable true plug-and-play multivendor interoperability [1]. This model was originally defined by the Field Device Integration (FDI) initiative and has already been refined by the Analyzer Devices Integration (ADI) group [2], defining specific analyzer devices. A working group, founded in October 2008 by PLCopen,⁶⁾ focuses on an OPC UA information model for IEC 61131-3 languages. The use of standard information models raises interoperability to a new level, not only allowing interoperable data exchange, but also making the model interoperable. This can, in the long-term, drastically reduce engineering costs when integrating systems that use products from different vendors.

OPC UA scales very well in several directions. It allows OPC UA applications to run on embedded devices with very limited hardware resources, as well as on very powerful machines like mainframes. Typically, servers running in such different environments will not provide the same information. The server on the embedded device is unlikely to provide a long history of the data and will only support a few clients, whereas other servers may provide several years worth of history and support thousands of clients. Information modeling aspects of OPC UA are also

3 Pillars of OPC UA

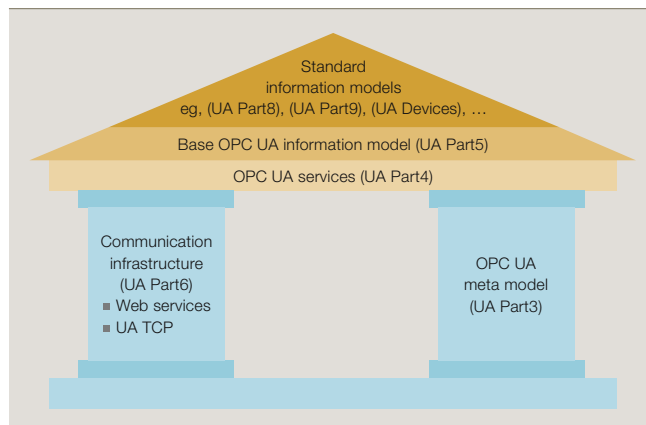

Footnote

⁶⁾ PLCopen is a vendor- and product-independent worldwide association. Its mission is to be the leading association resolving topics related to control programming to support the use of international standards in this field.

scalable. A server can provide anything from a very simple model, similar to Classic OPC, to highly sophisticated models providing highly sophisticated meta data on the given data. A client can just ignore this additional information and provide a simple view of the data or make use of the meta data provided by the server.

OPC UA defines two main pillars supporting interoperability: the communication infrastructure and the OPC UA meta model [3]. The communication infrastructure defines how information is exchanged and the meta model defines what information is exchanged.

Independent of the communication infrastructure, OPC UA defines a set of abstract services [3] that can run on different communication infrastructures and use the meta model [4] as the basis for defining appropriate parameters for the services. The base OPC UA Information Model [5] provides base types and entry points to the server's address space. On top of the base information model, vendor-specific or standard information models can be built. OPC UA already defines several standard information models for data access [6], alarms and

conditions [7], programs [8], historical data [9], and aggregate functions [10]. It also provides mechanisms to support multiple information models on one server. Data about the information models can be read by the services, so that clients knowing only the services, are capable of accessing all the information. Of course, clients knowing specific information models can be optimized by making use of that knowledge.

OPC UA is not directly compatible with Classic OPC, because it uses a different technology for data communication. To fulfill this requirement, however, the OPC Foundation not only provides software infrastructure for OPC UA communication (stacks⁷⁾ in ANSI C,⁽⁸⁾ .NET⁽⁹⁾ and Java), but also wrappers and proxies that either wrap existing servers to OPC UA clients or provide a proxy server⁽¹⁰⁾ for Classic OPC clients to access OPC UA servers.

OPC UA at ABB

ABB was heavily involved in the creation of OPC UA. Several ABB employees were members of the OPC UA working group formed by the OPC Foundation. Over time, ABB members have edited three of the eight released

specifications (ie, Address Space Model, Information Model and Security Model). With their broad software architecture expertise and extensive connections to experts, these employees helped to make decisions about the design and technology required to create a secure, reliable and high-performance OPC UA standard. A special focus for ABB was to ensure that the OPC UA information modeling concepts fit well with Extended Automation System 800xA's well-established and powerful Aspect Object Model. ABB's corporate research provided mapping concepts for integrating third-party OPC UA servers into System 800xA acting as an OPC UA client, and for integrating System 800xA, as an OPC UA server, into third-party OPC UA clients [4]. A prototype implementation has proved that the OPC UA concepts can be applied to System 800xA easily.

ABB is strongly supportive of OPC UA and has committed resources to ensure adequate training courses and presentations are available to introduce the OPC UA concepts. A third-party C++ based OPC UA software development kit (SDK) is provided for use within ABB. A sharepoint server

4 Typical screen shots from System 800xA

a System 800xA native view (Plant Explorer)

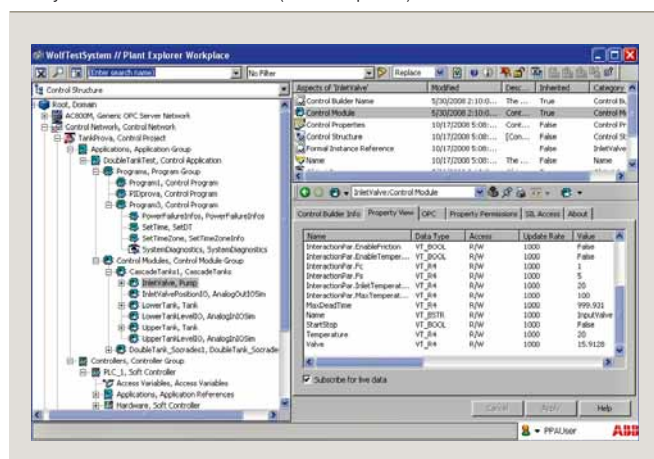

b System 800xA view using a generic OPC UA client

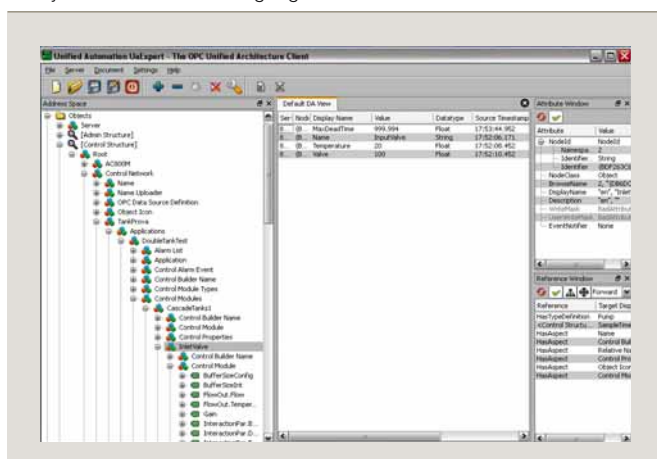

Footnotes

- ⁷⁾ A communication stack is the software that implements a communication protocol across a computer network.
- ⁸⁾ ANSI C is the American National Standards Institute's standard C programming language. By creating a standard for software developers writing in C the code is portable (ie, little effort is required to adapt it to a new environment).
- ⁹⁾ The Microsoft .NET Framework is a software framework available with several Microsoft Windows operating systems intended to be used by most new applications created for the Windows platform.
- ¹⁰⁾ A proxy server acts as a go-between for requests from clients seeking resources from other servers.
- ¹¹⁾ Anybody inside ABB can contact the authors of this article for training or access to ABB's sharepoint server.

Efficiency and standards

provides the latest news and SDK updates to keep the ABB OPC UA community informed worldwide^[1].

ABB also took part in the early adopter program of the OPC Foundation, helping to develop an ANSI C-based OPC UA stack, developing the security module and participating in code reviews. The portable design of the stack already allowed ABB to develop a port to VxWorks, a popular real-time operation system running on many ABB controllers like the AC800M and the robotics controller (IRC5). In addition, the OPC Foundation provides the stack with ports for Linux and Windows operating systems.

5 The authors have written a book, OPC Unified Architecture, which provides further discussion of advanced topics.

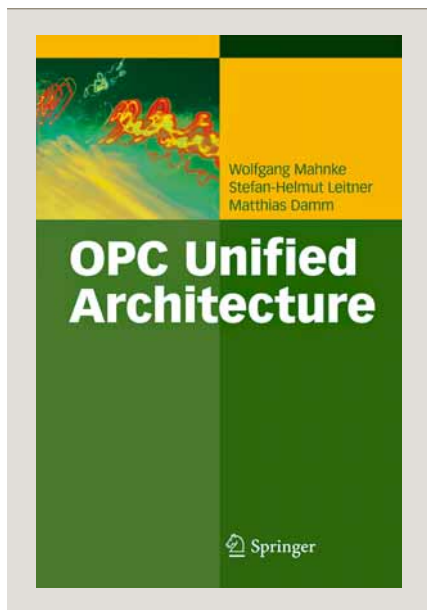

As the development of the specification was finalized ABB participated in several interoperability workshops organized by the OPC Foundation to ensure interoperability of ABB's OPC UA applications with third-party implementations, including those from ICONICS, Siemens, Beckhoff, Kepware, and OSISoft.

ABB is strongly supportive of OPC UA and has committed resources to ensure adequate training courses and presentations are available to introduce the OPC UA concepts.

ABB was involved in the development of standard information models based on OPC UA for field devices (FDI) and analyzer devices (ADI). In addition, ABB is a member of the PLCopen working group defining an OPC UA-based information model for IEC 61131-3 languages.

Internal presentations and training, together with ABB participation at several OPC UA developer conferences and other events, have emphasized ABB's leading role in OPC UA development and its position as technology leader. ABB's determination to provide an easy-to-read introduction to the OPC UA concept with further discussion of advanced topics is illustrated by its authorship of the first book written on OPC UA [11] 5.

OPC UA products

ABB is currently evaluating the application of OPC UA to certain ABB products. Others have already been evaluated and OPC UA-compatible products are on their way. Among these early products are SCADA Vantage™, which is due for release in 2010, and process analytical technology – PAT 2.0, which is already on the market as the first ABB product supporting OPC UA.

SCADA Vantage

ABB's Industrial™ SCADA Vantage is a SCADA (Supervisory Control and Data Acquisition) system typically used in the oil and gas industry 6. The information provided includes instances and types, current data, alarms & events, and history. The same information can be exposed natively via an OPC UA server 7. Thus the SCADA Vantage data is exposed in a standardized way and can be used by third-party products as well as integrated into other ABB products having an OPC UA client. The release of SCADA Vantage with an OPC UA server is scheduled for 2010. Later versions will also have an OPC UA client to allow the integration of OPC UA servers into SCADA Vantage.

Process analytical technology

ABB's Industrial™ eXtended PAT promotes the integration of analytical measurements into the manufacturing process and was released in 2007. A major upgrade with OPC UA support was released in Q1 2009. It utilizes OPC UA to provide standardized connectivity to process analyzers.

6 The SCADA Vantage native explorer

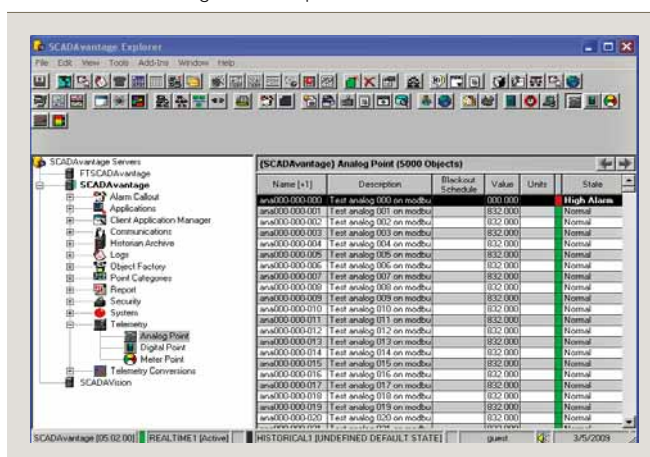

7 The SCADA Vantage OPC UA view

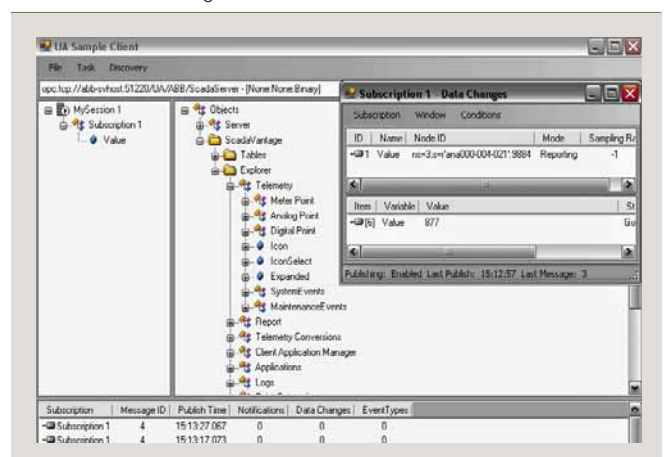

8 OPC UA helps xPAT integrate analyzers, either by using a proprietary interface for each analyzer provided by an analyzer controller **a**, or using OPC UA for all analyzer devices supporting OPC UA **b**.

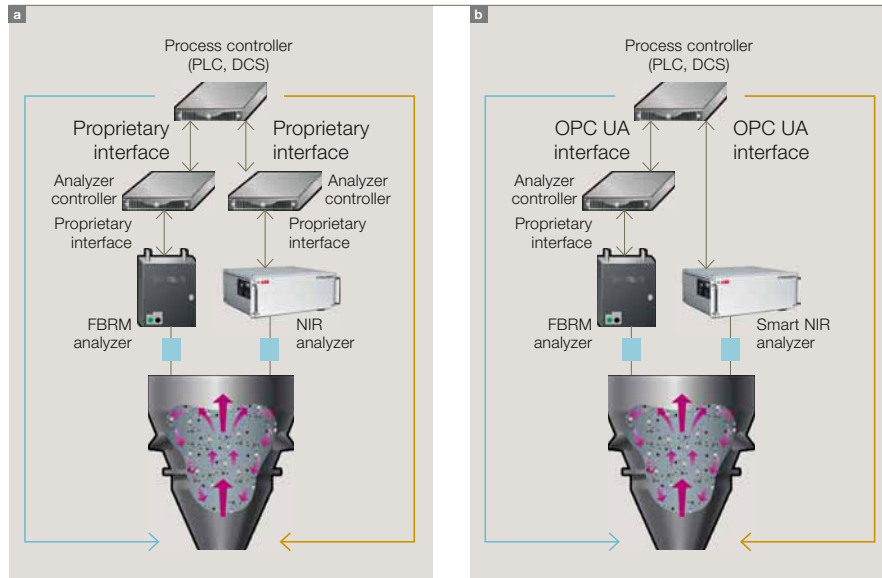

With its powerful integration capabilities and functionality, xPAT helps customers in the life science industry implement quality, by design, throughout the entire pharmaceutical product life-cycle, from drug discovery through development to production.

Process analytical technology – PAT 2.0 – is already on the market as the first ABB product supporting OPC UA.

ABB's xPAT uses OPC UA when integrating analyzers **8**. The OPC UA server can either be hosted on an

analyzer controller or directly on the analyzer device and thus eliminate additional hardware. Using the ADI information model, it is not only possible to standardize how data is communicated, but also what data is exchanged.

Other suppliers

The first products from other suppliers have already been launched, even before the specification was released. This includes ICONICS' HMI/SCADA system, GENESIS 64, which also uses OPC UA for internal communication, Beckhoff's TwinCat and Kepware's KEPServerEx, both running on controllers, as well as Siemens' SIMATIC NET. For 2009, long lists of competitors have promised to deliver their

first OPC UA products, including Emerson, Honeywell, Wonderware, and Yokogawa.

SCADA Vantage data is exposed in a standardized way and can be used by third-party products as well as integrated into other ABB products having an OPC UA client.

Prospects

OPC UA is ready to replace Classic OPC using state-of-the-art, high-performance technology that is reliable and secure, raising interoperability in automation to a new level, by allowing standard information models based on OPC UA. With the wrappers and proxies provided by the OPC Foundation, existing OPC products are guaranteed to work within the OPC UA environment.

References

- [1] OPC Foundation: Devices, Draft Version 0.75, Dec. 2008
- [2] OPC Foundation: Analyzer Devices, Draft Version 0.30.00, Dec. 2008
- [3] OPC Foundation: UA Spec. Part 4 – Services, Version 1.01, Feb. 2009
- [4] OPC Foundation: UA Spec. Part 3 – Address Space Model, Version 1.01, Feb. 2009
- [5] OPC Foundation: UA Spec. Part 5 – Information Model, Version 1.01, Feb. 2009
- [6] OPC Foundation: UA Spec. Part 8 – Data Access, Version 1.01, Feb. 2009
- [7] OPC Foundation: UA Spec. Part 9 – Alarms and Conditions, DRAFT Version 0.93q, Nov. 2007
- [8] OPC Foundation: UA Spec. Part 10 – Programs, Version 1.00, Jan. 2007
- [9] OPC Foundation: UA Spec. Part 11 – Historical Access, Version 1.00, Jan. 2007
- [10] OPC Foundation: UA Spec. Part 13 – Aggregates, RC Version 1.0, July 2008
- [11] Mahnke, W., Leitner, S.-H., Damm, M. (2009). OPC Unified Architecture. Springer Verlag.

Further reading

- OPC Foundation: UA Spec. Part 6 – Concepts, Version 1.00, Feb. 2009
- OPC Foundation: UA Spec. Part 7 – Profiles, Version 1.00 Feb. 2009

Wolfgang Mahnke

Stefan-Helmut Leitner

ABB Corporate Research

Ladenburg, Germany

wolfgang.mahnke@de.abb.com

stefan.leitner@de.abb.com