

SOFTSTARTER TYPE PSTX

Fieldbus Plug

Modbus RTU



| | | | | |
|---|---------------------------------|--------------------------|-------------|--------------|
| PREPARED 2021-03-12 | STATUS Approved | SECURITY LEVEL Public | | |
| RELEASED 2021-04-27 | DOCUMENT KIND Manual | | | |
| OWNING ORGANIZATION Motor Starting & Safety Softstarters | DOCUMENT ID. 1SFC132092M0201 | REV. F | LANG. en | PAGE 1/32 |

© Copyright 2021 ABB. All rights reserved.

Contents

- 1. Modbus RTU 3**
- 2. Modbus Addressing 4**
 - 2.1. Protocol Address 4
 - 2.2. Modicon Address 4
 - 2.3. Translating Modicon address to protocol address 4
- 3. PSTX Data 5**
 - 3.1. Digital input telegram 5
 - 3.2. Programmable Digital Inputs 6
 - 3.3. Analog input telegram 7
 - 3.4. Programmable Analog Inputs 8
 - 3.5. Digital output telegram 9
 - 3.6. Analog output telegram 11
- 4. Modbus RTU - A set-up example 11**
 - 4.1. Softstarter PST Modbus RTU communication 11
 - 4.2. Settings 12
 - 4.3. Read binary input telegram 12
 - 4.4. Write binary output telegram 13
 - 4.5. Read analog input telegram 14
 - 4.6. Write analog input telegram 16
- 5. Fieldbus Tasks 17**
 - 5.1. FBT Control Word 17
 - 5.2. Task ID 17
 - 5.3. Response ID 17
 - 5.4. Error codes 18
 - 5.5. Request parameter value, lower word 18
 - 5.5.1. Arguments 18
 - 5.5.2. Return Value 18
 - 5.6. Change parameter value 18
 - 5.6.1. Arguments 18
 - 5.6.2. Return Value 18
 - 5.7. Set date and time 19
 - 5.7.1. Arguments 19
 - 5.7.2. Return Value 19
 - 5.8. Request parameter value, upper word 19
 - 5.8.1. Arguments 19
 - 5.8.2. Return Value 19
 - 5.9. Parameter numbers and values 20
 - 5.9.1. Negative values 20
- 6. Example application with Automation Builder 21**
 - 6.1. Create a new project in Automation Builder 21
 - 6.2. Add Modbus RTU master to project 22
 - 6.3. Build a START-STOP program 23
 - 6.4. Connect to PLC using TCP/IP 30
 - 6.5. Build and run the PLC demo program 31
- 7. Contact us 32**

| STATUS | SECURITY LEVEL | DOCUMENT ID. | REV. | LANG. | PAGE |
|----------|----------------|-----------------|------|-------|------|
| Approved | Public | 1SFC132092M0201 | F | en | 2/32 |

1. Modbus RTU

Modbus is a master-slave protocol and only one device can transmit on the line at any time. The master (which in most cases is a PLC) manages the exchanges and only it can take the initiative. It interrogates each of the slaves in succession and no slave can send a message unless it is invited to do so. The master repeats the question when there is an incorrect exchange and declares the interrogated slave absent if no response is received within a given time. If a slave does not understand a message, it sends an exception response to the master who may or may not repeat the request.

The Modbus protocol is a fieldbus protocol that provides full control and status information of the softstarter, reading as well as writing of parameters. Through the fieldbus it is possible to start and stop the motor, read out currents and frequency, get information about protections, warnings, faults and much more.

See chapter 8 in the Installation and commissioning manual, document 1SFC132081M0201, for fieldbus related settings.

Before the Modbus RTU can be taken in operation following parameters must be set in the softstarter:

- Parameter 12.2 FB interface connector set to FbPlug.
- Parameter 12.3 Fieldbus control set to On (This parameter can be set to Off if the fieldbus interface is only used to monitor the softstarter).
- Parameter 12.4 Fieldbus address set to an available Modbus slave id. In the examples (section 4) the fieldbus address is set to 47, but this parameter can be set to any value between 1-247.

The parity and number of stop bits are automatically detected by the fieldbus plug.

The baud rate depends on the configured fieldbus address according to the table below:

| Fieldbus address | Baud rate bits/s |
|------------------|------------------|
| 1 to 32 | 9600 |
| 33 to 65 | 19200 |
| 66 to 98 | 57600 |
| 99 to 247 | 19200 |



Information

After changing any of the communication parameters it is needed to perform a power cycle of the device for the parameter values to be taken into effect. Or another way for a communication parameter value change to be taken into effect is to set parameter 12.2 FB interface connector to “None” and then set it back to “FbPlug”.

If there is no message passed between the PSTX softstarter and the Fieldbus plug for more than 100ms, the PSTX softstarter will trip on fieldbus communication failure protection (P1E00) and with the default configuration, the motor will be stopped. If the fieldbus communication system is setup in such a way that commands/requests are not continuously passed between the PLC and softstarter, this protection function should be disabled. The parameter 19.4 (Fieldbus failure op) can then be set to “Off”.

**Caution!**

The motor may start unexpectedly if there is a start signal present when doing any of the actions listed below.

- Switching from one type of control to another (fieldbus control/hardwire control)
- Reset all Settings

2. Modbus Addressing

When talking about Modbus addressing, there is often a misunderstanding about what an address really is. This section will try to clarify the conventions in this document.

2.1. Protocol Address

The Modbus standard specification uses one kind of address, a two-byte unsigned integer (0-65535).

This is the address that is actually transmitted to the device.

2.2. Modicon Address

Modbus was originally developed by Modicon and the notation used then is still often used today, though considered obsolete by present standards.

The Modicon notation combines two pieces of information in a single number:

1. The register type
2. The register number

A register number offset defines the type and makes it possible to translate between the two types of addresses.

Table 1 Register types and ranges

| Prefix | Register Type | Range |
|--------|------------------|-------------|
| 0x | Coil | 00001-00001 |
| 1x | Discrete Input | 10001-19999 |
| 3x | Input Register | 30001-39999 |
| 4x | Holding Register | 40001-49999 |

2.3. Translating Modicon address to protocol address

An example:

Modicon address 40002 selects the holding register at protocol address 0001 (40002 – 40001 = 1). The protocol address 0001 will be transmitted in the message packet.

| STATUS | SECURITY LEVEL | DOCUMENT ID. | REV. | LANG. | PAGE |
|----------|----------------|-----------------|------|-------|------|
| Approved | Public | 1SFC132092M0201 | F | en | 4/32 |

3. PSTX Data

3.1. Digital input telegram

To PLC from the softstarter. The input data is updated every 20 ms.

Use Modbus function code 01, Read Coil Status.

| Protocol Address | Modicon Address | Bit | Data | Description |
|------------------|-----------------|-----|-------------------------------|---|
| 0000h | 00001 | 0 | Auto Mode status ¹ | 0 = softstarter control from fieldbus not allowed |
| 0001h | 00002 | 1 | Event status | 0 = No active fault/warning/protection |
| 0002h | 00003 | 2 | Ready to start | 0 = A start will probably cause a fault, 1 = A start will probably not cause a fault |
| 0003h | 00004 | 3 | FBT Response 0 | See Fieldbus Tasks |
| 0004h | 00005 | 4 | FBT Response 1 | See Fieldbus Tasks |
| 0005h | 00006 | 5 | FBT Toggle Bit | See Fieldbus Tasks |
| 0006h | 00007 | 6 | Programmable Digital Input 1 | Function of programmable digital input, see section 3.2 |
| 0007h | 00008 | 7 | Programmable Digital Input 2 | |
| 0008h | 00009 | 8 | Programmable Digital Input 3 | |
| 0009h | 00010 | 9 | Programmable Digital Input 4 | |
| 000Ah | 00011 | 10 | Programmable Digital Input 5 | |
| 000Bh | 00012 | 11 | Programmable Digital Input 6 | |
| 000Ch | 00013 | 12 | Programmable Digital Input 7 | |
| 000Dh | 00014 | 13 | Programmable Digital Input 8 | |
| 000Eh | 00015 | 14 | Programmable Digital Input 9 | |
| 000Fh | 00016 | 15 | Programmable Digital Input 10 | |

¹⁾ Auto mode reflects the control state of the Softstarter. This is affected by a combination of:

- The Auto mode input signal from the PLC (Digital output telegram).
- The state of the Local/Remote switch on the Fieldbus Plug Accessory.
- The state of the Local/Remote switch on the HMI.
- The parameter "Fieldbus control".
- The digital input "Fieldbus disable".

3.2. Programmable Digital Inputs

The functions of the programmable Digital inputs are controlled by the parameters Fieldbus DI 1 through Fieldbus DI 10. The following functions are available for selection:

| Function | Data |
|-----------------------------|--|
| None | Value is set to 0. |
| Start feedback | Status of Start signal. |
| Stop feedback | Status of Stop signal. |
| Fault reset feedback | Status of Reset signal. |
| Slow speed reverse feedback | Status of Slow speed reverse signal. |
| Slow speed forward feedback | Status of Slow speed forward signal. |
| Start 1 feedback | Status of Start 1 signal. |
| Start 2 feedback | Status of Start 2 signal. |
| Start 3 feedback | Status of Start 3 signal. |
| Motor heating feedback | Status Motor heating signal. |
| User defined feedback | Status of User defined protection signal. |
| Stand still brake feedback | Status of Stand still brake signal. |
| Emergency mode feedback | Status of Emergency mode signal. |
| Start reverse feedback | Status of Start reverse signal. |
| Run status | 1 = Indicates when the softstarter gives voltage to the motor. |
| TOR status | Top of Ramp. 1 = Indicates that motor runs on full voltage. |
| Line | Line or Inside Delta Connection; 0 = Line, 1 = Delta. |
| Phase sequence | 0 = L1, L2, L3; 1 = L1, L3, L2. |
| Event group 0 status | 0 = No active events present in group 0. |
| Event group 1 status | 0 = No active events present in group 1. |
| Event group 2 status | 0 = No active events present in group 2. |
| Event group 3 status | 0 = No active events present in group 3. |
| Event group 4 status | 0 = No active events present in group 4. |
| Event group 5 status | 0 = No active events present in group 5. |
| Event group 6 status | 0 = No active events present in group 6. |
| Sequence 1 Run status | Run status of sequence connected motor 1. |
| Sequence 2 Run status | Run status of sequence connected motor 2. |
| Sequence 3 Run status | Run status of sequence connected motor 3. |
| Sequence 1 TOR status | Top of Ramp status of sequence connected motor 1. |
| Sequence 2 TOR status | Top of Ramp status of sequence connected motor 2. |
| Sequence 3 TOR status | Top of Ramp status of sequence connected motor 3. |
| Run reverse status | 1 = Indicates when the softstarter gives voltage to the motor after a reverse start. |
| Enable status | Status of Enable signal. |
| Digital In0 status | Status of internal digital input In0. |

| Function | Data |
|---------------------------------|---|
| Digital In1 status | Status of internal digital input In1. |
| Digital In2 status | Status of internal digital input In2. |
| Local control status | 0 = Remote control, 1 = Local control (HMI). |
| Cancel brake feedback | Status of Cancel brake signal. |
| Pump cleaning auto status | Status of automatic pump cleaning. |
| Pump cleaning forward status | Status of forward pump cleaning. |
| Pump cleaning backward status | Status of reverse pump cleaning. |
| External digital 1DI0 status | Status of external digital input 1DI0. |
| External digital 1DI1 status | Status of external digital input 1DI1. |
| External digital 1DI2 status | Status of external digital input 1DI2. |
| External digital 1DI3 status | Status of external digital input 1DI3. |
| External digital 1DI4 status | Status of external digital input 1DI4. |
| External digital 2DI5 status | Status of external digital input 2DI5. |
| External digital 2DI6 status | Status of external digital input 2DI6. |
| External digital 2DI7 status | Status of external digital input 2DI7. |
| HW DI Start status | Status of the hard wire internal digital input Start. |
| HW DI Stop status | Status of the hard wire internal digital input Stop. |
| Ready to start (line contactor) | Same conditions as the Ready to Start bit except that the incoming three phase voltage condition is excluded. The bit can be used when a line contactor is connected. |

3.3. Analog input telegram

To PLC from the softstarter.

All analog data is represented as 16-bit values. The input data is updated every 20 ms. Use Modbus function code 04, Read Input Registers.

A protocol for Fieldbus tasks is used to read and write parameters. It is applicable for all fieldbuses.

| Protocol Address | Modicon Address | Data | Representation |
|------------------|-----------------|-----------------------------|--|
| 0200h | 30513 | FBT Return Value | See Fieldbus Tasks |
| 0201h | 30514 | Programmable Analog Input 1 | Function of programmable analog input, see section 3.4 |
| 0202h | 30515 | Programmable Analog Input 2 | |
| 0203h | 30516 | Programmable Analog Input 3 | |
| 0204h | 30517 | Programmable Analog Input 4 | |
| 0205h | 30518 | Programmable Analog Input 5 | |
| 0206h | 30519 | Programmable Analog Input 6 | |

3.4. Programmable Analog Inputs

The functions of the programmable analog inputs are controlled by the parameters Fieldbus AI 1 through Fieldbus AI 10. The following functions are available for selection:

| Function | Representation |
|---------------------------------|--|
| None | Value is set to 0 |
| Phase L1 current ¹ | Value = 1000 ⇒ 100A |
| Phase L2 current ¹ | Value = 1000 ⇒ 100A |
| Phase L3 current ¹ | Value = 1000 ⇒ 100A |
| Active power (hp) | Value = 1000 ⇒ 10hp |
| Active power | Value = 1000 ⇒ 10kW |
| Apparent power | Value = 1000 ⇒ 10kVA |
| Mains voltage | Value = 1000 ⇒ 100V |
| Power factor | Value = 100 ⇒ 1 Example: 87 ⇒ 0.87 |
| Motor voltage | Value = 100 ⇒ 100% |
| Active energy (resettable) | Value = 1000 ⇒ 10kWh |
| EOL time to trip | Value = 100 ⇒ 100s Value = 65535 ⇒ No overload Value = 0 ⇒ Trip already occurred |
| Mains frequency | Value = 1000 ⇒ 100Hz |
| Max phase current ¹ | Value = 1000 ⇒ 100A |
| Motor current | Value = 1000 ⇒ 100A |
| Motor run time (resettable) | Value = 100 ⇒ 1000h |
| Motor temperature | Value = 100 ⇒ 100°C |
| Motor temperature percent | Value = 100 ⇒ 100% |
| Number of starts (resettable) | Value = 1 ⇒ 100 |
| Phase sequence | Value = 0 ⇒ L1->L2->L3 Value = 1 ⇒ L1->L3->L2 Value = 2 ⇒ No sequence detected |
| PT100 temperature | Value = n ⇒ n/10 – 50°C Example: 750 ⇒ 25°C |
| PTC resistance | Value = 100 ⇒ 100Ω |
| Reactive energy (resettable) | Value = 1000 ⇒ 10kVARh |
| Reactive power | Value = 1000 ⇒ 100VAR |
| Remaining time to start | Value = 100 ⇒ 100s |
| Thyristor temperature | Value = 100 ⇒ 100°C |
| Thyristor temperature percent | Value = 100 ⇒ 100% |
| EOL time to cool | Value = 100 ⇒ 100s |
| Top event code | Value = 1000 ⇒ 1000 |
| Motor current in percent of IE | Value = 100 ⇒ 100% |
| Thyristor run time (resettable) | Value = 1 ⇒ 10h |

| Function | Representation |
|---|---|
| Motor connection | Value = 0 ⇒ auto Value = 1 ⇒ In-line Value = 2 ⇒ Inside delta – UI Value = 3 ⇒ Inside delta – IU Value = 4 ⇒ 2-phase L1 shorted Value = 5 ⇒ 2-phase L2 shorted Value = 6 ⇒ 2-phase L3 shorted |
| Phase L1 current high range ² | Value = 100 ⇒ 100A |
| Phase L2 current high range ² | Value = 100 ⇒ 100A |
| Phase L3 current high range ² | Value = 100 ⇒ 100A |
| Active power (hp) high range ² | Value = 100 ⇒ 100hp |
| Active power high range ² | Value = 100 ⇒ 100kW |
| Apparent power high range ² | Value = 100 ⇒ 100kVA |
| Reactive power high range ² | Value = 100 ⇒ 100kVAr |
| Max phase current high range ² | Value = 100 ⇒ 100A |
| Max motor current high range ² | Value = 100 ⇒ 100A |
| Active energy high range ² | Value = 1 ⇒ 10000kWh |
| Reactive energy high range ² | Value = 1 ⇒ 10000kVArh |
| Number of starts (high precision) | Value = 1 ⇒ 1 |

¹⁾ Phase current L1, L2 and L3 indicate the current through the softstarter, while the Max phase current is always the line current.

²⁾ High Range alternatives are available for a few signals where there is a possibility for the values to wrap. The values are 16-bit so the maximum value for each signal is 65535. The High Range alternatives have different scaling and will never wrap around but instead have lower precision.

3.5. Digital output telegram

From PLC to softstarter. Use Modbus function code 15 (0Fh), Force Multiple Coils.

| Protocol Address | Modicon Address | Bit | Data | Description |
|------------------|-----------------|-----|--------------------|--|
| 0100h | 257 | 0 | Start | Commence a start when signal is set. |
| 0101h | 258 | 1 | Stop | Commence a stop when signal is negated. |
| 0102h | 259 | 2 | Fault reset | Reset signal for possible events. |
| 0103h | 260 | 3 | Auto mode | This must be set for controlling the motor. |
| 0104h | 261 | 4 | Slow speed reverse | Perform slow speed reverse when signal is set. |
| 0105h | 262 | 5 | Slow speed forward | Perform slow speed when signal is set. |
| 0106h | 263 | 6 | Spare | |
| 0107h | 264 | 7 | Start1 | Start1 if sequence start. |
| 0108h | 265 | 8 | Start2 | Start2 if sequence start. |

| Protocol Address | Modicon Address | Bit | Data | Description |
|------------------|-----------------|-----|--------------------------|---|
| 0109h | 266 | 9 | Start3 | Start3 if sequence start |
| 010Ah | 267 | 10 | Motor heating | Perform motor heating when signal is set |
| 010Bh | 268 | 11 | Stand still brake | Perform stand still brake when signal is set |
| 010Ch | 269 | 12 | Start reverse | Commence a reverse start when signal is set |
| 010Dh | 270 | 13 | Spare | |
| 010Eh | 271 | 14 | Emergency mode | Set to "1" to enable emergency mode |
| 010Fh | 272 | 15 | FBT Toggle Bit | See Fieldbus Tasks |
| 0110h | 273 | 16 | User defined trip | Set to "1" to trigger user defined protection trip |
| 0111h | 274 | 17 | Switch to remote control | Switch to remote control when signal is set (rising edge triggered) |
| 0112h | 275 | 18 | Pump cleaning automatic | Perform automatic pump cleaning when signal is set |
| 0113h | 276 | 19 | Pump cleaning forward | Perform forward pump cleaning when signal is set |
| 0114h | 277 | 20 | Pump cleaning reverse | Perform reverse pump cleaning when signal is set |
| 0115h | 278 | 21 | K4 relay command | Set "1" to activate the internal K4 output relay. Note that parameter 10.4 K4 function has to be set as "Fieldbus" |
| 0116h | 279 | 22 | K5 relay command | Set "1" to activate the internal K5 output relay. Note that parameter 10.5 K5 function has to be set as "Fieldbus" |
| 0117h | 280 | 23 | K6 relay command | Set "1" to activate the internal K6 output relay. Note that parameter 10.6 K6 function has to be set as "Fieldbus" |
| 0118h | 281 | 24 | 1DO0 relay command | Set "1" to activate the external 1DO0 output relay. Note that parameter 11.9 1DO0 function has to be set as "Fieldbus" |
| 0119h | 282 | 25 | 1DO1 relay command | Set "1" to activate the external 1DO1 output relay. Note that parameter 11.10 1DO1 function has to be set as "Fieldbus" |
| 011Ah | 283 | 26 | 2DO2 relay command | Set "1" to activate the external 2DO2 output relay. Note that parameter 11.11 2DO2 function has to be set as "Fieldbus" |
| 011Bh | 284 | 27 | 2DO3 relay command | Set "1" to activate the external 2DO3 output relay. Note that parameter 11.12 2DO3 function has to be set as "Fieldbus" |
| 011Ch | 285 | 28 | Refresh parameters | Restart fieldbus interface to refresh communication parameters |
| 011Dh | 286 | 29 | Spare | |
| 011Eh | 287 | 30 | Spare | |

| Protocol Address | Modicon Address | Bit | Data | Description |
|------------------|-----------------|-----|-------|-------------|
| 011Fh | 288 | 31 | Spare | |

3.6. Analog output telegram

From PLC to the softstarter.

All analog data is represented as 16-bit values.

Use Modbus function code 16 (10h), Write Multiple Registers

| Protocol Address | Modicon Address | Data | Representation |
|------------------|-----------------|--|--|
| 0300h | | | Address offset |
| 0300h | 40769 | FBT Control Word | This register is used to read parameters (see fieldbus tasks) |
| 0301h | 40770 | Fieldbus AO 1 (FBT Argument 2 or Internal analog output) | Parameter 12.37 Fieldbus AO1 decides the use of this register. If set as "FBT Argument 2", it is used to write parameters and set time (see fieldbus tasks). If set as "Internal analog output" this value of this register controls the internal analog output. Note that parameter 10.8 AO type needs to be set as "Fieldbus [%]" |
| 0402h | 40771 | Fieldbus AO 2 (FBT Argument 3 or External analog output) | Parameter 12.38 Fieldbus AO2 decides the use of this register. If set as "FBT Argument 3", it is used to write parameters and set time (see fieldbus tasks). If set as "External analog output" this value of this register controls the external analog output. Note that parameter 11.14 1A00 type needs to be set as "Fieldbus [%]" |

4. Modbus RTU - A set-up example

4.1. Softstarter PST Modbus RTU communication

This document describes an application example between a Modbus RTU master (PLC CPU, PC, etc.) and the ABB softstarter PSTX equipped with an Anybus Modbus-RTU module. In this example the softstarter address is 47.

Please always use the actual softstarter manuals. In this particular example following documents has been used:

Modbus RTU FBP Fieldbus Plug MRP21. FBP technical description 2CDC194001D0203.

Softstarter PSTX Installation and commissioning manual, document 1SFC132081M0201.

4.2. Settings

1. **Set the softstarter address and field bus communication.**

Change the address of the softstarter to 47 (Fieldbus Address) and enable fieldbus control (Fieldbus control = On).

2. **Set the communication parameters.**

The communication parameters are:

1 Start bit, 8 Data bits, the Parity will be adapted to the master.

The baud rate is mapped to the slave address; e.g. the baud rate to the slave 47 is 19200.

Therefore the master and the slave will have the communication parameters:

1 start bit, 1 stop bit, 8 data bit, even parity, 19200 baud.

3. Select the FBP interface.

The previous changes are taken in effect when the fieldbus interface is changed.

Change parameter FB interface connector to FbPlug.

4.3. Read binary input telegram

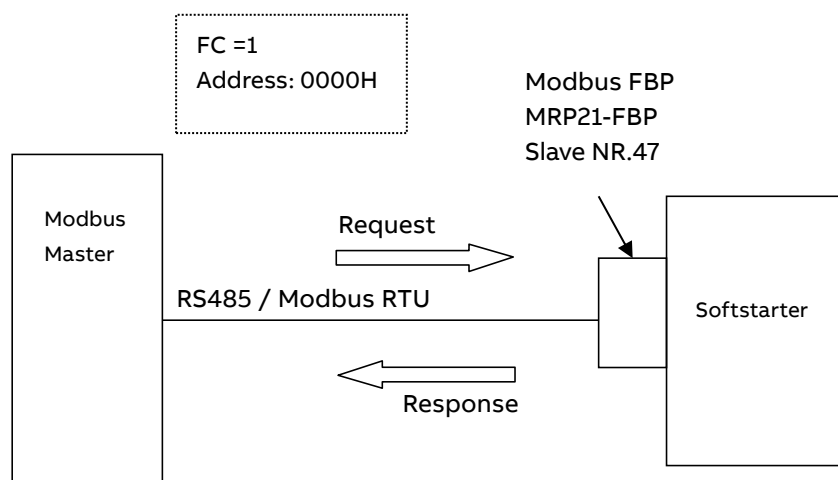

E.g.: Read 16 bit starting at the address: 0000H

Request:

2F 01 00 00 00 10 3B 88

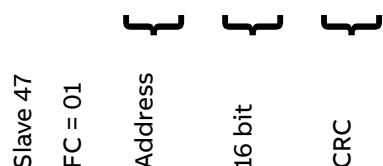

Response:

2F 01 02 00 00 51 FA



4.4. Write binary output telegram

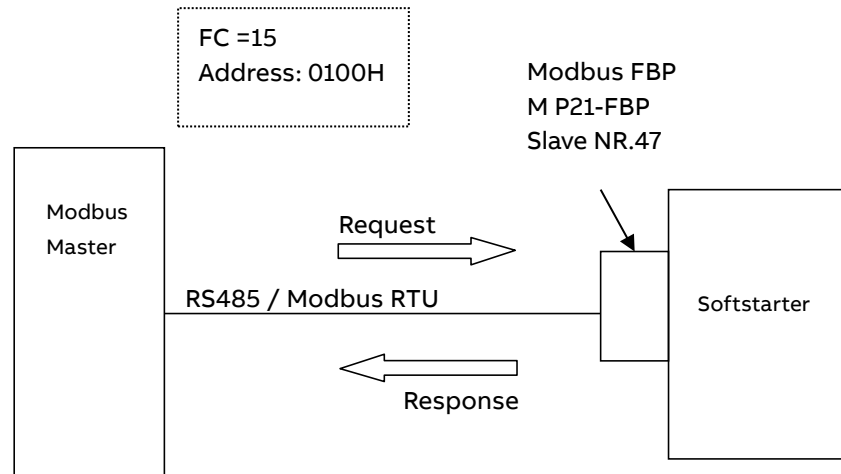

E.g.: Write 16 bit starting at the address: 0100H

Request:

2F 0F 01 00 00 10 02 00 00 27 41



Slave 47
FC = 15
Address
16 bit
2 Byte
Output
CRC

Response:

2F 0F 01 00 00 10 53 B5



Slave 47
 FC = 15
 Address
 16 bit
 CRC

4.5. Read analog input telegram

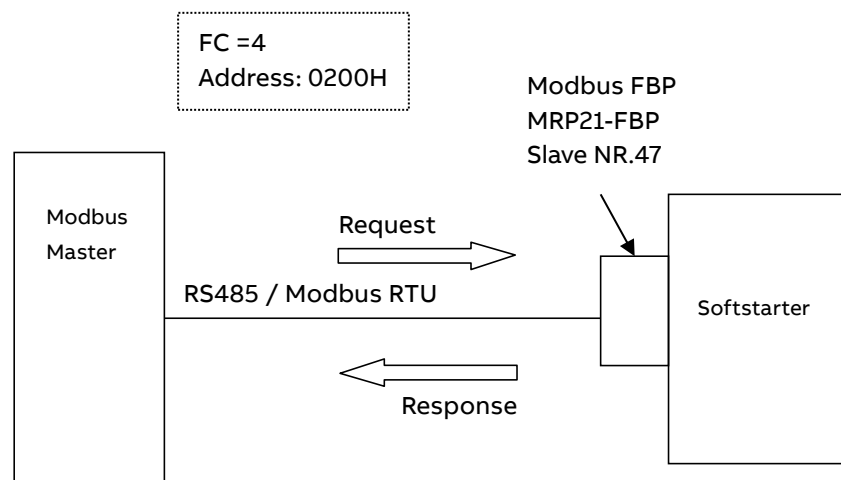

E.g.: Read analog output words 2 & 3. Phase L1 current and Phase L2current with default settings.

Request:

2F 04 02 01 00 02 27 FD



Slave 47
 FC = 04
 Address
 2 words
 Output

Response:

2F 04 04 00 00 00 00 35 86

| | | | | | |
|----------|----------------|-----------------|------|-------|-------|
| STATUS | SECURITY LEVEL | DOCUMENT ID. | REV. | LANG. | PAGE |
| Approved | Public | 1SFC132092M0201 | F | en | 14/32 |

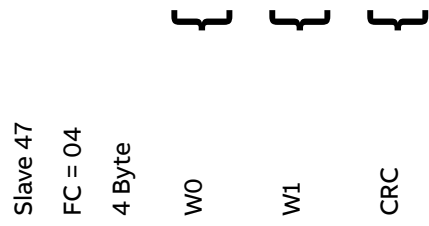

W0: Phase L1 current

W1: Phase L2 current

| STATUS | SECURITY LEVEL | DOCUMENT ID. | REV. | LANG. | PAGE |
|----------|----------------|-----------------|------|-------|-------|
| Approved | Public | 1SFC132092M0201 | F | en | 15/32 |

4.6. Write analog input telegram

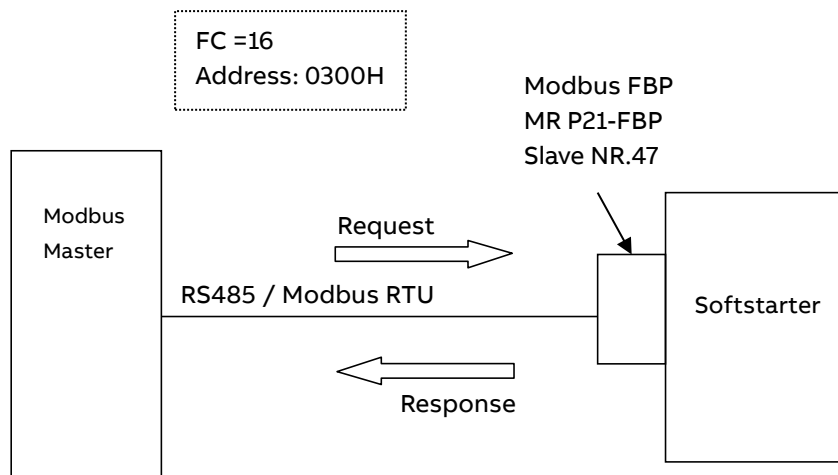

E.g.: Write analog output words 1 & 23. FBT Control Word and FBT Argument 2.

Request:

2F 10 03 00 00 02 04 00 00 00 00 78 77



| | | | | | | | |
|----------|---------|---------|---------|---------|----|----|-----|
| Slave 47 | FC = 16 | Address | 2 words | Address | W0 | W1 | CRC |
|----------|---------|---------|---------|---------|----|----|-----|

W0: FBT Control Word

W1: FBT Argument 2

Response:

2F 10 03 00 00 02 47 C2



| | | | | |
|----------|---------|---------|---------|-----|
| Slave 47 | FC = 16 | Address | 2 words | CRC |
|----------|---------|---------|---------|-----|

5. Fieldbus Tasks

By using Fieldbus Tasks it is possible to read/write parameters and to set the real-time clock.

Which task to execute is selected by filling in the FBT Control Word. There are three signals for arguments to the task:

FBT Argument 1 is packed together with the Task ID in the FBT Control Word.

There are two additional 16-bit arguments in separate analog output signals, FBT Argument 2 and FBT Argument 3.

To control when the task is executed, the digital output signal FBT Toggle Bit shall be changed. The softstarter will detect the change, execute the task, fill in the return values, and toggle the digital input signal FBT Toggle Bit as acknowledgement. Thus, the return values must be disregarded if the two toggle bits have different value.

5.1. FBT Control Word

The control word is a 16-bit analog output value sent from the PLC to the softstarter. It consists of a Task ID and an 11-bit argument packed together.

| | | | |
|-----------|--------------------|-----------|---|
| 15 | 14, 13, 12, | 11 | 10, 9, 8, 7, 6, 5, 4, 3, 2, 1, 0 |
| - | Task ID | - | Argument 1 |

5.2. Task ID

The task identifier controls which function should be performed.

| Task ID | Task | Response ID | |
|---------|-------------------------------------|-------------|----------|
| | | Positive | Negative |
| 0 | No task | 0 | - |
| 1 | Request parameter value, lower word | 1 | 2 |
| 2 | Change parameter value | 1 | 2 |
| 3 | Set date and time | 1 | 2 |
| 4 | Request parameter value, upper word | 1 | 2 |

5.3. Response ID

The response ID is the softstarter response to a task. It tells whether a task was executed successfully. If there was an error, an additional error code is returned in the FBT Return Value analog input. The Response ID is transmitted as two digital input signals, FBT Response 0 and FBT Response 1.

| Response ID | FBT Response 1 | FBT Response 0 | Explanation |
|-------------|----------------|----------------|---|
| 0 | 0 | 0 | No response |
| 1 | 0 | 1 | Task executed |
| 2 | 1 | 0 | Task cannot be executed (with error number) |
| 3 | 1 | 1 | Reserved. |

5.4. Error codes

The following error codes are sent when a task cannot be executed.

| Error code | Explanation |
|------------|-----------------------------------|
| 0 | Illegal parameter number |
| 1 | Parameter value cannot be changed |
| 3 | Lower or upper limit violated |
| 4 | Invalid argument |
| 5 | No error |
| 6 | Invalid task number |

5.5. Request parameter value, lower word

This task reads the lower 16 bits of the specified parameter's value. See chapter 5.9 for parameter number and value scaling information.

5.5.1. Arguments

- FBT Argument 1: parameter number.

5.5.2. Return Value

- Response ID 1 and parameter value in FBT Return Value on success.
- Response ID 2 and error number in FBT Return Value on failure.

5.6. Change parameter value

This task writes a specified value to a parameter. See chapter 5.9 for parameter number and value scaling information.

5.6.1. Arguments

- FBT Argument 1: parameter number.
- FBT Argument 2: parameter value (lower word)
- FBT Argument 3: parameter value (upper word)

5.6.2. Return Value

- Response ID 1 on success.
- Response ID 2 and error number in FBT Return Value on failure.

5.7. Set date and time

This task updates the real-time clock on the softstarter. The date and time fields have the following limits:

- Year: 0-63 (2000-2063)
- Month: 1-12
- Day: 1-31
- Hour: 0-23
- Minute: 0-59
- Second: 0-59

5.7.1. Arguments

FBT Argument 2: year, month, day and least significant bit of seconds.

| | | | |
|-----------|------------------------------|-------------------|----------------------|
| 15 | 14, 13, 12, 11, 10, 9 | 8, 7, 6, 5 | 4, 3, 2, 1, 0 |
| s0 | year | month | day |

FBT Argument 3: hour, minute, seconds, bit 1-5.

| | | |
|---------------------------|--------------------------|----------------------|
| 15, 14, 13, 12, 11 | 10, 9, 8, 7, 6, 5 | 4, 3, 2, 1, 0 |
| Hour | minute | seconds, bit 1-5 |

5.7.2. Return Value

- Response ID 1 on success.
- Response ID 2 and error number in FBT Return Value on failure. In case the supplied time didn't differ from the set time, error code 5 (no error) is used.

5.8. Request parameter value, upper word

This task reads the upper 16 bits of the specified parameter's value. See chapter 5.9 for parameter number and value scaling information.

5.8.1. Arguments

- FBT Argument 1: parameter number.

5.8.2. Return Value

- Response ID 1 and parameter value in FBT Return Value on success.
- Response ID 2 and error number in FBT Return Value on failure.

| | | | | | |
|----------|----------------|-----------------|------|-------|-------|
| STATUS | SECURITY LEVEL | DOCUMENT ID. | REV. | LANG. | PAGE |
| Approved | Public | 1SFC132092M0201 | F | en | 19/32 |

5.9. Parameter numbers and values

To access parameters from the fieldbus a unique parameter number is needed, this can be found in document 1SFC132081M0201, Chapter 7.25 Complete parameter list.

Since the parameter values need to be represented as integers on the fieldbus while, the parameter values with greater precision need to be scaled. In document 1SFC132081M0201, Chapter 7.25 Complete parameter list, there is a column specifying the number of decimals for each parameter.

Parameter values that are read from the fieldbus needs to be divided by $10^{\text{numbers of decimals}}$.

Parameter values that are written from the fieldbus needs to be multiplied by $10^{\text{numbers of decimals}}$.

For example:

The parameter Kick start time has parameter number 24 and 2 decimals. To read this parameter:

1. Set FBT Task ID to 1.
2. Set FBT Argument 1 to 24 to specify the parameter.
3. Toggle FBT Toggle Bit output and wait for the FBT Toggle Bit input to update.
4. Response ID 1 should now contain value 1, indicating success.
5. FBT Return Value contains the value 50 (this is an example and depends on the actual value set).
6. The return value should be interpreted as $50/10^2 = 0.5s$.

To change the Kick start time parameter to 1s:

1. Set FBT Task ID to 2 for Change parameter value.
2. Set FBT Argument 1 to 24 to specify the parameter.
3. Set FBT Argument 2 to $1 \cdot 10^2 = 100$.
4. Set FBT Argument 3 to 0 as $100 \leq 65535$ which means it doesn't require more than 16 bits.
5. Toggle FBT Toggle Bit output and wait for the FBT Toggle Bit input to update.
6. Response ID 1 should now contain value 1, indicating success.

5.9.1. Negative values

Negative values are represented internally using 32-bit two's complement numbers.

Example:

Setting parameter 17.5 PT100 reset temp (parameter number 249) to a value of -25°C:

The two's complement of -25 is FFFFFFFE_{hex}. The upper word is FFFF_{hex} and the lower FFE7_{hex}, in decimal notation 65535 and 65511.

1. Set FBT Task ID to 2 for Change parameter value.
2. Set FBT Argument 1 to 249 to specify the parameter.
3. Set FBT Argument 2 to 65511 to specify the lower word.
4. Set FBT Argument 3 to 65535 to specify the upper word.
5. Toggle FBT Toggle Bit output and wait for the FBT Toggle Bit input to update.
6. Response ID 1 should now contain value 1, indicating success.

| STATUS | SECURITY LEVEL | DOCUMENT ID. | REV. | LANG. | PAGE |
|----------|----------------|-----------------|------|-------|-------|
| Approved | Public | 1SFC132092M0201 | F | en | 20/32 |

6. Example application with Automation Builder

This section shows a demo about how to start and stop motor by sending commands from fieldbus that is controlled by Programmable logic controller (PLC). We use Automation Builder as an example platform and show the demo about building such communication setting.

6.1. Create a new project in Automation Builder

We perform the following steps in Automation Builder 2.1 for PLC AC500 PM573.

1. Open Automation Builder
2. Select File->New Project->AC500 project->OK
3. Select the correct PLC CPU in Search object name ...-> Add PLC

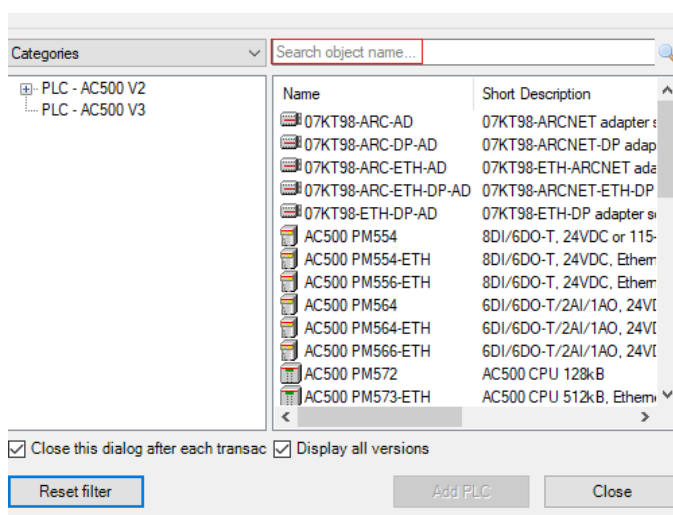

4. Check that the correct device type is selected by double clicking the device name in Devices field. Check that the correct Terminal Base Type is also selected for the tag for Hardware.

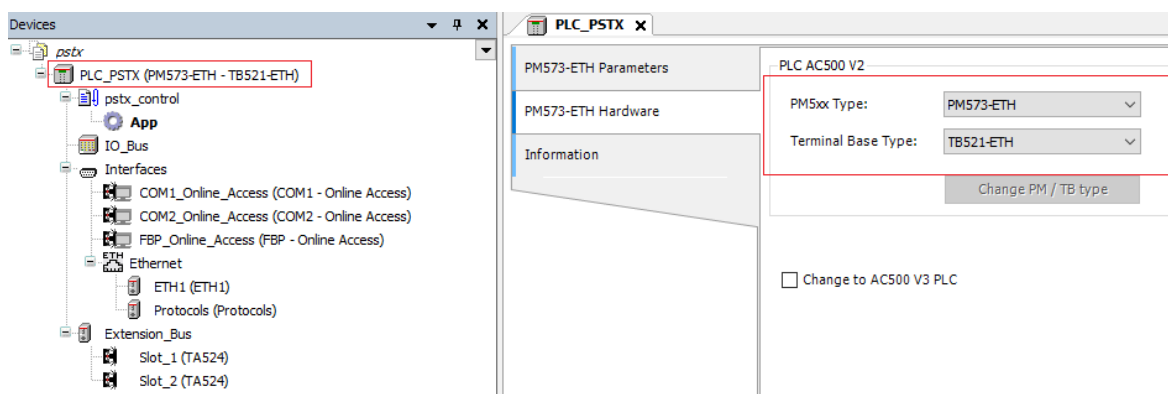

| | | | | | |
|----------|----------------|-----------------|------|-------|-------|
| STATUS | SECURITY LEVEL | DOCUMENT ID. | REV. | LANG. | PAGE |
| Approved | Public | 1SFC132092M0201 | F | en | 21/32 |

6.2. Add Modbus RTU master to project

1. Right click on one of the comports and select Add object

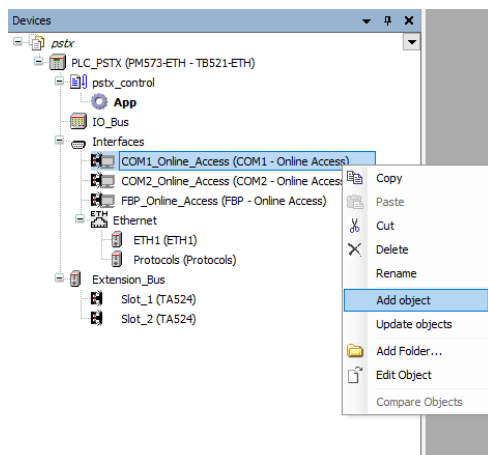

2. Select COM1 - Modbus and click Replace object

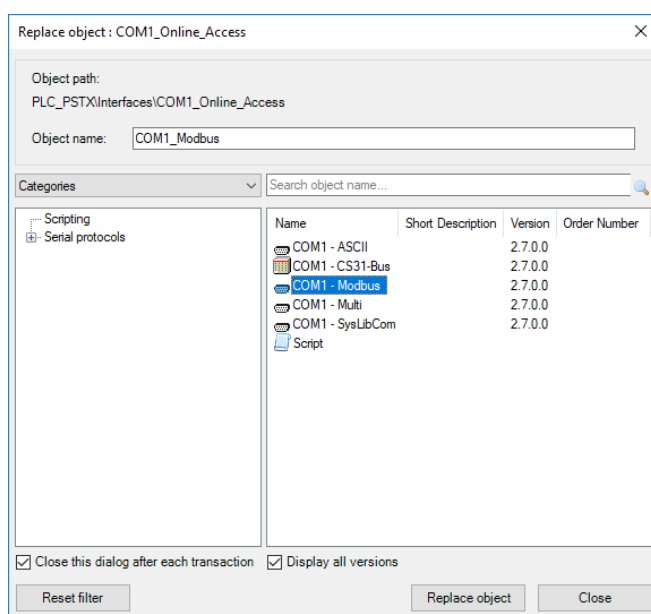

3. Double click interfaces, COM1_Modbus, from the device tree. Set RTS control to Telegram and Operation mode to Client for COM1 – Modbus Parameters in COM1_Modbus

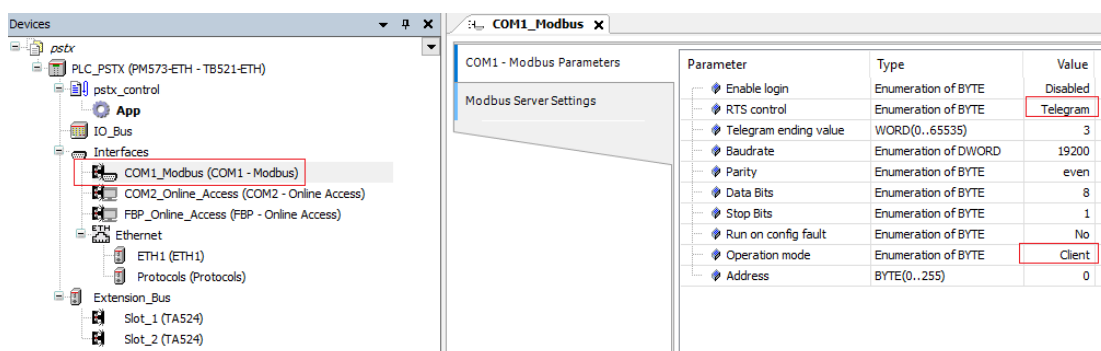

6.3. Build a START-STOP program

We perform the following steps for building our start-stop demo program in CoDeSys.

1. Open CoDeSys by double clicking your application in Devices file in Automation Builder, if it is not opened yet.

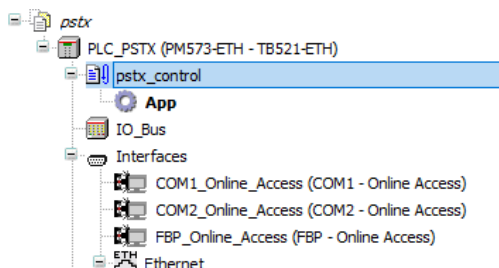

2. Delete the default POU by right click on it and select.

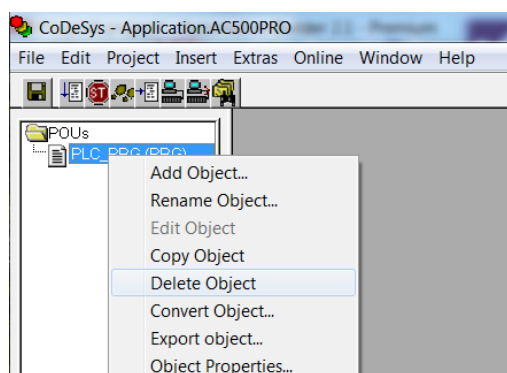

3. We choose to use LD as the language of the POU here by right click POU's -> Add Object... -> Insert Name of the new POU -> Choose "LD" for "Language of the POU" -> OK.

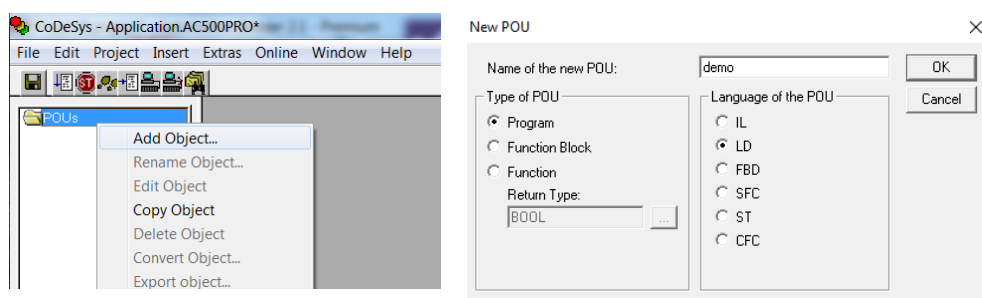

4. Open the newly created POU by double click it and select the first network, create a contact (by CTRL+K) and two coils (by CTRL+L).

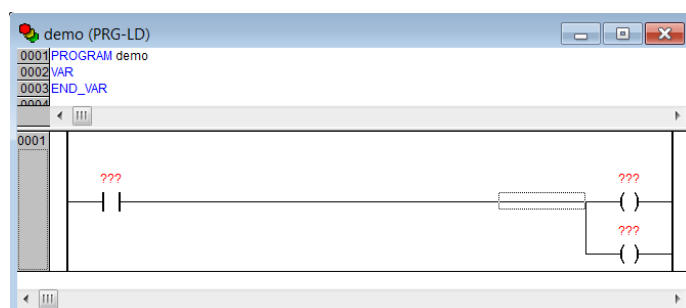

5. Name the contact START by changing the ??? to START, select type BOOL.

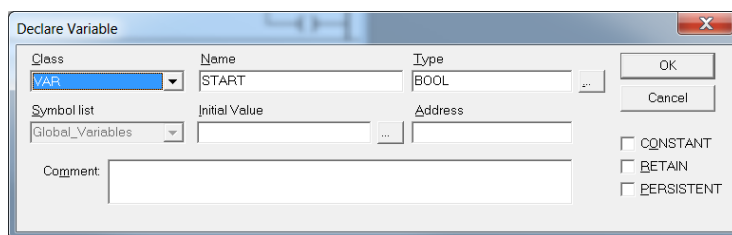

6. Name the coils "BITVAL[1]" and "BITVAL[2]", set the type to "ARRAY [1..16] OF BOOL".

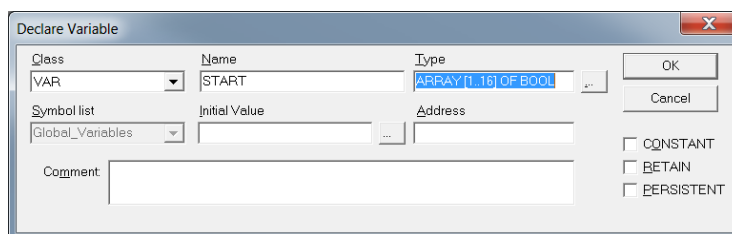

7. Add a second network by CTRL+T and add a single coil (by CTRL+L) named "BITVAL[4]"

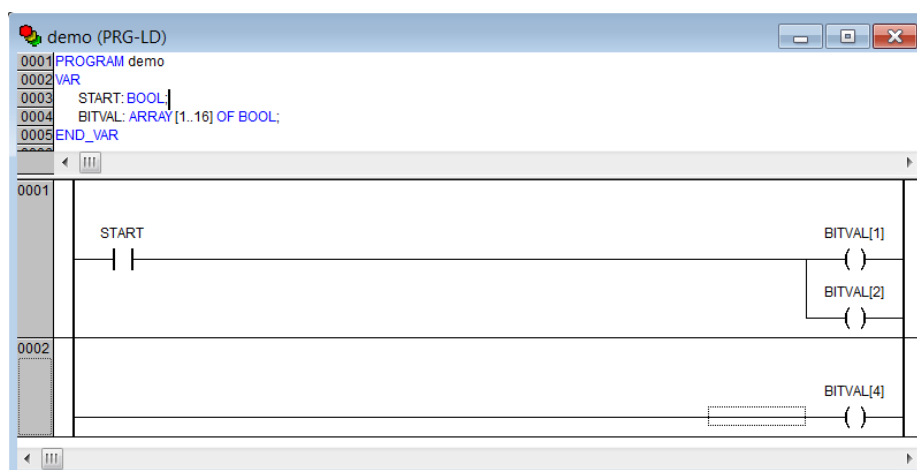

8. Add another network by CTRL+T. Create a function block "BLINK" by CTRL+B and select Standard Function Blocks -> Util.lib -> signals-> BLINK(FB)->Ok.

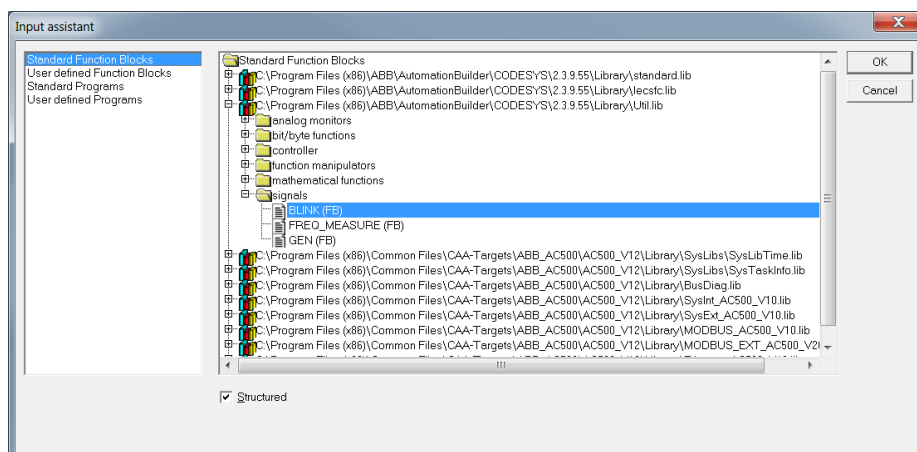

| STATUS | SECURITY LEVEL | DOCUMENT ID. | REV. | LANG. | PAGE |
|----------|----------------|-----------------|------|-------|-------|
| Approved | Public | 1SFC132092M0201 | F | en | 24/32 |

9. We name the BLINK function block as blink. We set t#2ms for TIMELOW and TIMEHIGH.

10. Continue to create a function block “COM_MOD_MAST” by CTRL+B and select Standard Function Blocks -> MODBUS_AC500_V10.LIB -> COM_MOD_MAST(FB) -> OK.

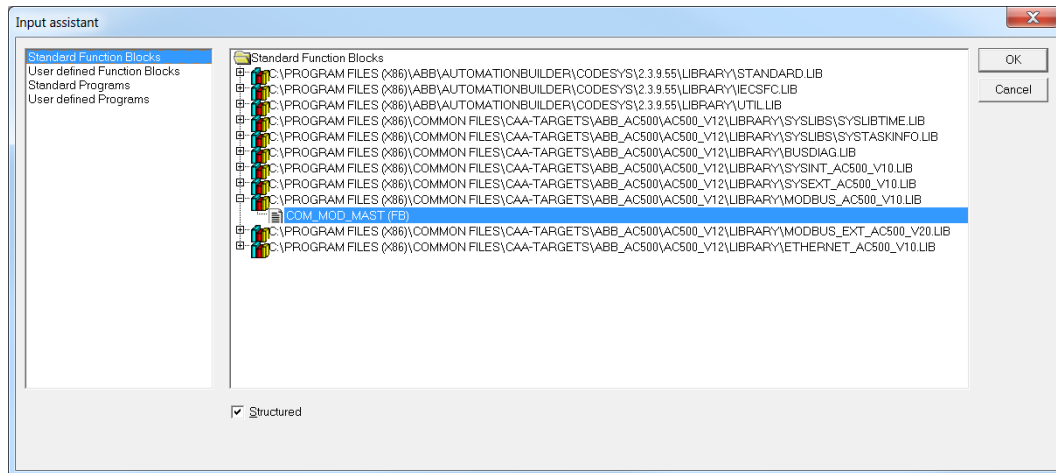

Now, we should have two function blocks in network 0003.

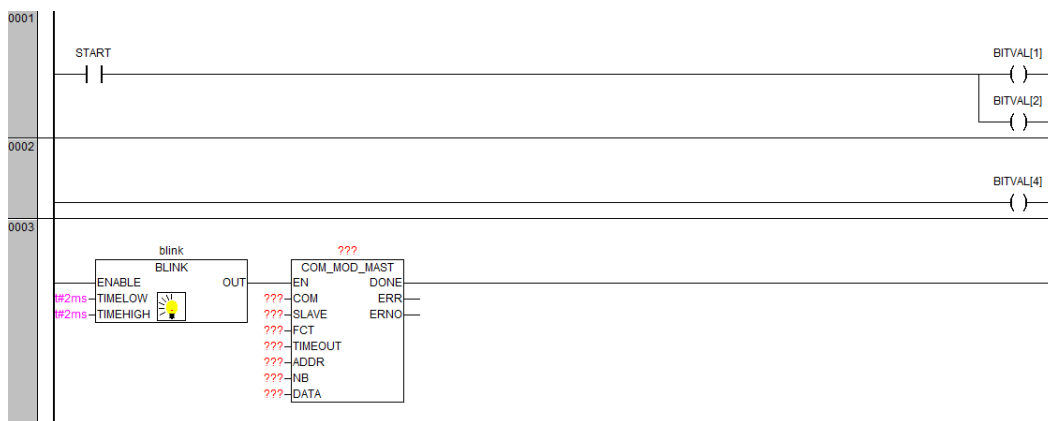

The COM_MOD_MAST is a function block for sending/receiving OpenModbus. Their definition is available from CoDeSys -> Resources -> Library Manager.

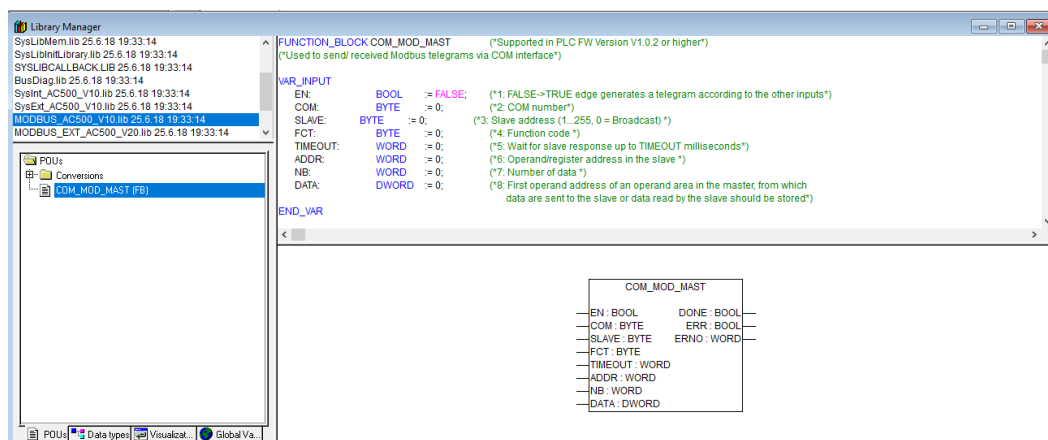

To enable this function block, it is required to send a FALSE->TRUE edge at input EN and therefore we introduce BLINK, which is for creating a flip-flop signal.

11. DATA (the data to send) require DWORD inputs. We can convert data with a box, "ADR".

a) Select the bar in front of DATA.

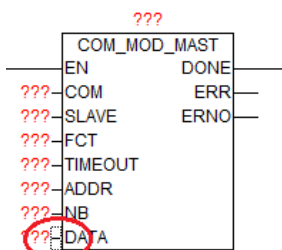

b) Choose Insert-> Insert at Blocks-> Box.

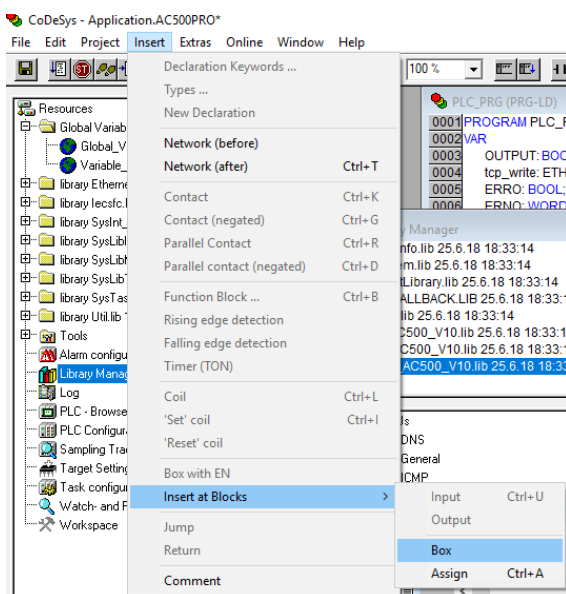

The default box is "AND", change the name to ADR and it will be a ADR box.

12. Set:

- The name of the block to modbus_write.
- COM to 1 or 2 depending on comport used.
- Slave to the value of "Fieldbus address" (Parameter 12.4 in PSTX), note that this affects the baud rate.
- FCT to 15.
- TIMEOUT to 100.
- ADDR to 256, according to Section 3.5, the first Protocol Address is 0100h.
- NB to 16.
- ERR to ERRO (new BOOL variable).
- ERRNO (new WORD variable).

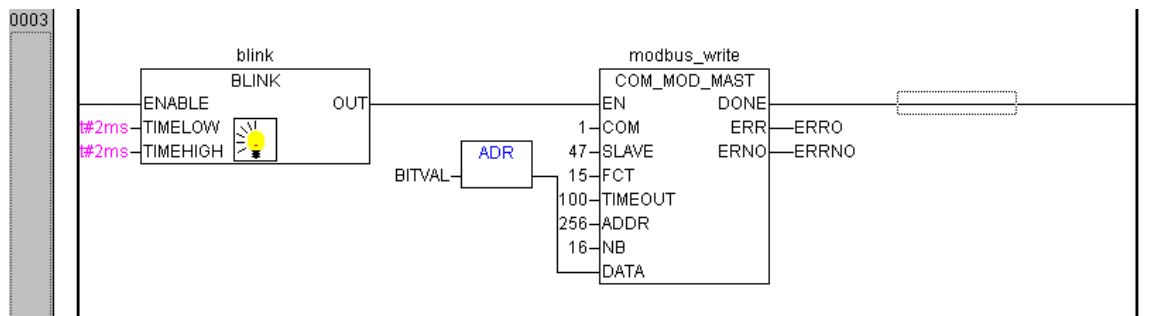

13. Insert a coil named "OUTPUT" in the last network and the LD-program is done.

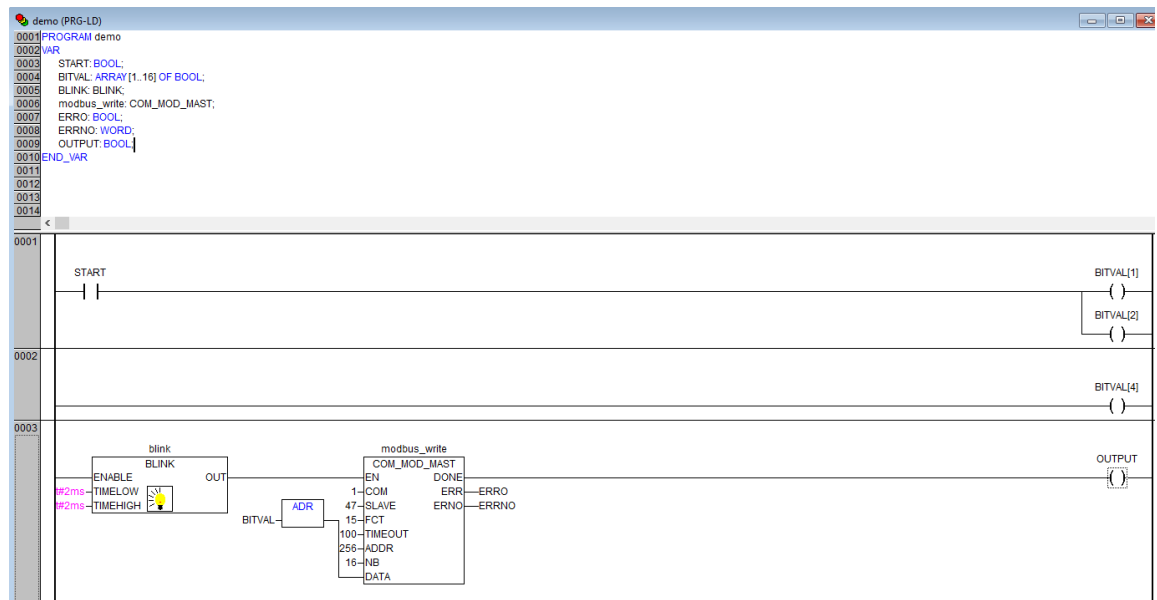

14. Now we want to create one control button for signing the value of “START” from the first network into TRUE. We do this by Visualization -> right click -> Add object -> Write name of the new Visualization as “view” -> OK.

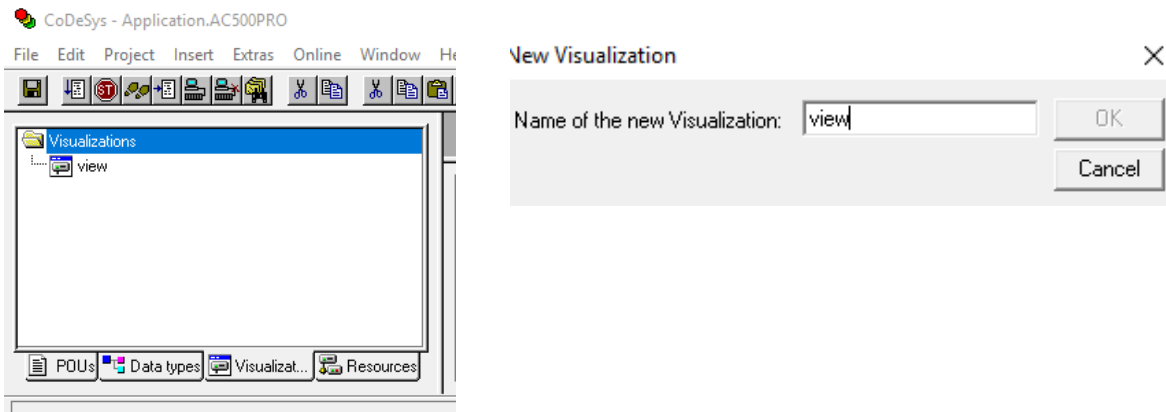

15. We draw a shape as the button  -> double click the shape -> Regular Element Configuration -> Input -> check Toggle variable -> insert “demo.START” ->OK.

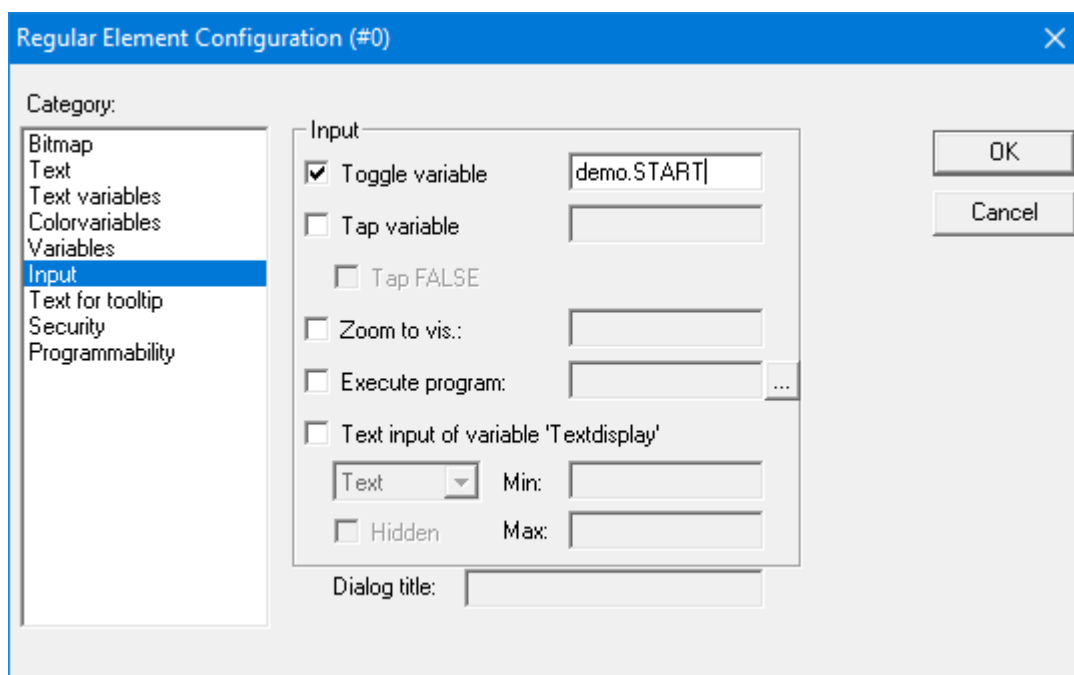

16. We configure this program into task configuration by Resource -> Task configuration -> Right click Task configuration -> Append Task -> Insert t#10ms in Properties in Taskattributes. Then we need to sign our program to this task by right click NewTask-> Append Program Call-> Choose demo(PRG) by clicking the select button in Program Call ->OK.

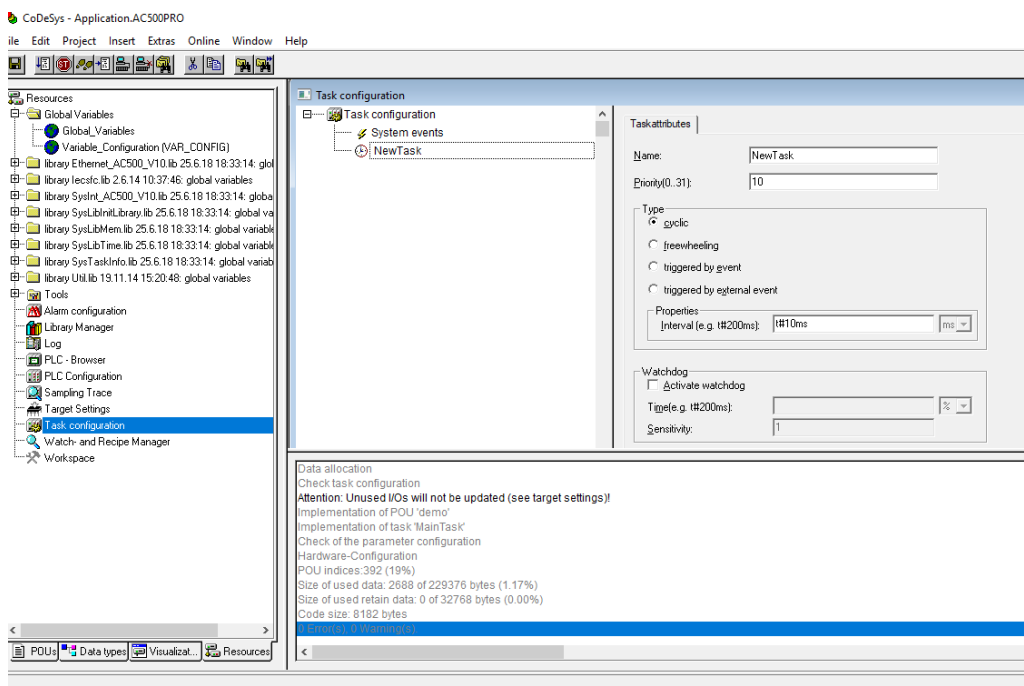

17. Right click on the NewTask and select Append Program Call.

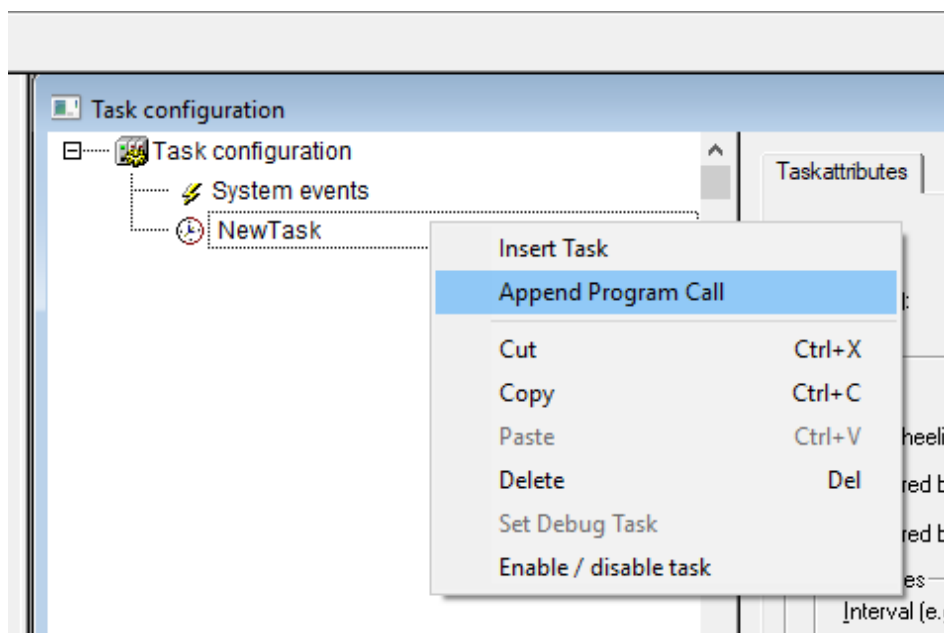

| STATUS | SECURITY LEVEL | DOCUMENT ID. | REV. | LANG. | PAGE |
|----------|----------------|-----------------|------|-------|-------|
| Approved | Public | 1SFC132092M0201 | F | en | 29/32 |

18. Select the demo program call.

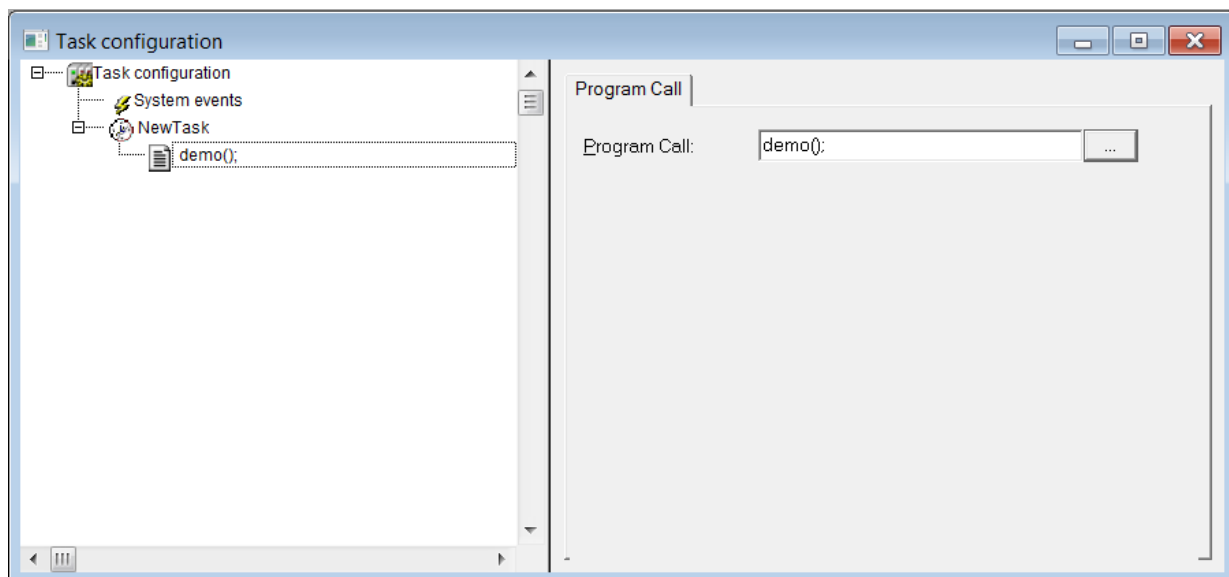

19. Now we can build the project by Project -> Build. Check again if fieldbus is connected correctly. We can then run the program by pressing ALT+F8 and then F5.

6.4. Connect to PLC using TCP/IP

1. Control the IP address for the device is also correct by right click the device name and then chose communication setting. The IP address should be the address of PLC CPU device.

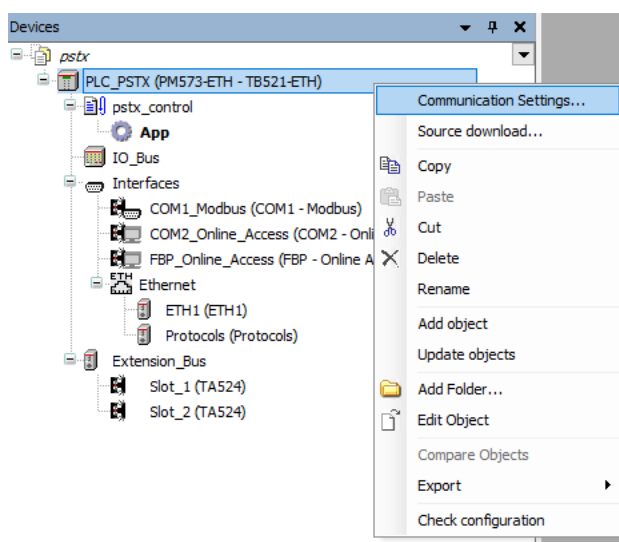

2. Control that the IP address for PC and the PLC is in the same network but not the same IP address. This can be checked by using through Ethernet Properties.
3. Click the icon “Login”, for building the configuration and checking if configuration is correct.

- If the configuration is correct, a program for building PLC should be opened in the PLC environment, CoDeSys. Automation Builder will ask for downloading PLC configuration. Choose "Update". Automation Builder will confirm that the program has changed.

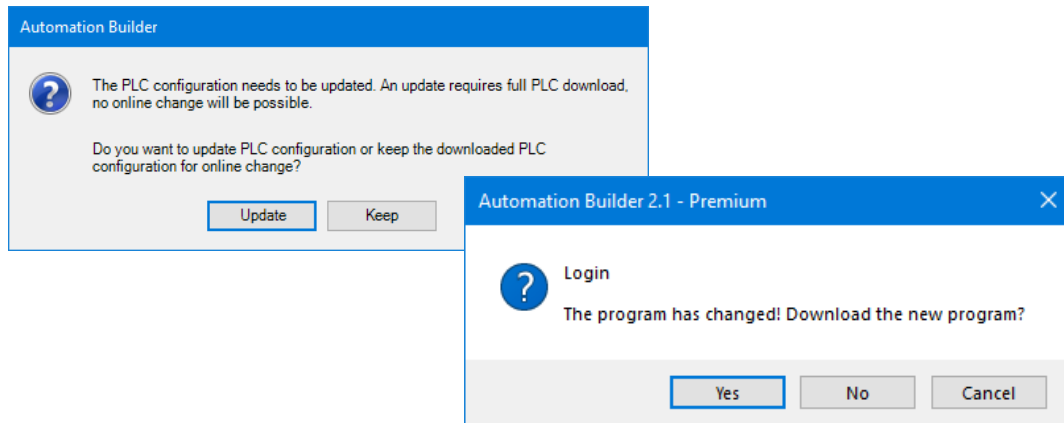

6.5. Build and run the PLC demo program

Use the key, F11, to build the program once. Login and start project from Automation Builder by clicking Alt+F8 to login the CodeSys. Click yes to login

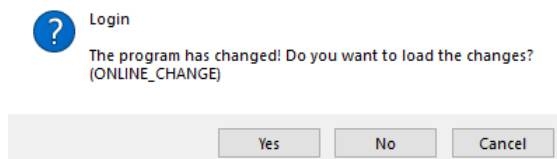

Click F5 to start. Switch to CoDeSys and click Alt+F8 to login demo. The program can be controlled with the view from CodeSys

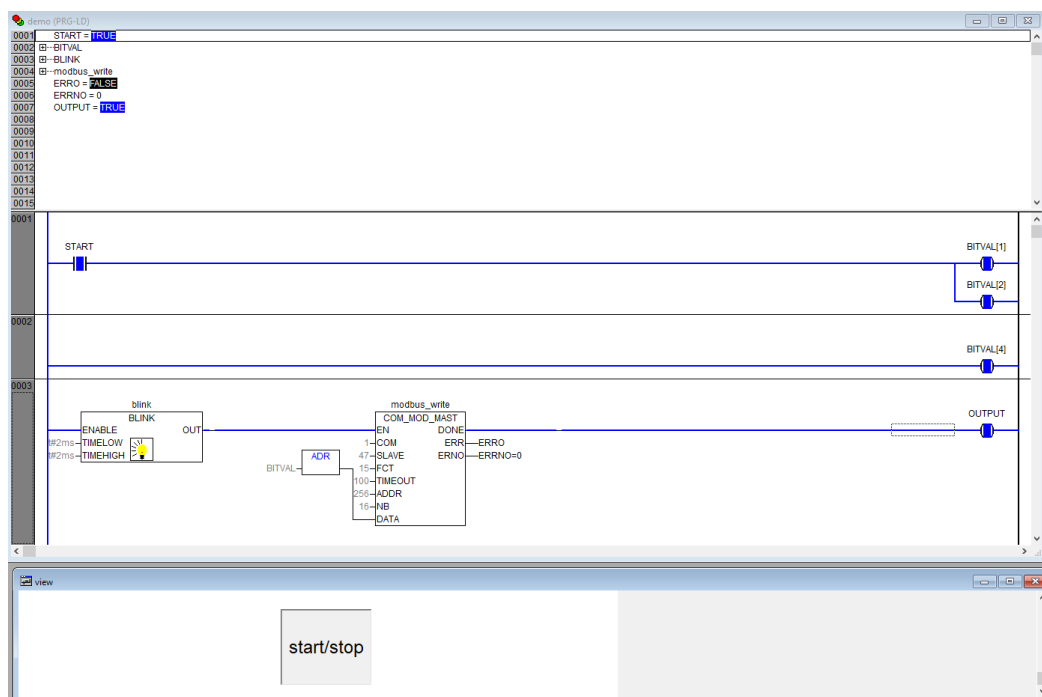

| STATUS | SECURITY LEVEL | DOCUMENT ID. | REV. | LANG. | PAGE |
|----------|----------------|-----------------|------|-------|-------|
| Approved | Public | 1SFC132092M0201 | F | en | 31/32 |

7. Contact us

For more information, please contact your local ABB representative or visit <https://solutions.abb/softstarters>

| STATUS | SECURITY LEVEL | DOCUMENT ID. | REV. | LANG. | PAGE |
|----------|----------------|-----------------|------|-------|-------|
| Approved | Public | 1SFC132092M0201 | F | en | 32/32 |