

Multifunctional three-phase monitoring relays CM-MPN

CM-MPN.52, CM-MPN.62 and CM-MPN.72

The three-phase monitoring relays CM-MPN.x2 monitor the phase parameters phase sequence, phase failure, over- and undervoltage as well as phase unbalance.

All devices are available with two different terminal versions. You can choose between the proven screw connection technology (double-chamber cage connection terminals) and the completely tool-free Easy Connect Technology (push-in terminals).



2CDC251062 V0011

Characteristics

- Monitoring of three-phase mains for phase sequence (can be switched off), phase failure, over- and undervoltage as well as phase unbalance
- TRMS measuring principle
- Automatic phase sequence correction configurable
- Threshold values for over- and undervoltage as well as phase unbalance are adjustable as absolute values
- Tripping delay T_V can be adjusted or switched off by means of a logarithmic scale (0 s; 0,1-30 s)
- ON-delayed or OFF-delayed tripping delay selectable
- Powered by the measuring circuit
- Precise adjustment by front-face operating controls
- Screw connection technology or Easy Connect Technology available
- Housing material for highest fire protection classification UL 94 V-0
- Tool-free mounting on DIN rail as well as demounting
- 1 x 2 or 2 x 1 c/o (SPDT) contacts configurable
- 45 mm (1.78 in) width
- 3 LEDs for the indication of operational states

Order data

Three-phase monitoring relays

Type	Rated control supply voltage = measuring voltage	Connection technology	Order code
CM-MPN.52P	3 x 350-580 V AC	Push-in terminals	1SVR760487R8300
CM-MPN.52S		Screw terminals	1SVR750487R8300
CM-MPN.62P	3 x 450-720 V AC	Push-in terminals	1SVR760488R8300
CM-MPN.62S		Screw terminals	1SVR750488R8300
CM-MPN.72P	3 x 530-820 V AC	Push-in terminals	1SVR760489R8300
CM-MPN.72S		Screw terminals	1SVR750489R8300

Accessories

Type	Description	Order code
ADP.02	Adapter for screw mounting	1SVR440029R0100
MAR.12	Marker label for devices with DIP switches	1SVR730006R0000
COV.12	Sealable transparent cover	1SVR750005R0100

Connection technology

Maintenance free Easy Connect Technology with push-in terminals

Type designation CM-xxS.yyP

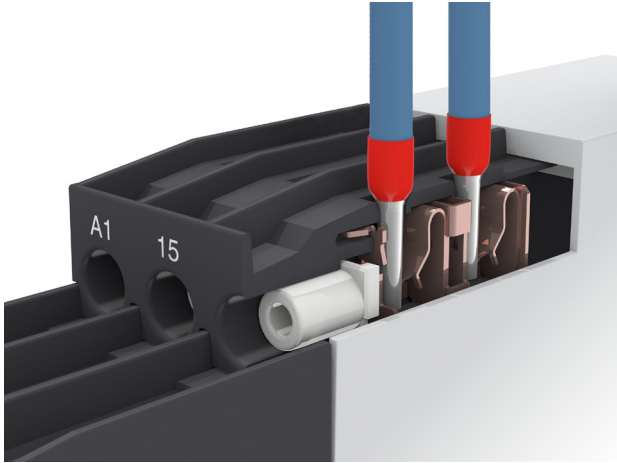

Push-in terminals

- Tool-free connection of rigid and flexible wires with wire end ferrule
- Easy connection of flexible wires without wire end ferrule by opening the terminals
- No retightening necessary
- One operation lever for opening both connection terminals
- For triggering the lever and disconnecting of wires you can use the same tool (Screwdriver according to DIN ISO 2380-1 Form A 0.8 x 4 mm (0.0315 x 0.157 in), DIN ISO 8764-1 PZ1 \varnothing 4.5 mm (0.177 in))
- Constant spring force on terminal point independent of the applied wire type, wire size or ambient conditions (e. g. vibrations or temperature changes)
- Opening for testing the electrical contacting
- Gas-tight

Approved screw connection technology with double-chamber cage connection terminals

Type designation CM-xxS.yyS

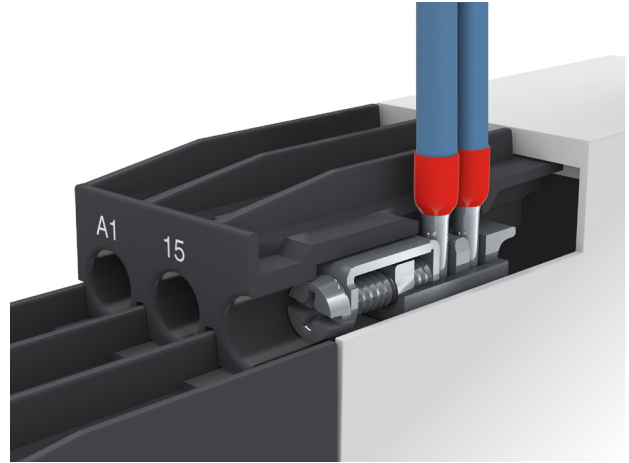

Double-chamber cage connection terminals

- Terminal spaces for different wire sizes
- One screw for opening and closing of both cages
- Pozidrive screws for pan- or crosshead screwdrivers according to DIN ISO 2380-1 Form A 0.8 x 4 mm (0.0315 x 0.157 in), DIN ISO 8764-1 PZ1 \varnothing 4.5 mm (0.177 in)

Both the Easy Connect Technology with push-in terminals and screw connection technology with double-chamber cage connection terminals have the same connection geometry as well as terminal position.

Functions

Operating controls

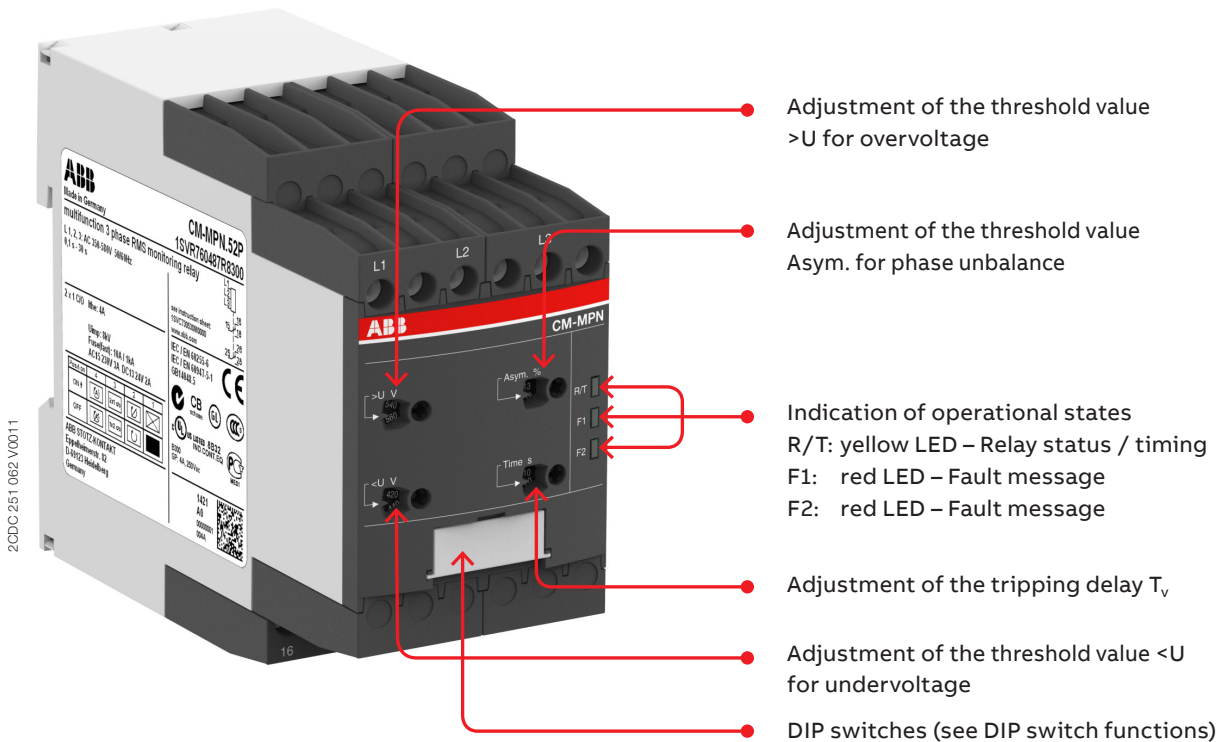

Application

The three-phase monitoring relays CM-MPN.x2 are designed for use in three-phase mains for monitoring the phase parameters phase sequence, phase failure, over- and undervoltage as well as phase unbalance.

The CM-MPN.x2 provide an adjustable tripping delay and work according to the closed-circuit principle.

Operating mode

The CM-MPN.x2 have 2 c/o (SPDT) contacts and are available for 3-wire AC systems. The units are adjusted with front-face operating controls. The selection of ON- or OFF- delay, phase sequence monitoring activated or phase sequence monitoring deactivated , 2 x 1 c/o or 1 x 2 c/o (SPDT) contacts as well as automatic phase sequence correction activated or automatic phase sequence correction deactivated is made with DIP switches. Potentiometers, with direct reading scale, allow the adjustment of the threshold values for overvoltage ($>U$), undervoltage ($<U$), phase unbalance (Asym %) and the tripping delay T_v . The tripping delay T_v is adjustable with a range from instantaneous to a 30 s delay. Timing is displayed by a flashing yellow LED labelled R/T.

Adjustment potentiometer

Threshold values

By means of three separate potentiometers with direct reading scales, the threshold values for over- and undervoltage as well as for phase unbalance can be adjusted within the measuring range.













	Measuring range for overvoltage	Measuring range for undervoltage	Measuring range for phase unbalance
CM-MPN.52	3 x 480-580 V AC	3 x 350-460 V AC	2-25 % of average of phase voltages
CM-MPN.62	3 x 600-720 V AC	3 x 450-570 V AC	
CM-MPN.72	3 x 690-820 V AC	3 x 530-660 V AC	

Tripping delay T_v

The tripping delay T_v can be adjusted within a range of 0.1 to 30 s by means of a potentiometer with logarithmic scale. By turning to the left stop, the tripping delay can be switched off.

Indication of operational states

LEDs, status information and fault messages

Operational state	R/T: LED yellow	F1: LED red	F2: LED red
Control supply voltage applied, output relay energized		-	-
Tripping delay T_v active		-	-
Phase failure	-		
Phase sequence	-	 alternating	
Overvoltage	-		-
Undervoltage	-	-	
Phase unbalance	-		
Adjustment error ¹⁾			

¹⁾

Possible misadjustments of the front-face operating controls:

Overlapping of the threshold values: The threshold value for overvoltage is set to a smaller value than the threshold value for undervoltage.

DIP switch 3 = OFF and DIP switch 4 = ON: Automatic phase sequence correction is activated and selected operating mode is 1 x 2 c/o (SPDT) contacts.

DIP switch 2 and 4 = ON: Phase sequence detection is deactivated and the automatic phase sequence correction is activated.

Function descriptions / diagrams

Phase sequence and phase failure monitoring

Applying control supply voltage begins the fixed start-up delay T_s . When T_s is complete and all phases are present with correct voltage, the output relays energize and the yellow LED R/T is on.

Phase sequence monitoring

If phase sequence monitoring is activated (DIP switch 2 = OFF), the output relays de-energize as soon as a phase sequence error occurs. The fault is displayed by alternated flashing of the LEDs F1 and F2. The output relays re-energize automatically as soon as the phase sequence is correct again.

If phase sequence monitoring is deactivated (DIP switch 2 = ON), a phase sequence error will not cause tripping of the relays. The output relays do not change state and the LEDs F1 and F2 don't flash.

Phase failure monitoring:

The output relays de-energize instantaneously if a phase failure occurs. The fault is indicated by lighting up of LED F1 and flashing of LED F2. The output relays re-energize automatically as soon as the voltage returns to the tolerance range.

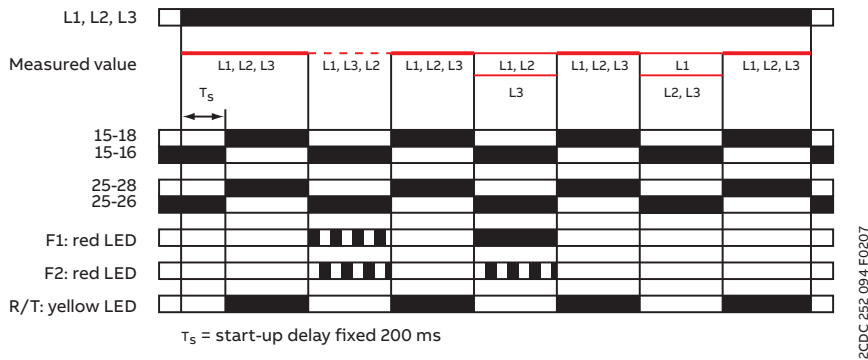

Over- and undervoltage monitoring 1 x 2 c/o (SPDT) contacts 1x2 c/o

Applying control supply voltage begins the fixed start-up delay T_s . When T_s is complete and all phases are present with correct voltage and with correct phase sequence, the output relays energize and the yellow LED R/T is on.

Type of tripping delay = ON-delay

If the voltage to be monitored exceeds or falls below the set threshold value, the output relays de-energize after the set tripping delay T_v is complete. The LED R/T flashes during timing and turns off as soon as the output relays de-energize.

The output relays re-energize automatically as soon as the voltage returns to the tolerance range, taking into account a fixed hysteresis of 5 %. The LED R/T is on.

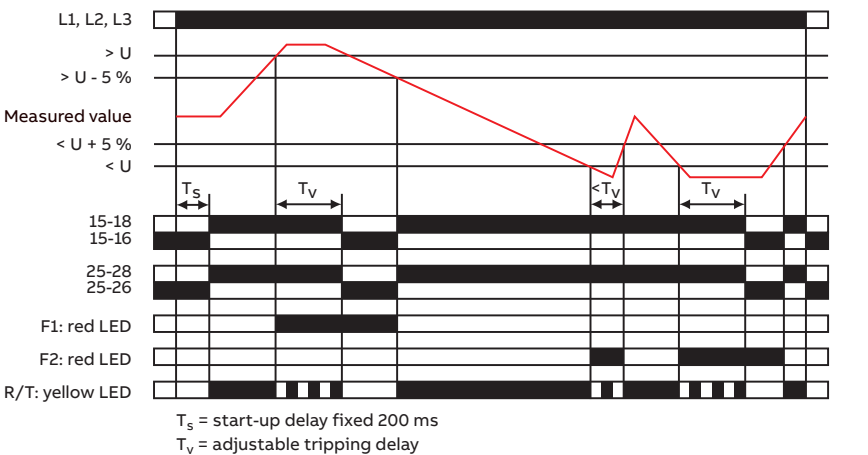

Type of tripping delay = OFF-delay ■

If the voltage to be monitored exceeds or falls below the set threshold value, the output relays de-energize instantaneously and the LED R/T turns off.

As soon as the voltage returns to the tolerance range, taking into account a fixed hysteresis of 5 %, the output relays re-energize automatically after the set tripping delay T_v is complete. The LED R/T flashes during timing and turns steady when timing is complete.

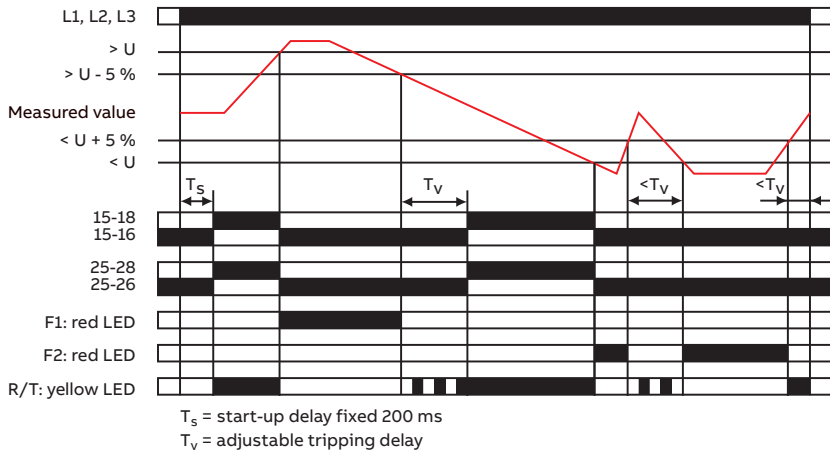

2CDC 252 091 F0207

Over- and undervoltage monitoring 2 x 1 c/o (SPDT) contacts 2x1 c/o

Applying control supply voltage begins the fixed start-up delay T_s . When T_s is complete and all phases are present with correct voltage and with correct phase sequence, the output relays energize. The yellow LED R/T is on as long as at least one output relay is energized.

Type of tripping delay = ON-delay ☒

If the voltage to be monitored exceeds or falls below the set threshold value, output relay R1 (overvoltage) or output relay R2 (undervoltage) de-energizes after the set tripping delay T_v is complete. The LED R/T flashes during timing.

The corresponding output relay re-energizes automatically as soon as the voltage returns to the tolerance range, taking into account a fixed hysteresis of 5 %.

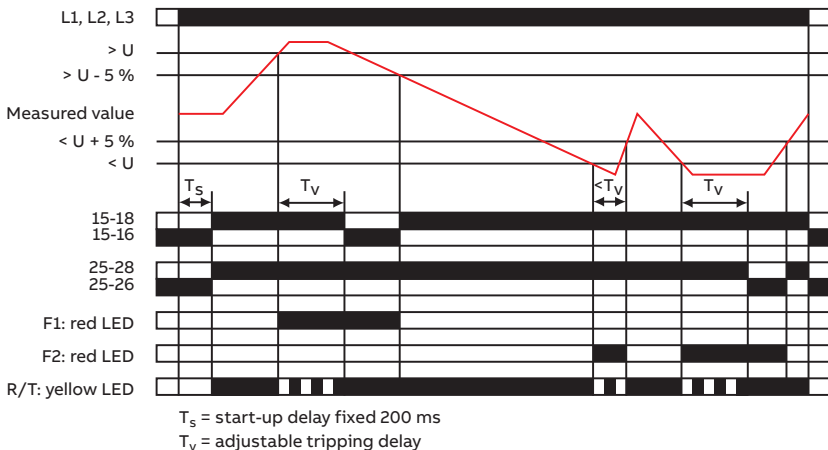

2CDC 252 006 F0207

Type of tripping delay = OFF-delay ■

If the voltage to be monitored exceeds or falls below the set threshold value, output relay R1 (overvoltage) or output relay R2 (undervoltage) de-energizes instantaneously.

As soon as the voltage returns to the tolerance range, taking into account a fixed hysteresis of 5 %, the corresponding output relay re-energizes automatically after the set tripping delay T_v is complete. The LED R/T flashes during timing.

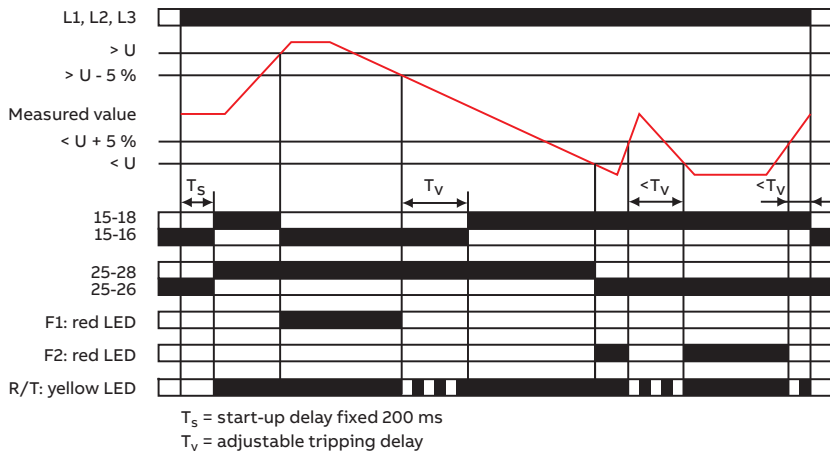

Phase unbalance monitoring

Applying control supply voltage begins the fixed start-up delay T_s . When T_s is complete and all phases are present with correct voltage and with correct phase sequence, the output relays energize and the yellow LED R/T is on.

Type of tripping delay = ON-delay

If the voltage to be monitored exceeds or falls below the set phase unbalance threshold value, the output relays de-energize after the set tripping delay T_v is complete. The LED R/T flashes during timing and turns off as soon as the output relays de-energize.

The output relays re-energize automatically as soon as the voltage returns to the tolerance range, taking into account a fixed hysteresis of 20 %. The LED R/T is on.

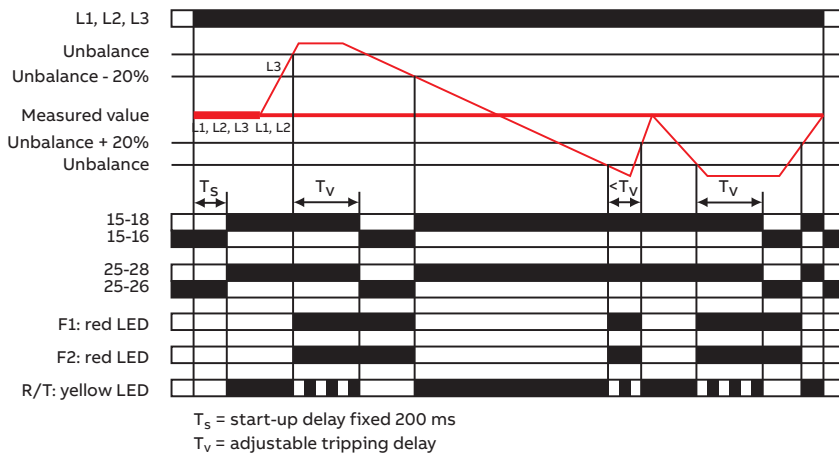

Type of tripping delay = OFF-delay

If the voltage to be monitored exceeds or falls below the set phase unbalance threshold value, the output relays de-energize instantaneously and the LED R/T turns off.

As soon as the voltage returns to the tolerance range, taking into account a fixed hysteresis of 20 %, the output relays re-energize automatically after the set tripping delay T_V is complete. The LED R/T flashes during timing and turns steady when timing is complete.

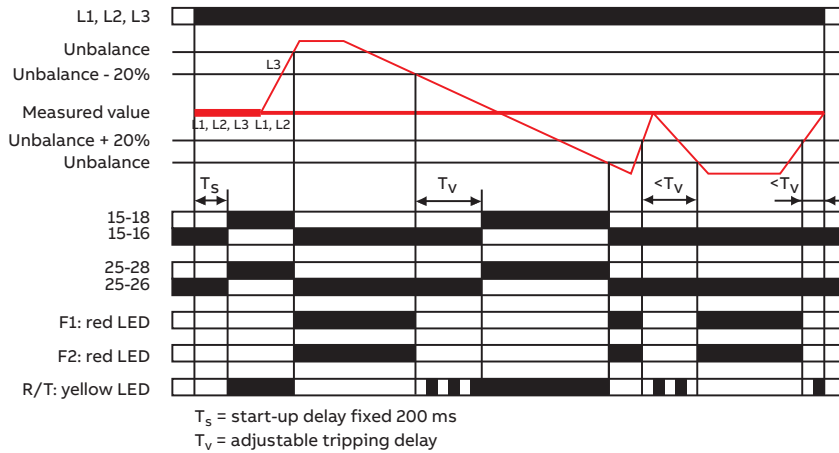

2CDC 252 093 F0207

Automatic phase sequence correction

This function can be selected only if phase sequence monitoring is activated (DIP switch 2 = ON) and operating mode 2 x 1 c/o (SPDT) contact is selected (DIP switch 3 = OFF).

Applying control supply voltage begins the fixed start-up delay T_{s1} . When T_{s1} is complete and all phases are present with correct voltage, output relay R1 energizes. Output relay R2 energizes when the fixed start-up delay T_{s2} is complete and all phases are present with correct phase sequence. Output relay R2 remains de-energized if the phase sequence is incorrect. If the voltage to be monitored exceeds or falls below the set threshold values for phase unbalance, over- or undervoltage or if a phase failure occurs, output relay R1 de-energizes and the LEDs F1 and F2 indicate the fault. Output relay R2 is responsive only to a false phase sequence. In conjunction with a reversing contactor combination, this enables an automatic correction of the rotation direction. See circuit diagrams.

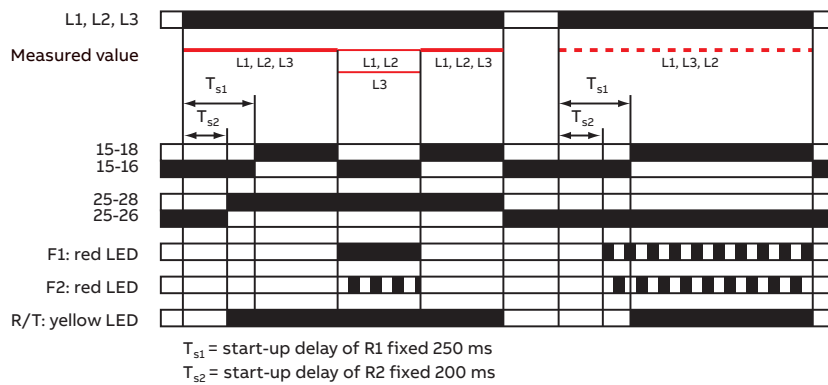

2CDC 252 085 F0107

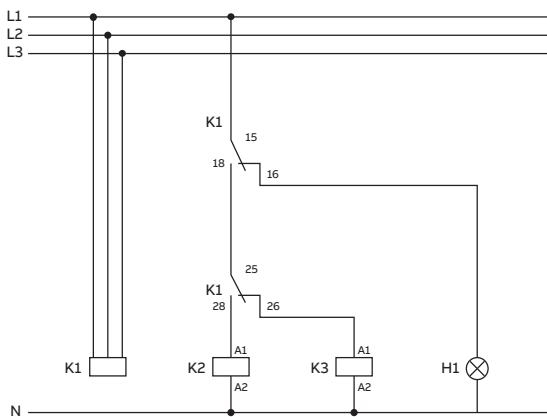

2CDC 253 009 F0014

Control circuit diagram (K1 = CM-MPN.x2)

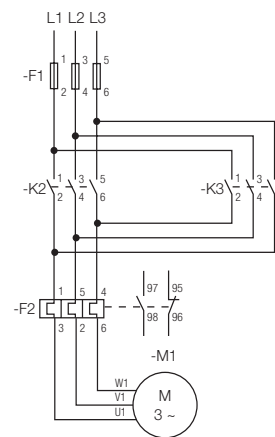

2CDC 252 087 F0b07

Power circuit diagram

Electrical connection

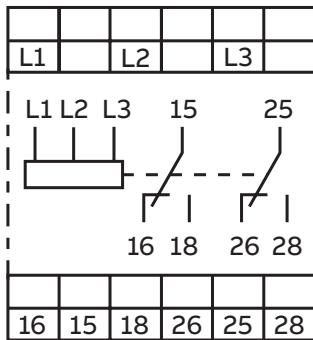

2CDC 252 038 F0008

L1, L2, L3 Control supply voltage = measuring voltage

15-16/18 Output contacts - closed-circuit principle
25-26/28

Connection diagram CM-MPN.x2

DIP switches

Position	4	3	2	1
ON ↑		2x1 c/o		
OFF		1x2 c/o		

2CDC 252 041 F0008

1 Timing function	ON	ON-delayed : In case of a fault, the de-energizing of the output relays and the respective fault message are suppressed for the adjusted tripping delay T _v .
	OFF	OFF-delayed : In case of a fault, the output relays de-energize instantaneously and a fault message is displayed and stored for the length of the adjusted tripping delay T _v . Thereby, also momentary undervoltage conditions are recognized.
2 Phase sequence monitoring	ON	Phase sequence monitoring deactivated : Phase sequence errors will not cause tripping of the relays.
	OFF	Phase sequence monitoring activated : The output relays de-energize as soon as a phase sequence error occurs. The output relays re-energize automatically as soon as the phase sequence is correct again.
3 Operating principle of the output relays	ON	2x1 c/o (SPDT) contact Depending on the configuration of automatic phase sequence correction and on the fault type, the output relays R1 (15-16/18) and R2 (25-26/28) react differently, if operating principle 2x1 c/o (SPDT) contact is selected. Automatic phase sequence correction deactivated : <ul style="list-style-type: none"> Overvoltage: only 1st c/o (SPDT) contact R1 (15-16/18) switches Undervoltage: only 2nd c/o (SPDT) contact R2 (25-26/28) switches Phase unbalance, phase sequence, phase failure, interrupted neutral: both output relays R1 (15-16/18) and R2 (25-26/28) react synchronously Automatic phase sequence correction activated : <ul style="list-style-type: none"> Overvoltage, undervoltage, phase unbalance, phase failure, interrupted neutral: only 1st c/o (SPDT) contact R1 (15-16/18) switches Phase sequence: only 2nd c/o (SPDT) contact R2 (25-26/28) switches Operating principle 2x1 c/o (SPDT) contact is mandatory if automatic phase sequence correction is activated.
	OFF	1x2 c/o (SPDT) contacts If operating principle 1x2 c/o (SPDT) contacts is selected, both output relays R1 (15-16/18) and R2 (25-26/28) react synchronously, independent of the fault type.
4 Automatic phase sequence correction	ON	Phase sequence correction activated : In conjunction with a reversing contactor combination, it is ensured that the correct phase sequence is applied to the input terminals of the load.
	OFF	Phase sequence correction deactivated : No automatic phase sequence correction in case of phase sequence error.

Technical data

Data at $T_a = 25\text{ °C}$ and rated values, unless otherwise indicated

Input circuit

Type	CM-MPN.52	CM-MPN.62	CM-MPN.72
Supply circuit = measuring circuit	L1, L2, L3		
Rated control supply voltage U_s = measuring voltage	3 x 350-580 V AC	3 x 450-720 V AC	3 x 530-820 V AC
Rated control supply voltage U_s tolerance	-15...+10 %		
Rated frequency	50/60 Hz		
Frequency range	45-65 Hz		
Typical current / power consumption	29 mA / 41 VA (480 V AC)	29 mA / 52 VA (600 V AC)	29 mA / 59 VA (690 V AC)

Measuring circuit	L1, L2, L3			
Monitoring functions	Phase failure	■		
	Phase sequence	can be switched off		
	Automatic phase sequence correction	configurable		
	Over-/undervoltage	■		
Measuring range	Phase unbalance	■		
	Overvoltage	3 x 480-580 V AC	3 x 600-720 V AC	3 x 690-820 V AC
	Undervoltage	3 x 350-460 V AC	3 x 450-570 V AC	3 x 530-660 V AC
	Phase unbalance	2-25 % of average of phase voltages		
Thresholds	Overvoltage	adjustable within measuring range		
	Undervoltage	adjustable within measuring range		
	Phase unbalance (switch-off value)	adjustable within measuring range		
Tolerance of the adjusted threshold value	6 % of full-scale value			
Hysteresis related to the threshold value	Over-/undervoltage	fixed 5 %		
	Phase unbalance	fixed 20 %		
Rated frequency of the measuring signal	50/60 Hz			
Frequency range of the measuring signal	45-65 Hz			
Maximum measuring cycle time	100 ms			
Accuracy within the rated control supply voltage tolerance	$\Delta U \leq 0.5\%$			
Accuracy within the temperature range	$\Delta U \leq 0.06\% / \text{°C}$			
Measuring method	True RMS			

Timing circuit	
Start-up delay T_s and T_{s2}	fixed 200 ms
Start-up delay T_{s1}	fixed 250 ms
Tripping delay T_v	ON- or OFF-delay 0 s; 0.1-30 s adjustable
Repeat accuracy (constant parameters)	$< \pm 0.2\%$
Accuracy within the rated control supply voltage tolerance	$\Delta t \leq 0.5\%$
Accuracy within the temperature range	$\Delta t \leq 0.06\% / \text{°C}$

User interface

Indication of operational states		
Relay status / timing	R/T	yellow LED
Fault message	F1	red LED
Fault message	F2	red LED

Details see table ‚LEDs, status information and fault messages‘ on page 4 and ‚Function descriptions / diagrams‘ on page 5.

Output circuits

Kind of output	15-16/18 25-26/28	relays, 1 x 2 or 2 x 1 (SPDT) contact(s) configurable
Operating principle		closed-circuit principle ¹⁾
Contact material		AgNi alloy, Cd free
Rated operational voltage U _e		250 V
Minimum switching voltage / Minimum switching current		24 V / 10 mA
Maximum switching voltage / Maximum switching current		see load limit curves
Rated operational current I _e	AC-12 (resistive) at 230 V	4 A
	AC-15 (inductive) at 230 V	3 A
	DC-12 (resistive) at 24 V	4 A
	DC-13 (inductive) at 24 V	2 A
AC rating (UL 508)	Utilization category (Control Circuit Rating Code)	B 300
	max. rated operational voltage	300 V AC
	max. continuous thermal current at B 300	5 A
	max. making/breaking apparent power at B 300	3600/360 VA
Mechanical lifetime		30 x 10 ⁶ switching cycles
Electrical lifetime	AC-12, 230 V, 4 A	0.1 x 10 ⁶ switching cycles
Maximum fuse rating to achieve short-circuit protection	n/c contact	10 A fast-acting
	n/o contact	10 A fast-acting

General data

MTBF		on request		
Duty time		100 %		
Dimensions		see 'Dimensional drawings'		
Weight	net weight	CM-MPN.52	Screw connection technology	Easy Connect Technology (push-in)
		CM-MPN.62	0.230 kg (0.507 lb)	0.226 kg (0.498 lb)
		CM-MPN.72	0.229 kg (0.504 lb)	0.224 kg (0.494 lb)
	gross weight	CM-MPN.52	0.224 kg (0.494 lb)	0.220 kg (0.485 lb)
		CM-MPN.62	0.255 kg (0.562 lb)	0.251 kg (0.553 lb)
		CM-MPN.72	0.254 kg (0.560 lb)	0.245 kg (0.540 lb)
Mounting		DIN rail (IEC/EN 60715), snap-on mounting without any tool		
Mounting position		any		
Minimum distance to other units		not necessary		
Material of housing		UL 94 V-0		
Degree of protection	housing	IP50		
	terminals	IP20		

¹⁾ Closed-circuit principle: Output relay(s) de-energize(s) if measured value exceeds or falls below the adjusted threshold value.

Electrical connection

		Screw connection technology	Easy Connect Technology (push-in)
Connecting capacity	fine-strand with(out) wire end ferrule	1 x 0.5-2.5 mm ² (1 x 18-14 AWG) 2 x 0.5-1.5 mm ² (2 x 18-16 AWG)	2 x 0.5-1.5 mm ² (2 x 18-16 AWG)
	rigid	1 x 0.5-4 mm ² (1 x 20-12 AWG) 2 x 0.5-2.5 mm ² (2 x 20-14 AWG)	2 x 0.5-1.5 mm ² (2 x 20-16 AWG)
Stripping length		8 mm (0.32 in)	
Tightening torque		0.6 - 0.8 Nm (7.08 lb.in)	-

Environmental data

Ambient temperature ranges	operation	-25...+60 °C
	storage	-40...+85 °C
Damp heat, cyclic (IEC/EN 60068-2-30)		6 x 24 cycle, 55 °C, 95 % RH
Climatic class		3K3
Vibration, sinusoidal		Class 2
Shock		Class 2

Isolation data

Type		
Rated insulation voltage U_i	input circuit / output circuit	1000 V
	output circuit 1 / output circuit 2	300 V
Rated impulse withstand voltage U_{imp}	input circuit / output circuit	6 kV, 1.2/50 μ s
	output circuit 1 / output circuit 2	4 kV, 1.2/50 μ s
Basic insulation	input circuit / output circuit	1000 V
Protective separation (IEC/EN 61140, EN 50178)	input circuit / output circuit	-
Pollution degree		3
Overvoltage category		III

Standards / Directives

Standards	IEC/EN 60947-5-1, IEC/EN 60255-27, EN 50178
Low Voltage Directive	2014/35/EU
EMC directive	2014/30/EU
RoHS directive	2011/65/EU

Electromagnetic compatibility

Type		
Interference immunity to		IEC/EN 61000-6-2
electrostatic discharge	IEC/EN 61000-4-2	Level 3 (6 kV / 8 kV)
radiated, radio-frequency, electromagnetic field	IEC/EN 61000-4-3	Level 3 (10 V/m)
electrical fast transient / burst	IEC/EN 61000-4-4	Level 3 (2 kV / 2 kHz)
surge	IEC/EN 61000-4-5	Level 4 (2 kV L-L)
conducted disturbances, induced by radio-frequency fields	IEC/EN 61000-4-6	Level 3 (10 V)
harmonics and interharmonics	IEC/EN 61000-4-13	Class 3
Interference emission		IEC/EN 61000-6-3
high-frequency radiated	IEC/CISPR 22, EN 55022	Class B
high-frequency conducted	IEC/CISPR 22, EN 55022	Class B

Technical diagrams

Load limit curves

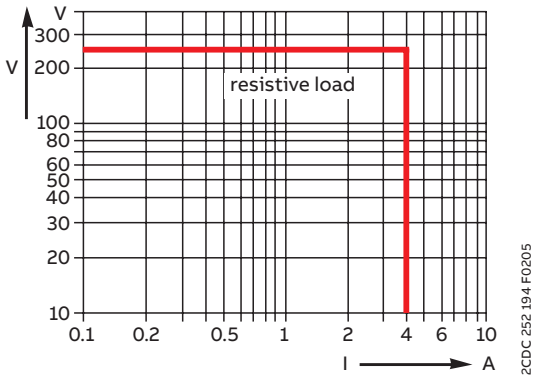

AC load (resistive)

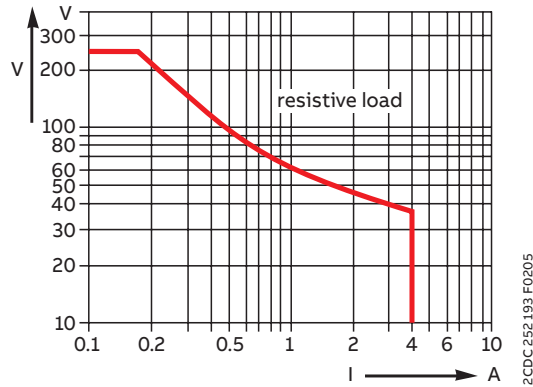

DC load (resistive)

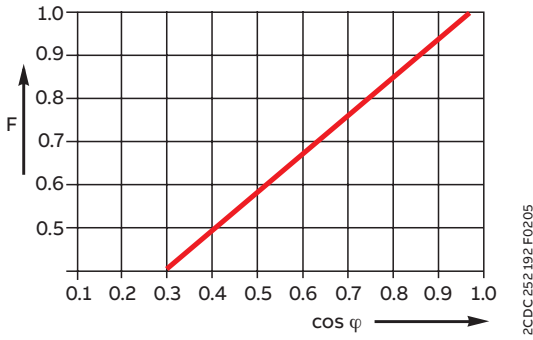

Derating factor F for inductive AC load

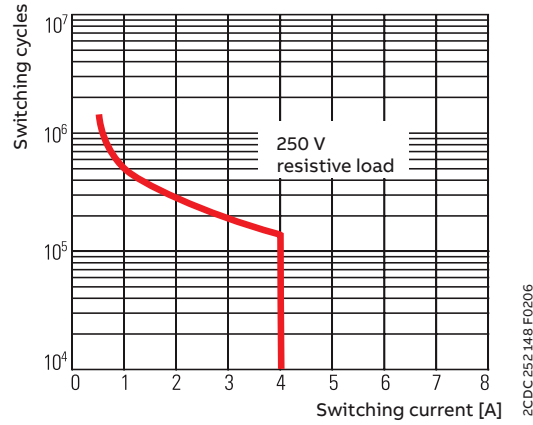

Contact lifetime

Dimensions

in mm and inches

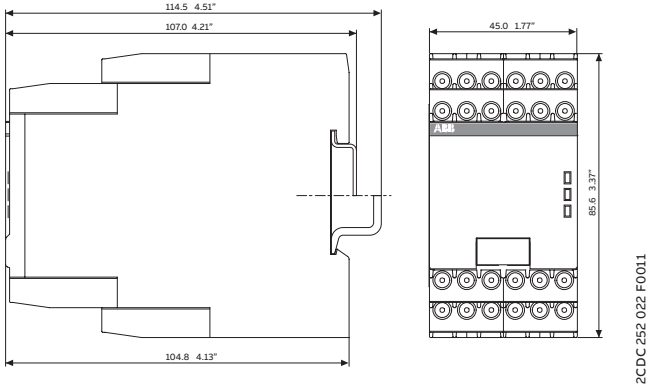

Accessories

in mm and inches

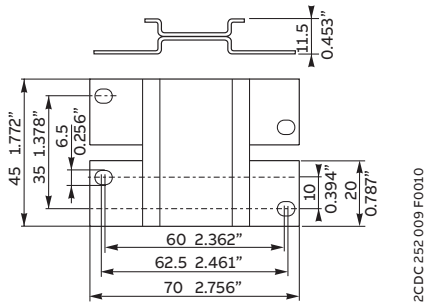

ADP.02 - Adapter for screw mounting

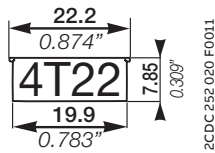

MAR.12 - Marker label for devices with DIP switches

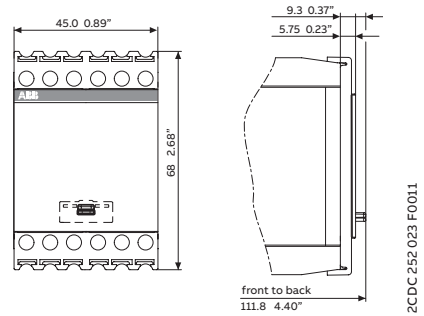

COV.12 - Sealable transparent cover

Further documentation

Document title	Document type	Document number
Electronic relays and controls	Catalog	2CDC 110 004 C02xx
CM-MPS.23, CM-MPS.43, CM-MPN.52, CM-MPN.62, CM-MPN.72	Instruction manual	1SVC 730 530 M0000

You can find the documentation on the internet at www.abb.com/lowvoltage

-> Automation, control and protection -> Electronic relays and controls -> Measuring and monitoring relays.

CAD system files

You can find the CAD files for CAD systems at <http://abb-control-products.partcommunity.com>

-> Low Voltage Products & Systems -> Control Products -> Electronic Relays and Controls.



ABB STOTZ-KONTAKT GmbH
Eppelheimer Strasse 82
69123 Heidelberg, Germany

abb.com/lowvoltage

We reserve the right to make technical changes or modify the contents of this document without prior notice. With regard to purchase orders, the agreed particulars shall prevail. ABB Ltd. does not accept any responsibility whatsoever for potential errors or possible lack of information in this document.

We reserve all rights in this document and in the subject matter and illustrations contained therein. Any reproduction, disclosure to third parties or utilization of its contents – in whole or in parts – is forbidden without prior written consent of ABB Ltd. Copyright© 2020 ABB Ltd. All rights reserved