



Relion® 605 series

# Feeder/Motor protection and control / Feeder/Motor protection REF601/REJ601/REM601 Application Manual

Power and productivity  
for a better world™







Document ID: 1MDU07212-YN

Issued: 2014-08-11

Revision: D

Product version: 2.2FP1

© Copyright 2014 ABB. All rights reserved

# Copyright

This document and parts thereof must not be reproduced or copied without written permission from ABB, and the contents thereof must not be imparted to a third party, nor used for any unauthorized purpose.

The software or hardware described in this document is furnished under a license and may be used, copied, or disclosed only in accordance with the terms of such license.

## Trademarks

ABB and Relion are registered trademarks of ABB Group. All other brand or product names mentioned in this document may be trademarks or registered trademarks of their respective holders.

## Warranty

Please inquire about the terms of warranty from your nearest ABB representative.

ABB India Limited,  
Distribution Automation  
Maneja,  
Vadodara, India  
Telephone: +91 265 2604386  
Fax: +91 265 2638922  
<http://www.abb.com/substationautomation>

## Disclaimer

The data, examples and diagrams in this manual are included solely for the concept or product description and are not to be deemed as a statement of guaranteed properties. All persons responsible for applying the equipment addressed in this manual must satisfy themselves that each intended application is suitable and acceptable, including that any applicable safety or other operational requirements are complied with. In particular, any risks in applications where a system failure and/or product failure would create a risk for harm to property or persons (including but not limited to personal injuries or death) shall be the sole responsibility of the person or entity applying the equipment, and those so responsible are hereby requested to ensure that all measures are taken to exclude or mitigate such risks.

This document has been carefully checked by ABB but deviations cannot be completely ruled out. In case any errors are detected, the reader is kindly requested to notify the manufacturer. Other than under explicit contractual commitments, in no event shall ABB be responsible or liable for any loss or damage resulting from the use of this manual or the application of the equipment.

## Conformity

This product complies with the directive of the Council of the European Communities on the approximation of the laws of the Member States relating to electromagnetic compatibility (EMC Directive 2004/108/EC) and concerning electrical equipment for use within specified voltage limits (Low-voltage directive 2006/95/EC). This conformity is the result of tests conducted by ABB in accordance with the product standards EN 50263 and EN 60255-26 for the EMC directive, and with the product standards EN 60255-1 and EN 60255-27 for the low voltage directive. The IED is designed in accordance with the international standards of the IEC 60255 series.

---

## Table of contents

|                  |  |                                     |
|------------------|--|-------------------------------------|
| <b>Section 1</b> | <b>General.....</b>  | <b>5</b>                            |
|                  | 1.1 This manual.....   | 5                                   |
|                  | 1.2 Intended audience.....                                     | 5                                   |
|                  | 1.3 Document revision history.....                             | 5                                   |
|                  | 1.4 Document symbol and conventions.....                       | 6                                   |
| <b>Section 2</b> | <b>REM601 overview.....</b>                                    | <b>Error! Bookmark not defined.</b> |
|                  | 2.1 Overview.....  | <b>Error! Bookmark not defined.</b> |
|                  | 2.2 Product version history.....                               | 8                                   |
|                  | 2.3 Operation Functionality.....                               | 8                                   |
|                  | 2.3.1 Relay functions.....                                     | 8                                   |
|                  | 2.3.2 Optional function.....                                   | 10                                  |
|                  | 2.4 Other Functions.....                                       | 10                                  |
|                  | 2.4.1 Self-Supervision.....                                    | 10                                  |
|                  | 2.4.2 Fault record and Trip counter.....                       | 11                                  |
|                  | 2.4.3 Event Log.....   | 12                                  |
|                  | 2.4.4 Real Time Clock.....                                     | 15                                  |
|                  | 2.4.5 Access Control.....                                      | 15                                  |
|                  | 2.4.6 Power-ON sequence.....                                   | 15                                  |
| <b>Section 3</b> | <b>Technical Data.....</b>                                     | <b>16</b>                           |
| <b>Section 4</b> | <b>Protection and Control Function.....</b>                    | <b>16</b>                           |
|                  | 4.1 Three Phase Overcurrent Protection.....                    | 16                                  |
|                  | 4.1.1 Functionality.....                                       | 16                                  |
|                  | 4.1.2 Principle of Operation.....                              | 16                                  |
|                  | 4.1.3 Setting range of Three Phase Overcurrent Protection..... | 16                                  |

# Table of contents

---

|        |   |                                     |
|--------|---|-------------------------------------|
| 4.2    | Earth Fault Protection.....                               | 17                                  |
| 4.2.1  | Functionality .....                                       | 17                                  |
| 4.2.2  | Principle of Operation.....                               | 17                                  |
| 4.2.3  | Setting range of Earth fault Overcurrent Protection ..... | 18                                  |
| 4.3    | Three Phase Inrush Detector .....                         | <b>Error! Bookmark not defined.</b> |
| 4.4    | Negative-sequence overcurrent protection .....            | 18                                  |
| 4.4.1  | Functionality .....                                       | 18                                  |
| 4.4.2  | Principle of Operation.....                               | 19                                  |
| 4.5    | Phase discontinuity protection .....                      | 19                                  |
| 4.5.1  | Functionality .....                                       | 19                                  |
| 4.5.2  | Principle of Operation.....                               | 19                                  |
| 4.6    | Circuit breaker failure protection .....                  | 20                                  |
| 4.6.1  | Functionality .....                                       | 20                                  |
| 4.6.2  | Principle of Operation.....                               | 20                                  |
| 4.7    | Setting groups .....                                      | 22                                  |
| 4.8    | Auto-reclose function.....                                | 22                                  |
| 4.8.1  | Functionality .....                                       | 22                                  |
| 4.8.2  | Principle of operation .....                              | 23                                  |
| 4.9    | Thermal overload protection .....                         | 26                                  |
| 4.9.1  | Functionality .....                                       | 26                                  |
| 4.9.2  | Principle of operation .....                              | 26                                  |
| 4.10   | Protection characteristics .....                          | 33                                  |
| 4.10.1 | Time / Current characteristics .....                      | 36                                  |
| 4.10.2 | IEC 60255-3 IDMT characteristic.....                      | 36                                  |
| 4.10.3 | ANSI C37.112 IDMT characteristic .....                    | 37                                  |
| 4.10.4 | RI type characteristic.....                               | 38                                  |
| 4.11   | Configurable Binary Outputs .....                         | 38                                  |
| 4.12   | Configurable LED .....                                    | 40                                  |
| 4.13   | Configurable Binary Inputs .....                          | 41                                  |



---

|                  |   |           |
|------------------|---|-----------|
|                  | 4.14 Breaker control and Trip command operation.....      | 42        |
|                  | 4.15 Trip Circuit Supervision .....                       | 42        |
| <b>Section 5</b> | <b>Use of LHMI.....</b>                                   | <b>44</b> |
| 5.1              | Overview .....  | 44        |
| 5.1.1            | LED's.....  | 44        |
| 5.1.2            | LCD display .....   | 45        |
| 5.1.3            | Navigation .....  | 45        |
| 5.1.4            | Authorization .....                                       | 46        |
| 5.1.5            | Configuration status .....                                | 47        |
| 5.2              | LHMI menu navigation .....                                | 48        |
| 5.2.1            | Default screen .....                                      | 48        |
| 5.2.2            | Main menu .....   | 48        |
| 5.2.3            | Menu – Measurement .....                                  | 49        |
| 5.2.4            | Menu – Fault record .....                                 | 50        |
| 5.2.5            | Menu - Events .....                                       | 50        |
| 5.2.6            | Menu – Setting .....                                      | 51        |
| 5.2.7            | Menu – Configuration .....                                | 53        |
| 5.2.8            | Menu – Test .....   | 61        |
| 5.2.9            | Access level .....  | 66        |
| 5.2.10           | Version information .....                                 | 66        |
| <b>Section 6</b> | <b>Installation .....</b>                                 | <b>67</b> |
| 6.1              | Unpacking and inspecting the device .....                 | 67        |
| 6.2              | Storage.....  | 67        |
| 6.3              | Checking environmental condition and mounting space ..... | 67        |
| 6.4              | Relay wiring.....   | 68        |
| 6.5              | Relay mounting and dimensions .....                       | 68        |
| 6.6              | Terminal diagram .....                                    | 71        |
| 6.7              | Relay ordering information .....                          | 73        |

## Table of contents

---

|        |  |    |
|--------|--|----|
| 6.8    | Accessories and ordering data.....                         | 74 |
| 6.9    | Setting table .....  | 75 |
| 6.10   | Earthing of relay and Bonding of sensor cable shield ..... | 81 |
| 6.10.1 | Earthing of relay .....                                    | 81 |
| 6.10.2 | Shield connection at relay side (Sensor variant).....      | 82 |

## Section 1      General

### 1.1              This manual

This manual contains application and functionality descriptions and connection diagrams, input and output signals, setting parameters and technical data. The manual can be used as a technical reference during the engineering phase, installation and commissioning phase, and during normal service. The manual can also be used when calculating settings. The manual provides instructions on how to operate the IED during normal service once it has been commissioned and to find out how to handle disturbances or view calculated and measured network data in order to determine the cause of a fault.

### 1.2              Intended audience

This manual addresses system engineers, installation and commissioning personnel, who use technical data during engineering, installation and commissioning, and in normal service. System engineer must have a thorough knowledge of protection systems, protection equipment, protection functions and the configured functional logics in the IEDs. The installation and commissioning personnel must have a basic knowledge in handling electronic equipment.

This manual addresses Protection and control engineer responsible for planning, pre-engineering and engineering. The protection and control engineer must be experienced in electrical power engineering and have knowledge of related technology, such as communication and protocols.

The manual also addresses the operator, who operates the IED on a daily basis. The operator must be trained in and have a basic knowledge of how to operate protection equipment. The manual contains terms and expressions commonly used to describe this kind of equipment.

### 1.3              Document revision history

| Document revision/date | Product version | Document history  |
|------------------------|-----------------|---|
| A / 28.09.2012         | 2.1             | Release of REF601/REJ601 with conventional current transformer  |
| B / 28.03.2013         | 2.2             | Common version for REF601 /REJ601 CT and REF601 Sensor variant  |
| C / 23.06.2014         | 2.2FP1          | Release of REF601/REJ601 with functionality for version 2.2 FP1 |
| D / 11.08.2014         | 2.2FP1          | Release of REM601 with functionality for version 2.2 FP1        |

## 1.4 Document symbol and conventions

This publication includes the following icons that point out safety-related conditions or other important information:

### Safety indication symbols



The information icon alerts the reader to important facts and conditions.



Non-observance can result in death, personal injury or substantial property damage

Breaking the sealing tape on the upper handle of the device will result in loss of warranty and proper operation will no longer be guaranteed.

When the plug-in unit has been detached from the case, do not touch the inside of the case. The relay case internals may contain high voltage potential and touching these may cause personal injury.



The warning icon indicates the presence of a hazard which could result in personal injury.

Dangerous voltages can occur on the connectors, even though the auxiliary voltage has been disconnected.

National and local electrical safety regulations must always be followed.

The device contains components which are sensitive to Electrostatic discharge. Unnecessary touching of electronic components must therefore be avoided.

Only a competent electrician is allowed to carry out the electrical installation.



The caution icon indicates important information or warning related to the concept discussed in the text. It might indicate the presence of a hazard which could result in corruption of software or damage to equipment or property.



The tip icon indicates advice on, for example, how to design your project or how to use a certain function.

---

## Section 2 REF601/REJ601/REM601 overview

### 2.1 Overview

REF601/REJ601 is a dedicated feeder protection relay, intended for the protection of utility substations and industrial power systems, in primary and secondary distribution networks. Similarly REM601 is a dedicated motor protection relay, intended for the protection of medium voltage and low voltage asynchronous motors in manufacturing and process industry. REF601/REJ601/REM601 are the member of ABB's Relion<sup>®</sup> product family and part of its 605 series.

The relay provides an optimized composition of protection, monitoring and control functionality in one unit, with the best performance usability in its class and is based on ABB's in-depth knowledge of protection and numerical technology.

The common features of REF601/REJ601/REM601 includes:

- Compact size and ease of use
- Standard 1A or 5A CT input for phase current measurement
- Alternate support for sensor input for phase current measurement
- Earth current measurement internally or externally through CBCT
- Local and remote control of circuit breaker
- Trip Circuit Supervision and relay internal supervision
- Lockout function
- 100 event logs with date and time stamping
- Five analogue fault records
- Non-resettable trip counter
- On-line current measurements in primary value
- Comprehensive local HMI
- Universal auxiliary supply
- Optional MODBUS RTU or IEC 60870-5-103 communication
- Non-volatile memory for setting and fault records
- User selectable rated frequency 50 / 60 Hz
- Configurable binary inputs, outputs and alarm LEDs
- Multi language support for local HMI
- Two setting groups

## REF601/REJ601/REM601 overview

The protection features of REF601/REJ601 includes:

- Three-stage overcurrent protection
- Two-stage earth-fault protection
- Inrush detection for stability during transformer charging
- Thermal overload protection
- Negative sequence overcurrent
- Phase discontinuity protection
- Circuit breaker failure protection
- Multi shot Auto recloser functionality for overhead line

The protection features of REM601 includes:

- Three-phase thermal overload protection
- Negative phase sequence protection
- Phase discontinuity or single phasing protection and phase reversal protection
- Motor start-up protection or stalling protection and repetitive start protection
- Short circuit and earth fault protection
- Motor load jam or locked rotor protection
- Under current protection
- Emergency restart function
- Circuit breaker failure protection

## 2.2

### Product version history

| Product version | Release date | Product History   |
|-----------------|--------------|---|
| 1.0             | 20.03.2009   | Product released  |
| 1.0 SP1         | 21.08.2009   | Service Pack released   |
| 2.0             | 04.04.2012   | Version 2.0 released  |
| 2.1             | 28.09.2012   | Version 2.1 release with support of conventional current transformer    |
| 2.2             | 28.03.2013   | Common version release for REF601 / REJ601 CT and REF601 Sensor variant |
| 2.2 FP1         | 23.06.2014   | REF601 / REJ601 Version 2.2 FP1 released                                |
| 2.2 FP1         | 11.08.2014   | REM601 Version 2.2 FP1 released   |

## 2.3

### Operation Functionality

#### 2.3.1

#### Relay functions

REF601/REJ601/REM601 offers pre-configured functionality which facilitates easy and fast commissioning of switchgear. To emphasize the simplicity of relay's usage, only application specific parameters needs to set within the relay's intended area of application.

The relay offers protection, control, measurement and condition monitoring functionality. The table indicates the functions supported by the IED

## REF601/REJ601/REM601 overview

Table 1: Relay functions

| Test   | Related products   |               | REJ601/<br>REF601 | REJ601/<br>REF601 | REJ601/<br>REF601 | REM601 | REM601 |
|--|--------------------|---------------|-------------------|-------------------|-------------------|--------|--------|
|  | ANSI               | IEC           | B                 | C                 | D                 | B      | C      |
| <b>Functionality</b>   |                    |               |                   |                   |                   |        |        |
| <b>Protection</b>  |                    |               |                   |                   |                   |        |        |
| Non-directional overcurrent protection, low-set stage  | 51                 | 3I>           | •                 | •                 | •                 | •      | •      |
| Non-directional overcurrent protection, high-set stage   | 50-1               | 3I>>          | •                 | •                 | •                 | •      | •      |
| Non-directional overcurrent protection, instantaneous stage  | 50-2               | 3I>>>         | •                 | •                 | •                 | •      | •      |
| Earth-fault protection, low-set stage  | 51N                | Io>           | •                 | •                 | •                 | •      | •      |
| Earth-fault protection, high-set stage   | 50N                | Io>>          | •                 | •                 | •                 | •      | •      |
| Three phase transformer inrush detector  | 68                 | 3I2f>         | •                 | •                 | •                 | -      | -      |
| Three-phase thermal protection for feeders, cables, distribution transformers and motor  | 49                 | 3Ith>         | -                 | •                 | •                 | •      | •      |
| Phase discontinuity / Single phasing protection  | 46PD               | I2/I1>        | -                 | •                 | •                 | •      | •      |
| Negative-sequence overcurrent protection   | 46                 | I2>           | -                 | -                 | •                 | •      | •      |
| Phase reversal protection  | 46R                | I2R>          | -                 | -                 | •                 | •      | •      |
| Motor startup supervision / Stalling protection with provision of speed switch input<br>Repetitive start up protection and restart inhibit | 51LRS/<br>14/48/66 | I2t n<        | -                 | -                 | -                 | •      | •      |
| Locked rotor protection during running   | 50-2               | 3I>>>         | -                 | -                 | -                 | •      | •      |
| Under current protection   | 37                 | 3I<           | -                 | -                 | -                 | •      | •      |
| Emergency restart  | ESTART             | ESTART        | -                 | -                 | -                 | •      | •      |
| Circuit breaker failure protection   | 51BF/<br>51NBF     | 3I>/Io><br>BF | -                 | •                 | •                 | •      | •      |
| Master trip  | 86                 | Master Trip   | •                 | •                 | •                 | •      | •      |
| Two setting group  | -                  | -             | •                 | •                 | •                 | •      | •      |
| <b>Control (Function available in REF601 and REM601 Application configuration C )</b>  |                    |               |                   |                   |                   |        |        |
| Breaker control functionality  | I <-> O<br>CB      | I <-> O<br>CB | •                 | •                 | •                 | -      | •      |
| Auto-reclosing   | 79                 | O -> I        | -                 | -                 | •                 | -      | -      |

REF601/REJ601/REM601 overview

**Table 1: Relay functions, continue**

| Test                                 | Related products |                | REJ601/<br>REF601 | REJ601/<br>REF601 | REJ601/<br>REF601 | REM601 | REM601 |
|--------------------------------------|------------------|----------------|-------------------|-------------------|-------------------|--------|--------|
|                                      | ANSI             | IEC            | B                 | C                 | D                 | B      | C      |
| <b>Condition monitoring</b>          |                  |                |                   |                   |                   |        |        |
| Trip circuit supervision             | TCM              | TCS            | •                 | •                 | •                 | •      | •      |
| Measurement                          |                  |                |                   |                   |                   |        |        |
| Three-phase current measurement      | 3I               | 3I             | •                 | •                 | •                 | •      | •      |
| Residual current measurement         | I <sub>n</sub>   | I <sub>o</sub> | •                 | •                 | •                 | •      | •      |
| Negative phase sequence current      | I <sub>2</sub>   | I <sub>2</sub> | -                 | -                 | •                 | •      | •      |
| Thermal level                        | ϑ                | ϑ              | -                 | •                 | •                 | •      | •      |
| Operation counter                    | -                | -              | •                 | •                 | •                 | •      | •      |
| Motor run time                       | -                | -              | -                 | -                 | -                 | •      | •      |
| Latest motor start up max. current   | -                | -              | -                 | -                 | -                 | •      | •      |
| Latest motor start up time           | -                | -              | -                 | -                 | -                 | •      | •      |
| Time to next possible motor start up | -                | -              | -                 | -                 | -                 | •      | •      |

• = Included

### 2.3.2 Optional function

The relay supports two optional communication MODBUS RTU and IEC 60870-5-103, on a two wire RS485 interface.

## 2.4 Other Functions

### 2.4.1 Self-Supervision

The IED is provided with an extensive self-supervision system which continuously supervises the software and the electronics. It handles run-time fault situations and informs the user about a fault via the LHMI.

At normal condition (no internal fault), the green Ready LED glow and the self-supervision output contact is closed. When an internal fault is detected in the IED, the green LED ceases to glow and the self-supervision contact opens. Also, all other outputs are released.

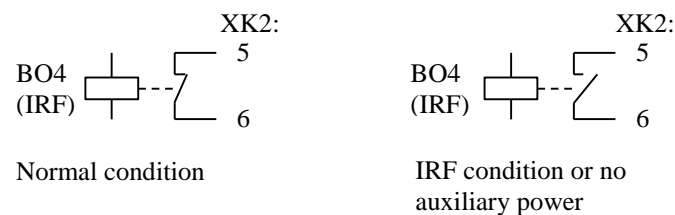

Figure 1: Behavior of contact assigned for Unit ready / IRF



REF601/REJ601/REM601 overview

Internal fault indications have the highest priority on the LHMI. None of other LHMI indications can override the internal fault indication. An indication about the fault is shown as a message on the LHMI.

The internal fault code indicates the type of internal IED fault

*Table 2: Internal fault indications and fault codes*

| Internal fault code | Type of fault                 |
|---------------------|-------------------------------|
| IRF 008             | Internal supply voltage check |
| IRF 016             | Power on "EEPROM" check fault |
| IRF 032             | Runtime "EEPROM" check fault  |
| IRF 064             | Gain check fault              |

The user can try to eliminate the fault by restarting the IED. If the fault is found to be permanent, the IED stays in internal fault mode.

2.4.2

**Fault record and Trip counter**

The relay stores records of analog values for last five trip events in non-volatile memory. The fault recording is triggered by the trip signal of a protection function. Each fault record includes the rms current values of fundamental component for all three phases and the neutral current at five different times along the trip event.

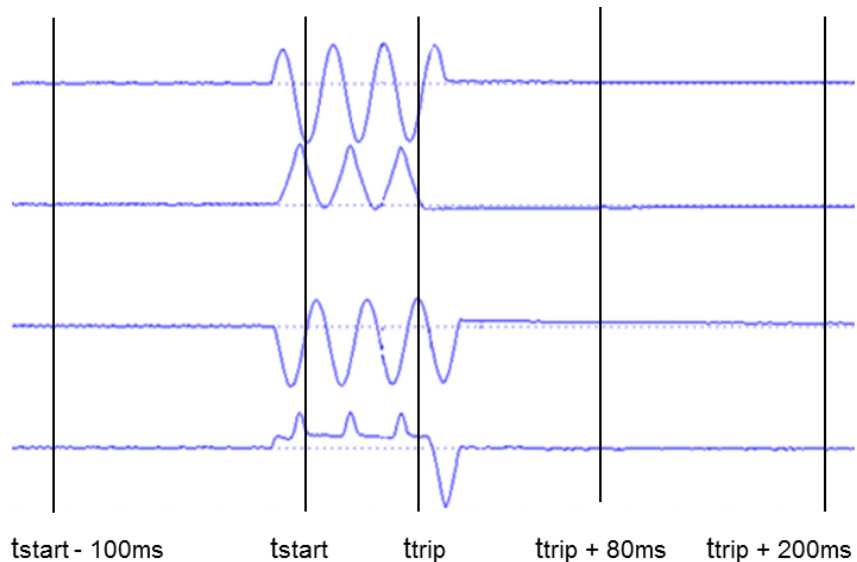

*Figure 2: Fault record*

These records enable the user to analyze the five most recent power system events. The oldest recording is lost when a new fault recording is made.

REF601/REJ601/REM601 overview

Additionally, the relay count the number of phase fault trip and earth fault trip into dedicated trip counters. These trip counters cannot be reset by the user and are stored in nonvolatile memory.

The values of fault records and trip counters are accessible locally LHMI and remotely via communication interface of the relay.

2.4.3

Event Log

To collect sequence-of-events (SoE) information, the relay incorporates a non-volatile memory to store 100 event logs. Each event log includes type of event along with date and time stamping. The event logs are stored sequentially, the most recent being first and so on.

The SoE information are accessible locally via LHMI and remotely via communication interface of the relay.

Table 3: List of event types and related description

| Sr. No.  | Event type   | Description   | Data considered   |
|--|--|---|---|
| 1  | Power supply presence  | Unit ready contact activation will be stored as an event. This unit ready contact is activated when power supply is on and no internal relay fault detected | Unit Ready  |
| 2  | Trip circuit supervision   | When trip circuit becomes faulty, an event of trip circuit faulty will be recorded. & when it becomes health shall also record it as an event               | TCS fault ↑<br>TCS fault ↓  |
| 3  | Setting parameter change   | Settings (I>,I>>,I>>>,Io>,Io>> and t>,t>>,t>>>,to>,to>>) alteration will be captured as an event without setting value.                                     | I>, I>>, I>>>, Io>, Io>>, t>, t>>, t>>>, to>, to>>  |
|  |  | Circuit breaker failure protection settings - IBF, IOBF, t Retrip, t Backup   | Icbfp, IOcbfp, t Retrip, t Backup   |
|  |  | On change of Count value  | Count Value   |
|  |  | Negative sequence setting change - I2> and tI2>   | I2>, tI2>   |
|  |  | Phase discontinuity setting change - I2/I1> and tI2/I1>   | I2/I1>, tI2/I1>   |
|  |  | Thermal protection setting change- ϑ0, Ib, t↑, t↓s, t↓r, ϑalm, ϑtrip, ϑstrinhibit, ϑEM  | ϑ0, Ib, t↑, t↓s, t↓r, ϑalm, ϑtrip, ϑstrinhibit, ϑEM   |
|  |  | Under current parameter change - 3I< and t3I<   | 3I<, t3I<   |
|  |  | Phase reversal setting change – I2R> and tI2R>  | I2R>, tI2R>   |
|  |  | Auto reclose function setting change - Mode, CB Ready, Activate t # of Cycle, Pulse tp, cycle t1, cycle t2, cycle t3, cycle t4, Reclaim tr, Block tb        | O→I - Mode, CB Ready, Activate t # of Cycle, Pulse tp, cycle t1, cycle t2, cycle t3, cycle t4, Reclaim tr, Block tb |
| Motor startup and stall protection parameter change I start>, Istartup, t startup, t lockrotor, Max Strt, tn, Restrain 68M | I start>, Istartup, t startup, t lockrotor, Max Strt, tn, Restrain 68M |   |   |

## REF601/REJ601/REM601 overview

Table 3: List of event types and related description, continue

| Sr. No. | Event type  | Description  | Data considered |
|---------|---|--|-----------------|
| 4       | Protection start  | Start event by I>,I>>, I>>>,Io> OR Io>> will be captured as individual event for both rising and dropping  | Start I> ↑      |
|         |   |  | Start I>> ↑     |
|         |   |  | Start I>>> ↑    |
|         |   |  | Start IO> ↑     |
|         |   |  | Start IO>> ↑    |
|         |   |  | Start I> ↓      |
|         |   | Start I>> ↓  |                 |
|         |   | Start I>>> ↓   |                 |
|         |   | Start IO> ↓  |                 |
|         |   | Start IO>> ↓   |                 |
|         | On I2> start both rising and falling signal   | Start I2> ↑<br>Start I2> ↓   |                 |
|         | On I2/I1> start both rising & falling signal  | Start I2/I1> ↑<br>Start I2/I1> ↓   |                 |
|         | On thermal alarm output signal for both rising & falling signal                           | 3Ith> Alarm ↑<br>3Ith> Alarm ↓   |                 |
|         | On phase reversal start   | I2R> Start ↑<br>I2R> Start ↓   |                 |
|         | On start of motor output activation and deactivation                                      | I2tn< Mstr ↑<br>I2tn< Mstr ↓   |                 |
| 5       | Protection trip   | In the event of Tripping, which protection stage (I>, I>>, I>>>, Io> and Io>>) caused trip will be captured as an event information. Event shall be available for both rising & dropping | Trip I> ↑       |
|         |   |  | Trip I>> ↑      |
|         |   |  | Trip I>>> ↑     |
|         |   |  | Trip IO> ↑      |
|         |   |  | Trip IO>> ↑     |
|         |   |  | Trip I> ↓       |
|         |   | Trip I>> ↓   |                 |
|         |   | Trip I>>> ↓  |                 |
|         |   | Trip IO> ↓   |                 |
|         |   | Trip IO>> ↓  |                 |
|         | On I2> trip both rising & falling signal  | Trip I2> ↑<br>Trip I2> ↓   |                 |
|         | On I2/I1> trip both rising & falling signal   | Trip I2/I1> ↑<br>Trip I2/I1> ↓   |                 |
|         | On undercurrent trip  | 3I< Trip ↑<br>3I< Trip ↓   |                 |
|         | On phase reversal trip  | I2R> Trip ↑<br>I2R> Trip ↓   |                 |
|         | On trip output activation & deactivation due to either stall protection or I2t protection | tall Trip ↑<br>Stall Trip ↓<br>I2t Trip ↑<br>I2t Trip ↓  |                 |
|         | On thermal trip output signal for both rising & falling signal                            | 3Ith> Trip ↑<br>3Ith> Trip ↓   |                 |
| 6       | IRF   | "IRF" – internal relay fault shall be captured as an event.  | IRF codes       |
| 7       | Breaker open  | When breaker open cmd  | Breaker Open    |
| 8       | Breaker close   | When breaker close cmd   | Breaker Close   |
| 9       | Remote trip   | When remotely trip command issued  | Remote Trip     |
| 10      | Reset   | When reset of protection trip, LEDs and screen done  | Reset           |

## REF601/REJ601/REM601 overview

Table 3: List of event types and related description, continue

| Sr. No. | Event type                              | Description   | Data considered  |
|---------|---|---|--|
| 11      | Blocking                                | When blocking by binary input, And shall have event for both rising & dropping  | BI Blocking ↑<br>BI Blocking ↓   |
| 12      | Breaker position                        | When breaker open, close or maintenance position sensed by associated binary input                                      | CB POS CLS ↑<br>CB POS CLS ↓   |
|         |   |   | CB POS OPN ↑<br>CB POS OPN ↓   |
|         |   |   | CB Maint ↑<br>CB Maint ↓   |
| 13      | Memory read fail                        | In case unable to read Event from EEPROM, a message i.e. "Memory Read Fail" will be displayed for that particular event | Memory Read Fail   |
| 14      | Hardware test                           | When in test menu, initiate hardware test   | Hardware Test  |
| 15      | Binary output test                      | When in test menu , initiate binary output test   | BO Test  |
| 16      | Functional test                         | When in test menu, initiate protection function test  | Functional Test  |
| 17      | Power Off                               | When binary input is mapped to register power off situation & power supply to IED goes OFF.                             | Power Off  |
| 18      | Breaker Failure Stage 1, 2 output       | On breaker failure receive stage 1 output   | BF Stage1 ↑<br>BF Stage2 ↑<br>BF Stage1 ↓<br>BF Stage2 ↓                         |
| 19      | Breaker Failure receive trip output     | On breaker failure receive trip output  | BF RecTrip BO↑<br>BF RecTrip BO↓   |
| 20      | Breaker Failure receive trip Acceptance | On Acceptance of BF RecTrip input   | BF RecTrip Acp ↑   |
| 21      | Setting group change                    | On change of setting group from one to another  | Setting SG Edt.<br>Setting SG No.<br>Setting SG Act.                             |
| 22      | Thermal reset                           | On reset of thermal function either from BI, LHMI or communication.   | 3lth> Reset  |
| 23      | Thermal block breaker close             | On breaker close blocking output signal for both rising & falling signal  | 3lth> Blk Cls ↑<br>3lth> Blk Cls ↓   |
|         |   | On breaker close blocking output signal for both rising & falling signal due to cumulative startup protection           | I2tn< BlkCl ↑<br>I2tn< BlkCl ↓   |
| 24      | O→I close                               | On O→I close output   | O→I close 1 ↑<br>O→I close 2 ↑<br>O→I close 3 ↑<br>O→I close 4 ↑                 |
| 25      | O→I FinalTr                             | On O→I final trip output  | O→I FinalTr ↑  |
| 26      | O→I Blocked                             | On O→I blocked output   | O→I Blocked ↑<br>O→I Blocked ↓   |
| 27      | O→I Stopped                             | On O→I stopped internal signal generated  | O→I Stopped ↑  |
| 28      | O→I Started                             | On O→I started internal signal generated  | O→I Started ↑  |
| 29      | Signal 1, 2, 3                          | On signal 1, 2, 3 output activation and deactivation respectively   | Signal 1 ↑<br>Signal 2 ↑<br>Signal 3 ↑<br>Signal 1 ↓<br>Signal 2 ↓<br>Signal 3 ↓ |

**Table 3:** List of event types and related description, continue

| Sr. No. | Event type               | Description   | Data considered  |
|---------|--------------------------|---|--|
| 30      | Binary input 1, 2, 3, 4  | On binary input 1, 2, 3, 4 activation and deactivation respectively   | BI 1 ↑, BI 2 ↑, BI 3 ↑, BI 4 ↑<br>BI 1 ↓, BI 2 ↓, BI 3 ↓, BI 4 ↓ |
| 31      | Setting parameter change | OPTS parameter change – value   | OPTS - value   |
| 32      | Start                    | An event for general start will be capture for both rising and falling which will be from any of start of I>,I>>, I>>>,lo>,lo>>, I2>, I2/I1>                | Start ↑<br>Start ↓   |
| 33      | Trip                     | An event for general trip will be capture for both rising and falling which will be from any of trip of I>,I>>, I>>>,lo>,lo>>, I2>, I2/I1> and Thermal trip | Trip ↑<br>Trip ↓   |
| 34      | Factory default          | Event for factory default   | Factory Default  |

## 2.4.4

### Real Time Clock

IED comes with a real time clock with user settable date and time. Date can be set in “DD/MM/YYYY” format and time can be set in “HH:MM:SS” format. The time stamping have 1 ms resolution. RTC is used for time stamping the event logs and as well as fault records. In case of power failure RTC will have a stored energy backup for around 48 hrs. at ambient temperature when stored energy element is fully charged. Initial time setting is “01/01/2011” and “00:00:00:0000”.

## 2.4.5

### Access Control

To protect the relay from unauthorized access and to maintain the integrity of information, the relay is armed with a three level, role-based user authentication system with individual password for the operator, engineer (Setting level) and administrator level. With the Ver. 2.2 FP1 REF601/REJ601/REM601 supports two modes for password handling:

1. a combination of different navigation keys (default mode)
2. alphanumeric password

## 2.4.6

### Power-ON sequence

The Power-ON sequence takes around 6 sec.

In case the optional communication on MODBUS RTU / IEC 60870-5-103 is present, the startup time takes around 40 sec.

## Section 3 Technical Data

For detailed technical data please refer the product guide.

## Section 4 Protection and Control Function

### 4.1 Three Phase Overcurrent Protection

#### 4.1.1 Functionality

The three-phase overcurrent protections can be used as three phase non-directional overcurrent and short-circuit protection for feeders.

The operate time characteristics for low stage can be selected to be either definite time (DT) or inverse definite minimum time (IDMT). The high and instantaneous stage always operates with the definite time (DT) characteristics.

#### 4.1.2 Principle of Operation

The three-phase overcurrent unit continuously measures all three phase currents of the protected object. The maximum current of the three phases is evaluated by the low stage ( $I >$  / 51), high stage ( $I >>$  / 50-1) and instantaneous stage ( $I >>>$  / 50-2) of phase overcurrent functions.

On occurrence of fault, fulfilling the trip condition of respective stage, the LED “Trip” and “Trip Ip” will be activated as configured. Additionally the output relays (Trip and signalization) will be activated according the binary output configuration. Each of the stages could be blocked by settings or via binary input of the relay.

#### 4.1.3 Setting range of Three Phase Overcurrent Protection

**Table 4:** *Setting ranges Non-directional overcurrent protection, Low stage 3I>, 51*

| Description                            | Value  |
|--|--|
| Setting range of pick-up current $I >$ | 0.1...2.50 x $I_n$ in steps 0.001, infinite  |
| Operate time delay (DT) $t >$          | 0.04...64 sec in steps of 0.01   |
| Operating curve type (IDMT)            | IEC 60255-3: Normal inverse, Very inverse, Extremely inverse, Long-time inverse<br>ANSI C37.112: Moderate inverse, Normal Inverse, Very inverse, Extremely inverse<br>Special curves: RI inverse |
| Time multiplier setting k (IDMT)       | 0.02...1.6, in steps of 0.01   |
| Reset ratio                            | IDMT : 0.96 and DT : 0.98  |
| Reset time                             | 40 ms  |
| Trig CBFP                              | Yes / No   |

## Protection and Control Function

**Table 5:** *Setting ranges Non-directional overcurrent protection, High stage 3I>>, 50-1*

| Description                          | Value  |
|--------------------------------------|--|
| Setting range of pick-up current I>> | 0.2...25 x In in steps 0.001, infinite for CT variant<br>0.2...20 x In in steps 0.001, infinite for sensor variant |
| Operation mode                       | Definite time  |
| Operate time delay (DMT) t>>         | 0.04...64 sec in steps of 0.01   |
| Reset ratio                          | 0.98   |
| Reset time                           | 40 ms  |
| Trig CBFP                            | Yes / No   |

**Table 6:** *Setting ranges Non-directional overcurrent protection, Instantaneous stage 3I>>>, 50-2*

| Description                           | Value  |
|---------------------------------------|--|
| Setting range of pick-up current I>>> | 0.5...25 x In in steps 0.001, infinite for CT variant<br>0.5...20 x In in steps 0.001, infinite for sensor variant |
| Operation mode                        | Definite time  |
| Operate time delay (DMT) t>>>         | 0.03...64 sec in steps of 0.01   |
| Reset ratio                           | 0.98   |
| Reset time                            | 40 ms  |
| Trig CBFP                             | Yes / No   |

## 4.2 Earth Fault Protection

### 4.2.1 Functionality

The earth-fault protection function is used as non-directional earth-fault protection for feeders.

The earth current can be calculated internally or measured externally by core balance current transformer.

The operate time characteristics for low stage can be selected to be either definite time (DT) or inverse definite minimum time (IDMT). The high stage always operates with the definite time (DT) characteristics.

### 4.2.2 Principle of Operation

The earth fault protection function continuously measures the neutral current of the protected object. The current is evaluated by the low stage (I<sub>0></sub> / 51N) and high stage (I<sub>0>></sub> / 50N) of earth fault over current functions.

On occurrence of fault, fulfilling the trip condition of respective stage, the LED “Trip” and “Trip I<sub>0</sub>” will be activated. Additionally the output relays (Trip and signalization) will be activated according the binary output configuration.

Each of the stages could be blocked by settings or via binary input of the relay.

## Protection and Control Function

### 4.2.3 Setting range of Earth fault Overcurrent Protection

**Table 7:** *Setting ranges Non-directional earth fault protection, Low stage  $I_{o>}$ , 51N*

| Description                               | Value   |
|---|---|
| Nominal value of earth current            | 1 A or 5A for CT variant, 1A for sensor variant   |
| Setting range of pick-up current $I_{o>}$ | External earth :<br>0.01...2.0 x $I_n$ in steps 0.001, infinite<br>Internal earth :<br>0.1...2.0 x $I_n$ in steps 0.001, infinite   |
| Operate time delay (DT) $t_{o>}$          | 0.04...64 sec in steps of 0.01  |
| Operating curve type (IDMT)               | IEC 60255-3:<br>Normal inverse, Very inverse, Extremely inverse, Long-time inverse<br>ANSI C37.112:<br>Moderate inverse, Normal Inverse, Very inverse, Extremely inverse<br>Special curves:<br>RI inverse |
| Time multiplier setting $k_o$ (IDMT)      | 0.02...1.6, in steps of 0.01  |
| Reset ratio                               | IDMT : 0.96 and DT : 0.98   |
| Reset time                                | 40 ms   |
| Trig CBFP                                 | Yes / No  |

**Table 8:** *Setting ranges Non-directional earth fault protection, High stage  $I_{o>>}$ , 50N*

| Description                                    | Value   |
|--|---|
| Setting range of pick-up current ' $I_{o>>}$ ' | External earth:<br>0.05...12.5 x $I_n$ in steps 0.001, infinite<br>Internal earth:<br>0.5...12.5 x $I_n$ in steps 0.001, infinite |
| Operation mode                                 | Definite time   |
| Operate time delay (DMT) ' $t_{o>>}$ '         | 0.04...64 sec in steps of 0.01  |
| Reset ratio                                    | 0.98  |
| Reset time                                     | 40 ms   |
| Trig CBFP                                      | Yes / No  |

## 4.3 Negative-sequence overcurrent protection

### 4.3.1 Functionality

The negative-sequence overcurrent protection is used for increasing sensitivity to detect unbalance load or unsymmetrical feeder voltages.

The operate time characteristics is based on definite time (DT) i.e. function operates after a predefined operate time and resets when the fault current disappears.



### 4.3.2 Principle of Operation

The function is based on the measurement of negative sequence current. In a fault situation, the function starts when the negative sequence current ( $I_2$ ) exceeds the set value. When the set definite time operation timer has reached the value set by the operate delay time, the OPERATE output is activated.

On occurrence of fault, fulfilling the trip condition of respective stage, the LED “Trip” and programmable LED if configured will be activated. Additionally the output relays (Trip and signalization) will be activated according the binary output configuration.

The protection could be blocked by settings or via binary input of the relay.

**Table 9: Setting ranges Negative sequence overcurrent protection**

| Parameter                                    | Value (Range)                    |
|--|----------------------------------|
| Start value, ‘I2>’                           | 0.1...1.5 x In, in steps of 0.01 |
| Operate delay time, ‘tI2>’                   | 0.1 ... 300 sec, in steps of 0.1 |
| Block the negative phase sequence protection | 0 = No, 1 = Yes                  |
| Operation accuracy                           | ± 5.0% of set value              |
| Operation time accuracy                      | 3% of set value or ± 30ms        |
| Reset ratio                                  | 0.98                             |

## 4.4 Phase discontinuity protection

### 4.4.1 Functionality

The phase discontinuity protection is used for detecting unbalance situations caused by broken conductors.

The operate time characteristics is based on definite time (DT) i.e. function operates after a predefined operate time and resets when the fault current disappears.

### 4.4.2 Principle of Operation

The unbalance of network is detected by monitoring the ratio of negative sequence current to positive sequence current  $I_2/I_1$ . The function operates when the ratio of unbalance current  $I_2/I_1$  exceeds the set value. When the set definite time operation timer has reached the value set by the operate delay time, the OPERATE output is activated.

On occurrence of fault, fulfilling the trip condition of respective stage, the LED “Trip” and programmable LED if configured will be activated. Additionally the output relays (Trip and signalization) will be activated according the binary output configuration.

## Protection and Control Function

The phase discontinuity protection will be inhibited when all phase currents fall below  $0.1 \times I_n$ .

The protection could be blocked by settings or via binary input of the relay.

**Table 10: Setting ranges Phase discontinuity protection**

| Parameter                                | Value (Range)                   |
|--|---------------------------------|
| Start value, 'I2/I1>'                    | 10... 100%, in steps of 1%      |
| Operate delay time, 'tI2/I1>'            | 0.1 ... 64 sec, in steps of 0.1 |
| Block the phase discontinuity protection | 0 = No, 1 = Yes                 |
| Operation accuracy                       | $\pm 5.0\%$ of set value        |
| Operation time accuracy                  | 3% of set or $\pm 30$ ms        |
| Reset ratio                              | 0.98                            |

## 4.5 Circuit breaker failure protection

### 4.5.1 Functionality

The circuit breaker failure protection function provides re-trip and back-up trip signal in case circuit breaker under operation fails to open. Function is activated by trip commands from the protection functions or via external protection trip using binary input.

The function has two independent timers for trip purposes: a re-trip timer for the repeated tripping of its own breaker and a back-up timer for the trip logic operation for upstream breakers.

The protection could be blocked by settings of the relay.

### 4.5.2 Principle of Operation

The operation of the breaker failure protection can be described using a module diagram.

Protection and Control Function

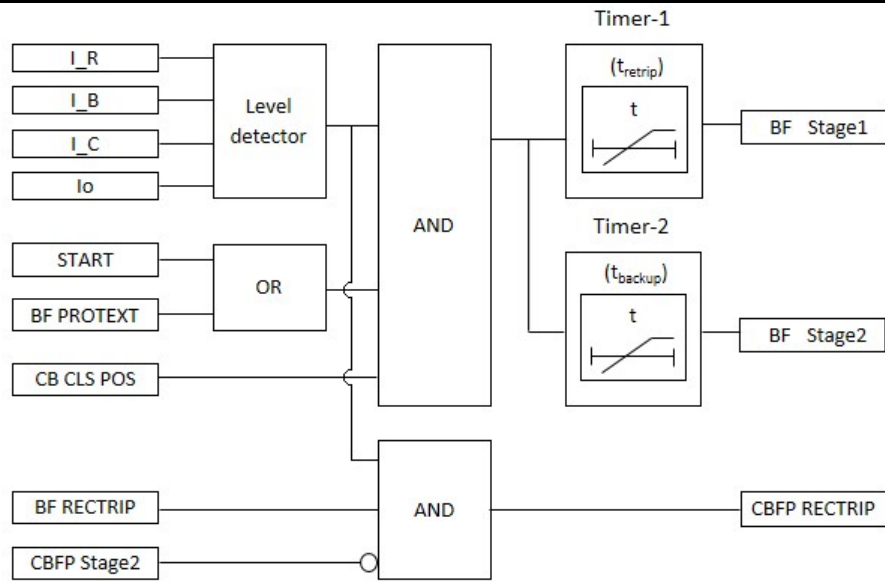

Figure 3: Circuit breaker failure protection functional module diagram

The measured phase currents are compared phasewise to the set  $I_{CBFP}$ . Similarly the neutral current is compared to the set  $I_{oCBFP}$ . If either of these measured values exceeds the respective setting, the level detector gives permissive to CBFP initiation logic.

The CBFP initiation logic is triggered by the rising edge of the START (from protection function  $I>$ ,  $I>>$ ,  $I>>>$ ,  $I_o>$  and  $I_o>>$ ) input or by the rising edge of the BF PROTEXT input wired to digital input of relay as external protection trip.

**Retrip function**

On receipt of trigger signal and reporting of exceeding value of the current by level detector, the CBFP initiation logic activates Timer 1. In case if relay is configured to received CB closed position information at any binary input that information is also used in deciding activation of Timer 1.

Once activated, the timer runs until the set  $t_{retrip}$  value has elapsed. The time characteristic for retrip function is according to definite time. When the operation timer has reached the maximum time value, the BF STAGE1 output is activated.

**Backup trip function**

The Timer 2 for backup trip function activates after timer 1 expires. Once activated, the timer runs until the set  $t_{backup}$  value has elapsed. The time characteristic is according to definite time. When the operation timer has reached the maximum time value, the BF STAGE2 output is activated.

In both retrip as well backup trip conditions, the timer reset immediately when the current value in all three phases decreases below  $I_{CBFP}$ , and neutral current decrease below  $I_{oCBFP}$ .

## Protection and Control Function

However in case where CB closed position information is also used, the timer resets immediately when CB closed position changes to False (i.e. CB opens).

### Inter-trip receive function

This block accepts the breaker failure inter trip input from the other IED. The input is accepted on receipt of binary input BF RECTRIP provided its own BF STAGE2 is not active.

The inter-trip logic on acceptance of receipt of binary input will activate binary output BF RECTRIP if the level detector is reporting the exceeding of the value.

The pulse duration of BF STAGE1, BF STAGE2 and BF RECTRIP output is 200ms.

**Table 11: Setting ranges Breaker failure protection**

| Parameter                                    | Value (Range)                    |
|--|----------------------------------|
| Operating phase current, 'ICBFP'             | 0.2...2.0 x In, in steps of 0.1  |
| Operating neutral current, 'loCBFP'          | 0.1...2.0 x In, in steps of 0.1  |
| Time delay for retrip, 'tretrip'             | 0.06...0.5 sec, in steps of 0.01 |
| Time delay for backup protection, 'tbackup'  | 0.06...0.5 sec, in steps of 0.01 |
| Block the circuit breaker failure protection | 0 = No, 1 = Yes                  |
| Operation accuracy                           | ± 5.0% of set value              |
| Operation time accuracy                      | 3% of set value or ± 30ms        |

## 4.6

### Setting groups

REF601/REJ601/REM601 Ver. 2.2 FP1 supports two setting groups. Customer can change the active setting groups at run time.

The active setting group can be changed by a setting parameter or via binary input.

User has an option to select number of setting groups required in the IED via setting "No of SG", default set as 1. When setting group is selected as 2, user needs to select active setting group via "Active SG".

## 4.7

### Auto-reclose function

#### 4.7.1

#### Functionality

Majority of overhead line faults are transients in nature and automatically cleared by momentarily de-energizing the line. De-energizing of the fault location for a selected time period is implemented through automatic reclosing, during which most of the faults can be cleared.

In case of a permanent fault, the automatic reclosing is followed by final tripping. The auto-reclose function can be used with any circuit breaker suitable for auto-reclosing. The function provides four programmable auto-reclose cycles and can be set to perform one to four successive auto-reclosures of desired duration.

## 4.7.2 Principle of operation

### Initialization logic

There are two methods by which function can be initialized. The method to be used depends on *O→I start mode* setting. Possible options for this settings are

- Mode 1 = Trip
- Mode 2 = Gen Start & Trip

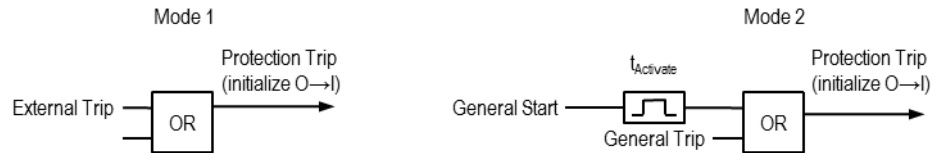

Figure 4: Initiation logic

Mode 1 operation:

The function is initialized on the rising edge of the external trip signal (received via binary input and Modbus, provided they are not blocked).

Remark: However in addition it is required that circuit breaker is in closed position AND auto reclosure is not blocked AND circuit breaker is in ready condition (if *CB ready* setting is selected as O-C-O).

Mode 2 operation:

The function is initialized on rising signal of the general trip signal (which will be an OR of trip of I>, I>>, I>>>, Io>, Io>>, I2>, I2/I1>) if it is received within time set via Activate t of receipt of general start signal (which will be an OR of start of I>, I>>, I>>>, Io>, Io>>, I2>, I2/I1>).

However in addition it is required that circuit breaker is in closed position AND auto reclosure is not blocked AND circuit breaker is in ready condition (if *CB ready* setting is selected as O-C-O).

The initialization of the auto reclosures function will be registered as an event “O→I Started”.

The auto-reclose function can be set off by setting *O→I cycle* to “0”.



In case if no binary inputs are configured for indicating circuit breaker position, the setting *O→I cycle* will automatically sets to “0” (Auto Reclose not in use) to avoid any mal-operation.

### Auto reclose control

The auto reclose control initiated by above described initiation logic follows following schematic:

Protection and Control Function

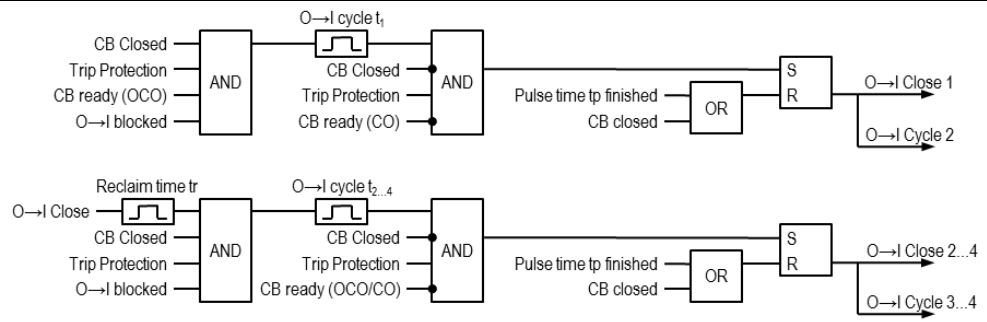

Figure 5: Auto reclose control

O→I cycle 2 ... 4 are initiated with a protection trip signal according the selected initiation logic during the set reclaim time  $t_r$ , which is started by close command of the previous O→I cycle. For the start of O→I cycle 2 ... 4 the CB ready signal is not considered.

The auto reclose cycle could get interrupted respective aborted by the signal O→I blocked and result in a final trip:

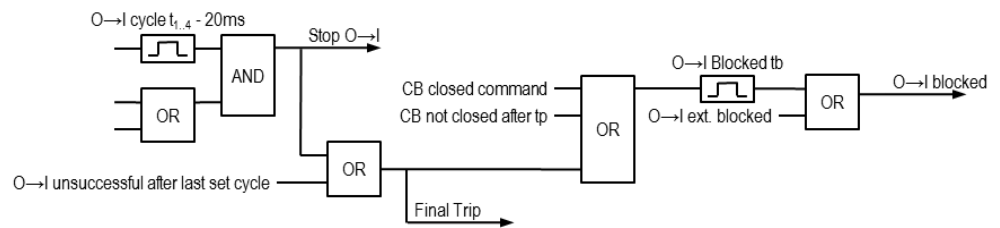

Figure 6: Auto reclose control



If the CB gets closed manually, the auto reclose function is blocked for the time  $t_b$ .

In case if no binary inputs are configured for indicating circuit breaker position, the setting O→I cycle will automatically sets to “0” (Auto Reclose not in use) to avoid any mal-operation.

4.7.2.1

Setting range for Auto-reclose function

Table 12: Setting ranges for Auto-reclose function I ↔ O, 79

| Parameter      | Description   | Range                                   | Unit | Step | Default |
|----------------|---|---|------|------|---------|
| O→I start mode | Auto reclose initialization mode  | 1 = Select Trip<br>2 = Gen Start & Trip |      | 1    | 1       |
| CB ready       | Type of CB ready signal available   | 1 = OCO<br>2 = CO                       |      | 1    | 1       |
| # of cycle     | Number of Auto reclose cycles (0 = Auto-reclose not in use)                 | 0 ... 4                                 |      | 1    | 1       |
| Activate t     | Time between General Start and General Trip for activation of O→I in Mode 2 | 0.1 ... 5                               | s    | 0.1  | 0.8     |

## Protection and Control Function

Table 12 Setting ranges for Auto-reclose function I &lt;-&gt; O, 79, continue

| Parameter  | Description                             | Range               | Unit | Step | Default |
|------------|---|---------------------|------|------|---------|
| Pulse tp   | Auto reclose pulse time                 | 0.2 ... 20.0 [s]    | s    | 0.1  | 0.2     |
| Cycle t1   | Dead time for first auto reclose cycle  | 0.20 ... 300.00 [s] | s    | 0.01 | 0.5     |
| Cycle t2   | Dead time for second auto reclose cycle | 0.20 ... 300.00     | s    | 0.01 | 0.5     |
| Cycle t3   | Dead time for third auto reclose cycle  | 0.20 ... 300.00     | s    | 0.01 | 0.5     |
| Cycle t4   | Dead time for fourth auto reclose cycle | 0.20 ... 300.00     | s    | 0.01 | 0.5     |
| Reclaim tr | Reclaim time                            | 1 ... 300           | s    | 1    | 1       |
| Block tb   | Auto reclosure block time.              | 1 ... 300           | s    | 1    | 5       |

## 4.7.2.2

## Configurable inputs to Auto-reclose function

Table 13: Configurable inputs to Auto-reclose function I &lt;-&gt; O, 79

| Name        | Type | Description                                 |
|-------------|------|---|
| CB CLOS POS | BOOL | Circuit breaker closed position information |
| EXT TRIP    | BOOL | External trip input                         |
| CB READY    | BOOL | Circuit breaker ready information           |

## 4.7.2.3

## Configurable outputs of Auto-reclose function

Table 14: Configurable Outputs to Auto-reclose function I &lt;-&gt; O, 79

| Name            | Type | Description  |
|-----------------|------|--|
| O→I CLOSE       | BOOL | Closing command from auto reclosure                        |
| O→I IN PROGRESS | BOOL | Reclosing cycle in progress, activated during reclose time |
| FINAL TRIP      | BOOL | Final trip from auto reclosure                             |
| O→I BLOCKED     | BOOL | Auto reclosure blocked                                     |

## Protection and Control Function

## 4.8 Thermal overload protection

### 4.8.1 Functionality

The thermal overload protection protects the apparatus from overheating, which causes the premature insulation failures. The protection function has two modes of operation, one for static apparatus like cables, feeders and transformers (REF601 and REJ601) and an additionally mode for motor / rotating machines (only available in REM601). The function models the thermal behavior of apparatus on the basis of the measured load current and disconnects the apparatus when stored thermal energy has reached the level of set value.

The maximum permanently stored energy at maximum load current is defined as 100%.

Additionally the user can set an alarm level  $\vartheta_{\text{alm}}$  to indicate the potential risk.

### 4.8.2 Principle of operation

The function use for the calculation of the function the highest load current of the three phases.

Thermal model:

The thermal model can be divided into three conditions:

1. warming of apparatus – (diabatic behavior or adiabatic behavior),
2. no change in thermal image
3. Cooling of the apparatus.

#### 1. Warming of the protected object:

Warming of the protected object can be segregated into two types, diabatic and adiabatic behavior. In diabatic behavior, the protected object have a heat dissipation with the environment during warming itself due to the load current.

For current greater than twice the base current  $I_b$  (also known as rated current or full load current) the behavior is classified as adiabatic, this means, that the heat exchange with the environment during warming is considerable small related to the heating.

Warming is defined as:

$$\vartheta_0 < \left(\frac{I}{I_b}\right) * 100[\%]$$

$\vartheta_0$  = present value of thermal image

$I$  = maximum value of measured phase currents

$I_b$  = base current (rated current/full load current defined by setting).



## Protection and Control Function

Thermal characteristic warming condition at diabatic behavior:

$$\vartheta_1 = \vartheta_0 + \left( \left( \frac{I}{I_b} \right)^2 - \vartheta_0 \right) * \left( 1 - e^{-\left( \frac{\Delta t}{\tau \uparrow} \right)} \right)$$

$\vartheta_1$  = new value of thermal image

$\vartheta_0$  = present value of thermal image

$I$  = maximum value of measured phase currents

$I_b$  = base current (rated current/full load current defined by setting).

$\Delta t$  = time interval between  $\vartheta_0$  and  $\vartheta_1$

$\tau \uparrow$  = Heating time constant

Thermal characteristic warming condition at adiabatic behavior:

$$\vartheta_1 = \vartheta_0 + \left( \frac{I}{I_b} \right)^2 * \left( \frac{\Delta t}{\tau \uparrow} \right)$$



The value of  $\vartheta_0$  at the start of the function (i.e. at power on of the IED) is defined by a setting

### 2. Constant thermal image of protected object:

During this condition, the dissipated heat is equal to heat generated by the current flowing through the protected object.

The thermal model for this conditions is as follow:

$$\vartheta_1 = \vartheta_0$$

whereas:

$$\vartheta_0 = \left( \frac{I}{I_b} \right)^2 * 100[\%]$$

$\vartheta_1$  = new value of thermal image

$\vartheta_0$  = present value of thermal image

$I$  = maximum value of measured phase currents

$I_b$  = base current (rated current/full load current defined by setting).

### 3. Cooling of protected object:

When the current reduces compared to previous condition or the motor has stopped it results into cooling of an apparatus.

Cooling condition is defined when:

$$\vartheta_0 > \left( \frac{I}{I_b} \right)^2 * 100[\%]$$

The thermal model used during cooling condition for standing objects (cable / transformer / standing motor) is:

$$\vartheta_1 = \left( \frac{I}{I_b} \right)^2 + \left( \vartheta_0 - \left( \frac{I}{I_b} \right)^2 \right) * e^{-\left( \frac{\Delta t}{\tau_{d,s}} \right)}$$

## Protection and Control Function

The thermal model used during cooling condition for rotating machines is:

$$\vartheta_1 = \left(\frac{I}{I_b}\right)^2 + \left(\vartheta_0 - \left(\frac{I}{I_b}\right)^2\right) * e^{-\left(\frac{\Delta t}{\tau_{lr}}\right)}$$

$\vartheta_1$  = new value of thermal image

$\vartheta_0$  = present value of thermal image

$I$  = maximum value of measured phase currents

$I_b$  = base current (rated current/full load current defined by setting).

$\Delta t$  = time interval between  $\vartheta_0$  and  $\vartheta_1$

$\tau_{ls}$  = Cooling time constant of standing objects

$\tau_{lr}$  = Cooling time constant of rotating objects (only REM601)

### Emergency start function for motors:

An additionally configurable start emergency input (START\_EMERG) is provided. When the activated, the emergency mode is activated, which temporary increase the thermal trip value  $\vartheta_{trip}$  by the setting  $\vartheta_{EM}$  in %. For function to remain in emergency mode, it is required that START\_EMERG remains active continuously. As soon as the input is deactivated, trip value will restore back to original setting. The activation and deactivation of input START\_EMERG is recorded as an event.

### Block closing of CB

To prevent overheating of hotspots within a motor during startup, the restart could be blocked if the actual thermal image is above by the setting of  $\vartheta_{startinhibit}$ . During this condition the output to block closing of the CB (BLK\_CLOSE) is activated.

When BLK\_CLOSE is active closing of CB is not allowed by any means (i.e. communication or HMI or binary input). The activation and deactivation of BLK\_CLOSE will be recorded as an event.



The thermal value of at the start of the function (i.e. at power on of the IED) is defined by a setting

### Behavior of thermal image during power down condition of IED:

Condition arises where in the power supplied to the IED is interrupted. The user could select four different behaviors / options to calculate the thermal level when the power is restored. These options are selectable by the setting Mode  $\vartheta_{powerOFF}$ .

The thermal image along with time is stored every 60 sec. (and for option 1 also the actual maximum phase current).

Protection and Control Function

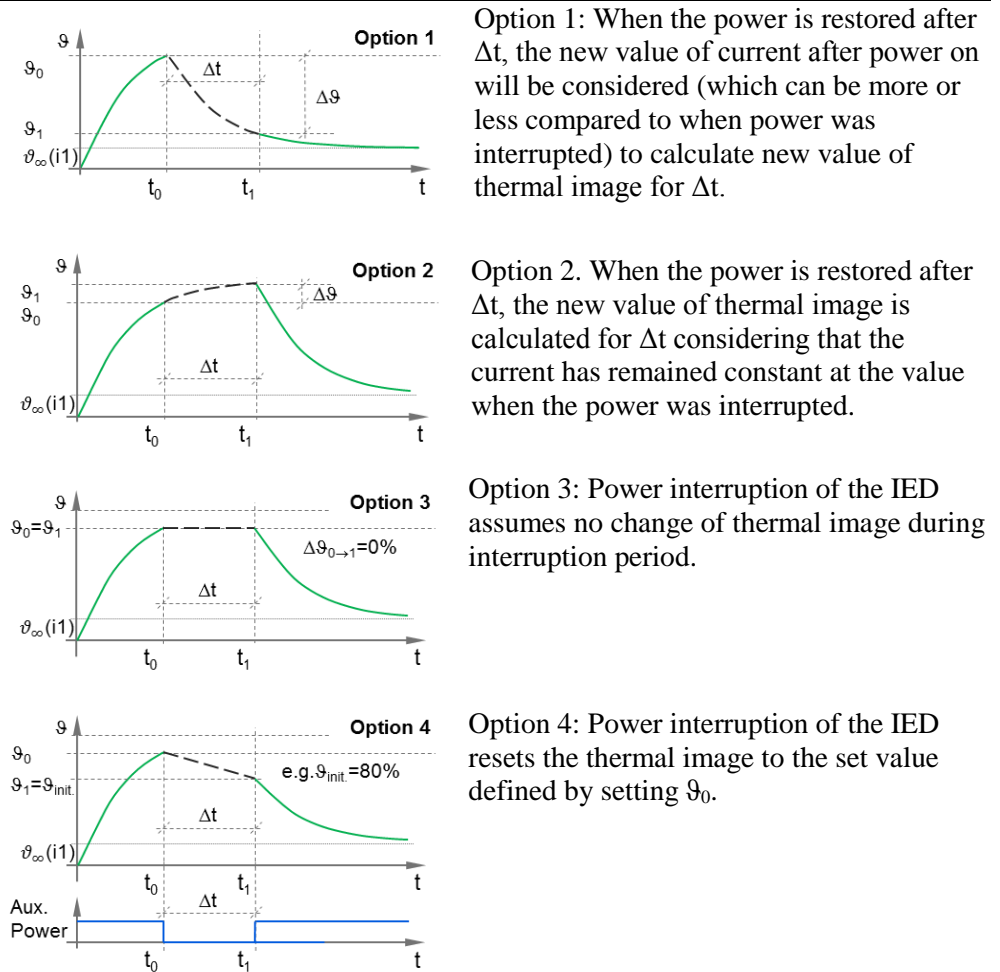

Figure 7: Behavior of thermal image during power down condition

4.8.2.1

Setting range for thermal overload protection

Table 15: Setting range for thermal overload protection 3lth, 49

| Parameter                  | Description                                      | Range                      | Unit | Step | Default |
|----------------------------|--|----------------------------|------|------|---------|
| Mode $\vartheta$           | Mode of thermal overload protection*             | 0 = rotating<br>1 = static | -    | 1    | 0       |
| $\vartheta_0$              | Initial thermal level of the apparatus           | 0...100                    | %    | 1    | 80      |
| $I_b$                      | Reference current leading to thermal calculation | 0.1 ... 1.5                | xIn  | 0.1  | 1.0     |
| $\tau_t$                   | Heating time constant of machine                 | 1 ... 300                  | min  | 1    | 45      |
| $\tau_{is}$                | Cooling time constant of static machine          | 1 ... 300                  | min  | 1    | 45      |
| $\tau_{ir}$                | Cooling time constant of rotating machine*       | 1 ... 1000                 | min  | 1    | 180     |
| $\vartheta_{alm}$          | Alarm value                                      | 50 ... 200                 | %    | 1    | 121     |
| $\vartheta_{trip}$         | Operate value                                    | 50 ... 200                 | %    | 1    | 144     |
| $\vartheta_{startinhibit}$ | Start inhibit value                              | 50 ... 200                 | %    | 1    | 105     |

## Protection and Control Function

**Table 15:** *Setting range for thermal overload protection 3lth, 49, continue*

| Parameter                   | Description  | Range     | Unit | Step | Default |
|-----------------------------|--|-----------|------|------|---------|
| $\vartheta_{EM}$            | Percentage by which $\vartheta_{trip}$ will be increased in emergency mode | 10... 100 | %    | 1    | 50      |
| Mode $\vartheta_{powerOFF}$ | Options for calculating thermal value during power interruption            | 1...4     | -    | 1    | 4       |

\*Setting in REF601 and REJ601 hidden (fixed set to static mode)

### 4.8.2.2

### Configurable inputs to thermal overload protection

**Table 16:** *Configurable inputs to thermal overload protection 3lth, 49*

| Name  | Type | Description      |
|-------|------|------------------|
| RESET | BOOL | Reset protection |
| BLOCK | BOOL | Block protection |

### 4.8.2.3

### Configurable outputs of thermal overload protection

**Table 17:** *Configurable inputs to thermal overload protection 3lth, 49*

| Name        | Type | Description            |
|-------------|------|------------------------|
| ALARM       | BOOL | Alarm                  |
| OPERATE     | BOOL | Operate                |
| $\vartheta$ | REAL | Value of thermal image |

## 4.9

## Motor start up supervision / Stalling protection

### 4.9.1

### Functionality

Motor start up supervision function is designed for protection of motors against excessive starting time and locked rotor conditions during motor starting. The starting of the motor is supervised by monitoring the magnitude of all the phase currents. During startup period of the motor, function calculates the integral of the  $I^2t$  value. If the calculated value exceeds the set value, the operate signal is activated.

Function also has the provision to accept the speed switch input, which means protection suitable for motors having permissible stalled time more than starting time. The function also covers repetitive (cumulative) startup function which protects motor from too frequent startup attempts, causing overheating of motor.

---

## 4.9.2 Principle of operation

### Startup detection

The starting condition of the motor is detected by startup detection. The function initially recognizes the de-energized condition of the motor when the values of all three phase currents are less than  $0.12 \times I_b$  for longer than 5s. If any of the phase currents of the de-energized condition rises to a value equal to or greater than  $I_{start}$  within 100ms, the motor start output signal is activated indicating that the motor startup is in progress. At the same time  $I^2t$  protection is also enabled.

The motor start output remains active until the values of all three phase currents drops below set value of  $I_{start}$  and remains below that level for a time period of 500ms to take into consider short voltage dip or interruption into account. If the current is not reached up to  $I_{start}$  within 100ms, the occurrence is not considered to be a normal starting sequence.

In addition during startup condition (i.e. when motor start is active), the start value settings for  $I>$ ,  $I>>$ ,  $I>>>$  gets doubled and functions  $I_o>$  and  $I_o>>$  gets blocked if Blocking/doubling feature is enabled. This feature can be enabled or disable by a setting "Restraint 68M". The function  $I_o>$  and  $I_o>>$  is blocked to avoid mal operation due to CT saturation during starting.

The start time (t motor start) of the last motor startup is recorded and available as measurement. Also the maximum startup current is recorded and available as measurement on LHMI as well as available over communication. Both these measurement is available in non-volatile memory. The values are updated in memory each new startup of motor.

### Speed switch input

Speed switch is used to indicate whether a motor is accelerating during startup or not. At motor standstill, the Spd Sw input is active (i.e. the input available from speed switch), indicating that the rotor is not rotating. When the motor has started, at certain revolution the deactivation of the Spd Sw by the speed switch indicates that the rotor is rotating. If the input is not deactivated within the t locked rotor, the Trip output is activated indicating that the rotor is locked.

If the speed switch is not configured at any binary input this feature is blocked internally.

### Thermal stress $I^2t$ calculator

This function gets activated during startup detection and calculates the thermal stress developed in the motor during startup condition. The heat developed during the starting is equal as the integral of  $I^2t$ . The function integrates the value of  $I^2t$  and compares it to the limiting value obtained from the product of the square of the values of the  $I_{startup}$  and t startup settings. When the calculated value of the thermal stress exceeds this limit, the Trip output is activated.

## Protection and Control Function

The calculation is stopped once motor is in running condition.

In case if speed switch is employed, deactivation of speed switch indicates that the motor is now rotating and  $I^2t$  protection is blocked.

### Cumulative startup protection

This function protects the motor from an excessive number of startups.

When the motor is started, the 1st timer will be started and it resets after the supervised time  $t_n$ . When the motor is started next time, the next non-active timer will start. Function will count the number of active timers at a particular instant. If the active timers are greater than or equal to set maximum possible setting, it results into activation of binary output which can be used to block closing operation (blocking further restart).



If supervised time  $t_n$  setting is decreased, then the running timer which are greater than  $t_n$  will be forced to be equal to new supervised time  $t_n$ .

When the function inhibits further restart, it is possible to view the time remaining for next restart RStr\_Ena\_t in the measurement view.

When the ESTART RQ emergency start is set high, the cumulative restart inhibit binary output (i.e. BLK CLOSE) will get blocked as long as the emergency start signal is active. However the new timer will start as well as the count -down of other active timers will continue in background.

#### 4.9.2.1

### Setting range for startup supervision / stalling protection

**Table 18:** Setting range for startup supervision/stalling protection I2t n<, 51LRS/14/48/66

| Parameter      | Description  | Range       | Unit              | Step | Default |
|----------------|--|-------------|-------------------|------|---------|
| Istart         | Current value for detecting starting of motor              | 1.0 .. 10.0 | xIb <sup>1)</sup> | 0.1  | 1.3     |
| Restraint 68M  | Disable/Enable the doubling / blocking of OC-EF protection | Yes / No    | -                 | -    | No      |
| Istartup       | Motor starting current                                     | 1.0...10.0  | xIb               | 0.1  | 6.0     |
| t startup      | Motor starting time  | 5...120     | s                 | 1    | 12      |
| t lockedrotor  | Permitted stalling time                                    | 2...120     | s                 | 1    | 12      |
| Max Str        | Maximum start allowed per defined supervised time          | 1 ... 10    | -                 | 1    | 3       |
| t <sub>n</sub> | Supervised time allowed for maximum starts                 | 1...180     | Min               | 1    | 60      |

<sup>1)</sup> Ib rated current of motor defined by base current setting

### 4.9.2.2 Inputs to Motor startup / Stalling protection

**Table 19:** *Inputs to startup supervision/stalling protection I2t n<, 51LRS/14/48/66*

| Parameter       | Type | Description  |
|-----------------|------|--|
| I <sub>L1</sub> | REAL | Phase A current  |
| I <sub>L2</sub> | REAL | Phase B current  |
| I <sub>L3</sub> | REAL | Phase C current  |
| Spd Sw          | BOOL | Input signal for showing the motor is not stalling (from speed switch) |

**Table 19:** *Inputs to startup supervision/stalling protection I2t n<, 51LRS/14/48/66, continue*

| Parameter | Type | Description                           |
|-----------|------|---------------------------------------|
| BLOCK     | BOOL | Blocking of function via binary input |

### 4.9.2.3 Outputs to Motor startup / Stalling protection

**Table 20:** *Outputs from startup supervision/stalling protection I2t n<, 51LRS/14/48/66*

| Parameter             | Type | Description  |
|-----------------------|------|--|
| Motor start           | BOOL | Motor startup indication                                   |
| Stall trip            | BOOL | Motor operate signal for stalling protection.              |
| I <sup>2</sup> t trip | BOOL | Motor operate signal for thermal stress.                   |
| Block close           | BOOL | Lockout condition for restart of motor                     |
| t <sub>MS</sub>       | REAL | Measured motor latest startup time in sec                  |
| I <sub>str max</sub>  | REAL | Measured motor latest current time in amp                  |
| Restart Enabled t     | REAL | Time left for restart when lockstart is enabled in minutes |

## 4.10 Phase reversal protection

### 4.10.1 Functionality

The phase reversal protection is used to detect the reversed connection of the phases to a three-phase motor by monitoring the negative phase sequence current (I<sub>2</sub>) of the motor. Function starts when the negative sequence current (I<sub>2</sub>) exceeds the set value. The operate time characteristics is based on definite time (DT) i.e. function operates after a predefined operate time.

### 4.10.2 Principle of operation

The measured negative sequence current is compared to the set I<sub>2R</sub>>. If the measured value exceeds the set I<sub>2R</sub>>, the level detector activates the timer module. On activation, timer activates the I<sub>2R</sub>> START output. The time characteristic is according to Definite Time (DT). When the operation timer has reached the value set by the tI<sub>2R</sub>>, the protection TRIP output is activated. If the fault disappears before the module operates, the function resets immediately, and the protection START output is deactivated.

The protection could be blocked by settings or via binary input of the relay.

## Protection and Control Function

**Table 21: Setting ranges Phase reversal protection**

| Parameter                                    | Value (Range)                                 |
|--|---|
| Start value, 'I2R>'                          | 0.1...1.5 x I <sub>b</sub> , in steps of 0.01 |
| Operate delay time, 'tI2R>'                  | 0.1 ... 300 sec, in steps of 0.1              |
| Block the negative phase sequence protection | 0 = No, 1 = Yes                               |
| Operation accuracy                           | ± 5.0% of set value                           |
| Operation time accuracy                      | 3% of set value or ± 30ms                     |
| Reset ratio                                  | 0.98  |

## 4.11 Under current protection

### 4.11.1 Functionality

The under current protection is used to detect a sudden loss of load which is considered as a fault condition. Function starts when the current is less than the set limit. It operates with the definite time (DT) characteristics i.e. function operates after a predefined operate time and resets when the fault current disappears

### 4.11.2 Principle of operation

The measured three phase current is compared to the set  $3I_{<}$  value. If the measured value is less than the set  $3I_{<}$  value, in all the three phases the level detector activates the timer module and will activate binary output  $3I_{<}$  Start. The level detector is enabled only after all three phase currents are above the set  $3I_{<}$  value for at least 5sec before the comparison is initialized.

The function is blocked internally when current in all three phases are below  $0.12 \times I_n$  (which is considered as stopped condition)

The time characteristic is according to Definite Time (DT). When the operation timer has reached the value set by the  $t_{3I_{<}}$  value, the  $3I_{<}$  Trip output is activated. If the fault disappears before the module operates, the reset timer is activated. It is a fixed timer of 40msec, when the timer reaches 40msec, the operate timer resets.

The protection could be blocked by settings or via binary input of the relay.



The START output of the function can be configured at alarm LEDs, however activation of START output will not result into activation of START LED or any event logging.



## Protection and Control Function

Table 21: *Setting ranges Under current protection*

| Parameter                           | Value (Range)                      |
|-------------------------------------|------------------------------------|
| Start value, '3I<'                  | 0.12...0.80 x Ib, in steps of 0.01 |
| Operate delay time, 't3I<'          | 0. ... 30 s, in steps of 0.1       |
| Block the phase reversal protection | 0 = No, 1 = Yes                    |
| Operation accuracy                  | ± 5.0% of set value                |
| Operation time accuracy             | 3% of set or ± 30 ms               |
| Reset ratio                         | 0.98                               |

## 4.12 Emergency restart

### 4.12.1 Functionality

An emergency restart function helps to keep essential critical motors in running condition by allowing motor start up even though start inhibit is active. The emergency startup function ESMGAPC allows motor startup during emergency conditions. After the emergency start input is activated, the motor can be started normally.

### 4.12.2 Principle of operation

Emergency restart function has fixed timer of 10 min. which can be activated when the binary input ESTART RQ is activated and motor standstill condition (all the three phase currents are below 0.12xIn) is fulfilled.

When emergency start input is the activated, it temporary increases the thermal trip value  $\mathcal{I}_{trip}$  by the setting  $\mathcal{I}_{EM}$ . Once emergency start input is activated, it remains active for duration of 10min or until it is kept pressed whichever is higher. The activation and deactivation of input START\_EMERG is recorded as an event.

## 4.13 Motor runtime counter

### 4.13.1 Functionality

The generic runtime counter function MDSOPT calculates and presents the accumulated operation time of a motor as the output. The unit of time for accumulation is hour.

The accumulated operation time is one of the parameters for scheduling a service for the motors. It indicates the use of the motor and hence the mechanical wear and tear. Generally, the equipment manufacturers provide a maintenance schedule based on the number of hours of service.

## Protection and Control Function

### 4.13.2 Principle of operation

This module counts the operation time. When current in any phase exceeds  $0.12 \times I_n$  the counter is activated and starts counting. The count is continuously added to the time duration until all current drops below  $0.12 \times I_n$ . The unit of time duration count for RUN\_TIME is hour. The value is available through the monitored data view.

The RUN\_TIME output is a continuously increasing value and it is stored in a non-volatile memory.

Resetting of the counter can be done by changing the setting value. As soon as new setting is saved the counter will get reset and will be registered as an event. The counter will count up to  $2^{16}$  after which counter will overflow and restart from 0.

*Table 21: Setting ranges counter*

| Parameter   | Value (Range)  |
|---|--|
| Initial value of the counter at the start of IED, 'Value' | 0...65535, in steps of 1   |
| Binary input configured at PULSE_INPUT, 'Blconf'          | 1...4 (1=BI1, 2=BI2, 3=BI3, 4=BI4)<br>'-' no selection if counter selection not needed |

## 4.14 Protection characteristics

### 4.14.1 Time / Current characteristics

Relay offers three-stage overcurrent and two stage earth-fault protection functions. The low-set stage of overcurrent protection and earth-fault protection are equipped with standard Inverse Definite Minimum Time (IDMT) characteristics – (Normal Inverse (NI), Extreme Inverse (EI), Long Inverse (LI), and Very Inverse (VI)) along with definite time (DT) characteristics for better co-ordination with rest of the network. Additionally special characteristic curve RI is also provided. The high stage and instantaneous stage for over current protection and high stage earth fault protection come with DT characteristics.

When IDMT characteristic has been selected, the operating time of the stage will be a function of the current; the higher the current, the shorter the operating time. The stage includes ten different time/current curve sets – four according to the BS 142 and IEC 60255 standards namely normal inverse, very inverse, extremely inverse, longtime inverse, four according ANSI C37.xxx standard namely moderate inverse, normal inverse, very inverse, extremely inverse and one special curve, named RI type curve along with DT characteristics.

### 4.14.2 IEC 60255-3 IDMT characteristic

The relationship between current and time for standard normal inverse, very inverse, extremely inverse and long-time inverse complies with the BS 142.1966 and IEC 60255-3 standards and can be expressed as follows:

$$t = \frac{(K * \beta)}{\left(\frac{I}{I_{set}}\right)^\alpha - 1}$$

Where,

- $t$  = operate time in seconds
- $K$  = time multiplier
- $I$  = measured current value
- $I_{set}$  = set start current value

The slope of the time/current characteristics shall be determined by the constants  $\alpha$  and  $\beta$  as indicated below:

**Table 22: Values of constant  $\alpha$  and  $\beta$**

| Slope of the time/current curve set | $\alpha$ | $\beta$ |
|-------------------------------------|----------|---------|
| IEC – Normal inverse                | 0.02     | 0.14    |
| IEC – Very inverse                  | 1.0      | 13.5    |
| IEC – Extremely inverse             | 2.0      | 80      |
| IEC – Long time inverse             | 1.0      | 120     |

### 4.14.3

### ANSI C37.112 IDMT characteristic

The relationship between current and time for standard moderate inverse, normal inverse, very inverse, extremely inverse complies with the ANSI C37.112 standards and can be expressed as follows:

Where:

$$t = \left( \frac{\beta}{\left(\frac{I}{I_{set}}\right)^\alpha - 1} + \gamma \right) * K$$

Where,

- $t$  = operate time in seconds
- $K$  = time multiplier
- $I$  = measured current value
- $I_{set}$  = set start current value

The slope of the time/current characteristics shall be determined by the constants  $\alpha$  and  $\beta$  and  $\gamma$  as indicated below:

**Table 23: Values of constant  $\alpha$ ,  $\beta$  and  $\gamma$**

| Slope of the time/current curve set | $\alpha$ | $\beta$ | $\gamma$ |
|-------------------------------------|----------|---------|----------|
| ANSI – Moderate inverse             | 0.02     | 0.0515  | 0.1140   |
| ANSI – Normal inverse               | 0.02     | 0.0086  | 0.0185   |
| ANSI – Very inverse                 | 2.0      | 19.61   | 0.491    |
| ANSI – Extremely inverse            | 2.0      | 28.2    | 0.1217   |

## Protection and Control Function

---

### 4.14.4 RI type characteristic

The RI-type characteristic is a special characteristic used mainly in combination with existing mechanical relays. The characteristic is based on the following mathematical expression:

$$t = \frac{K}{\alpha - \beta \left( \frac{I_{set}}{I} \right)}$$

Where,

- t = operate time in seconds
- K = time multiplier
- I = measured current value
- Iset = set start current value
- $\alpha$  = 0.339
- $\beta$  = 0.236

### 4.15 Configurable Binary Outputs

The relay has total six output contacts, two power contact and four signaling contacts. Except BO4 (reserved to IRF signaling purpose), remaining can be individually configured as either Inverted or Non-Inverted and also can be configure for following different operating modes:

1. **Pulse mode (P):** In pulse mode, the binary output activates for a fixed duration of 200 ms when triggered
2. **Self-reset mode (S):** In self-reset mode, the binary output follows the behavior of the triggering signal. The output remains in active state till trigger persists.
3. **Hold mode (H):** Once output is activated, it will remain active even if trigger signal drops.  
Output can be reset by all possible reset input triggers
  - a local HMI by reset key combination
  - Reset binary input
  - Reset command from optional communication module via MODBUS / IEC60870-5-103.
4. **Lockout mode (L):** Once output is activated, it will remain active even if trigger signal drop.  
Output can be reset only by
  - a local HMI by reset key combination and
  - Reset binary input.

All above mode also supports Inverted (I) operation.



Operating mode for binary output BO4 is fixed to “Non – inverted Self-Reset Mode.”

Protection and Control Function



By default all binary outputs are NO (Normally Open).  
 (Exception: BO1 in CEI configuration is NC (Normally Close))  
 During non-availability of power, binary output configured as Inverted will open and its status will be restored only after availability of power.

All binary outputs except BO4 can be triggered by different protection and control signals. It is possible to map same signal to trigger more than one binary output. The signals available for triggering binary outputs are as follows:

- Individual start of protection functions I>, I>>, I>>>, Io> and Io>>>
- Individual trip of protection functions I>, I>>, I>>>, Io> and Io>>>
- External trip (open) command available at binary input (configured for Breaker command operation) as well command available from MODBUS / IEC\_103 or Front HMI
- External close command available at binary input (configured for Breaker command operation) as well command available from MODBUS / IEC\_103 or Front HMI
- External user defined Signal 1 to Signal 3 available at binary input (configured via binary input menu)

Apart from above signals, the UNIT READY status is fixed configured at BO4 and cannot be changed. No other signals can be configured at BO4.

**Table 24: Trip and signaling contacts**

| Binary output | Default configuration  |
|---------------|--|
| BO1           | Default as Trip1 contact for O/C and E/F. Under relay healthy condition, this contact will remain open. In the event of trip/breaker open command, it will close.                        |
| BO2           | Default as Trip2 contact for breaker open output. In the event of fault (O/C and E/F) / breaker open command, it will close  |
| BO3           | Default as contact for Breaker close command. This contact will close, when breaker close command is received either from relay HMI or through communication.                            |
| BO4           | Non-configurable signaling contact for Unit ready / internal relay fault indication. Under relay healthy condition this will be in close condition. During internal fault this will open |
| BO5           | Default as signaling contact over current trip. In the event of phase faults (I>, I>> and I >>>) it will close and remain latched  |
| BO6           | Default as signaling contact earth fault trip. In the event of earth faults (Io> and Io>>) it will close and remain latched  |

## Protection and Control Function

## 4.16 Configurable LED

The relay has total five LED's for user defined signaling. They can be configured with the same signals as the binary output contacts. They can be individually configured for following different operating modes:

1. **Self-reset mode (S):** In self-reset mode, the LED follows the behavior of the triggering signal. The LED remains in active state till trigger persists.
2. **Hold mode (H):** Once LED is activated, it will remain active even if trigger signal drops.

LED can be reset by all possible reset input triggers

- a local HMI by reset key combination
- b Reset binary input
- c Reset command from optional communication module via MODBUS / IEC.

All five user defined LED's can be triggered by different protection and control signals. It is possible to map same signal to trigger more than one binary output. The signals available for triggering binary outputs are as follows:

- Individual start of protection functions I>, I>>, I>>>, Io> and Io>>>
- Individual trip of protection functions I>, I>>, I>>>, Io> and Io>>>
- External user defined Signal 1 to Signal 3 available at binary input (configured via binary input menu)

**Table 22:** LED indications (on relay front)

| LED            | Default configuration   |
|----------------|---|
| Ready (Green)  | LED indicates that relay has no internal fault and is powered up for desired functionality. It glows after internal health check after power on and continue to glow until power goes off or there is internal fault in the relay |
| Start (Yellow) | Start LED for any protection function start   |
| Trip (RED)     | Common trip LED for overcurrent and earth fault trip indication   |
| LED 1 (RED)    | User configured:<br>Default: Trip Ip => Trip overcurrent faults (I>, I>> and I>>>)  |
| LED 2 (RED)    | User configured:<br>Default: Trip Io => Trip earth faults (Io> and Io>>)  |
| LED 3 (RED)    | User configured:<br>Default: TCS Fault => trip circuit has failure  |
| LED 4 (RED)    | User configured:<br>Default: Spare (not configured)   |
| LED 5 (RED)    | User configured:<br>Default: Spare (not configured)   |

## 4.17 Configurable Binary Inputs

The IED has four binary inputs BI1 to BI4. Each binary input can be configured individually and supports various features. Binary input BI1 is fixed for blocking operation, whereas BI2 to BI4 are used for other than blocking operation. However for binary input BI2 to BI4, user at a time can configure one operation per binary input i.e., once any of the binary input BI2 to BI4 is configured for a particular operation, it is not available for other operation.

1. **Blocking:** Binary input BI1 is dedicate for blocking protection and control function. User depending on his need can configure this binary input to block individual protection functions viz., I>, I>>, I>>>, Io> and Io>> as well as to block breaker opening and closing command and trip circuit supervision e.g. with open circuit breaker position.

The function configured for blocking will remain in block state until BI1 is active.



BI1 configured to block breaker opening and closing command will block command received from local HMI or MODBUS or binary input.

2. **Circuit Breaker Status:** Binary inputs BI2 to BI4 can be configured to indicate the status of circuit breaker i.e. breaker open or breaker close or breaker in maintenance. The available status information is sent to MODBUS communication.
3. **Circuit Breaker Command:** Binary inputs BI2 to BI4 can be configured to provide external (remote) breaker open or breaker close command.



For routing circuit breaker opening or closing command from binary input, it is necessary that user also configures binary output to receive respective command.

4. **Reset:** Binary input BI2 to BI4 can be configured for reset operation. When the rising edge is detected, the IED resets all the protection and control functions (all internal timers are reset). It also resets the Start, Trip, Trip Ip, Trip Io and de-latches the binary output.
5. **Trip Circuit Supervision:** Binary input BI2 is used to receive the invalidity of trip circuit. No other binary input can be used for this purpose.
6. To the Binary input BI2 to BI4 also user defined signals could be configured, called Signal 1 to Signal 3. This Signals can be routed / connected in the binary output configuration menu directly to binary output contacts and additionally in the LED configuration menu to 5 LED's.

All binary inputs BI1 to BI4 also support Inverted (I) operation.

**Table 24:** Binary inputs

| Binary input | Default configuration  |
|--------------|--|
| BI1          | Default configured as UNBLOCK  |
| BI2          | Default configured as TCS  |
| BI3          | Default configured as external trip command to breaker                     |
| BI4          | Default configured as reset command for resetting indications and contacts |

Protection and Control Function

### 4.18 Breaker control and Trip command operation

Relay supports breaker control operation. The control operation can be done from control push-buttons provided on relay front, from remote via MODBUS communication or from signals wired to relay binary inputs duly configured for control operation.

### 4.19 Trip Circuit Supervision

**Application**

The Trip Circuit Supervision TCS detects faults in the electrical trip / open control circuit (which includes trip coil, trip contact, wiring and auxiliary voltage) of circuit. It can supervise trip circuit in breaker open as well as breaker close condition.

It is possible to enable/disable TCS functionality through configuration parameter. For the TCS functionality the BI2 need to be connected in parallel to the trip output BO2 as shown in the figure below. Additionally the BI2 need to be configured for the TCS functionally.

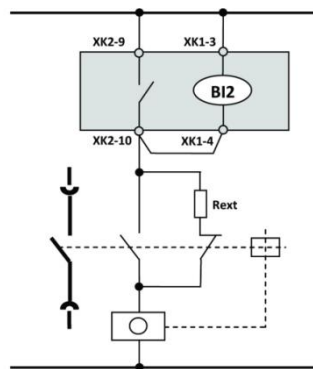

Figure 8: Application diagram of TCS function

When the circuit breaker is open, TCS measure the voltage across the trip contact through Rext (external shunt resistance shown in below figure) and trip coil. When the circuit breaker is close, TCS measure the voltage across the trip contact through CB internal contact and trip coil. Below table shows the specification for the Rext for the TCS circuit.

Table 25: TCS functionality specification

| Description                                   | Value                           |
|---|---------------------------------|
| Auxiliary voltage range                       | 48-250V AC/DC                   |
| Current drain through the supervision circuit | ~1.5 mA                         |
| Minimum voltage over the TCS contact          | 20 V AC/DC                      |
| Operating voltage Vaux                        | Recommended shunt resistor Rext |
| 48 V DC                                       | 1.2 kΩ, 5 W                     |
| 60 V DC                                       | 5.6 kΩ, 5 W                     |
| 110 V DC                                      | 22 kΩ, 5 W                      |
| 220 V DC                                      | 33 kΩ, 5 W                      |



## Protection and Control Function

---

Whenever TCS functionality is enabled, it is recommended to connect  $R_{ext}$ . Otherwise, TCS sees a faulty trip circuit in open circuit breaker position.

**Table 26:** *TCS functionality parameters and selection range*

| Name               | Value (Range) | Unit | Step | Default | Description |
|--------------------|---------------|------|------|---------|-------------|
| Operate delay time | 1...10        | Sec  | 1    | 1       | Settable    |
|                    | 10...300      | Sec  | 1    |         |             |
| Reset delay time   | 0.5           | Sec  | ---  | 0.5     | Fixed       |

## Section 5 Use of LHMI

### 5.1 Overview

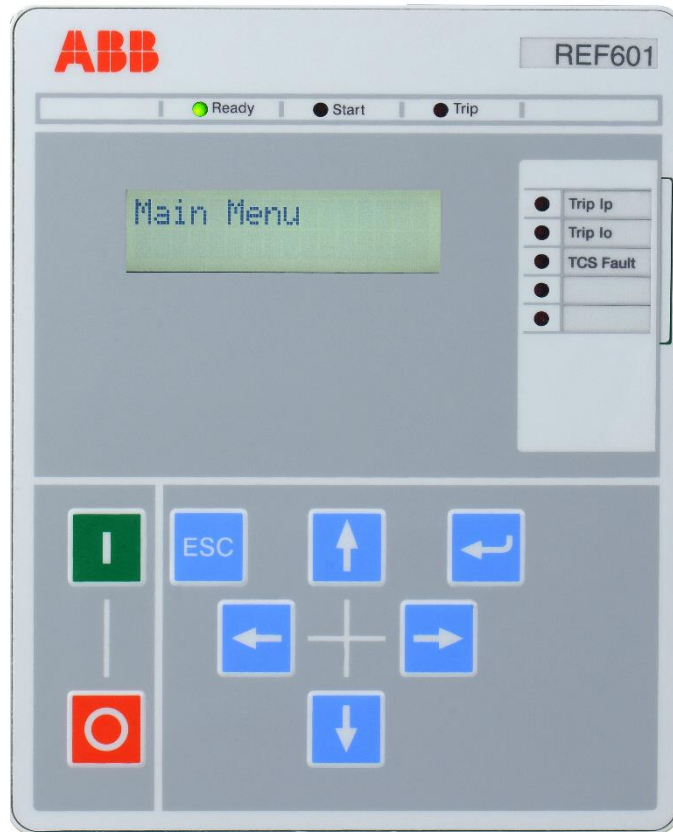

Figure 10: Local HMI of relay REF601/REJ601/REM601

The local HMI of the relay contains following elements:

- LED indicators
- LCD display
- Navigation buttons / keys

The LHMI is used for setting, monitoring and controlling.

#### 5.1.1

#### LED's

LED's displays following information respective status

Ready: Green LED

Start: Yellow LED lights after any start of a protection function

Trip: Red LED lights after any trip of protection function

LED 1...5 Red LED functionality as configured











### 5.1.2 LCD display

The LHMI includes a 2 x 16 character LCD display which supports English and Chinese characters.

### 5.1.3 Navigation

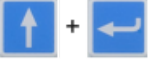
The LHMI keypad consists of push buttons which are used to navigate in different views or menus. With control push buttons the open or close commands can be given to breaker. The push buttons are also used to acknowledge alarms, reset indications and reset of lockout functions.

**Table 27: LHMI push buttons**

| Key Picture   | Key Name      | Description   |
|---|---------------|---|
|    | Up            | Used for incrementing of parameter value while editing, or provides up level selection of menu item.  |
|    | Down          | Used for decrementing of parameter value while editing, or provides down level selection of menu item.  |
|   | Back          | Used for going to higher level of menu item from its lower level submenu.   |
|  | Next          | Used for going to lower level submenu from higher level menu.   |
|  | Enter         | Used for saving of edited parameter value.  |
|  | Escape/Cancel | a) Used for discarding changed parameter value in edit mode<br>b) Used for going back to main menu from any level of menu navigation. 2 <sup>nd</sup> pressing "ESC" will lead to default view. |
|  | Reset         | Press key combination Up and Enter key together to reset the relay from LHMI as well to reset trip LEDs   |
|  | Edit          | Press key Enter to edit the relay parameter from LHMI   |
|  | Breaker Close | Hotkey for providing Breaker Close command.   |
|  | Breaker Open  | Hotkey for providing Breaker Open command.  |

Use of LHMI

**5.1.4 Authorization**

To protect the relay from unauthorized access and to maintain the integrity of information, the relay is armed with a three level, role based user authentication system with individual password for operator, engineer and administrator level.

To access the relay by any category of user, supported two different type of password protection as listed below:

- Simple password protection (Default) – Achieve by two key combinations as available in release 2.2 and earlier. The password shall be set by selecting arrow symbols in password configuration menu.
- Alpha-numeric password protection – Achieve by four letter password. The password shall be set in password configuration menu by the allowed character set for password i.e. capital letters from ‘A’ to ‘Z’, number ‘0’ to ‘9’ & underscore ‘\_’ as a special character.

Type of password protection shall be distinguished by the way they are set in password configuration menu.

The rights per user category and their default password are listed in following table:

**Table 28: User authorization and default password**

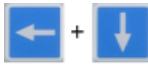
| Sr No. | Features  | Operator Level User      | Engineer Level User  | Admin Level User   |
|--------|---|--------------------------|--|--|
| 1      | Menu viewing  | Yes                      | Yes  | Yes  |
| 2      | Protection settings editing   | -                        | Yes  | Yes  |
| 3      | COM Board parameter editing   | -                        | Yes  | Yes  |
| 4      | Perform test  | -                        | Yes  | Yes  |
| 5      | Relay Configuration editing   | -                        | -  | Yes  |
| 6      | Password editing  | -                        | -  | Yes  |
| 7      | Simple password protection:<br>Password key combination<br>(Default combination for simple password method) | Other than Admin/setting | <br>Back + Up | <br>Back + Down |
| 8      | Alpha numeric password protection:  | Other than Admin/setting | Capital letters from ‘A’ to ‘Z’, number ‘0’ to ‘9’ & underscore ‘_’ as a special character         | Capital letters from ‘A’ to ‘Z’, number ‘0’ to ‘9’ & underscore ‘_’ as a special character           |

The selection of user category is done via password at entering the main menu.

At default view, whenever any key is pressed, for 3 second the Configuration status screen appears followed by a password request screen.

Password needs to be entered here as indicated in Sr. no. 7 in case it is configured as Simple password and should be as indicated in Sr. no. 8 in case it is configured as alpha-numerical password.

In case of wrong password being entered by the user, automatically the operator user category is selected.  
The selected category will pop up for one second before the main menu is shown.  
Sequence looks as follow:

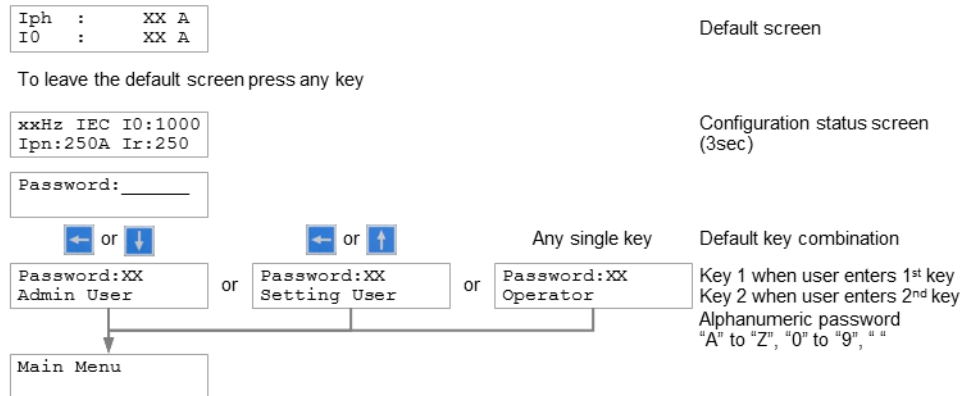

Figure 11: Login process of relay REF601 / REJ601/REM601

### Password configuration

The password could be changed under the Main Menu -> Access Level.

In access level menu, password can be set for both setting & admin level. In edit mode, cursor position can be set by ← or → arrow key and allowed password symbol can be selected by ↑ or ↓ arrow key. Finally by ENTER key password can be set.

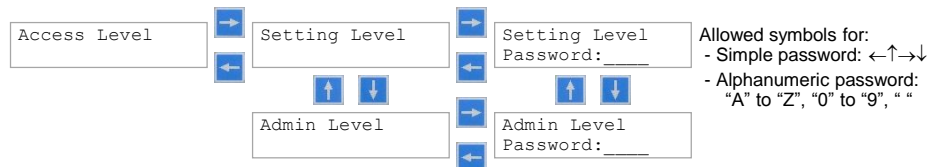

Figure 12: Password configuration in relay

## 5.1.5

### Configuration status

At default view, whenever any key is pressed, for 3 second the Configuration status screen appears followed by a password request screen.

Following figure shows configuration status screen:

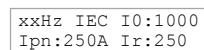

Figure 13: Configuration status display screen

Configuration status screen (3 sec)

1. Frequency: 50 or 60 Hz
2. I0: 20..9999 (Primary current of external earth CT)
3. Ipn: 20..9999 (Primary current of phase CT or Rogowski coil sensor) (for Rogowski coil sensor 80A or 250A)
4. Ir: Relay reference current (only for sensor variant)

Use of LHMI

## 5.2 LHMI menu navigation

### 5.2.1 Default screen

The default view of the relay displays the largest phase current and earth current which is indicated in Fig. 10. The relay returns to default screen after 5 minutes if no key is pressed.

Current values are displayed in this view for phase current and earth current in “A” as shown in following figure.

|     |   |    |   |
|-----|---|----|---|
| Iph | : | XX | A |
| I0  | : | XX | A |

Figure 14: Default screen of relay REF601 / REJ601 / REM601

### 5.2.2 Main menu

The main menu appears after entering the password with the user rights depended on the entered password. Following view shows the main menu of the relay.

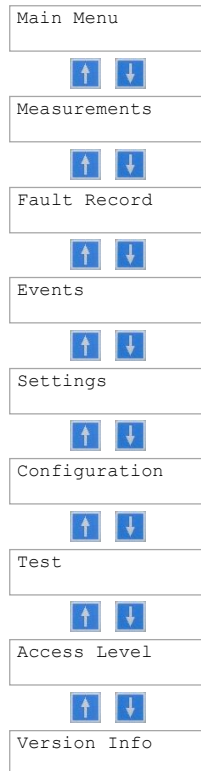
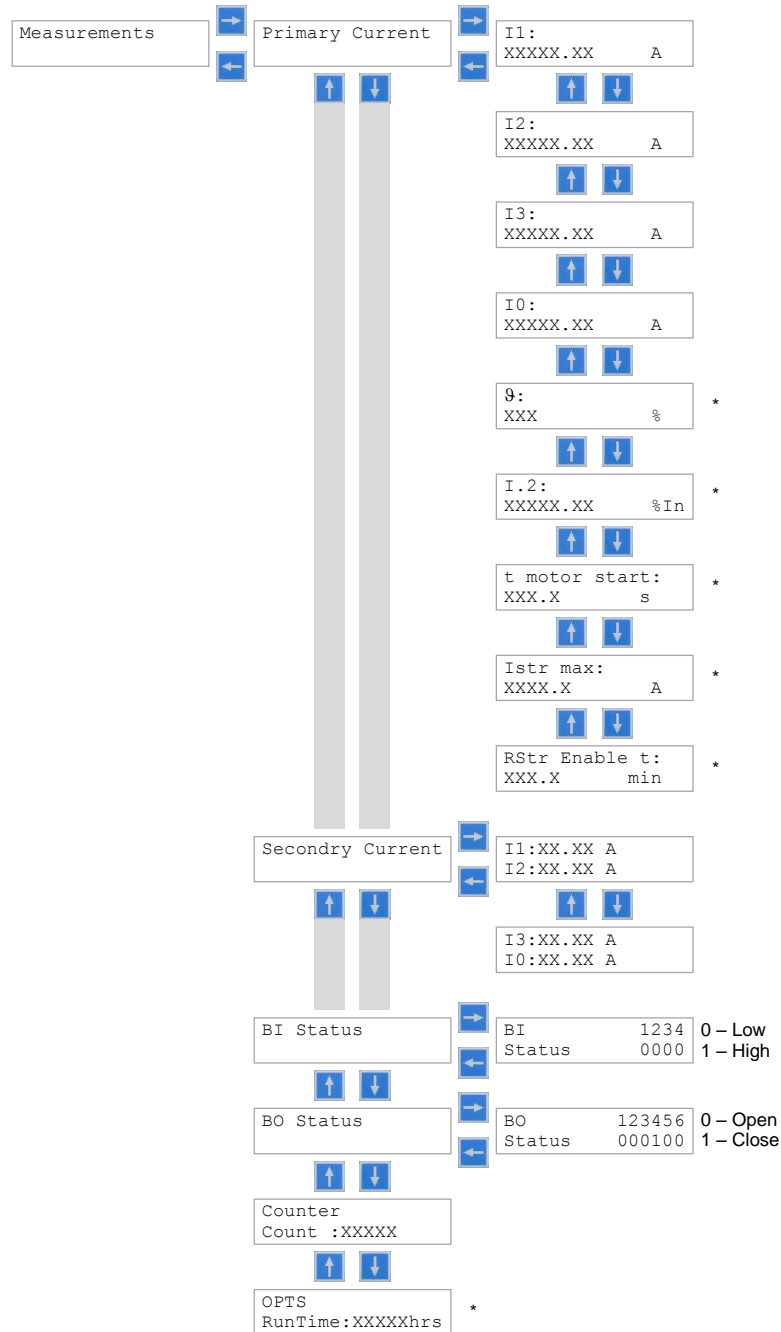

Figure 15: Main menu of relay REF601/REJ601/REM601

### 5.2.3 Menu – Measurement

Submenu Measurement shows analogue input values as primary or as secondary values according to primary and secondary current of current transformer selected in the submenu configuration – settings. Also it shows binary input and output status at the relay terminal.



Note \* – only available when respective function in IED configuration

Figure 16: Measurement menu of relay REF601/REJ601/REM601

### 5.2.4 Menu – Fault record

Submenu Fault record shows under Recorded Current the fault records for the last five protection trips and the values for trip counters segregated in phase fault trips and earth fault trips.

For viewing the user should follow the figure below.

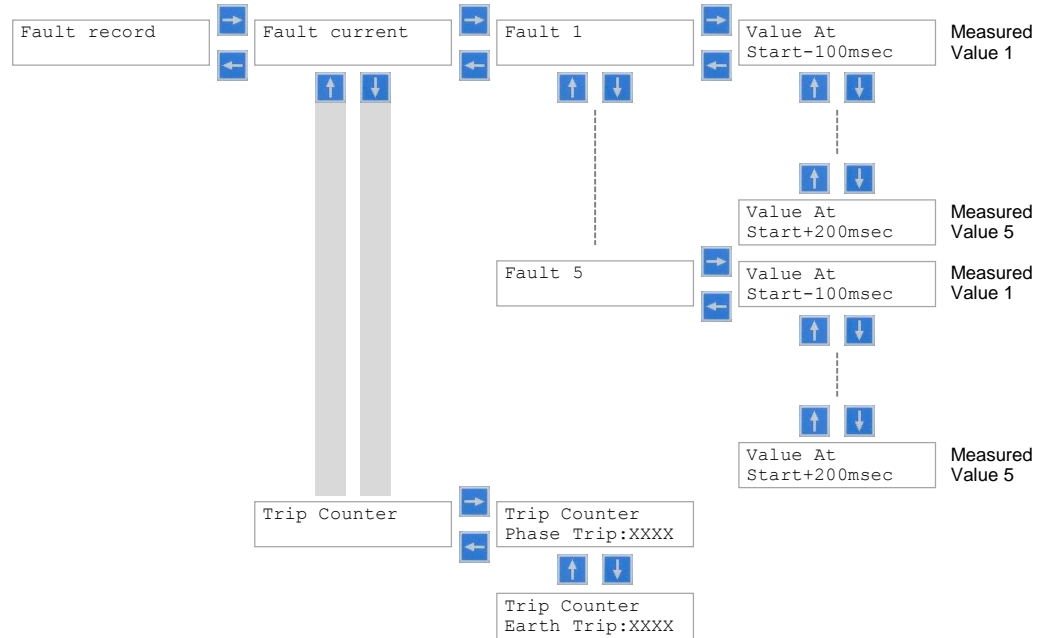

Figure 17: Fault record data menu of relay REF601/REJ601/REM601

### 5.2.5 Menu - Events

Submenu Events shows events 1 – 100 with details in respective submenu.

Event 1 will always contain data of most recent event and event 100 would be the oldest.

The event menu can be access as below.

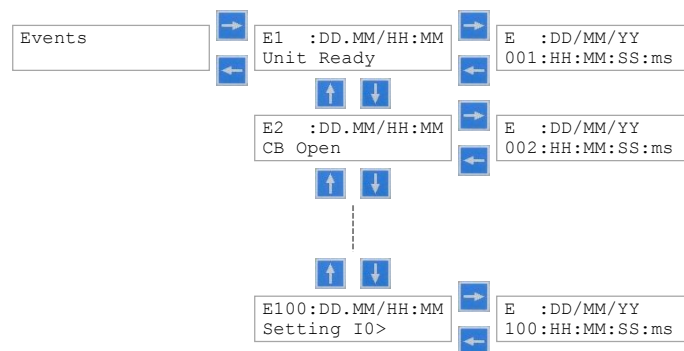





Figure 18: Event menu of relay REF601/REJ601/REM601



## 5.2.6 Menu – Setting

Submenu Settings and respective submenus shows and allows depending on the user right to change all protection parameters and communication parameters.

Remark:

- To modify settings needs user rights of Setting or Admin user.
- To modify selected setting start with key 
- To save changed setting with key 
- To discard and exit a modified setting with key  / 
- View of time parameters of I> and IO> (k / t> respective k/t0>) are depending on the selection of the curve selection of its function.



If COM Admin Level is YES, then IED configuration parameter is allowed to change through MODBUS

Following menu structure is used to navigate to the respective settings:

Use of LHMI

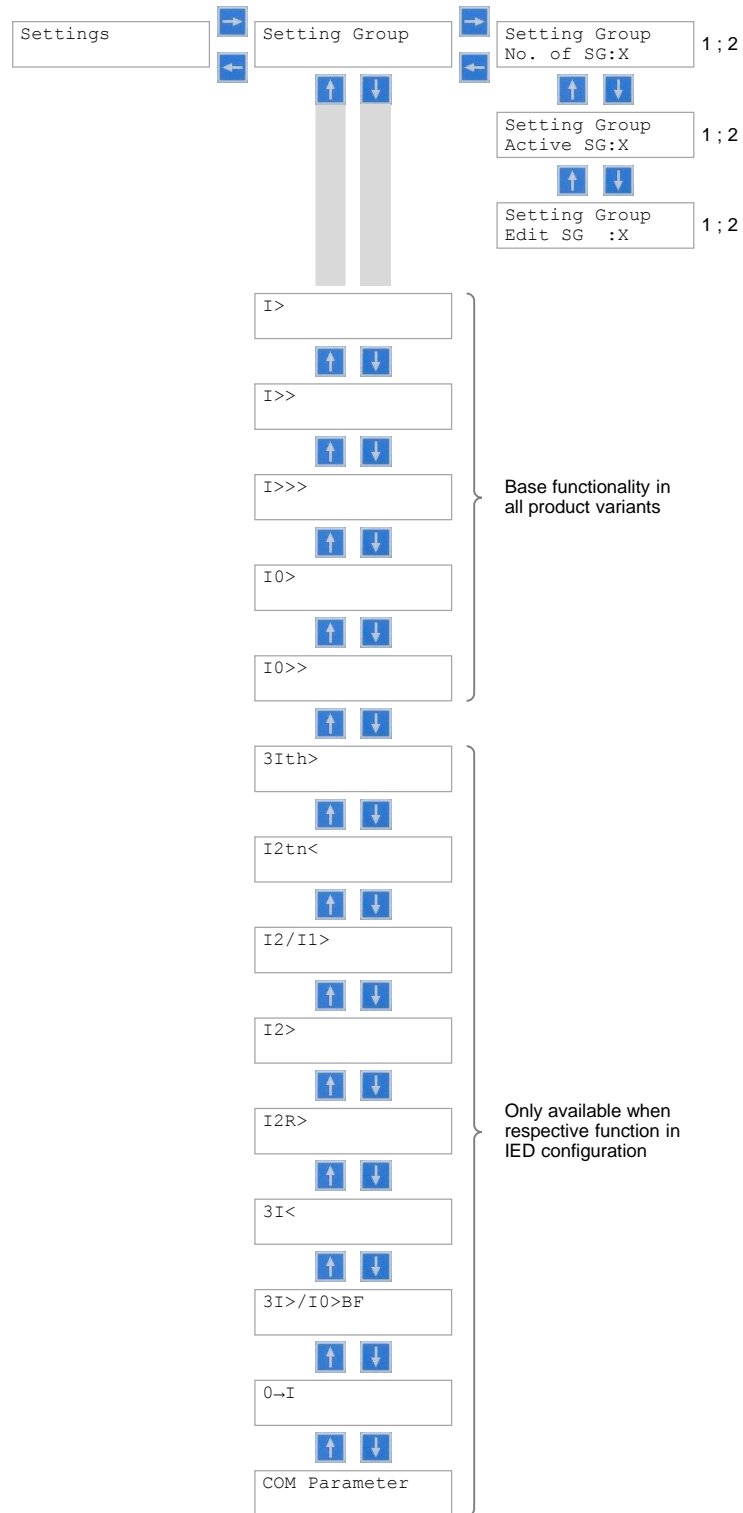

Figure 19: Setting menu of relay REF601/REJ601/REM601

---

## 5.2.7

### Menu – Configuration

- Submenu Configuration and respective submenus shows and allows depending on the user right to change
- Blocking of particular protection stage or remote trip activation
- Relay configuration settings like sensor type selection and earth current calculation method
- Inrush protection related settings
- Selection for loading factory settings (protection parameters only)

#### Remark:

- To modify configuration settings needs user rights of Admin user.
- To modify selected setting start with key
- To save changed setting with key
- To discard and exit a modified setting with key



Following menu structure is used to navigate to the respective configuration settings:

Use of LHMI

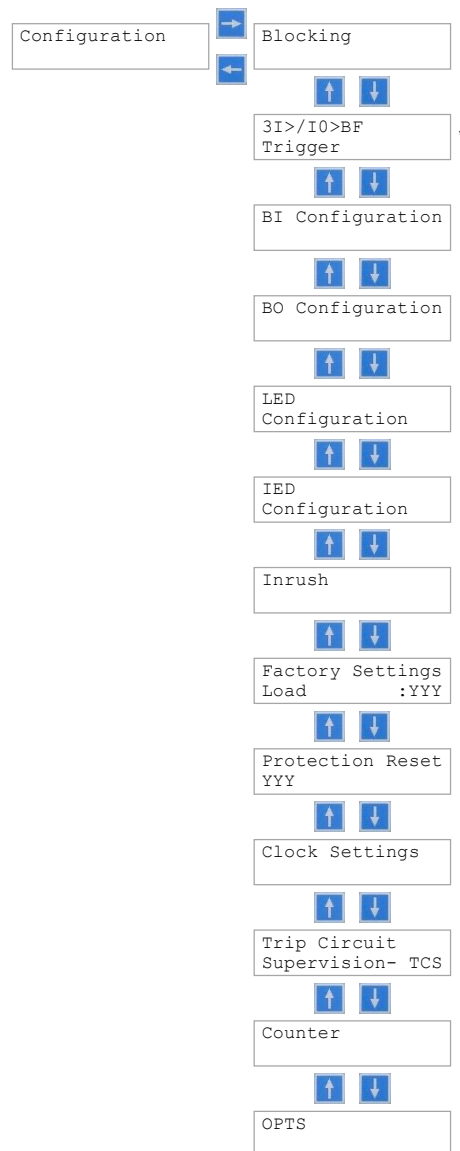

Note \* – only available when respective function in IED configuration

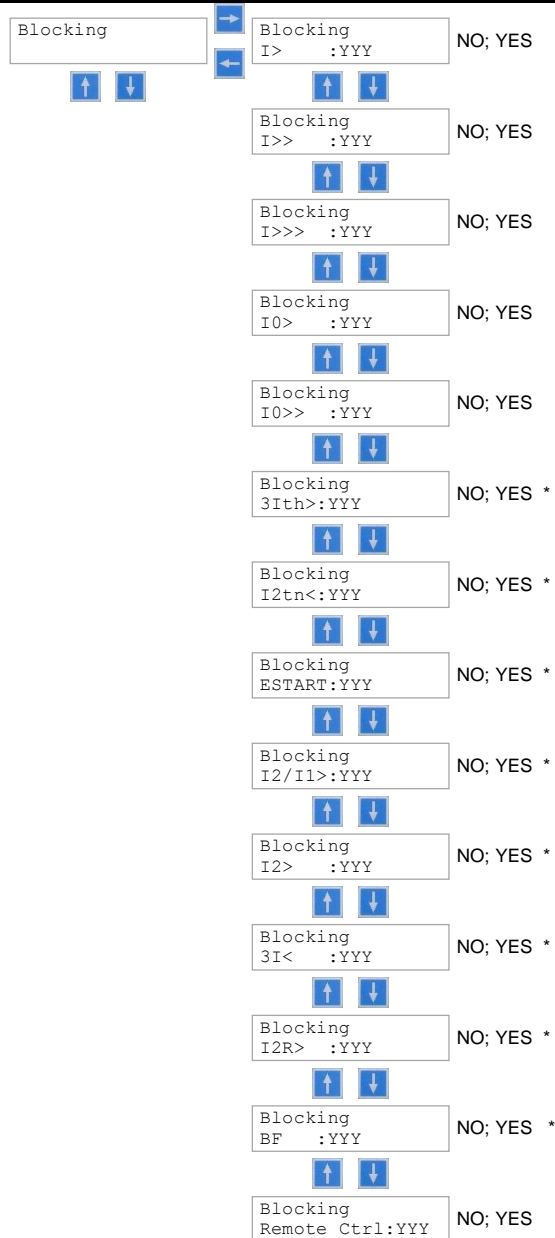

Note \* – only available when respective function in IED configuration

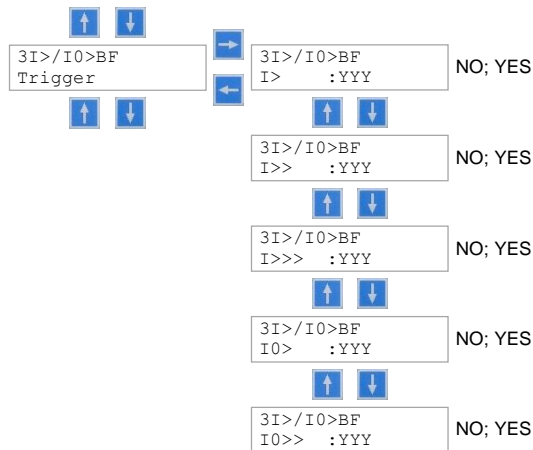

Use of LHMI

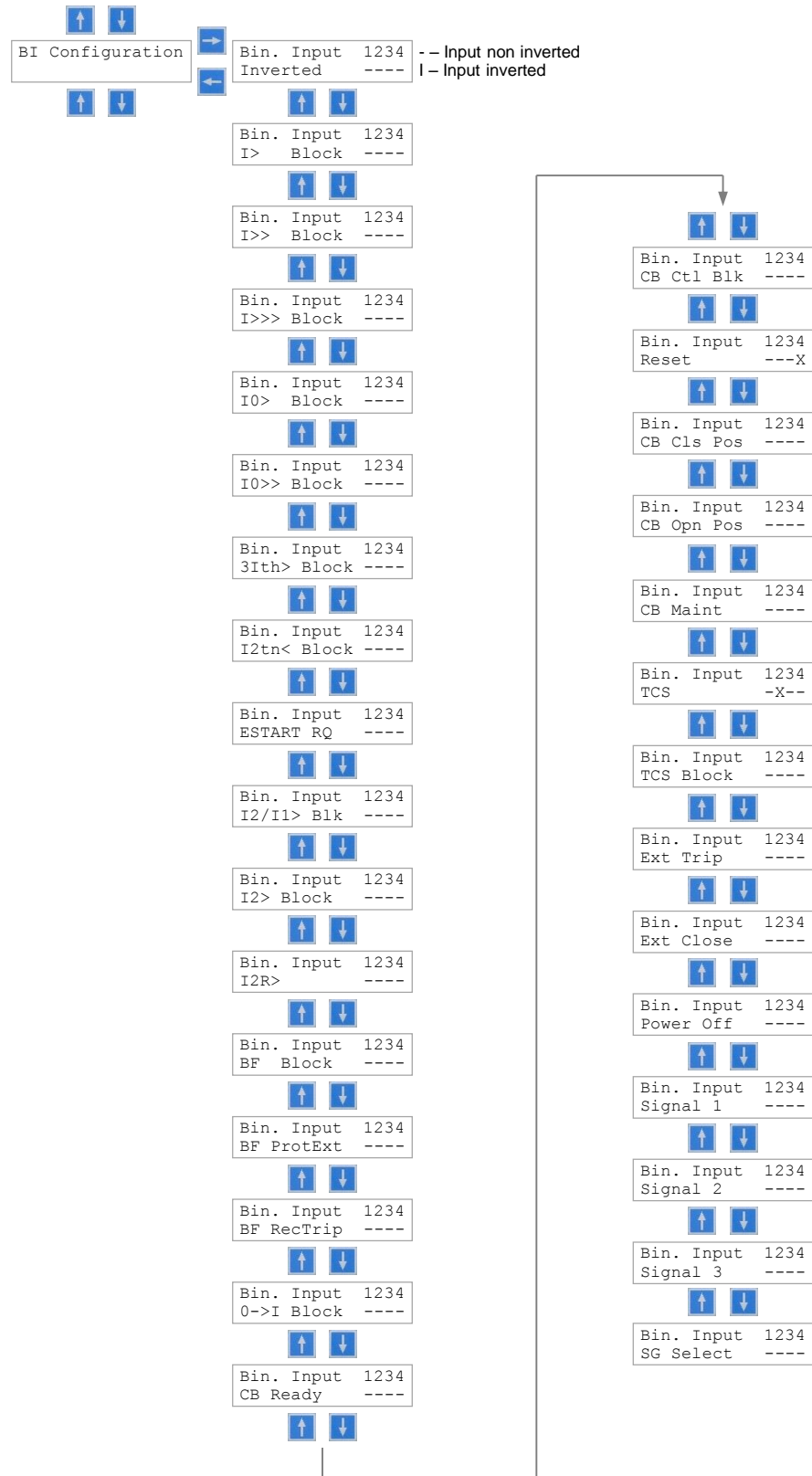

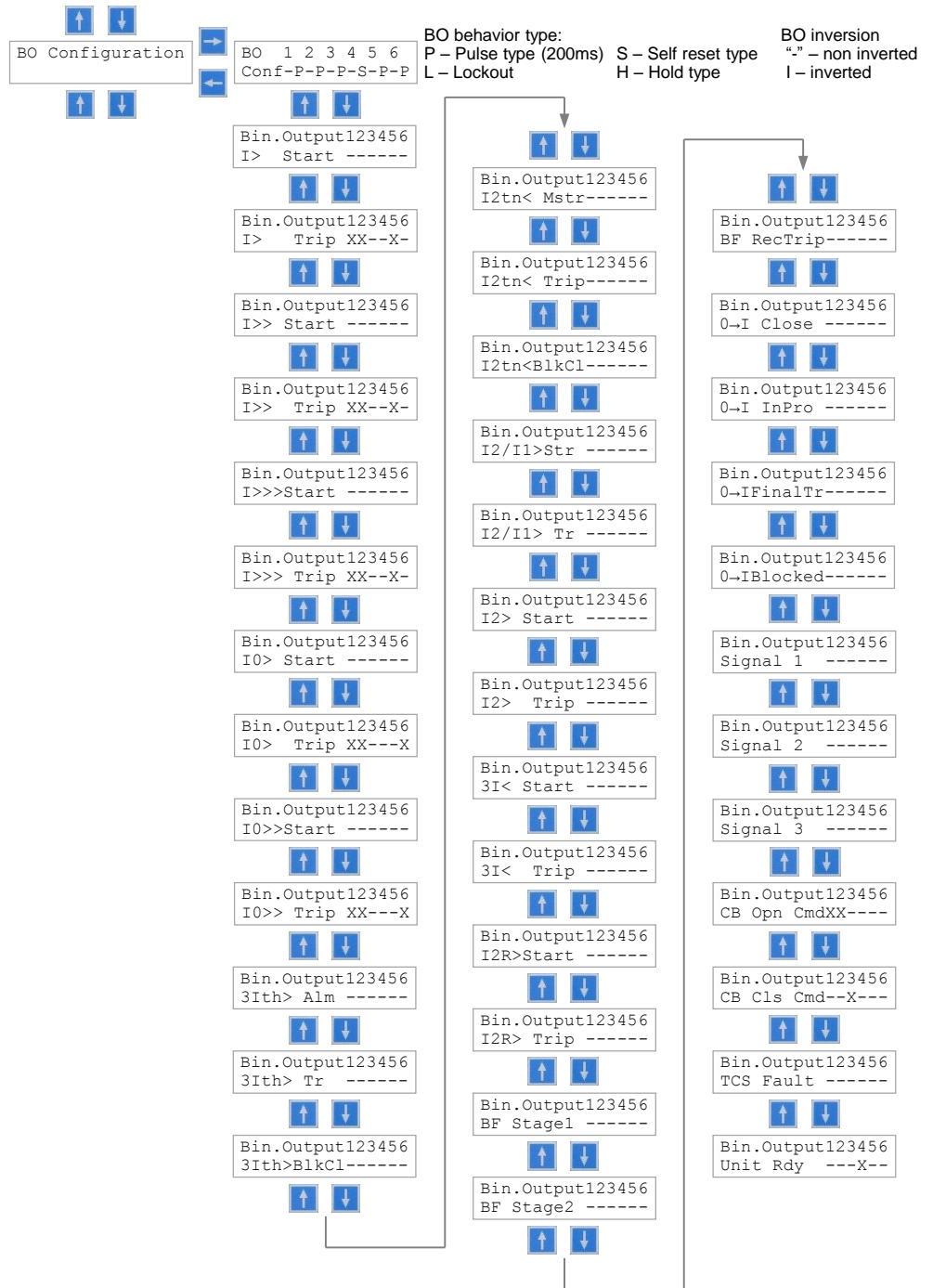

Use of LHMI

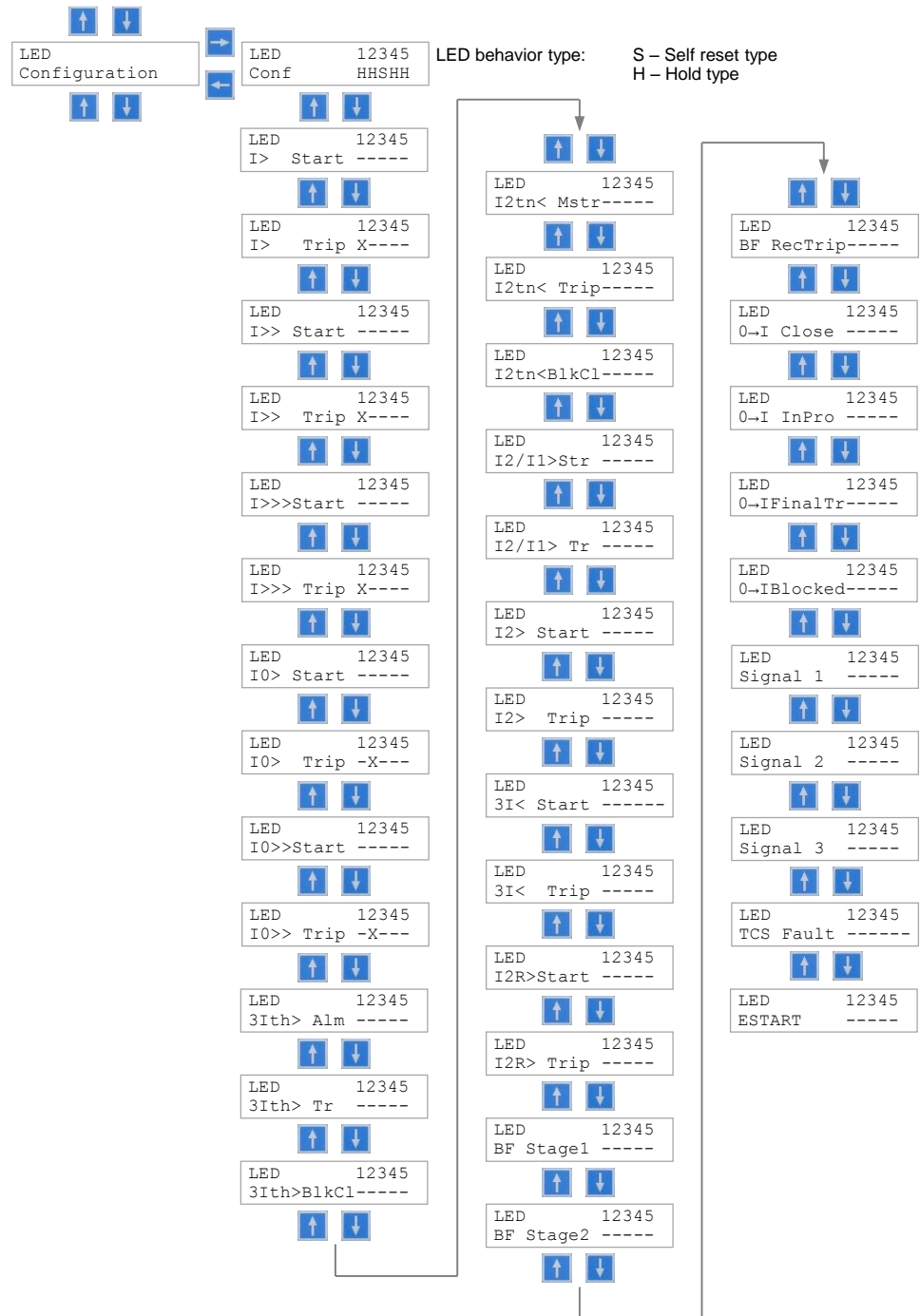



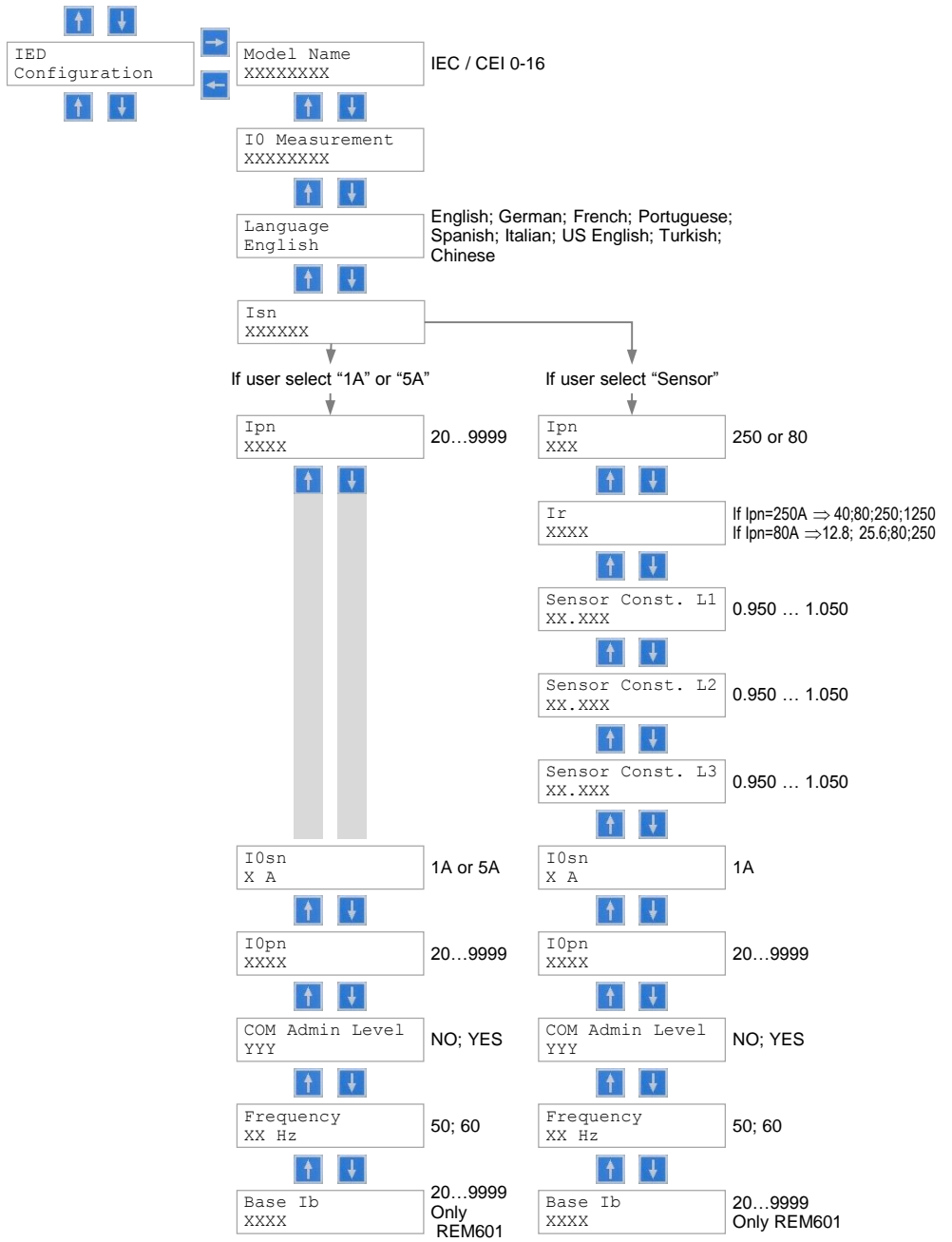

Use of LHMI

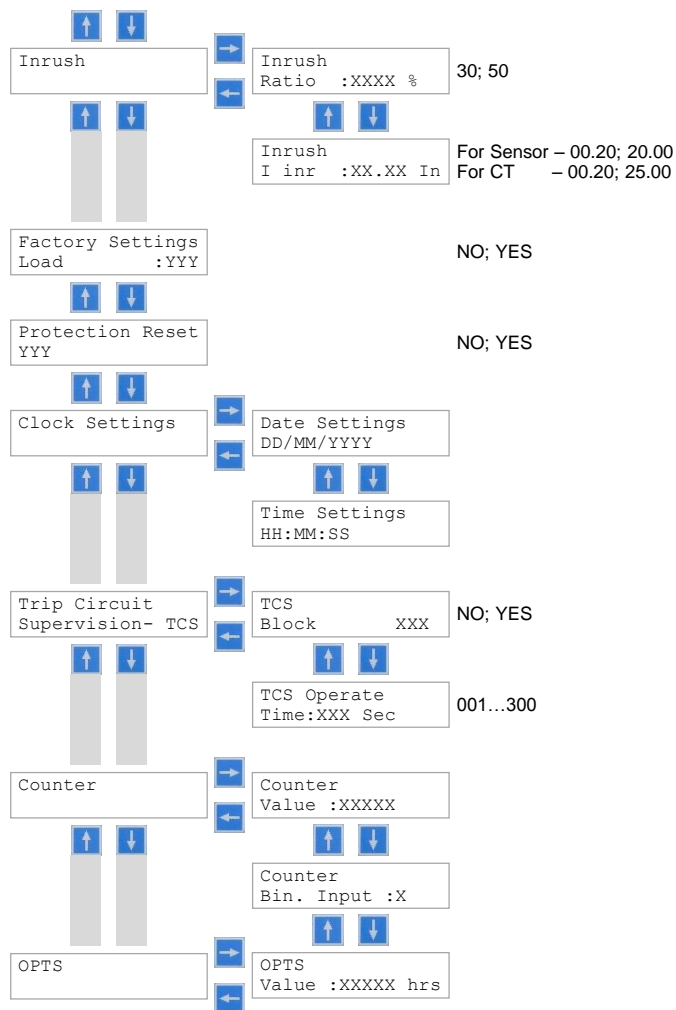

Figure 20: Configuration menu of relay REF601/REJ601/REM601 with its submenu

## 5.2.8 Menu – Test

Submenu Test and respective submenus shows and allows depending on the user right to perform several kind of tests to verify the IED functionality:

**Test -> Hardware:** Enables Internal Hardware Tests, which includes LCD check, Keyboard check and LEDs check. User can skip particular checks using interactive menu selection.

**Test -> Binary Output (BO):** Enables testing of all output contact to test the complete external circuit initiated by the output contact. Once test BO selected output will be operated for around 2 sec.

**Test -> Functional:** Enables each protection function tests by loading fixed analog values for five seconds and ignoring actual analog inputs. User can test all protection stages and accordingly its relay configuration by having a simulated analog values for 5 seconds.

The details of functions available in test mode are described as under the respective section.

Remark:

To modify settings needs user rights of Setting or Admin user.

Following menu structure is used to navigate to the respective test settings:

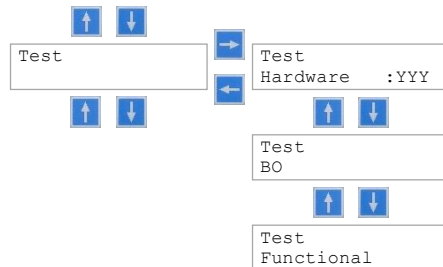

Figure 21: Test menu of relay REF601/REJ601/REM601 with its submenu

Use of LHMI

5.2.8.1 Menu – Hardware

Following functionalities can be tested through this menu.

- LCD Test
- Keyboard Test
- LED Test

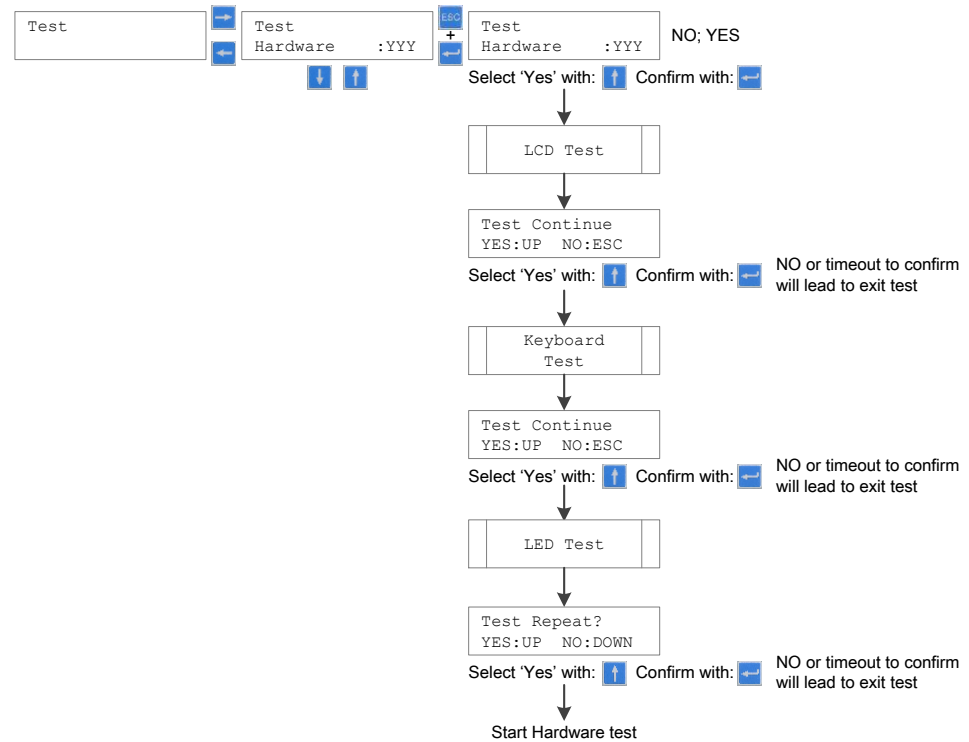

During each test wherever confirmation from user is asked to continue test sequence, if no selection from user, automatically after 5 sec timeout test sequence will move to next screen.

Each test procedure provides test result messages and interactive user selections on LCD.

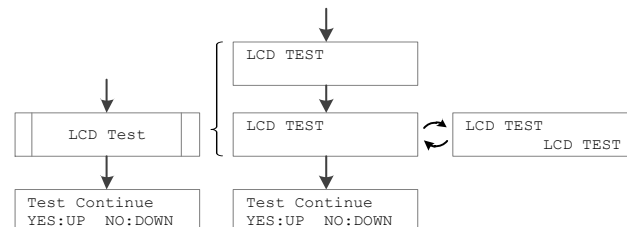

Figure 22: Hardware test menu of relay REF601/REJ601/REM601 with its submenu

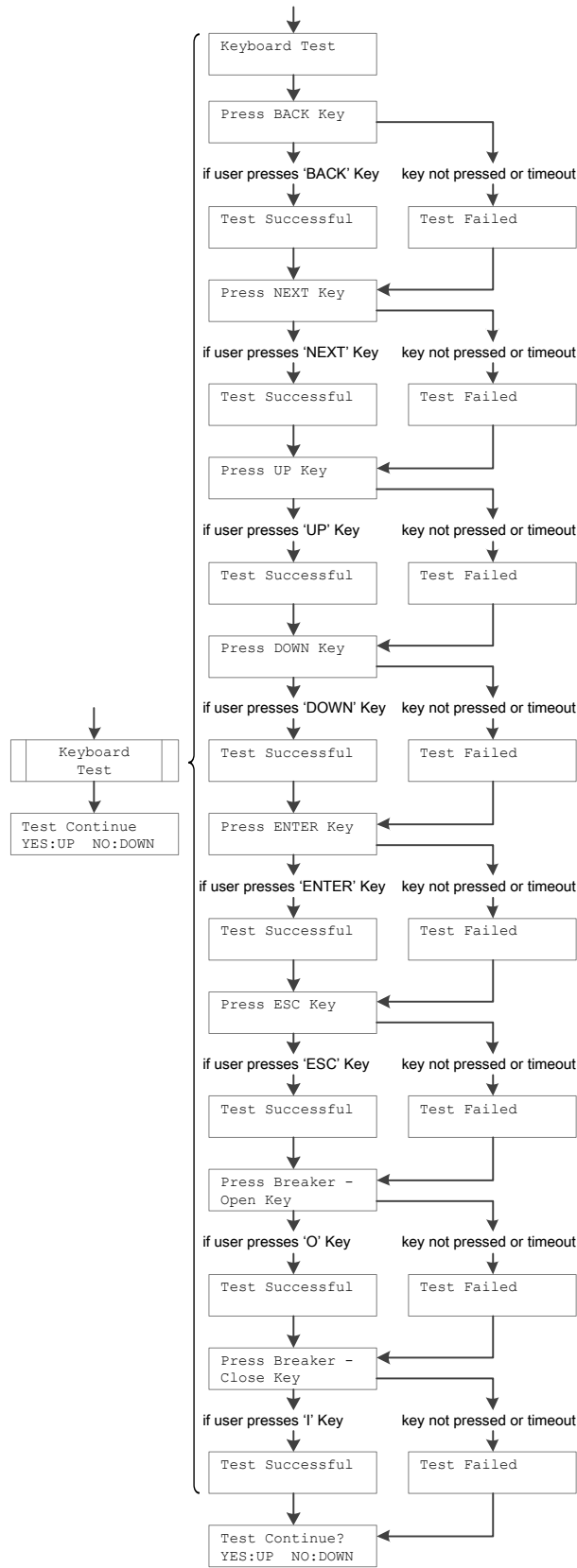

Figure 23: Hardware test menu of relay REF601/REJ601/REM601 with its submenu (Continue)

Use of LHMI

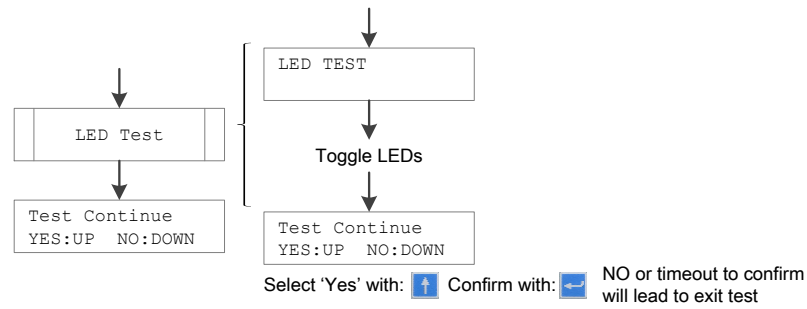

Figure 23: Hardware test menu of relay REF601/REJ601/REM601 with its submenu (Continue)

5.2.8.2 Submenu – Binary output test

Submenu binary output test allows to force a binary output. The forced output operates for a pulse duration of 1 sec.

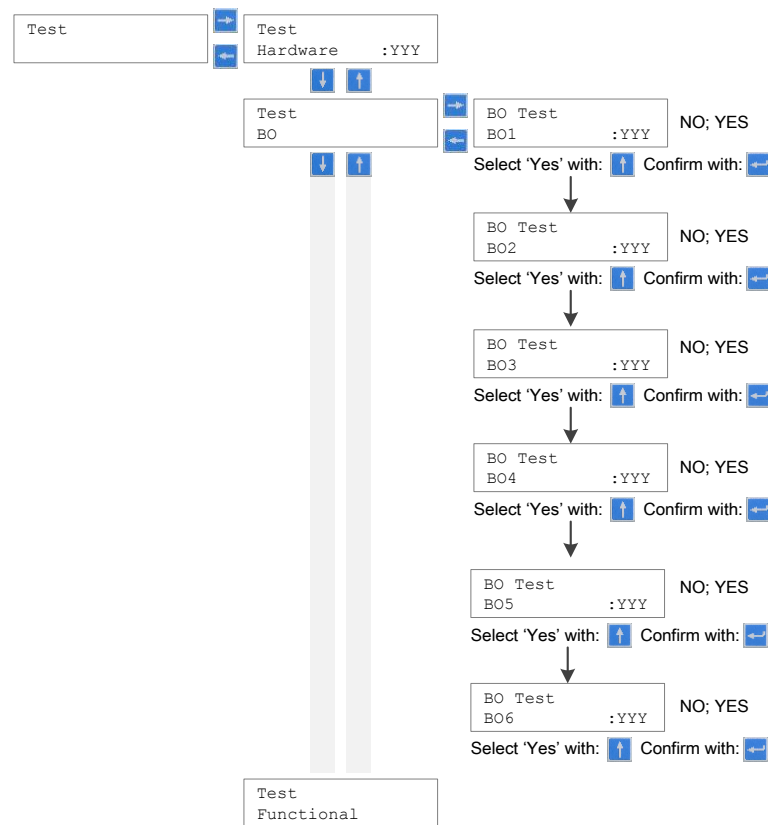

Figure 24: Binary output test menu of relay REF601/REJ601/REM601 with its submenu (Continue)

5.2.8.3 Submenu – Functional test

Submenu functional test allows performing simulation of each protection function by giving a test current to the selected protection function.



Figure 25: Functional test menu of relay REF601/REJ601/REM601

### 5.2.9 Access level

This menu provides the password change facility for the different access levels. Only Admin can change the password of the other access levels. Activating edit mode by pressing Enter and Cancel button together can change password. User can then enter new password. Enter button must be pressed before timeout period after changing the password. Password can be of six different combinations of the navigation keys. Each navigation key has its unique ID (1..4) which will be selected as password for the different access levels. Only two key combinations can be used for password entry/selection.

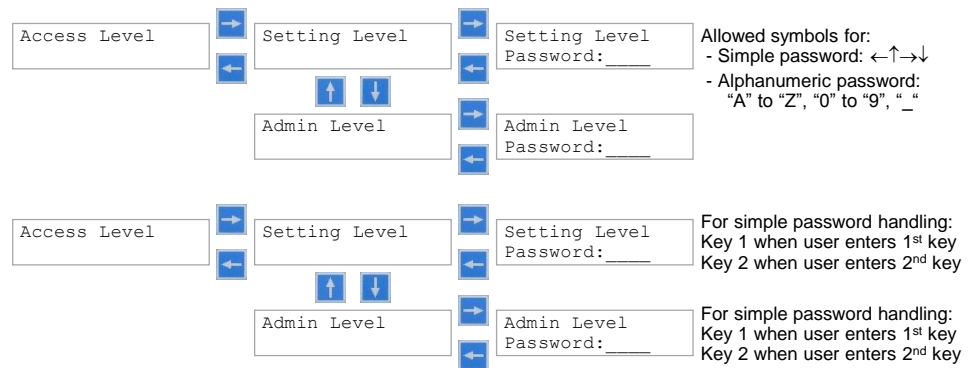

Figure 26: Access level menu

### 5.2.10 Version information

This menu provides information regarding the Product type selected, Software version being presently loaded into the product, Model name, Nominal current value selected, and the type of trip circuit present.

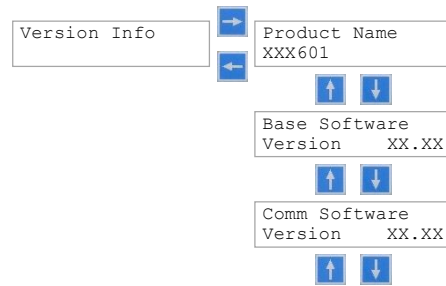

Figure 27: Version information menu



---

## Section 6 Installation

### 6.1 Unpacking and inspecting the device

REF601/REJ601/REM601 products, although of robust construction, require careful handling prior to installation on site. The delivered products should always be examined to ensure that no damage has been sustained during transit.

Remove transport packing carefully without force. Appropriate tools needs to be used.

Check the relay for transport damages. If the product has been damaged, a claim should be made to the transport contractor and the local representative of ABB should be promptly notified. Compare the type designation of the product with the ordering information to verify that you have received the right product.

Electrostatic discharge (ESD) :

The products contain components that are sensitive to electrostatic discharge. The electronic circuits are well protected by the relay case and therefore the rear panel may not be removed.

### 6.2 Storage

On receipt, the apparatus must be carefully unpacked and checked as described under chapter 6.1. Should installation not be carried out immediately, the apparatus must be repacked using the original packing material. Should the original packing material no longer be available, store the apparatus in a dry, dust-free, covered area which is non-corrosive and has a temperature of between  $-40\text{ }^{\circ}\text{C}$  and  $+85\text{ }^{\circ}\text{C}$ .

### 6.3 Checking environmental condition and mounting space

The mechanical and electrical environmental conditions at the installation site must be within the limits described in the technical data.

- Avoid installation in dusty, damp places.
- Avoid places susceptible to rapid temperature variations, powerful vibrations and shocks, surge voltages of high amplitude and fast rise time, strong induced magnetic fields or similar extreme conditions.
- Check that sufficient space is available.
- To allow access for maintenance and future modifications a sufficient space is needed in front and at side of the relay.
- Suitably qualified personnel with adequate knowledge of the apparatus must carry out all the installation operations.
- The relay should be disconnected before carrying out any work on relay.

---

## 6.4 Relay wiring

The connection wiring to the relay should be made by using single strand wire or stranded wire with the use of insulated crimp terminal to maintain the insulation requirements. The wire with below indicated cross-section should be used for control wiring:

- 0.2 - 2.5 mm<sup>2</sup> finely stranded
- 0.2 - 2.5 mm<sup>2</sup> single-core
- 2 x 0.2 – 1.0 mm<sup>2</sup>

For short circuit terminals for conventional CT the wire with below indicated cross-section should be used for wiring:

- 0.5 – 6.0 mm<sup>2</sup> finely stranded
- 0.5 – 6.0 mm<sup>2</sup> single-core
- 2 x 0.5 - 2.5 mm<sup>2</sup>

## 6.5 Relay mounting and dimensions

All the mounting elements are integrated in the relay. The relay has been equipped with in-build press fit mechanism.

The space requirement of mounting:

|                                |   |
|--------------------------------|---|
| Overall dimensions (H x W x D) | : 160 x 130 x 151.5 mm for CT variant     |
|                                | : 160 x 130 x 101.5 mm for Sensor variant |
| Cutout dimensions (H x W)      | : 151.5 ± 0.5 x 121.5 ± 0.5 mm            |
| Depth behind the panel         | : 151.5 mm for CT variant                 |
|                                | : 101.5 mm for Sensor variant             |
| Weight                         | : 1.43 kg for CT variant                  |
|                                | : 1.20 kg for Sensor variant              |

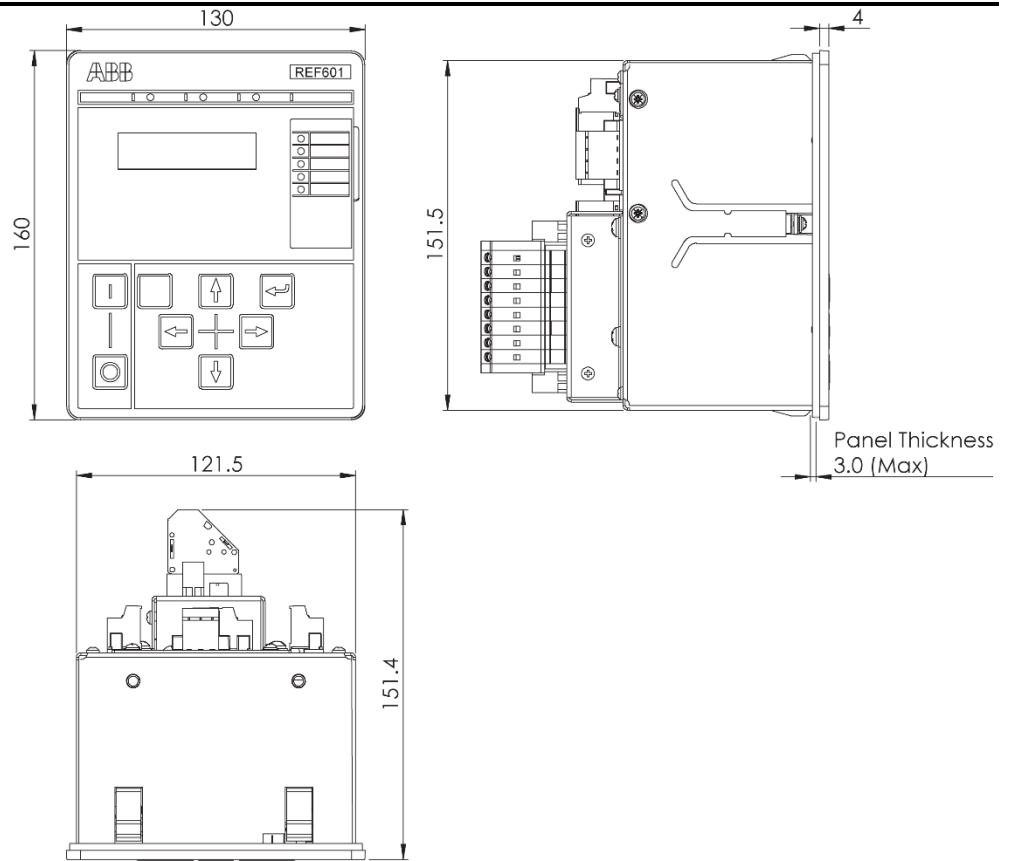

Figure 28: Overall mounting dimension of REF601/REJ601/REM601 with CT variant

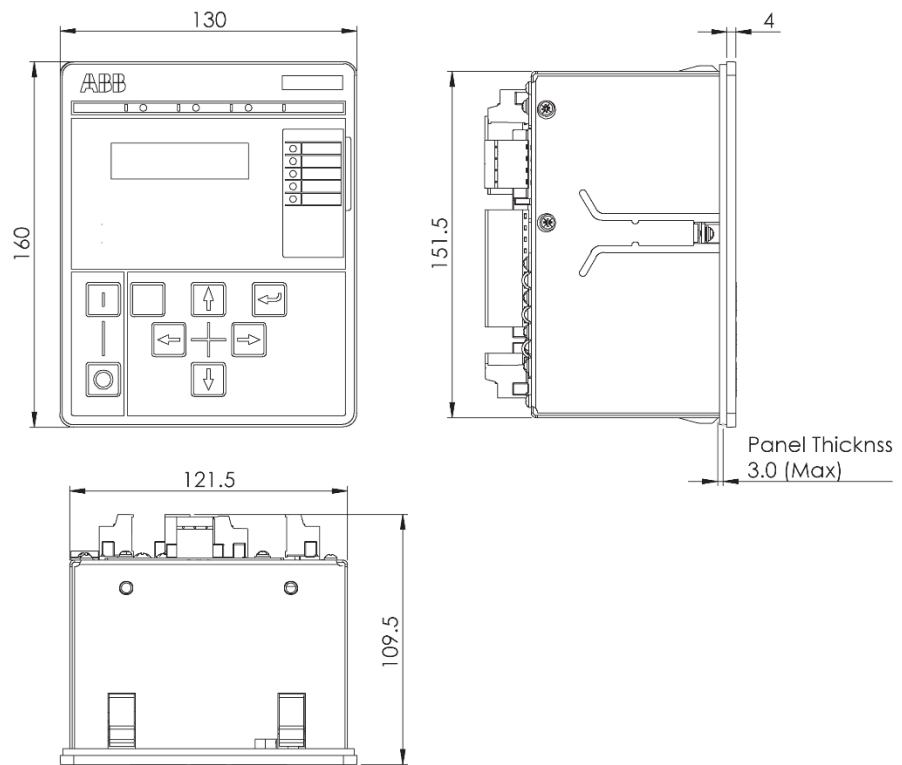

Figure 29: Overall mounting dimension of REF601/REJ601/REM601 with Sensor variant

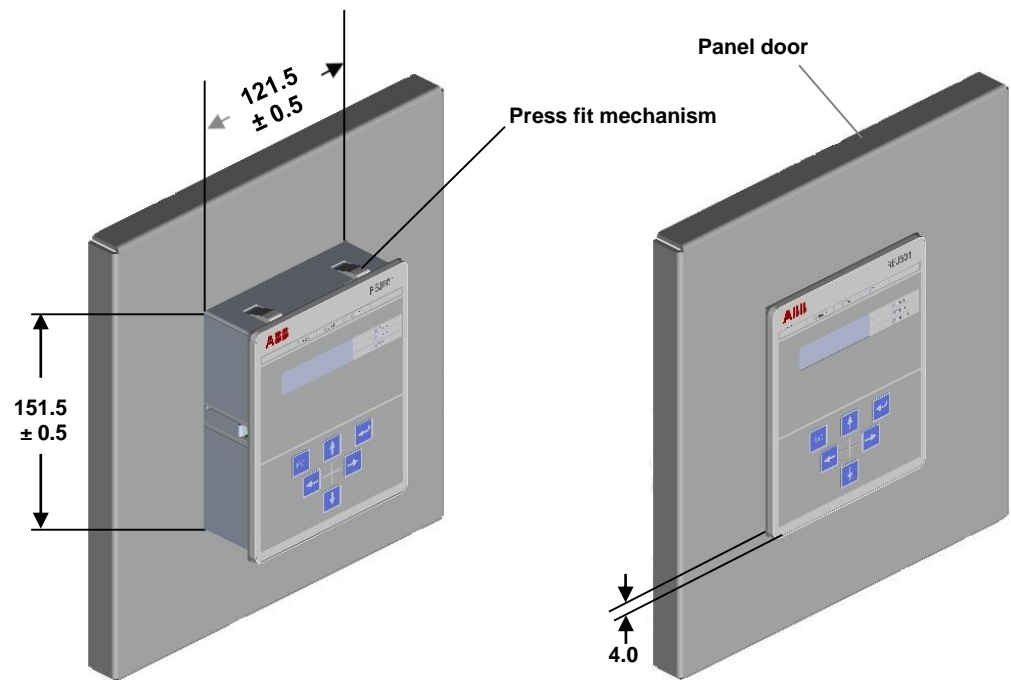

Figure 30: Panel mounting details of REF601/REJ601/REM601

## 6.6 Terminal diagram

Relay terminal / connection diagram for both conventional CT as well sensor variant shall be as the relay.

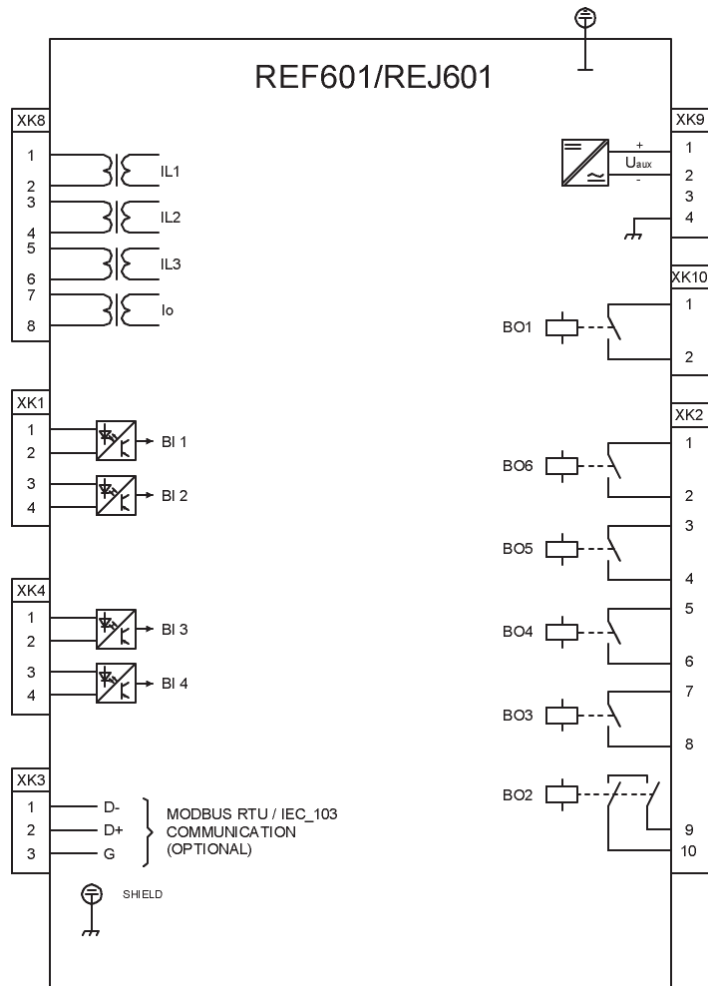

Figure 31: Connection diagram of relay REF601 /REJ601/REM601 with CT variant

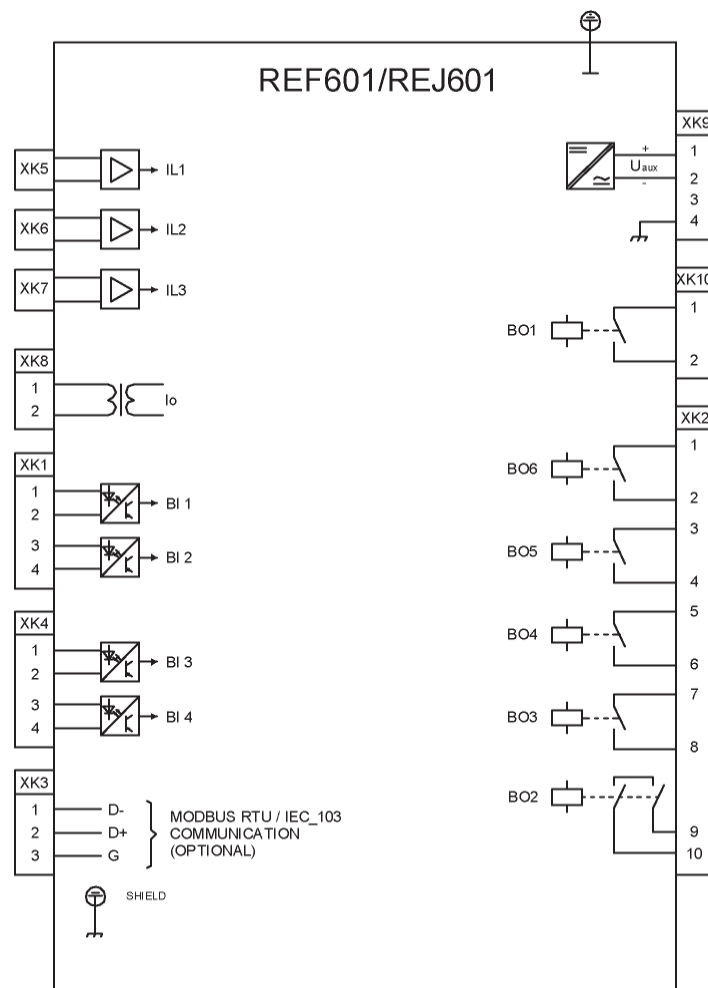

Figure 32: Connection diagram of relay REF601 /REJ601/REM601 with Sensor variant

## 6.7 Relay ordering information

The relay type and serial number label identifies the protection relay. An order number label is placed on the side of the relay. The order number consists of a string of codes generated from the hardware and software modules of the relay. The serial number and order number label is placed on side of relay.

**Example code**

REF601 B E4 46 B D 1 N H

| #   | Description                        |                 |
|-----|------------------------------------|-----------------|
| 1   | <b>Relay type</b>                  |                 |
|     | Feeder protection with control     | REF601          |
|     | Feeder protection                  | REJ601          |
|     | Motor protection with control      | REM601          |
|     | Motor protection                   | REM601          |
| 2   | <b>Standard</b>                    |                 |
|     | ANSI                               | A               |
|     | IEC                                | B               |
|     | Chinese                            | C               |
|     | CEI                                | J               |
| 3,4 | <b>Analog input / output</b>       |                 |
|     | 3 sensor and ground current input  | A4              |
|     | Phase and Earth current input – 1A | D4              |
|     | Phase and Earth current input – 5A | E4              |
| 5,6 | <b>Binary input / output</b>       |                 |
|     | 4 BI + 6 BO                        | 46              |
| 7   | <b>Serial communication</b>        |                 |
|     | MODBUS RTU with RS485 two wire     | B               |
|     | IEC60870-5-103 with RS485 two wire | C               |
|     | None                               | N               |
| 8   | <b>Application configuration</b>   |                 |
|     | Configuration 2                    | B               |
|     | Configuration 3                    | C               |
|     | Configuration 4                    | D <sup>1)</sup> |
| 9   | <b>Power supply</b>                |                 |
|     | 24...240V AC / DC                  | 1               |
| 10  | <b>Configuration</b>               |                 |
|     | Ring lug terminals                 | B               |
|     | Screw terminals                    | N               |
| 11  | <b>Version</b>                     |                 |
|     | Product version 2.2 FP1            | H               |

1) Not applicable for REM601 in release 2.2 FP1

|                 |   |   |     |     |   |   |   |    |    |
|-----------------|---|---|-----|-----|---|---|---|----|----|
| Digit (#)       | 1 | 2 | 3,4 | 5,6 | 7 | 8 | 9 | 10 | 11 |
| Your Order Code |   |   |     |     |   |   |   |    |    |

Figure 33: Ordering information of relay REF601/REJ601/REM601

---

## 6.8 Accessories and ordering data

*Table 29: REF601/REJ601/REM601 accessories and ordering data*

| Item                      | Order number     |
|---------------------------|------------------|
| RE_601 communication card | CIM601BNNNNBANXH |



## 6.9 Setting table

Table 30: Settings

| Parameter                    | Actual value | Default value | Unit | Range   | Resolution |
|------------------------------|--------------|---------------|------|---|------------|
| <b>3I&gt; / 51</b>           |              |               |      |   |            |
| I>                           |              | 01.50         | In   | 0.1...2.5; infinite   | 0.001      |
| t>                           |              | 01.00         | s    | 0.04...64   | 0.010      |
| I> Curve                     |              | DT            | -    | DT, IEC NI, IEC VI, IEC LI, IEC EI, RI, ANSI NI, ANSI VI, ANSI MI, ANSI EI, | -          |
| k                            |              |               |      | 0.02 – 1.6  | 0.010      |
| <b>3I&gt;&gt; / 50-1</b>     |              |               |      |   |            |
| I>>                          |              | 04.00         | In   | 0.2...20; infinite (sensor variant)<br>0.2...25; infinite (CT variant)      | 0.001      |
| t>>                          |              | 00.30         | s    | 0.04...64   | 0.010      |
| <b>3I&gt;&gt;&gt; / 50-2</b> |              |               |      |   |            |
| I>>>                         |              | 10.00         | In   | 0.2...20; infinite (sensor variant)<br>0.2...25; infinite (CT variant)      | 0.001      |
| t>>>                         |              | 00.03         | s    | 0.03...64   | 0.010      |
| <b>I0&gt; / 51N</b>          |              |               |      |   |            |
| I0>                          |              | 00.05         | In   | Ext.: 0.01...2.0; infinite<br>Int.: 0.1...2.0; infinite                     | 0.001      |
| t0>                          |              | 01.50         | s    | 0.04...64   | 0.010      |
| I0> Curve                    |              | DT            | -    | DT, IEC NI, IEC VI, IEC LI, IEC EI, RI, ANSI NI, ANSI VI, ANSI MI, ANSI EI, | -          |
| k0                           |              |               |      | 0.02 – 1.6  | 0.010      |
| <b>I0&gt;&gt; / 50N</b>      |              |               |      |   |            |
| I0>>                         |              | 04.00         | In   | Ext.: 0.05...12.5; infinite<br>Int.: 0.5...12.5; infinite                   | 0.001      |
| t0>>                         |              | 00.05         | s    | 0.04...64   | 0.010      |
| <b>3I2f&gt; / 68</b>         |              |               |      |   |            |
| Inrush threshold             |              | 0.50          | In   | 0.2...25 (sensor variant)<br>0.2...20 (CT variant)                          | 0.010      |
| Ratio Setting                |              | 30%           | %    | 30%...50%,  | 5%         |
| <b>I2&gt; / 46</b>           |              |               |      |   |            |
| I2>                          |              | 0.30          | In   | 0.1...1.5   | 0.010      |
| tI2>                         |              | 1.00          | s    | 0.1 ... 300   | 0.100      |
| block protn                  |              | 0             |      | 0=No<br>1=Yes   |            |
| <b>I2/I1&gt; / 46PD</b>      |              |               |      |   |            |
| I2/I1>                       |              | 015%          | In   | 10...100%   | 0.010      |
| tI2/I1>                      |              | 00.10         | s    | 0.1 ... 64  | 0.100      |
| block protn                  |              | 0             |      | 0=No<br>1=Yes   |            |

Table 30 Settings, continue

| Parameter                   | Actual value | Default value | Unit | Range                             | Resolution |
|-----------------------------|--------------|---------------|------|-----------------------------------|------------|
| <b>3lth&gt; / 49</b>        |              |               |      |                                   |            |
| ∅0                          |              | 080           | %    | 0.0...100%                        | 1%         |
| ∅powerOFF                   |              | 4             | -    | 1...4                             | 1          |
| lb                          |              | 1.0           | In   | 0.1 ... 1.5                       | 0.100      |
| τ↑                          |              | 045           | min  | 1.0...300                         | 1.000      |
| τ↓s                         |              | 045           | min  | 1.0...300                         | 1.000      |
| ∅alm                        |              | 121           | %    | 50...200%,                        | 1%         |
| ∅trip                       |              | 144           | %    | 50...200%,                        | 1%         |
| ∅startinhibit               |              | 105           | %    | 50...200%,                        | 1%         |
| <b>3l/loBF / 51BF/51NBF</b> |              |               |      |                                   |            |
| lcbfp                       |              | 01.1          | In   | 0.2...2.0                         | 0.100      |
| locbfp                      |              | 01.1          | In   | 0.1...2.0                         | 0.100      |
| t Retrip                    |              | 0.10          | s    | 0.06...0.5                        | 0.010      |
| t Backup                    |              | 0.12          | s    | 0.06...0.5                        | 0.010      |
| <b>O -&gt; I / 79</b>       |              |               |      |                                   |            |
| AR start mode               |              | 1             | -    | 1 = Trip, 2 = Gen. start and trip | 1          |
| CB ready                    |              | 1             | -    | 1 = OCO, 2 = CO                   | 1          |
| Shot                        |              | 3             | -    | 0...4                             | 1          |
| Activate t                  |              |               | sec  | 0.1...5                           | 0.100      |
| Pulse tp                    |              |               | sec  | 0.2...20                          | 0.100      |
| Cycle t1                    |              |               | sec  | 0.2...300                         | 0.010      |
| Cycle t2                    |              |               | sec  | 0.2...300                         | 0.010      |
| Cycle t3                    |              |               | sec  | 0.2...300                         | 0.010      |
| Cycle t4                    |              |               | sec  | 0.2...300                         | 0.010      |
| Reclaim tr                  |              |               | sec  | 1...300                           | 1          |
| Block tb                    |              |               | sec  | 1...300                           | 1          |

Table 31: Configuration

| Configuration Parameter | Actual value | Default value | Unit | Range   | Resolution |
|-------------------------|--------------|---------------|------|---|------------|
| Blocking: I> / 51       |              | NO            | -    | NO; YES   | -          |
| Blocking: I>> / 50-1    |              | NO            | -    | NO; YES   | -          |
| Blocking: I>>> / 50-2   |              | NO            | -    | NO; YES   | -          |
| Blocking: Io> / 51N     |              | NO            | -    | NO; YES   | -          |
| Blocking: Io>> / 50N    |              | NO            | -    | NO; YES   | -          |
| Blocking: 3Ith> / 49    |              | NO            | -    | NO; YES   | -          |
| Blocking: I2> / 46      |              | NO            | -    | NO; YES   | -          |
| Blocking: I2/I1> / 46PD |              | NO            | -    | NO; YES   | -          |
| Blocking: BF            |              | NO            | -    | NO; YES   | -          |
| Blocking: O -> I / 79   |              | NO            | -    | NO; YES   | -          |
| Blocking Remote Ctrl    |              | NO            | -    | NO; YES   | -          |
| Block TCS               |              | NO            | -    | NO; YES   | -          |
| TCS Operate Time        |              | 5             | sec  | 1 ... 300   | 1          |
| Earth type / IO meas.   |              | External      |      | Internal; External  | -          |
| CT Ipn                  |              | 1000          | A    | 20 ... 9999   | 1          |
| CT Isn                  |              | 1             | A    | 1; 5  | -          |
| Frequency               |              | 50            | Hz   | 50; 60  | -          |
| COM Parameters          |              |               |      |   |            |
| Protocol                |              |               |      | MODBUS RTU<br>IEC 60870-5-103                                     |            |
| Comm. Baud Rate         |              | 19200         | -    | MODBUS: 2400; 4800; 9600;<br>19200; 38400<br>IEC_103: 9600; 19200 | -          |
| Relay Addr              |              | 001           | -    | MODBUS: 001 ... 247<br>IEC_103: 001...254                         | -          |
| Comm. Parity            |              | Even          | -    | MODBUS: None; Odd; Even<br>IEC_103: None; Even                    | -          |
| Class2 Intv (IEC_103)   | 10           | sec           |      | 0...60 sec  |            |
| Class2 SF               | 2.4          |               |      | 1.2; 2.4  |            |
| Comm Admin Level        |              | Yes           | -    | NO; YES   | -          |

**Table 32: Binary Input configuration**

| Binary input<br>Connected to signal | BI1 | BI2 | BI3 | BI4 |
|-------------------------------------|-----|-----|-----|-----|
| Input behavior: inversion           | (-) | (-) | (-) | (-) |
| Block : l> / 51                     |     |     |     |     |
| Block : l>> / 50-1                  |     |     |     |     |
| Block : l>>> / 50-2                 |     |     |     |     |
| Block : lo> / 51N                   |     |     |     |     |
| Block : lo>> / 50N                  |     |     |     |     |
| Blocking: 3lth> / 49                |     |     |     |     |
| Blocking: l2> / 46                  |     |     |     |     |
| Blocking: l2/l1> / 46PD             |     |     |     |     |
| Blocking: BF                        |     |     |     |     |
| Blocking: BF ProtExt                |     |     |     |     |
| Blocking: BF RecTrip                |     |     |     |     |
| CB Ready                            |     |     |     |     |
| Blocking: O -> l / 79               |     |     |     |     |
| Block : CB Control                  |     |     |     |     |
| Reset                               |     |     |     | (x) |
| CB Close Position                   |     |     |     |     |
| CB Open Position                    |     |     |     |     |
| CB Maintenance (Test)               |     |     |     |     |
| TCS                                 |     | (x) |     |     |
| TCS Block                           |     |     |     |     |
| External Trip                       |     |     | (x) |     |
| External Close                      |     |     |     |     |
| Power off                           |     |     |     |     |
| Signal 1                            |     |     |     |     |
| Signal 2                            |     |     |     |     |
| Signal 3                            |     |     |     |     |
| SG Select                           |     |     |     |     |

Input behavior: “-” = Non inverted, “I” = Inverted  
 Remark: “(..)” = Default setting

**Table 33: Binary Output configuration**

| Binary output<br>Signal to activate output | BO1 | BO2 | BO3 | BO4 | BO5 | BO6 |
|--|-----|-----|-----|-----|-----|-----|
| Output behavior: inversion                 | (-) | (-) | (-) | (-) | (-) | (-) |
| Output behavior: duration                  | (P) | (P) | (P) | (S) | (P) | (P) |
| Start : l> / 51                            |     |     |     |     |     |     |
| Start : l>> / 50-1                         |     |     |     |     |     |     |
| Start : l>>> / 50-2                        |     |     |     |     |     |     |
| Start : lo> / 50N-1                        |     |     |     |     |     |     |
| Start : lo>> / 50N-2                       |     |     |     |     |     |     |

Table 33: Binary Output configuration, continue

| Binary output<br>Signal to activate output | BO1 | BO2 | BO3 | BO4 | BO5 | BO6 |
|--|-----|-----|-----|-----|-----|-----|
| 3lth > Alm                                 |     |     |     |     |     |     |
| 3lth> Blkcl                                |     |     |     |     |     |     |
| I2/I1> Str                                 |     |     |     |     |     |     |
| I2> Start                                  |     |     |     |     |     |     |
| Trip : I> / 51                             | (x) | (x) |     |     | (x) |     |
| Trip : I>> / 50-1                          | (x) | (x) |     |     | (x) |     |
| Trip : I>>> / 50-2                         | (x) | (x) |     |     | (x) |     |
| Trip : Io> / 51N                           | (x) | (x) |     |     |     | (x) |
| Trip : Io> / 50N                           | (x) | (x) |     |     |     | (x) |
| 3lth > Trip                                |     |     |     |     |     |     |
| I2/I1> Trip                                |     |     |     |     |     |     |
| I2> Trip                                   |     |     |     |     |     |     |
| BF Stage1                                  |     |     |     |     |     |     |
| BF Stage2                                  |     |     |     |     |     |     |
| BF RecTrip                                 |     |     |     |     |     |     |
| O->I Close                                 |     |     |     |     |     |     |
| O->I InPro                                 |     |     |     |     |     |     |
| O->I FinalTr                               |     |     |     |     |     |     |
| O->I Blocked                               |     |     |     |     |     |     |
| Signal 1                                   |     |     |     |     |     |     |
| Signal 2                                   |     |     |     |     |     |     |
| Signal 3                                   |     |     |     |     |     |     |
| CB Open Command                            | (x) | (x) |     |     |     |     |
| CB Close Command                           |     |     | (x) |     |     |     |
| TCS Fault                                  |     |     |     |     |     |     |
| Unit Ready                                 |     |     |     | (x) |     |     |

Output behavior : “.” = Non inverted, “!” = Inverted  
 Remark : “(..)” = Default setting

**Table 34 LED configuration**

| Configurable LED<br>Signal to<br>activate output | LED1 | LED2 | LED3 | LED4 | LED5 |
|--|------|------|------|------|------|
| LED behavior: S=Self reset<br>H=Hold             | (H)  | (H)  | (S)  | (H)  | (H)  |
| Start : I> / 51                                  |      |      |      |      |      |
| Trip : I> / 51                                   | (x)  |      |      |      |      |
| Start : I>> / 50-1                               |      |      |      |      |      |
| Trip : I>> / 50-1                                | (x)  |      |      |      |      |
| Start : I>>> / 50-2                              |      |      |      |      |      |
| Trip : I>>> / 50-2                               | (x)  |      |      |      |      |
| Start : Io> / 50N-1                              |      |      |      |      |      |
| Trip : Io> / 50N-1                               |      | (x)  |      |      |      |
| Start : Io>> / 50N-2                             |      |      |      |      |      |
| Trip : Io>> / 50N-2                              |      | (x)  |      |      |      |
| 3lth> Alm  |      |      |      |      |      |
| 3lth> BlkCl                                      |      |      |      |      |      |
| I2/I1> Str                                       |      |      |      |      |      |
| I2/I1> Tr  |      |      |      |      |      |
| I2> Start  |      |      |      |      |      |
| I2> Trip   |      |      |      |      |      |
| BF Stage1  |      |      |      |      |      |
| BF Stage2  |      |      |      |      |      |
| BF RecTrip                                       |      |      |      |      |      |
| O->I Close                                       |      |      |      |      |      |
| O->I InPro                                       |      |      |      |      |      |
| O->I FinalTr                                     |      |      |      |      |      |
| O->I Blocked                                     |      |      |      |      |      |
| Signal 1   |      |      |      |      |      |
| Signal 2   |      |      |      |      |      |
| Signal 3   |      |      |      |      |      |
| TCS Fault  |      |      | (x)  |      |      |

## 6.10 Earthing of relay and Bonding of sensor cable shield

### 6.10.1 Earthing of relay



The earth lead must be at least 6.0 mm<sup>2</sup>. If the length of the earth lead is long, the cross section of the wire must be increased.



To improve the immunity against high frequency distortion it is recommended to use flat braided copper wire as the earth lead.

To connect a separate earth protection lead:

1. Loosen the protective earth screw to connect a separate earth protection lead.

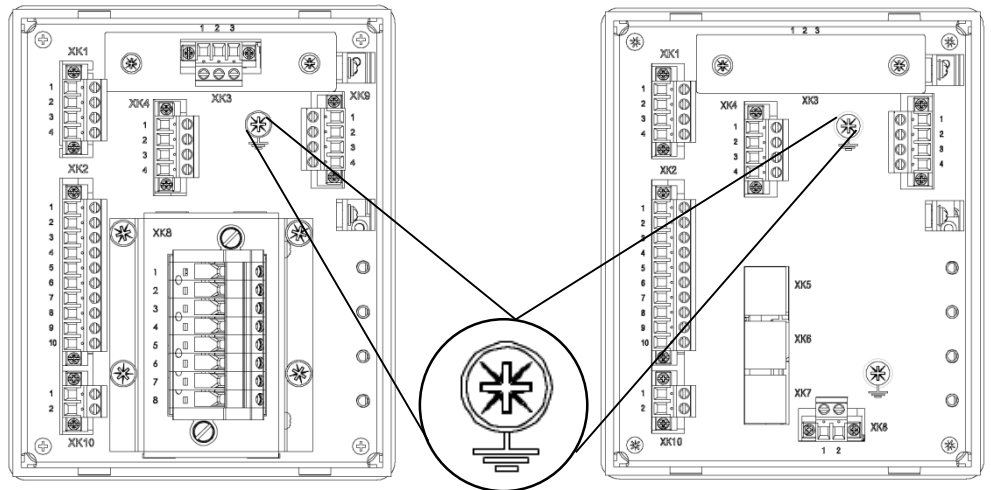

Figure 34: Location of protective earth screw



The earth lead should be as short as possible but notice that extra length is required for door mounting.



Each IED must have its own earth lead connected to the earth circuit connector.

2. Connect the earth lead to the earth bar. Use either stripped wire screwed between a washer cup and the protective earth screw or a ring-lug.



Select a suitable ring-lug to fit under the M4 screw.

3. Tighten the protective earth screw.
4. Support the earth lead so that it cannot break or weaken.  
Be aware of the mechanical, chemical and electrochemical environment.

### 6.10.2 Shield connection at relay side (Sensor variant)

- Remove the isolation of the sensor cable for the specific section at relay side.
- Metal strip to be mounted at the rear of the relay as shown in figure with cables.
- Tighten screws carefully so that the sensor cable should not get damaged due to misalignment
- This shall result in a better connection of the sensor cable shield to the chassis respect to ground.

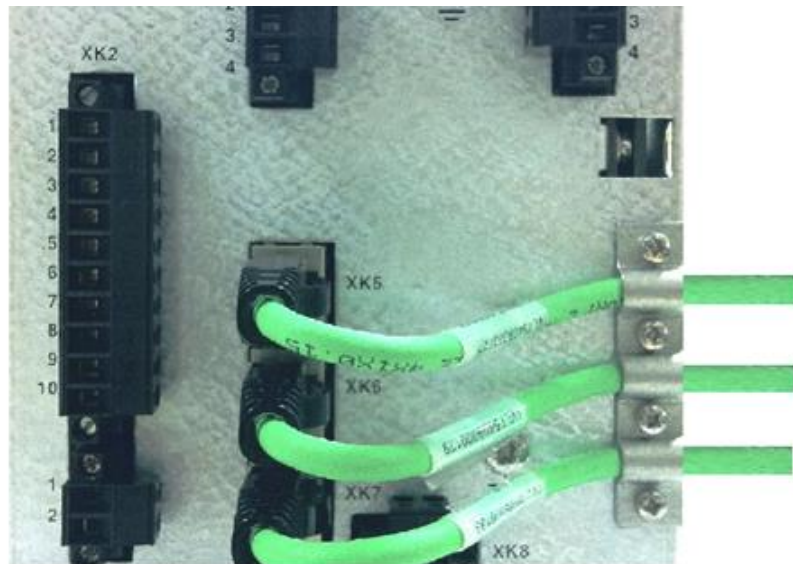

Figure 35: Shields connection at relay side

- In case of breaker mounting metal strip can be mounted at the rear of the relay on metal plate.





# Contact us

## **ABB India Limited**

### **Distribution Automation**

Maneja Works

Vadodara-390013, India

Phone: +91 265 2604386

Fax: +91 265 2638922

## **ABB Oy**

### **Medium Voltage Products,**

### **Distribution Automation**

P.O. Box 699

FI-65101 VAASA, Finland

Phone: +358 10 22 11

Fax: +358 10 22 41094

[www.abb.com/substationautomation](http://www.abb.com/substationautomation)