

Feeder Protection Relay REF 610

Operator's Manual



Contents

Copyrights	5
1. Introduction.....	7
1.1. This manual.....	7
1.2. Use of symbols	7
1.3. Intended audience	7
1.4. Product documentation	8
1.5. Document conventions	8
1.6. Document revisions.....	9
2. Safety information.....	11
3. Product overview	13
3.1. Use of the relay.....	13
3.2. Features.....	13
4. Operation	15
4.1. HMI features	15
4.1.1. Front panel	15
4.1.2. How to use the push buttons	15
4.1.3. Display.....	16
4.1.3.1. Display test at power up	16
4.1.3.2. Display modes	17
4.1.3.3. Display backlight	17
4.1.3.4. How to adjust the display contrast....	18
4.1.4. Main menu	18
4.1.5. Submenu.....	18
4.1.6. HMI passwords	19
4.1.7. SPA password.....	20
4.1.8. How to select language	21
4.1.9. How to set the real-time clock.....	22
4.1.10. How to reset the trip lockout function	23
4.1.11. How to switch between front and rear connection.....	24
4.1.11.1. Indicator LED for front communication.....	25
4.1.12. How to select the protocol for rear communication	25
4.2. HMI operation levels	26
4.2.1. User level.....	26
4.2.1.1. Menu groups of the user level	26
4.2.1.2. How to monitor measured values	27
4.2.1.3. How to monitor recorded data	29
4.2.1.4. INFO menu group.....	30
4.2.2. Technical level.....	31

4.2.2.1.	Menu system of parameters	31
4.2.2.2.	How to change settings	31
4.2.2.3.	Configuration	35
4.2.2.4.	How to acknowledge and reset indications, output contacts and memorized values	38
4.3.	Protection relay indications	39
4.3.1.	Indicator LEDs	39
4.3.1.1.	Green indicator LED	39
4.3.1.2.	Yellow indicator LED	40
4.3.1.3.	Red indicator LED	40
4.3.1.4.	Programmable indicator LEDs	41
4.3.2.	Indication messages	41
4.3.2.1.	Operation indication messages	41
4.3.2.2.	Disturbance recorder indication	43
4.3.2.3.	Self-supervision	43
4.4.	Detachable plug-in unit	46
4.4.1.	Identifying the product	46
4.4.2.	Detaching and installing the plug-in unit	47
4.4.3.	Inserting and changing the battery	49
5.	Commissioning and maintenance	51
5.1.	Commissioning instructions	51
5.2.	Maintenance instructions	52
5.2.1.	Relay verification	53
5.2.2.	Preventive parts replacement	53
5.3.	Measurements verification	53
5.4.	Function test	54
5.5.	Digital input test	55
5.6.	Arc detection test	55
5.7.	Testing protection functions	56
5.7.1.	Testing of the short-circuit protection	56
5.7.2.	Testing of the earth-fault protection	57
6.	Spare parts	59
6.1.	Plug-in unit	59
6.2.	Battery	59
7.	Repair	61
8.	Ordering information	63
9.	Abbreviations	65

Copyrights

The information in this document is subject to change without notice and should not be construed as a commitment by ABB Oy. ABB Oy assumes no responsibility for any errors that may appear in this document.

In no event shall ABB Oy be liable for direct, indirect, special, incidental or consequential damages of any nature or kind arising from the use of this document, nor shall ABB Oy be liable for incidental or consequential damages arising from use of any software or hardware described in this document.

This document and parts thereof must not be reproduced or copied without written permission from ABB Oy, and the contents thereof must not be imparted to a third party nor used for any unauthorized purpose.

The software or hardware described in this document is furnished under a license and may be used, copied, or disclosed only in accordance with the terms of such license.

© Copyright 2004 ABB. All rights reserved.

Trademarks

ABB is a registered trademark of ABB Group. All other brand or product names mentioned in this document may be trademarks or registered trademarks of their respective holders.

Guarantee

Please inquire about the terms of guarantee from your nearest ABB representative.

1. Introduction

1.1. This manual

This manual provides basic information on the protection relay REF 610 and presents detailed instructions on how to use the human-machine interface (HMI) of the relay. In addition to the instructive part, a short chapter on commissioning and maintenance of the relay is included.

1.2. Use of symbols

This publication includes the following icons that point out safety-related conditions or other important information:



The electrical warning icon indicates the presence of a hazard which could result in electrical shock.



The warning icon indicates the presence of a hazard which could result in personal injury.



The caution icon indicates important information or warning related to the concept discussed in the text. It might indicate the presence of a hazard which could result in corruption of software or damage to equipment or property.



The information icon alerts the reader to relevant facts and conditions.



The tip icon indicates advice on, for example, how to design your project or how to use a certain function.

Although warning hazards are related to personal injury, it should be understood that operation of damaged equipment could, under certain operational conditions, result in degraded process performance leading to personal injury or death. Therefore, comply fully with all warning and caution notices.

1.3. Intended audience

This manual is intended for operators, supervisors and administrators to support normal use of the product.

1.4. Product documentation

In addition to the relay and this manual, the delivery contains the following relay-specific documentation:

Table 1.4.-1 REF 610 product documentation

Name	Document ID
Installation Manual	1MRS752265-MUM
Technical Reference Manual	1MRS755310
Operator's Manual	1MRS755311

1.5. Document conventions

The following conventions are used for the presentation of material:

- Push button navigation in the human-machine interface (HMI) menu structure is presented by using the push button icons, for example:

To navigate between the options, use ▲ and ▼.

- HMI menu paths are presented as follows:

Use the arrow buttons to select CONFIGURATION\ COMMUNICATION\ SPA SETTINGS\ PASSWORD SPA.

- Parameter names, menu names, relay indication messages and relay's HMI views are shown in a Courier font, for example:

Use the arrow buttons to monitor other measured values in the menus DEMAND VALUES and HISTORY DATA.

- HMI messages are shown inside quotation marks when it is good to point out them for the user, for example:

When you store a new password, the relay confirms the storage by flashing “- - -” once on the display.

1.6.**Document revisions**

Version	IED Revision	Date	History
A	A	05.10.2004	Document created. Version A2 includes only a minor layout change.
B	A	12.09.2005	Content updated
C	C	30.11.2006	Content updated
D	C	06.07.2007	Content updated

2. Safety information



Dangerous voltages can occur on the connectors, even though the auxiliary voltage has been disconnected.

Non-observance can result in death, personal injury or substantial property damage.

Only a competent electrician is allowed to carry out the electrical installation.

National and local electrical safety regulations must always be followed.

The frame of the device has to be carefully earthed.

When the plug-in unit has been detached from the case, do not touch the inside of the case. The relay case internals may contain high voltage potential and touching these may cause personal injury.



The device contains components which are sensitive to electrostatic discharge. Unnecessary touching of electronic components must therefore be avoided.

Breaking the sealing tape on the upper handle of the device will result in loss of guarantee and proper operation will no longer be insured.

3. Product overview

3.1. Use of the relay

The feeder protection relay REF 610 is a versatile multifunction protection relay mainly designed to protect incoming and outgoing feeders in a wide range of feeder applications.

The relay is based on a microprocessor environment. A self-supervision system continuously monitors the operation of the relay.

The HMI includes a liquid crystal display (LCD) which makes the local use of the relay safe and easy.

Local control of the relay via serial communication can be carried out with a computer connected to the front communication port. Remote control can be carried out via the rear connector connected to the control and monitoring system through the serial communication bus.

3.2. Features

- Three-phase non-directional overcurrent protection with definite-time or IDMT characteristic, low-set stage.
- Three-phase non-directional overcurrent protection, high-set stage
- Three-phase non-directional overcurrent protection, instantaneous stage
- Non-directional earth-fault protection with definite-time or IDMT characteristic, low-set stage
- Non-directional earth-fault protection, high-set stage.
- Phase discontinuity protection
- Three-phase thermal overload protection for cables
- Arc protection:
 - Two lens sensors for arc detection (optional)
 - Automatic reference level adjustment based on backlight intensity
 - Arc detection via a remote light signal
- Automatic reclosing 1...3 shots
- Circuit-breaker failure protection
- Trip counters for circuit-breaker condition monitoring
- Trip-circuit supervision with possibility to route the warning signal to a signal output
- Trip lockout function
- Four accurate current inputs
- User-selectable rated frequency 50/60 Hz
- Three normally open power output contacts
- Two change-over signal output contacts and three additional change-over signal output contacts on the optional I/O module
- Output contact functions freely configurable for wanted operation

Operator's Manual

- Two galvanically isolated digital inputs and three additional galvanically isolated digital inputs on the optional I/O module
- Disturbance recorder:
 - Recording time up to 80 seconds
 - Triggering by one or several internal or digital input signals
 - Records four analog channels and up to eight user-selectable digital channels
 - Adjustable sampling rate
- Non-volatile memory for:
 - Up to 100 event codes with time stamp
 - Setting values
 - Disturbance recorder data
 - Recorded data of the five last events with time stamp
 - Number of AR shots and starts/trips for protection stages
 - Operation indication messages and LEDs showing the status at the moment of power failure
- HMI with an alphanumeric LCD and navigation buttons
 - Eight programmable LEDs
- Multi-language support
- User-selectable password protection for the HMI
- Display of primary current values
- Demand values
- All settings can be modified with a PC
- Optical front communication connection: wirelessly or via cable
- Optional rear communication module with plastic fibre-optic, combined fibre-optic (plastic and glass) or RS-485 connection for system communication using the SPA-bus, IEC 60870-5-103 or Modbus (RTU and ASCII) communication protocol
- Optional DNP 3.0 rear communication module with RS-485 connection for system communication using the DNP 3.0 communication protocol
- Battery back-up for real-time clock
- Battery charge supervision
- Continuous self-supervision of electronics and software
- Detachable plug-in unit

4. Operation

4.1. HMI features

4.1.1. Front panel

The front panel of the relay contains:

- Alphanumeric 2 × 16 characters' LCD with backlight and automatic contrast control
- Three indicator LEDs (green, yellow, red) with fixed functionality
- Eight programmable indicator LEDs (red)
- HMI push-button section with four arrow buttons and buttons for clear/cancel and enter, used in navigating in the menu structure and in adjusting setting values
- Optically isolated serial communication port with an indicator LED.

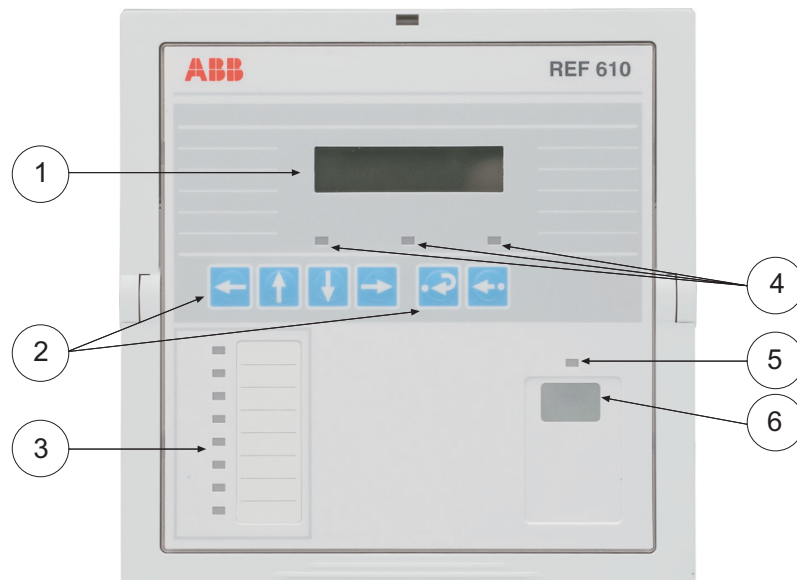

A040214_2

Fig. 4.1.1.-1 Front view of the relay

- 1) LCD
- 2) HMI push-button section
- 3) Programmable indicator LEDs (red)
- 4) Indicator LEDs:
 - Left: Ready (green)
 - Center: Start/Alarm (yellow)
 - Right: Trip (red)
- 5) Indicator LED for front communication
- 6) Front communication port (infrared)

4.1.2. How to use the push buttons

The HMI contains push buttons for navigating in the menu.

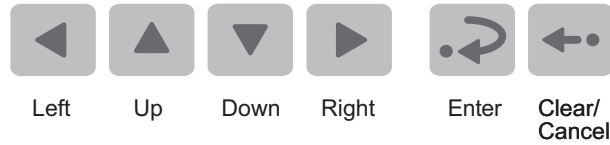

A040225

Fig. 4.1.2.-1 Navigation push buttons

Use the navigation buttons to view, select and edit the wanted menu items.



























- Activate the main menu by pressing an arrow button.
- Move between the menu levels and menu items by using the arrow buttons.
- Select the item to be edited or store a new value by pressing .
- Increase or decrease the activated digit, shift the activated decimal point, or navigate between options by using  and .
- Cancel and return the display to the previous mode (view mode or idle mode), by pressing .

Table 4.1.2.-1 Button navigation and editing

Wanted step or operation	Push button
Step downward in the main menu or a submenu	
Step upward in the main menu or a submenu	
Entering a submenu from the main menu or a higher submenu	
Leaving a submenu for the main menu or a higher submenu	
Increasing a value in the setting mode	
Decreasing a value in the setting mode	
Moving the cursor in the setting mode	 or 
Selecting the front connection at power up	 and 
Entering or leaving the setting mode, storing a new value	
Entering the monitoring state	 and 
Adjusting the display contrast	 and  or 
Resetting or canceling, leaving the setting mode without storing a new value	
Resetting latched output contacts in the idle mode	 for 5 s
Acknowledging and resetting indications, latched output contacts and memorized values	 and 
Resetting thermal level to 0 at power up	 and 

4.1.3.

Display

4.1.3.1.

Display test at power up

When connecting the auxiliary voltage to the relay:

1. The backlight is turned on after the relay has performed the internal power-up tests and entered into the protection mode.
2. The display is tested by inverting it for approximately three seconds, see Fig. 4.1.3.1.-1.
3. The display is returned to the idle mode and the backlight is turned off if no operation indication message is displayed. However, if the non-volatile function is active, a message shown on the display before the auxiliary voltage was disconnected reappears on the display.

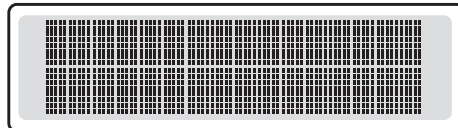

A040216

Fig. 4.1.3.1.-1 Display test at power up, display inverted

4.1.3.2.

Display modes

When the display is in the idle mode, the name of the feeder is displayed, which by default is - ABB -. To change the name of the feeder, use SPA parameter M20.

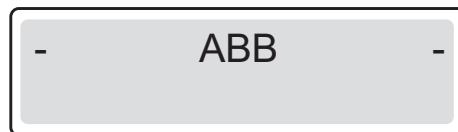

A040217

Fig. 4.1.3.2.-1 Display in the idle mode

When the display is in the view mode, you can only view the settings.

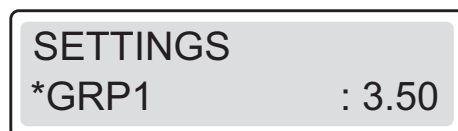

A040218

Fig. 4.1.3.2.-2 Display in the view mode

When the display is in the setting mode, you can also edit the settings.

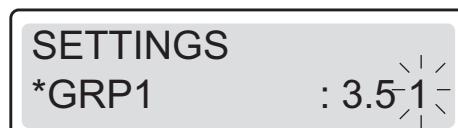

A040219

Fig. 4.1.3.2.-3 Display in the setting mode

4.1.3.3.





Display backlight

Normally the backlight of the display is off.

- Turn the backlight on by pressing an arrow button on the HMI. If the HMI panel is not used for approximately five minutes, the backlight is turned off automatically.
- Activating the power-saving built-in feature by pressing  turns the backlight off within 20 seconds.

4.1.3.4. How to adjust the display contrast

The display contrast is dependent on the temperature. The relay automatically adjusts the contrast for optimum readability. When the display is in the idle mode, you can also adjust the contrast manually.

- To increase the contrast, hold down  and adjust the contrast using .
- To decrease the contrast, hold down  and adjust the contrast using .

After power start up of the relay, the factory default value of the display contrast is automatically restored.

4.1.4. Main menu



The main menu contains six main groups:

- OPERATION
- MEASUREMENTS
- RECORDED DATA
- SETTINGS
- CONFIGURATION
- INFO



A040228

Fig. 4.1.4.-1 Display showing the first main menu group

- Navigate between the main menu groups by using  and .
- Return the display to the idle mode by pressing .

The display is returned to the idle mode on expiration of the time out.

4.1.5. Submenu

The menu structure contains several subgroups. The name of the main menu group is always shown on the first line. The second line displays either the name of the group menu, the name of the parameter and the parameter value, or just the parameter value, in which case it is also the name of the parameter.



A040229

Fig. 4.1.5.-1 Display showing the first submenu

- Enter a submenu by pressing ; exit by pressing .
- Navigate between the main levels in the submenus by using or .
- Press to return the display to the idle mode.

4.1.6.

HMI passwords

The HMI passwords are used to protect user-changeable values on technical level from being changed by an unauthorized person. There are two different HMI passwords; an HMI setting password for changing all user-changeable values and an HMI communication password for changing communication settings only. The password function remains inactive until the default password is replaced. The default HMI password is 999. You can also change the HMI passwords via SPA parameters V162 and V163, but you can only read the password via the HMI.

As soon as you have replaced the default HMI password, the new password is required for altering parameter values. Once you have given the valid password, the display remains in the setting mode until returned to the idle mode.

The following rules and exceptions apply, if the HMI passwords are in use:

- Navigating and reading parameter values do not require a password.
- All user-changeable values can be changed with the HMI setting password.
- User-changeable values under CONFIGURATION\COMMUNICATION can be changed either with the HMI communication password or the HMI setting password.
- Changing of the SPA password requires the HMI setting password.
- Changing of the HMI language does not require a password.
- Setting of time and date does not require a password.
- Performing trip lockout reset does not require a password.

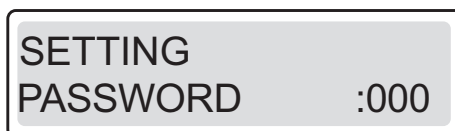

A040230_2









Fig. 4.1.6.-1 HMI setting password request for editing setting parameters



A060567

Fig. 4.1.6.-2 HMI communication password request for editing setting parameters

Change the HMI setting password as follows:

1. Press an arrow button to access the main menu.
2. Use the arrow buttons to select CONFIGURATION\HMI PASSWORDS \ SETTING PASSWORD and press .
3. Press  to enter the setting mode and give the current HMI password if required. If the default password 999 is still valid, no password is required.
4. The first digit of the password to be edited starts to flash. Set the digit using  and .
5. Activate the next digit to be set by pressing  or .
6. To store the new password and return the display to the view mode, press . The display confirms the storage by flashing “- - -” once on the display.
Alternatively, to exit the setting mode without storing the password change, press  once before confirming and the display returns to the view mode.
7. Press  to return the display to the idle mode.



The same procedure applies also when changing the HMI communication password.

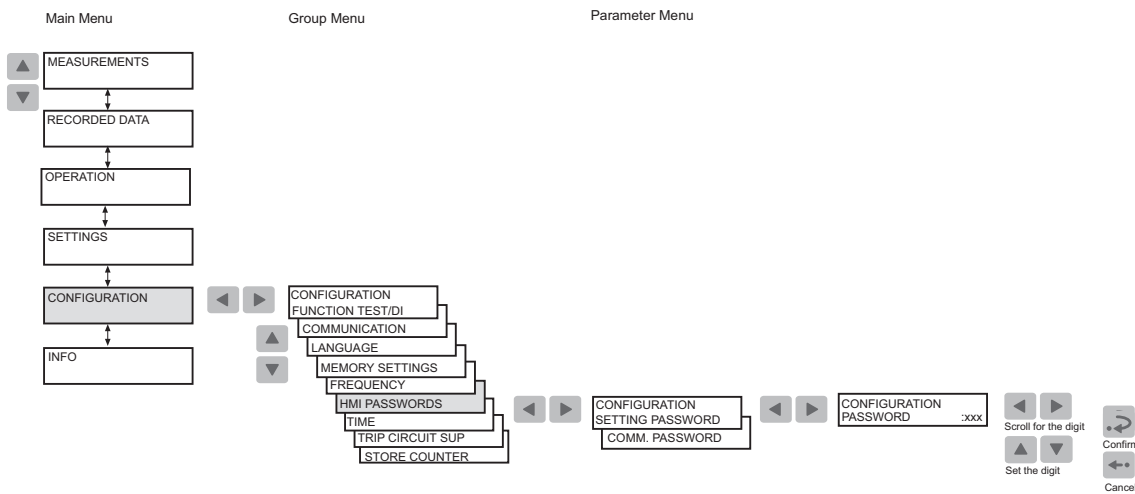

A040232_2









Fig. 4.1.6.-3 Changing HMI setting password and HMI communication password.

4.1.7. SPA password

The password for SPA bus communication is required for altering parameter values via the SPA bus. The default password is 001. You can change the SPA password either via the HMI or the SPA bus by first entering the currently valid password into parameter V160 and then entering the new password into parameter V161.

Change the SPA password as follows:

Operator's Manual

1. Press an arrow button to access the main menu
2. Use the arrow buttons to select CONFIGURATION\ COMMUNICATION\ SPA SETTINGS\ PASSWORD SPA and press .
3. Press  to enter the setting mode and give the current HMI password if required. If the default password 999 is still valid, no password is required.
4. The first digit of the password to be edited starts to flash. Set the digit using  and .
5. Activate the next digit to be set by pressing  or .
6. To store the new SPA password and return the display to the view mode, press . The display confirms the storage by flashing "-- --" once on the display.
Alternatively, to exit the setting mode without storing the SPA password change, press  once before confirming and the display returns to the view mode.
7. Press  to return the display to the idle mode.

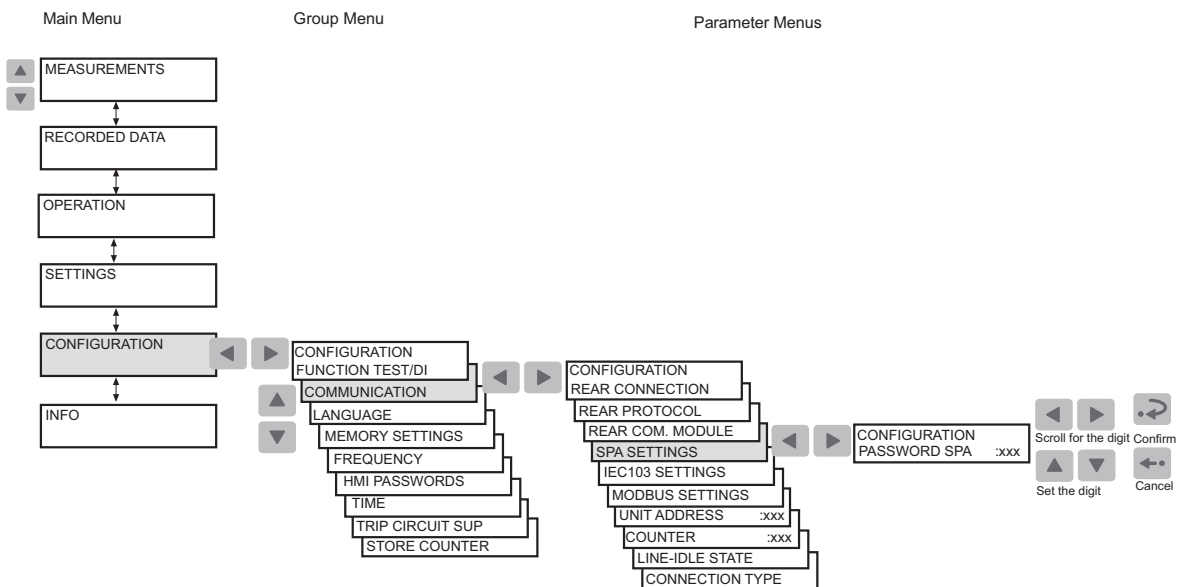





A040234_2

Fig. 4.1.7.-1 Changing SPA password

4.1.8. How to select language

The relay allows you to choose among several different languages. The default language is English.

Change the display language as follows:

1. Press an arrow button to access the main menu.
2. Use the arrow buttons to select CONFIGURATION\ LANGUAGE and press  to enter the currently valid language.
3. Press  to enter the setting mode and give the password if required. The second line starts to flash indicating that you are allowed to set the language.
4. Use  or  to move the cursor to the wanted language.

Operator's Manual

5. Press to confirm the selection. The selected language is shown on the display.
6. Press to return the display to the idle mode.

By pressing before confirming the selection, the former language remains active and the display is returned to the view mode. Pressing again returns the display to the idle mode.

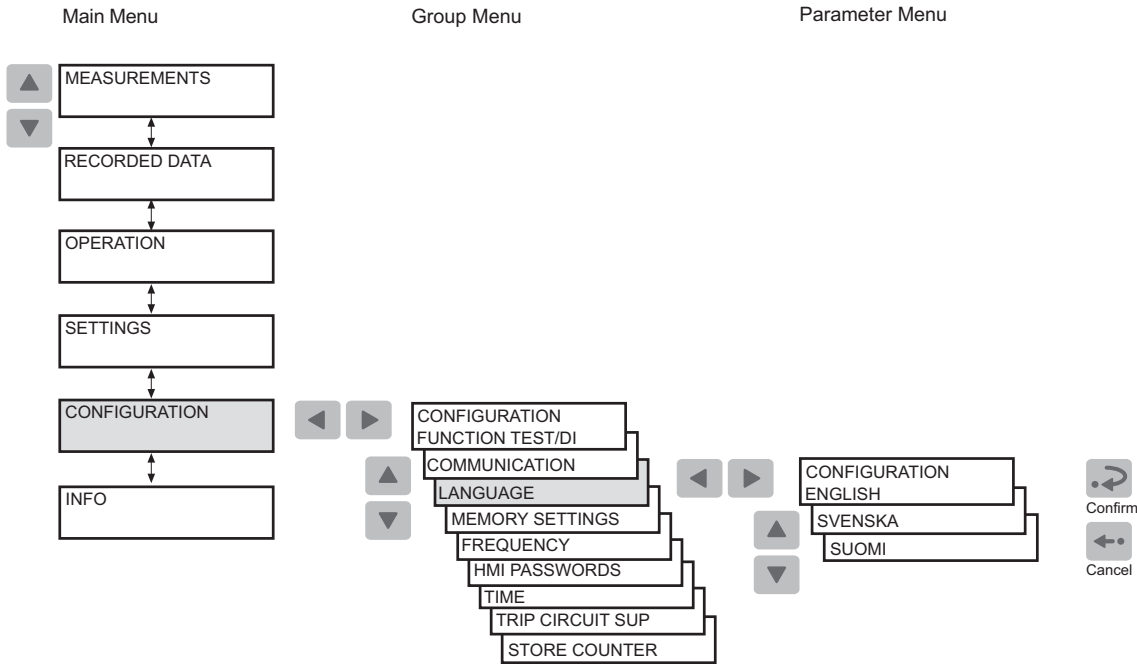

A040235_2

Fig. 4.1.8.-1 Selecting language



The list of languages in the language selection menu differs depending on the HMI language set number in the order number.

4.1.9. How to set the real-time clock

The real-time clock used for time-stamped events is set via two different settings, one for Year-Month-Day and another for Hours-Minutes-Seconds.

To change one setting or both settings:

1. Press an arrow button to access the main menu.
2. Use the arrow buttons to select CONFIGURATION\ TIME and press .
3. Use or to select the parameter to be edited.
4. Press to enter the setting mode and give the password, if required. If the default password 999 is still valid, no password is required.

5. The first digit of the setting value of the parameter to be edited starts to flash. Use and to move the cursor and and to increase or decrease the value. The setting range (for example Year or Minutes) is shown on the right-hand side of the second line of the display.
6. To store a new value and return the display to the view mode, press .
7. To exit the setting mode without storing the changes, press once before confirming and the display is returned to the view mode.
8. Press to return the display to the idle mode.

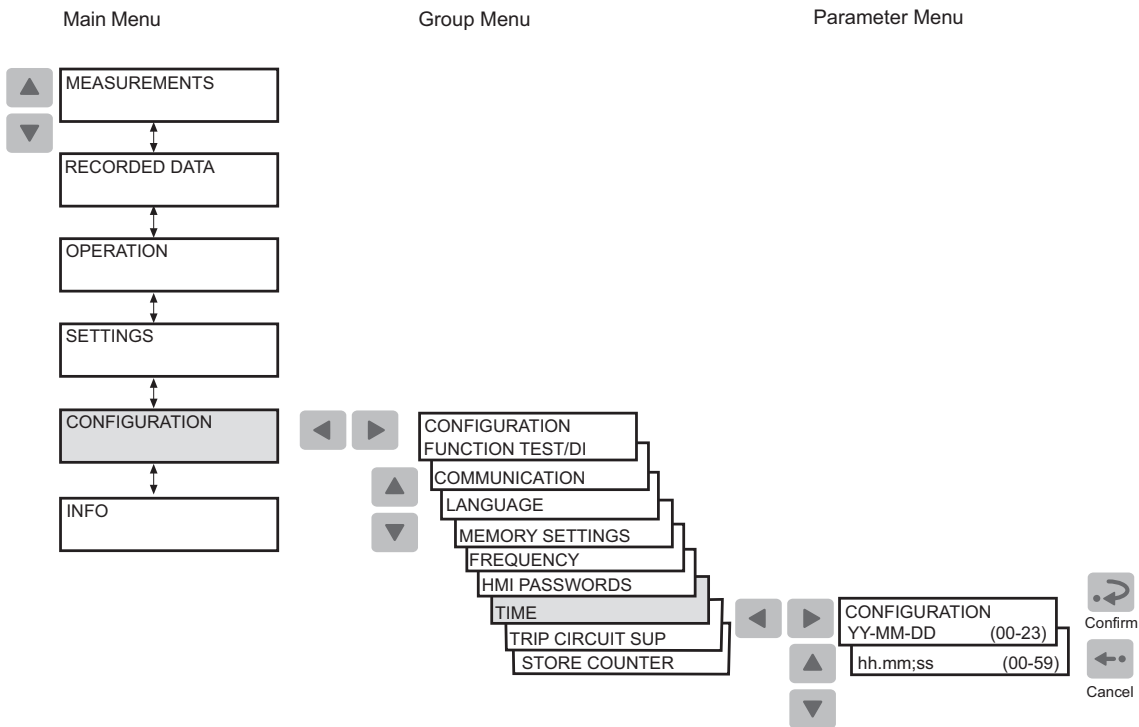

A040238_2

Fig. 4.1.9.-1 Setting the real-time clock

4.1.10. How to reset the trip lockout function

The trip lockout function is used to prevent accidental closing of the circuit breaker after a trip. The trip lockout function must be locally reset with a separate reset before the circuit breaker can be closed again.

Reset the trip lockout as follows:

1. Press an arrow button to access the main menu.
2. Use the arrow buttons to select OPERATION\ TRIP LOCKOUT\ LOCKOUT RESET.
3. Press to enter the setting mode. The second line starts to flash.
4. Press to reset trip lockout.
5. Press to return the display to the idle mode.

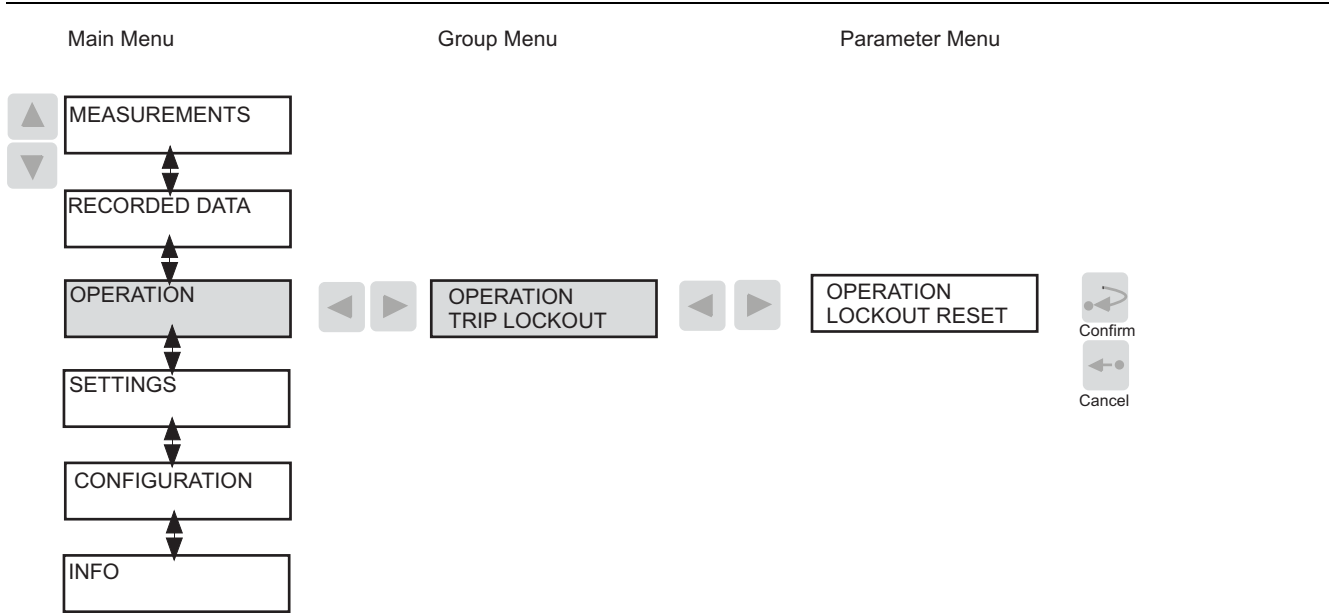

A040239

Fig. 4.1.10.-1 Resetting trip lockout function

4.1.11.

How to switch between front and rear connection

There are two means of serial communication available for the relay: the front connection for SPA bus communication and optional rear communication modules for communication via the SPA bus, IEC 60870-5-103, MODBUS (RTU or ASCII) protocol or DNP 3.0 protocol.



If the relay is not provided with an optional rear communication module, or if the module has been disabled, the front connection is always active and switching between front and rear connection is not allowed.

If the optional rear communication module is installed and enabled, the default setting is the rear connection. Switch between front and rear connection as follows:

1. Press an arrow button to access the main menu.
2. Use the arrow buttons to select CONFIGURATION\ COMMUNICATION and press . The cursor is at the setting currently in use (REAR CONNECTION or FRONT CONNECTION).
3. Press to enter the setting mode. The second line starts to flash.
4. Use or to select the wanted setting.
5. Press to confirm the selection.
6. Press to return the display to the idle mode.

When the front connection has been selected and there is no communication for approximately five minutes, the rear connection is automatically activated. To keep the front connection continuously active, press and simultaneously when connecting the auxiliary voltage to the relay.



When the rear connection is selected, the selected rear protocol is automatically activated.

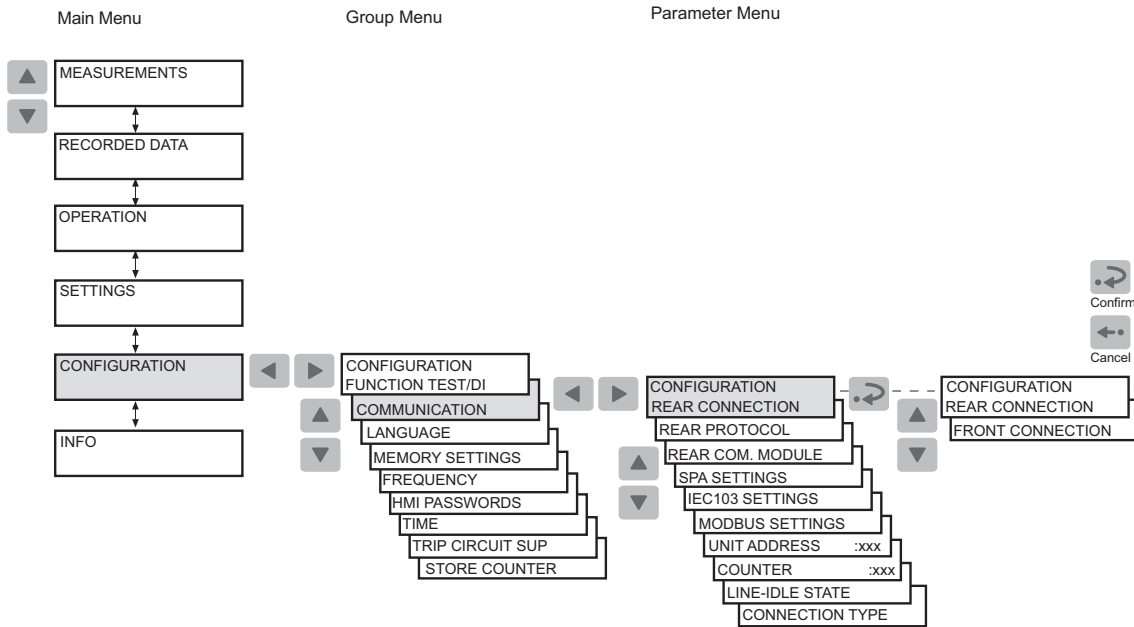

A040242_2

Fig. 4.1.11.-1 Switching between the front and rear connections

4.1.11.1. Indicator LED for front communication

- Indicator off: the rear communication is currently selected.
- Lit indicator: the front communication port is currently selected.
- Flashing indicator: the front communication port is currently selected and the relay is communicating.

4.1.12. How to select the protocol for rear communication

When the relay is provided with a communication module for the built-in communication protocols, it allows you to choose the communication protocol for the rear connection. If the relay is equipped with a protocol-specific communication module, no communication protocol selections are allowed. The protocol is then defined by the communication module.

The selected protocol is stored in the non-volatile memory and is therefore activated automatically after an interruption in the auxiliary voltage.

Select the rear communication protocol as follows:

Operator's Manual

1. Press an arrow button to access the main menu.
2. Use the arrow buttons to select CONFIGURATION\ COMMUNICATION\ REAR PROTOCOL and press . The cursor is at the setting currently in use (for example SPA).
3. Press to enter the setting mode. The second line starts to flash.
4. Use or to select the wanted setting.
5. Press to confirm the selection.
6. Press to return the display to the idle mode.

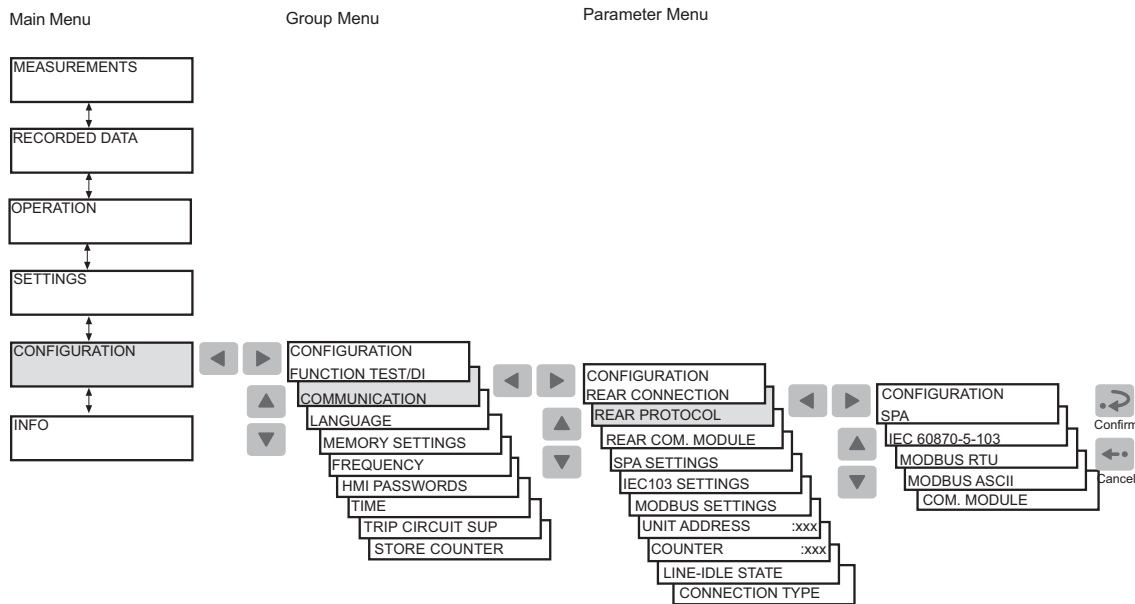

A040244_2

Fig. 4.1.12.-1 Selecting the communication protocol for the rear connection

4.2. HMI operation levels

The HMI menu consists of a user level and a technical level. The user level is used for measuring and monitoring. The technical level is used for advanced protection relay setting and can be configured to require a password. The password is required after the default value 999 is replaced.

4.2.1. User level

4.2.1.1. Menu groups of the user level

The user level contains the following menu groups. You can monitor the data without a password.

- MEASUREMENTS
 - Monitored measured values
- RECORDED DATA





Operator's Manual

- Stored event values from the protection functions
- Registered number of starts of protection functions
- Continuously updated registers of actual values from protection functions
- OPERATION
 - Resetting of trip lockout
- INFO
 - Information on the relay, such as device type and relay serial number

4.2.1.2.**How to monitor measured values**

You can monitor all measured values via MEASUREMENTS in the HMI menu. In addition, the measured current values on phases L1, L2 and L3 and the measured value of I_0 can also be monitored by activating the monitoring state.

To access the measured values on phases L1, L2 and L3 and the measured value of I_0 , ΔI and θ via the HMI menu:

1. Press an arrow button to access the main menu.
2. The cursor is at the first menu item, MEASUREMENTS. Press  to see the measured value on phase L1.
3. Use  and  to monitor the measured values on phases L1, L2 and L3 and the measured value of I_0 , ΔI and θ . The phase currents are shown as multiples of the rated current I_n . I_0 is shown as a percentage of the rated current, I_n , while ΔI is shown as a percentage of the highest phase current and θ is shown as a percentage of the thermal trip level. Press  once more to see the corresponding primary current value for L1, L2, L3 and I_0 current value for I_a , I_b , I_c and I_n . If the conversion factors are set to zero, dashes "- - -" are displayed instead.
4. Use the arrow buttons to monitor other measured values in the menu DEMAND VALUES; see Fig. 4.2.1.2.-1.
5. Press  to return the display to the idle mode.

Operator's Manual

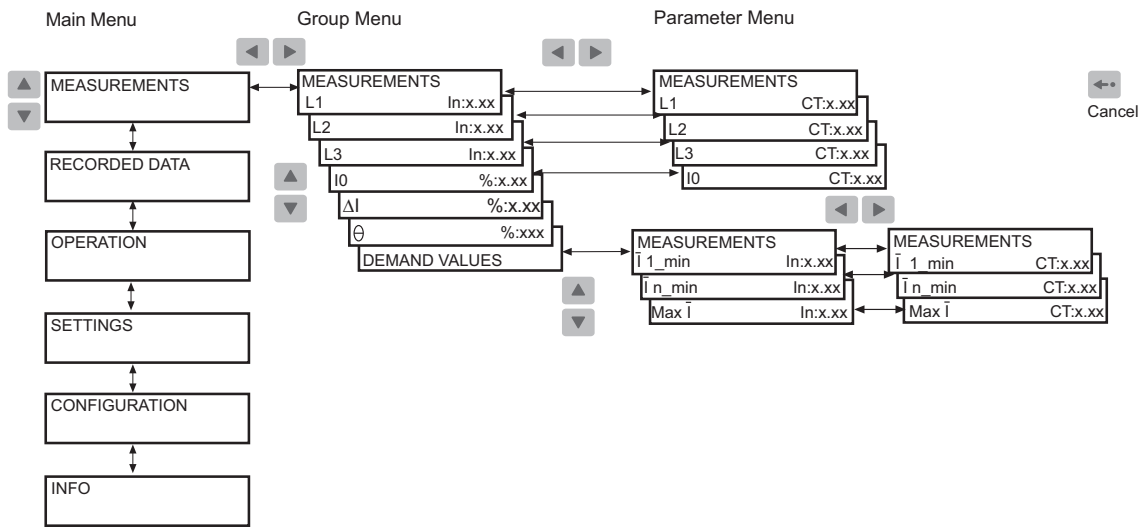

A040246_2

Fig. 4.2.1.2.-1 Monitoring measurements

To access the primary current values by activating the monitoring state:

1. Press and simultaneously to view the primary line currents on phases L1, L2 and L3 and the earth-fault current, I₀.
2. Press to return the display to the idle mode.

The display has to be in the idle mode to be able to activate the monitoring state. The display is not returned to the idle mode automatically as the monitoring state does not have a time out. In case a fault is detected, however, the fault indication displaces the monitoring state.

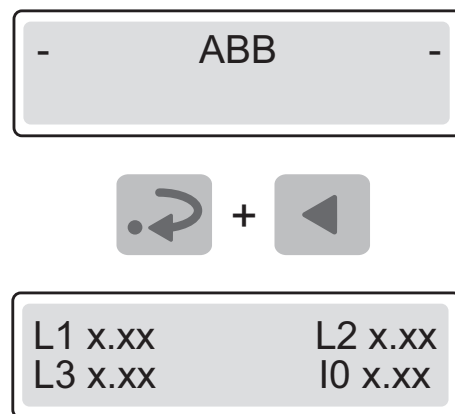

A040248

Fig. 4.2.1.2.-2 Activating the monitoring state



Before you can monitor the correct primary current values, the parameters M80 and M83 must be correctly set via serial communication.

4.2.1.3. How to monitor recorded data

The contents of the event register and the information on number of auto-reclosures initiated, starts and trips are found under the main menu group RECORDED DATA.

1. Press an arrow button to access the main menu.
2. Use ▲ or ▼ to select RECORDED DATA in the main menu and press ▶ to enter the first event.
3. To navigate between the events, use ▲ and ▼.
4. To enter a submenu, use ▶ and to exit, use ◀.
5. To return the display to the idle mode, press ◀◀.

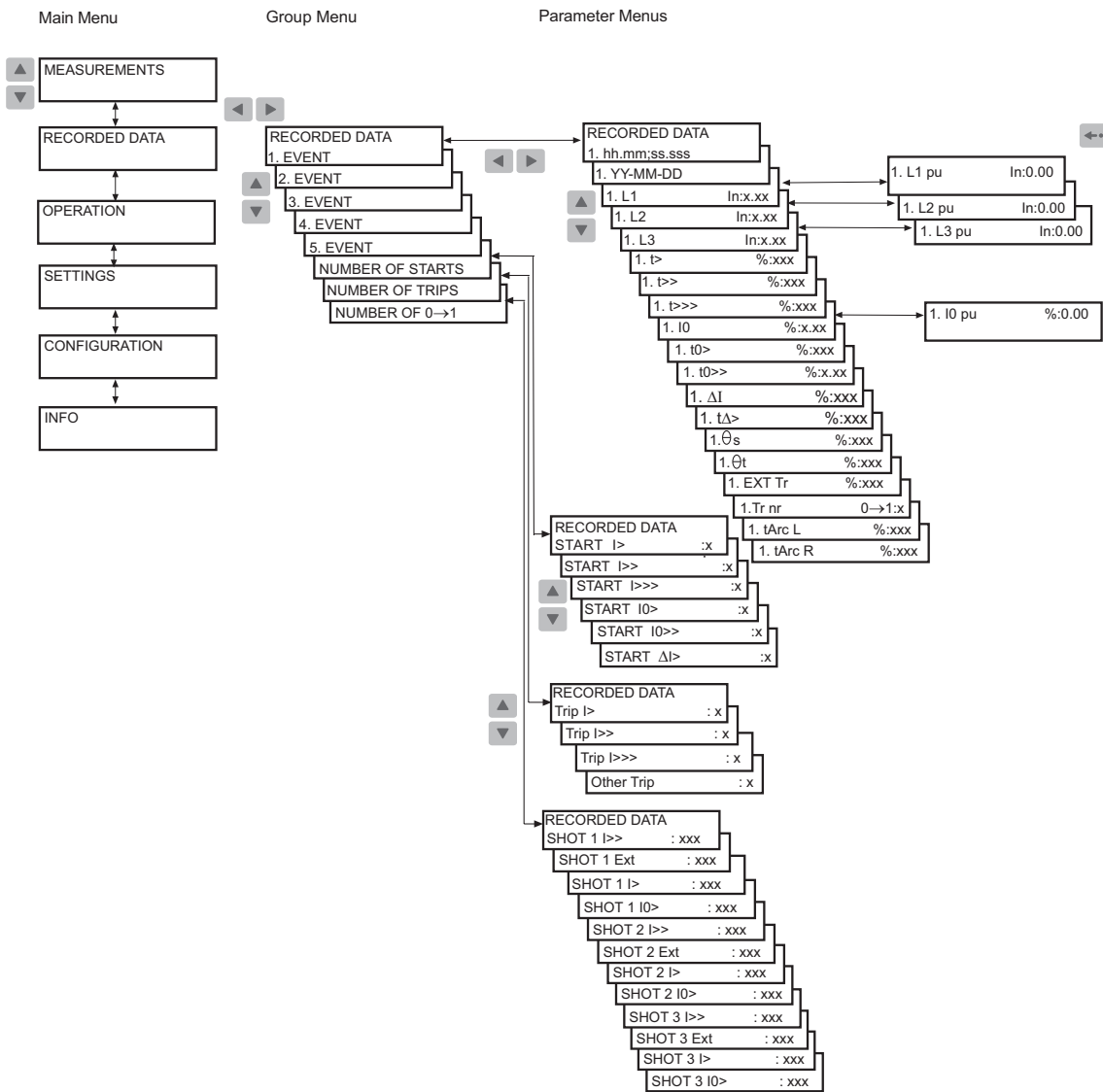

Fig. 4.2.1.3.-1 Monitoring recorded data

A040249

4.2.1.4. INFO menu group

The main menu group INFO contains information which you may need when ordering repair service.

1. Press an arrow button to access the main menu.
2. Use the arrow buttons to select INFO and press **▶** to enter the first submenu. The first submenu shows the device type, relay serial number, test date, the CPU module as well as the optional DNP 3.0 communication module.
3. For specific information on the CPU module, use **▼** to select CPU MODULE and press **▶** to view the CPU software number and revision. While in the CPU software number and revision view, press **▶** to view the CPU build number or **▼** to view the CPU serial number.
4. Use the arrow buttons to monitor the corresponding information on the optional DNP 3.0 communication module.

While in the DNP serial number view, press **▼** to view the DNP protocol name.

5. To return the display to the idle mode, press **←→**.

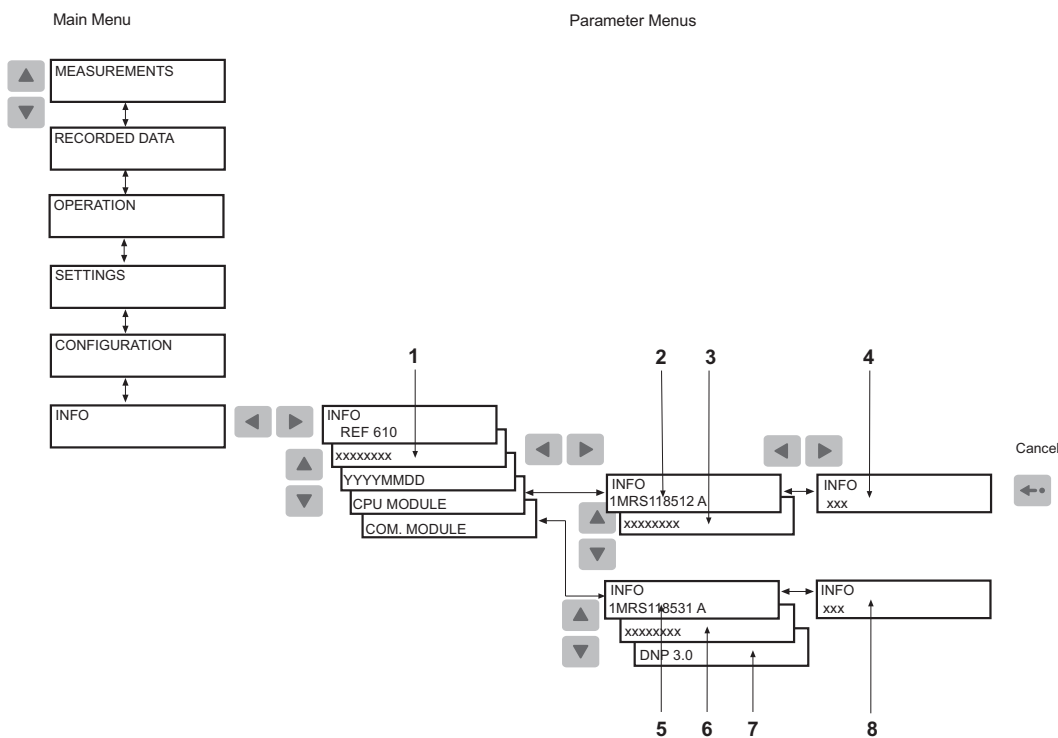

Fig. 4.2.1.4.-1 INFO menu group

- 1) Relay serial number
- 2) CPU module software number and revision
- 3) CPU module serial number
- 4) CPU module software build number
- 5) Communication module software number and revision
- 6) Communication module serial number
- 7) Communication module protocol name
- 8) Communication module software build number

4.2.2. Technical level

4.2.2.1. Menu system of parameters

Press an arrow button to activate the main menu. If the default password is in use, no password is required to change the parameters. If the password protection is in use, "***" is shown on the display until you give the valid HMI password.

The views are used for reading and setting parameters, which are divided into two main groups:

- SETTINGS
- CONFIGURATION

4.2.2.2. How to change settings

The actual settings consist of the settings of group 1 or group 2, depending on which group has been selected to be active (indicated by an asterisk "*"). The actual settings can be seen in the first parameter menu, for example:

```
SETTINGS\ PROTECT. STAGES\ Is> In:x.xx
```

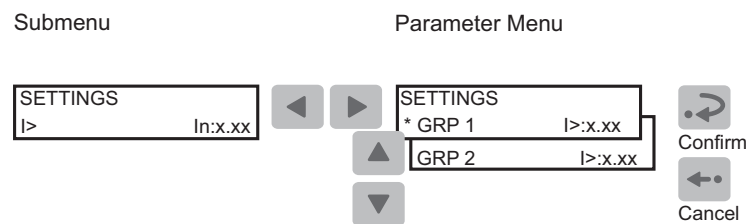

A040253

Fig. 4.2.2.2.-1 Setting parameters in setting group 1 and setting group 2

By switching between setting groups 1 and 2, you can activate a whole group of settings at the same time. Switch between the setting groups as follows:

- With the parameter GROUP 1/GROUP 2 under the main menu group SETTINGS.
- With a digital input signal, provided that SGB1...5/4 has been set to 1 in both setting groups (GRP1 and GRP2).
- With parameter V150 via the SPA bus.



When a large number of settings is to be altered, for example during the commissioning of the relay systems, use a PC equipped with the necessary software.

If no PC is available, or when only a few settings are to be altered:

Operator's Manual

1. Press an arrow button to access the main menu.
2. Use the arrow buttons to select the main menu group `SETTINGS` and the wanted group menu (for example `PROTECT . STAGES`), and press `▶`.
3. Use `▲` or `▼` to select the parameter to be changed and press `▶`.
4. Use `▲` or `▼` to select setting group 1 or 2 (`GRP1` or `GRP2`). The active setting group is indicated by an asterisk "*" .
5. Enter the setting mode by pressing `↵` and give the password if required. If the default password 999 is still valid, no password is required.
6. The first digit of the setting value of the parameter to be edited starts to flash. Use `◀` and `▶` to move the cursor and `▲` and `▼` to increase or decrease the number.
7. To store a new value and return the display to the view mode, press `↵`. If the parameter is of a numerical kind, the display confirms the storage by flashing "- -" once on the display.
8. To exit the setting mode without storing the changes, press `↵` once before confirming and the display returns to the view mode.
9. Press `↵` to return the display to the idle mode.

Operator's Manual

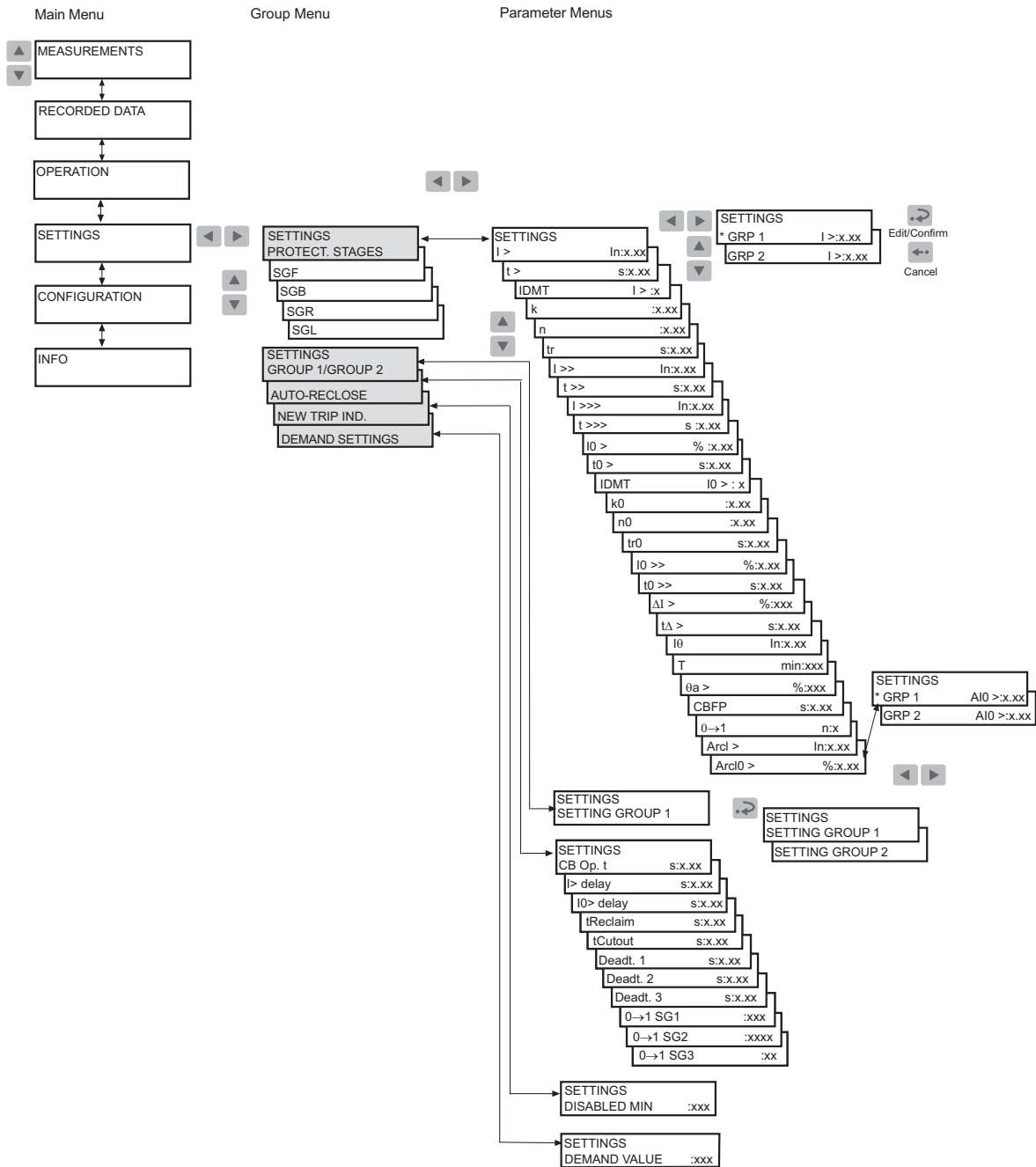

Fig. 4.2.2.2.-2 SETTINGS menu

A040255

Switchgroups

The relay contains the following switchgroups:

SGF1	Output contacts
SGF2	Display settings
SGF3, SGF4	Protection functions
SGF5	Latching feature for programmable LEDs
SGB1...SGB5	Digital inputs (DI1...DI5)
SGR1...SGR8	Output contacts (PO1, PO2, PO3, SO1, SO2, SO3, SO4, SO5)
SGL1...SGL8	Programmable LEDs

To set functions via switchgroups:

1. Press an arrow button to access the main menu.
2. Use the arrow buttons to select the main menu group `SETTINGS` and the wanted switchgroup menu (for example `SGF`), and press `▶`.
3. Use `▲` or `▼` to select the wanted switchgroup (for example `SGF2` for display settings) and press `▶`.
4. Use `▲` or `▼` to select setting group 1 or 2 (`GRP1` or `GRP2`). The active setting group is indicated by an asterisk `"*"`.
5. Press `↵` to enter the setting mode and give the password if required.
6. Use `◀` or `▶` to select the bit to be set, and `▲` or `▼` to select the wanted bit state, see Fig. 4.2.2.2.-4.
7. Press `↵` to confirm the selection. After confirmation, the display returns to the view mode and shows the checksum of the switchgroup.
8. Press `←` to return the display to the idle mode.

Operator's Manual

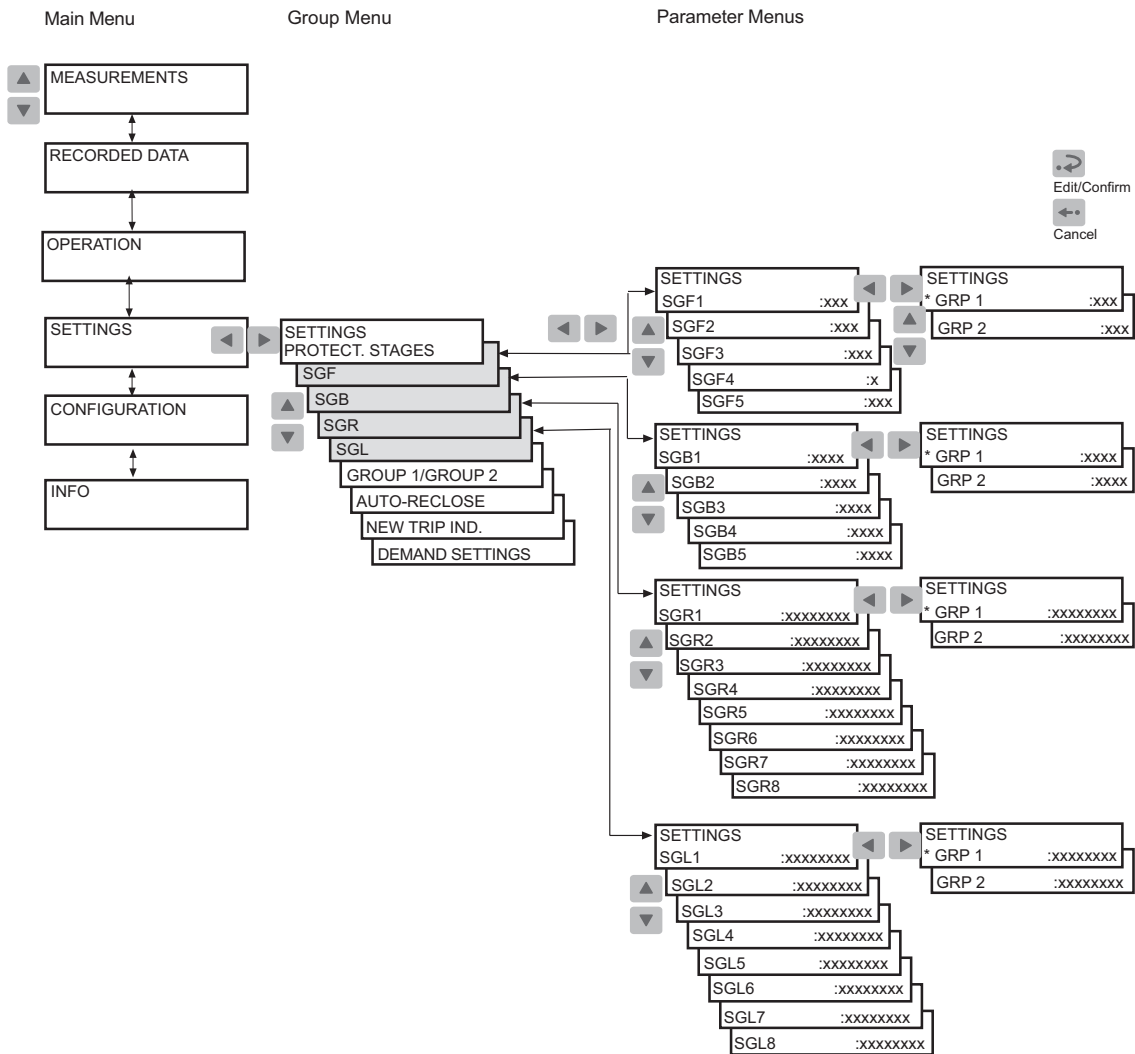

A040257

Fig. 4.2.2.2.-3 Settings for switchgroups

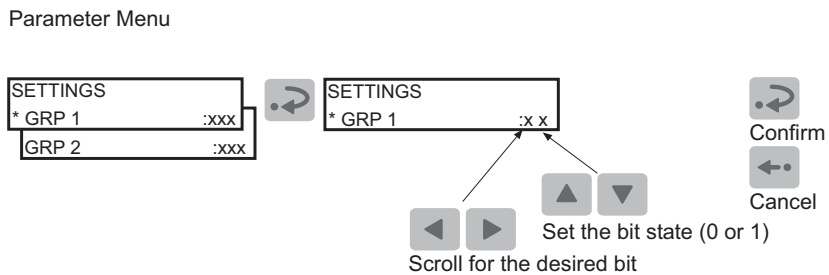

A040259











Fig. 4.2.2.2.-4 Setting bits

4.2.2.3. Configuration

In general, the parameters found under CONFIGURATION are set only once by the customer, that is, prior to commissioning of the relay.

Operator's Manual

To change a parameter:

1. Press an arrow button to access the main menu.
2. Use the arrow buttons to select the main menu group CONFIGURATION and the wanted group menu, and press .
3. Use  or  to select the wanted parameter (for example UNIT ADDRESS : xxx) or a set of parameters (for example SPA SETTINGS). In case of a set of parameters, use arrow buttons until you reach the wanted parameter.
4. Press  to enter the setting mode and give the password if required.
5. The parameter text (enumerator) or the first digit of the parameter setting value starts to flash. Set the enumerator or the digit/character by using  and . Activate the next digit/character to be set by pressing  or . When setting an enumerator, however, the left and right arrows have no function.
6. To store a new value and return the display to the view mode, press . If the parameter is of numerical kind, the display confirms the storage by flashing "--" once on the display.
7. To exit the setting mode without storing the changes, press  once before confirming and the display returns to the view mode.
8. Press  once more to return the display to the idle mode.



If a setting value outside the allowed limits is confirmed in the setting mode, the former value is restored.

Operator's Manual

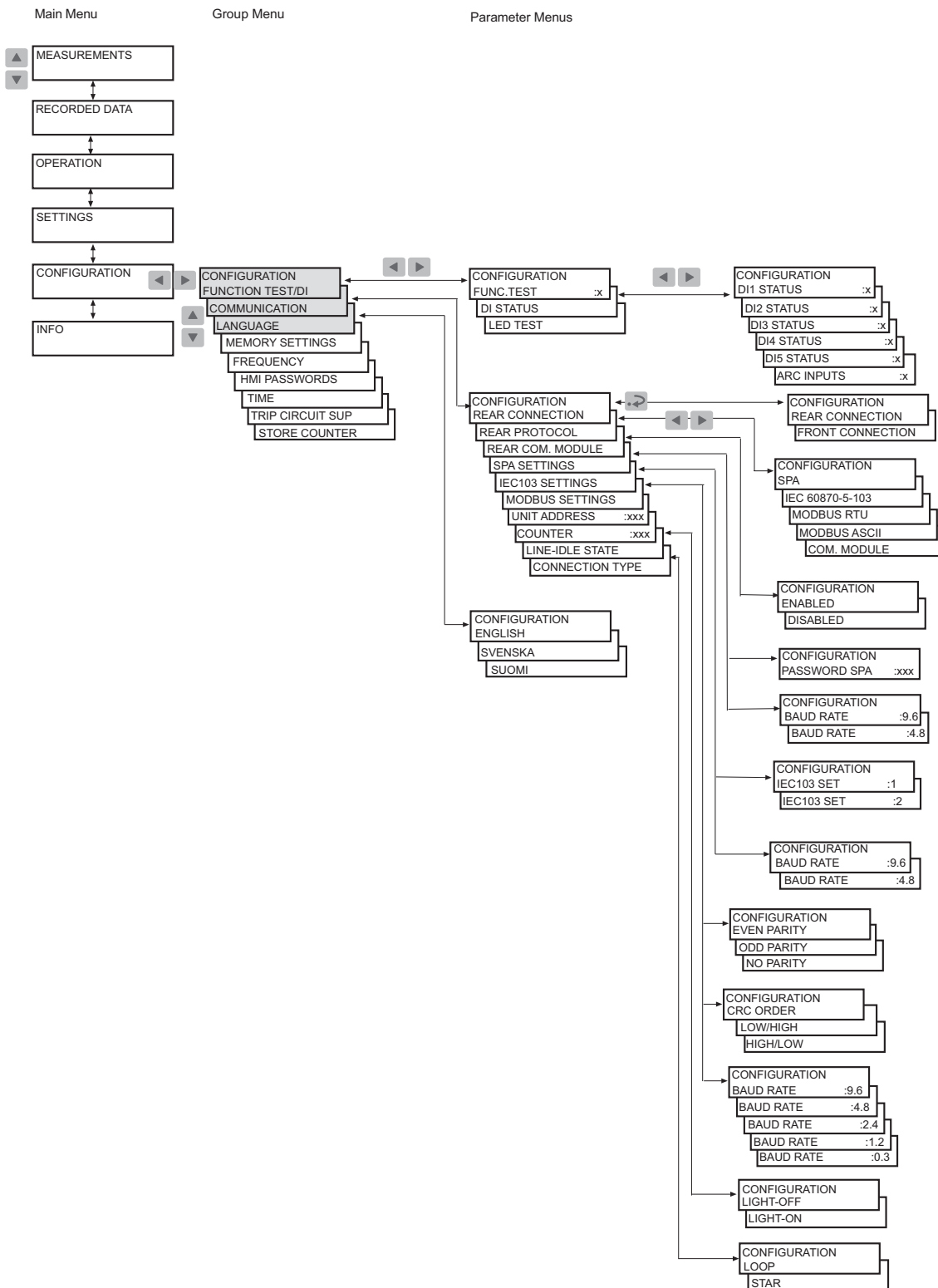

A040260_2

Fig. 4.2.2.3.-1 CONFIGURATION menu, part 1

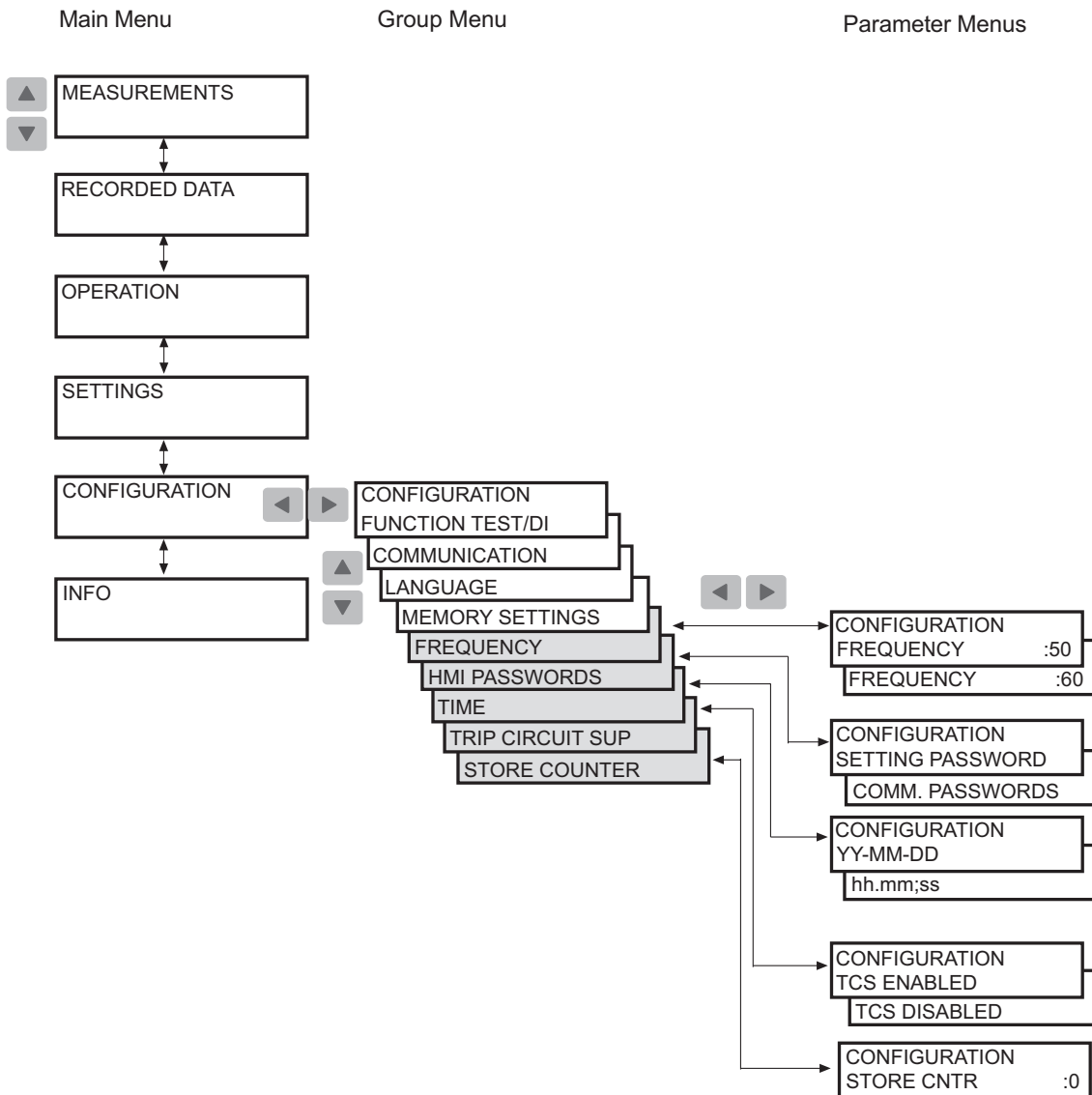

A040262_2

Fig. 4.2.2.3.-2 CONFIGURATION menu, part 2

4.2.2.4.

How to acknowledge and reset indications, output contacts and memorized values

- To clear the LEDs and the display, press **←→**. The LEDs and the display are cleared only if the fault has disappeared.
- To unlatch the output contacts, press **←←** for at least five seconds. Note that the LEDs and the display have to be cleared before this.
- Press **←←** and **→→** simultaneously for at least half a second to perform a master reset, that is, to clear indications and memorized values and to unlatch the output contacts. The display being inverted confirms this action. Memorized values include recorded data, disturbance recorder data and average values (demand values).

4.3. Protection relay indications

The operation of the relay can be monitored by means of three different HMI indications:

- Three indicator LEDs with fixed functionality:
 - Ready
 - Start/Alarm
 - Trip
- Eight programmable indicator LEDs
- Text message on the display

The protection functions are not affected by fault indications.

4.3.1. Indicator LEDs

When a protection stage starts or generates an alarm, the yellow indicator LED is lit.

When a protection stage trips, the yellow indicator LED remains lit and the red indicator LED is lit.

When a starting protection stage is blocked, the yellow indicator LED starts to flash. The yellow indicator LED is also lit to indicate an alarm from a protection stage.

4.3.1.1. Green indicator LED



A040264

Fig. 4.3.1.1.-1 Green indicator LED

Two different functions are embedded in the green indicator LED: power on and internal relay fault (IRF).

- Indicator off:

The auxiliary voltage is not connected.

- Lit indicator:

The relay is in operation. However, a less severe fault (warning) may have occurred. Refer to Section 4.3.2.3. Self-supervision.

- Flashing indicator:

An internal relay fault requiring repair by an authorized service supplier has occurred. Refer to Section 4.3.2.3. Self-supervision.

4.3.1.2.

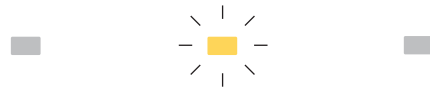
Yellow indicator LED

A040266

Fig. 4.3.1.2.-1 Yellow indicator LED

- Indicator off:
No protection stage has started and there are no thermal alarms.
- Lit indicator:
A protection stage has started or generated an alarm. The start and alarm indication can be selected to be either latching or non-latching with the SGF switches. A non-latching indication is automatically cleared when the fault has disappeared and the protection stage has been reset, whereas a latching indication remains lit until manually cleared.
- Flashing indicator:
Starting protection stages have been blocked by an external digital input signal. The blocking indication is non-latching, that is, it disappears with the digital input signal.

The yellow indicator LED continues flashing for as long as a protection stage remains blocked. The blocking indication disappears with the digital input signal or when the protection stage is no longer starting.

If a protection stage is blocked when other protection stages are starting, the indicator continues flashing. This is because a blocking indication has a higher priority than a starting indication.

4.3.1.3.

Red indicator LED

A040265

Fig. 4.3.1.3.-1 Red indicator LED

- Indicator off:
No protection stage has tripped.
- Lit indicator:
A protection stage has tripped. The trip indication is latching, that is, it remains lit until manually cleared.
- Flashing indicator:
CBFP has tripped. The indication is latching, that is, it remains flashing until manually cleared.

4.3.1.4. Programmable indicator LEDs

In addition to the three fixed LEDs, the relay contains eight LEDs which you can program to indicate the status of different type of relay signals. The programmable LEDs can indicate the following information:

- Trip signals from protection stages
- Alarm signals from protection stages
- Circuit-breaker position
- Status of the auto-reclose function
- Trip lockout
- Light detected by the arc protection
- Status of the digital input signals

Route the signals to the LEDs via switchgroups SGL1...SGL8; to LED1 with the switches of switchgroup SGL1, to LED2 with those of SGL2, and so forth.

For detailed information on the signals, refer to the Technical Reference Manual.

The LEDs are non-latching by default but you can also set them to operate as latching via switchgroup SGF5.

For instructions on setting the switchgroups, refer to Section 4.2.2.2. How to change settings.

4.3.2. Indication messages

The messages give an overview of protection operations and internal relay faults.

4.3.2.1. Operation indication messages

When a protection stage starts, the text `START` appears on the display along with the name of the function. Additionally, in case of a latching start indication, the name of the energizing input(s) which caused the fault are displayed (except for the thermal protection and phase discontinuity protection). The yellow indicator LED is lit.

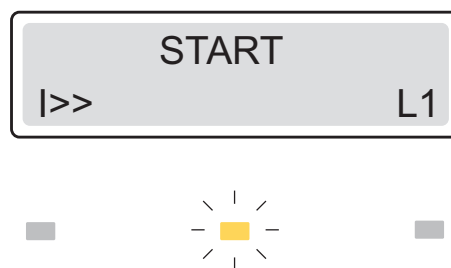
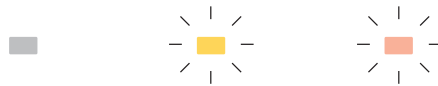

Fig. 4.3.2.1.-1 Latching start indication

A040268

When a protection stage trips, the text TRIP appears on the display along with the name of the function. Additionally, the name of the energizing input(s) which caused the fault are displayed (except for the thermal protection and phase discontinuity protection). The red indicator is lit.



A040270

Fig. 4.3.2.1.-2 Trip indication

In case of an alarm from the thermal overload protection, the text ALARM appears on the display along with the function symbol and the yellow indicator LED is lit.



A040272

Fig. 4.3.2.1.-3 Alarm indication

If the auto-reclose function has generated the definite trip alarm signal, the text DEF. TRIP ALARM will appear on the display to indicate that the CB has been left in the open position and that no more auto-reclosures are being generated.

If a start or trip indication for the stage that initiated an ongoing auto-reclose shot is cleared, the text Shot Due appears on the display to indicate that a shot is ongoing and that the CB will be closed after expiration of the dead time.

In case the CB reclosing failed or it is inhibited, this is indicated on the display with the text RECLOSING FAILED.

If the auto-reclose function has generated the lockout signal, the text LOCKOUT will appear on the display to indicate that the whole auto-reclose function is temporarily inhibited.

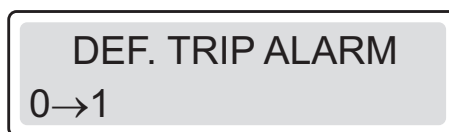

A040277

Fig. 4.3.2.1.-4 Definite Trip-alarm indication

Latching and non-latching indications

A latching operation indication message remains on the display until manually cleared or until replaced by a message of higher priority. However, if the fault is stable and has not disappeared, the operation indication message and the LED(s) are not cleared. An operation indication generated by a non-latching start is automatically cleared when the stage is reset.

Priority of operation indication messages

The messages on the display have a certain priority order. If different types of indications are activated simultaneously, the message with the highest priority appears on the display.

The priority order of the messages:

1. CBFP/Trip from Arc protection
2. CB Reclosing Failed
3. Trip/Definite Trip Alarm
4. Start/Alarm/Shot Due/AR Lockout

When several protection stages generate starts, the last start indication message is displayed. When several protection stages trip, the first trip indication message is displayed until the time, as specified by the `NEW TRIP IND.` setting value, has expired. After this, a new trip indication message can replace the old one. A hidden trip indication message can be brought forward by pressing .

4.3.2.2.

Disturbance recorder indication

When the display is in the idle mode, an asterisk "*" indicating that the disturbance recorder has been triggered and is ready to be unloaded, is shown in the lower right-hand corner of the display. Disturbance recorder status indication can also be routed to the programmable LEDs.

4.3.2.3.

Self-supervision

There are two types of fault indications; internal relay fault (IRF) indications and warnings. Internal relay faults prevent relay operation. Warnings are less severe faults and continued relay operation with full or reduced functionality is allowed.

Internal relay fault (IRF)

At permanent internal relay faults, the relay is no longer protecting and has to be sent for repair at an authorized service supplier. When the self-supervision system detects a permanent internal relay fault, the green indicator LED starts to flash. The text `INTERNAL FAULT` and a fault code appear on the display.



State the fault code when sending the relay for service.

As long as the green indicator LED (ready) is flashing, the fault indication cannot be cleared. In case an internal fault disappears, the green indicator LED stops flashing and the relay is returned to the normal service state, but the fault indication message remains on the display until manually cleared.



A040278

Fig. 4.3.2.3.-1 Permanent IRF

The fault code is a number which identifies the fault type. The fault codes are listed in the table below:

Table 4.3.2.3.-1 IRF codes

Fault code	Type of fault
4	Error in output relay PO1
5	Error in output relay PO2
6	Error in output relay PO3
7	Error in output relay SO1
8	Error in output relay SO2
9	Error in the enable signal for output relay PO1, PO2, SO1 or SO2
10, 11, 12	Error in the feedback, enable signal or output relay PO1, PO2, SO1 or SO2
13	Error in optional output relay SO3
14	Error in optional output relay SO4
15	Error in optional output relay SO5
16	Error in the enable signal for optional output relay SO3, SO4 or SO5
17, 18, 19	Error in the feedback, enable signal or optional output relay SO3, SO4 or SO5
20, 21	Auxiliary voltage dip
30	Faulty program memory
50, 59	Faulty work memory
51, 52, 53 ^{a)} , 54, 56	Faulty parameter memory ^{b)}
55	Faulty parameter memory, calibration parameters
80	Optional I/O module missing
81	Optional I/O module unknown
82	Optional I/O module configuration error
85	Power supply module faulty
86	Power supply module unknown
90	Hardware configuration error
95	Communication module unknown
104	Faulty configuration set (for IEC 60870-5-103)

Table 4.3.2.3.-1 IRF codes (Continued)

Fault code	Type of fault
131, 139, 195, 203, 222, 223	Internal reference voltage error
240	Faulty input, Light sensor 2
241	Faulty input, Light sensor 1
253	Error in the measuring unit

a) Can be corrected by restoring factory settings for CPU.
 b) All settings will be zero during the fault.

Warning

In case of a less severe fault (warning), the relay continues to operate except for those protection functions possibly affected by the fault. At this type of fault, the green indicator LED remains lit as during normal operation, but the text WARNING with a fault code or a text message indicating the fault type replaces the name of the feeder on the display in the idle mode. Some of these faults can be corrected by a relay operator at site. After the fault has disappeared or been corrected, the message is automatically cleared.



A040279

Fig. 4.3.2.3.-2 Warning with text message

If more than one type of fault occur at the same time, one single numeric code which indicates all the faults is displayed. For instance, the code 33 implies two faults: the battery is low and the DNP 3.0 module is faulty. The fault code is composed of the weighting factors assigned to each fault type as follows: 1 + 32; see Table 4.3.2.3.-2

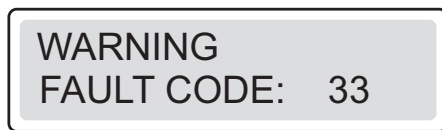

A040280

Fig. 4.3.2.3.-3 Warning with numeric code

Table 4.3.2.3.-2 Warning codes

Fault	Weight value	Description
Battery low	1	Battery voltage level low <ul style="list-style-type: none"> Battery should be replaced If the relay is used without battery, this warning can be disabled by setting non-volatile memory settings to 0 In case only this warning is active, it is displayed in text format (BATTERY LOW)
Trip-circuit supervision ^{a)}	2	Error in trip circuit <ul style="list-style-type: none"> Check the trip circuit for broken conductors and correct Warning is not displayed if trip-circuit supervision (TCS) has been disabled
Power supply module temperature high	4	Temperature inside relay is too high <ul style="list-style-type: none"> Check that ambient temperature is within service temperature range
Communication module faulty or missing	8	Communication module faulty or not installed <ul style="list-style-type: none"> Check that plug-in unit is properly attached to relay case Check that communication module is installed Warning is not displayed if rear communication module has been disabled In case only this warning is active, it is displayed in text format (Comm.card faulty)
DNP 3.0 configuration error	16	DNP 3.0 configuration error <ul style="list-style-type: none"> DNP 3.0 parameters should be formatted and re-configured
DNP 3.0 module faulty	32	Faulty memory in DNP 3.0 card or communication lost between DNP 3.0 card and relay <ul style="list-style-type: none"> The DNP 3.0 card or plug-in unit requires service
Continuous light detected by Light sensor 1 or 2 ^{a)}	64	Sensor detected continuous light <ul style="list-style-type: none"> Check sensors and fibres Check that there are no light sources that could interfere the sensors (for example door of the switch gear is open)
Checksum:	127	

^{a)} The external fault warning can be routed to SO2 with SGF1/8.

4.4. Detachable plug-in unit

4.4.1. Identifying the product

You can find the order number on a label under the lower handle of the relay.



When checking the order number of the relay plug-in unit, be careful not to lift the handle more than 25° (approx. 40 mm). Lifting the handle any further detaches the plug-in unit from the case.

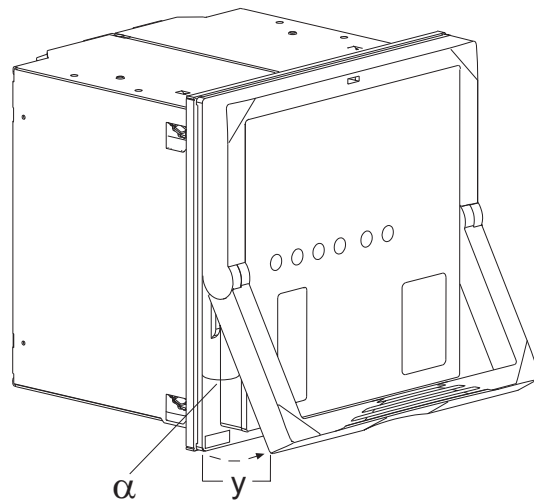

Fig. 4.4.1.-1 Checking the order number of the relay

$$\alpha = 25^\circ$$

$$y = 40 \text{ mm}$$

A040165

4.4.2.

Detaching and installing the plug-in unit



Before detaching the plug-in unit from the case, the auxiliary voltage must be disconnected.

To detach the plug-in unit:

1. Lift the lower handle until the spring-loaded locks on both sides of the handle are released and the unit is pushed about 6 mm out of the case. This separates the connectors.
2. Pull the unit out of the case.

The relay features an automatic short-circuit mechanism in the current transformer (CT) connector. Therefore, detaching the plug-in unit will not open the secondary circuit of the CT which otherwise could cause dangerously high voltages.

Signal connectors are left open when the plug-in unit is detached.

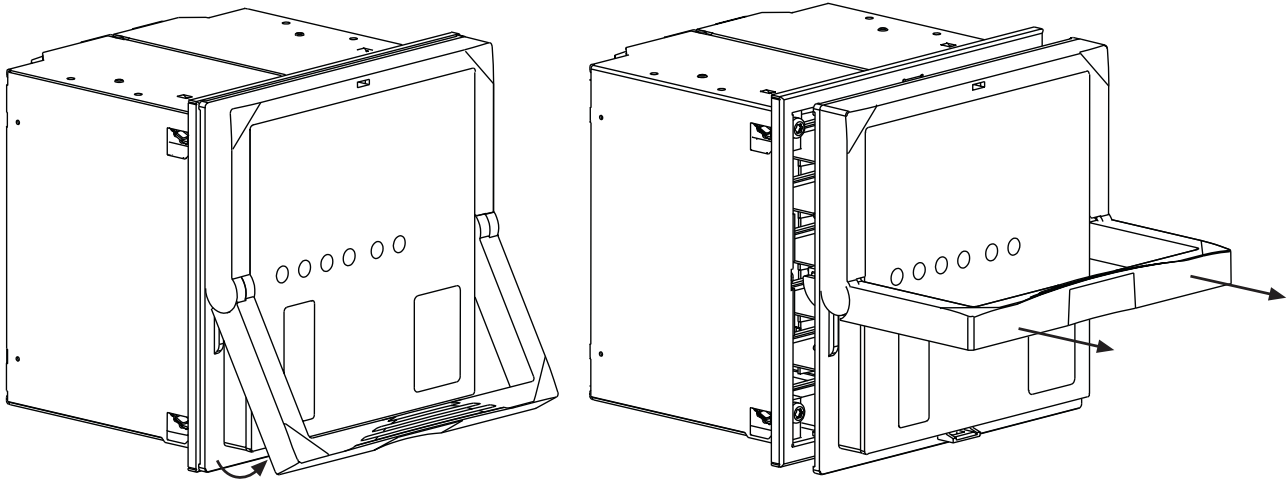

A040166

Fig. 4.4.2.-1 Detaching a plug-in unit from the case



Before fitting a relay plug-in unit into a relay case, check that the unit and the case have the same order number.

The order number of the case is printed on the bottom plate inside the case. However, if a substitute plug-in unit has to be used instead of the original unit, ensure that at least the first 10 characters in the order numbers of the case and the plug-in unit are identical, as in the following example:

Order number of the relay case	REF610C55HCHP XX
Order number of the plug-in unit	REF610C55HCNR XX

However, it is highly recommended that all characters in the order number of the substitute plug-in unit, except for those indicating a spare part, should match the ones of the case. Otherwise, it may result in loss of significant functionality in the application.

The relay features a built-in mechanical coding system which allows that a plug-in unit with voltage or current measuring inputs only can be plugged into a corresponding case. This helps to prevent dangerous situations from arising in case a non-suitable plug-in unit is fitted into a relay case.



Forcing a non-suitable plug-in unit into a case breaks the relay and may cause dangerous situations.

When installing a plug-in unit into a case:

1. Check that the handle is down in its initial position.
2. Push the unit into the case until the locks click; see Fig. 4.4.2.-2.

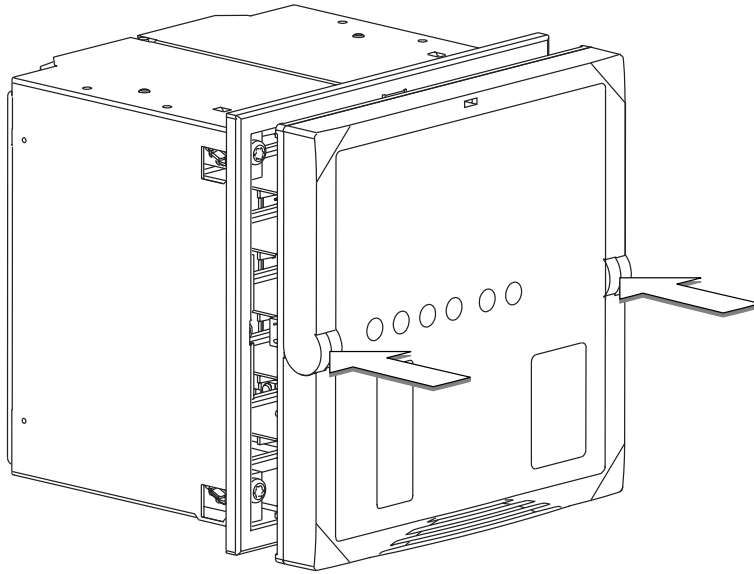

A040167

Fig. 4.4.2.-2 Installing a plug-in unit into the case

4.4.3.

Inserting and changing the battery



The battery may only be inserted and changed by trained service personnel.

To insert or change the battery, first detach the plug-in unit; refer to Section 4.4.2. Detaching and installing the plug-in unit.

The battery compartment is accessible from underneath the plug-in unit as shown in Fig. 4.4.3.-1.

1. Gently remove the battery with, for example, a flat-ended screwdriver. Be careful not to drop the battery inside the plug-in unit.
2. Insert a new battery under the battery holder and ensure that you install the battery with the correct polarity to avoid damage to the equipment.
3. Dispose the removed battery according to local environmental regulations on the disposal of lithium batteries.

The battery is not being charged during normal operation.

When the relay is taken out of service, the battery should be removed to avoid discharge. Typical battery discharge time is 14 days.

Operator's Manual

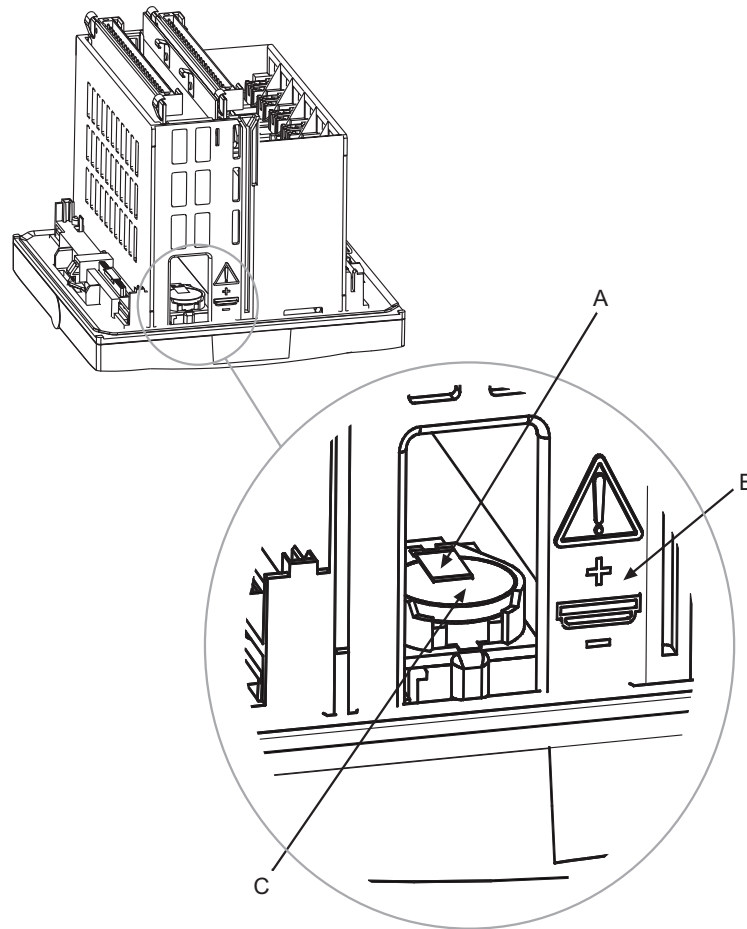

A040282_2

Fig. 4.4.3.-1 Inserting and changing the battery

- A) Battery holder
- B) Note! Polarity
- C) Battery

5. Commissioning and maintenance



The relay should be subject to regular tests and maintenance in accordance with national regulations and instructions.

Prior to commissioning, the functionality of the application-specific relay configuration and settings have to be tested.

During relay commissioning, the operation of short-circuit and earth-fault protection is to be tested by using secondary injection testing to secure personal safety. Additionally, correct operation of input and output signals to and from the relay should be verified.

The relay is a numerical protection relay with functionality implemented in the relay software configuration. Software functionality does not change over time and the relay performs extensive self-supervision during operation. Therefore, it is not necessary to perform extensive relay testing during periodic maintenance.

When the protection relay is operating under the specified conditions (refer to the Technical Reference Manual), the manufacturer recommends preventive maintenance to be performed every five years. This periodically performed preventive maintenance is to be carried out to secure correct and safe operation of the relay. When performing preventive maintenance, the correct functionality of the relay is to be verified as well as the wiring circuitry to and from the relay.



If the environmental conditions at the relay operating site differ from those specified, for instance temperature and humidity, or if the atmosphere around the relay contains chemically active gases or dust, the relay ought to be visually inspected.

At the visual inspection, the following should be observed:

- Signs of mechanical damage on the relay, contacts and relay case.
- Rust spots or signs of corrosion on the terminals or case.



Do not open the secondary circuit of a current transformer during any phase of the testing when the primary circuit is live. The high voltage generated by an open CT secondary circuit may be lethal and damage instruments and insulation.

5.1. Commissioning instructions

Relay commissioning is carried out to confirm correct operation of the relay when it is taken into use.



Polarity checking of phase current transformers (CTs) should be performed to confirm that the wiring circuitry between the CTs and the relay is correct, which is a prerequisite for the protection functions in the relay to operate correctly. The circuit breaker tripping circuit, interlocking and signaling wiring should also be tested.

When commissioning the relay, secondary injection testing is performed to secure personal safety in case of short circuits or earth faults in the system. If wanted, secondary injection testing can also be used for more elaborate testing of the relay's functionality.

Relay commissioning contains:

1. Verifying that the correct application-specific settings have been entered into the relay. This is done by reading the relay settings either via the HMI or serial communication and comparing these to the calculated application-specific settings. If read via serial communication, the settings can be stored as a commissioning setting record file.
2. Verifying the current measurements – refer to Section 5.3. Measurements verification
3. Testing of signal routing to output contacts – refer to Section 5.4. Function test
4. Testing of digital input signals availability – refer to Section 5.5. Digital input test
5. Testing of the optional arc detection - refer to Section
6. Testing of short-circuit protection – refer to Section 5.7.1. Testing of the short-circuit protection
7. Testing of earth-fault protection – refer to Section 5.7.2. Testing of the earth-fault protection

5.2.

Maintenance instructions

Relay preventive maintenance includes verification of the relay operation and changing the possibly worn parts. The verification is carried out to ensure that the relay hardware operates correctly, that is, as it did when first commissioned.

When performing periodic preventive maintenance, the whole circuit breaker tripping circuit should also be tested, if possible. This can easily be done with the plug-in unit removed from the relay case, as the terminals for output contacts in the relay case are left open in such a situation.



When the plug-in unit is removed from the case, internals of the case must not be touched. Relay case internals may have high voltage potential and touching these may cause personal injury.

5.2.1. Relay verification

The relay maintenance verification contains:

1. Verifying measurements – can be performed according to the instructions in Section 5.3. Measurements verification.
2. Verifying output contacts operation – can be performed according to the instructions in Section 5.4. Function test.



The circuit breaker tripping circuit should be disconnected from the relay during this verification, in order to avoid unwanted operation in the system. Interlocking signals should also be disconnected from the relay during the verification in order to avoid dangerous situations from occurring in the system.

3. Verifying digital inputs operation – can be performed according to the instructions in Section 5.5. Digital input test.
4. If there is a reason to believe that the optical fiber or the lens sensor for the arc protection may have been damaged, for example due to heavy arcing inside the switch gear cubicle, correct operation of the arc detection can be verified according to the instructions in section Arc detection test.

5.2.2. Preventive parts replacement

When being used for real-time clock and recorded data functions, the battery should be changed every five years. Refer to Section 4.4.3. Inserting and changing the battery.

5.3. Measurements verification

As most of the protection functions in the protection relay are based on the phase currents and earth-fault current measured by the relay, it is important to verify that the relay is measuring proper values.

This measurements verification can be performed by examining the current readings on the display while injecting a pure sinusoidal current into the current input. If the reading on the display corresponds to the calculated value, taking the relay accuracy and display resolution into account, the relay is measuring proper values.

Rated current for the energizing input that is being verified is shown on the relay label under the lower handle of the relay.

When verifying phase currents measured by the relay, the value to be shown on the display is calculated as follows:

$$\text{Value on LCD } (I_n) = \left(\frac{\text{Injected current}}{\text{energizing input rated current}} \right) \times I_n \quad (1)$$

When verifying the earth-fault current measured by the relay, the value to be shown on the display is calculated as follows:

$$\text{Value on LCD (\%)} = \left(\frac{\text{Injected current}}{\text{energizing input rated current}} \right) \times 100\% \quad (3)$$

5.4. Function test

This section describes how the signal routing from protection functions to, and operation of, the output contacts in the relay can be tested.

The internal signals are routed to the output contacts according to the SGR switch groups.

The test mode is accessible via `FUNCTION TEST/DI` under `CONFIGURATION` in the HMI menu. In the test mode, all internal signals from the different protection stages can be activated one by one, the self-supervision included.

1. Press an arrow button to access the main menu.
2. Use `▲` or `▼` to select `CONFIGURATION` in the main menu and press `▶`. The cursor is at the first menu item, `FUNCTION TEST/DI`. Press `▶` again to enter the test menu.
3. The cursor is at the first parameter, `FUNC . TEST`. Press `↵` to enter the test mode and give the password if required.
4. Select the wanted signal with `◀` or `▶` and press `↵` to activate the signal. The signal remains active for as long as you press `↵`.
5. Repeat the previous step to test other signals.
6. To exit the test mode, press `↵`.
7. Press `↵` again to return the display to the idle mode.

The table below shows the activation order and the corresponding flashing digit when a signal is being tested.

Table 5.4.-1 Function test

Number	Function
1	Start of stage I>
2	Trip of stage I>
3	Start of stage I>>
4	Trip of stage I>>
5	Start of stage I>>>
6	Trip of stage I>>>
7	Start of stage I ₀ >
8	Trip of stage I ₀ >
9	Start of stage I ₀ >>
10	Trip of stage I ₀ >>
11	Start of stage ΔI>
12	Trip of stage ΔI>

Table 5.4.-1 Function test (Continued)

Number	Function
13	Alarm of stage θ >
14	Trip of stage θ >
15	External trip
16	Trip of stage ARC
0	IRF



It is also possible to test the output contacts via serial communication by using the O parameters.

5.5. Digital input test

This section describes how the availability of signals connected to the digital inputs can be tested.

To monitor the status of the digital inputs, navigate in the HMI menu as follows:

1. Press an arrow button to access the main menu.
2. Use or to select CONFIGURATION in the main menu and press . The cursor is at the first menu item, FUNCTION TEST/DI. Press again to enter the test menu.
3. Use or to select DI STATUS and press to see the status of DI1.
4. Use and to monitor the state of the other four digital inputs.
5. Press to return the display to the idle mode.



It is also possible to read the state of the digital inputs via serial communication.

5.6. Arc detection test

This section describes how the connections for the optional external arc detection lens sensor and connection fiber can be tested.

It is recommended that a camera flash with at least guide number 36 and adjustable shutter speed set to at least 1/60 second is used for this test. An alternative light source for the test is a suitable flashlight.

1. Select the programmable LED to indicate detection of light from the arc detection by setting switch 21 to 1 in the SGL for the chosen LED. It is also possible to route the detected light signal to an output relay, that should be set to be latched.
2. Configure the chosen programmable LED to be latched by setting the corresponding switch in SGF5 to 1
3. Position the camera flash at a minimum of 3 meters distance from the lens sensor and flash the light. Alternatively position the flashlight against the lens sensor and light it.
4. The selected programmable LED should become lit if the arc detection is operating properly. If an output relay is used, then the output contacts should be activated.



Ensure that the switch in SGF3 for light signal output L> is set, and that the light signal output L> is configured to be activated immediately upon detection of light, with a switch in SGF4.

5.7.

Testing protection functions

The short-circuit and earth-fault protection functions in the relay can be tested with the setting values used during normal operation. If other settings are used during testing, make sure that the original settings are re-entered after the test is completed.

The test is performed as a secondary test, by injecting current to the current energizing inputs. To enable secondary testing without accidentally blocking other relays or tripping circuit breakers in the system, the relay has to be disconnected.



For the limited current carrying capacity of the wiring, terminals and measuring transformers of the relay, refer to the Technical Reference Manual.

5.7.1.

Testing of the short-circuit protection

If proper 3-phase secondary testing equipment is not available for current generation, the phase unbalance protection function has to be out of operation during the test.

When calculating the current to be injected into the phase current energizing inputs, the calculation should be done on the basis of the following:

- The rated current, 1 A or 5 A, of the relay energizing input to be tested

This gives the current to be injected during the test as follows:

- Injected current (A) = $2.5 \times I_{>>}$ x Rated current of the energizing input

To perform the test, inject the current in all three phase current energizing inputs. The output contacts, to which the trip signal is routed from the short-circuit protection function, should be activated on the expiration of the set operate time of stage $I_{>>}$.

5.7.2.

Testing of the earth-fault protection

When calculating the current to be injected into the earth-fault current energizing input, the calculation should be done on the basis of the following:

- The rated current, 0.2 A, 1 A or 5 A, of the relay energizing input to be tested

This gives the current to be injected during the test as follows:

- Injected current (A) = $2.5 \times I_{0>}$ x Rated current of energizing input

To perform the test, inject the current in the earth-fault current energizing input. The output contacts, to which the trip signal has been routed from the earth-fault protection stage, should be activated on the expiration of the set operate time of stage $I_{0>}$.

6. Spare parts

6.1. Plug-in unit

The relay's construction allows a spare part in form of a plug-in unit. The outage time can therefore be reduced to a minimum in case the relay should fail.

In case of malfunction, please consult your relay supplier.

The spare plug-in unit to be used for a certain relay is suitable if at least the first 10 characters in the order number are identical with those in the order number of the case.



To obtain identical functionality to those of the original product, all characters in the order number, except for those indicating a spare part, should match the ones in the order number of the case.

The relay features a built-in mechanical coding system which allows that a plug-in unit with voltage or current measuring inputs only can be plugged into a corresponding case. This helps to prevent dangerous situations from arising in case a non-suitable plug-in unit is fitted into a relay case.



Forcing a non-suitable plug-in unit into a case breaks the relay and may cause dangerous situations.

The plug-in unit is calibrated as a whole to achieve the best possible operation accuracy and individual pieces of it should not be removed.

If the faulty plug-in unit is subject to guarantee and the fault is caused under circumstances covered by the guarantee conditions, it should be returned for repair.

Ordering of spare parts is done by using the same ordering system as for ordering a new relay.

6.2. Battery

The battery for real-time clock and non-volatile memory can be purchased in stores specialized in electronic components.

Recommended battery manufacturers and types are:

- Panasonic of type BR2032¹⁾
- Rayovac of type BR2032¹⁾

¹⁾ Batteries of the recommended lithium BR-types cannot be recharged.

7. Repair

If the relay fails in operation or if the operating values differ remarkably from the specified values, the relay is to be given a proper service.



All major measures involving overhaul of electronics are to be taken by the manufacturer.

Contact the manufacturer or the nearest representative for further information on checking, service and re-calibration of the relay.



When contacting ABB for ordering repair services, give a description of the fault and state the fault code, if applicable.

8. Ordering information

For ordering information, refer to the Technical Reference Manual.

9. Abbreviations

Abbreviation	Description
AR	Auto reclosure
ASCII	American Standard Code for Information Interchange
CB	Circuit-breaker
CBFP	Circuit-breaker failure protection
CPU	Central processing unit
CT	Current transformer
DI	Digital input
HMI	Human-machine interface
IDMT	Inverse definite minimum time characteristic
IEC	International Electrotechnical Commission
IED	Intelligent electronic device
IRF	Internal relay fault
LCD	Liquid crystal display
LED	Light-emitting diode
PC	Personal computer
PO	Power output, process object
RTU	Remote terminal unit
SGB	Switchgroup for digital inputs
SGF	Switchgroup for functions
SGL	Switchgroup for LEDs
SGR	Switchgroup for output contacts
SO	Signal output
SPA	Data communication protocol developed by ABB
TCS	Trip-circuit supervision



ABB Oy
Distribution Automation
P.O. Box 699
FI-65101 Vaasa
FINLAND
+358 10 2211
+358 10 224 1080
www.abb.com/substationautomation