

PRODUCT CATALOG CANADA

Miniature Circuit Breaker

UL / CSA Range



- UL489 / CSA C22.2 No.5 devices
- UL1077 / CSA C22.2 No. 235 devices
- Electronic Protection Devices
- Technical data

With more than 100 years of product development and knowledge, ABB's miniature circuit breakers are today's market reference for electrical distribution and equipment protection.



Miniature Circuit Breakers

INTRODUCTION, DEFINITIONS
AND EXPLANATIONS

UL489 / CSA C22.2 NO.5
DEVICE SELECTION

UL1077 / CSA C22.2 NO.235
DEVICE SELECTION

ELECTRONIC PROTECTION
DEVICE SELECTION

1

2

3

4



Introduction, Definitions and Explanations

005	Introduction and Definition
006–008	Circuit Breaker Construction
009–010	Current Limitation
011–012	Selective Coordination
013–014	UL489 vs UL1077
015–020	Wiring in DC applications

Miniature circuit breakers

Introduction and definition

The circuit breaker plays an important role in providing overcurrent protection and a disconnect means in electrical networks. Recent advancements in circuit breaker technology has increased breaker performance and protection.

Overload

An overload is a slow and small overcurrent situation that causes the ampacity and temperature of the circuit to gradually increase over time. This type of event is characterized by a slight increase in the load (ampacity) on the circuit and is interrupted by the thermal trip unit of the breaker.

Thermal Example

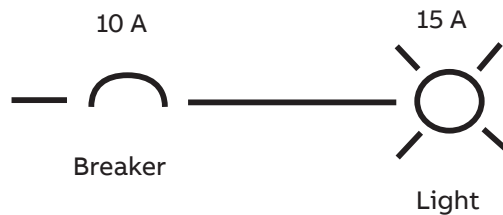

The light draws more than 10 amps for an extended period of time creating a thermal overload.

Short circuit

A short circuit is a rapid and intense overcurrent situation that causes the ampacity of the circuit to increase. This type of event is characterized by a dramatic increase in the load (ampacity) on the circuit and is interrupted by the magnetic trip unit of the breaker.

Magnetic Example

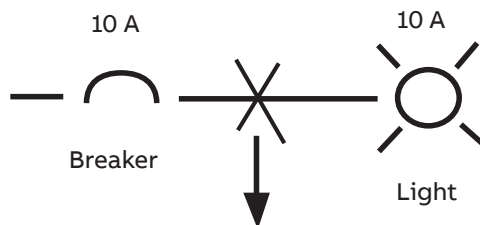

The wire connected between the light and breaker is cut and shorted to ground creating a short circuit.

Breaker definition

A breaker is a device designed to isolate a circuit during an overcurrent event without the use of a fusible element. A breaker is a resettable protective device that protects against two types of overcurrent situations: overload and short circuit

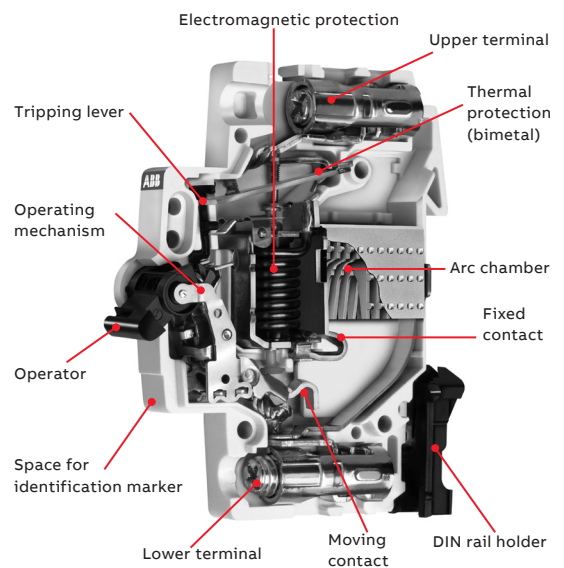

Miniature circuit breakers

Circuit breaker construction

Thermal / Magnetic trip units

ABB Current Limiting Breakers use an electromechanical (Thermal/Magnetic) trip unit to open the breaker contacts during an overcurrent event. The thermal trip unit is temperature sensitive and the magnetic trip unit is current sensitive. Both units act independently and mechanically with the breaker's trip mechanism to open the breaker's contacts.

Current flow during operation:

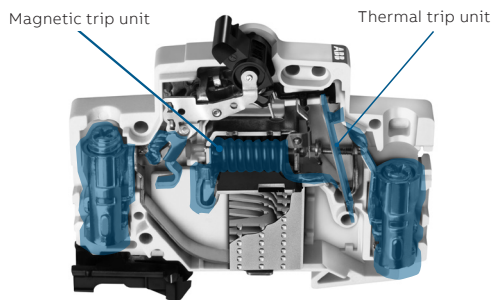

All highlighted components are energized during operation

Overload protection

The thermal trip unit protects against a continuous overload. The thermal unit is comprised of a bimetal element located behind the circuit breaker trip bar and is part of the breaker's current carrying path. When there is an overload, the increased current flow heats the bimetal causing it to bend. As the bimetal bends, it pulls the trip bar that opens the breaker's contacts.

The time required for the bimetal to bend and trip the breaker varies inversely with the current. Because of this, the tripping time becomes quicker as current increases in magnitude.

Overload protection is applicable to any installa-

tion, conductor, or component that can be subjected to low-magnitude but long-time overcurrents. Low-magnitude, long-time overcurrents can be dangerous because they reduce the life of the electrical installation, conductor, and components. If left unchecked, fire could result.

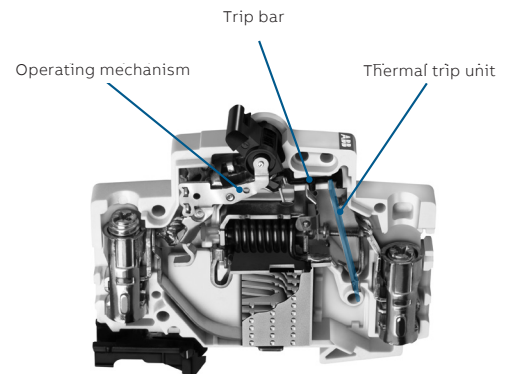

Magnetic trip unit

The magnetic trip unit protects against a short circuit. The magnetic trip unit is comprised of an electromagnet and an armature.

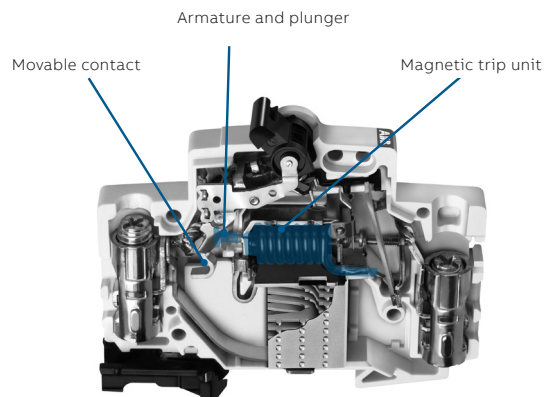

Miniature circuit breakers

Circuit breaker construction

Components of a magnetic trip unit

When there is a short circuit, a high magnitude of current passes through the coils creating a magnetic field that attracts the movable armature towards the fixed armature. The hammer trip is pushed against the movable contact and the contacts are opened. The opening of the breaker's contacts during a short circuit is complete in 0.5 milli-seconds.

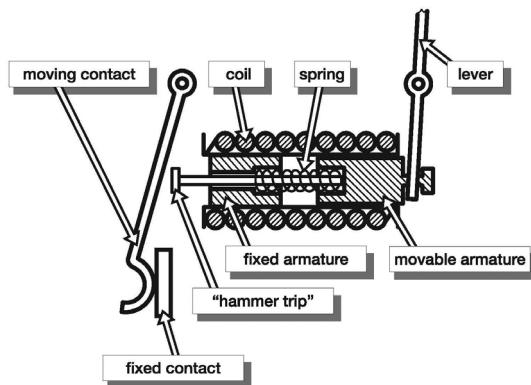

Arc runners / arc chutes

The arc runner guides the electric arc away from the open contacts into the arc chute where it is extinguished.

During an overload or short circuit event, the contacts of the breaker separate, and an electrical arc is formed between the contacts through air. The arc is moved into the arc chute by "running" the arc down the interior of the breaker along the arc runner. When the arc reaches the arc chute, it is broken into small segmented arcs. The segmented arcs split the overall energy level into segments less than 25 V. Each 25 V segment does not have a high enough energy level to maintain an arc and all energy is naturally dissipated.

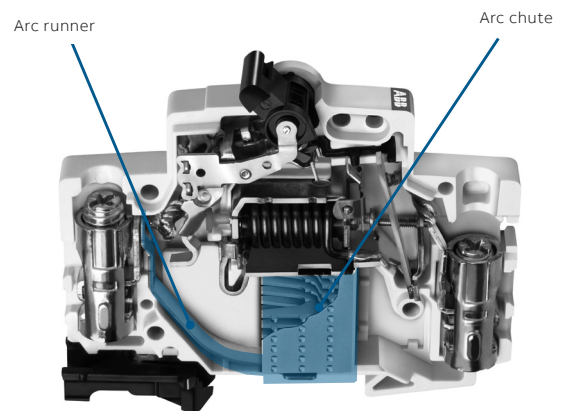

Breaker's thermal trip (region 1)

The first sloping region of the breaker curve is a graphical representation (next page) of the tripping characteristics of the thermal trip unit. This portion of the curve is sloped due to the nature of the thermal trip unit. The trip unit bends to trip the breaker's trip bar in conjunction with a rise in amperage (temperature) over time.

As the current on the circuit increases, the temperature rises, the faster the thermal element will trip. Example using the curve on next page: If you had a 10 A breaker and the circuit was producing 30 amps of current, the breaker would trip between two seconds and one minute. In this example, you would find the circuit current on the bottom of the graph (multiples of rated current). The first line is 10 amps (10 amp breaker x a multiple of one), the second line is 20 amps (10 amp breaker x multiple of two), and the third line is 30 amps (10 amp breaker x multiple of three). Next, you would trace the vertical 30A line up until it intersects the red portion of the breaker thermal curve. If you follow the horizontal lines on both sides of the red curve to the left, you will see that the breaker can trip as fast as two seconds and no slower than one minute.

Miniature circuit breakers

Circuit breaker construction

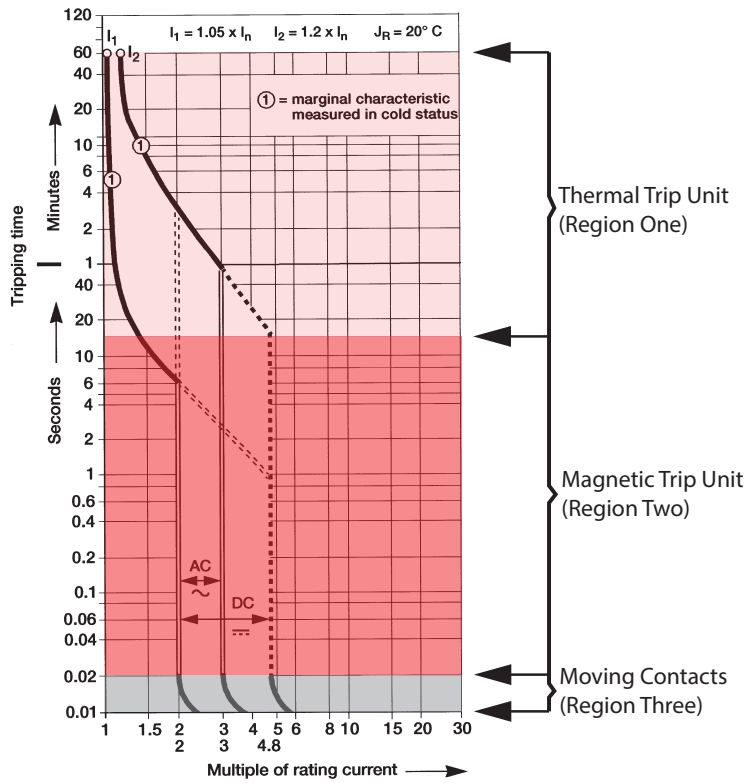

Breaker's magnetic trip (region 2)

This region of the breaker curve is the instantaneous trip unit. ABB's miniature circuit breaker's instantaneous trip unit interrupts a short circuit in 2.3 to 2.5 milliseconds. Because of this, the curve has no slope and is graphically represented as a vertical straight line.

See curve example. If you had a 10 amp breaker, the magnetic trip element would interrupt a short circuit between 10 and 30 amps (10 amp breaker x multiple of two and three) in 2.3 to 2.5 milliseconds

Breaker's contacts (region 3)

This region of the curve is the time required for the contacts of the breaker to begin to separate. The contacts will open in less than .5 milliseconds and is graphically represented by the bottom vertical portion of the curve.

Miniature circuit breakers

Circuit breaker current limitation

All ABB miniature circuit breakers are UL tested and certified as current limiting protective devices. Current limiting circuit breakers provide a higher level of circuit protection than typical zero point external breakers.

60Hz AC cycle (UL)

UL defines an AC cycle as the potential energy of the wave form traveling from zero-to-positive amplitude, positive-to-zero amplitude, zero-to-negative amplitude, negative-to-zero amplitude 60 times in one second. One cycle is completed every 16.6 milliseconds.

Current limiting breaker (UL)

UL defines breaker current limitation as a breaker that interrupts and isolates a fault in less than 1/2 of an AC cycle. Half a cycle is completed in 8.3 milliseconds.

NEC240.2 current limiting

A device that, when interrupting current in its current-limiting range, reduces the current flowing in the faulted circuit to a magnitude substantially less than that obtainable in the same circuit if the device were replaced with a solid conductor having comparable impedance.

IEC 60947-2 current limiting

A circuit breaker with sufficiently short trip time to prevent the short-circuit current from reaching the peak value which would otherwise be reached.

ABB's current limiting circuit breakers

ABB current limiting breakers can interrupt and isolate a fault in 1/8 of an AC cycle. The breaker fault interruption is completed in 2.3 to 2.5 milliseconds.

Zero point extinguishing breakers

A typical zero point extinguishing breaker interrupts a fault and does not isolate the energy. The breaker allows an arc to be present between the open contacts until the AC wave form crosses zero.

When the wave form crosses zero, the potential energy is zero and the arc (fault) naturally extinguishes. The arc could be present for up to 8.3 milliseconds.

Current limiting breakers and electrical networks current limitation

When a short-circuit condition occurs, the "ideal" current limiting circuit breaker opens before the current waveform can reach its full potential magnitude which occurs at ¼ cycle (4.17ms). ABB's current limiting breakers can interrupt a fault in about ½ cycle or 2.3 ms to 2.5 ms. ABB's current limiting breakers interrupt a short circuit in less than 1/8 cycle and limit the amount of current that can reach a circuit. Limiting the available current on the circuit provides additional protection against network, breaker, or bus damage and prevents the tripping of upstream breakers (selective coordination).

I²t (let-thru energy)

The true destructive nature of a short circuit is measured by the time it is available combined with the peak value of the short circuit. The I²t (Amps Squared over Time) value represents the amount of energy available on a network during a short circuit and is represented by the shaded area on the graph next page.

During a short circuit, both magnetic forces and thermal energy combine to damage devices on the electrical network. The level of thermal energy and magnetic forces are directly proportional to the square of the current. The magnetic forces vary as a square of the peak current available and the thermal energy varies as a square of the RMS (root mean square) current available.

ABB's current limiting breakers will limit the let-through energy to a fraction (1/100) of the value that is available from the network. By comparison, a zero crossing breaker would let through approximately 100 times as much destructive energy as the current limiting circuit breaker [(100,000A / 10,000A) squared = 100X].

Miniature circuit breakers

Circuit breaker current limitation

ABB's current limiting breakers limit the short circuit current to a relatively small magnitude in an extremely short time, which dramatically limits a short circuit's destructive energy.

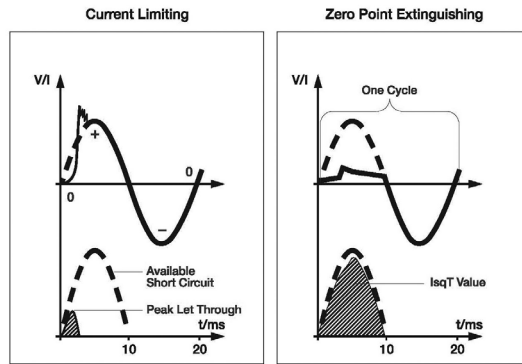

Current limiting and zero crossing breakers

During the initial stages of a short circuit, a breaker's contacts open to interrupt the circuit. After the contacts open, an arc forms in the air between the contacts on both the current limiting and zero crossing breaker contacts. What distinguishes a current limiting breaker from a zero, crossing breaker is what each breaker does after an arc is formed between the open contacts.

A current limiting breaker "runs" the arc down the breaker arc runner into an arc chute that extinguishes the arc.

A zero crossing breaker does not attempt to extinguish the arc. The breaker is designed to withstand the energy of the arc long enough for the waveform to cross zero. When the wave form crosses zero the potential energy is zero and the arc naturally extinguishes itself.

ABB's current limiting breakers interrupt the arc en-

ergy in 2.3 ms to 2.5 ms (1/8 cycle) and a zero crossing breaker allows the arc to be present for up to 8.3 ms (1/2 cycle). A zero crossing breaker will let through 100 times as much energy as an ABB current limiting breaker.

Current limiting example

The lab test report below details a 20 A S200 series current limiting breaker interrupting a 28 kA fault in 1.7 milliseconds. The total "I Square T" value is 32.0 kA.

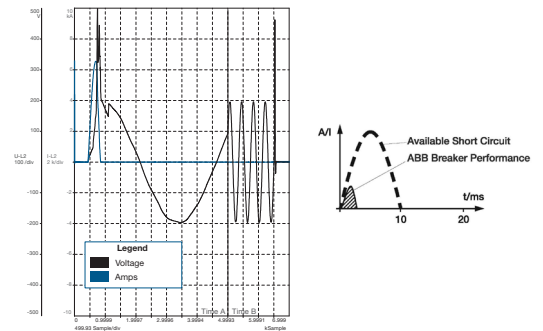

Zero crossing example

The test report below details a 20 A zero point extinguishing breaker interrupting a 9 kA fault in 9 milliseconds. The total "I Square T" value is 104.0 kA.

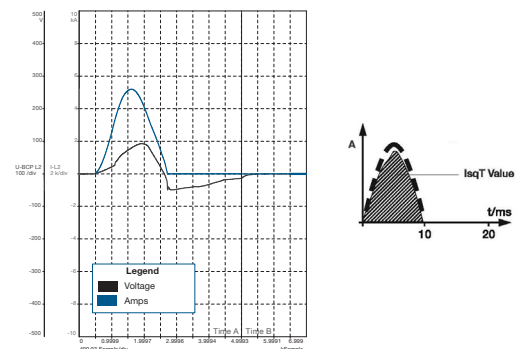

Miniature circuit breakers

Selective coordination and series rating

Definition of selective coordination

Coordination between the operating characteristics of two or more overcurrent protection devices, so that when an over-current within established limits occurs, the device designated to operate within those limits trips whereas the other devices does not trip.

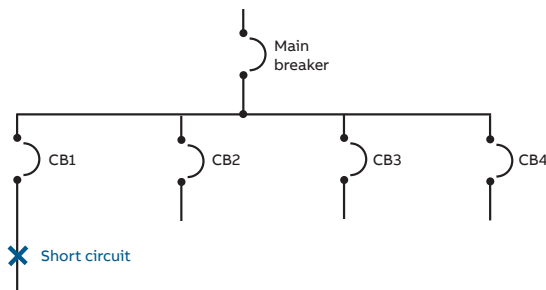

Example of breaker coordination

When an over-current event occurs at the branch breaker level (CB1), and the event is within the operating characteristics of the breaker, then the branch breaker should interrupt the circuit (open) and the main breaker should remain closed and energized. The chart below gives a graphical representation of a down stream branch breaker (B curve) and a main breaker (A curve) with coordination. The separation between the curves allows the branch breaker to react to the fault and the main breaker remains closed and energized.

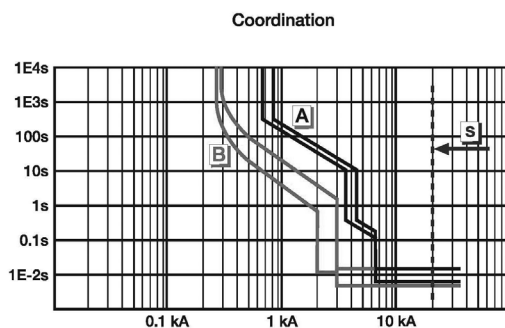

Example of no breaker coordination

Selective breaker coordination is not achieved when there is an overload event at the branch breaker level (MCB1) and both the branch breaker and main breaker interrupt the circuit (open). When there is no breaker coordination, several circuits lose power that should remain operational during and after the overload event. The chart below gives a graphical representation of a down stream branch breaker (B curve) and a main breaker (A curve) without coordination. There is no separation between the curves. The branch breaker will react to a fault and the main breaker will open and de-energize all circuits down stream.

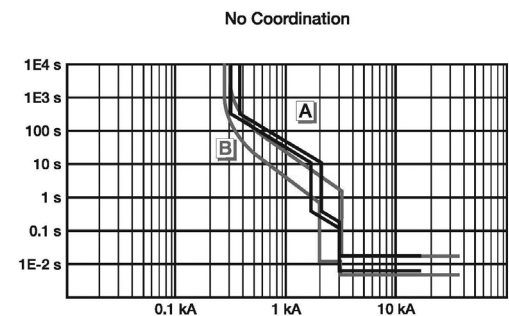

Problems in coordination occur when the branch breaker allows the "I Square T" value of the short circuit to rise to a level that is in the operating range of the upstream main breaker. Proper breaker coordination is easier to achieve with the use of current limiting breakers at the branch level.

Selective coordination and current limiting

Recent improvements in ABB circuit breaker technology has pushed the performance of breakers to the same level as fuses. The reaction time and tripping characteristics of current limiting breakers are now on par with fuses. This allows ABB to provide a high level of coordination between branch breakers and the main. A current limiting branch breaker will limit the "I Square T" value well below the level

Miniature circuit breakers

Selective coordination and series rating

of the operating range of the upstream main breaker. ABB's current limiting branch breakers can coordinate between the main breaker up to 35 kA.

Selective coordination and zero crossing

Zero crossing breakers do not limit the "I Square T" value. They wait for the wave form to cross zero and allow a high level of let-through energy to pass through the system. The "I Square T" value of a zero crossing breaker is high enough that the main breaker will likely trip during a short circuit. With zero crossing breakers it is extremely difficult to coordinate between branch and main breakers. A typical zero crossing breaker's coordination level is below 10 kA. There are a few manufacturers that have achieved coordination between a branch zero crossing breaker and the main by slowing the performance (protection) of the main breaker.

Selective coordination

Selective coordination is achieved when there is a short circuit on a branch circuit breaker, the branch breaker opens and isolates the fault, and the main breaker remains closed. The rating is usually a value above the "stand alone" interrupting rating of the branch breaker and the "stand alone" rating of the main breaker.

Example:

- 65 kA rated main breaker
- 10 kA rated branch breaker
- Coordination between the two breakers up to 35 kA

There can be a short circuit on the branch breaker up to 35 kA where the branch will open (CB1) and the main breaker will remain closed. Although the branch has a 10 kA "stand alone" rating, both the breakers work together to limit the available short circuit to allow the branch (CB1) to isolate the fault.

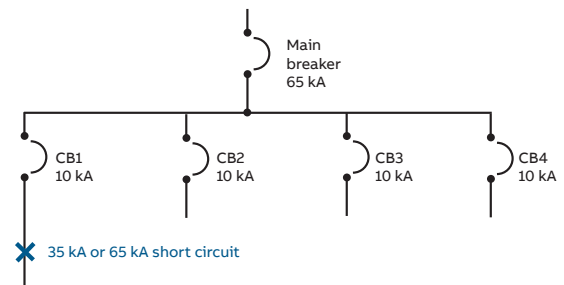

Series ratings

Series ratings are different from coordination ratings. Unlike coordination ratings where the branch opens and the main remains closed, a series rated combination is one where both the branch and main breakers open and work together to isolate the fault.

The series rating combination of two breakers is equal to the "stand alone" interrupting value of the main breaker. This is a result of the main breaker let-through value being lower than the "stand alone" interrupting value of the branch breaker.

During a short circuit the main breaker will limit the energy to a level that is below the "stand alone" value of the branch breaker.

Example:

- 65 kA rated main breaker
- 10 kA rated branch breaker
- Series combination rating between the two breakers up to 65 kA

There can be a short circuit on the branch breaker up to 65 kA where the branch will open and the main breaker will open. Although the branch breaker (CB1) has a 10 kA "stand alone" rating the main breaker has a let-through value below 10 kA. If there is a fault up to 65 kA on the network, the main breaker will limit the energy to a value less than the rating of the branch breaker (CB1). Both breakers will trip (no coordination), but the network can safely withstand a fault of 65 kA.

Miniature circuit breakers

UL489 vs UL1077

Definition of branch circuits (UL489) and supplemental protectors (UL1077)

A branch circuit is defined as a circuit that has the first overcurrent device. UL489 has additional spacing requirements (over surface, through air) compared to supplemental protection. Branch protection breakers also have some different spacing, and slight mechanical differences, internally to the breaker, as compared to a Supplemental Protector.

A Supplemental Protector is defined as an overcurrent device for protection of the end circuit. Or, said another way, may be added to a circuit to provide an extra level of protection for a specific component. These devices require the use of an upstream protective device, or Branch Protection. It is not designed to be used as a substitute for Branch Protection (per NEC Article 240.10).

Where to use supplemental protectors.

If the Branch Protection is adequate to protect the circuit and/ or components, a supplemental protector can be inserted. If the supplemental protector is part of the circuit, and then removed, and the Branch protection meets the above protection requirements, the supplemental protector is properly applied.

Drawing below based on UL "Description of terminology," Figure 6.1 effective April 25, 2003 for UL508A, UL489 & UL1077 (UL copyrighted)

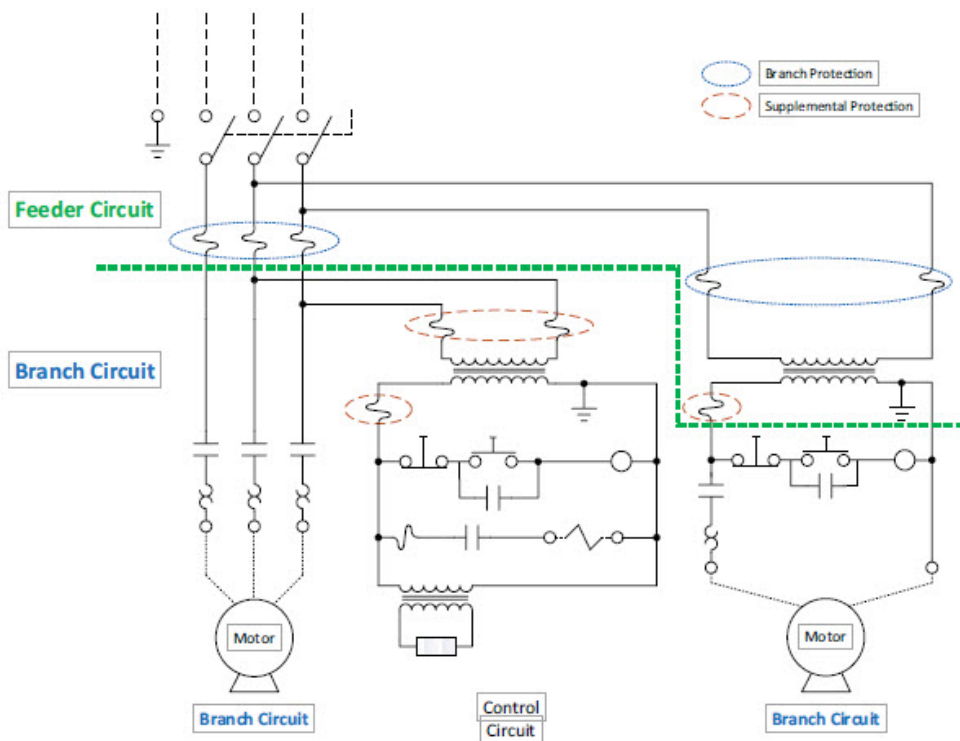

Miniature circuit breakers

UL489 vs UL1077

Misuse of supplemental protection

In this circuit, a UL489 molded case circuit breaker (MCCB) is correctly used as the main breaker for the four motors being controlled. However, each motor is protected by a UL1077 supplemental “miniature breaker.”

This is not correct and violates both the NEC and UL. Each individual motor circuit is a separate branch circuit and requires the use of a UL489 listed circuit breaker.

This is determined by evaluating the conductors feeding the loads. Supplemental protectors must be ignored because they are not listed branch circuit protective devices. Therefore, in this example, the 10 AWG conductors are only being protected by the 100A MCCB. **The 100A MCCB is too large to adequately protect the small 10 AWG conductors per the NEC.** The supplemental protectors must be replaced by appropriately sized UL489 listed circuit breakers.

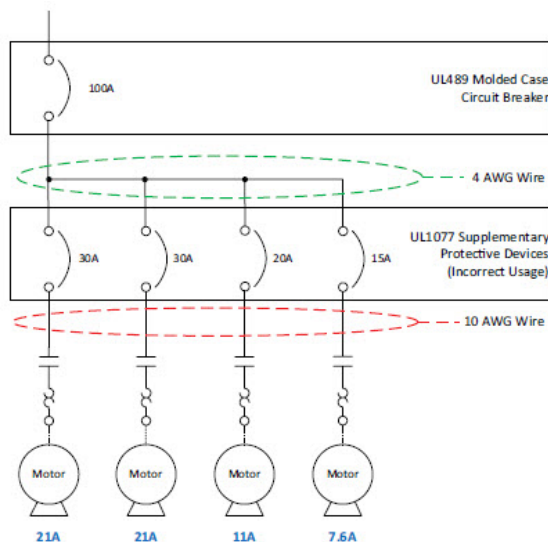

Correct usage of supplemental protection

In this circuit, a UL489 molded case circuit breaker (MCCB) is again correctly used as the main breaker for the three heater loads being protected.

Each individual heater is protected by a UL1077 supplemental device. It is essential the wire feeding each individual heater is adequately protected by the UL489 breaker, and in **this case the wire size has not been decreased but remains 6 AWG throughout the circuit.** Since heaters may appropriately be connected in parallel, **the use of the supplemental devices is optional and therefore permitted.**

A failure of one heater may trip the associated supplemental device but not trip the upstream 80A breaker. This will allow the other two heaters to continue to function.

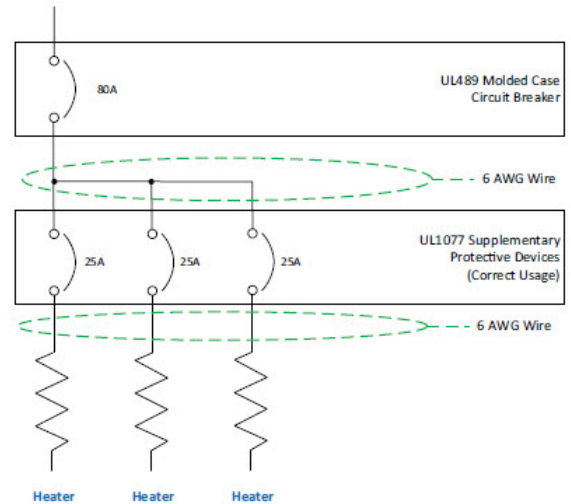

Miniature circuit breakers

Wiring in DC applications

Use of S2T00M in direct current circuits (60 / 125 Vdc)

In DC systems up to 60 Vdc or, as the case may be, series connection up to 125 Vdc, customary ST200M series MCBs can be used. Polarity does not need to be taken into consideration, the outgoing circuit may be implemented from above or below the device.

For higher direct voltage up to 500 Vdc, devices of the S200MUC series must be used.

Example of permissible voltages between the conductors depending on the number of poles and type of connection

Voltage between conductors	60 Vdc	125 Vdc	125 Vdc	60 Vdc
	1 pole	2 pole	2 pole	2 pole

Supply from top or bottom

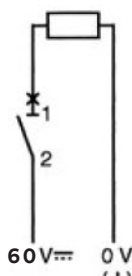
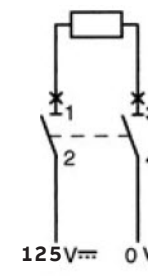
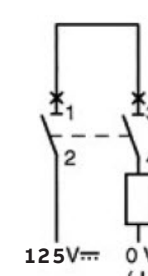
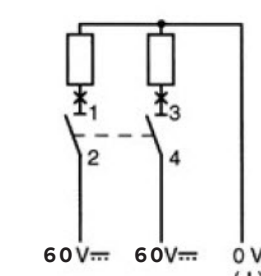



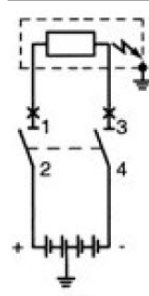

Example for different voltages between a conductor and earth where voltages between conductors are identical

Maximum voltage allowed	60 Vdc	125 Vdc
	2 pole	4 pole

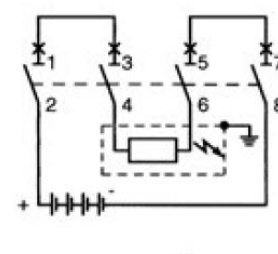

60 Vdc



125 Vdc

Miniature circuit breakers

Wiring in DC applications

Use of S200MUC in direct current circuits (250 / 500 Vdc)

S200MUC miniature circuit breakers can be used in the 1 pole version at 250 VDC, and in the 2-pole or 4-pole version with series connection of two poles up to 500 VDC. S200MUC differs from the standard S200 type. It is equipped with permanent magnets that assist in the forced extinguishing of the arc.

If voltages to ground exceeding 250 VDC occur, 2-pole S200MUC should be used for one-pole disconnection and four-pole S200MUC for all-pole disconnection

For DC incoming supply from top / above

S200MUC MCBs have permanent magnets in the area of arc chutes. Therefore, it is necessary to take into account the polarity during the installation process. In the case of a short circuit, the magnetic field of the permanent magnets corresponds with the electromagnetic field of the short-circuit current, therefore, safely leading the short circuit into the arc chute. Incorrect polarities may cause damage to the MCB. As a result for top-fed devices, terminal 1 must be connected to (-) and terminal 3 to (+).

Example of permissible voltages between the conductors depending on the number of poles and circuit layout

Voltage between conductors	250 Vdc	500 Vdc	500 Vdc	500 Vdc	500 Vdc
Voltage between conductor and earth	250 Vdc	250 Vdc	500 Vdc	250 Vdc	250 Vdc
	S201MUC	S202MUC	S202MUC	S202MUC	S204MUC

Supply from bottom / below

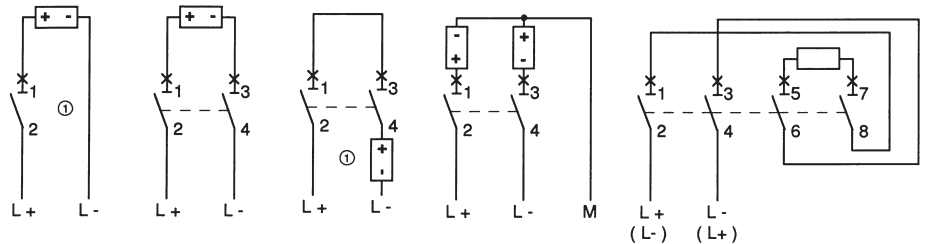

Supply from top / above

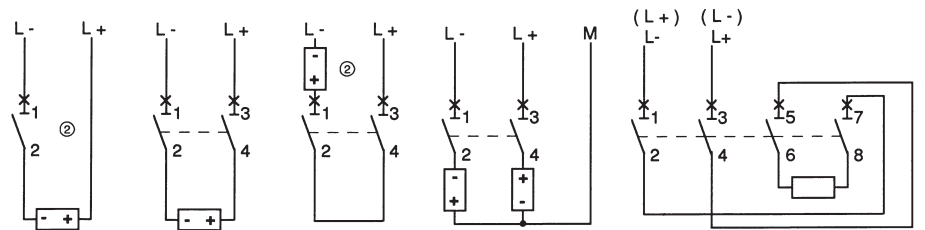

(1) In the circuit diagram, the negative pole is earthed
 (2) In the circuit diagram, the positive pole is earthed

Miniature circuit breakers

Wiring in DC applications

Example of permissible voltages between the conductors depending on the number of poles and circuit layout for S200MUC

Voltage between conductors	500 Vdc All-pole disconnection	500 Vdc 1-pole disconnection	500 Vdc All-pole disconnection
Voltage between conductor and earth	250 Vdc Symmetrically grounded	250 Vdc Unsymmetrically grounded	250 Vdc Unsymmetrically grounded
	S202MUC	S202MUC	S204MUC

Supply from bottom / Below

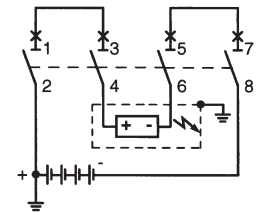
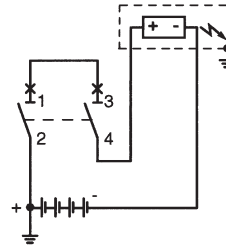
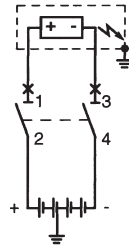

- (1) In the circuit diagram, the negative pole is earthed
 (2) In the circuit diagram, the positive pole is earthed

Miniature circuit breakers

Wiring in DC applications

Use of S200UDC in direct current circuits (60 / 125 Vdc) according to UL489 / CSA C22.2 No.5

S200UDC MCBs can be used in the one-pole version as 60 Vdc, and in the 2-pole version with series connection of two poles up to 125 Vdc.

S200UDC contains fitted permanent magnets, which assists in the forced extinguishing of the arc. If voltages to earth exceeding 60 Vdc may occur, 2-pole S200UDC is to be used for one-pole disconnection.

For DC incoming supply from above S200UDC-... MCBs have, in the area of arc chutes, permanent magnets, it is therefore necessary to take into account the polarity during the installation process.

Doing so ensures that in the case of a short circuit the magnetic field of the permanent magnets corresponds with the electromagnetic field of the short-circuit current, therefore safely leading the short circuit into the arc chute.

Incorrect polarities may cause damage to the MCB. This is why – in the case of top-fed devices – terminal 1 must be connected to (-) and terminal to 3 (+).

Example of permissible voltages between the conductors depending on the number of poles and circuit layout

Voltage between conductors	U_n	125 V- (≤ 40 A) 60 V- (> 40 A)	250 V- (≤ 40 A) 125 V- (> 40 A)	250 V- (≤ 40 A) 125 V- (> 40 A)	250 V- (≤ 40 A) 125 V- (> 40 A)
Voltage between conductor and earth	U_n	125 V- (≤ 40 A) 60 V- (> 40 A)	125 V- (≤ 40 A) 60 V- (> 40 A)	250 V- (≤ 40 A) 125 V- (> 40 A)	125 V- (≤ 40 A) 60 V- (> 40 A)
		1-pole - S201UDC	2-pole - S202UDC	2-pole - S202UDC	2-pole - S202UDC

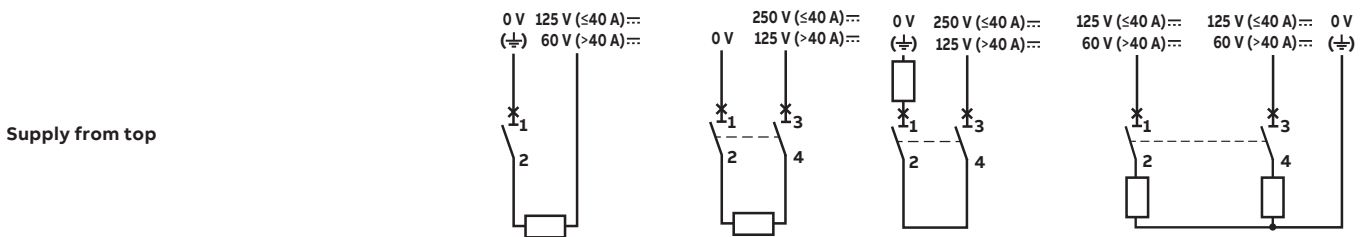
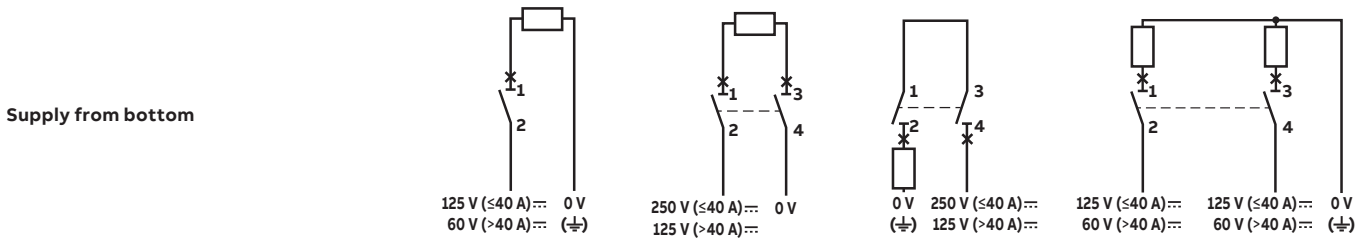

Miniature circuit breakers

Wiring in DC applications

Example for different voltage levels between conductor and earth in case of identical voltage between conductors for S200UDC

Voltage between conductors	U_n	250 V- (≤ 40 A) 125 V- (> 40 A) all-pole disconnection	250 V- (≤ 40 A) 125 V- (> 40 A) 1-pole disconnection
Voltage between conductor and earth	U_n	125 V- (≤ 40 A) 60 V- (> 40 A) circuit symmetrically earthed	250 V- (≤ 40 A) 125 V- (> 40 A) circuit unsymmetrically earthed
		2-pole - S202UDC	2-pole - S202UDC

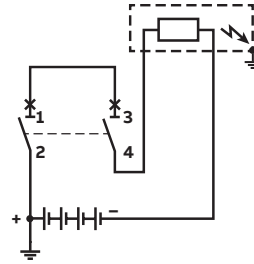
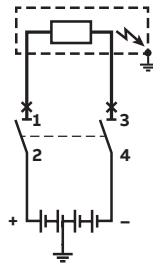



Notes

A series of horizontal dotted lines for taking notes.



CSA C22.2 No.5 / UL489 devices

003–006	SU200M
007	SU200MR
008	S200UDC
009–013	Accessories
014–019	Technical details
020–024	Tripping curves details
025–026	Dimensions
029–032	S800U
033–034	S804U-UCZ
035–036	S804U-PVS
037–040	Accessories
041–045	Technical details
046–049	Tripping curves details
050–052	Dimensions

SU200M series

UL489 Branch Circuit Protection

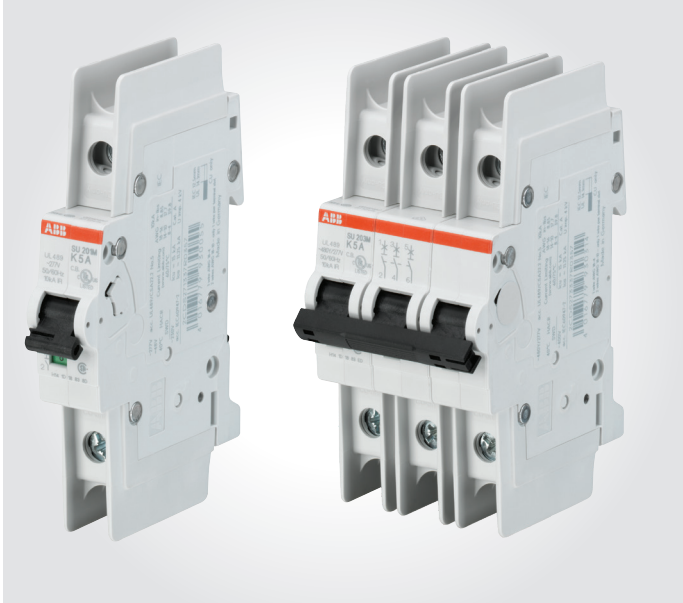

The miniature circuit breaker SU200M is ABB's solution for UL 489 branch circuit protection up to 480 Y/277 V AC and 96 V DC.

This circuit breaker is an all-round device for AC and DC applications for universal use in North American

Moreover, SU200M is fully compatible with System pro M compact® UL 489 accessories.

General Data	SU200M
Amperage	0.2 up to 63 A
Voltage	480Y/277 V AC 48/96 V DC (1/2-pole)
Poles	1, 2, 3, 4
Trip curves	C, K, Z
Short circuit interrupt rating	10 kA
Auxiliary contacts	Yes
Ambient temperature	-25 ... +55 °C
Mechanical life	20,000 operations
Bell alarm	Yes
Shunt trip	Yes
Undervoltage release	Yes
Busbar	Yes

Features

- UL current limiting
- Fast breaking time (2.3–2.5 ms)
- Bus connection system
- Wide range of accessories
- Available with variable depth handle mechanism
- CE certified and marked
- DIN rail mounting
- Finger-safe terminals
- Multi-function terminals
- Suitable for reverse feed
- CSA C22.2 No.5 certified
- UL 489 listed branch circuit protective device
- UL File #E212323

SU200M series

C tripping characteristic

1 pole	Box Qty	Weight each (kg)	Rated Current	Part number
	10	0.125	0.5 A	SU201M-C0.5
			1.0 A	SU201M-C1
			1.6 A	SU201M-C1.6
			2.0 A	SU201M-C2
			3.0 A	SU201M-C3
			4.0 A	SU201M-C4
			5.0 A	SU201M-C5
			6.0 A	SU201M-C6
			7.0 A	SU201M-C7
			8.0 A	SU201M-C8
			10.0 A	SU201M-C10
			13.0 A	SU201M-C13
			15.0 A	SU201M-C15
			16.0 A	SU201M-C16
			20.0 A	SU201M-C20
			25.0 A	SU201M-C25
			30.0 A	SU201M-C30
			32.0 A	SU201M-C32
			35.0 A	SU201M-C35
			40.0 A	SU201M-C40
		50.0 A	SU201M-C50	
		60.0 A	SU201M-C60	
		63.0 A	SU201M-C63	

2 poles	Box Qty	Weight each (kg)	Rated Current	Part number
	5	0.250	0.5 A	SU202M-C0.5
			1.0 A	SU202M-C1
			1.6 A	SU202M-C1.6
			2.0 A	SU202M-C2
			3.0 A	SU202M-C3
			4.0 A	SU202M-C4
			5.0 A	SU202M-C5
			6.0 A	SU202M-C6
			7.0 A	SU202M-C7
			8.0 A	SU202M-C8
			10.0 A	SU202M-C10
			13.0 A	SU202M-C13
			15.0 A	SU202M-C15
			16.0 A	SU202M-C16
			20.0 A	SU202M-C20
			25.0 A	SU202M-C25
			30.0 A	SU202M-C30
			32.0 A	SU202M-C32
			35.0 A	SU202M-C35
			40.0 A	SU202M-C40
		50.0 A	SU202M-C50	
		60.0 A	SU202M-C60	
		63.0 A	SU202M-C63	

3 poles	Box Qty	Weight each (kg)	Rated Current	Part number
	3	0.375	0.5 A	SU203M-C0.5
			1.0 A	SU203M-C1
			1.6 A	SU203M-C1.6
			2.0 A	SU203M-C2
			3.0 A	SU203M-C3
			4.0 A	SU203M-C4
			5.0 A	SU203M-C5
			6.0 A	SU203M-C6
			7.0 A	SU203M-C7
			8.0 A	SU203M-C8
			10.0 A	SU203M-C10
			13.0 A	SU203M-C13
			15.0 A	SU203M-C15
			16.0 A	SU203M-C16
			20.0 A	SU203M-C20
			25.0 A	SU203M-C25
			30.0 A	SU203M-C30
			32.0 A	SU203M-C32
			35.0 A	SU203M-C35
			40.0 A	SU203M-C40
		50.0 A	SU203M-C50	
		60.0 A	SU203M-C60	
		63.0 A	SU203M-C63	

4 poles	Box Qty	Weight each (kg)	Rated Current	Part number
	2	0.500	0.5 A	SU204M-C0.5
			1.0 A	SU204M-C1
			1.6 A	SU204M-C1.6
			2.0 A	SU204M-C2
			3.0 A	SU204M-C3
			4.0 A	SU204M-C4
			5.0 A	SU204M-C5
			6.0 A	SU204M-C6
			7.0 A	SU204M-C7
			8.0 A	SU204M-C8
			10.0 A	SU204M-C10
			13.0 A	SU204M-C13
			15.0 A	SU204M-C15
			16.0 A	SU204M-C16
			20.0 A	SU204M-C20
			25.0 A	SU204M-C25
			30.0 A	SU204M-C30
			32.0 A	SU204M-C32
			35.0 A	SU204M-C35
			40.0 A	SU204M-C40
		50.0 A	SU204M-C50	
		60.0 A	SU204M-C60	
		63.0 A	SU204M-C63	

SU200M series

K tripping characteristic

1 pole	Box Qty	Weight each (kg)	Rated Current	Part number
	10	0.125	0.5 A	SU201M-K0.5
			1.0 A	SU201M-K1
			1.6 A	SU201M-K1.6
			2.0 A	SU201M-K2
			3.0 A	SU201M-K3
			4.0 A	SU201M-K4
			5.0 A	SU201M-K5
			6.0 A	SU201M-K6
			7.0 A	SU201M-K7
			8.0 A	SU201M-K8
			10.0 A	SU201M-K10
			13.0 A	SU201M-K13
			15.0 A	SU201M-K15
			16.0 A	SU201M-K16
			20.0 A	SU201M-K20
			25.0 A	SU201M-K25
			30.0 A	SU201M-K30
			32.0 A	SU201M-K32
			35.0 A	SU201M-K35
			40.0 A	SU201M-K40
			50.0 A	SU201M-K50
			60.0 A	SU201M-K60
			63.0 A	SU201M-K63



2 poles	Box Qty	Weight each (kg)	Rated Current	Part number
	5	0.250	0.5 A	SU202M-K0.5
			1.0 A	SU202M-K1
			1.6 A	SU202M-K1.6
			2.0 A	SU202M-K2
			3.0 A	SU202M-K3
			4.0 A	SU202M-K4
			5.0 A	SU202M-K5
			6.0 A	SU202M-K6
			7.0 A	SU202M-K7
			8.0 A	SU202M-K8
			10.0 A	SU202M-K10
			13.0 A	SU202M-K13
			15.0 A	SU202M-K15
			16.0 A	SU202M-K16
			20.0 A	SU202M-K20
			25.0 A	SU202M-K25
			30.0 A	SU202M-K30
			32.0 A	SU202M-K32
			35.0 A	SU202M-K35
			40.0 A	SU202M-K40
			50.0 A	SU202M-K50
			60.0 A	SU202M-K60
			63.0 A	SU202M-K63



3 poles	Box Qty	Weight each (kg)	Rated Current	Part number
	3	0.375	0.5 A	SU203M-K0.5
			1.0 A	SU203M-K1
			1.6 A	SU203M-K1.6
			2.0 A	SU203M-K2
			3.0 A	SU203M-K3
			4.0 A	SU203M-K4
			5.0 A	SU203M-K5
			6.0 A	SU203M-K6
			7.0 A	SU203M-K7
			8.0 A	SU203M-K8
			10.0 A	SU203M-K10
			13.0 A	SU203M-K13
			15.0 A	SU203M-K15
			16.0 A	SU203M-K16
			20.0 A	SU203M-K20
			25.0 A	SU203M-K25
			30.0 A	SU203M-K30
			32.0 A	SU203M-K32
			35.0 A	SU203M-K35
			40.0 A	SU203M-K40
			50.0 A	SU203M-K50
			60.0 A	SU203M-K60
			63.0 A	SU203M-K63





4 poles	Box Qty	Weight each (kg)	Rated Current	Part number
	2	0.500	0.5 A	SU204M-K0.5
			1.0 A	SU204M-K1
			1.6 A	SU204M-K1.6
			2.0 A	SU204M-K2
			3.0 A	SU204M-K3
			4.0 A	SU204M-K4
			5.0 A	SU204M-K5
			6.0 A	SU204M-K6
			7.0 A	SU204M-K7
			8.0 A	SU204M-K8
			10.0 A	SU204M-K10
			13.0 A	SU204M-K13
			15.0 A	SU204M-K15
			16.0 A	SU204M-K16
			20.0 A	SU204M-K20
			25.0 A	SU204M-K25
			30.0 A	SU204M-K30
			32.0 A	SU204M-K32
			35.0 A	SU204M-K35
			40.0 A	SU204M-K40
			50.0 A	SU204M-K50
			60.0 A	SU204M-K60
			63.0 A	SU204M-K63





SU200M series

Z tripping characteristic

1 pole	Box Qty	Weight each (kg)	Rated Current	Part number
	10	0.125	0.5 A	SU201M-Z0.5
			1.0 A	SU201M-Z1
			1.6 A	SU201M-Z1.6
			2.0 A	SU201M-Z2
			3.0 A	SU201M-Z3
			4.0 A	SU201M-Z4
			5.0 A	SU201M-Z5
			6.0 A	SU201M-Z6
			7.0 A	SU201M-Z7
			8.0 A	SU201M-Z8
			10.0 A	SU201M-Z10
			13.0 A	SU201M-Z13
			15.0 A	SU201M-Z15
			16.0 A	SU201M-Z16
			20.0 A	SU201M-Z20
			25.0 A	SU201M-Z25
			30.0 A	SU201M-Z30
			32.0 A	SU201M-Z32
			35.0 A	SU201M-Z35
			40.0 A	SU201M-Z40
		50.0 A	SU201M-Z50	
		60.0 A	SU201M-Z60	
		63.0 A	SU201M-Z63	

2 poles	Box Qty	Weight each (kg)	Rated Current	Part number
	5	0.250	0.5 A	SU202M-Z0.5
			1.0 A	SU202M-Z1
			1.6 A	SU202M-Z1.6
			2.0 A	SU202M-Z2
			3.0 A	SU202M-Z3
			4.0 A	SU202M-Z4
			5.0 A	SU202M-Z5
			6.0 A	SU202M-Z6
			7.0 A	SU202M-Z7
			8.0 A	SU202M-Z8
			10.0 A	SU202M-Z10
			13.0 A	SU202M-Z13
			15.0 A	SU202M-Z15
			16.0 A	SU202M-Z16
			20.0 A	SU202M-Z20
			25.0 A	SU202M-Z25
			30.0 A	SU202M-Z30
			32.0 A	SU202M-Z32
			35.0 A	SU202M-Z35
			40.0 A	SU202M-Z40
		50.0 A	SU202M-Z50	
		60.0 A	SU202M-Z60	
		63.0 A	SU202M-Z63	

3 poles	Box Qty	Weight each (kg)	Rated Current	Part number
	3	0.375	0.5 A	SU203M-Z0.5
			1.0 A	SU203M-Z1
			1.6 A	SU203M-Z1.6
			2.0 A	SU203M-Z2
			3.0 A	SU203M-Z3
			4.0 A	SU203M-Z4
			5.0 A	SU203M-Z5
			6.0 A	SU203M-Z6
			7.0 A	SU203M-Z7
			8.0 A	SU203M-Z8
			10.0 A	SU203M-Z10
			13.0 A	SU203M-Z13
			15.0 A	SU203M-Z15
			16.0 A	SU203M-Z16
			20.0 A	SU203M-Z20
			25.0 A	SU203M-Z25
			30.0 A	SU203M-Z30
			32.0 A	SU203M-Z32
			35.0 A	SU203M-Z35
			40.0 A	SU203M-Z40
		50.0 A	SU203M-Z50	
		60.0 A	SU203M-Z60	
		63.0 A	SU203M-Z63	

4 poles	Box Qty	Weight each (kg)	Rated Current	Part number
	2	0.500	0.5 A	SU204M-Z0.5
			1.0 A	SU204M-Z1
			1.6 A	SU204M-Z1.6
			2.0 A	SU204M-Z2
			3.0 A	SU204M-Z3
			4.0 A	SU204M-Z4
			5.0 A	SU204M-Z5
			6.0 A	SU204M-Z6
			7.0 A	SU204M-Z7
			8.0 A	SU204M-Z8
			10.0 A	SU204M-Z10
			13.0 A	SU204M-Z13
			15.0 A	SU204M-Z15
			16.0 A	SU204M-Z16
			20.0 A	SU204M-Z20
			25.0 A	SU204M-Z25
			30.0 A	SU204M-Z30
			32.0 A	SU204M-Z32
			35.0 A	SU204M-Z35
			40.0 A	SU204M-Z40
		50.0 A	SU204M-Z50	
		60.0 A	SU204M-Z60	
		63.0 A	SU204M-Z63	

SU200MR series

UL489 Branch Circuit Protection



The SU200MR is a high-performance circuit breaker with ring cable lug connections compliant with UL, CSA and IEC standards.

The integrated captive connecting screws simplify the connection of electric lines with extra protection and time saving.

As part of the proven product range System proM compact®, SU200MR can be combined with most of the UL 489 and CSA 22.2 No. 5 approved components.

General Data	SU200MR
Amperage	0.2 up to 63 A
Voltage	480Y/277 V AC
Poles	1, 2, 3, 4
Trip curves	K
Short circuit interrupt rating	10 kA
Auxiliary contacts	Yes
Ambient temperature	-25 ... +55 °C
Mechanical life	20,000 operations
Bell alarm	Yes
Shunt trip	Yes
Undervoltage release	Yes
Busbar	Yes

Features

- UL current limiting
- Fast breaking time (2.3–2.5 ms)
- Bus connection system
- Wide range of accessories
- Available with variable depth handle mechanism
- CE certified and marked
- DIN rail mounting
- Ring terminals
- Finger-safe terminals
- Multi-function terminals
- Suitable for reverse feed
- CSA C22.2 No.5 certified
- UL 489 listed branch circuit protective device
- UL File #E212323

SU200MR (ring terminals) series

K tripping characteristic

1 pole



Box Qty	Weight each (kg)	Rated current	Part number
10	0.140	0.2 A	SU201MR-K0.2
		0.3 A	SU201MR-K0.3
		0.5 A	SU201MR-K0.5
		0.75 A	SU201MR-K0.75
		1.0 A	SU201MR-K1
		1.6 A	SU201MR-K1.6
		2.0 A	SU201MR-K2
		3.0 A	SU201MR-K3
		4.0 A	SU201MR-K4
		5.0 A	SU201MR-K5
		6.0 A	SU201MR-K6
		8.0 A	SU201MR-K8
		10.0 A	SU201MR-K10
		13.0 A	SU201MR-K13
		15.0 A	SU201MR-K15
		16.0 A	SU201MR-K16
		20.0 A	SU201MR-K20
		25.0 A	SU201MR-K25
		30.0 A	SU201MR-K30
32.0 A	SU201MR-K32		
35.0 A	SU201MR-K35		
40.0 A	SU201MR-K40		
50.0 A	SU201MR-K50		
60.0 A	SU201MR-K60		
63.0 A	SU201MR-K63		

2 pole



Box Qty	Weight each (kg)	Rated current	Part number
5	0.280	0.2 A	SU202MR-K0.2
		0.3 A	SU202MR-K0.3
		0.5 A	SU202MR-K0.5
		0.75 A	SU202MR-K0.75
		1.0 A	SU202MR-K1
		1.6 A	SU202MR-K1.6
		2.0 A	SU202MR-K2
		3.0 A	SU202MR-K3
		4.0 A	SU202MR-K4
		5.0 A	SU202MR-K5
		6.0 A	SU202MR-K6
		8.0 A	SU202MR-K8
		10.0 A	SU202MR-K10
		13.0 A	SU202MR-K13
		15.0 A	SU202MR-K15
		16.0 A	SU202MR-K16
		20.0 A	SU202MR-K20
		25.0 A	SU202MR-K25
		30.0 A	SU202MR-K30
32.0 A	SU202MR-K32		
35.0 A	SU202MR-K35		
40.0 A	SU202MR-K40		
50.0 A	SU202MR-K50		
60.0 A	SU202MR-K60		
63.0 A	SU202MR-K63		

3 pole



Box Qty	Weight each (kg)	Rated current	Part number
3	0.420	0.2 A	SU203MR-K0.2
		0.3 A	SU203MR-K0.3
		0.5 A	SU203MR-K0.5
		0.75 A	SU203MR-K0.75
		1.0 A	SU203MR-K1
		1.6 A	SU203MR-K1.6
		2.0 A	SU203MR-K2
		3.0 A	SU203MR-K3
		4.0 A	SU203MR-K4
		5.0 A	SU203MR-K5
		6.0 A	SU203MR-K6
		8.0 A	SU203MR-K8
		10.0 A	SU203MR-K10
		13.0 A	SU203MR-K13
		15.0 A	SU203MR-K15
		16.0 A	SU203MR-K16
		20.0 A	SU203MR-K20
		25.0 A	SU203MR-K25
		30.0 A	SU203MR-K30
32.0 A	SU203MR-K32		
35.0 A	SU203MR-K35		
40.0 A	SU203MR-K40		
50.0 A	SU203MR-K50		
60.0 A	SU203MR-K60		
63.0 A	SU203MR-K63		

4 pole



Box Qty	Weight each (kg)	Rated current	Part number
2	0.560	0.2 A	SU204MR-K0.2
		0.3 A	SU204MR-K0.3
		0.5 A	SU204MR-K0.5
		0.75 A	SU204MR-K0.75
		1.0 A	SU204MR-K1
		1.6 A	SU204MR-K1.6
		2.0 A	SU204MR-K2
		3.0 A	SU204MR-K3
		4.0 A	SU204MR-K4
		5.0 A	SU204MR-K5
		6.0 A	SU204MR-K6
		8.0 A	SU204MR-K8
		10.0 A	SU204MR-K10
		13.0 A	SU204MR-K13
		15.0 A	SU204MR-K15
		16.0 A	SU204MR-K16
		20.0 A	SU204MR-K20
		25.0 A	SU204MR-K25
		30.0 A	SU204MR-K30
32.0 A	SU204MR-K32		
35.0 A	SU204MR-K35		
40.0 A	SU204MR-K40		
50.0 A	SU204MR-K50		
60.0 A	SU204MR-K60		
63.0 A	SU204MR-K63		

S200UDC series

UL489 Branch Circuit Protection (DC)

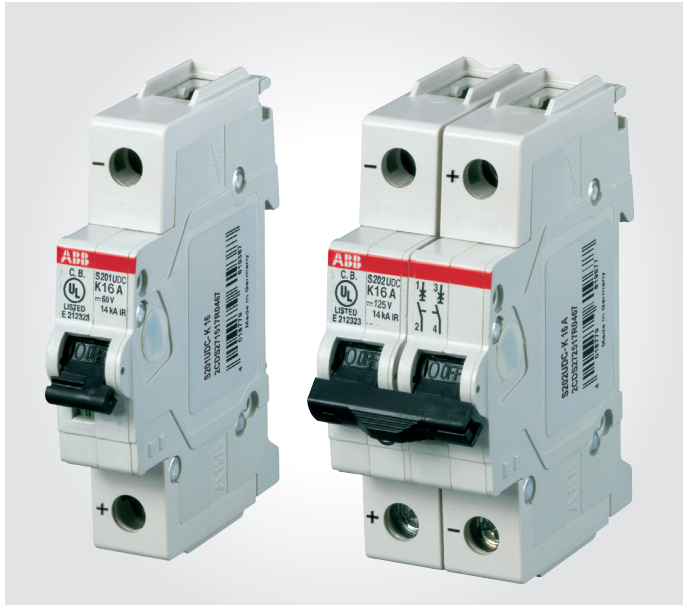

The S200UDC Miniature circuit breaker was designed for DC system in UL489 accordance for 60Vdc and 125Vdc

As part of the proven product range System proM compact®, S200UDC can be combined with most of the UL 489 and CSA 22.2 No. 5 approved components.

General Data	S200UDC
Amperage	1A up to 63 A
Voltage	60 / 125 Vdc
Poles	1, 2
Trip curves	K, Z
Short circuit interrupt rating	14 kA
Auxiliary contacts	Yes
Ambient temperature	-25 ... +55 °C
Mechanical life	20,000 operations
Bell alarm	Yes
Shunt trip	Yes
Undervoltage release	Yes
Busbar	Yes

Features

- UL current limiting
- Fast breaking time (2.3–2.5 ms)
- Bus connection system
- Wide range of accessories
- Available with variable depth handle mechanism
- CE certified and marked
- DIN rail mounting
- Ring terminals
- Finger-safe terminals
- Multi-function terminals
- Suitable for reverse feed
- CSA C22.2 No.5 certified
- UL 489 listed branch circuit protective device
- UL File #E212323

S200UDC series

K tripping characteristic

1 pole	Box Qty	Weight each (kg)	Rated current	Part number
	10	0.150	1.0 A	S201UDC-K1
			1.6 A	S201UDC-K1.6
			2.0 A	S201UDC-K2
			3.0 A	S201UDC-K3
			4.0 A	S201UDC-K4
			5.0 A	S201UDC-K5
			6.0 A	S201UDC-K6
			8.0 A	S201UDC-K8
			10.0 A	S201UDC-K10
			13.0 A	S201UDC-K13
			15.0 A	S201UDC-K15
			16.0 A	S201UDC-K16
			20.0 A	S201UDC-K20
			25.0 A	S201UDC-K25
			30.0 A	S201UDC-K30
			32.0 A	S201UDC-K32
			40.0 A	S201UDC-K40
			50.0 A	S201UDC-K50
			60.0 A	S201UDC-K60
63.0 A	S201UDC-K63			

2 poles	Box Qty	Weight each (kg)	Rated current	Part number
	5	0.300	1.0 A	S202UDC-K1
			1.6 A	S202UDC-K1.6
			2.0 A	S202UDC-K2
			3.0 A	S202UDC-K3
			4.0 A	S202UDC-K4
			5.0 A	S202UDC-K5
			6.0 A	S202UDC-K6
			8.0 A	S202UDC-K8
			10.0 A	S202UDC-K10
			13.0 A	S202UDC-K13
			15.0 A	S202UDC-K15
			16.0 A	S202UDC-K16
			20.0 A	S202UDC-K20
			25.0 A	S202UDC-K25
			30.0 A	S202UDC-K30
			32.0 A	S202UDC-K32
			40.0 A	S202UDC-K40
			50.0 A	S202UDC-K50
			60.0 A	S202UDC-K60
63.0 A	S202UDC-K63			

S200UDC series

Z tripping characteristic



1 pole	Box Qty	Weight each (kg)	Rated current	Part number
	10	0.150	1.0 A	S201UDC-Z1
			1.6 A	S201UDC-Z1.6
			2.0 A	S201UDC-Z2
			3.0 A	S201UDC-Z3
			4.0 A	S201UDC-Z4
			5.0 A	S201UDC-Z5
			6.0 A	S201UDC-Z6
			8.0 A	S201UDC-Z8
			10.0 A	S201UDC-Z10
			13.0 A	S201UDC-Z13
			15.0 A	S201UDC-Z15
			16.0 A	S201UDC-Z16
			20.0 A	S201UDC-Z20
			25.0 A	S201UDC-Z25
			30.0 A	S201UDC-Z30
			32.0 A	S201UDC-Z32
			40.0 A	S201UDC-Z40
			50.0 A	S201UDC-Z50
			60.0 A	S201UDC-Z60
63.0 A	S201UDC-Z63			

2 poles	Box Qty	Weight each (kg)	Rated current	Part number
	5	0.300	1.0 A	S202UDC-Z1
			1.6 A	S202UDC-Z1.6
			2.0 A	S202UDC-Z2
			3.0 A	S202UDC-Z3
			4.0 A	S202UDC-Z4
			5.0 A	S202UDC-Z5
			6.0 A	S202UDC-Z6
			8.0 A	S202UDC-Z8
			10.0 A	S202UDC-Z10
			13.0 A	S202UDC-Z13
			15.0 A	S202UDC-Z15
			16.0 A	S202UDC-Z16
			20.0 A	S202UDC-Z20
			25.0 A	S202UDC-Z25
			30.0 A	S202UDC-Z30
			32.0 A	S202UDC-Z32
			40.0 A	S202UDC-Z40
			50.0 A	S202UDC-Z50
			60.0 A	S202UDC-Z60
63.0 A	S202UDC-Z63			



Accessories

Electrical accessories

Auxiliary contacts and bell alarms

	Description	Part number
	<p>Auxiliary contact (1 form C)</p> <p>The auxiliary contacts will signal whether the breaker is in the ON or OFF position. Mounts on the right side of the breaker up to maximum of 3 sets</p>	S2C-H6RU
	<p>Bell alarm contact (1 form C)</p> <p>The bell alarm includes a set of contacts that will only signal when the breaker has tripped. It also includes a test button for testing the alarm contacts without opening the breaker. Mounts on the right side of the breaker up to a maximum of 3 sets</p>	S2C-S6RU

Shunt trip

	Description	Part number
	<p>12...60 Vac/dc Shunt trip</p> <p>For remote tripping of the breaker, a shunt trip device can be added onto the MCB. The solenoid device opens the breaker after a control voltage is applied. Mounts on the right side of the MCB and can be mixed with auxiliary contacts</p>	S2C-A1U
	<p>110...415 Vac (110...250 Vdc) Shunt trip</p> <p>For remote tripping of the breaker, a shunt trip device can be added onto the MCB. The solenoid device opens the breaker after a control voltage is applied. Mounts on the right side of the MCB and can be mixed with auxiliary contacts</p>	S2C-A2U

Possible mounting arrangements of electrical accessories

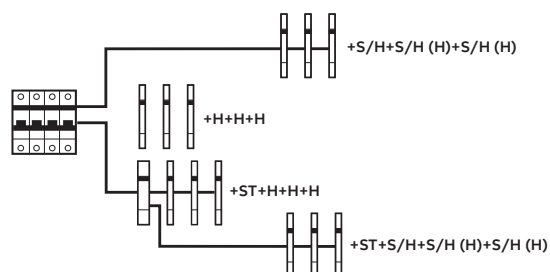

Accessories



Electrical accessories

Busbars for SU200M (uncuttable)



Amp rating	Phase	Nbr of pins	Busbar length (mm)	Part number
80 / 115 A	1	6	103.2	PS 1/6/16BP
		12	208.8	PS 1/12/16BP
		18	314.4	PS 1/18/16BP
	2	6	103.2	PS 2/6/16BP
		12	208.8	PS 2/12/16BP
		18	314.4	PS 2/18/16BP
	3	6	103.2	PS 3/6/16BP
		12	208.8	PS 3/12/16BP
		18	314.4	PS 3/18/16BP

Accessories for busbars (uncuttable)

Description	Part number
 <p>Busbar pin covers (covers 3 unused pins)</p>	BSK-BP
 <p>Insulated feeder terminal with pin contact (breaker mounting)</p>	AST35/15BP
 <p>Single pole feeder terminal (busbar mounting)</p>	SZ-ESKBP

Accessories

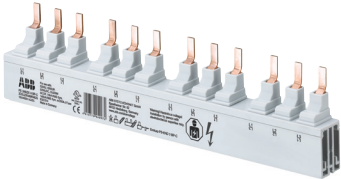
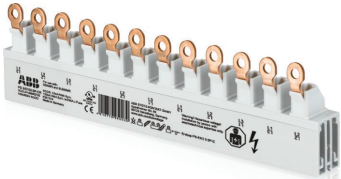

Electrical accessories

Busbars for SU200M and SU200MR (cuttable, end caps not included)

	Used with	Phase	Nbr of pins	Phase sequence	Part number
	SU200M	1	57	L1-L1-L1...	PS 1/57/25 BP-C
			37	L1-AUX-L1-AUX... ⁽¹⁾	PS 1/37/25 H BP-C
		2	56	L1-L2-L1-L2...	PS 2/56/25 BP-C
			46	L1-L2-AUX-L1-L2-AUX... ⁽¹⁾	PS 2/46/25 H BP-C
		3	57	L1-L2-L3-L1-L2-L3...	PS 3/57/25 BP-C
			48	L1-L2-L3-AUXL1-L2-L3-AUX... ⁽¹⁾	PS 3/48/25 H BP-C
	SU200MR	1	57	L1-L1-L1...	PS 1/57/25 BP-CR
			37	L1-AUX-L1-AUX... ⁽¹⁾	PS 1/37/25 H BP-CR
		2	56	L1-L2-L1-L2...	PS 2/56/25 BP-CR
			46	L1-L2-AUX-L1-L2-AUX... ⁽¹⁾	PS 2/46/25 H BP-CR
		3	57	L1-L2-L3-L1-L2-L3...	PS 3/57/25 BP-CR
			48	L1-L2-L3-AUXL1-L2-L3-AUX... ⁽¹⁾	PS 3/48/25 H BP-CR
			39	L1-AUX-L2-AUX-L3-AUX... ⁽¹⁾	PS 3/39/25 H BP-CR

⁽¹⁾ For devices with auxiliary contact(half module) after each phase sequence

Accessories for busbars (cuttable)

	Used with	Description	Part number
	Both	Busbar end cap (mandatory, not included with busbar) covers busbar endings.	PS-END 3 BP-C
	SU200M	Busbar pin cover (covers 3 unused pins)	BSK BP-C
	SU200MR	Busbar pin cover (covers 3 unused pins)	BSK BP-CR
	SU200M	Single pole feeder terminal (busbar mounting)	AST 35/58 BP-C

Accessories

Mechanical accessories

Rotary handle mechanism



Description	Part number
External handle rotary drive. For the actuation of 2, 3 or 4 pole miniature circuit breakers. To be used with 5 or 6 mm ² shafts	S2C-DH

External handles



Description	Color	With defeater	Part number
Type 3R/12 selector handle, padlockable with maximum 3 padlocks (bail diameter 5...8mm) with door interlock in ON position. Available with defeating option to allow the MCB to stay in ON state when opening the door.	Black	Yes	OHBS2AJ
		No	OHBS2AJ1
	Yellow-Red	Yes	OHYS2AJ
		No	OHYS2AJ1
	Silver	Yes	OHSS2AJ
		No	OHSS2AJ1
	Grey	Yes	OHGS2AJ
		No	OHGS2AJ1

Shafts

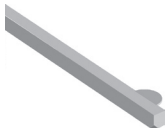

Description	Length	Part number
Shaft extensions to be used with selector typ handles. Shafts are cuttable. 6 mm ² diameter	85 mm	OXS6X85
	105 mm	OXS6X105
	120 mm	OXS6X120
	130 mm	OXS6X130
	160 mm	OXS6X160
	180 mm	OXS6X180
	250 mm	OXS6X250
	330 mm	OXS6X330

Accessories

Mechanical accessories

Locking devices (lock out / tag out)

Description	Used with	Part number
 Lock out / Tag out adaptor device, removable	1 pole devices	S2C-LOTO-S
	2, 3, 4 pole devices	S2C-LOTO-M

False pole

Description	Used with	Part number
 Used to fill empty spaces on DIN rails (one of each is required)	False pole (1)	FP1
	DIN rail support for false pole	SFP

Front flange mounting kits

Description	Nbr of MCBs	Part number
 Front flange mounting kit	1	ME1-1
	2	ME2-2
	3	ME3-3
	4	ME4-4
	6	ME6-6
	8	ME8-8

Technical details

SU200M (R) and S200UDC series

Technical specifications MCBs

	SU200M	SU200MR	S200UDC
Specifications	CSA C22.2 No.5 UL489 IEC 60947-2	CSA C22.2 No.5 UL489 IEC 60947-2	CSA C22.2 No.5 UL489 VDE 0660
UL file number	E 212323, current limiting	E 212323, current limiting	E 212323
Nbr of poles	1, 2, 3, 4	1, 2, 3, 4	1,2
Trip curves	C, K, Z	K	K, Z
Amperage	0.2...63 A	0.2...63 A	1...63 A
Voltage AC	(1)	(1)	-
Voltage DC (1p/2p)	48/96 Vdc	-	60/125 Vdc
Interrupt rating	10 kA	10 kA	14 kA
Calibration temp	40°C	40°C	25°C
Mounting position	Any	Any	Any
Protection degree	IP20	IP20	IP20
Mounting	35 mm DIN rail	35 mm DIN rail	35 mm DIN rail
Tightening torque	25 in-lbs 2.8Nm	25 in-lbs 2.8Nm	25 in-lbs 2.8Nm
Terminal wire size	16...4 AWG	16...4 AWG	16...4 AWG
Ambient temperature	-25°C...+55°C -13°F...+131°F	-25°C...+55°C -13°F...+131°F	-25°C...+55°C -13°F...+131°F
Shock resistance (IEC60068-2-27)	25g - 2 shocks - 13ms	25g - 2 shocks - 13ms	25g - 2 shocks - 13ms
Mechanical life	20,000 ops	20,000 ops	20,000 ops

(1)	Amperage range	Max. Voltage
SU200M-C	0.5...40 A	480Y / 277 Vac
	50...63 A	240 Vac
SU200M-K	0.2...35 A	480Y / 277 Vac
SU200MR-K	40...63 A	240 Vac
SU200M-Z	0.5...40 A	480Y / 277 Vac
	50...63 A	240 Vac
All types	All range	240 Vac

Technical details

SU200M (R) and S200UDC series

Internal resistance and power loss per pole (SU200M/SU200MR)

Rated current (A)	C and K tripping characteristics		Z tripping characteristic	
	Internal resistance ⁽¹⁾ (mΩ)	Power loss (W)	Internal resistance ⁽¹⁾ (mΩ)	Power loss (W)
0.2	42500 / 25300	1.7 / 1.01	-	-
0.3	18889 / 13700	1.7 / 1.23	-	-
0.5	5600 / 4740	1.4 / 1.19	9000	2.3
0.75	2489 / 2067	1.4 / 1.16	-	-
1	1400 / 1270	1.4 / 1.27	2200	2.2
1.6 (1.5 for SU200MR)	703 / 610	1.8 / 1.56	1000	2.6
2	450 / 442	1.8 / 1.77	650	2.6
3	178 / 140	1.6 / 1.26	250	2.3
4	113 / 109	1.8 / 1.75	140	2.2
5	50 / 50	1.31 / 1.26	100	2.5
6	56 / 54	2.0 / 1.94	70	2.5
8	23 / 22	1.5 / 1.41	28	1.8
10	21 / 18.2	2.1 / 1.82	21	2.1
13	14 / 14.8	2.3 / 2.5	17	2.9
15	11 / 8.1	2.4 / 1.83	13	2.9
16	9.8 / 11.1	2.5 / 2.83	10	2.6
20	6.3 / 8.5	2.5 / 3.40	6.5	2.6
25	5.1 / 5.5	3.2 / 3.43	5.1	3.2
30	3.9 / 3.8	3.5 / 3.39	3.9	3.5
32	3.6 / 4.6	3.7 / 4.70	3.6	3.7
35	3.3 / 3.9	4.1 / 4.76	3.3	4.1
40	2.8 / 2.8	4.54 / 4.40	2.8	4.5
50	1.8 / 1.7	4.5 / 4.25	1.8	4.5
60	1.4 / 1.7	4.9 / 6.18	1.4	4.9
63	1.4 / 1.9	5.4 / 7.56	1.4	5.4

⁽¹⁾ Internal resistances are subject to application-specific and environment-specific conditions and are therefore to be considered as typical values

Technical details

SU200M (R) and S200UDC series

Temperature derating (SU200M and SU200MR)

Standard	Rated current (A)	Maximum operating current(A) at ambient temperature T											
		- 40 °C	- 30 °C	- 20 °C	- 10 °C	0 °C	10 °C	20 °C	30 °C	40 °C	50 °C	60 °C	70 °C
UL489	0.2 ⁽¹⁾	0.27	0.26	0.25	0.24	0.23	0.22	0.22	0.21	0.2	0.19	0.19	0.18
	0.3 ⁽¹⁾	0.40	0.39	0.37	0.36	0.35	0.33	0.32	0.31	0.3	0.29	0.28	0.27
	0.5	0.67	0.64	0.62	0.60	0.58	0.56	0.54	0.52	0.5	0.48	0.46	0.45
	0.75 ⁽¹⁾	1.00	0.97	0.93	0.90	0.87	0.84	0.81	0.78	0.75	0.72	0.70	0.67
	1	1.34	1.29	1.24	1.20	1.16	1.12	1.08	1.04	1	0.96	0.93	0.89
	1.6	1.74	1.68	1.62	1.56	1.50	1.45	1.40	1.35	1.3	1.25	1.21	1.16
	2	2.67	2.58	2.49	2.40	2.31	2.23	2.15	2.07	2	1.93	1.85	1.79
	3	4.01	3.87	3.73	3.60	3.47	3.35	3.23	3.11	3	2.89	2.78	2.68
	4	5.35	5.16	4.97	4.80	4.63	4.46	4.30	4.15	4	3.85	3.71	3.57
	5	6.69	6.45	6.22	6.00	5.78	5.58	5.38	5.19	5	4.82	4.64	4.47
	6	8.02	7.74	7.46	7.20	6.94	6.69	6.45	6.22	6	5.78	5.56	5.36
	8	10.70	10.32	9.95	9.59	9.25	8.92	8.60	8.30	8	7.70	7.42	7.14
	10	13.37	12.90	12.44	11.99	11.56	11.15	10.75	10.37	10	9.63	9.27	8.93
	13	17.38	16.76	16.17	15.59	15.03	14.50	13.98	13.48	13	12.52	12.06	11.61
	15	20.06	19.34	18.65	17.99	17.35	16.73	16.13	15.56	15	14.45	13.91	13.40
	16	21.40	20.63	19.90	19.19	18.50	17.84	17.21	16.59	16	15.41	14.84	14.29
	20	26.75	25.79	24.87	23.98	23.13	22.30	21.51	20.74	20	19.26	18.55	17.86
25	33.43	32.24	31.09	29.98	28.91	27.88	26.88	25.93	25	24.08	23.18	22.33	
30	40.12	38.69	37.31	35.98	34.69	33.45	32.26	31.11	30	28.89	27.82	26.79	
32	42.79	41.27	39.79	38.37	37.01	35.69	34.41	33.18	32	30.82	29.68	28.58	
35	46.81	45.14	43.53	41.97	40.47	39.03	37.64	36.30	35	33.71	32.46	31.26	
40	53.49	51.58	49.74	47.97	46.26	44.61	43.01	41.48	40	38.52	37.09	35.72	
50	66.87	64.48	62.18	59.96	57.82	55.76	53.77	51.85	50	48.15	46.37	44.65	
60	80.24	77.38	74.61	71.95	69.39	66.91	64.52	62.22	60	57.78	55.64	53.58	
63	84.25	81.24	78.35	75.55	72.85	70.25	67.75	65.33	63	60.67	58.42	56.26	

(1) Amperages available with K characteristic only

Multiple devices correction factor (multiply the correction factor in the table on the nominal value of each devices)

Nbr of adjacent devices	Correction factor
1	-
2...3	0.9
4...5	0.8
> 6	0.75

Technical details

Electrical accessories

Technical specifications auxiliary contacts

	S2C-H6RU	S2C-S6RU
Amperage	10 A	10 A
Voltage	24 Vac/dc	24 Vac/dc
Contact type	Dry SPDT (form C)	Dry SPDT (form C)
Terminal wire capacity	#18...14 AWG	#18...14 AWG
Installation / wiring	See below	See below
Tightening torque	11 in-lbs 1.2Nm	11 in-lbs 1.2 Nm
Shock resistance (DIN IEC 68-2-6)	5g , 20 cycles (5...150...5 Hz) at 24 Vac/dc, 5mA auto-reclosing < 10 ms	5g , 20 cycles (5...150...5 Hz) at 24 Vac/dc, 5mA auto-reclosing < 10 ms
Mechanical life	10,000 ops	10,000 ops

Connection drawings and installation

Auxiliary contact S2C-H6RU

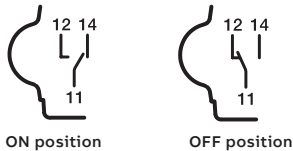

Mounting instruction of S2C-H6RU

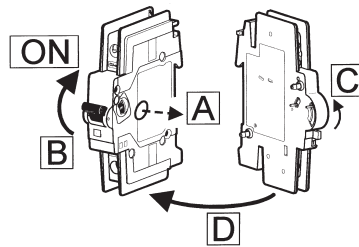

Procedure

- | | |
|---|------------------------------------|
| A | Remove coupling cover on the right |
| B | Circuit breaker in ON position |
| C | Auxiliary contact in ON position |
| D | Assemble switches |

Bell alarm contact S2C-S6RU

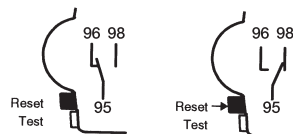
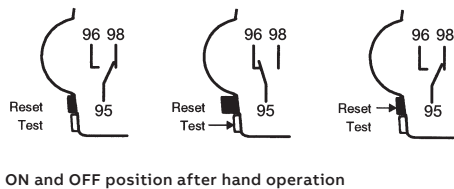

Mounting instruction of S2C-S6RU

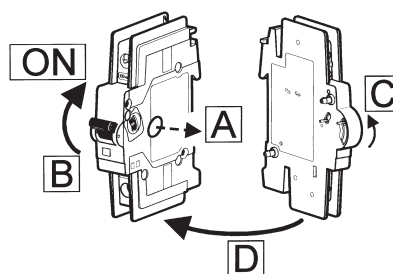

Procedure

- | | |
|---|------------------------------------|
| A | Remove coupling cover on the right |
| B | Circuit breaker in ON position |
| C | Auxiliary contact in ON position |
| D | Assemble switches |

Technical details

Electrical accessories

Technical specifications shunt trips

	S2C-A1U	S2C-A2U
Voltage AC	12...60 V	110...415 V
Voltage DC	12...60 V	110...250 V
Maximum release duration	< 10 ms	< 10 ms
Minimum release voltage AC	7 V	55 V
Minimum release voltage DC	10 V	80 V
Consumption on release AC	40...200 VA	55...210 VA
Consumption on release DC	40...200 VA	55...110 VA
Coil resistance	3.7 Ω	225 Ω
Installation / wiring	See below	See below
Terminal wire capacity	#18...6 AWG	#18...6 AWG
Tightening torque	18 in-lbs 2 Nm	18 in-lbs 2 Nm

Connection drawings and installation

Shunt trip S2C-A...U

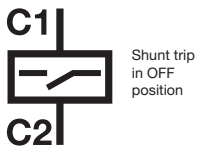

Mounting instruction of S2C-A...U

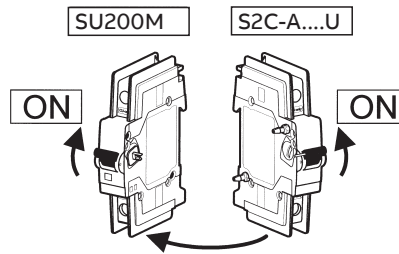

Technical details

Electrical accessories

Technical specifications busbars (Electrical)

	PS...BP-C / PS...BP-CR
Standards	UL508, EN 60947-1 / IEC 60947-1:2004
Rated voltage	600 Vac/dc
Rated frequency	50 Hz (IEC) / 60 Hz (UL/CSA)
Rated impulse withstand voltage	≥ 10kV
Rated current ⁽¹⁾	100 A (200A center-fed)
Short circuit current rating (SCCR)	10 kA 3 cycles @ 600V / 140 kA Fuse class J 200A

(1) Independently from the current rating of the feeder terminal or busbar, the current-carrying capacity/current rating of the MCB terminal must not be exceeded.

Technical specifications busbars (mechanical)

	PS...BP-C / PS...BP-CR
Housing	UL508, EN 60947-1 / IEC 60947-1:2004
Resistance to climatic conditions	According to DIN EN 60068
Overvoltage category	III
Pollution degree	2

Technical specifications busbars (installation)

	PS...BP-C / PS...BP-CR
Cross section	25 mm ²
Mounting position	Optional
Supply	Via cable with ring tongue (PS...BP-CR) direct or via feeder terminal (PS...BP-C)

Technical specifications busbars (accessories)

	PS...BP-C / PS...BP-CR
Shock protection caps	BSK BP-C (PS...BP-C) or BSK BP-CR (PS...BP-CR)
End caps	Via cable with ring tongue (PS...BP-CR) direct or via feeder terminal (PS...BP-C)

Technical specifications busbars (approvals)

	PS...BP-C / PS...BP-CR
UL508, cULus listed	
CE, RoHS	

Tripping curves details

C tripping curve

Description

The "C" time-current curve is designed for medium magnetic start-up currents. Instantaneous tripping occurs between 5 and 10 times rated current in 50/60 Hz systems.

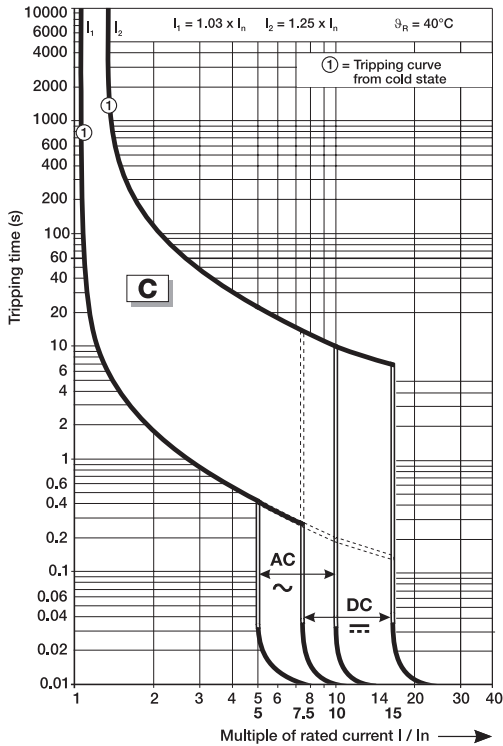

Standard	Thermal release ⁽¹⁾		Magnetic release ⁽²⁾	
	Value	Tripping time	Range of instantaneous trip	Tripping time
UL489	Conventional non-tripping current I1	1.03 x In	> 1 hr	> 0.2 s
	Conventional tripping current I2	1.25 x In	< 1 hr ⁽³⁾	< 0.2 s

⁽¹⁾ The thermal releases are calibrated to a nominal reference ambient temperature e.g. for UL489 of 40°C. In the case of higher ambient temperature, the current values fall by approx. 4% for each 10 K temperature rise.

⁽²⁾ The indicated tripping value of electromagnetic tripping devices apply to a frequency of 50/60Hz. The thermal release operated independent of frequency.

⁽³⁾ As from operating temperature (after I1 > 1 hr)

Tripping curves details

K tripping curve

Description

The "K" time-current characteristic considers high magnetic start-up currents from motors, transformers and other equipment. Instantaneous tripping occurs between 8 and 12 times rated current in 50/60Hz systems. The "K" characteristic is available up through 63 amperes.

The "K" curve offers the best protection for the broadest range of electrical systems. The higher magnetic trip settings maximizes protection while allowing for higher in-rush currents during system start-up.

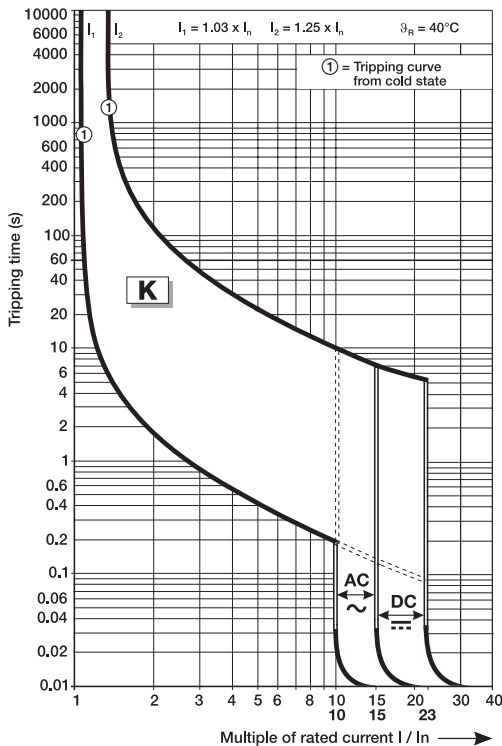

Standard	Thermal release ⁽¹⁾		Magnetic release ⁽²⁾		
	Value	Tripping time	Range of instantaneous trip	Tripping time	
UL489	Conventional non-tripping current I1	$1.03 \times I_n$	> 1 hr	$10 \times I_n$	> 0.2 s
	Conventional tripping current I2	$1.25 \times I_n$	< 1 hr ⁽³⁾	$14 \times I_n$	< 0.2 s

⁽¹⁾ The thermal releases are calibrated to a nominal reference ambient temperature e.g. for UL489 of 40°C. In the case of higher ambient temperature, the current values fall by approx. 4% for each 10 K temperature rise.

⁽²⁾ The indicated tripping value of electromagnetic tripping devices apply to a frequency of 50/60Hz. The thermal release operated independent of frequency.

⁽³⁾ As from operating temperature (after I1 > 1 hr)

Tripping curves details

Z tripping curve

Description

The "Z" characteristic offers instantaneous tripping between 2 and 3 times rated current in 50/60Hz systems.

Many applications require a very low short circuit trip settings in order to protect semiconductor or other sensitive devices and the "Z" trip characteristic may provide maximum protection and service in these applications.

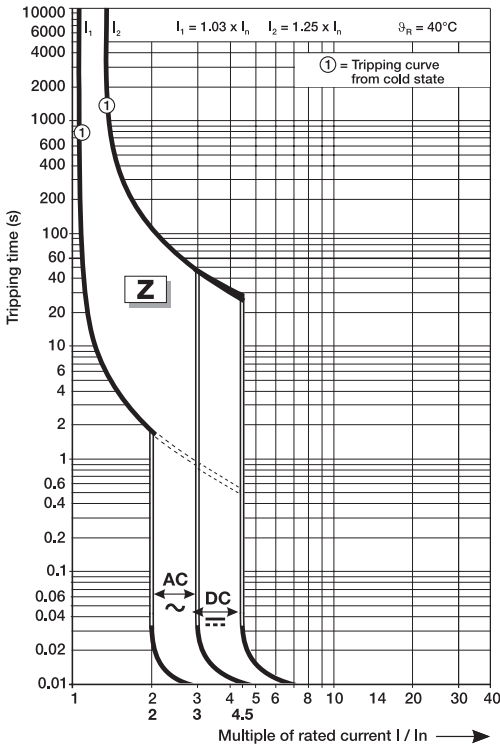

Standard	Thermal release ⁽¹⁾		Magnetic release ⁽²⁾		
	Value	Tripping time	Range of instantaneous trip	Tripping time	
UL489	Conventional non-tripping current I1	1.03 x In	> 1 hr	2 x In	> 0.2 s
	Conventional tripping current I2	1.25 x In	< 1 hr ⁽³⁾	3 x In	< 0.2 s

⁽¹⁾ The thermal releases are calibrated to a nominal reference ambient temperature e.g. for UL489 of 40°C. In the case of higher ambient temperature, the current values fall by approx. 4% for each 10 K temperature rise.

⁽²⁾ The indicated tripping value of electromagnetic tripping devices apply to a frequency of 50/60Hz. The thermal release operated independent of frequency.

⁽³⁾ As from operating temperature (after I1 > 1 hr)

Tripping curves details

K tripping curve (S200UDC)

Description

The "K" time-current characteristic for S200UDC was specifically designed to offer instantaneous tripping between 14 and 25 times rated current in DC systems.

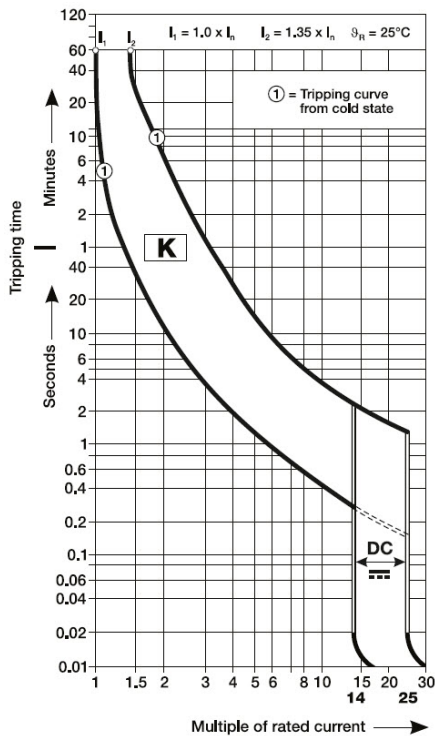

Standard	Thermal release ⁽¹⁾		Magnetic release	
	Value	Tripping time	Range of instantaneous trip	Tripping time
UL489	Conventional non-tripping current I1	1.0 x I _n	> 1 hr	> 0.2 s
	Conventional tripping current I2	1.35 x I _n	< 1 hr ⁽³⁾	< 0.2 s

⁽¹⁾ The thermal releases are calibrated to a nominal reference ambient temperature e.g. for UL489 of 40°C. In the case of higher ambient temperature, the current values fall by approx. 4% for each 10 K temperature rise.

⁽³⁾ As from operating temperature (after I1 > 1 hr)

Tripping curves details

Z tripping curve (S200UDC)

Description

The "Z" time-current characteristic for S200UDC was specifically designed to offer fast instantaneous tripping between 3 and 6 times rated current in DC systems.

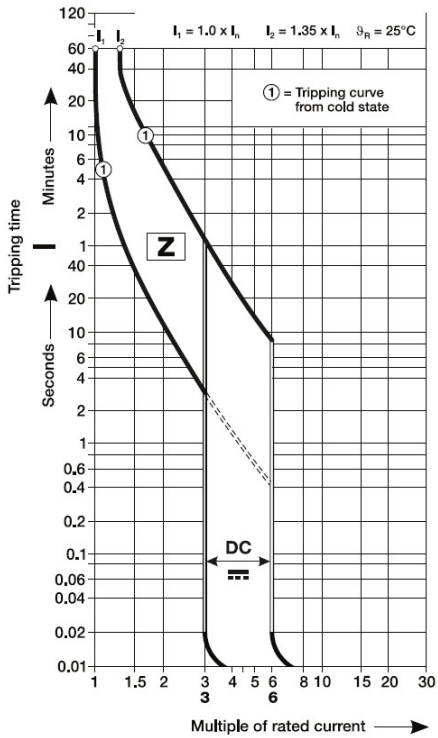

Standard	Thermal release ⁽¹⁾		Magnetic release	
	Value	Tripping time	Range of instantaneous trip	Tripping time
UL489	Conventional non-tripping current I1	1.00 x In	> 1 hr	> 2 s
	Conventional tripping current I2	1.35 x In	< 1 hr ⁽³⁾	< 2 s

⁽¹⁾ The thermal releases are calibrated to a nominal reference ambient temperature e.g. for UL489 of 40°C. In the case of higher ambient temperature, the current values fall by approx. 4% for each 10 K temperature rise.

⁽³⁾ As from operating temperature (after I1 > 1 hr)

Dimensions

SU200M and S200UDC series

SU200M approximate dimensions

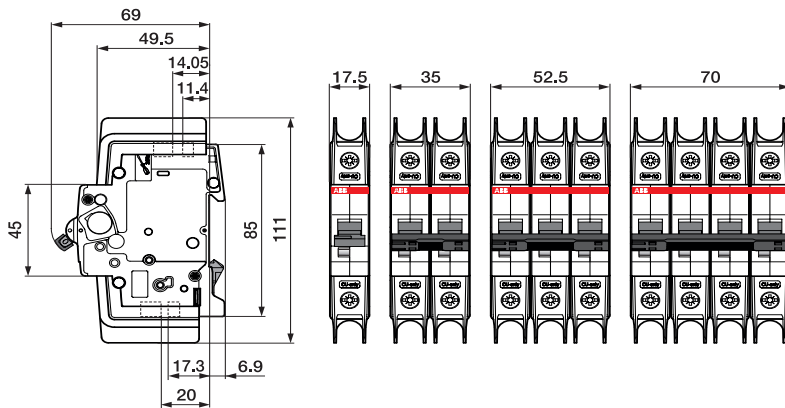

SU200MR approximate dimensions

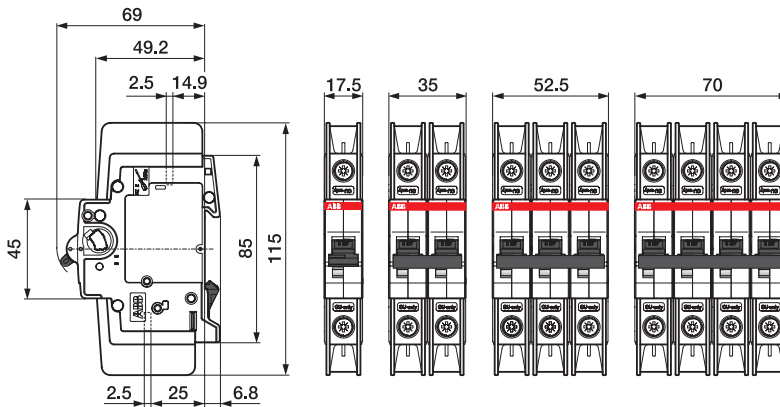

S200UDC approximate dimensions

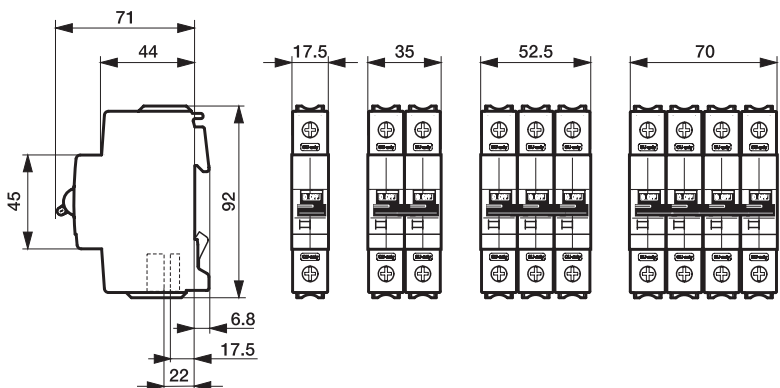

Dimensions

Accessories and busbars

S2C-H6RU, S2C-S6RU approximate dimensions

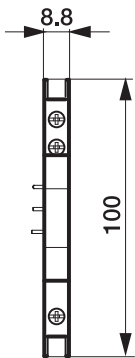

S2C-A1U, S2C-A2U approximate dimensions

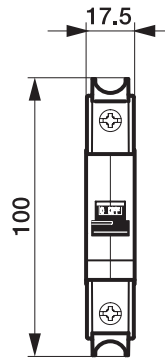

PS...BP-C, PS...BP-CR approximate dimensions

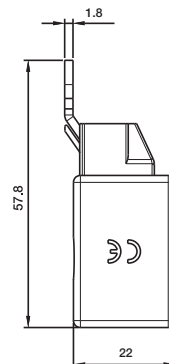
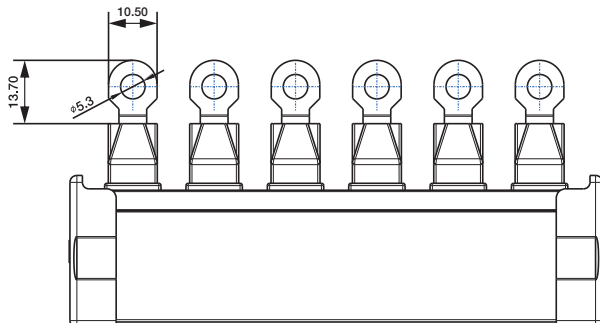
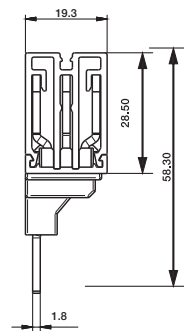
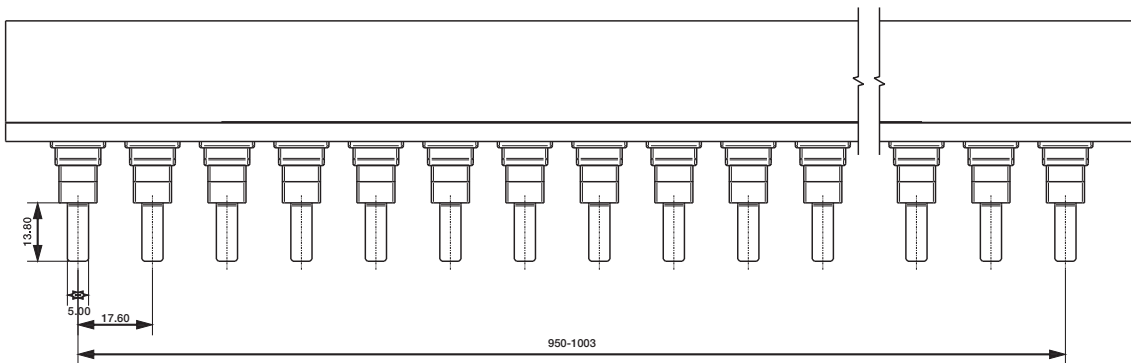

S800U series

UL489 Branch Circuit Protection

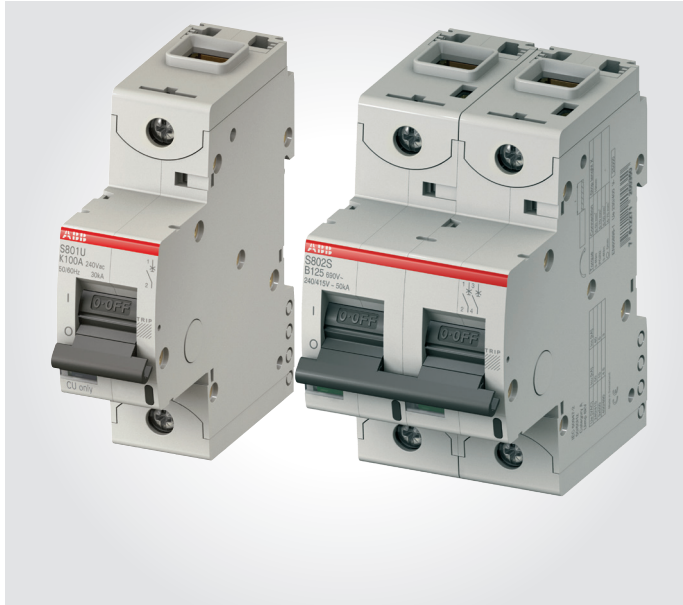

The S800U high performance MCB offers a compact solution to circuit protection.

The S800U devices are DIN rail mounted and available with application-specific trip characteristics to provide maximum circuit protection.

Designed specifically for 240Vac system requiring a high interrupting capability.

General Data	S800U
Amperage	10A up to 100 A
Voltage	240 V AC
Poles	1, 2, 3, 4
Trip curves	K, Z
Short circuit interrupt rating	30 (1p) / 50 kA (2,3,4p)
Auxiliary contacts	Yes
Ambient temperature	-25 ... +55 °C
Mechanical life	4,000 operations
Bell alarm	Yes
Shunt trip	Yes
Undervoltage release	Yes
TErminals	Interchangeable (RT / cage)

Features

- Energy limiting
- Fast breaking time (2.3–2.5 ms)
- Wide range of accessories
- DIN rail mounting
- Finger-safe terminals
- Multi-function terminals
- Ring tongue compatible
- CSA C22.2 No 5 certified
- UL 489 File #E312425

S800U series

K tripping characteristic (240Vac)

1 pole

	Box Qty	Weight each (kg)	Rated current	Part number
	1	0.245	10.0 A	S801U-K10
			15.0 A	S801U-K15
			20.0 A	S801U-K20
			25.0 A	S801U-K25
			30.0 A	S801U-K30
			40.0 A	S801U-K40
			50.0 A	S801U-K50
			60.0 A	S801U-K60
			70.0 A	S801U-K70
			80.0 A	S801U-K80
			90.0 A	S801U-K90
		100.0 A	S801U-K100	

2 poles

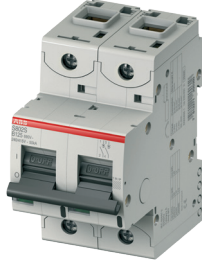
	Box Qty	Weight each (kg)	Rated current	Part number
	1	0.490	10.0 A	S802U-K10
			15.0 A	S802U-K15
			20.0 A	S802U-K20
			25.0 A	S802U-K25
			30.0 A	S802U-K30
			40.0 A	S802U-K40
			50.0 A	S802U-K50
			60.0 A	S802U-K60
			70.0 A	S802U-K70
			80.0 A	S802U-K80
			90.0 A	S802U-K90
		100.0 A	S802U-K100	

3 poles

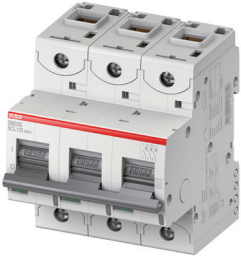
	Box Qty	Weight each (kg)	Rated current	Part number
	1	0.735	10.0 A	S803U-K10
			15.0 A	S803U-K15
			20.0 A	S803U-K20
			25.0 A	S803U-K25
			30.0 A	S803U-K30
			40.0 A	S803U-K40
			50.0 A	S803U-K50
			60.0 A	S803U-K60
			70.0 A	S803U-K70
			80.0 A	S803U-K80
			90.0 A	S803U-K90
		100.0 A	S803U-K100	

4 poles

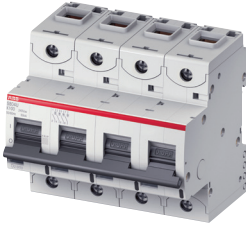
	Box Qty	Weight each (kg)	Rated current	Part number
	1	0.980	10.0 A	S804U-K10
			15.0 A	S804U-K15
			20.0 A	S804U-K20
			25.0 A	S804U-K25
			30.0 A	S804U-K30
			40.0 A	S804U-K40
			50.0 A	S804U-K50
			60.0 A	S804U-K60
			70.0 A	S804U-K70
			80.0 A	S804U-K80
			90.0 A	S804U-K90
		100.0 A	S804U-K100	

S800U series

Z tripping characteristic (240Vac)

1 pole



Box Qty	Weight each (kg)	Rated current	Part number
1	0.245	10.0 A	S801U-Z10
		15.0 A	S801U-Z15
		20.0 A	S801U-Z20
		25.0 A	S801U-Z25
		30.0 A	S801U-Z30
		40.0 A	S801U-Z40
		50.0 A	S801U-Z50
		60.0 A	S801U-Z60
		70.0 A	S801U-Z70
		80.0 A	S801U-Z80
		90.0 A	S801U-Z90
100.0 A	S801U-Z100		

2 poles

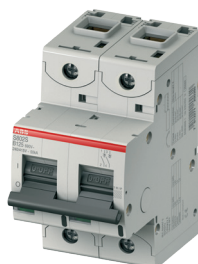

Box Qty	Weight each (kg)	Rated current	Part number
1	0.490	10.0 A	S802U-Z10
		15.0 A	S802U-Z15
		20.0 A	S802U-Z20
		25.0 A	S802U-Z25
		30.0 A	S802U-Z30
		40.0 A	S802U-Z40
		50.0 A	S802U-Z50
		60.0 A	S802U-Z60
		70.0 A	S802U-Z70
		80.0 A	S802U-Z80
		90.0 A	S802U-Z90
100.0 A	S802U-Z100		

3 poles

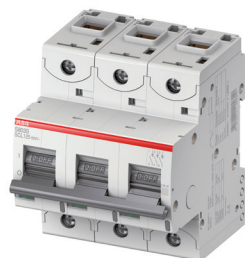

Box Qty	Weight each (kg)	Rated current	Part number
1	0.735	10.0 A	S803U-Z10
		15.0 A	S803U-Z15
		20.0 A	S803U-Z20
		25.0 A	S803U-Z25
		30.0 A	S803U-Z30
		40.0 A	S803U-Z40
		50.0 A	S803U-Z50
		60.0 A	S803U-Z60
		70.0 A	S803U-Z70
		80.0 A	S803U-Z80
		90.0 A	S803U-Z90
100.0 A	S803U-Z100		

4 poles

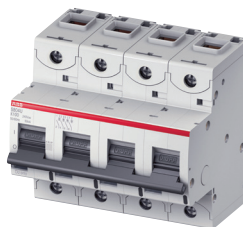

Box Qty	Weight each (kg)	Rated current	Part number
1	0.980	10.0 A	S804U-Z10
		15.0 A	S804U-Z15
		20.0 A	S804U-Z20
		25.0 A	S804U-Z25
		30.0 A	S804U-Z30
		40.0 A	S804U-Z40
		50.0 A	S804U-Z50
		60.0 A	S804U-Z60
		70.0 A	S804U-Z70
		80.0 A	S804U-Z80
		90.0 A	S804U-Z90
100.0 A	S804U-Z100		



Notes

A series of horizontal dotted lines for taking notes.

S804U-UCZ and PVS5 series

UL489 Branch Circuit Protection



The S804U-UCZ high performance MCB offers a compact solution to circuit protection in 600Vdc systems

It is available as 4-pole version with a short-circuit current rating of 10 kA according to UL 489.

General Data	S800U
Amperage	10A up to 80 A
Voltage	600 Vdc
Poles	4p in series
Trip curves	Z
Short circuit interrupt rating	10 kA
Auxiliary contacts	-
Ambient temperature	-25 ... +60 °C
Bell alarm	-
Shunt trip	-
Undervoltage release	-
TErminals	Cage (compression)

Features

- Energy limiting
- Fast breaking time (2.3–2.5 ms)
- Wide range of accessories
- DIN rail mounting
- Finger-safe terminals
- Multi-function terminals
- CSA C22.2 No 5 certified
- UL 489 File #E312425

S804U-UCZ series

Z tripping characteristic (600Vdc)

4 poles

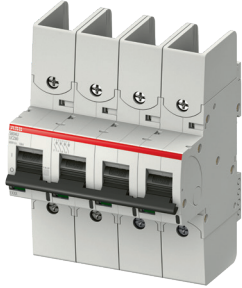

Box Qty	Weight each (kg)	Rated current	Part number
1	0.980	10.0 A	S804U-Z10
		15.0 A	S804U-Z15
		20.0 A	S804U-Z20
		25.0 A	S804U-Z25
		30.0 A	S804U-Z30
		40.0 A	S804U-Z40
		50.0 A	S804U-Z50
		60.0 A	S804U-Z60
		70.0 A	S804U-Z70
		80.0 A	S804U-Z80
		90.0 A	S804U-Z90
		100.0 A	S804U-Z100

Technical specifications

	10...32 A	40...63 A	70...80 A
Conductor type	Single conductor per terminal copper only, 60/75 °C wire	Single conductor per terminal copper only, 60 °C wire	Single conductor per terminal copper only, 60 °C wire
Wire range	#14...2 AWG, Cu solid or stranded	1/0...8 AWG, Cu solid or stranded	1/0...8 AWG, Cu solid or stranded
Jumper length	1 ft (30.5 cm)	1 ft (30.5 cm)	2 ft (61 cm)

Tested and listed wirings (line and load might be reversed)

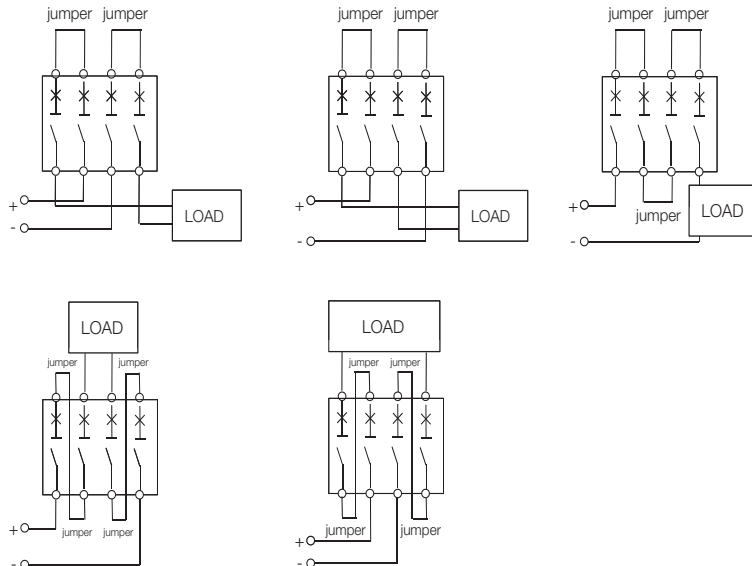

S804U-PVS5 series

UL489B Branch Circuit Protection

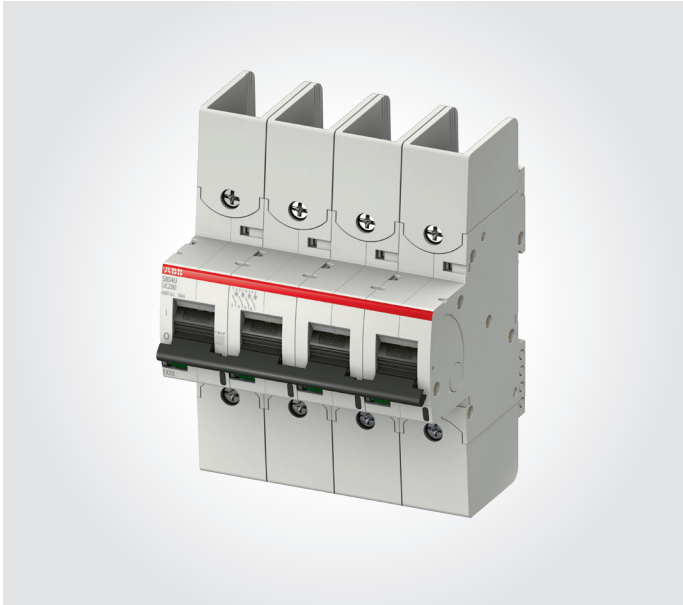

The S804U-PVS5 is for GFDI application (GroundFault Detector Interrupter) in photovoltaic systems.

In case of a ground fault, the breaker will trip. Thus the PV generator will not be damaged. The breaker is tested acc. to UL489B for 1000 V d.c.

General Data	S804U-PVS
Amperage	5 A
Voltage	1000 Vdc
Poles	4p in series
Trip curves	PVS
Short circuit interrupt rating	3 kA
Auxiliary contacts	-
Ambient temperature	-25 ... +55 °C
Bell alarm	-
Shunt trip	-
Undervoltage release	-
TErminals	Cage (compression)

Features

- Energy limiting
- Fast breaking time (2.3–2.5 ms)
- Wide range of accessories
- DIN rail mounting
- Finger-safe terminals
- Multi-function terminals
- CSA C22.2 No 5 certified
- UL 489 File #E312425

S804U-PVS5 series

PV-S tripping characteristic for GFDI in PV applications (1000Vdc)

4 poles

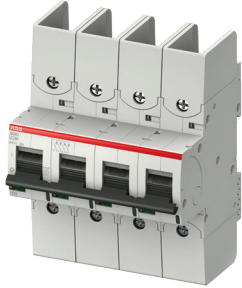

Box Qty	Weight each (kg)	Rated current	Part number
---------	------------------	---------------	-------------

1	0.980	5.0 A	S804U-PVS5
---	-------	-------	------------

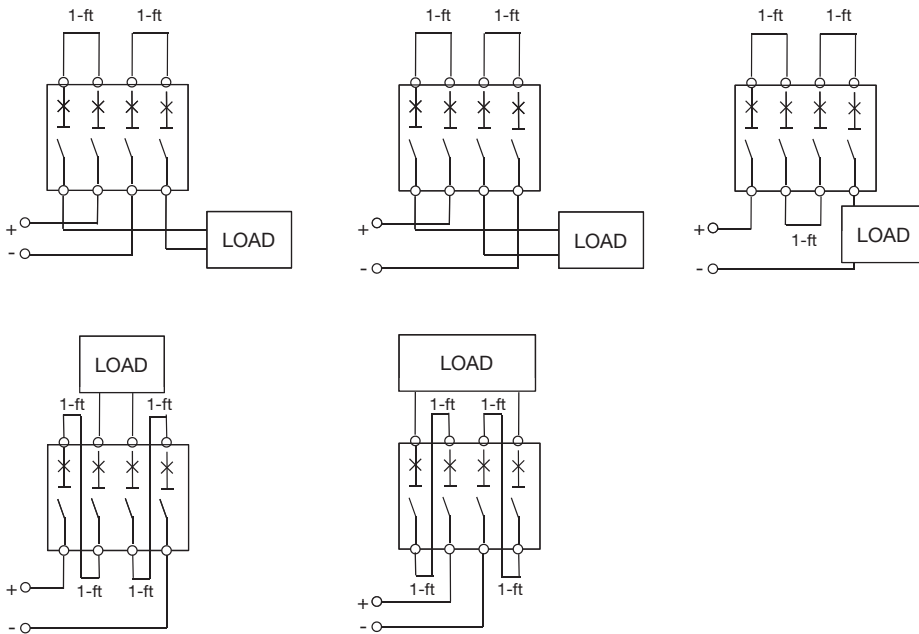

Tested and listed wirings (line and load might be reversed)



Accessories

Electrical accessories

Auxiliary contacts and bell alarms

	Description	Part number
	<p>Auxiliary contact (2 form C)</p> <p>The auxiliary contacts will signal whether the breaker is in the ON or OFF position. Mounts on the left side of the breaker up to maximum of 2 sets</p>	S800-AUX
	<p>Combined auxiliary contact + bell alarm (2 form C)</p> <p>The S800-AUX/ALT combined auxiliary and signal contact is used for electrical signaling of the operating state of the high performance MCB. One signal for the on/off/ state, one signal for tripped state only. Mounts on the left side of the breaker up to maximum of 2 sets.</p>	S800-AUX/ALT

Shunt trip

	Description	Part number
	<p>24 Vac/dc Shunt trip</p> <p>For remote tripping of the breaker, a shunt trip device can be added onto the MCB. The solenoid device opens the breaker after a control voltage is applied. Mounts on the left side of the MCB and can be mixed with auxiliary contacts</p>	S800-SOR24
	<p>48...130 Vac/dc Shunt trip</p> <p>For remote tripping of the breaker, a shunt trip device can be added onto the MCB. The solenoid device opens the breaker after a control voltage is applied. Mounts on the left side of the MCB and can be mixed with auxiliary contacts</p>	S800-SOR130
	<p>110...250 Vdc Shunt trip</p> <p>For remote tripping of the breaker, a shunt trip device can be added onto the MCB. The solenoid device opens the breaker after a control voltage is applied. Mounts on the left side of the MCB and can be mixed with auxiliary contacts</p>	S800-SOR250

Accessories

Electrical accessories

Undervoltage release



Description	Part number
<p>24...36 Vac/dc undervoltage release</p> <p>For remote tripping of the breaker, when the voltage drops below approximately 50% of rated voltage. The breaker can't be operated unless proper voltage is first applied. Mounts on the left side of the MCB and can be mixed with auxiliary contacts</p>	S800-UVR36
<p>48...60 Vac/dc undervoltage release</p> <p>For remote tripping of the breaker, when the voltage drops below approximately 50% of rated voltage. The breaker can't be operated unless proper voltage is first applied. Mounts on the left side of the MCB and can be mixed with auxiliary contacts</p>	S800-UVR60
<p>110...130 Vac/dc undervoltage release</p> <p>For remote tripping of the breaker, when the voltage drops below approximately 50% of rated voltage. The breaker can't be operated unless proper voltage is first applied. Mounts on the left side of the MCB and can be mixed with auxiliary contacts</p>	S800-UVR130
<p>220...250 Vdc undervoltage release</p> <p>For remote tripping of the breaker, when the voltage drops below approximately 50% of rated voltage. The breaker can't be operated unless proper voltage is first applied. Mounts on the left side of the MCB and can be mixed with auxiliary contacts</p>	S800-UVR250

Remote switching unit and cable



Description	Part number
<p>Remote switching unit (breaker not included)</p> <p>The RSU will allow a remote operation of the circuit breaker when 24Vdc is applied</p>	S800W-RSU
<p>Connecting cable and plug (mandatory with RSU)</p> <p>Used with the RSU to provide power and controle. 3 meter cable 0.5 mm² (#20 AWG) including 10-pole Micro-Fit 3.0™ plug.</p>	S800-RSU-CP



Accessories

Mechanical accessories

Ring tongue adaptor

Description	Part number
 <p>Ring terminal cable connection 40...125 A (kit of 2 nuts, insulation nuts, cable lugs, allen screws and 25mm insulation walls)</p>	S800-RT2125

Handle operating mechanism

Description	Part number
 <p>Mounts on the circuit breaker and allows "through the door" operation</p>	S800-RD

Rotary handle

Description	Part number
 <p>Grey rotary handle</p>	S800-RHE-H
<p>Red emergency rotary handle</p>	S800-RHE-EM

Shaft extension

Description	Part number
 <p>To connect rotary drive and door handle</p>	S800-RHE-S

Accessories

Mechanical accessories

UL locking device

Description	Part number
 <p>Lock out / tag out device for S800 series (padlock not included)</p>	S800U-PLL

Technical details

S800U, UCZ, PVS series

Technical specifications MCBs

	S800U	S800U-UCZ	S800U-PVS
Specifications	CSA C22.2 No.5-02 UL489 IEC 60947-2	CSA C22.2 No.5 UL489 IEC 60947-2	CSA C22.2 No.5 UL489B IEC 60947-2
UL file number	E 312425, cULus	E 212323, current limiting	E 212323, current limiting
Nbr of poles	1, 2, 3, 4	4	4
Trip curves	K, Z	UCZ	PVS
Amperage	10...100 A	10...80 A	5 A
Voltage AC	240 Vac	-	-
Voltage DC (1p/2p)	-	600 Vdc	1000 Vdc
Interrupt rating	30 kA (1p), 50 kA	10 kA	1.5 kA
Calibration temp	25°C	25°C	50°C
Mounting position	Any	Any	Any
Protection degree	IP20	IP20	IP20
Mounting	35 mm DIN rail	35 mm DIN rail	35 mm DIN rail
Tightening torque	31 in-lbs 3.5Nm	31 in-lbs 3.5Nm	31 in-lbs 3.5Nm
Terminal wire size	(1)	(1)	(1)
Ambien temperature	-25°C...+60°C -13°F...+140°F	-25°C...+60°C -13°F...+140°F	-25°C...+60°C -13°F...+140°F
Application type	Building installation	Datacenter, critical power	GFDI in PV applications
Mechanical life	4,000 ops	4,000 ops	1,000 ops

(1) Wire size (Cu, solid or stranded)

S800U 14...2 AWG (10-30A)
8...1/0 AWG (10-100A)

S800U-UCZ 14...2 AWG (10-32A)
8...1/0 AWG (40-80A)

S800U-PVS 14...2AWG

Technical details

S800U, UCZ, PVS series

Internal resistance and power loss at 25°C (S800-K, S800U-Z)

Rated current (A)	K and Z tripping characteristics	
	Internal resistance ⁽¹⁾ (mΩ)	Power loss (W)
10	15.2	1.5
15	12.1	2.7
20	8.7	3.5
25	6.8	4.2
30	3.1	2.8
40	2.3	3.7
50	1.7	4.3
60	1.6	5.8
70	1.0	6.4
80	1.0	6.4
90	0.8	6.5
100	0.8	8.3

Temperature derating (S800U, UCZ and PVS)

Standard	Rated current (A)	Maximum operating current(A) at ambient temperature T											
		10 °C	15 °C	20 °C	25 °C	30 °C	35 °C	40 °C	45 °C	50 °C	55 °C	60 °C	
Standard	10	10.9	10.7	10.4	10.0	9.6	9.3	9.0	8.7	8.4	8.0	7.6	
	15	16.5	16.0	15.6	15.0	14.4	14.0	13.5	13.0	12.6	12.0	11.4	
	20	22.0	21.4	20.8	20.0	19.2	18.6	18.0	17.4	16.8	16.0	15.2	
	25	27.5	26.8	26.0	25.0	24.0	23.3	22.5	21.8	21.0	20.0	19.0	
	30	33.1	32.1	31.2	30.0	28.8	27.9	27.0	26.1	25.2	24.0	22.9	
	UL489	40	44.0	42.8	41.6	40.0	38.4	37.2	36.0	34.8	33.6	32.0	30.9
		50	55.1	53.5	52.0	50.0	48.0	46.5	45.0	43.5	42.0	40.0	38.3
		60	66.2	64.2	62.4	60.0	57.6	55.8	54.0	52.2	50.4	48.0	46.0
		70	76.9	74.9	72.8	70.0	67.2	65.1	63.0	60.9	58.8	56.0	53.4
		80	88.0	85.6	83.2	80.0	76.8	74.4	72.0	69.6	67.1	64.0	61.6
90		99.1	96.3	93.6	90.0	86.4	83.7	81.0	78.3	75.6	72.0	69.5	
100		110.5	107.0	104.0	100.0	96.0	93.0	90.0	87.0	83.8	80.0	77.8	

Technical details

Electrical accessories

Technical specifications auxiliary contacts S800AUX, S800AUX/ALT

	S800-AUX	S800-AUX/ALT
	AC15 400/2 A-UL AC15 240/6 A-UL DC13 250/0.55 A DC13 125 V/1.1A DC13/60 V/2A DC13 24 V/4A	AC15 400/2 A-UL AC15 240/6 A-UL DC13 250/0.55 A DC13 125 V/1.1A DC13/60 V/2A DC13 24 V/4A
Usage category		
Continuous thermal current	6 A	6 A
Ratd insulation voltage	690 V	690 V
Number of contacts	2	2 (1 AUX + 1 ALT)
Rated impulse withstand voltage	6 kV	6 kV
Protection degree	3	3
Function of contact	Change over (dry SPDT)	Change over (dry SPDT)
Connection (CU)	1x 2.5mm ² or 2x 1.5 mm ²	1x 2.5mm ² or 2x 1.5 mm ²
Tightening torque	1 Nm	1 Nm
Ensured contacts during shake test according to IEC 68-2-6	5g, 20 frequency cycle at 24 Vac/dc 5 mA brief interrupt < 10 ms	5g, 20 frequency cycle at 24 Vac/dc 5 mA brief interrupt < 10 ms
Supply	Any	Any
Mounting	On MCB, DIN rail	On MCB, DIN rail
Type of protection	IP20	IP20
Permissible ambient temperature	-25°C...+60°C -13°F...+140°F	-25°C...+60°C -13°F...+140°F
Storage temperature	-40°C...+70°C -40°F...+158°F	-40°C...+70°C -40°F...+158°F
Mechanical life	6,000 ops	6,000 ops
Resistance to vibration	IEC 60068-2-27, 60068-2, 61373 Cat. 1/ class B	IEC 60068-2-27, 60068-2, 61373 Cat. 1/ class B

Connection drawings (normal state - OFF position below)

Auxiliary contact S800-AUX

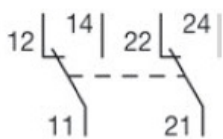

Auxiliary contact S800-AUX/ALT

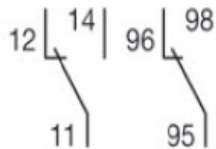

Technical details

Electrical accessories

Technical specifications shunt trip S800-SOR

	S800-SOR24	S800-SOR130	S800-SOR250
Rated voltage	24 Vac/dc	48...130 Vac/dc	110...250 Vac/dc
Operating range	70...110%	70...110%	70...110%
Insulation voltage	690 V	690 V	690 V
Coil pull in consumption	16.6 W (17 VA)	On request	On request
Rated frequency	DC 50/60 Hz	DC 50/60 Hz	DC 50/60 Hz
Protection degree	3	3	3
Connectio Cu	1...35 mm ²	1...35 mm ²	1...35 mm ²
Tightening torque	3...4 Nm	3...4 Nm	3...4 Nm
AC/DC supply	Any	Any	Any
Installation	On MCB, DIN rail	On MCB, DIN rail	On MCB, DIN rail
Type of protection	IP20	IP20	IP20
Permissible ambient temperature	-25°C...+60°C -13°F...+140°F	-25°C...+60°C -13°F...+140°F	-25°C...+60°C -13°F...+140°F
Storage temperature	-40°C...+70°C -40°F...+158°F	-40°C...+70°C -40°F...+158°F	-40°C...+70°C -40°F...+158°F
Resistance to vibration	IEC 60068-2-27, 60068-2, 61373 Cat. 1/ class B	IEC 60068-2-27, 60068-2, 61373 Cat. 1/ class B	IEC 60068-2-27, 60068-2, 61373 Cat. 1/ class B

Technical specifications undervoltage release S800-UVR

	S800-UVR36	S800-UVR60	S800-UVR130	S800-UVR250
Rated voltage	24...36 Vac/dc	48...60 Vac/dc	110...130 Vac/dc	220...250 Vac/dc
Operating opening	35...70% of nominal voltage	35...70% of nominal voltage	35...70% of nominal voltage	35...70% of nominal voltage
Operating closing	85% of nominal voltage	85% of nominal voltage	85% of nominal voltage	85% of nominal voltage
Insulation voltage	690 V	690 V	690 V	690 V
Coil pull in consumption	1 W (14 VA)	1 W (25 VA)	1 W (41 VA)	1 W (91 VA)
Rated frequency	DC 50/60 Hz	DC 50/60 Hz	DC 50/60 Hz	DC 50/60 Hz
Protection degree	3	3	3	3
Connectio Cu	1...35 mm ²	1...35 mm ²	1...35 mm ²	1...35 mm ²
Tightening torque	3...4 Nm	3...4 Nm	3...4 Nm	3...4 Nm
AC/DC supply	Any	Any	Any	Any
Installation	On MCB, DIN rail	On MCB, DIN rail	On MCB, DIN rail	On MCB, DIN rail
Type of protection	IP20	IP20	IP20	IP20
Permissible ambient temperature	-25°C...+60°C -13°F...+140°F	-25°C...+60°C -13°F...+140°F	-25°C...+60°C -13°F...+140°F	-25°C...+60°C -13°F...+140°F
Storage temperature	-40°C...+70°C -40°F...+158°F	-40°C...+70°C -40°F...+158°F	-40°C...+70°C -40°F...+158°F	-40°C...+70°C -40°F...+158°F
Resistance to vibration	IEC 60068-2-27, 60068-2, 61373 Cat. 1/ class B	IEC 60068-2-27, 60068-2, 61373 Cat. 1/ class B	IEC 60068-2-27, 60068-2, 61373 Cat. 1/ class B	IEC 60068-2-27, 60068-2, 61373 Cat. 1/ class B

Technical details

Electrical accessories

Technical specifications S800W-RSU

	S800-SOR250
Operating voltage	24 Vdc
Current consumption	2.5 A
Standby current	< 50 mA
Switching time (OFF-ON)	< 500 ms
Switching time (ON-OFF)	< 250 ms
Ambient operating temperature	-25°C...+70°C
Mechanical life	10,000 operations
Maximum cable length	10 M
Protection degree	IP20
Weight	0.661387 lbs (300 g)
Type of protection	
Connection	1-pole Micro-Fit™ 3.0

General details for S800W-RSU

Features:

- The remote switching unit S800W-RSU has a brushless, high precision DC motor to ensure fast remote control operations
- Low power consumption
- Short switching times
- The S800W-RSU is mounted on any multi-pole S800 high-performance
- MCB
- Installation and wiring can be field installable
- The connection is done by a 10-pole Micro-Fit 3.0™ (not included in delivery)
- The S800W-RSU can be operated by a standard pushbutton or drive by a PLC

Switching times:

- OFF > ON
< 500 ms from signal to contact closing
- ON > OFF
<250 ms from signal to contact opening
- TRIP > OFF > ON
<1500 ms from signal to contact closing

Safety intelligence

- Inputs are deactivated when detecting manual use
- All outputs become active when spindle is rotated more than 360 degrees
- S800W-RSU is locked for five minutes after three switching attempts leading to a trip
- Manual switch off possible for 3 and 4 pole devices

Tripping curves details

K tripping curve

Description

The "K" characteristic offers instantaneous tripping at 13 times rated current in 50/60Hz systems.

Used in case of high magnetic inrush currents that can occur, e.g. in engines or transformers. This characteristic provides the best protection for a wide range of electrical systems by allowing high inrush currents when start-ing up the system.

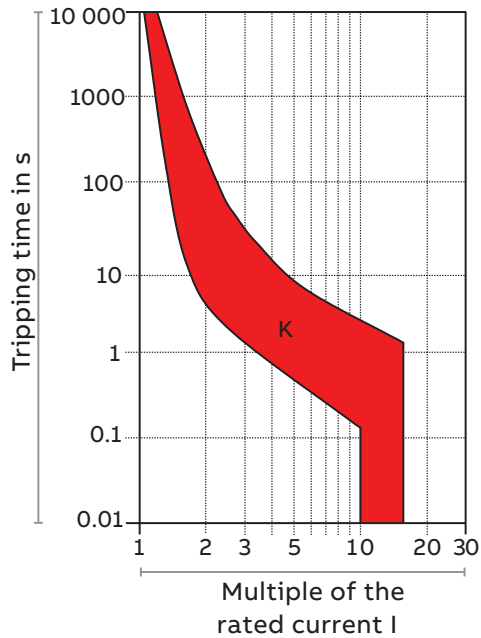

Standard	Currents	Thermal release		Magnetic release
		Small test current	Large test current	Range of instantaneous trip
UL489	10...100 A	1.00 x I _n	1.35 x I _n	13 x I _n ± 20%

Tripping curves details

Z tripping curve

Description

The "Z" characteristic offers instantaneous tripping at 4 times rated current in 50/60Hz systems.

Used as Ground-Fault Detector Interrupter (GFDI) in photo-voltaic systems.

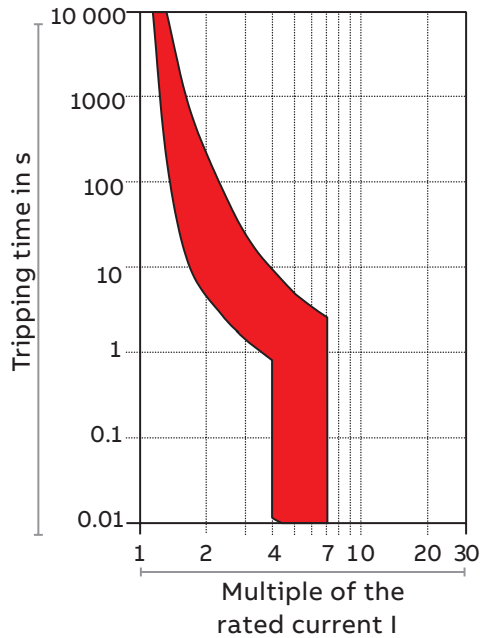

Standard	Currents	Thermal release		Magnetic release
		Small test current	Large test current	Range of instantaneous trip
UL489	10...100 A	$1.00 \times I_n$	$1.35 \times I_n$	$4 \times I_n \pm 20\%$

Tripping curves details

UCZ tripping curve

Description

The "UCZ" characteristic offers instantaneous tripping at 11 times rated current in DC systems.

Used in case of circuit breaker in 600 Vdc networks, especially in datacenters.

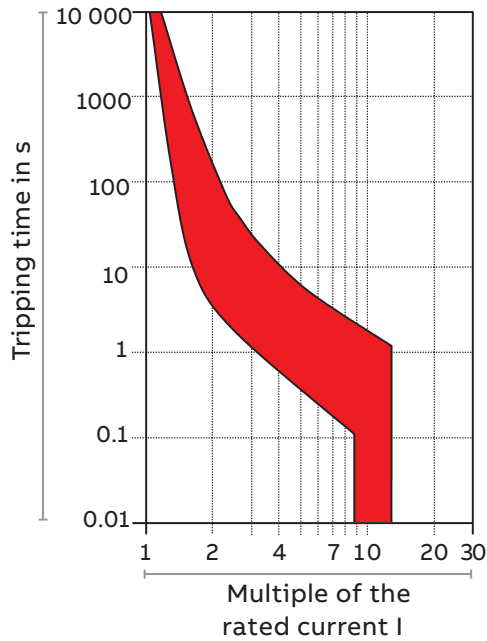

Standard	Currents	Thermal release		Magnetic release
		Small test current	Large test current	Range of instantaneous trip
UL489	10...80 A	1.00 x I _n	1.35 x I _n	11 x I _n ± 20% (DC)

Tripping curves details

PVS tripping curve

Description

The "PVS" characteristic offers instantaneous tripping at 6 times rated current in DC systems.

Used in case of circuit breaker protecting electric circuits feeding consumers that do not generate any current peaks, or only mild ones.

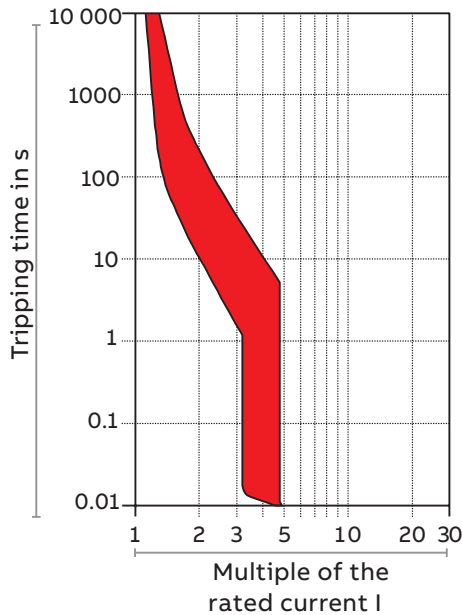

Standard	Currents	Thermal release		Magnetic release
		Small test current	Large test current	Range of instantaneous trip
UL489	5 A	$1.13 \times I_n$	$1.30 \times I_n$	$6 \times I_n$ (DC)

Dimensions

S800U, UCZ and PVS series

S800U approximate dimensions

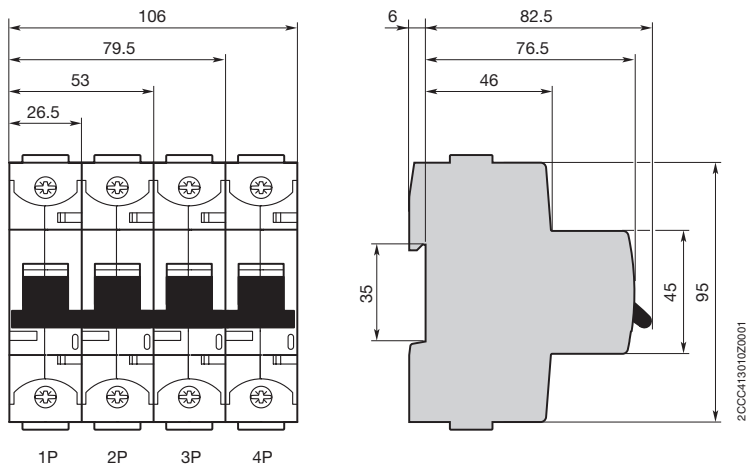

S800U-UCZ and S800U-PVS approximate dimensions

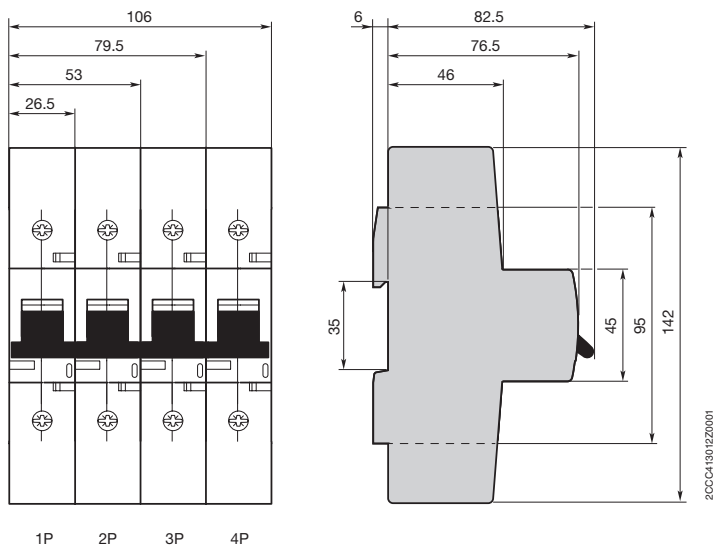

Dimensions

Accessories

S800-AUX and S800-AUX/ALT approximate dimensions

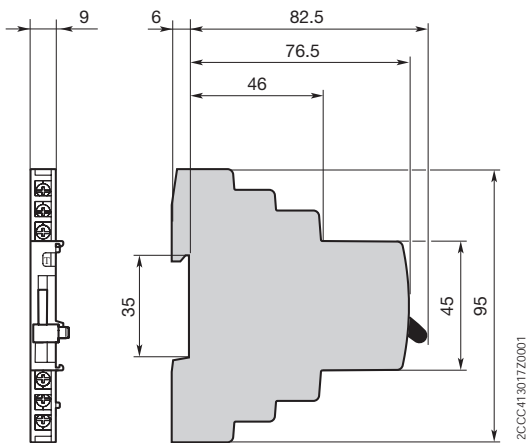

S800-SOR and S800-UVR approximate dimensions

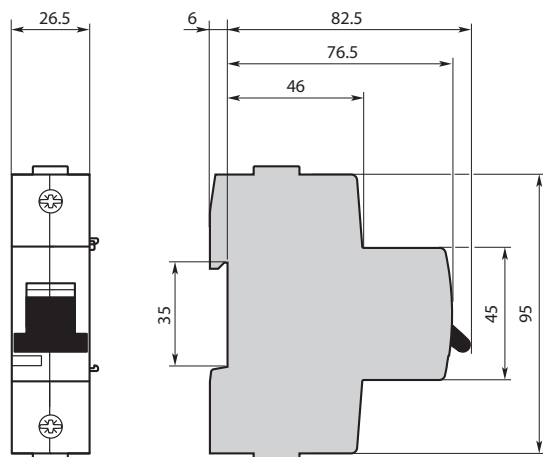

Dimensions

Accessories

S800W-RSU approximate dimensions

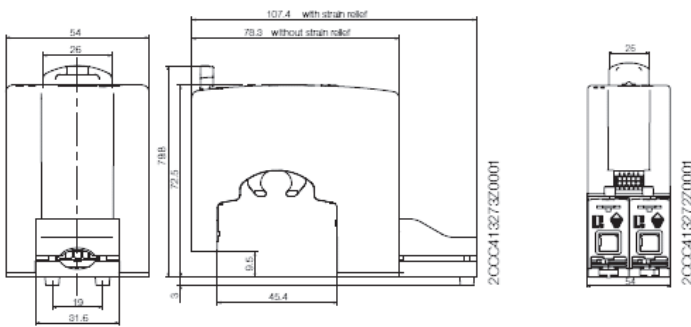

S800-RD and S800-RHE approximate dimensions

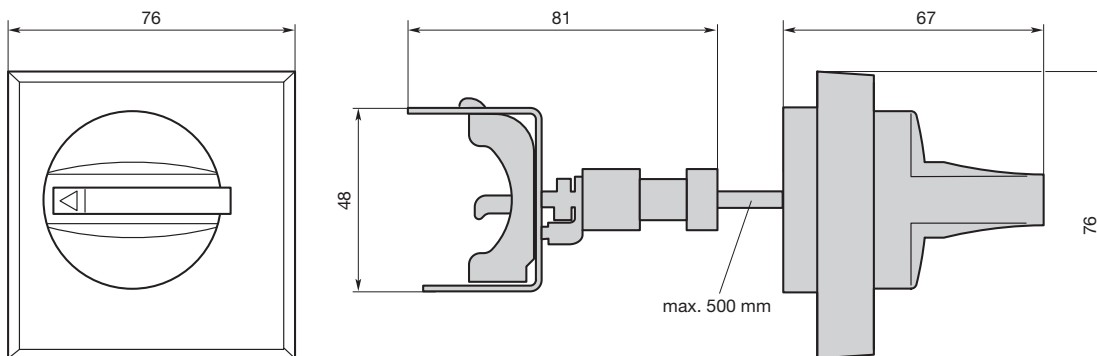



CSA C22.2 No.235 / UL1077 devices

003–014	ST200M series
015–016	S200MR series
017–020	S200MUC series
021–025	Accessories
026–033	Technical details
034–038	Tripping curves details
039–040	Dimensions
041–045	S800C
046–047	S800S
048	S800HV
049–053	Accessories
054–059	Technical details
060–063	Tripping curves details
064–066	Dimensions

ST200M series

UL 1077 Supplementary Protectors



The ST 200 M miniature circuit breaker provides supplementary protection acc. to CSA C22.2 No. 235 and UL 1077 up to 480 Y/277 V AC and 125 V DC.

With a broad range of options and approvals acc. to the international standards UL, CSA and IEC, the ST 200 M is ideal for multiple applications and markets.

It is also fully compatible with System pro M compact® accessories.

General Data	ST200M
Amperage	0.5 up to 63 A
Voltage	480Y/277 V AC 60/125 V DC (1/2-pole)
Poles	1, 1+N, 2, 3, 3+N, 4
Trip curves	B, C, D, K, Z
Short circuit interrupt rating	10 kA (up to 32 A) 5kA (32...63 A)
Auxiliary contacts	Yes
Ambient temperature	-25 ... +55 °C
Mechanical life	20,000 operations
Bell alarm	Yes
Shunt trip	Yes
Undervoltage release	Yes
Busbar	Yes

Features

- High performance MCB with interrupt rating up to 10 kA
- DIN rail mounting
- CE certified and marked
- CSA 22.2 No. 235 and UL1077 (UL file #E76126) certified
- Energy limiting
- Fast breaking time (2.3 to 2.5 ms)
- Wide range of accessories
- Finger-safe terminals
- Suitable for reverse feed
- High calibration temperature of 40 °C for reduced derating in ICP applications
- Laser printing provides clear product information on device
- Clear contact position indication in red/green ("real CPI")
- Unique, patented twin terminal for wiring up to 35 mm² with captive screws
- Field wiring available for most types
- Bus connection system
- Robust thermoplastic housing material for better protection against external influences

ST200M series

B tripping characteristic

1 pole	Box Qty	Weight each (kg)	Rated Current	Part number
	10	0.115	0.5 A	ST201M-B0.5
			1.0 A	ST201M-B1
			1.6 A	ST201M-B1.6
			2.0 A	ST201M-B2
			3.0 A	ST201M-B3
			4.0 A	ST201M-B4
			5.0 A	ST201M-B5
			6.0 A	ST201M-B6
			7.0 A	ST201M-B7
			8.0 A	ST201M-B8
			10.0 A	ST201M-B10
			13.0 A	ST201M-B13
			15.0 A	ST201M-B15
			16.0 A	ST201M-B16
			20.0 A	ST201M-B20
			25.0 A	ST201M-B25
			30.0 A	ST201M-B30
32.0 A	ST201M-B32			
35.0 A	ST201M-B35			
40.0 A	ST201M-B40			
50.0 A	ST201M-B50			
60.0 A	ST201M-B60			
63.0 A	ST201M-B63			

1 pole + Neutral	Box Qty	Weight each (kg)	Rated Current	Part number
	5	0.230	0.5 A	ST201M-B0.5NA
			1.0 A	ST201M-B1NA
			1.6 A	ST201M-B1.6NA
			2.0 A	ST201M-B2NA
			3.0 A	ST201M-B3NA
			4.0 A	ST201M-B4NA
			5.0 A	ST201M-B5NA
			6.0 A	ST201M-B6NA
			7.0 A	ST201M-B7NA
			8.0 A	ST201M-B8NA
			10.0 A	ST201M-B10NA
			13.0 A	ST201M-B13NA
			15.0 A	ST201M-B15NA
			16.0 A	ST201M-B16NA
			20.0 A	ST201M-B20NA
			25.0 A	ST201M-B25NA
			30.0 A	ST201M-B30NA
32.0 A	ST201M-B32NA			
35.0 A	ST201M-B35NA			
40.0 A	ST201M-B40NA			
50.0 A	ST201M-B50NA			
60.0 A	ST201M-B60NA			
63.0 A	ST201M-B63NA			

2 poles	Box Qty	Weight each (kg)	Rated Current	Part number
	5	0.230	0.5 A	ST202M-B0.5
			1.0 A	ST202M-B1
			1.6 A	ST202M-B1.6
			2.0 A	ST202M-B2
			3.0 A	ST202M-B3
			4.0 A	ST202M-B4
			5.0 A	ST202M-B5
			6.0 A	ST202M-B6
			7.0 A	ST202M-B7
			8.0 A	ST202M-B8
			10.0 A	ST202M-B10
			13.0 A	ST202M-B13
			15.0 A	ST202M-B15
			16.0 A	ST202M-B16
			20.0 A	ST202M-B20
			25.0 A	ST202M-B25
			30.0 A	ST202M-B30
32.0 A	ST202M-B32			
35.0 A	ST202M-B35			
40.0 A	ST202M-B40			
50.0 A	ST202M-B50			
60.0 A	ST202M-B60			
63.0 A	ST202M-B63			

3 poles	Box Qty	Weight each (kg)	Rated Current	Part number
	1	0.345	0.5 A	ST203M-B0.5
			1.0 A	ST203M-B1
			1.6 A	ST203M-B1.6
			2.0 A	ST203M-B2
			3.0 A	ST203M-B3
			4.0 A	ST203M-B4
			5.0 A	ST203M-B5
			6.0 A	ST203M-B6
			7.0 A	ST203M-B7
			8.0 A	ST203M-B8
			10.0 A	ST203M-B10
			13.0 A	ST203M-B13
			15.0 A	ST203M-B15
			16.0 A	ST203M-B16
			20.0 A	ST203M-B20
			25.0 A	ST203M-B25
			30.0 A	ST203M-B30
32.0 A	ST203M-B32			
35.0 A	ST203M-B35			
40.0 A	ST203M-B40			
50.0 A	ST203M-B50			
60.0 A	ST203M-B60			
63.0 A	ST203M-B63			

ST200M series

B tripping characteristic (cont.)

3 poles+ Neutral	Box Qty	Weight each (kg)	Rated Current	Part number
	1	0.460	0.5 A	ST203M-B0.5NA
			1.0 A	ST203M-B1NA
			1.6 A	ST203M-B1.6NA
			2.0 A	ST203M-B2NA
			3.0 A	ST203M-B3NA
			4.0 A	ST203M-B4NA
			5.0 A	ST203M-B5NA
			6.0 A	ST203M-B6NA
			7.0 A	ST203M-B7NA
			8.0 A	ST203M-B8NA
			10.0 A	ST203M-B10NA
			13.0 A	ST203M-B13NA
			15.0 A	ST203M-B15NA
			16.0 A	ST203M-B16NA
			20.0 A	ST203M-B20NA
			25.0 A	ST203M-B25NA
			30.0 A	ST203M-B30NA
			32.0 A	ST203M-B32NA
			35.0 A	ST203M-B35NA
			40.0 A	ST203M-B40NA
			50.0 A	ST203M-B50NA
			60.0 A	ST203M-B60NA
			63.0 A	ST203M-B63NA



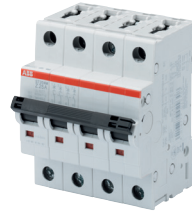

4 poles	Box Qty	Weight each (kg)	Rated Current	Part number
	1	0.460	0.5 A	ST204M-B0.5
			1.0 A	ST204M-B1
			1.6 A	ST204M-B1.6
			2.0 A	ST204M-B2
			3.0 A	ST204M-B3
			4.0 A	ST204M-B4
			5.0 A	ST204M-B5
			6.0 A	ST204M-B6
			7.0 A	ST204M-B7
			8.0 A	ST204M-B8
			10.0 A	ST204M-B10
			13.0 A	ST204M-B13
			15.0 A	ST204M-B15
			16.0 A	ST204M-B16
			20.0 A	ST204M-B20
			25.0 A	ST204M-B25
			30.0 A	ST204M-B30
			32.0 A	ST204M-B32
			35.0 A	ST204M-B35
			40.0 A	ST204M-B40
			50.0 A	ST204M-B50
			60.0 A	ST204M-B60
			63.0 A	ST204M-B63





ST200M series

C tripping characteristic

1 pole	Box Qty	Weight each (kg)	Rated Current	Part number
	10	0.115	0.5 A	ST201M-C0.5
			1.0 A	ST201M-C1
			1.6 A	ST201M-C1.6
			2.0 A	ST201M-C2
			3.0 A	ST201M-C3
			4.0 A	ST201M-C4
			5.0 A	ST201M-C5
			6.0 A	ST201M-C6
			7.0 A	ST201M-C7
			8.0 A	ST201M-C8
			10.0 A	ST201M-C10
			13.0 A	ST201M-C13
			15.0 A	ST201M-C15
			16.0 A	ST201M-C16
			20.0 A	ST201M-C20
			25.0 A	ST201M-C25
			30.0 A	ST201M-C30
			32.0 A	ST201M-C32
35.0 A	ST201M-C35			
40.0 A	ST201M-C40			
50.0 A	ST201M-C50			
60.0 A	ST201M-C60			
63.0 A	ST201M-C63			

1 pole + Neutral	Box Qty	Weight each (kg)	Rated Current	Part number
	5	0.230	0.5 A	ST201M-C0.5NA
			1.0 A	ST201M-C1NA
			1.6 A	ST201M-C1.6NA
			2.0 A	ST201M-C2NA
			3.0 A	ST201M-C3NA
			4.0 A	ST201M-C4NA
			5.0 A	ST201M-C5NA
			6.0 A	ST201M-C6NA
			7.0 A	ST201M-C7NA
			8.0 A	ST201M-C8NA
			10.0 A	ST201M-C10NA
			13.0 A	ST201M-C13NA
			15.0 A	ST201M-C15NA
			16.0 A	ST201M-C16NA
			20.0 A	ST201M-C20NA
			25.0 A	ST201M-C25NA
			30.0 A	ST201M-C30NA
			32.0 A	ST201M-C32NA
35.0 A	ST201M-C35NA			
40.0 A	ST201M-C40NA			
50.0 A	ST201M-C50NA			
60.0 A	ST201M-C60NA			
63.0 A	ST201M-C63NA			

2 poles	Box Qty	Weight each (kg)	Rated Current	Part number
	5	0.230	0.5 A	ST202M-C0.5
			1.0 A	ST202M-C1
			1.6 A	ST202M-C1.6
			2.0 A	ST202M-C2
			3.0 A	ST202M-C3
			4.0 A	ST202M-C4
			5.0 A	ST202M-C5
			6.0 A	ST202M-C6
			7.0 A	ST202M-C7
			8.0 A	ST202M-C8
			10.0 A	ST202M-C10
			13.0 A	ST202M-C13
			15.0 A	ST202M-C15
			16.0 A	ST202M-C16
			20.0 A	ST202M-C20
			25.0 A	ST202M-C25
			30.0 A	ST202M-C30
			32.0 A	ST202M-C32
35.0 A	ST202M-C35			
40.0 A	ST202M-C40			
50.0 A	ST202M-C50			
60.0 A	ST202M-C60			
63.0 A	ST202M-C63			

3 poles	Box Qty	Weight each (kg)	Rated Current	Part number
	1	0.345	0.5 A	ST203M-C0.5
			1.0 A	ST203M-C1
			1.6 A	ST203M-C1.6
			2.0 A	ST203M-C2
			3.0 A	ST203M-C3
			4.0 A	ST203M-C4
			5.0 A	ST203M-C5
			6.0 A	ST203M-C6
			7.0 A	ST203M-C7
			8.0 A	ST203M-C8
			10.0 A	ST203M-C10
			13.0 A	ST203M-C13
			15.0 A	ST203M-C15
			16.0 A	ST203M-C16
			20.0 A	ST203M-C20
			25.0 A	ST203M-C25
			30.0 A	ST203M-C30
			32.0 A	ST203M-C32
35.0 A	ST203M-C35			
40.0 A	ST203M-C40			
50.0 A	ST203M-C50			
60.0 A	ST203M-C60			
63.0 A	ST203M-C63			

ST200M series

C tripping characteristic (cont.)

3 poles+ Neutral	Box Qty	Weight each (kg)	Rated Current	Part number
	1	0.460	0.5 A	ST203M-C0.5NA
			1.0 A	ST203M-C1NA
			1.6 A	ST203M-C1.6NA
			2.0 A	ST203M-C2NA
			3.0 A	ST203M-C3NA
			4.0 A	ST203M-C4NA
			5.0 A	ST203M-C5NA
			6.0 A	ST203M-C6NA
			7.0 A	ST203M-C7NA
			8.0 A	ST203M-C8NA
			10.0 A	ST203M-C10NA
			13.0 A	ST203M-C13NA
			15.0 A	ST203M-C15NA
			16.0 A	ST203M-C16NA
			20.0 A	ST203M-C20NA
			25.0 A	ST203M-C25NA
			30.0 A	ST203M-C30NA
			32.0 A	ST203M-C32NA
			35.0 A	ST203M-C35NA
			40.0 A	ST203M-C40NA
			50.0 A	ST203M-C50NA
			60.0 A	ST203M-C60NA
			63.0 A	ST203M-C63NA





4 poles	Box Qty	Weight each (kg)	Rated Current	Part number
	1	0.460	0.5 A	ST204M-C0.5
			1.0 A	ST204M-C1
			1.6 A	ST204M-C1.6
			2.0 A	ST204M-C2
			3.0 A	ST204M-C3
			4.0 A	ST204M-C4
			5.0 A	ST204M-C5
			6.0 A	ST204M-C6
			7.0 A	ST204M-C7
			8.0 A	ST204M-C8
			10.0 A	ST204M-C10
			13.0 A	ST204M-C13
			15.0 A	ST204M-C15
			16.0 A	ST204M-C16
			20.0 A	ST204M-C20
			25.0 A	ST204M-C25
			30.0 A	ST204M-C30
			32.0 A	ST204M-C32
			35.0 A	ST204M-C35
			40.0 A	ST204M-C40
			50.0 A	ST204M-C50
			60.0 A	ST204M-C60
			63.0 A	ST204M-C63





ST200M series

D tripping characteristic

1 pole	Box Qty	Weight each (kg)	Rated Current	Part number
	10	0.115	0.5 A	ST201M-D0.5
			1.0 A	ST201M-D1
			1.6 A	ST201M-D1.6
			2.0 A	ST201M-D2
			3.0 A	ST201M-D3
			4.0 A	ST201M-D4
			5.0 A	ST201M-D5
			6.0 A	ST201M-D6
			7.0 A	ST201M-D7
			8.0 A	ST201M-D8
			10.0 A	ST201M-D10
			13.0 A	ST201M-D13
			15.0 A	ST201M-D15
			16.0 A	ST201M-D16
			20.0 A	ST201M-D20
			25.0 A	ST201M-D25
			30.0 A	ST201M-D30
			32.0 A	ST201M-D32
35.0 A	ST201M-D35			
40.0 A	ST201M-D40			
50.0 A	ST201M-D50			
60.0 A	ST201M-D60			
63.0 A	ST201M-D63			

1 pole + Neutral	Box Qty	Weight each (kg)	Rated Current	Part number
	5	0.230	0.5 A	ST201M-D0.5NA
			1.0 A	ST201M-D1NA
			1.6 A	ST201M-D1.6NA
			2.0 A	ST201M-D2NA
			3.0 A	ST201M-D3NA
			4.0 A	ST201M-D4NA
			5.0 A	ST201M-D5NA
			6.0 A	ST201M-D6NA
			7.0 A	ST201M-D7NA
			8.0 A	ST201M-D8NA
			10.0 A	ST201M-D10NA
			13.0 A	ST201M-D13NA
			15.0 A	ST201M-D15NA
			16.0 A	ST201M-D16NA
			20.0 A	ST201M-D20NA
			25.0 A	ST201M-D25NA
			30.0 A	ST201M-D30NA
			32.0 A	ST201M-D32NA
35.0 A	ST201M-D35NA			
40.0 A	ST201M-D40NA			
50.0 A	ST201M-D50NA			
60.0 A	ST201M-D60NA			
63.0 A	ST201M-D63NA			

2 poles	Box Qty	Weight each (kg)	Rated Current	Part number
	5	0.230	0.5 A	ST202M-D0.5
			1.0 A	ST202M-D1
			1.6 A	ST202M-D1.6
			2.0 A	ST202M-D2
			3.0 A	ST202M-D3
			4.0 A	ST202M-D4
			5.0 A	ST202M-D5
			6.0 A	ST202M-D6
			7.0 A	ST202M-D7
			8.0 A	ST202M-D8
			10.0 A	ST202M-D10
			13.0 A	ST202M-D13
			15.0 A	ST202M-D15
			16.0 A	ST202M-D16
			20.0 A	ST202M-D20
			25.0 A	ST202M-D25
			30.0 A	ST202M-D30
			32.0 A	ST202M-D32
35.0 A	ST202M-D35			
40.0 A	ST202M-D40			
50.0 A	ST202M-D50			
60.0 A	ST202M-D60			
63.0 A	ST202M-D63			

3 poles	Box Qty	Weight each (kg)	Rated Current	Part number
	1	0.345	0.5 A	ST203M-D0.5
			1.0 A	ST203M-D1
			1.6 A	ST203M-D1.6
			2.0 A	ST203M-D2
			3.0 A	ST203M-D3
			4.0 A	ST203M-D4
			5.0 A	ST203M-D5
			6.0 A	ST203M-D6
			7.0 A	ST203M-D7
			8.0 A	ST203M-D8
			10.0 A	ST203M-D10
			13.0 A	ST203M-D13
			15.0 A	ST203M-D15
			16.0 A	ST203M-D16
			20.0 A	ST203M-D20
			25.0 A	ST203M-D25
			30.0 A	ST203M-D30
			32.0 A	ST203M-D32
35.0 A	ST203M-D35			
40.0 A	ST203M-D40			
50.0 A	ST203M-D50			
60.0 A	ST203M-D60			
63.0 A	ST203M-D63			

ST200M series

D tripping characteristic (cont.)

3 poles+ Neutral	Box Qty	Weight each (kg)	Rated Current	Part number
	1	0.460	0.5 A	ST203M-D0.5NA
			1.0 A	ST203M-D1NA
			1.6 A	ST203M-D1.6NA
			2.0 A	ST203M-D2NA
			3.0 A	ST203M-D3NA
			4.0 A	ST203M-D4NA
			5.0 A	ST203M-D5NA
			6.0 A	ST203M-D6NA
			7.0 A	ST203M-D7NA
			8.0 A	ST203M-D8NA
			10.0 A	ST203M-D10NA
			13.0 A	ST203M-D13NA
			15.0 A	ST203M-D15NA
			16.0 A	ST203M-D16NA
			20.0 A	ST203M-D20NA
			25.0 A	ST203M-D25NA
			30.0 A	ST203M-D30NA
			32.0 A	ST203M-D32NA
			35.0 A	ST203M-D35NA
			40.0 A	ST203M-D40NA
			50.0 A	ST203M-D50NA
			60.0 A	ST203M-D60NA
			63.0 A	ST203M-D63NA



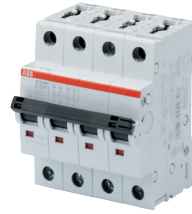

4 poles	Box Qty	Weight each (kg)	Rated Current	Part number
	1	0.460	0.5 A	ST204M-D0.5
			1.0 A	ST204M-D1
			1.6 A	ST204M-D1.6
			2.0 A	ST204M-D2
			3.0 A	ST204M-D3
			4.0 A	ST204M-D4
			5.0 A	ST204M-D5
			6.0 A	ST204M-D6
			7.0 A	ST204M-D7
			8.0 A	ST204M-D8
			10.0 A	ST204M-D10
			13.0 A	ST204M-D13
			15.0 A	ST204M-D15
			16.0 A	ST204M-D16
			20.0 A	ST204M-D20
			25.0 A	ST204M-D25
			30.0 A	ST204M-D30
			32.0 A	ST204M-D32
			35.0 A	ST204M-D35
			40.0 A	ST204M-D40
			50.0 A	ST204M-D50
			60.0 A	ST204M-D60
			63.0 A	ST204M-D63





ST200M series

K tripping characteristic

1 pole	Box Qty	Weight each (kg)	Rated Current	Part number
	10	0.115	0.5 A	ST201M-K0.5
			1.0 A	ST201M-K1
			1.6 A	ST201M-K1.6
			2.0 A	ST201M-K2
			3.0 A	ST201M-K3
			4.0 A	ST201M-K4
			5.0 A	ST201M-K5
			6.0 A	ST201M-K6
			7.0 A	ST201M-K7
			8.0 A	ST201M-K8
			10.0 A	ST201M-K10
			13.0 A	ST201M-K13
			15.0 A	ST201M-K15
			16.0 A	ST201M-K16
			20.0 A	ST201M-K20
			25.0 A	ST201M-K25
			30.0 A	ST201M-K30
32.0 A	ST201M-K32			
35.0 A	ST201M-K35			
40.0 A	ST201M-K40			
50.0 A	ST201M-K50			
60.0 A	ST201M-K60			
63.0 A	ST201M-K63			

1 pole + Neutral	Box Qty	Weight each (kg)	Rated Current	Part number
	5	0.230	0.5 A	ST201M-K0.5NA
			1.0 A	ST201M-K1NA
			1.6 A	ST201M-K1.6NA
			2.0 A	ST201M-K2NA
			3.0 A	ST201M-K3NA
			4.0 A	ST201M-K4NA
			5.0 A	ST201M-K5NA
			6.0 A	ST201M-K6NA
			7.0 A	ST201M-K7NA
			8.0 A	ST201M-K8NA
			10.0 A	ST201M-K10NA
			13.0 A	ST201M-K13NA
			15.0 A	ST201M-K15NA
			16.0 A	ST201M-K16NA
			20.0 A	ST201M-K20NA
			25.0 A	ST201M-K25NA
			30.0 A	ST201M-K30NA
32.0 A	ST201M-K32NA			
35.0 A	ST201M-K35NA			
40.0 A	ST201M-K40NA			
50.0 A	ST201M-K50NA			
60.0 A	ST201M-K60NA			
63.0 A	ST201M-K63NA			

2 poles	Box Qty	Weight each (kg)	Rated Current	Part number
	5	0.230	0.5 A	ST202M-K0.5
			1.0 A	ST202M-K1
			1.6 A	ST202M-K1.6
			2.0 A	ST202M-K2
			3.0 A	ST202M-K3
			4.0 A	ST202M-K4
			5.0 A	ST202M-K5
			6.0 A	ST202M-K6
			7.0 A	ST202M-K7
			8.0 A	ST202M-K8
			10.0 A	ST202M-K10
			13.0 A	ST202M-K13
			15.0 A	ST202M-K15
			16.0 A	ST202M-K16
			20.0 A	ST202M-K20
			25.0 A	ST202M-K25
			30.0 A	ST202M-K30
32.0 A	ST202M-K32			
35.0 A	ST202M-K35			
40.0 A	ST202M-K40			
50.0 A	ST202M-K50			
60.0 A	ST202M-K60			
63.0 A	ST202M-K63			

3 poles	Box Qty	Weight each (kg)	Rated Current	Part number
	1	0.345	0.5 A	ST203M-K0.5
			1.0 A	ST203M-K1
			1.6 A	ST203M-K1.6
			2.0 A	ST203M-K2
			3.0 A	ST203M-K3
			4.0 A	ST203M-K4
			5.0 A	ST203M-K5
			6.0 A	ST203M-K6
			7.0 A	ST203M-K7
			8.0 A	ST203M-K8
			10.0 A	ST203M-K10
			13.0 A	ST203M-K13
			15.0 A	ST203M-K15
			16.0 A	ST203M-K16
			20.0 A	ST203M-K20
			25.0 A	ST203M-K25
			30.0 A	ST203M-K30
32.0 A	ST203M-K32			
35.0 A	ST203M-K35			
40.0 A	ST203M-K40			
50.0 A	ST203M-K50			
60.0 A	ST203M-K60			
63.0 A	ST203M-K63			

ST200M series

K tripping characteristic (cont.)

3 poles+ Neutral	Box Qty	Weight each (kg)	Rated Current	Part number
	1	0.460	0.5 A	ST203M-K0.5NA
			1.0 A	ST203M-K1NA
			1.6 A	ST203M-K1.6NA
			2.0 A	ST203M-K2NA
			3.0 A	ST203M-K3NA
			4.0 A	ST203M-K4NA
			5.0 A	ST203M-K5NA
			6.0 A	ST203M-K6NA
			7.0 A	ST203M-K7NA
			8.0 A	ST203M-K8NA
			10.0 A	ST203M-K10NA
			13.0 A	ST203M-K13NA
			15.0 A	ST203M-K15NA
			16.0 A	ST203M-K16NA
			20.0 A	ST203M-K20NA
			25.0 A	ST203M-K25NA
			30.0 A	ST203M-K30NA
			32.0 A	ST203M-K32NA
			35.0 A	ST203M-K35NA
			40.0 A	ST203M-K40NA
			50.0 A	ST203M-K50NA
			60.0 A	ST203M-K60NA
			63.0 A	ST203M-K63NA



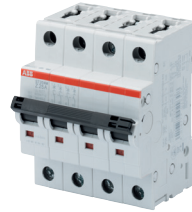

4 poles	Box Qty	Weight each (kg)	Rated Current	Part number
	1	0.460	0.5 A	ST204M-K0.5
			1.0 A	ST204M-K1
			1.6 A	ST204M-K1.6
			2.0 A	ST204M-K2
			3.0 A	ST204M-K3
			4.0 A	ST204M-K4
			5.0 A	ST204M-K5
			6.0 A	ST204M-K6
			7.0 A	ST204M-K7
			8.0 A	ST204M-K8
			10.0 A	ST204M-K10
			13.0 A	ST204M-K13
			15.0 A	ST204M-K15
			16.0 A	ST204M-K16
			20.0 A	ST204M-K20
			25.0 A	ST204M-K25
			30.0 A	ST204M-K30
			32.0 A	ST204M-K32
			35.0 A	ST204M-K35
			40.0 A	ST204M-K40
			50.0 A	ST204M-K50
			60.0 A	ST204M-K60
			63.0 A	ST204M-K63





ST200M series

Z tripping characteristic

1 pole	Box Qty	Weight each (kg)	Rated Current	Part number
	10	0.115	0.5 A	ST201M-Z0.5
			1.0 A	ST201M-Z1
			1.6 A	ST201M-Z1.6
			2.0 A	ST201M-Z2
			3.0 A	ST201M-Z3
			4.0 A	ST201M-Z4
			5.0 A	ST201M-Z5
			6.0 A	ST201M-Z6
			7.0 A	ST201M-Z7
			8.0 A	ST201M-Z8
			10.0 A	ST201M-Z10
			13.0 A	ST201M-Z13
			15.0 A	ST201M-Z15
			16.0 A	ST201M-Z16
			20.0 A	ST201M-Z20
			25.0 A	ST201M-Z25
			30.0 A	ST201M-Z30
			32.0 A	ST201M-Z32
35.0 A	ST201M-Z35			
40.0 A	ST201M-Z40			
50.0 A	ST201M-Z50			
60.0 A	ST201M-Z60			
63.0 A	ST201M-Z63			

1 pole + Neutral	Box Qty	Weight each (kg)	Rated Current	Part number
	5	0.230	0.5 A	ST201M-Z0.5NA
			1.0 A	ST201M-Z1NA
			1.6 A	ST201M-Z1.6NA
			2.0 A	ST201M-Z2NA
			3.0 A	ST201M-Z3NA
			4.0 A	ST201M-Z4NA
			5.0 A	ST201M-Z5NA
			6.0 A	ST201M-Z6NA
			7.0 A	ST201M-Z7NA
			8.0 A	ST201M-Z8NA
			10.0 A	ST201M-Z10NA
			13.0 A	ST201M-Z13NA
			15.0 A	ST201M-Z15NA
			16.0 A	ST201M-Z16NA
			20.0 A	ST201M-Z20NA
			25.0 A	ST201M-Z25NA
			30.0 A	ST201M-Z30NA
			32.0 A	ST201M-Z32NA
35.0 A	ST201M-Z35NA			
40.0 A	ST201M-Z40NA			
50.0 A	ST201M-Z50NA			
60.0 A	ST201M-Z60NA			
63.0 A	ST201M-Z63NA			

2 poles	Box Qty	Weight each (kg)	Rated Current	Part number
	5	0.230	0.5 A	ST202M-Z0.5
			1.0 A	ST202M-Z1
			1.6 A	ST202M-Z1.6
			2.0 A	ST202M-Z2
			3.0 A	ST202M-Z3
			4.0 A	ST202M-Z4
			5.0 A	ST202M-Z5
			6.0 A	ST202M-Z6
			7.0 A	ST202M-Z7
			8.0 A	ST202M-Z8
			10.0 A	ST202M-Z10
			13.0 A	ST202M-Z13
			15.0 A	ST202M-Z15
			16.0 A	ST202M-Z16
			20.0 A	ST202M-Z20
			25.0 A	ST202M-Z25
			30.0 A	ST202M-Z30
			32.0 A	ST202M-Z32
35.0 A	ST202M-Z35			
40.0 A	ST202M-Z40			
50.0 A	ST202M-Z50			
60.0 A	ST202M-Z60			
63.0 A	ST202M-Z63			

3 poles	Box Qty	Weight each (kg)	Rated Current	Part number
	1	0.345	0.5 A	ST203M-Z0.5
			1.0 A	ST203M-Z1
			1.6 A	ST203M-Z1.6
			2.0 A	ST203M-Z2
			3.0 A	ST203M-Z3
			4.0 A	ST203M-Z4
			5.0 A	ST203M-Z5
			6.0 A	ST203M-Z6
			7.0 A	ST203M-Z7
			8.0 A	ST203M-Z8
			10.0 A	ST203M-Z10
			13.0 A	ST203M-Z13
			15.0 A	ST203M-Z15
			16.0 A	ST203M-Z16
			20.0 A	ST203M-Z20
			25.0 A	ST203M-Z25
			30.0 A	ST203M-Z30
			32.0 A	ST203M-Z32
35.0 A	ST203M-Z35			
40.0 A	ST203M-Z40			
50.0 A	ST203M-Z50			
60.0 A	ST203M-Z60			
63.0 A	ST203M-Z63			

ST200M series

Z tripping characteristic (cont.)

3 poles+ Neutral	Box Qty	Weight each (kg)	Rated Current	Part number
	1	0.460	0.5 A	ST203M-Z0.5NA
			1.0 A	ST203M-Z1NA
			1.6 A	ST203M-Z1.6NA
			2.0 A	ST203M-Z2NA
			3.0 A	ST203M-Z3NA
			4.0 A	ST203M-Z4NA
			5.0 A	ST203M-Z5NA
			6.0 A	ST203M-Z6NA
			7.0 A	ST203M-Z7NA
			8.0 A	ST203M-Z8NA
			10.0 A	ST203M-Z10NA
			13.0 A	ST203M-Z13NA
			15.0 A	ST203M-Z15NA
			16.0 A	ST203M-Z16NA
			20.0 A	ST203M-Z20NA
			25.0 A	ST203M-Z25NA
			30.0 A	ST203M-Z30NA
			32.0 A	ST203M-Z32NA
			35.0 A	ST203M-Z35NA
			40.0 A	ST203M-Z40NA
			50.0 A	ST203M-Z50NA
			60.0 A	ST203M-Z60NA
			63.0 A	ST203M-Z63NA



4 poles	Box Qty	Weight each (kg)	Rated Current	Part number
	1	0.460	0.5 A	ST204M-Z0.5
			1.0 A	ST204M-Z1
			1.6 A	ST204M-Z1.6
			2.0 A	ST204M-Z2
			3.0 A	ST204M-Z3
			4.0 A	ST204M-Z4
			5.0 A	ST204M-Z5
			6.0 A	ST204M-Z6
			7.0 A	ST204M-Z7
			8.0 A	ST204M-Z8
			10.0 A	ST204M-Z10
			13.0 A	ST204M-Z13
			15.0 A	ST204M-Z15
			16.0 A	ST204M-Z16
			20.0 A	ST204M-Z20
			25.0 A	ST204M-Z25
			30.0 A	ST204M-Z30
			32.0 A	ST204M-Z32
			35.0 A	ST204M-Z35
			40.0 A	ST204M-Z40
			50.0 A	ST204M-Z50
			60.0 A	ST204M-Z60
			63.0 A	ST204M-Z63





Notes

A series of horizontal dotted lines for taking notes.



S200MR series

UL 1077 Supplementary Protectors



The S200MR is a high-performance supplementary protector with ring cable lug connections conforming to UL , CSA , and IEC standards.

The integrated captive connecting screws simplify the connection of electric lines, providing extra protection and time saving.

The S200MR is also fully compatible with System pro M compact® accessories.

General Data	S200MR
Amperage	0.2 up to 63 A
Voltage	480Y/277 V AC
Poles	1, 2, 3, 4
Trip curves	K
Short circuit interrupt rating	10 kA
Auxiliary contacts	Yes
Ambient temperature	-25 ... +55 °C
Mechanical life	20,000 operations
Bell alarm	Yes
Shunt trip	Yes
Undervoltage release	Yes
Busbar	Yes

Features

- High performance MCB with interrupt rating up to 10 kA
- DIN rail mounting
- CE certified and marked
- CSA 22.2 No. 235 and UL1077 (UL file #E76126) certified
- Energy limiting
- Fast breaking time (2.3 to 2.5 ms)
- Wide range of accessories
- Finger-safe terminals
- Ring terminals
- Suitable for reverse feed
- High calibration temperature of 40 °C for reduced derating in ICP applications
- Laser printing provides clear product information on device
- Clear contact position indication in red/green ("real CPI")
- Unique, patented twin terminal for wiring up to 35 mm² with captive screws
- Field wiring available for most types
- Bus connection system
- Robust thermoplastic housing material for better protection against external influences

S200MR (ring terminals) series

K tripping characteristic

1 pole



Box Qty	Weight each (kg)	Rated current	Part number
10	0.140	0.2 A	S201MR-K0.2
		0.3 A	S201MR-K0.3
		0.5 A	S201MR-K0.5
		0.75 A	S201MR-K0.75
		1.0 A	S201MR-K1
		1.6 A	S201MR-K1.6
		2.0 A	S201MR-K2
		3.0 A	S201MR-K3
		4.0 A	S201MR-K4
		5.0 A	S201MR-K5
		6.0 A	S201MR-K6
		8.0 A	S201MR-K8
		10.0 A	S201MR-K10
		13.0 A	S201MR-K13
		15.0 A	S201MR-K15
		16.0 A	S201MR-K16
		20.0 A	S201MR-K20
		25.0 A	S201MR-K25
		30.0 A	S201MR-K30
		32.0 A	S201MR-K32
35.0 A	S201MR-K35		
40.0 A	S201MR-K40		
50.0 A	S201MR-K50		
60.0 A	S201MR-K60		
63.0 A	S201MR-K63		

2 pole



Box Qty	Weight each (kg)	Rated current	Part number
5	0.280	0.2 A	S202MR-K0.2
		0.3 A	S202MR-K0.3
		0.5 A	S202MR-K0.5
		0.75 A	S202MR-K0.75
		1.0 A	S202MR-K1
		1.6 A	S202MR-K1.6
		2.0 A	S202MR-K2
		3.0 A	S202MR-K3
		4.0 A	S202MR-K4
		5.0 A	S202MR-K5
		6.0 A	S202MR-K6
		8.0 A	S202MR-K8
		10.0 A	S202MR-K10
		13.0 A	S202MR-K13
		15.0 A	S202MR-K15
		16.0 A	S202MR-K16
		20.0 A	S202MR-K20
		25.0 A	S202MR-K25
		30.0 A	S202MR-K30
		32.0 A	S202MR-K32
35.0 A	S202MR-K35		
40.0 A	S202MR-K40		
50.0 A	S202MR-K50		
60.0 A	S202MR-K60		
63.0 A	S202MR-K63		

3 pole



Box Qty	Weight each (kg)	Rated current	Part number
3	0.420	0.2 A	S203MR-K0.2
		0.3 A	S203MR-K0.3
		0.5 A	S203MR-K0.5
		0.75 A	S203MR-K0.75
		1.0 A	S203MR-K1
		1.6 A	S203MR-K1.6
		2.0 A	S203MR-K2
		3.0 A	S203MR-K3
		4.0 A	S203MR-K4
		5.0 A	S203MR-K5
		6.0 A	S203MR-K6
		8.0 A	S203MR-K8
		10.0 A	S203MR-K10
		13.0 A	S203MR-K13
		15.0 A	S203MR-K15
		16.0 A	S203MR-K16
		20.0 A	S203MR-K20
		25.0 A	S203MR-K25
		30.0 A	S203MR-K30
		32.0 A	S203MR-K32
35.0 A	S203MR-K35		
40.0 A	S203MR-K40		
50.0 A	S203MR-K50		
60.0 A	S203MR-K60		
63.0 A	S203MR-K63		

4 pole

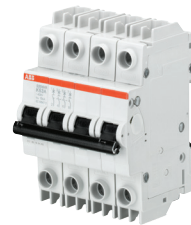

Box Qty	Weight each (kg)	Rated current	Part number
2	0.560	0.2 A	S204MR-K0.2
		0.3 A	S204MR-K0.3
		0.5 A	S204MR-K0.5
		0.75 A	S204MR-K0.75
		1.0 A	S204MR-K1
		1.6 A	S204MR-K1.6
		2.0 A	S204MR-K2
		3.0 A	S204MR-K3
		4.0 A	S204MR-K4
		5.0 A	S204MR-K5
		6.0 A	S204MR-K6
		8.0 A	S204MR-K8
		10.0 A	S204MR-K10
		13.0 A	S204MR-K13
		15.0 A	S204MR-K15
		16.0 A	S204MR-K16
		20.0 A	S204MR-K20
		25.0 A	S204MR-K25
		30.0 A	S204MR-K30
		32.0 A	S204MR-K32
35.0 A	S204MR-K35		
40.0 A	S204MR-K40		
50.0 A	S204MR-K50		
60.0 A	S204MR-K60		
63.0 A	S204MR-K63		

S200MUC series

UL 1077 Supplementary Protectors



The S200MUC extends the established ABB System pro M compact® product range with an MCB for DC and AC applications.

The S200MUC impresses with its extended DC performances up to 500Vdc.

Its high inbuilt short circuit breaking capacity across the entire model line, its flexible AC and DC application and its approval and compliance in accordance with all major international and local standards make it truly unique.

General Data	S200MUC
Amperage	0.2 up to 63 A
Voltage	480Y/277 V AC 250/500 V DC
Poles	1, 2, 3, 4
Trip curves	C, K, Z
Short circuit interrupt rating	10 kA
Auxiliary contacts	Yes
Ambient temperature	-25 ... +55 °C
Mechanical life	20,000 operations
Bell alarm	Yes
Shunt trip	Yes
Undervoltage release	Yes
Busbar	Yes

Features

- High performance MCB with interrupt rating up to 10 kA
- DIN rail mounting
- CE certified and marked
- CSA 22.2 No. 235 and UL1077 (UL file #E76126) certified
- Energy limiting
- Fast breaking time (2.3 to 2.5 ms)
- Wide range of accessories
- Finger-safe terminals
- Suitable for reverse feed in AC only
- High calibration temperature of 40 °C for reduced derating in ICP applications
- Laser printing provides clear product information on device
- Clear contact position indication in red/green ("real CPI")
- Unique, patented twin terminal for wiring up to 35 mm² with captive screws
- Field wiring available for most types
- Bus connection system
- Robust thermoplastic housing material for better protection against external influences

S200MUC series

C tripping characteristic

1 pole	Box Qty	Weight each (kg)	Rated Current	Part number
	10	0.125	0.5 A	S201MUC-C0.5
			1.0 A	S201MUC-C1
			1.6 A	S201MUC-C1.6
			2.0 A	S201MUC-C2
			3.0 A	S201MUC-C3
			4.0 A	S201MUC-C4
			6.0 A	S201MUC-C6
			8.0 A	S201MUC-C8
			10.0 A	S201MUC-C10
			13.0 A	S201MUC-C13
			16.0 A	S201MUC-C16
			20.0 A	S201MUC-C20
			25.0 A	S201MUC-C25
			32.0 A	S201MUC-C32
			40.0 A	S201MUC-C40
			50.0 A	S201MUC-C50
		63.0 A	S201MUC-C63	

2 poles	Box Qty	Weight each (kg)	Rated Current	Part number
	5	0.250	0.5 A	S202MUC-C0.5
			1.0 A	S202MUC-C1
			1.6 A	S202MUC-C1.6
			2.0 A	S202MUC-C2
			3.0 A	S202MUC-C3
			4.0 A	S202MUC-C4
			6.0 A	S202MUC-C6
			8.0 A	S202MUC-C8
			10.0 A	S202MUC-C10
			13.0 A	S202MUC-C13
			16.0 A	S202MUC-C16
			20.0 A	S202MUC-C20
			25.0 A	S202MUC-C25
			32.0 A	S202MUC-C32
			40.0 A	S202MUC-C40
			50.0 A	S202MUC-C50
		63.0 A	S202MUC-C63	

3 poles	Box Qty	Weight each (kg)	Rated Current	Part number
	1	0.375	0.5 A	S203MUC-C0.5
			1.0 A	S203MUC-C1
			1.6 A	S203MUC-C1.6
			2.0 A	S203MUC-C2
			3.0 A	S203MUC-C3
			4.0 A	S203MUC-C4
			6.0 A	S203MUC-C6
			8.0 A	S203MUC-C8
			10.0 A	S203MUC-C10
			13.0 A	S203MUC-C13
			16.0 A	S203MUC-C16
			20.0 A	S203MUC-C20
			25.0 A	S203MUC-C25
			32.0 A	S203MUC-C32
			40.0 A	S203MUC-C40
			50.0 A	S203MUC-C50
		63.0 A	S203MUC-C63	

4 poles	Box Qty	Weight each (kg)	Rated Current	Part number
	1	0.500	0.5 A	S204MUC-C0.5
			1.0 A	S204MUC-C1
			1.6 A	S204MUC-C1.6
			2.0 A	S204MUC-C2
			3.0 A	S204MUC-C3
			4.0 A	S204MUC-C4
			6.0 A	S204MUC-C6
			8.0 A	S204MUC-C8
			10.0 A	S204MUC-C10
			13.0 A	S204MUC-C13
			16.0 A	S204MUC-C16
			20.0 A	S204MUC-C20
			25.0 A	S204MUC-C25
			32.0 A	S204MUC-C32
			40.0 A	S204MUC-C40
			50.0 A	S204MUC-C50
		63.0 A	S204MUC-C63	

S200MUC series

K tripping characteristic

1 pole	Box Qty	Weight each (kg)	Rated current	Part number
	10	0.125	0.2 A	S201MUC-K0.2
			0.3 A	S201MUC-K0.3
			0.5 A	S201MUC-K0.5
			0.75 A	S201MUC-K0.75
			1.0 A	S201MUC-K1
			1.6 A	S201MUC-K1.6
			2.0 A	S201MUC-K2
			3.0 A	S201MUC-K3
			4.0 A	S201MUC-K4
			5.0 A	S201MUC-K5
			6.0 A	S201MUC-K6
			8.0 A	S201MUC-K8
			10.0 A	S201MUC-K10
			13.0 A	S201MUC-K13
			15.0 A	S201MUC-K15
			16.0 A	S201MUC-K16
			20.0 A	S201MUC-K20
			25.0 A	S201MUC-K25
			30.0 A	S201MUC-K30
			32.0 A	S201MUC-K32
35.0 A	S201MUC-K35			
40.0 A	S201MUC-K40			
50.0 A	S201MUC-K50			
60.0 A	S201MUC-K60			
63.0 A	S201MUC-K63			

2 pole	Box Qty	Weight each (kg)	Rated current	Part number
	5	0.250	0.2 A	S202MUC-K0.2
			0.3 A	S202MUC-K0.3
			0.5 A	S202MUC-K0.5
			0.75 A	S202MUC-K0.75
			1.0 A	S202MUC-K1
			1.6 A	S202MUC-K1.6
			2.0 A	S202MUC-K2
			3.0 A	S202MUC-K3
			4.0 A	S202MUC-K4
			5.0 A	S202MUC-K5
			6.0 A	S202MUC-K6
			8.0 A	S202MUC-K8
			10.0 A	S202MUC-K10
			13.0 A	S202MUC-K13
			15.0 A	S202MUC-K15
			16.0 A	S202MUC-K16
			20.0 A	S202MUC-K20
			25.0 A	S202MUC-K25
			30.0 A	S202MUC-K30
			32.0 A	S202MUC-K32
35.0 A	S202MUC-K35			
40.0 A	S202MUC-K40			
50.0 A	S202MUC-K50			
60.0 A	S202MUC-K60			
63.0 A	S202MUC-K63			

3 pole	Box Qty	Weight each (kg)	Rated current	Part number
	1	0.375	0.2 A	S203MUC-K0.2
			0.3 A	S203MUC-K0.3
			0.5 A	S203MUC-K0.5
			0.75 A	S203MUC-K0.75
			1.0 A	S203MUC-K1
			1.6 A	S203MUC-K1.6
			2.0 A	S203MUC-K2
			3.0 A	S203MUC-K3
			4.0 A	S203MUC-K4
			5.0 A	S203MUC-K5
			6.0 A	S203MUC-K6
			8.0 A	S203MUC-K8
			10.0 A	S203MUC-K10
			13.0 A	S203MUC-K13
			15.0 A	S203MUC-K15
			16.0 A	S203MUC-K16
			20.0 A	S203MUC-K20
			25.0 A	S203MUC-K25
			30.0 A	S203MUC-K30
			32.0 A	S203MUC-K32
35.0 A	S203MUC-K35			
40.0 A	S203MUC-K40			
50.0 A	S203MUC-K50			
60.0 A	S203MUC-K60			
63.0 A	S203MUC-K63			

4 pole	Box Qty	Weight each (kg)	Rated current	Part number
	1	0.500	0.2 A	S204MUC-K0.2
			0.3 A	S204MUC-K0.3
			0.5 A	S204MUC-K0.5
			0.75 A	S204MUC-K0.75
			1.0 A	S204MUC-K1
			1.6 A	S204MUC-K1.6
			2.0 A	S204MUC-K2
			3.0 A	S204MUC-K3
			4.0 A	S204MUC-K4
			5.0 A	S204MUC-K5
			6.0 A	S204MUC-K6
			8.0 A	S204MUC-K8
			10.0 A	S204MUC-K10
			13.0 A	S204MUC-K13
			15.0 A	S204MUC-K15
			16.0 A	S204MUC-K16
			20.0 A	S204MUC-K20
			25.0 A	S204MUC-K25
			30.0 A	S204MUC-K30
			32.0 A	S204MUC-K32
35.0 A	S204MUC-K35			
40.0 A	S204MUC-K40			
50.0 A	S204MUC-K50			
60.0 A	S204MUC-K60			
63.0 A	S204MUC-K63			

S200MUC series

Z tripping characteristic

1 pole	Box Qty	Weight each (kg)	Rated current	Part number
	10	0.125	0.5 A	S201MUC-Z0.5
			1.0 A	S201MUC-Z1
			1.6 A	S201MUC-Z1.6
			2.0 A	S201MUC-Z2
			3.0 A	S201MUC-Z3
			4.0 A	S201MUC-Z4
			5.0 A	S201MUC-Z5
			6.0 A	S201MUC-Z6
			8.0 A	S201MUC-Z8
			10.0 A	S201MUC-Z10
			15.0 A	S201MUC-Z15
			16.0 A	S201MUC-Z16
			20.0 A	S201MUC-Z20
			25.0 A	S201MUC-Z25
			30.0 A	S201MUC-Z30
			32.0 A	S201MUC-Z32
			35.0 A	S201MUC-Z35
			40.0 A	S201MUC-Z40
			50.0 A	S201MUC-Z50
			60.0 A	S201MUC-Z60
63.0 A	S201MUC-Z63			

2 pole	Box Qty	Weight each (kg)	Rated current	Part number
	5	0.250	0.5 A	S202MUC-Z0.5
			1.0 A	S202MUC-Z1
			1.6 A	S202MUC-Z1.6
			2.0 A	S202MUC-Z2
			3.0 A	S202MUC-Z3
			4.0 A	S202MUC-Z4
			5.0 A	S202MUC-Z5
			6.0 A	S202MUC-Z6
			8.0 A	S202MUC-Z8
			10.0 A	S202MUC-Z10
			15.0 A	S202MUC-Z15
			16.0 A	S202MUC-Z16
			20.0 A	S202MUC-Z20
			25.0 A	S202MUC-Z25
			30.0 A	S202MUC-Z30
			32.0 A	S202MUC-Z32
			35.0 A	S202MUC-Z35
			40.0 A	S202MUC-Z40
			50.0 A	S202MUC-Z50
			60.0 A	S202MUC-Z60
63.0 A	S202MUC-Z63			



3 pole	Box Qty	Weight each (kg)	Rated current	Part number
	1	0.375	0.5 A	S203MUC-Z0.5
			1.0 A	S203MUC-Z1
			1.6 A	S203MUC-Z1.6
			2.0 A	S203MUC-Z2
			3.0 A	S203MUC-Z3
			4.0 A	S203MUC-Z4
			5.0 A	S203MUC-Z5
			6.0 A	S203MUC-Z6
			8.0 A	S203MUC-Z8
			10.0 A	S203MUC-Z10
			15.0 A	S203MUC-Z15
			16.0 A	S203MUC-Z16
			20.0 A	S203MUC-Z20
			25.0 A	S203MUC-Z25
			30.0 A	S203MUC-Z30
			32.0 A	S203MUC-Z32
			35.0 A	S203MUC-Z35
			40.0 A	S203MUC-Z40
			50.0 A	S203MUC-Z50
			60.0 A	S203MUC-Z60
63.0 A	S203MUC-Z63			

4 pole	Box Qty	Weight each (kg)	Rated current	Part number
	1	0.500	0.5 A	S204MUC-Z0.5
			1.0 A	S204MUC-Z1
			1.6 A	S204MUC-Z1.6
			2.0 A	S204MUC-Z2
			3.0 A	S204MUC-Z3
			4.0 A	S204MUC-Z4
			5.0 A	S204MUC-Z5
			6.0 A	S204MUC-Z6
			8.0 A	S204MUC-Z8
			10.0 A	S204MUC-Z10
			15.0 A	S204MUC-Z15
			16.0 A	S204MUC-Z16
			20.0 A	S204MUC-Z20
			25.0 A	S204MUC-Z25
			30.0 A	S204MUC-Z30
			32.0 A	S204MUC-Z32
			35.0 A	S204MUC-Z35
			40.0 A	S204MUC-Z40
			50.0 A	S204MUC-Z50
			60.0 A	S204MUC-Z60
63.0 A	S204MUC-Z63			

Accessories

Electrical accessories

Auxiliary contacts and bell alarms

	Description	Part number
	1 SPDT auxiliary contact (form C) The auxiliary contacts will signal whether the breaker is in the ON or OFF position. Mounts on the right side of the breaker up to maximum of 3 sets	S2C-H6R
	1 NO + 1 NC auxiliary contact The auxiliary contacts will signal whether the breaker is in the ON or OFF position. Mounts on the right side of the breaker up to maximum of 2 sets	S2C-H6-11R
	2 NO auxiliary contact The auxiliary contacts will signal whether the breaker is in the ON or OFF position. Mounts on the right side of the breaker up to maximum of 2 sets	S2C-H6-20R
	2 NC auxiliary contact (2 NC) The auxiliary contacts will signal whether the breaker is in the ON or OFF position. Mounts on the right side of the breaker up to maximum of 2 sets	S2C-H6-02R
	1 NC auxiliary micro contact (bottom fitting)	S2C-H01
	1 NO auxiliary micro contact (bottom fitting)	S2C-H10
	Bell alarm contact (1 form C) The bell alarm includes a set of contacts that will only signal when the breaker has tripped. It also includes a test button for testing the alarm contacts without opening the breaker. Mounts on the right side of the breaker up to a maximum of 3 sets	S2C-S/H6R

Possible mounting arrangements of auxiliary contacts

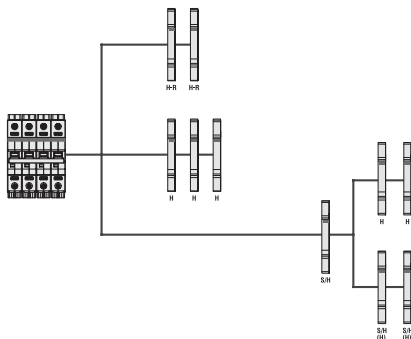



Legend

Auxiliary contact S2C-H6R	H
Auxiliary contact S2C-H6-..R	H-R
Bell alarm/auxiliary contact S2C-S/H6R	S/H
Bell alarm/auxiliary contact used as auxiliary contact	S/H (H)

Accessories

Electrical accessories

Shunt trips and undervoltage release

	Description	Part number
	12...60 Vac/dc shunt trip For remote tripping of breaker when control voltage is applied	S2C-A1
	110...415 Vac (110...250 Vdc) shunt trip For remote tripping of breaker when control voltage is applied	S2C-A2
	12 Vdc undervoltage release Used to trip the breaker when voltage drops below approximately 50% of control voltage	S2C-UA12DC
	24 Vac or 24 Vdc undervoltage release Used to trip the breaker when voltage drops below approximately 50% of control voltage	S2C-UA24AC S2C-UA24DC
	48 Vac or 48 Vdc undervoltage release Used to trip the breaker when voltage drops below approximately 50% of control voltage	S2C-UA48AC S2C-UA48DC
	110 Vac or 110 Vdc undervoltage release Used to trip the breaker when voltage drops below approximately 50% of control voltage	S2C-UA110AC S2C-UA110DC
	230 Vac or 230 Vdc undervoltage release Used to trip the breaker when voltage drops below approximately 50% of control voltage	S2C-UA230AC S2C-UA230DC
	400 Vac undervoltage release Used to trip the breaker when voltage drops below approximately 50% of control voltage	S2C-UA400AC

Possible mounting arrangements of shunt trips and undervoltage release.

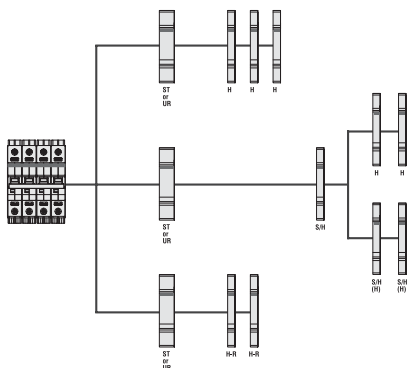

Legend	
Auxiliary contact S2C-H6R	H
Auxiliary contact S2C-H6..R	H-R
Bell alarm/auxiliary contact S2C-S/H6R	S/H
Bell alarm/auxiliary contact used as auxiliary contact	S/H (H)
Shunt trip S2C-A...	ST
Undervoltage release S2C-UA..	UR

Accessories





Electrical accessories

Busbars for S200 and S200P (cuttable)

	Maximum Amp.	Cross-section	Phase	Nbr of pins	Phase sequence	Part number
	80 A ⁽¹⁾	18 mm ²	1	57	L1-L1-L1...	PS 1/57/18 CB
				37	L1-AUX-L1-AUX...	PS 1/37/18 H CB
			2	56	L1-L2-L1-L2...	PS 2/56/18 CB
				46	L1-L2-AUX-L1-L2-AUX...	PS 2/46/18 H CB
			3	57	L1-L2-L3-L1-L2-L3...	PS 3/57/18 CB
				48	L1-L2-L3-AUX-L1-L2-L3-AUX...	PS 3/48/18 H CB
	100 A ⁽¹⁾	25 mm ²	1	57	L1-L1-L1...	PS 1/57/25 CB
				37	L1-AUX-L1-AUX...	PS 1/37/25 H CB
				56	L1-L2-L1-L2...	PS 2/56/25 CB
				46	L1-L2-AUX-L1-L2-AUX...	PS 2/46/25 H CB
				57	L1-L2-L3-L1-L2-L3...	PS 3/57/25 CB
				48	L1-L2-L3-AUX-L1-L2-L3-AUX...	PS 3/48/25 H CB
			39	L1-AUX-L2-AUX-L3-AUX...	PS 3/39/25 H CB	

⁽¹⁾ Maximum rating of busbar with end-feeding. For center-fed details, please consult technical detail section of the accessories.

Accessories for busbars (cuttable)

	Description	Part number
	1 phase busbar end caps	PS-END 1 CB
	2 and 3 phase busbar end caps	PS-END 3 CB
	Busbar pin cover (covers 5 unused pins)	BSK CB
	Feeder terminal with pin contact for use with MCB and 1-phase busbar	AST 35/15-2 CB
	Feeder terminal with pin contact for use with MCB and 2-/3-phase busbar	AST 35/38-2 CB
	Feeder terminal with pin contact for use with E90 and 2-/3-phase busbar	AST 35/38-1 CB
	Feeder terminal with pin contact for use with E90 and 1-phase busbar	AST 35/15-1 CB
	Single pole feeder terminal can be mounted side by side, feed to the busbar pin	SZ-ESKSP

Accessories

Mechanical accessories

Rotary handle mechanism



Description	Part number
External handle rotary drive. For the actuation of 2, 3 or 4 pole miniature circuit breakers. To be used with 5 or 6 mm ² shafts	S2C-DH

External handles



Description	Color	With defeater	Part number
Type 3R/12 selector handle, padlockable with maximum 3 padlocks (bail diameter 5..8mm) with door interlock in ON position. Available with defeating option to allow the MCB to stay in ON state when opening the door.	Black	Yes	OHBS2AJ
		No	OHBS2AJ1
	Yellow-Red	Yes	OHYS2AJ
		No	OHYS2AJ1
	Silver	Yes	OHSS2AJ
		No	OHSS2AJ1
	Grey	Yes	OHGS2AJ
		No	OHGS2AJ1

Shafts

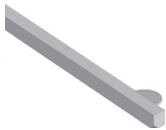



Description	Length	Part number
Shaft extensions to be used with selector typ handles. Shafts are cuttable. 6 mm ² diameter	85 mm	OXS6X85
	105 mm	OXS6X105
	120 mm	OXS6X120
	130 mm	OXS6X130
	160 mm	OXS6X160
	180 mm	OXS6X180
	250 mm	OXS6X250
	330 mm	OXS6X330

Accessories

Mechanical accessories

Locking device and padlock

	Description	Used with	Part number
	Locking device (3mm hasp)	S200 series	SA1
	Padlock with 2 keys	Locking device	SA2

False pole

	Description	Used with	Part number
	Used to fill empty spaces on DIN rails (one of each is required)	False pole (1)	FP1
		DIN rail support for false pole	SFP

Front flange mounting kits

	Description	Nbr of MCBs	Part number
	Front flange mounting kit	1	ME1-1
		2	ME2-2
		3	ME3-3
		4	ME4-4
		6	ME6-6
		8	ME8-8

Technical details

ST200M, S200MR, S200MUC series

Technical specifications MCBs

	ST200M	S200MR	S200MUC
Specifications	CSA C22.2 No.235 UL1077 IEC 60947-2	CSA C22.2 No.235 UL1077 IEC 60947-2	CSA C22.2 No.235 UL1077 IEC 60947-2
Nbr of poles	1, 1+N, 2, 3, 3+N, 4	1, 2, 3, 4	1,2
Trip curves	B, C, D, K, Z	K	B, C, K, Z
Amperage	0.5...63 A	0.2...63 A	0.2...63 A
Voltage AC	480Y/277 Vac	480Y/277 Vac	480Y/277 Vac
Voltage DC (1p/2p)	60/125 Vdc	-	250/500 Vdc
Interrupt rating	10 kA (up to 32A) 5 kA (35...63A)	10 kA	10 kA (DC) 6 kA (AC)
Calibration temp	40°C	25°C	25°C
Mounting position	Any	Any	Any
Protection degree	IP20	IP20	IP20
Mounting	35 mm DIN rail	35 mm DIN rail	35 mm DIN rail
Tightening torque	25 in-lbs 2.8Nm	25 in-lbs 2.8Nm	25 in-lbs 2.8Nm
Terminal wire size	18...4 AWG	18...4 AWG	18...4 AWG
Ambient temperature (mechanical)	-25°C...+55°C -13°F...+131°F	-25°C...+55°C -13°F...+131°F	-25°C...+55°C -13°F...+131°F
Shock resistance (IEC60068-2-27)	25g - 2 shocks - 13ms	25g - 2 shocks - 13ms	25g - 2 shocks - 13ms
Mechanical life	20,000 ops	20,000 ops	20,000 ops

Technical details

ST200M, S200MR, S200MUC series

Internal resistance and power loss per pole (ST200M)

Rated current (A)	B, C, K tripping characteristics		D tripping characteristic		Z tripping characteristic	
	Internal resistance (mΩ)	Power loss (W)	Internal resistance (mΩ)	Power loss (W)	Internal resistance (mΩ)	Power loss (W)
0.5	5500	1.40	4300	1.10	8100	2.40
1	1440	1.40	1250	1.25	2100	2.30
1.6	645	1.80	600	1.50	1000	2.80
2	460	1.80	410	1.70	620	2.50
3	150	1.60	130	1.20	235	2.40
4	110	1.80	105	1.70	150	2.40
5	55.0	1.40	52.0	1.30	75.0	1.90
6	55.0	2.00	52.0	1.90	75.0	3.20
7	24.0	1.20	26.0	1.30	28.0	1.40
8	23.0	1.50	24.0	1.50	27.0	2.00
10	21.0	2.20	16.0	1.60	24.0	2.70
13	14.0	2.30	14.0	2.20	15.0	2.60
15	8.50	2.00	8.50	2.00	11.0	2.50
16	8.50	2.50	8.50	2.50	10.9	2.80
20	6.25	2.50	6.10	2.30	6.00	2.40
25	5.00	3.20	4.30	3.10	4.50	3.30
30	3.50	3.10	3.50	3.20	3.50	3.20
32	3.50	3.70	3.50	3.60	3.50	3.60
35	3.40	4.20	3.40	4.20	3.50	4.30
40	3.00	4.80	2.20	4.20	2.50	4.10
50	1.80	4.30	1.30	2.90	1.50	4.10
60	1.20	4.40	1.20	4.40	1.30	4.70
63	1.20	4.50	1.20	4.80	1.30	5.20

Technical details

ST200M, S200MR, S200MUC series

Internal resistance and power loss per pole (S200MR)

Rated current (A)	K tripping characteristic	
	Internal resistance (mΩ)	Power loss (W)
0.2	25300	1.01
0.3	13700	1.23
0.5	4740	1.19
0.75	2067	1.16
1	1270	1.27
1.5	610	1.56
2	442	1.77
3	140	1.26
4	109	1.75
5	50	1.26
6	54	1.94
8	22	1.41
10	18.2	1.82
13	14.8	2.50
15	8.10	1.83
16	11.1	2.83
20	8.50	3.40
25	5.50	3.43
30	3.80	3.39
32	4.60	4.70
35	3.90	4.76
40	2.80	4.40
50	1.70	4.25
60	1.70	6.18
63	1.90	7.56

Technical details

ST200M, S200MR, S200MUC series

Temperature derating (ST200M - B, C, D, K, Z tripping characteristics)

Standard	Rated current (A)	Maximum operating current (A) at ambient temperature T											
		- 40 °C	- 30 °C	- 20 °C	- 10 °C	0 °C	10 °C	20 °C	30 °C	40 °C	50 °C	60 °C	70 °C
Standard	0.5	0.65	0.63	0.61	0.59	0.57	0.56	0.54	0.52	0.50	0.48	0.46	0.44
	1	1.30	1.26	1.22	1.19	1.15	1.11	1.07	1.04	1.00	0.96	0.93	0.89
	1.6	2.06	2.01	1.96	1.90	1.84	1.78	1.72	1.66	1.60	1.54	1.48	1.42
	2	2.60	2.52	2.44	2.37	2.30	2.22	2.15	2.07	2.00	1.93	1.85	1.78
	3	3.89	3.78	3.67	3.56	3.44	3.33	3.22	3.11	3.00	2.89	2.78	2.67
	4	5.19	5.04	4.89	4.74	4.59	4.44	4.30	4.15	4.00	3.85	3.70	3.56
	5	6.50	6.31	6.13	5.94	5.75	5.56	5.38	5.00	5.00	4.81	4.63	4.44
	6	7.77	7.55	7.33	7.11	6.89	6.67	6.44	6.22	6.00	5.78	5.56	5.33
	7	9.10	8.84	8.58	8.31	8.05	7.79	7.53	7.00	7.00	6.74	6.48	6.21
	8	10.36	10.07	9.78	9.48	9.18	8.89	8.59	8.30	8.00	7.70	7.41	7.11
UL1077	10	13.00	12.60	12.20	11.90	11.50	11.10	10.70	10.40	10.00	9.60	9.30	8.90
	13	16.90	16.40	15.90	15.40	14.90	14.40	14.00	13.50	13.00	12.50	12.00	11.60
	15	19.50	18.94	18.38	17.81	17.25	16.69	16.13	16.00	15.00	14.44	13.88	13.31
	16	20.60	20.10	19.60	19.00	18.40	17.80	17.20	16.60	16.00	15.40	14.80	14.20
	20	26.00	25.20	24.40	23.70	23.00	22.20	21.50	20.70	20.00	19.30	18.50	17.80
	25	32.40	31.50	30.60	29.60	28.70	27.80	26.90	25.90	25.00	24.10	23.20	22.20
	30	39.00	37.88	36.75	35.63	34.50	33.38	32.25	31.00	30.00	28.88	27.75	26.63
	32	41.50	40.30	39.10	37.90	36.70	35.60	34.40	33.20	32.00	30.80	29.60	28.40
	35	47.00	45.30	43.70	42.10	40.60	39.10	37.70	36.30	35.00	33.70	32.50	31.30
	40	51.90	50.40	48.90	47.40	45.90	44.40	43.00	41.50	40.00	38.50	37.00	35.60
	50	64.90	63.00	61.10	59.30	57.40	55.60	53.70	51.90	50.00	48.20	46.30	44.50
	60	80.50	77.60	74.80	72.10	69.50	67.00	64.60	62.30	60.00	57.80	55.70	53.70
	63	81.60	79.30	77.00	74.70	72.30	70.00	67.70	65.30	63.00	60.70	58.30	56.00

Technical details

ST200M, S200MR, S200MUC series

Temperature derating (S200MR/S200MUC - K, Z tripping characteristics)

		Maximum operating current (A) at ambient temperature T												
Standard	Rated current (A)	- 40 °C	- 30 °C	- 20 °C	- 10 °C	0 °C	10 °C	20 °C	30 °C	40 °C	50 °C	60 °C	70 °C	
Standard	0.5	0.66	0.64	0.61	0.59	0.56	0.53	0.5	0.47	0.43	0.40	0.35	0.31	
	1	1.32	1.27	1.22	1.17	1.12	1.06	1.0	0.94	0.87	0.79	0.71	0.61	
	1.6	2.12	2.04	1.96	1.88	1.79	1.70	1.6	1.50	1.39	1.26	1.13	0.98	
	2	2.65	2.55	2.45	2.35	2.24	2.12	2.0	1.87	1.73	1.58	1.41	1.22	
	3	4.00	3.80	3.70	3.50	3.40	3.20	3.0	2.80	2.60	2.40	2.10	1.80	
	4	5.30	5.10	4.90	4.70	4.50	4.20	4.0	3.70	3.50	3.20	2.80	2.40	
	6	7.90	7.60	7.30	7.00	6.70	6.40	6.0	5.60	5.20	4.70	4.20	3.70	
	8	10.8	10.2	9.80	9.40	8.90	8.50	8.0	7.50	6.90	6.30	5.70	4.90	
	IEC / UL / CSA	10	13.2	12.7	12.2	11.7	11.2	10.6	10.0	9.40	8.70	7.90	7.10	6.10
		13	17.2	16.6	15.9	15.2	14.5	13.8	13.0	12.2	11.3	10.3	9.20	8.00
16		21.2	20.4	19.6	18.8	17.9	17.0	16.0	15.0	13.9	12.6	11.3	9.80	
20		26.5	25.5	24.5	23.5	22.4	21.2	20.0	18.7	17.3	15.8	14.1	12.2	
25		33.1	31.9	30.6	29.3	28.0	26.5	25.0	23.4	21.7	19.8	17.7	15.3	
32		42.3	40.8	39.2	37.5	35.8	33.9	32.0	29.9	27.7	25.3	22.6	19.6	
40		52.9	51.0	49.0	46.9	44.7	42.4	40.0	37.4	34.6	31.6	28.3	24.5	
50		66.1	63.7	61.2	58.6	55.9	53.0	50.0	46.8	43.3	39.5	35.4	30.6	
63		83.3	80.3	77.2	73.9	70.4	66.8	63.0	58.9	54.6	49.8	44.5	38.6	

Technical details

Electrical accessories

Technical specifications auxiliary contacts

	S2C-H6R	S2C-H6-11R	S2C-H6-20R	S2C-H6-02R	S2C-H01	S2C-H10	S2C-S/H6R
Amperage	10 A	10 A	10 A	10 A	7.5 A	7.5 A	10 A
Voltage	230 Vac	230 Vac	230 Vac	230 Vac	230 Vac	230 Vac	230 Vac
Contact type	1 CO	1 NO+1 NC	2 NO	2 NC	1 NC	1 NO	1 CO
Terminal wire capacity	#18...14 AWG	#18...14 AWG	#18...14 AWG	#18...14 AWG	#18...14 AWG	#18...14 AWG	#18...14 AWG
Installation / wiring	See below	See below	See below	See below	See below	See below	See below
Tightening torque	1.2Nm	1.2 Nm	1.2 Nm	1.2 Nm	0.5 Nm	0.5 Nm	1.2 Nm
Shock resistance (DIN IEC 68-2-6)	5g, 20 cycles (5...150...5 Hz) at 24 Vac/dc, 5mA auto- reclosing < 10 ms	5g, 20 cycles (5...150...5 Hz) at 24 Vac/dc, 5mA auto- reclosing < 10 ms	5g, 20 cycles (5...150...5 Hz) at 24 Vac/dc, 5mA auto- reclosing < 10 ms	5g, 20 cycles (5...150...5 Hz) at 24 Vac/dc, 5mA auto- reclosing < 10 ms	-	-	5g, 20 cycles (5...150...5 Hz) at 24 Vac/dc, 5mA auto- reclosing < 10 ms
Mechanical life	10,000 ops	10,000 ops	10,000 ops	10,000 ops	10,000 ops	10,000 ops	10,000 ops

Connection drawings and installation

S2C-H6R

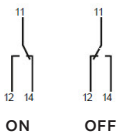

S2C-H6-11R

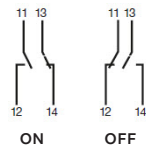

S2C-H6-20R

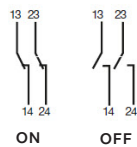

S2C-H6-02R

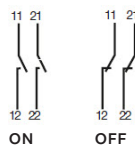

Mounting instruction of S2C-H6...

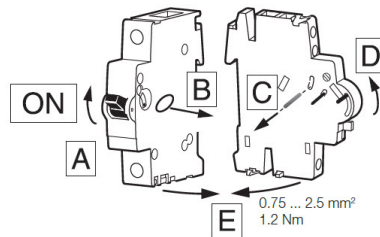

Mounting instruction of S2C-H10/H01

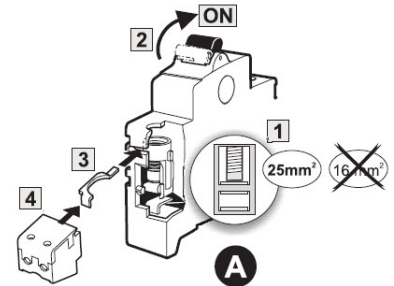

S2C-S/H6R (as signal contact)

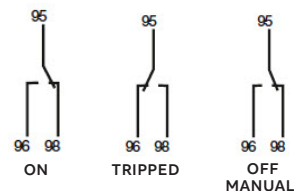

Mounting instruction of S2C-S/H6R

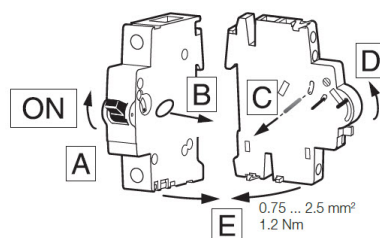

Selection of signal or auxiliary contact

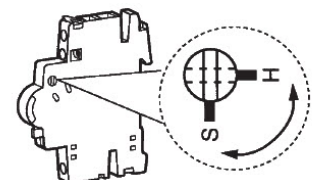

Technical details

Electrical accessories

Technical specifications busbars (Electrical)

	PS...SP
Standards	UL1077, EN 60947-1 / IEC 60947-1
Rated voltage	480 Vac
Rated frequency	50 / 60 Hz
Rated current ⁽¹⁾	up to 80 A (130 A center-fed)
Short circuit current rating (SCCR)	10 kA in series with fuse.

⁽¹⁾ In case of feed in from the middle of the busbar it needs to be ensured, that the sum of junction currents per side must not exceed the max busbar current. Irrespective of current carrying capacity of the busbar, the max rated current of the devices terminal may not be exceeded

Technical specifications busbars (mechanical)

	PS...SP
Housing	Light grey RAL 7035
Resistance to climatic conditions	According to DIN EN 60068
Overvoltage category	III
Pollution degree	2

Technical specifications busbars (installation)

	PS...SP
Cross section	10 mm ² or 16 mm ²
Mounting position	Optional
Supply	Via MCB terminal or feeder terminal (AST35/15SP)

Technical specifications busbars (accessories)

	PS...SP
SZ-ESKSP wire size	#1 AWG (50 mm ²)
AST35/15SP wire size	#2 AWG (35 mm ²)

Technical specifications busbars (approvals)

	PS...SP
UL 1077, cURus	

Tripping curves details

B tripping curve

Description

Available with the ST200M series only. The "B" time-current curve is designed primarily for use in cable protection applications. Instantaneous tripping occurs between approximately 3 to 5 times rated current in 50/60Hz systems. This quick trip curve maximizes protection of control circuits under low short circuit fault levels that could damage control wiring.

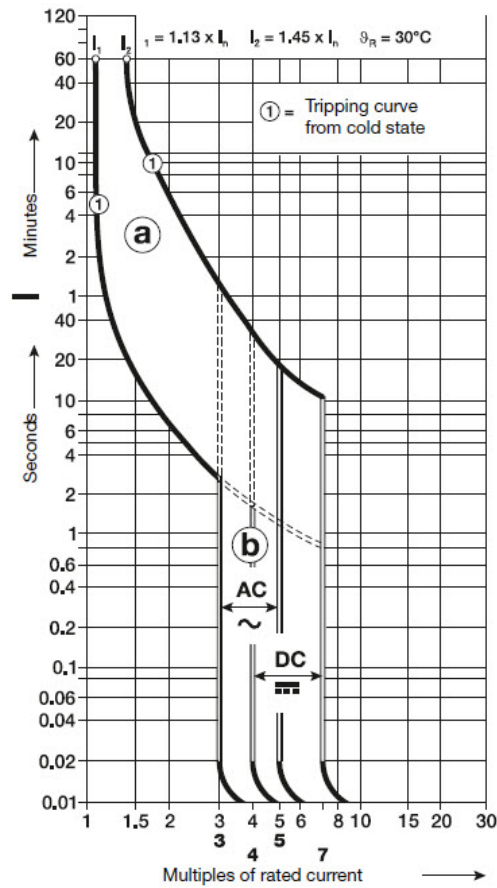

Standard	(A) Thermal release ⁽¹⁾		(B) Magnetic release ⁽²⁾	
	Value	Tripping time	Range of instantaneous trip	Tripping time
IEC 60898-1	Conventional non-tripping current I1	$1.13 \times I_n$	$> 1 \text{ hr}$	$3 \times I_n$
	Conventional tripping current I2	$1.45 \times I_n$	$< 1 \text{ hr}$	$5 \times I_n$

⁽¹⁾ The thermal releases are calibrated to a nominal reference ambient temperature of 30°C. In the case of higher ambient temperature, the current values fall by approx. 10% for each 10 K temperature rise.

⁽²⁾ The indicated tripping value of electromagnetic tripping devices apply to a frequency range from 16 2/3...60Hz. For different network frequencies or use in DC, the value changes according to the multiplier in the table below. The thermal tripping is independent from network frequency.

Network	Frequency	Trip range multiplier
AC	100 Hz	1.1
	200 Hz	1.2
	400 Hz	1.5
DC	-	1.5

Tripping curves details

C tripping curve

Description

Available for all series with rated currents up through 63 amperes. The "C" time-current curve is designed for medium magnetic start-up currents. Instantaneous tripping occurs between 5 and 10 times rated current in 50/60 Hz systems. The "C" characteristic is the most commonly used curved.

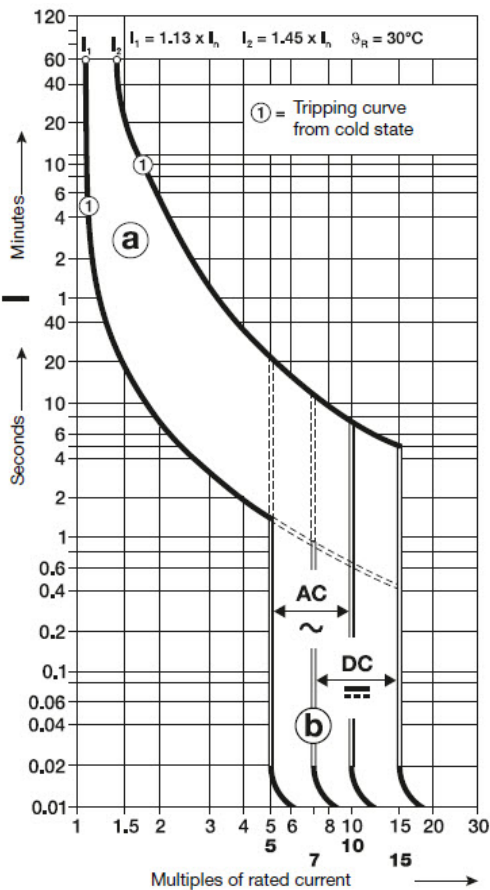

Standard	Value	(A) Thermal release ⁽¹⁾		(B) Magnetic release ⁽²⁾	
		Tripping time	Range of instantaneous trip	Tripping time	Tripping time
IEC 60898-1	Conventional non-tripping current I1	1.13 x In	> 1 hr	5 x In	> 0.1 s
	Conventional tripping current I2	1.45 x In	< 1 hr	10 x In	< 0.1 s

⁽¹⁾ The thermal releases are calibrated to a nominal reference ambient temperature of 30°C. In the case of higher ambient temperature, the current values fall by approx. 10% for each 10 K temperature rise.

⁽²⁾ The indicated tripping value of electromagnetic tripping devices apply to a frequency range from 16 2/3...60Hz. For different network frequencies or use in DC, the value changes according to the multiplier in the table below. The thermal tripping is independent from network frequency.

Network	Frequency	Trip range multiplier
AC	100 Hz	1.1
	200 Hz	1.2
	400 Hz	1.5
DC	-	1.5

Tripping curves details

D tripping curve

Description

Available with the ST200M series only. The "D" time-current curve has an instantaneous trip point between 10 to 20 times the breaker rating. Thus, the "D" characteristic can be a good protective solution for applications involving high in-rush transformers, motors and other high inductive systems. The "D" characteristic is also suitable for any application where a high instantaneous trip point is desired.

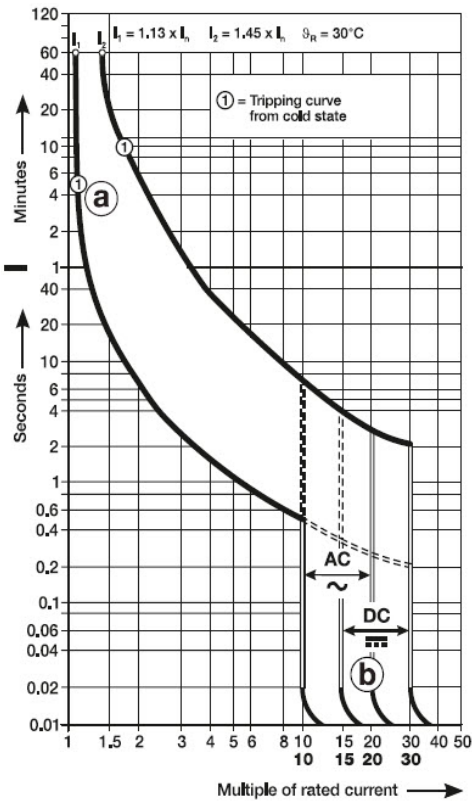

Standard	Value	(A) Thermal release ⁽¹⁾		(B) Magnetic release ⁽²⁾	
		Tripping time	Range of instantaneous trip	Tripping time	Tripping time
IEC 60898-1	Conventional non-tripping current I1	1.13 x In	> 1 hr	10 x In	> 0.1 s
	Conventional tripping current I2	1.45 x In	< 1 hr	20 x In	< 0.1 s

(1) The thermal releases are calibrated to a nominal reference ambient temperature of 30°C. In the case of higher ambient temperature, the current values fall by approx. 10% for each 10 K temperature rise.

(2) The indicated tripping value of electromagnetic tripping devices apply to a frequency range from 16 2/3...60Hz. For different network frequencies or use in DC, the value changes according to the multiplier in the table below. The thermal tripping is independent from network frequency.

Network	Frequency	Trip range multiplier
AC	100 Hz	1.1
	200 Hz	1.2
	400 Hz	1.5
DC	-	1.5

Tripping curves details

K tripping curve

Description

Available for all series with rated currents up through 63 amperes. The "K" time-current characteristic considers high magnetic start-up currents from motors, transformers and other equipment. Instantaneous tripping occurs between 10 to 14 times rated current in 50/60Hz systems. The "K" characteristic is available up through 63 amperes.

The "K" curve offers the best protection for the broadest range of electrical systems. The higher magnetic trip settings maximizes protection while allowing for higher in-rush currents during system start-up.

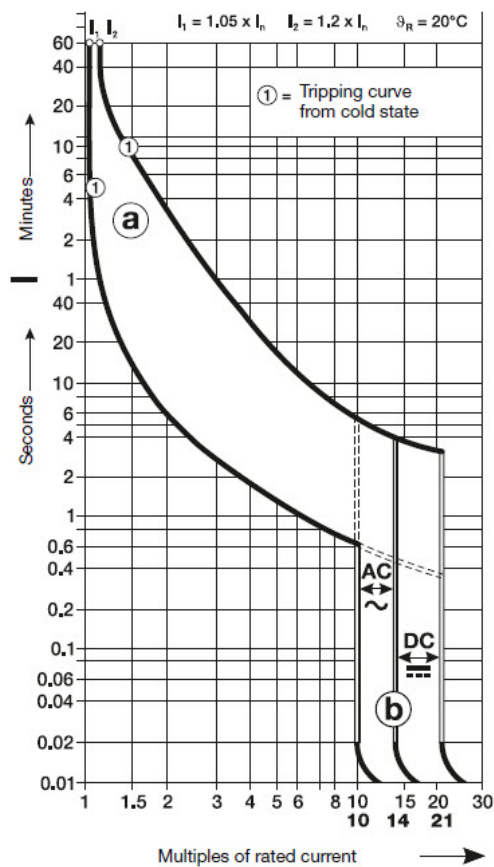

Standard	(A) Thermal release ⁽¹⁾		(B) Magnetic release ⁽²⁾		
	Value	Tripping time	Range of instantaneous trip	Tripping time	
IEC 60898-1	Conventional non-tripping current I1	$1.05 \times I_n$	$> 1 \text{ hr}$	$10 \times I_n$	$> 0.2 \text{ s}$
	Conventional tripping current I2	$1.20 \times I_n$	$< 1 \text{ hr}^{(3)}$	$14 \times I_n$	$< 0.2 \text{ s}$
		$1.50 \times I_n$	$< 2 \text{ min}^{(3)}$		
		$6.00 \times I_n$	$> 2 \text{ s (T1)}$		

⁽¹⁾ The thermal releases are calibrated to a nominal reference ambient temperature of 20°C. In the case of higher ambient temperature, the current values fall by approx. 10% for each 10 K temperature rise.

⁽²⁾ The indicated tripping value of electromagnetic tripping devices apply to a frequency range from 16 2/3...60Hz. For different network frequencies or use in DC, the value changes according to the multiplier in the table below. The thermal tripping is independent from network frequency.

⁽³⁾ As from operating temperature (after I1 > 1 hr or, as applicable, 2 h)

Network	Frequency	Trip range multiplier
AC	100 Hz	1.1
	200 Hz	1.2
	400 Hz	1.5
DC	-	1.5

Tripping curves details

Z tripping curve

Description

Available for ST200M and S200MUC series with rated currents up through 63 amperes. the "Z" characteristic offers instantaneous tripping between 2 and 3 times rated current in 50/60Hz systems.

Many applications require a very low short circuit trip settings in order to protect semiconductor or other sensitive devices and the "Z" trip characteristic may provide maximum protection and service in these applications.

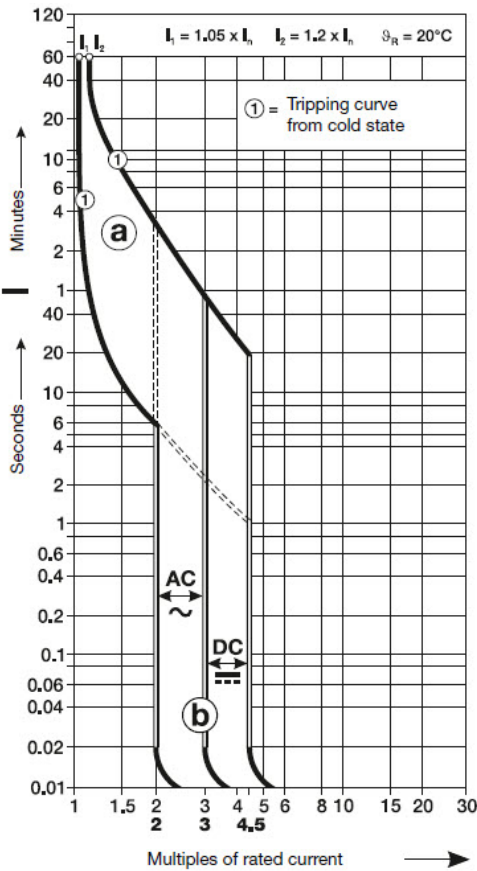

Standard	(A) Thermal release ⁽¹⁾		(B) Magnetic release ⁽²⁾		
	Value	Tripping time	Range of instantaneous trip	Tripping time	
IEC 60898-1	Conventional non-tripping current I1	1.05 x In	> 1 hr	2 x In	> 0.2 s
	Conventional tripping current I2	1.20 x In	< 1 hr ⁽³⁾	3 x In	< 0.2 s

⁽¹⁾ The thermal releases are calibrated to a nominal reference ambient temperature of 20°C. In the case of higher ambient temperature, the current values fall by approx. 10% for each 10 K temperature rise.

⁽²⁾ The indicated tripping value of electromagnetic tripping devices apply to a frequency range from 16 2/3...60Hz. For different network frequencies or use in DC, the value changes according to the multiplier in the table below. The thermal tripping is independent from network frequency.

⁽³⁾ As from operating temperature (after I1 > 1 hr or, as applicable, 2 h)

Network	Frequency	Trip range multiplier
AC	100 Hz	1.1
	200 Hz	1.2
	400 Hz	1.5
DC	-	1.5

Dimensions

S200, S200P and S200MUC series

ST200M, S200MUC approximate dimensions

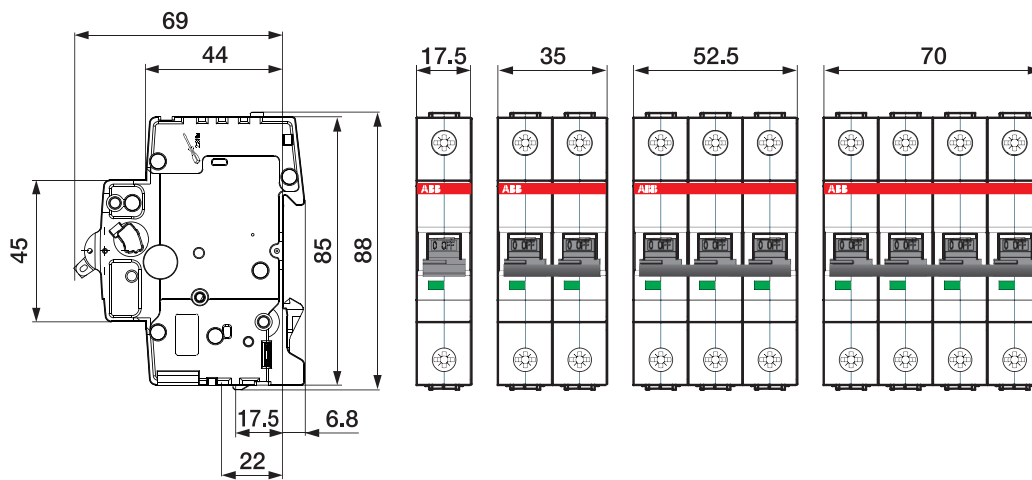

S200MR approximate dimensions

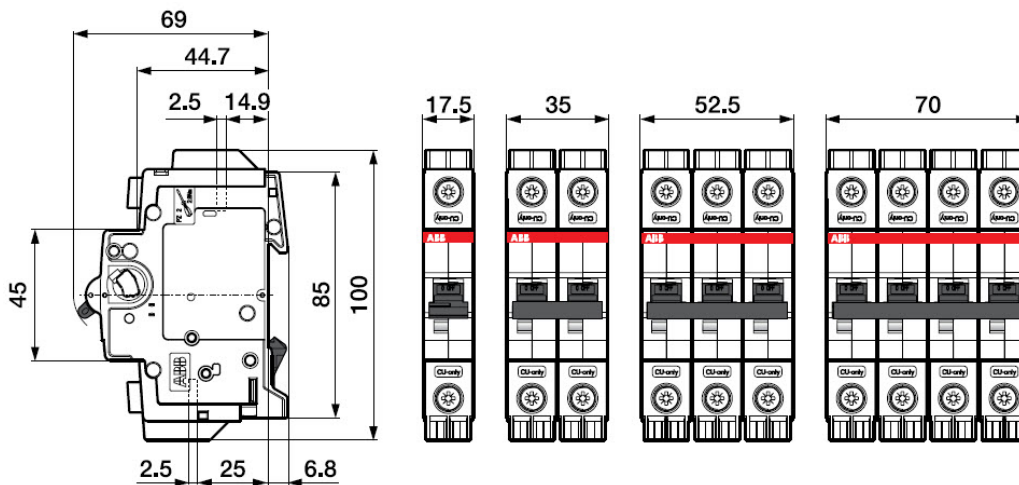

Dimensions

Accessories

S2C-H6...S2C-S/H6R approximate dimensions

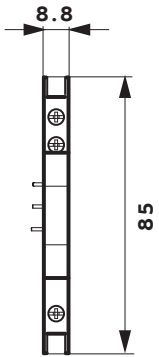

S2C-A1, S2C-A2 approximate dimensions

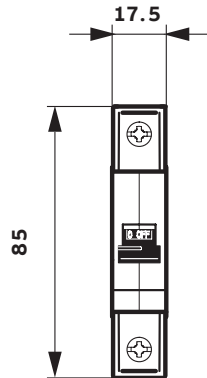

S2C-UA approximate dimensions

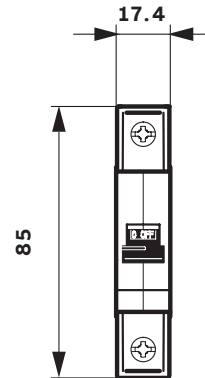

S2C-H10, H01 approximate dimensions

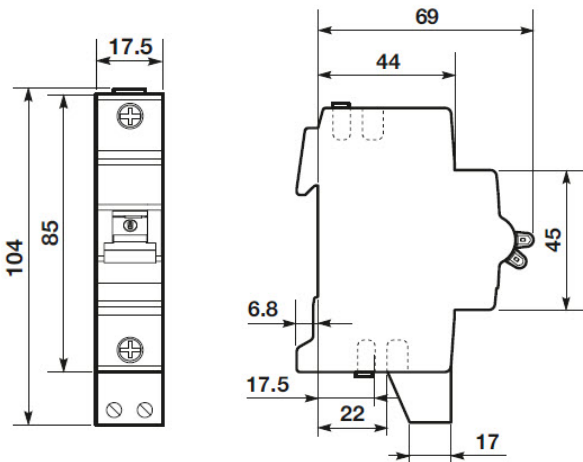

S800 series

UL 1077 Supplementary Protectors

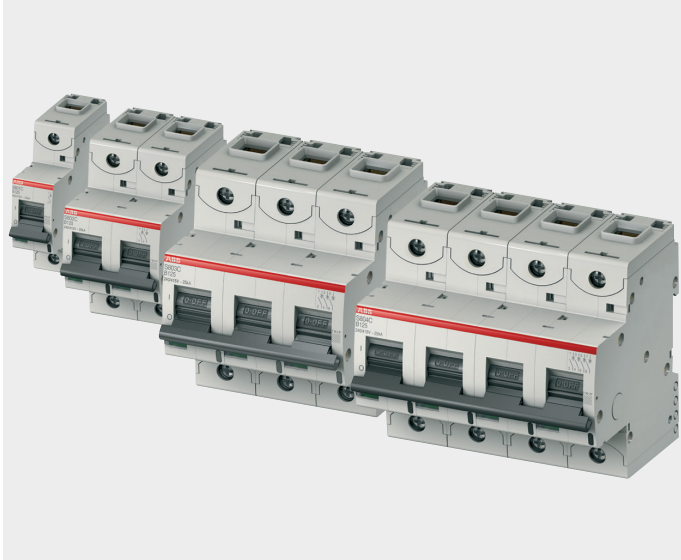

The S800 series are high performance circuit breakers.

The current range covers nominal rated currents from 10 A up to 100 A (S800C) and 6 A up to 63 A (S800S) with a maximum rated short-circuit interrupt rating of up to 20 kA (S800C) and 30 kA (S800S) in UL / CSA applications.

The S800HV is available for 600Y/347 VAC requirements up to 32A with 15kA IC

General Data	S800C	S800S	S800HV
Amperage	10...100 A	10...63 A	10...32 A
Voltage	480Y/277 Vac 125/500 Vdc	600Y/347 Vac	600Y/347 Vac
Poles	1, 2, 3, 4	1, 2, 3, 4	3
Trip curves	B, C, D, K	B, C, D, K	C, K
Short circuit interrupt rating	10 kA	6 kA	15 kA
Mechanical life	4,000 ops	4,000 ops	4,000 ops
Ambient temperature	-25 ... +60 °C	-25 ... +60 °C	-25 ... +60 °C
Auxiliary contacts	Yes	Yes	Yes
Bell alarm	Yes	Yes	Yes
Shunt trip	Yes	Yes	Yes
Undervoltage release	Yes	Yes	Yes
Busbar	No	No	No

Features

- Rated operational voltage up to 480Y/277 V AC – 500 V DC (S800C) and 600Y/347 V AC (S800S), respectively (UL)
- Compression terminals can be easily converted to ring tongue terminals
- Compact
- Space saving

S800C series

B tripping characteristic

1 pole	Box Qty	Weight each (kg)	Rated Current	Part number
	1	0.240	10.0 A	S801C-B10
			13.0A	S801C-B13
			16.0 A	S801C-B16
			20.0 A	S801C-B20
			25.0 A	S801C-B25
			32.0 A	S801C-B32
			40.0 A	S801C-B40
			50.0 A	S801C-B50
			63.0 A	S801C-B63
			80.0 A	S801C-B80
			100.0 A	S801C-B100

2 poles	Box Qty	Weight each (kg)	Rated Current	Part number
	1	0.490	10.0 A	S802C-B10
			13.0A	S802C-B13
			16.0 A	S802C-B16
			20.0 A	S802C-B20
			25.0 A	S802C-B25
			32.0 A	S802C-B32
			40.0 A	S802C-B40
			50.0 A	S802C-B50
			63.0 A	S802C-B63
			80.0 A	S802C-B80
			100.0 A	S802C-B100

3 poles	Box Qty	Weight each (kg)	Rated Current	Part number
	1	0.740	10.0 A	S803C-B10
			13.0A	S803C-B13
			16.0 A	S803C-B16
			20.0 A	S803C-B20
			25.0 A	S803C-B25
			32.0 A	S803C-B32
			40.0 A	S803C-B40
			50.0 A	S803C-B50
			63.0 A	S803C-B63
			80.0 A	S803C-B80
			100.0 A	S803C-B100

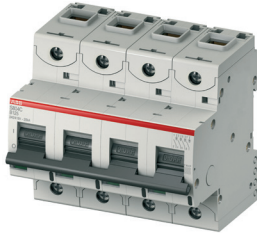
4 poles	Box Qty	Weight each (kg)	Rated Current	Part number
	1	0.980	10.0 A	S804C-B10
			13.0A	S804C-B13
			16.0 A	S804C-B16
			20.0 A	S804C-B20
			25.0 A	S804C-B25
			32.0 A	S804C-B32
			40.0 A	S804C-B40
			50.0 A	S804C-B50
			63.0 A	S804C-B63
			80.0 A	S804C-B80
			100.0 A	S804C-B100

S800C series

C tripping characteristic

1 pole	Box Qty	Weight each (kg)	Rated Current	Part number
	1	0.240	10.0 A	S801C-C10
			13.0A	S801C-C13
			16.0 A	S801C-C16
			20.0 A	S801C-C20
			25.0 A	S801C-C25
			32.0 A	S801C-C32
			40.0 A	S801C-C40
			50.0 A	S801C-C50
			63.0 A	S801C-C63
			80.0 A	S801C-C80
			100.0 A	S801C-C100

2 poles	Box Qty	Weight each (kg)	Rated Current	Part number
	1	0.490	10.0 A	S802C-C10
			13.0A	S802C-C13
			16.0 A	S802C-C16
			20.0 A	S802C-C20
			25.0 A	S802C-C25
			32.0 A	S802C-C32
			40.0 A	S802C-C40
			50.0 A	S802C-C50
			63.0 A	S802C-C63
			80.0 A	S802C-C80
			100.0 A	S802C-C100

3 poles	Box Qty	Weight each (kg)	Rated Current	Part number
	1	0.740	10.0 A	S803C-C10
			13.0A	S803C-C13
			16.0 A	S803C-C16
			20.0 A	S803C-C20
			25.0 A	S803C-C25
			32.0 A	S803C-C32
			40.0 A	S803C-C40
			50.0 A	S803C-C50
			63.0 A	S803C-C63
			80.0 A	S803C-C80
			100.0 A	S803C-C100

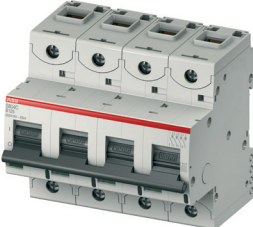
4 poles	Box Qty	Weight each (kg)	Rated Current	Part number
	1	0.980	10.0 A	S804C-C10
			13.0A	S804C-C13
			16.0 A	S804C-C16
			20.0 A	S804C-C20
			25.0 A	S804C-C25
			32.0 A	S804C-C32
			40.0 A	S804C-C40
			50.0 A	S804C-C50
			63.0 A	S804C-C63
			80.0 A	S804C-C80
			100.0 A	S804C-C100

S800C series

D tripping characteristic

1 pole	Box Qty	Weight each (kg)	Rated Current	Part number
	1	0.240	10.0 A	S801C-D10
			13.0A	S801C-D13
			16.0 A	S801C-D16
			20.0 A	S801C-D20
			25.0 A	S801C-D25
			32.0 A	S801C-D32
			40.0 A	S801C-D40
			50.0 A	S801C-D50
			63.0 A	S801C-D63
			80.0 A	S801C-D80
			100.0 A	S801C-D100

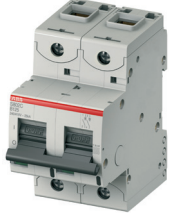
2 poles	Box Qty	Weight each (kg)	Rated Current	Part number
	1	0.490	10.0 A	S802C-D10
			13.0A	S802C-D13
			16.0 A	S802C-D16
			20.0 A	S802C-D20
			25.0 A	S802C-D25
			32.0 A	S802C-D32
			40.0 A	S802C-D40
			50.0 A	S802C-D50
			63.0 A	S802C-D63
			80.0 A	S802C-D80
			100.0 A	S802C-D100

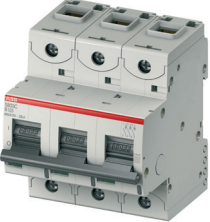
3 poles	Box Qty	Weight each (kg)	Rated Current	Part number
	1	0.740	10.0 A	S803C-D10
			13.0A	S803C-D13
			16.0 A	S803C-D16
			20.0 A	S803C-D20
			25.0 A	S803C-D25
			32.0 A	S803C-D32
			40.0 A	S803C-D40
			50.0 A	S803C-D50
			63.0 A	S803C-D63
			80.0 A	S803C-D80
			100.0 A	S803C-D100

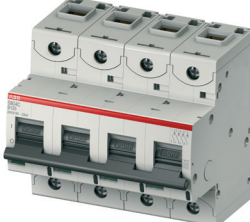
4 poles	Box Qty	Weight each (kg)	Rated Current	Part number
	1	0.980	10.0 A	S804C-D10
			13.0A	S804C-D13
			16.0 A	S804C-D16
			20.0 A	S804C-D20
			25.0 A	S804C-D25
			32.0 A	S804C-D32
			40.0 A	S804C-D40
			50.0 A	S804C-D50
			63.0 A	S804C-D63
			80.0 A	S804C-D80
			100.0 A	S804C-D100

S800C series

K tripping characteristic

1 pole	Box Qty	Weight each (kg)	Rated Current	Part number
	1	0.240	10.0 A	S801C-K10
			13.0A	S801C-K13
			16.0 A	S801C-K16
			20.0 A	S801C-K20
			25.0 A	S801C-K25
			32.0 A	S801C-K32
			40.0 A	S801C-K40
			50.0 A	S801C-K50
			63.0 A	S801C-K63
			80.0 A	S801C-K80
			100.0 A	S801C-K100

2 poles	Box Qty	Weight each (kg)	Rated Current	Part number
	1	0.490	10.0 A	S802C-K10
			13.0A	S802C-K13
			16.0 A	S802C-K16
			20.0 A	S802C-K20
			25.0 A	S802C-K25
			32.0 A	S802C-K32
			40.0 A	S802C-K40
			50.0 A	S802C-K50
			63.0 A	S802C-K63
			80.0 A	S802C-K80
			100.0 A	S802C-K100

3 poles	Box Qty	Weight each (kg)	Rated Current	Part number
	1	0.740	10.0 A	S803C-K10
			13.0A	S803C-K13
			16.0 A	S803C-K16
			20.0 A	S803C-K20
			25.0 A	S803C-K25
			32.0 A	S803C-K32
			40.0 A	S803C-K40
			50.0 A	S803C-K50
			63.0 A	S803C-K63
			80.0 A	S803C-K80
			100.0 A	S803C-K100

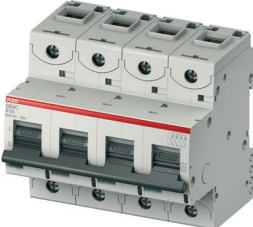
4 poles	Box Qty	Weight each (kg)	Rated Current	Part number
	1	0.980	10.0 A	S804C-K10
			13.0A	S804C-K13
			16.0 A	S804C-K16
			20.0 A	S804C-K20
			25.0 A	S804C-K25
			32.0 A	S804C-K32
			40.0 A	S804C-K40
			50.0 A	S804C-K50
			63.0 A	S804C-K63
			80.0 A	S804C-K80
			100.0 A	S804C-K100

S800S series

B tripping characteristic

1 pole	Box Qty	Weight each (kg)	Rated Current	Part number
	1	0.240	0.5 A	S801S-B0.5
			1.0 A	S801S-B1
			1.6 A	S801S-B1.6
			2.0 A	S801S-B2
			2.5 A	S801S-B2.5
			3.0 A	S801S-B3
			4.0 A	S801S-B4
			5.0 A	S801S-B5
			6.0 A	S801S-B6
			8.0 A	S801S-B8
			10.0 A	S801S-B10
			13.0A	S801S-B13
			16.0 A	S801S-B16
			20.0 A	S801S-B20
			25.0 A	S801S-B25
			32.0 A	S801S-B32
			40.0 A	S801S-B40
		50.0 A	S801S-B50	
		63.0 A	S801S-B63	

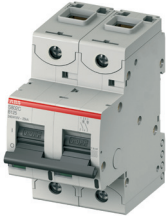
2 poles	Box Qty	Weight each (kg)	Rated Current	Part number
	1	0.490	0.5 A	S802S-B0.5
			1.0 A	S802S-B1
			1.6 A	S802S-B1.6
			2.0 A	S802S-B2
			2.5 A	S802S-B2.5
			3.0 A	S802S-B3
			4.0 A	S802S-B4
			5.0 A	S802S-B5
			6.0 A	S802S-B6
			8.0 A	S802S-B8
			10.0 A	S802S-B10
			13.0A	S802S-B13
			16.0 A	S802S-B16
			20.0 A	S802S-B20
			25.0 A	S802S-B25
			32.0 A	S802S-B32
			40.0 A	S802S-B40
		50.0 A	S802S-B50	
		63.0 A	S802S-B63	

3 poles	Box Qty	Weight each (kg)	Rated Current	Part number
	1	0.740	0.5 A	S803S-B0.5
			1.0 A	S803S-B1
			1.6 A	S803S-B1.6
			2.0 A	S803S-B2
			2.5 A	S803S-B2.5
			3.0 A	S803S-B3
			4.0 A	S803S-B4
			5.0 A	S803S-B5
			6.0 A	S803S-B6
			8.0 A	S803S-B8
			10.0 A	S803S-B10
			13.0A	S803S-B13
			16.0 A	S803S-B16
			20.0 A	S803S-B20
			25.0 A	S803S-B25
			32.0 A	S803S-B32
			40.0 A	S803S-B40
		50.0 A	S803S-B50	
		63.0 A	S803S-B63	

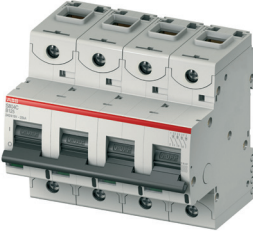
4 poles	Box Qty	Weight each (kg)	Rated Current	Part number
	1	0.980	0.5 A	S804S-B0.5
			1.0 A	S804S-B1
			1.6 A	S804S-B1.6
			2.0 A	S804S-B2
			2.5 A	S804S-B2.5
			3.0 A	S804S-B3
			4.0 A	S804S-B4
			5.0 A	S804S-B5
			6.0 A	S804S-B6
			8.0 A	S804S-B8
			10.0 A	S804S-B10
			13.0A	S804S-B13
			16.0 A	S804S-B16
			20.0 A	S804S-B20
			25.0 A	S804S-B25
			32.0 A	S804S-B32
			40.0 A	S804S-B40
		50.0 A	S804S-B50	
		63.0 A	S804S-B63	

S800S series

C tripping characteristic

1 pole	Box Qty	Weight each (kg)	Rated Current	Part number
	1	0.240	0.5 A	S801S-C0.5
			1.0 A	S801S-C1
			1.6 A	S801S-C1.6
			2.0 A	S801S-C2
			2.5 A	S801S-C2.5
			3.0 A	S801S-C3
			4.0 A	S801S-C4
			5.0 A	S801S-C5
			6.0 A	S801S-C6
			8.0 A	S801S-C8
			10.0 A	S801S-C10
			13.0A	S801S-C13
			16.0 A	S801S-C16
			20.0 A	S801S-C20
			25.0 A	S801S-C25
			32.0 A	S801S-C32
			40.0 A	S801S-C40
			50.0 A	S801S-C50
			63.0 A	S801S-C63



2 poles	Box Qty	Weight each (kg)	Rated Current	Part number
	1	0.490	0.5 A	S802S-C0.5
			1.0 A	S802S-C1
			1.6 A	S802S-C1.6
			2.0 A	S802S-C2
			2.5 A	S802S-C2.5
			3.0 A	S802S-C3
			4.0 A	S802S-C4
			5.0 A	S802S-C5
			6.0 A	S802S-C6
			8.0 A	S802S-C8
			10.0 A	S802S-C10
			13.0A	S802S-C13
			16.0 A	S802S-C16
			20.0 A	S802S-C20
			25.0 A	S802S-C25
			32.0 A	S802S-C32
			40.0 A	S802S-C40
			50.0 A	S802S-C50
			63.0 A	S802S-C63



3 poles	Box Qty	Weight each (kg)	Rated Current	Part number
	1	0.740	0.5 A	S803S-C0.5
			1.0 A	S803S-C1
			1.6 A	S803S-C1.6
			2.0 A	S803S-C2
			2.5 A	S803S-C2.5
			3.0 A	S803S-C3
			4.0 A	S803S-C4
			5.0 A	S803S-C5
			6.0 A	S803S-C6
			8.0 A	S803S-C8
			10.0 A	S803S-C10
			13.0A	S803S-C13
			16.0 A	S803S-C16
			20.0 A	S803S-C20
			25.0 A	S803S-C25
			32.0 A	S803S-C32
			40.0 A	S803S-C40
			50.0 A	S803S-C50
			63.0 A	S803S-C63



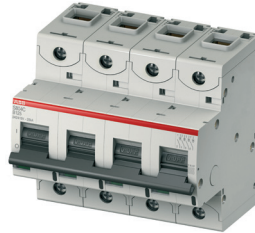

4 poles	Box Qty	Weight each (kg)	Rated Current	Part number
	1	0.980	0.5 A	S804S-C0.5
			1.0 A	S804S-C1
			1.6 A	S804S-C1.6
			2.0 A	S804S-C2
			2.5 A	S804S-C2.5
			3.0 A	S804S-C3
			4.0 A	S804S-C4
			5.0 A	S804S-C5
			6.0 A	S804S-C6
			8.0 A	S804S-C8
			10.0 A	S804S-C10
			13.0A	S804S-C13
			16.0 A	S804S-C16
			20.0 A	S804S-C20
			25.0 A	S804S-C25
			32.0 A	S804S-C32
			40.0 A	S804S-C40
			50.0 A	S804S-C50
			63.0 A	S804S-C63



S800S series

D tripping characteristic

1 pole	Box Qty	Weight each (kg)	Rated Current	Part number
	1	0.240	0.5 A	S801S-D0.5
			1.0 A	S801S-D1
			1.6 A	S801S-D1.6
			2.0 A	S801S-D2
			2.5 A	S801S-D2.5
			3.0 A	S801S-D3
			4.0 A	S801S-D4
			5.0 A	S801S-D5
			6.0 A	S801S-D6
			8.0 A	S801S-D8
			10.0 A	S801S-D10
			13.0A	S801S-D13
			16.0 A	S801S-D16
			20.0 A	S801S-D20
			25.0 A	S801S-D25
			32.0 A	S801S-D32
40.0 A	S801S-D40			
50.0 A	S801S-D50			
63.0 A	S801S-D63			

2 poles	Box Qty	Weight each (kg)	Rated Current	Part number
	1	0.490	0.5 A	S802S-D0.5
			1.0 A	S802S-D1
			1.6 A	S802S-D1.6
			2.0 A	S802S-D2
			2.5 A	S802S-D2.5
			3.0 A	S802S-D3
			4.0 A	S802S-D4
			5.0 A	S802S-D5
			6.0 A	S802S-D6
			8.0 A	S802S-D8
			10.0 A	S802S-D10
			13.0A	S802S-D13
			16.0 A	S802S-D16
			20.0 A	S802S-D20
			25.0 A	S802S-D25
			32.0 A	S802S-D32
40.0 A	S802S-D40			
50.0 A	S802S-D50			
63.0 A	S802S-D63			

3 poles	Box Qty	Weight each (kg)	Rated Current	Part number
	1	0.740	0.5 A	S803S-D0.5
			1.0 A	S803S-D1
			1.6 A	S803S-D1.6
			2.0 A	S803S-D2
			2.5 A	S803S-D2.5
			3.0 A	S803S-D3
			4.0 A	S803S-D4
			5.0 A	S803S-D5
			6.0 A	S803S-D6
			8.0 A	S803S-D8
			10.0 A	S803S-D10
			13.0A	S803S-D13
			16.0 A	S803S-D16
			20.0 A	S803S-D20
			25.0 A	S803S-D25
			32.0 A	S803S-D32
40.0 A	S803S-D40			
50.0 A	S803S-D50			
63.0 A	S803S-D63			

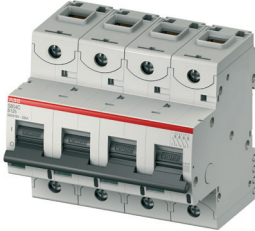
4 poles	Box Qty	Weight each (kg)	Rated Current	Part number
	1	0.980	0.5 A	S804S-D0.5
			1.0 A	S804S-D1
			1.6 A	S804S-D1.6
			2.0 A	S804S-D2
			2.5 A	S804S-D2.5
			3.0 A	S804S-D3
			4.0 A	S804S-D4
			5.0 A	S804S-D5
			6.0 A	S804S-D6
			8.0 A	S804S-D8
			10.0 A	S804S-D10
			13.0A	S804S-D13
			16.0 A	S804S-D16
			20.0 A	S804S-D20
			25.0 A	S804S-D25
			32.0 A	S804S-D32
40.0 A	S804S-D40			
50.0 A	S804S-D50			
63.0 A	S804S-D63			

S800S series

K tripping characteristic

1 pole	Box Qty	Weight each (kg)	Rated Current	Part number
	1	0.240	0.5 A	S801S-K0.5
			1.0 A	S801S-K1
			1.6 A	S801S-K1.6
			2.0 A	S801S-K2
			2.5 A	S801S-K2.5
			3.0 A	S801S-K3
			4.0 A	S801S-K4
			5.0 A	S801S-K5
			6.0 A	S801S-K6
			8.0 A	S801S-K8
			10.0 A	S801S-K10
			13.0A	S801S-K13
			16.0 A	S801S-K16
			20.0 A	S801S-K20
			25.0 A	S801S-K25
			32.0 A	S801S-K32
			40.0 A	S801S-K40
			50.0 A	S801S-K50
			63.0 A	S801S-K63



2 poles	Box Qty	Weight each (kg)	Rated Current	Part number
	1	0.490	0.5 A	S802S-K0.5
			1.0 A	S802S-K1
			1.6 A	S802S-K1.6
			2.0 A	S802S-K2
			2.5 A	S802S-K2.5
			3.0 A	S802S-K3
			4.0 A	S802S-K4
			5.0 A	S802S-K5
			6.0 A	S802S-K6
			8.0 A	S802S-K8
			10.0 A	S802S-K10
			13.0A	S802S-K13
			16.0 A	S802S-K16
			20.0 A	S802S-K20
			25.0 A	S802S-K25
			32.0 A	S802S-K32
			40.0 A	S802S-K40
			50.0 A	S802S-K50
			63.0 A	S802S-K63



3 poles	Box Qty	Weight each (kg)	Rated Current	Part number
	1	0.740	0.5 A	S803S-K0.5
			1.0 A	S803S-K1
			1.6 A	S803S-K1.6
			2.0 A	S803S-K2
			2.5 A	S803S-K2.5
			3.0 A	S803S-K3
			4.0 A	S803S-K4
			5.0 A	S803S-K5
			6.0 A	S803S-K6
			8.0 A	S803S-K8
			10.0 A	S803S-K10
			13.0A	S803S-K13
			16.0 A	S803S-K16
			20.0 A	S803S-K20
			25.0 A	S803S-K25
			32.0 A	S803S-K32
			40.0 A	S803S-K40
			50.0 A	S803S-K50
			63.0 A	S803S-K63



4 poles	Box Qty	Weight each (kg)	Rated Current	Part number
	1	0.980	0.5 A	S804S-K0.5
			1.0 A	S804S-K1
			1.6 A	S804S-K1.6
			2.0 A	S804S-K2
			2.5 A	S804S-K2.5
			3.0 A	S804S-K3
			4.0 A	S804S-K4
			5.0 A	S804S-K5
			6.0 A	S804S-K6
			8.0 A	S804S-K8
			10.0 A	S804S-K10
			13.0A	S804S-K13
			16.0 A	S804S-K16
			20.0 A	S804S-K20
			25.0 A	S804S-K25
			32.0 A	S804S-K32
			40.0 A	S804S-K40
			50.0 A	S804S-K50
			63.0 A	S804S-K63

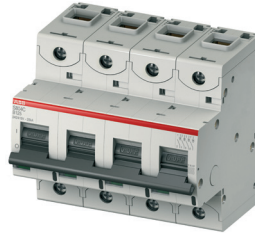

S800HV series

C tripping characteristic

3 poles



Box Qty	Weight each (kg)	Rated Current	Part number
1	0.740	10.0 A	S803HV-C10
		13.0A	S803HV-C13
		16.0 A	S803HV-C16
		20.0 A	S803HV-C20
		25.0 A	S803HV-C25
		32.0 A	S803HV-C32

S800HV series

K tripping characteristic

3 poles





Box Qty	Weight each (kg)	Rated Current	Part number
1	0.740	10.0 A	S803HV-K10
		13.0A	S803HV-K13
		16.0 A	S803HV-K16
		20.0 A	S803HV-K20
		25.0 A	S803HV-K25
		32.0 A	S803HV-K32

Accessories

Electrical accessories

Auxiliary contacts and bell alarms

	Description	Part number
	<p>Auxiliary contact (2 form C)</p> <p>The auxiliary contacts will signal whether the breaker is in the ON or OFF position. Mounts on the left side of the breaker up to maximum of 2 sets</p>	S800-AUX
	<p>Combined auxiliary contact + bell alarm (2 form C)</p> <p>The S800-AUX/ALT combined auxiliary and signal contact is used for electrical signaling of the operating state of the high performance MCB. One signal for the on/off/ state, one signal for tripped state only. Mounts on the left side of the breaker up to maximum of 2 sets.</p>	S800-AUX/ALT

Shunt trip

	Description	Part number
	<p>24 Vac/dc Shunt trip</p> <p>For remote tripping of the breaker, a shunt trip device can be added onto the MCB. The solenoid device opens the breaker after a control voltage is applied. Mounts on the left side of the MCB and can be mixed with auxiliary contacts</p>	S800-SOR24
	<p>48...130 Vac/dc Shunt trip</p> <p>For remote tripping of the breaker, a shunt trip device can be added onto the MCB. The solenoid device opens the breaker after a control voltage is applied. Mounts on the left side of the MCB and can be mixed with auxiliary contacts</p>	S800-SOR130
	<p>110...250 Vdc Shunt trip</p> <p>For remote tripping of the breaker, a shunt trip device can be added onto the MCB. The solenoid device opens the breaker after a control voltage is applied. Mounts on the left side of the MCB and can be mixed with auxiliary contacts</p>	S800-SOR250

Accessories

Electrical accessories

Undervoltage release



Description

24...36 Vac/dc undervoltage release

For remote tripping of the breaker, when the voltage drops below approximately 50% of rated voltage. The breaker can't be operated unless proper voltage is first applied. Mounts on the left side of the MCB and can be mixed with auxiliary contacts

S800-UVR36

48...60 Vac/dc undervoltage release

For remote tripping of the breaker, when the voltage drops below approximately 50% of rated voltage. The breaker can't be operated unless proper voltage is first applied. Mounts on the left side of the MCB and can be mixed with auxiliary contacts

S800-UVR60

110...130 Vac/dc undervoltage release

For remote tripping of the breaker, when the voltage drops below approximately 50% of rated voltage. The breaker can't be operated unless proper voltage is first applied. Mounts on the left side of the MCB and can be mixed with auxiliary contacts

S800-UVR130

220...250 Vdc undervoltage release

For remote tripping of the breaker, when the voltage drops below approximately 50% of rated voltage. The breaker can't be operated unless proper voltage is first applied. Mounts on the left side of the MCB and can be mixed with auxiliary contacts

S800-UVR250

Remote switching unit and cable

Description



Remote switching unit (breaker not included)

The RSU will allow a remote operation of the circuit breaker when 24Vdc is applied

S800W-RSU



Connecting cable and plug (mandatory with RSU)

Used with the RSU to provide power and controle. 3 meter cable 0.5 mm² (#20 AWG) including 10-pole Micro-Fit 3.0™ plug.

S800-RSU-CP

Accessories

Electrical accessories

S803W-SCL-SR Short circuit current limiter, self-resetting UL



Description

Part number

32 A Self-resetting current limiter

For increased short circuit breaking capacity of downstream manual motor starters and high performance MCBs (S800 series)- up to 65kA on approved combination.

S803W-SCL32-SR

63 A Self-resetting current limiter

For increased short circuit breaking capacity of downstream manual motor starters and high performance MCBs (S800 series)- up to 65kA on approved combination.

S803W-SCL63-SR

100 A Self-resetting current limiter

For increased short circuit breaking capacity of downstream manual motor starters and high performance MCBs (S800 series)- up to 65kA on approved combination.

S803W-SCL100-SR

See technical detail section for approved combination and technical data.

Accessories

Mechanical accessories

Ring tongue adaptor

Description	Part number
 <p>Ring terminal cable connection 40...125 A (kit of 2 nuts, insulation nuts, cable lugs, allen screws and 25mm insulation walls)</p>	S800-RT2125

Handle operating mechanism

Description	Part number
 <p>Mounts on the circuit breaker and allows "through the door" operation</p>	S800-RD

Rotary handle

Description	Part number
 <p>Grey rotary handle</p>	S800-RHE-H
<p>Red emergency rotary handle</p>	S800-RHE-EM

Shaft extension

Description	Part number
 <p>To connect rotary drive and door handle</p>	S800-RHE-S

Accessories

Mechanical accessories (S800 series)

UL locking device

Description	Part number
 <p>Lock out / tag out device for S800 series (padlock not included)</p>	S800U-PLL

Technical details

S800 series

Technical specifications MCBs

	S800C	S800S	S800HV
Specifications	CSA C22.2 No.235 UL1077 IEC 60947-2	CSA C22.2 No.235 UL1077 IEC 60947-2	CSA C22.2 No.235 UL1077 IEC 60947-2
Nbr of poles	1, 2, 3, 4	1, 2, 3, 4	3
Trip curves	B, C, D, K	B, C, D, K	C, K
Amperage	10...100 A	10...63 A	10...32 A
Voltage AC	480Y/277 Vac	600Y/347 Vac	600Y/347 Vac
Voltage DC	125 per pole	-	-
Interrupt rating	10 kA	6 kA	15 kA
Calibration temp	30...40 °C	30...40 °C	40 °C
Mounting position	Any	Any	Any
Protection degree	IP20	IP20	IP20
Mounting	35 mm DIN rail	35 mm DIN rail	35 mm DIN rail
Tightening torque	31 in-lbs 3.5 Nm	31 in-lbs 3.5 Nm	31 in-lbs 3.5 Nm
Terminal wire size	14...2 AWG (10...30 A) 8...1 AWG (40...100A)	14...2 AWG (10...30 A) 8...1 AWG (40...100A)	14...2 AWG
Ambien temperature	-25°C...+60°C -13°F...+140°F	-25°C...+60°C -13°F...+140°F	-25°C...+60°C -13°F...+140°F
Mechanical life	10,000 ops	10,000 ops	10,000 ops

Technical details

S800 series

Internal resistance and power loss per pole (S800C and S800S)

B, C, D, K tripping characteristics		
Rated current (A)	Internal resistance (mΩ)	Power loss (W)
10	15.2	1.5
13	12.1	2.0
16	12.1	3.1
20	8.7	3.5
25	6.8	4.3
32	3.1	3.2
40	2.3	3.7
50	1.7	4.3
63	1.6	6.4
80 ⁽¹⁾	1.0	6.4
100 ⁽¹⁾	0.8	8.0

⁽¹⁾ Only for S800C series

Internal resistance and power loss per pole (S800HV)

B, C, D, K tripping characteristics		
Rated current (A)	Internal resistance (mΩ)	Power loss (W)
10	15.2	1.5
13	12.1	2.0
16	12.1	3.1
20	8.7	3.5
25	6.8	4.3
32	3.1	3.2

Technical details

S800 series

Temperature derating (B, C, D tripping characteristics)

		Maximum operating current (A) at ambient temperature T											
Standard	Rated current (A)	- 25 °C	- 15 °C	- 10 °C	- 5 °C	0 °C	10 °C	20 °C	30 °C	40 °C	50 °C	60 °C	70 °C
Standard	10	12.0	11.7	11.5	11.3	11.1	10.7	10.4	10.0	9.6	9.3	8.9	8.5
	13	15.6	15.1	14.9	14.7	14.4	14.0	13.5	13.0	12.5	12.0	11.6	11.1
	16	19.2	18.6	18.3	18.1	17.8	17.2	16.6	16.0	15.4	14.8	14.2	13.7
	20	24.0	23.3	22.9	22.6	22.2	21.5	20.7	20.0	19.3	18.5	17.8	17.1
	25	30.0	29.1	28.7	28.2	27.8	26.8	25.9	25.0	24.1	23.2	22.2	21.3
IEC	32	38.5	37.3	36.7	36.1	35.5	34.3	33.2	32.0	30.8	29.7	28.5	27.3
	40	48.1	46.6	45.9	45.1	44.4	42.9	41.5	40.0	38.5	37.1	35.6	34.1
	50	60.1	58.3	57.3	56.4	55.5	53.7	51.8	50.0	48.2	46.3	44.5	42.7
	63	75.7	73.4	72.2	71.1	69.9	67.6	65.3	63.0	60.7	58.4	56.1	53.8
	80	96.1	93.2	91.7	90.3	88.8	85.9	82.9	80.0	77.1	74.1	71.2	68.3
	100	120.2	116.5	114.7	112.8	111.0	107.3	129.6	100.0	96.3	92.7	89.0	85.3

Temperature derating (K tripping characteristics)

		Maximum operating current (A) at ambient temperature T											
Standard	Rated current (A)	- 25 °C	- 15 °C	- 10 °C	- 5 °C	0 °C	10 °C	20 °C	30 °C	40 °C	50 °C	60 °C	70 °C
Standard	10	12.4	12.0	11.8	11.7	11.5	11.1	10.7	10.4	10.0	9.6	9.3	8.9
	13	16.1	15.6	15.4	15.1	14.9	14.4	14.0	13.5	13.0	12.5	12.0	11.6
	16	19.8	19.2	18.9	18.6	18.3	17.8	17.2	16.6	16.0	15.4	14.8	14.2
	20	24.8	24.0	23.7	23.3	22.3	22.2	21.5	20.7	20.0	19.3	18.5	17.8
	25	31.0	30.0	29.6	29.1	28.7	27.8	26.8	25.9	25.0	24.1	23.2	22.2
IEC	32	39.6	38.5	37.9	3.3	36.7	35.5	34.3	33.2	32.0	30.8	29.7	28.5
	40	49.5	48.1	47.3	46.6	45.9	44.4	42.9	41.5	40.0	38.5	37.1	35.6
	50	61.9	60.1	59.2	58.3	57.3	55.5	53.7	51.8	50.0	48.2	46.3	44.5
	63	78.0	75.7	74.6	73.4	72.2	69.9	67.6	65.3	63.0	60.7	58.4	56.1

Technical details

Electrical accessories (S800)

Technical specifications auxiliary contacts S800AUX, S800AUX/ALT

	S800-AUX	S800-AUX/ALT
	AC15 400/2 A-UL AC15 240/6 A-UL DC13 250/0.55 A DC13 125 V/1.1A DC13/60 V/2A DC13 24 V/4A	AC15 400/2 A-UL AC15 240/6 A-UL DC13 250/0.55 A DC13 125 V/1.1A DC13/60 V/2A DC13 24 V/4A
Usage category		
Continuous thermal current	6 A	6 A
Ratd insulation voltage	690 V	690 V
Number of contacts	2	2 (1 AUX + 1 ALT)
Rated impulse withstand voltage	6 kV	6 kV
Protection degree	3	3
Function of contact	Change over (dry SPDT)	Change over (dry SPDT)
Connection (CU)	1x 2.5mm ² or 2x 1.5 mm ²	1x 2.5mm ² or 2x 1.5 mm ²
Tightening torque	1 Nm	1 Nm
Ensured contacts during shake test according to IEC 68-2-6	5g, 20 frequency cycle at 24 Vac/dc 5 mA brief interrupt < 10 ms	5g, 20 frequency cycle at 24 Vac/dc 5 mA brief interrupt < 10 ms
Supply	Any	Any
Mounting	On MCB, DIN rail	On MCB, DIN rail
Type of protection	IP20	IP20
Permissible ambient temperature	-25°C...+60°C -13°F...+140°F	-25°C...+60°C -13°F...+140°F
Storage temperature	-40°C...+70°C -40°F...+158°F	-40°C...+70°C -40°F...+158°F
Mechanical life	6,000 ops	6,000 ops
Resistance to vibration	IEC 60068-2-27, 60068-2, 61373 Cat. 1/ class B	IEC 60068-2-27, 60068-2, 61373 Cat. 1/ class B

Connection drawings (normal state - OFF position below)

Auxiliary contact S800-AUX

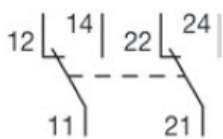

Auxiliary contact S800-AUX/ALT

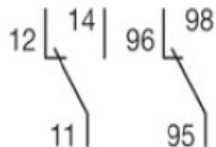

Technical details

Electrical accessories (S800)

Technical specifications shunt trip S800-SOR

	S800-SOR24	S800-SOR130	S800-SOR250
Rated voltage	24 Vac/dc	48...130 Vac/dc	110...250 Vac/dc
Operating range	70...110%	70...110%	70...110%
Insulation voltage	690 V	690 V	690 V
Coil pull in consumption	16.6 W (17 VA)	On request	On request
Rated frequency	DC 50/60 Hz	DC 50/60 Hz	DC 50/60 Hz
Protection degree	3	3	3
Connectio Cu	1...35 mm ²	1...35 mm ²	1...35 mm ²
Tightening torque	3...4 Nm	3...4 Nm	3...4 Nm
AC/DC supply	Any	Any	Any
Installation	On MCB, DIN rail	On MCB, DIN rail	On MCB, DIN rail
Type of protection	IP20	IP20	IP20
Permissible ambient temperature	-25°C...+60°C -13°F...+140°F	-25°C...+60°C -13°F...+140°F	-25°C...+60°C -13°F...+140°F
Storage temperature	-40°C...+70°C -40°F...+158°F	-40°C...+70°C -40°F...+158°F	-40°C...+70°C -40°F...+158°F
Resistance to vibration	IEC 60068-2-27, 60068-2, 61373 Cat. 1/ class B	IEC 60068-2-27, 60068-2, 61373 Cat. 1/ class B	IEC 60068-2-27, 60068-2, 61373 Cat. 1/ class B

Technical specifications undervoltage release S800-UVR

	S800-UVR36	S800-UVR60	S800-UVR130	S800-UVR250
Rated voltage	24...36 Vac/dc	48...60 Vac/dc	110...130 Vac/dc	220...250 Vac/dc
Operating opening	35...70% of nominal voltage	35...70% of nominal voltage	35...70% of nominal voltage	35...70% of nominal voltage
Operating closing	85% of nominal voltage	85% of nominal voltage	85% of nominal voltage	85% of nominal voltage
Insulation voltage	690 V	690 V	690 V	690 V
Coil pull in consumption	1 W (14 VA)	1 W (25 VA)	1 W (41 VA)	1 W (91 VA)
Rated frequency	DC 50/60 Hz	DC 50/60 Hz	DC 50/60 Hz	DC 50/60 Hz
Protection degree	3	3	3	3
Connectio Cu	1...35 mm ²	1...35 mm ²	1...35 mm ²	1...35 mm ²
Tightening torque	3...4 Nm	3...4 Nm	3...4 Nm	3...4 Nm
AC/DC supply	Any	Any	Any	Any
Installation	On MCB, DIN rail	On MCB, DIN rail	On MCB, DIN rail	On MCB, DIN rail
Type of protection	IP20	IP20	IP20	IP20
Permissible ambient temperature	-25°C...+60°C -13°F...+140°F	-25°C...+60°C -13°F...+140°F	-25°C...+60°C -13°F...+140°F	-25°C...+60°C -13°F...+140°F
Storage temperature	-40°C...+70°C -40°F...+158°F	-40°C...+70°C -40°F...+158°F	-40°C...+70°C -40°F...+158°F	-40°C...+70°C -40°F...+158°F
Resistance to vibration	IEC 60068-2-27, 60068-2, 61373 Cat. 1/ class B	IEC 60068-2-27, 60068-2, 61373 Cat. 1/ class B	IEC 60068-2-27, 60068-2, 61373 Cat. 1/ class B	IEC 60068-2-27, 60068-2, 61373 Cat. 1/ class B

Technical details

Electrical accessories (S800)

Technical specifications S803W-SCL-SR

	S803W-SCL-SR
Operating voltage	Up to 600 Vac (per UL 508)
Short circuit current rating (SCCR)	Up to 65 kA (per UL 508, CSA C22.2)
Pole	3
Frequency	50 / 60 Hz
Switching time (ON-OFF)	< 250 ms
Ambient operating temperature	-40°C...+70°C
Cable cross section	#14...1 AWG
Minimum cable length between devices	See below

Minimum cable length between S803W-SCL-SR and downstream devices

	Minimum length (X)	Minimum cross section
S803w-SCL32-SR	80 mm	#10 AWG (6 mm ²)
S803W-SCL63-SR	80 mm	#6 AWG (16 mm ²)
S803W-SCL100-SR	250 mm	#2 AWG (35 mm ²)

Tripping curves details

B tripping curve (S800)

Description

The "B" characteristic for S800 series offers instantaneous tripping between 3...5 times rated current in 50/60Hz systems.

Used for electric circuits feeding consumers that do not generate any current peaks, or only mild ones (boilers, electric heaters, cooking stoves).

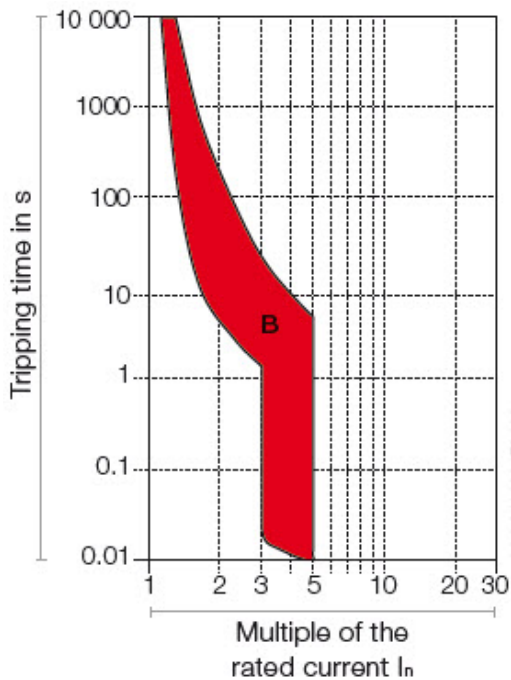

Standard	Currents	Thermal release		Magnetic release
		Small test current	Large test current	Range of instantaneous trip
IEC60947	10...100 A	1.05 x I _n	1.30 x I _n	3...5 x I _n

Tripping curves details

C tripping curve (S800)

Description

The "C" characteristic for S800 series offers instantaneous tripping between 5...10 times rated current in 50/60Hz systems.

Used for electric circuits feeding consumers that generate current peaks normal within inductive devices (fluorescent tubes, electric discharge lamps) as well as for circuits within sockets in commercially used systems/plants.

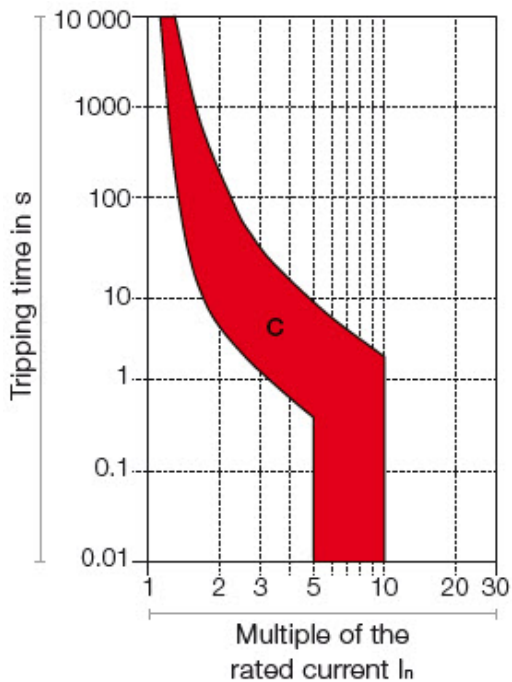

Standard	Currents	Thermal release		Magnetic release
		Small test current	Large test current	Range of instantaneous trip
IEC60947	10...100 A	$1.05 \times I_n$	$1.30 \times I_n$	$5...10 \times I_n$

Tripping curves details

D tripping curve (S800)

Description

The "D" characteristic for S800 series offers instantaneous tripping between 10...20 times rated current in 50/60Hz systems.

Used for electric circuits feeding consumers that generate extremely high current peaks (transformers, capacitor banks). As main circuit breaker connected upstream of other circuit breakers (reference overcurrent circuit breaker).

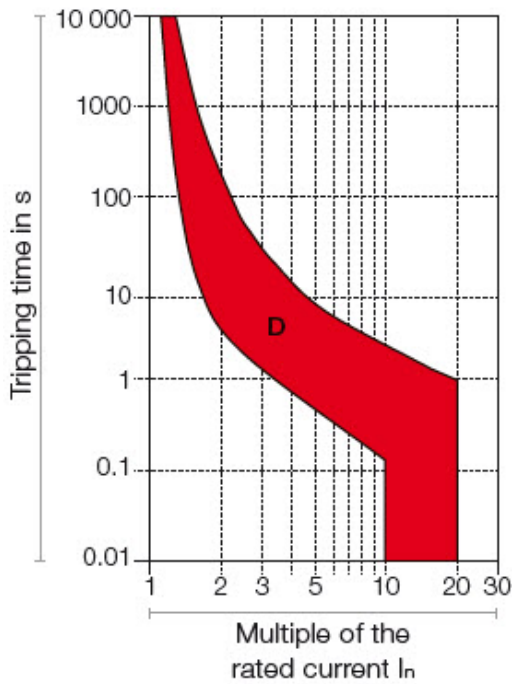

Standard	Currents	Thermal release		Magnetic release
		Small test current	Large test current	Range of instantaneous trip
IEC60947	10...100 A	1.05 x I_n	1.30 x I_n	10...20 x I_n

Tripping curves details

K tripping curve (S800)

Description

The "K" characteristic for S800 series offers instantaneous tripping between 10...14 times rated current in 50/60Hz systems.

Used as High Performance MCB in case of high magnetic inrush currents that occur, e.g. in engines or transformers. This characteristic provides the best protection for a wide range of electrical systems by allowing high inrush currents when starting up the system.

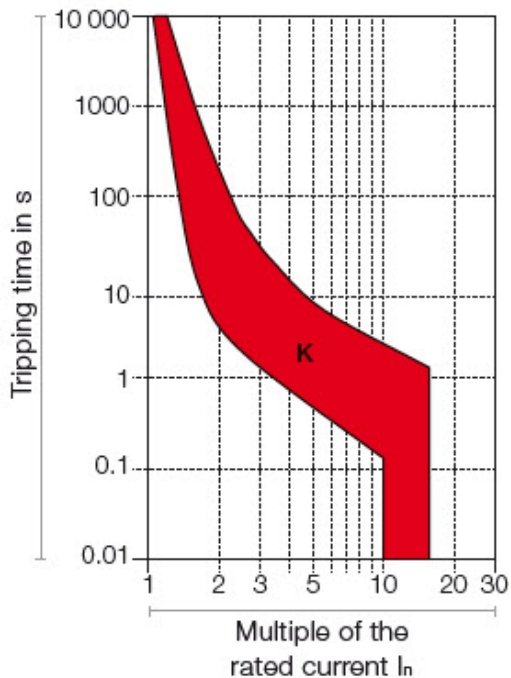

Standard	Currents	Thermal release		Magnetic release
		Small test current	Large test current	Range of instantaneous trip
IEC60947	10...100 A	$1.05 \times I_n$	$1.20 \times I_n$	10...14 x I_n

Dimensions

S800 series

S800C, S800S, S800HVC approximate dimensions

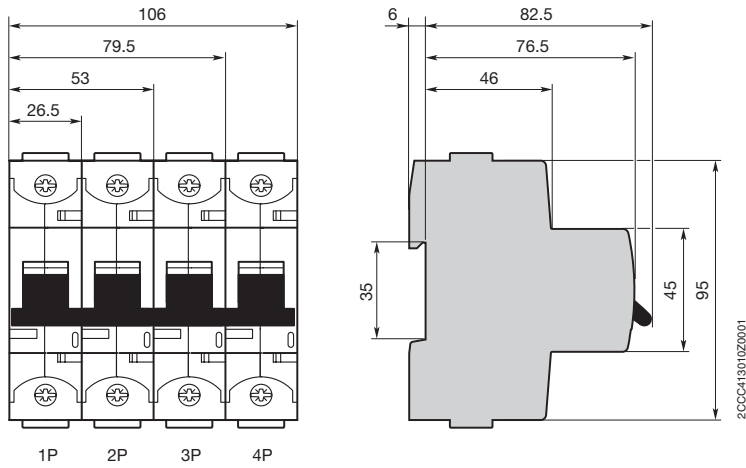

Dimensions

Accessories (S800)

S800-AUX and S800-AUX/ALT approximate dimensions

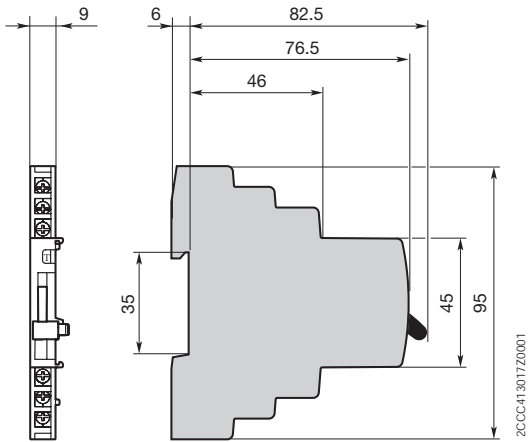

S800-SOR and S800-UVR approximate dimensions

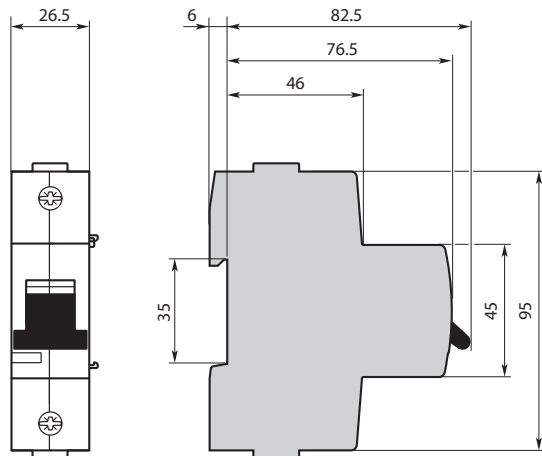



Notes

A series of horizontal dotted lines for taking notes.





Electronic protection devices

- 003** **Description and features**
- 004** **EPD24 series, accessories & dimensions**

Electronic Protection Devices

EPD24 series

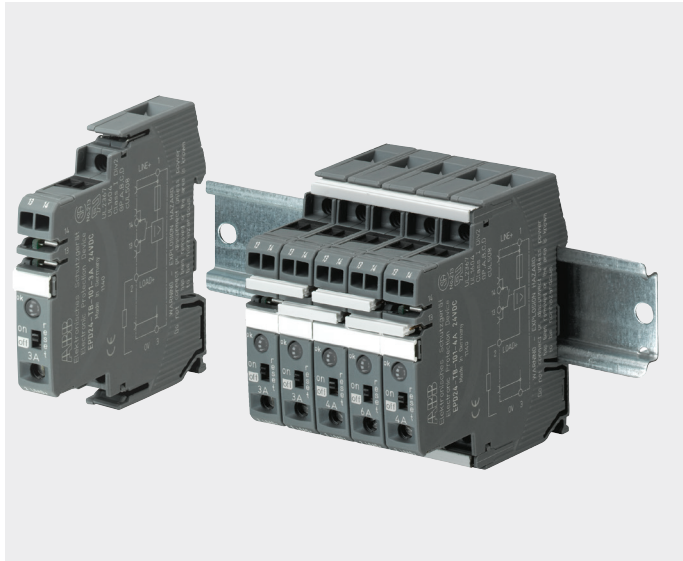

Description

The protection devices EPD24 extend the ABB product range of Modular DIN Rail Components by electronic overcurrent protection modules for selective protection of 24 V DC load circuits. This protection is achieved by a combination of active electronic current limitation in the case of a short circuit and an overload deactivation from 1.1 x I_N upwards.

If a fault occurs in a load circuit, the protection device EPD24 will detect this rapidly and reliably, disable the power output transistor and hence interrupt the current flow in the defective circuit. The maximum possible overcurrent is always limited to 1.3...1.8 times the selected rated current. An activation of capacitive loads up to 20,000 μF is possible, deactivation only occurring in the case of overloads or short circuits. Selective deactivation of the defective current circuit means undefined error states and a complete system stop are prevented.

	EPD24
Rated voltage	24 Vdc
Current range	0.5...12 A
Load output	Power-MOSFET switching output (high slide switch)
Degree of protection	IP20
Dielectric strength	32 Vdc max. (load circuit)
Protection degree	3
Weight	Apprx. 65g
Tightening torque	1.5...1.8 Nm
Wire size	0.5...4 mm ²
Installation	DIN rail
Approvals	UL 2367 Solid state overcurrent protectors UL 1604 (Class 1 Div.2 Group A, B, C, D) UL508 CSA C22.2 No. 213 (Class 1 Div.2) CSA C22.2 No. 142 CSA C22.2 No. 14 CE marked

Main features

- Selective load protection, one electronic tripping characteristic.
- Active current limitation for safe connection of capacitive loads up to 20,000 μF and on overload/short circuit.
- Current ratings from 0.5...12 A
- Reliable overload disconnection with 1.1 x I_N plus
- Manual ON/OFF button
- Clear status and failure indication through LED and integrated auxiliary contact
- Integral fail-safe element adjusted to current rating
- 12.5 mm wide unit
- DIN rail mounting
- Easy wiring through busbar LINE+ and 0V as well as signal bars
- UL and CSA approvals allow international use of the devices

EPD24 SERIES

Electronic Protection Devices

1 pole

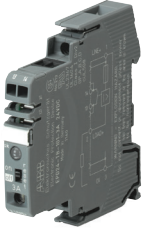

Box Qty	Weight each (kg)	Rated Current	Part number
4	0.065	0.5 A	EPD24-TB-101-0.5A
		1.0 A	EPD24-TB-101-1A
		2.0 A	EPD24-TB-101-2A
		3.0 A	EPD24-TB-101-3A
		4.0 A	EPD24-TB-101-4A
		6.0 A	EPD24-TB-101-6A
		8.0 A	EPD24-TB-101-8A
		10.0 A	EPD24-TB-101-10A
		63.0 A	EPD24-TB-101-12A

Busbar / signal bar accessories for EPD24 series

Description	Part number
<p>Busbars Busbars for LINE + and 0V, grey insulation, 500 mm length ⁽¹⁾</p>	EPD-BB500
<p>Signal bars Signal bars for auxiliary contacts, grey insulation, 21 mm length</p>	EPD-SB21

⁽¹⁾ Maximum load with one line entry 50 A (recommended center-feeding). Maximum load with two line entries 63 A

EPD24 approximate dimensions

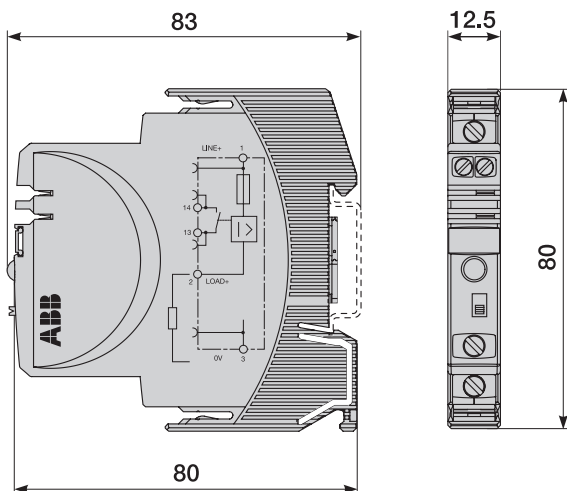

ABB - Campus Montréal

800 Hymus Boulevard
St-Laurent, Qc Canada
H4S 0B5
abb.com

Technical Support:
ep.support@ca.abb.com

We reserve the right to make technical changes or modify the contents of this document without prior notice. With regard to purchase orders and/or contracts, the agreed particulars shall prevail. ABB does not accept any responsibility whatsoever for potential errors or possible lack of information in this document. We reserve all rights in this document and in the subject matter and illustrations contained therein. Any reproduction, disclosure to third parties or utilization of its contents - in whole or in parts - is forbidden without prior written consent of ABB.