

# ACSM1

## User's Guide ACSM1 Control Panel



## ACSM1 Drive Manuals

### DRIVE HARDWARE MANUAL\*

---

ACSM1-04 Drive Modules (0.75 to 45 kW) Hardware Manual – 3AFE68797543 (English)

ACSM1-04 Drive Modules (55 to 110 kW) Hardware Manual – 3AFE68912130 (English)

ACSM1-04Lx Liquid-cooled Drive Modules (55 to 160 kW) Hardware Manual – 3AUA0000022083 (English)

### DRIVE FIRMWARE MANUALS

---

ACSM1 Speed and Torque Control Program Firmware Manual – 3AFE68848261 (English)

*For drives of type ACSM1-04xS...*

ACSM1 Motion Control Program Firmware Manual – 3AFE68848270 (English)

*For drives of type ACSM1-04xM...*

### DRIVE PC TOOLS MANUALS

---

DriveStudio User Manual – 3AFE68749026 (English)

DriveSPC User Manual – 3AFE68836590 (English)

### APPLICATION GUIDES

---

Functional Safety Solutions with ACSM1 Drives Application Guide – 3AUA0000031517 (English)

Safe Torque Off Function (STO) Application Guide – 3AFE68929814 (English)

System Engineering Manual – 3AFE68978297 (English)

ACSM1 Fieldbus Control with FPBA-01 PROFIBUS DP Adapter Module and ABB AC500 PLC; Application Guide – 3AUA0000049359 (English)

### OPTION MANUALS

---

FIO-01 Digital I/O Extension User's Manual\* – 3AFE68784921 (English)

FIO-11 Analog I/O Extension User's Manual\* – 3AFE68784930 (English)

FEN-01 TTL Encoder Interface User's Manual\* – 3AFE68784603 (English)

FEN-11 Absolute Encoder Interface User's Manual\* – 3AFE68784841 (English)

FEN-21 Resolver Interface User's Manual\* – 3AFE68784859 (English)

FEN-31 HTL Encoder Interface User's Manual\* – 3AUA0000031044 (English)

ACSM1 Control Panel User's Guide – 3AUA0000020131 (English)

\*A multilingual quick installation guide is included with the delivery.

# ACSM1 Control Panel

## **User's Guide**

3AUA0000020131 Rev B  
EN  
EFFECTIVE: 2009-08-12



# Table of contents

---

## **Table of contents**

### **About the manual**

What this chapter contains .....	7
Compatibility .....	7
Safety .....	7
Intended audience .....	7
Product and service inquiries .....	7
Product training .....	7
Providing feedback on ABB Drives manuals .....	7

### **Hardware description**

What this chapter contains .....	9
About control panels .....	9
Compatibility .....	9
ACSM1 Control Panel .....	10
Features .....	10
Overview .....	10
Maintenance .....	10
Status line .....	11

### **Installation**

What this chapter contains .....	13
Connecting the panel to the drive .....	13
The cable .....	13
Mounting the control panel .....	14
Mounting template .....	15
Gasket .....	16

### **Operation**

What this chapter contains .....	17
Basics of operation .....	17
List of tasks .....	18
Help and panel version – Any mode .....	19
How to get help .....	19
How to find out the panel version .....	19
Basic operations – Any mode .....	20
How to start, stop and switch between local and remote control .....	20
Output mode .....	21
How to change the direction of the motor rotation .....	21

How to select the monitored signals .....	22
How to set the speed, frequency, torque or position reference in the Output mode .....	23
How to adjust the display contrast .....	23
Parameters .....	24
How to select a parameter and change its value .....	24
How to change the value of value pointer parameters .....	25
How to change the value of bit pointer parameter to point to the value of a bit in another signal .....	27
How to change the value of bit pointer parameter to fixed 0 (FALSE) or 1 (TRUE) .....	29
Fault Logger .....	31
How to view faults .....	31
How to reset faults .....	31
Time & Date .....	32
How to show or hide the clock, change display formats, set the date and time and enable or disable clock transitions according to the daylight saving changes .....	32
Parameter Backup .....	34
How to backup and restore parameters .....	35
How to view information about the backup .....	41
Reference Edit .....	42
How to edit reference value .....	42
Drive Info .....	43
How to view drive info .....	43

# About the manual

---

## What this chapter contains

The chapter describes the compatibility and intended audience of this manual. There is also information about finding the safety instructions.

## Compatibility

The manual is compatible with the control panel of the ACSM1 drive.

## Safety

Follow all safety instructions delivered with the drive.

- Read the **complete safety instructions** before you install, commission, or use the drive. The complete safety instructions are given at the beginning of the *Hardware Manual*.
- Read the **software function specific warnings and notes** before changing the default settings of the function. For warnings and notes, see appropriate *Firmware Manual*.

## Intended audience

This manual is intended for persons who install and use the panel.

## Product and service inquiries

Address any inquiries about the product to your local ABB representative, quoting the type code and serial number of the unit in question. A listing of ABB sales, support and service contacts can be found by navigating to [www.abb.com/drives](http://www.abb.com/drives) and selecting *Sales, Support and Service network*.

## Product training

For information on ABB product training, navigate to [www.abb.com/drives](http://www.abb.com/drives) and select *Training courses*.

## Providing feedback on ABB Drives manuals

Your comments on our manuals are welcome. Go to [www.abb.com/drives](http://www.abb.com/drives) and select *Document Library – Manuals feedback form (LV AC drives)*.





# Hardware description

---

## What this chapter contains

The chapter describes the control panel keys. It also instructs in using the panel in control, monitoring and changing the settings.

## About control panels

Use a control panel to control the ACSM1, read status data, and adjust parameters.

## Compatibility

The manual is compatible with the ACSM1 drive control panel SW rev 3.05 and Flash rev 3.4.1.6 or later.

See page [19](#) for how to find out the control panel version.

## ACSM1 Control Panel

### Features

The ACSM1 Control Panel features:

- alphanumeric control panel with an LCD display
- context sensitive help
- real time clock.

### Overview

The following table summarizes the key functions and displays on the ACSM1 Control Panel.

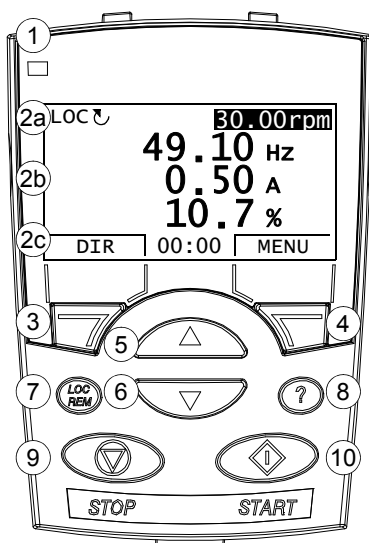

No.	Use
1	Status LED – Green for normal operation.
2	LCD display – Divided into three main areas: <ol style="list-style-type: none"> <li>Status line – variable, depending on the mode of operation, see section <a href="#">Status line</a> on page 11.</li> <li>Center – variable; in general, shows signal and parameter values, menus or lists. Shows also faults and alarms.</li> <li>Bottom line – shows current functions of the two soft keys and, if enabled, the clock display.</li> </ol>
3	Soft key 1 – Function depends on the context. The text in the lower left corner of the LCD display indicates the function.
4	Soft key 2 – Function depends on the context. The text in the lower right corner of the LCD display indicates the function.
5	Up – <ul style="list-style-type: none"> <li>• Scrolls up through a menu or list displayed in the center of the LCD display.</li> <li>• Increments a value if a parameter is selected.</li> <li>• Increments the reference value if the upper right corner is highlighted. Holding the key down changes the value faster.</li> </ul>
6	Down – <ul style="list-style-type: none"> <li>• Scrolls down through a menu or list displayed in the center of the LCD display.</li> <li>• Decrements a value if a parameter is selected.</li> <li>• Decrements the reference value if the upper right corner is highlighted. Holding the key down changes the value faster.</li> </ul>
7	LOC/REM – Changes between local and remote control of the drive.
8	Help – Displays context sensitive information when the key is pressed. The information displayed describes the item currently highlighted in the center of the display.
9	STOP – Stops the drive in local control.
10	START – Starts the drive in local control.

### Maintenance

Control panel battery must be replaced every 10 years. The battery is housed on the rear of the control panel. Replace it with a new CR 2032 battery.

## Status line

The top line of the LCD display shows the basic status information of the drive.

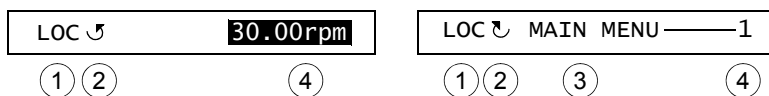

No.	Field	Alternatives	Significance
1	Control location	LOC	Drive control is local, that is, from the control panel.
		REM	Drive control is remote, such as the drive I/O or fieldbus.
2	State	↶	Forward shaft direction
		↷	Reverse shaft direction
		Rotating arrow	Drive is running at reference point.
		Dotted rotating arrow	Drive is running but not at reference point.
		Stationary arrow	Drive is stopped.
		Dotted stationary arrow	Start command is present, but the motor is not running, e.g. because start enable is missing.
3	Panel operation mode		<ul style="list-style-type: none"> <li>Name of the current mode</li> <li>Name of the list or menu shown</li> <li>Name of the operation state, e.g. REF EDIT.</li> </ul>
4	Reference value or number of the selected item		<ul style="list-style-type: none"> <li>Reference value in the Output mode</li> <li>Number of the highlighted item, e.g. mode, parameter group or fault.</li> </ul>



# Installation

---

## What this chapter contains

The chapter describes connecting and mounting of the control panel.

## Connecting the panel to the drive

The control panel connection to the drive is shown in the figure below. See also *ACSM1-04 Drive Modules Hardware Manual* [3AFE68797543 (English)].

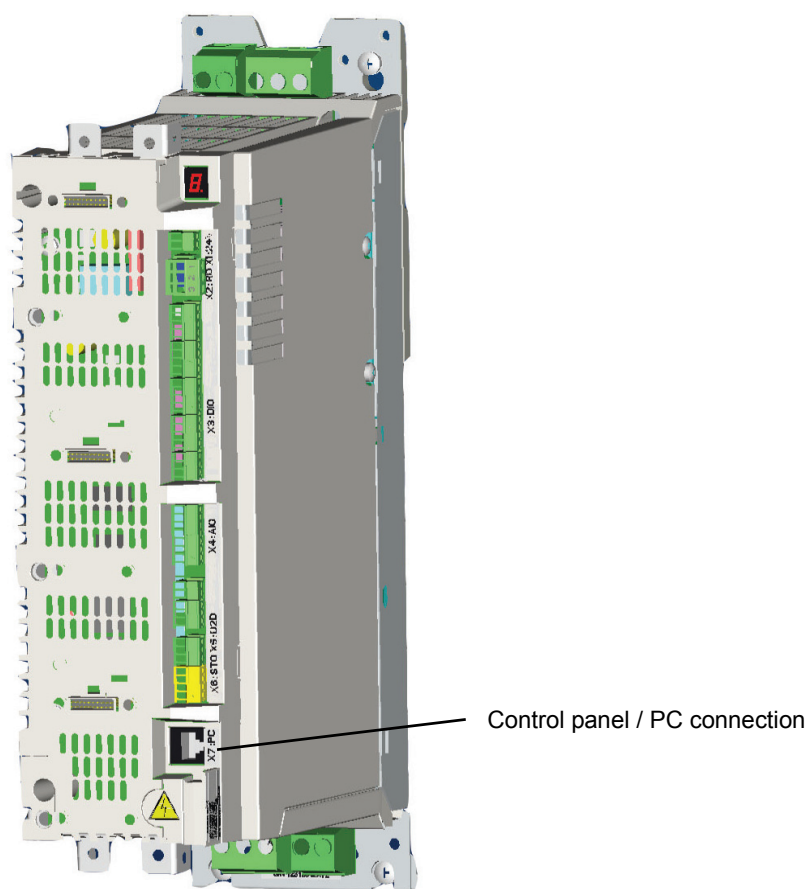

## The cable

CAT5 straight-through network cable (max. 3 m) can be used. The cable is available from ABB, but other cables fulfilling the specifications of that cable can be used.

## Mounting the control panel

There are two panel mounting kits, IP21 (68294673) and IP66 (68829593). The kits contain an extension cable, a gasket and other mounting accessories needed for installing the panel to the cabinet door. The kits also contain installation instructions as drawings, see the figures below.

### Mounting template

PANEL MOUNTING TEMPLATE

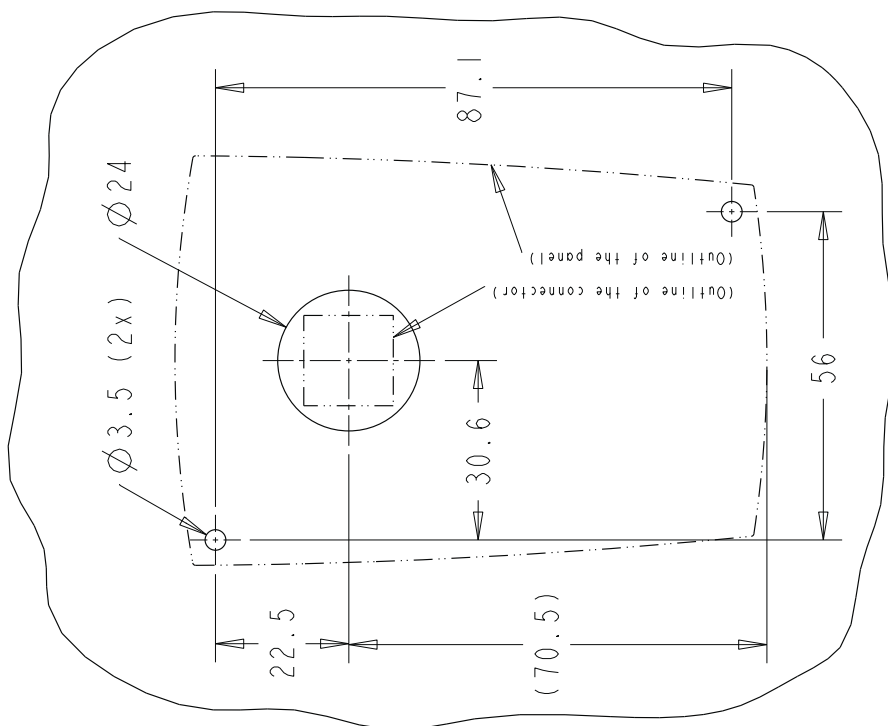

SCALE 1:1

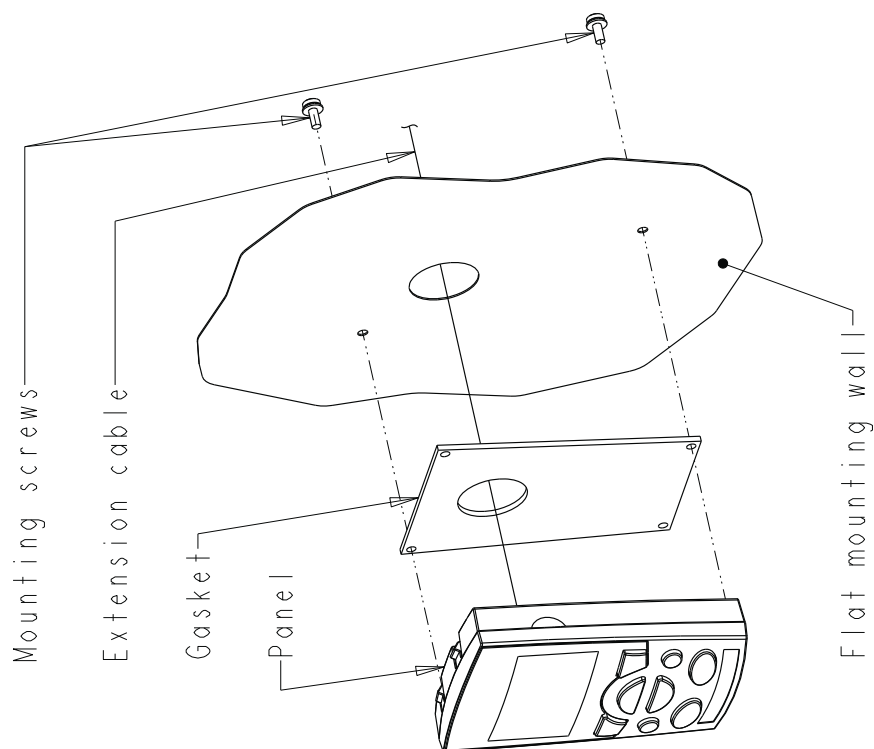

**Gasket**

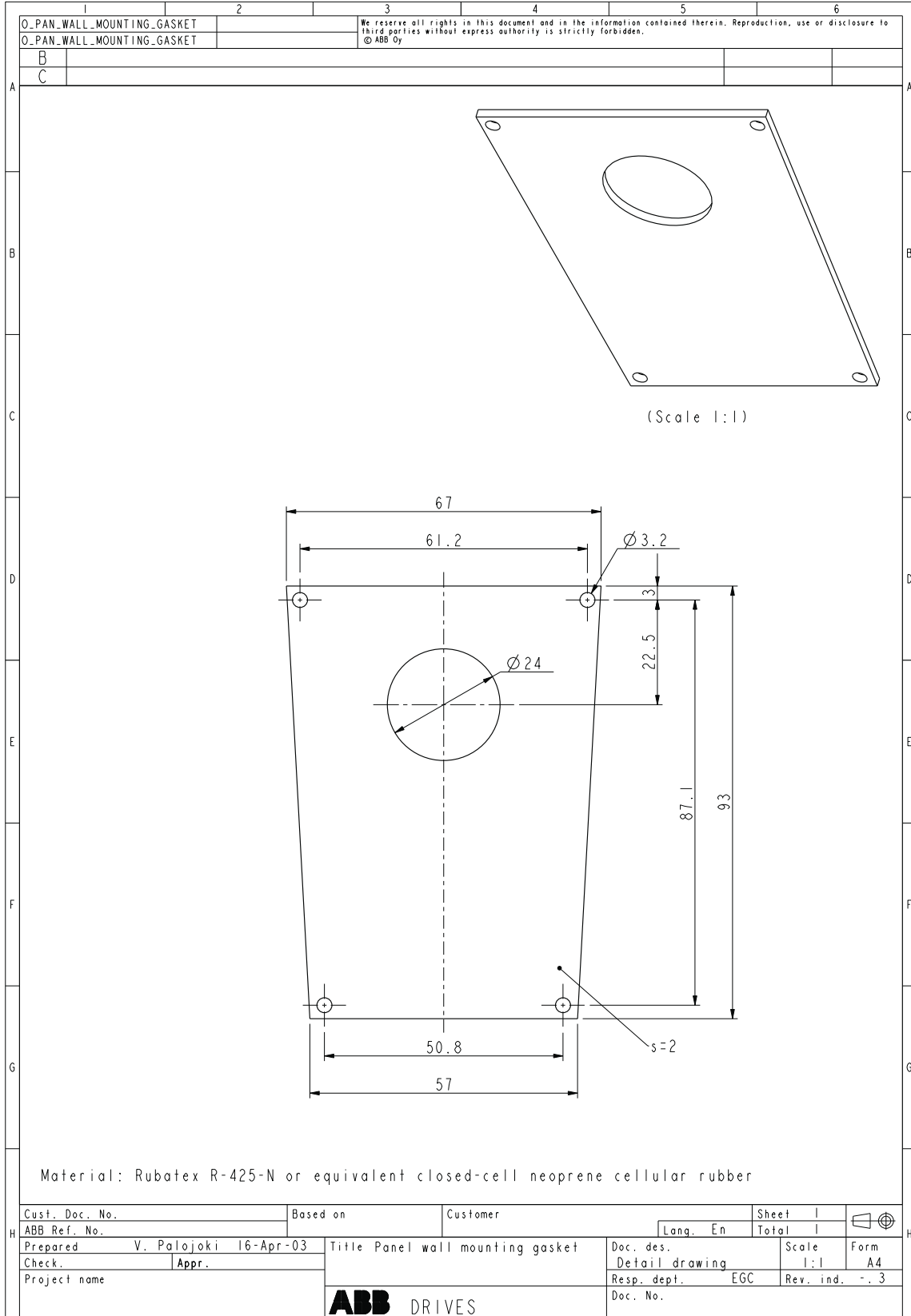



# Operation



---

## What this chapter contains

The chapter describes the operation of the control panel.

## Basics of operation

You operate the control panel with menus and keys. The keys include two context-sensitive soft keys, whose current function is indicated by the text shown in the display above each key.

You select an option, e.g. operation mode or parameter, by entering the MENU state using soft key 2, and then by scrolling the  and  arrow keys until the option is highlighted and then pressing the relevant soft key. With the right soft key you usually enter a mode, accept an option or save the changes. The left soft key is used to cancel the made changes and return to the previous operation level.

The ACSM1 Control Panel has six options in the Main menu: Parameters, Fault Logger, Time & Date, Parameter Backup, Reference Edit and Drive Info. In addition, the control panel has an Output mode, which is used as default. Also, when a fault or alarm occurs, the panel goes automatically to the Fault mode showing the fault or alarm. You can reset the fault in the Output or Fault mode. The operation in these modes and options is described in this chapter.

Initially, the panel is in the Output mode, where you can start, stop, change the direction, switch between local and remote control, modify the reference value and monitor up to three actual values. To do other tasks, go first to the Main menu and select the appropriate option on the menu. The status line (see section *Status line* on page 11) shows the name of the current menu, mode, item or state.

LOC ↺	50.00rpm
49.10 Hz	
0.50 A	
10.7 %	
DIR	00:00 MENU

LOC ↺ MAIN MENU	1
<b>PARAMETERS</b>	
<b>FAULT LOGGER</b>	
<b>TIME &amp; DATE</b>	
EXIT	00:00 ENTER

## List of tasks



The table below lists common tasks, the mode in which you can perform them, abbreviations of the options in the Main menu and the page number where the steps to do the task are described in detail.

Task	Mode / Main menu option	Abbreviations of the Main menu options *	Page
How to get help	Any	-	19
How to find out the panel version	Any	-	19
How to start and stop the drive	Output	-	20
How to switch between local and remote control	Any	-	20
How to change the direction of the motor rotation	Any	-	21
How to select the monitored signals	Parameters	PARAMETERS	22
How to set the speed, frequency, torque or position reference in the Output mode	Output	-	23
How to adjust the display contrast	Output	-	23
How to change the value of a parameter	Parameters	PARAMETERS	24
How to change the value of value pointer parameters	Parameters	PARAMETERS	25
How to change the value of bit pointer parameter to point to the value of a bit in another signal	Parameters	PARAMETERS	27
How to change the value of bit pointer parameter to fixed 0 (FALSE) or 1 (TRUE)	Parameters	PARAMETERS	29
How to view faults	Fault Logger	FAULT LOGGER	31
How to reset faults and alarms	Fault Logger	FAULT LOGGER	31
How to show/hide the clock, change date and time formats, set the clock and enable/disable automatic clock transitions according to the daylight saving changes	Time & Date	TIME & DATE	32
How to copy parameters from the drive to the control panel	Parameter Backup	PAR BACKUP	35
How to restore parameters from the control panel to the drive	Parameter Backup	PAR BACKUP	35
How to view backup information	Parameter Backup	PAR BACKUP	41
How to edit reference value	Reference Edit	REF EDIT	42
How to view drive info	Drive Info	DRIVE INFO	43

\* Main menu options actually shown in the control panel.

## Help and panel version – Any mode

### How to get help

Step	Action	Display
1.	Press <b>(?)</b> to read the context-sensitive help text for the item that is highlighted.  If help text exists for the item, it is shown on the display.	<pre> LOC ↵ TIME &amp; DATE — 6 TIME FORMAT DATE FORMAT SET TIME SET DATE DAYLIGHT SAVING EXIT   00:00   SEL </pre> <pre> LOC ↵ HELP Use daylight saving to enable or disable automatic clock adjustment according to daylight saving EXIT   00:00   </pre>
2.	If the whole text is not visible, scroll the lines with keys  and  .	<pre> LOC ↵ HELP to enable or disable automatic clock adjustment according to daylight saving changes EXIT   00:00   </pre>
3.	After reading the text, return to the previous display by pressing  .	<pre> LOC ↵ TIME &amp; DATE — 6 TIME FORMAT DATE FORMAT SET TIME SET DATE DAYLIGHT SAVING EXIT   00:00   SEL </pre>









### How to find out the panel version

Step	Action	Display
1.	If the power is switched on, switch it off.  - If the panel cable can be disconnected easily, unplug the panel cable from the control panel, OR  - if the panel cable can not be disconnected easily, switch off the control board or the drive.	
2.	Keep key <b>(?)</b> pressed down while you switch on the power and read the information. The display shows the following panel information:  Panel SW: panel firmware version ROM CRC: panel ROM check sum Flash Rev: flash content version Flash content comment.  When you release the <b>(?)</b> key, the panel goes to the Output mode.	<pre> PANEL VERSION INFO Panel SW:      x.xx ROM CRC:      xxxxxxxxxx Flash Rev:    x.xx xxxxxxxxxxxxxxxxxxxxxxxx xxxxxxxxxxxxxxxxxxxxxxxx </pre>

## Basic operations – Any mode

### How to start, stop and switch between local and remote control

You can start, stop and switch between local and remote control in any mode. To be able to start or stop the drive by using the control panel, the drive must be in local control.

Step	Action	Display
1.	<ul style="list-style-type: none"> <li>• To switch between remote control (REM shown on the status line) and local control (LOC shown on the status line), press .</li> </ul> <p><b>Note:</b> Switching to local control can be disabled with parameter 1601 LOCAL LOCK.</p> <p>The very first time the drive is powered up, it is in remote control (REM) and controlled through the drive I/O terminals. To switch to local control (LOC) and control the drive using the control panel, press . The result depends on how long you press the key:</p> <ul style="list-style-type: none"> <li>• If you release the key immediately (the display flashes “Switching to the local control mode”), the drive stops. Set the local control reference as instructed on page 23.</li> <li>• If you press the key for about two seconds, the drive continues running as before. The drive copies the current remote values for the run/stop status and the reference, and uses them as the initial local control settings.</li> <li>• To stop the drive in local control, press .</li> <li>• To start the drive in local control, press .</li> </ul>	<div style="border: 1px solid black; padding: 5px; margin-bottom: 10px;"> <p>LOC  MESSAGE Switching to the local control mode.</p> <hr/> <p style="text-align: center;">00:00</p> </div> <p>The arrow ( or ) on the status line stops rotating.</p> <p>The arrow ( or ) on the status line starts rotating. It is dotted until the drive reaches the setpoint.</p>

## Output mode

In the Output mode, you can:











- monitor actual values of up to three signals
- change the direction of the motor rotation
- set the speed, frequency, torque or position reference
- adjust the display contrast
- start, stop, change the direction and switch between local and remote control.

You get to the Output mode by pressing  repeatedly.

The top right corner of the display shows the reference value. The center can be configured to show up to three signal values or bar graphs.

LOC 	<b>30.00rpm</b>
49.10 Hz	
0.50 A	
10.7 %	
DIR	00:00 MENU

### How to change the direction of the motor rotation





Step	Action	Display										
1.	If you are not in the Output mode, press  repeatedly until you get there.	<table border="1"> <tr> <td>REM </td> <td><b>30.00rpm</b></td> </tr> <tr> <td>49.10 Hz</td> <td></td> </tr> <tr> <td>0.50 A</td> <td></td> </tr> <tr> <td>10.7 %</td> <td></td> </tr> <tr> <td>DIR</td> <td>00:00 MENU</td> </tr> </table>	REM 	<b>30.00rpm</b>	49.10 Hz		0.50 A		10.7 %		DIR	00:00 MENU
REM 	<b>30.00rpm</b>											
49.10 Hz												
0.50 A												
10.7 %												
DIR	00:00 MENU											
2.	If the drive is in remote control (REM shown on the status line), switch to local control by pressing  . The display briefly shows a message about changing the mode and then returns to the Output mode.	<table border="1"> <tr> <td>LOC </td> <td><b>30.00rpm</b></td> </tr> <tr> <td>49.10 Hz</td> <td></td> </tr> <tr> <td>0.50 A</td> <td></td> </tr> <tr> <td>10.7 %</td> <td></td> </tr> <tr> <td>DIR</td> <td>00:00 MENU</td> </tr> </table>	LOC 	<b>30.00rpm</b>	49.10 Hz		0.50 A		10.7 %		DIR	00:00 MENU
LOC 	<b>30.00rpm</b>											
49.10 Hz												
0.50 A												
10.7 %												
DIR	00:00 MENU											
3.	To change the direction from forward (  shown on the status line) to reverse (  shown on the status line), or vice versa, press  .											

### How to select the monitored signals



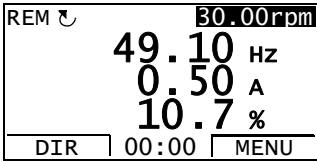

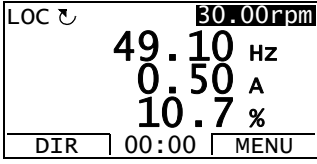
Step	Action	Display
1.	You can select which signals are monitored in the Output mode and how they are displayed with group 17 PANEL DISPLAY parameters. See page 24 for detailed instructions on changing parameter values.	<div style="border: 1px solid black; padding: 5px; margin-bottom: 5px;">                     LOC <input type="checkbox"/> PAR EDIT                      1701 SIGNAL1 PARAM  <b>01.03</b>                      CANCEL   00:00   NEXT                 </div> <div style="border: 1px solid black; padding: 5px; margin-bottom: 5px;">                     LOC <input type="checkbox"/> PAR EDIT                      1702 SIGNAL2 PARAM  <b>01.04</b>                      CANCEL   00:00   NEXT                 </div> <div style="border: 1px solid black; padding: 5px;">                     LOC <input type="checkbox"/> PAR EDIT                      1703 SIGNAL3 PARAM  <b>01.06</b>                      CANCEL   00:00   NEXT                 </div>

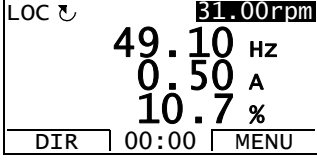
## How to set the speed, frequency, torque or position reference in the Output mode

See also section [Reference Edit](#) on page 42.

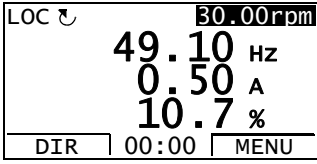
Step	Action	Display
1.	If you are not in the Output mode, press  repeatedly until you get there.	
2.	If the drive is in remote control (REM shown on the status line), switch to local control by pressing  . The display briefly shows a message about changing the mode and then returns to the Output mode.	
3.	<ul style="list-style-type: none"> <li>To increase the highlighted reference value shown in the top right corner of the display, press . The value changes immediately. It is stored in the permanent memory of the drive and restored automatically after power switch-off.</li> <li>To decrease the value, press .</li> </ul>	

## How to adjust the display contrast

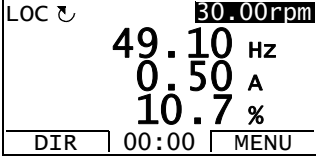











Step	Action	Display
1.	If you are not in the Output mode, press  repeatedly until you get there.	
2.	<ul style="list-style-type: none"> <li>To increase the contrast, press keys  and  simultaneously.</li> <li>To decrease the contrast, press keys  and  simultaneously.</li> </ul>	

## Parameters



In the Parameters option, you can:

- view and change parameter values
- start, stop, change the direction and switch between local and remote control.

### How to select a parameter and change its value

Step	Action	Display
1.	Go to the Main menu by pressing  if you are in the Output mode, otherwise by pressing  repeatedly until you get to the Main menu.	<pre> LOC ↺ MAIN MENU ——— 1 PARAMETERS FAULT LOGGER TIME &amp; DATE EXIT   00:00   ENTER                     </pre>
2.	Go to the Parameters option by selecting PARAMETERS on the menu with keys  and  , and pressing  .	<pre> LOC ↺ PAR GROUPS ——— 01 01 ACTUAL VALUES 02 I/O VALUES 03 CONTROL VALUES 04 POS CTRL VALUES 06 DRIVE STATUS EXIT   00:00   SEL                     </pre>
3.	Select the appropriate parameter group with keys  and  .  Press  .	<pre> LOC ↺ PAR GROUPS ——— 99 99 START-UP DATA 01 ACTUAL VALUES 02 I/O VALUES 03 CONTROL VALUES 04 POS CTRL VALUES EXIT   00:00   SEL  LOC ↺ PARAMETERS ——— 9901 LANGUAGE ENGLISH 9904 MOTOR TYPE 9906 MOT NOM CURRENT 9907 MOT NOM VOLTAGE EXIT   00:00   EDIT                     </pre>
4.	Select the appropriate parameter with keys  and  . The current value of the parameter is shown below the selected parameter.  Press  .	<pre> LOC ↺ PARAMETERS ——— 9901 LANGUAGE 9904 MOTOR TYPE AM 9906 MOT NOM CURRENT 9907 MOT NOM VOLTAGE EXIT   00:00   EDIT  LOC ↺ PAR EDIT ——— 9904 MOTOR TYPE AM [0] CANCEL   00:00   SAVE                     </pre>
5.	Specify a new value for the parameter with keys  and  .  Pressing the key once increments or decrements the value. Holding the key down changes the value faster. Pressing the keys simultaneously replaces the displayed value with the default value.	<pre> LOC ↺ PAR EDIT ——— 9904 MOTOR TYPE PMSM [1] CANCEL   00:00   SAVE                     </pre>





















Step	Action	Display
6.	<ul style="list-style-type: none"> <li>To save the new value, press .</li> <li>To cancel the new value and keep the original, press .</li> </ul>	<pre> LOC ↵ PARAMETERS 9901 LANGUAGE 9904 MOTOR TYPE       PMSM 9906 MOT NOM CURRENT 9907 MOT NOM VOLTAGE EXIT   00:00   EDIT </pre>

### How to change the value of value pointer parameters

In addition to the parameters shown above, there are two kinds of pointer parameters; value pointer parameters and bit pointer parameters. The value pointer parameter points to the value of another parameter/signal. The source parameter is given in format **P.xx.yy**, where xx = Parameter group; yy = parameter index.

For more information, see appropriate *Firmware Manual*.

Step	Action	Display
1.	Go to the Main menu by pressing  if you are in the Output mode, otherwise by pressing  repeatedly until you get to the Main menu.	<pre> LOC ↵ MAIN MENU — 1 PARAMETERS FAULT LOGGER TIME &amp; DATE EXIT   00:00   ENTER </pre>
2.	Go to the Parameters option by selecting PARAMETERS on the menu with keys  and  , and pressing  .	<pre> LOC ↵ PAR GROUPS — 01 01 ACTUAL VALUES 02 I/O VALUES 03 CONTROL VALUES 04 POS CTRL VALUES 06 DRIVE STATUS EXIT   00:00   SEL </pre>
3.	Select the appropriate parameter group with keys  and  . Here the value pointer parameter 15.01 AO1 PTR is used as an example.	<pre> LOC ↵ PAR GROUPS — 15 10 START/STOP 11 START/STOP MODE 12 DIGITAL IO 13 ANALOGUE INPUTS 15 ANALOGUE OUTPUTS EXIT   00:00   SEL </pre>
4.	Press  to select the appropriate parameter group. Select the appropriate parameter with keys  and  , current value of each parameter is shown below it.	<pre> LOC ↵ PARAMETERS 1501 AO1 PTR       P.01.05 1502 AO1 FILT TIME 1503 AO1 MAX 1504 AO1 MIN EXIT   00:00   EDIT </pre>
5.	Press  . Current value of the value pointer parameter is shown, as well as the parameter group it points to.	<pre> LOC ↵ PAR EDIT 1501 AO1 PTR       P.01.05 01 ACTUAL VALUES CANCEL   00:00   NEXT </pre>
6.	Specify a new parameter group for the value pointer parameter to point to with keys  and  . The parameter group changes respectively.	<pre> LOC ↵ PAR EDIT 1501 Ao1 PTR       P.02.05 02 I/O VALUES CANCEL   00:00   NEXT </pre>













Step	Action	Display
7.	<ul style="list-style-type: none"> <li>To continue, press .</li> <li>To cancel the new value and keep the original, press .</li> </ul> <p>Specify a new parameter for the value pointer parameter to point to with keys  and . The parameter changes respectively.</p>	<pre> LOC ↻ PAR EDIT 1501 AO1 PTR       P.02.08 0208 AO1 CANCEL   00:00   SAVE           </pre>
8.	<ul style="list-style-type: none"> <li>To save the new value for the pointer parameter, press .</li> <li>To cancel the new value and keep the original, press .</li> </ul> <p>The new value is shown in the parameters list.</p>	<pre> LOC ↻ PARAMETERS 1501 AO1 PTR       P.02.08 1502 AO1 FILT TIME 1503 AO1 MAX 1504 AO1 MIN EXIT   00:00   EDIT           </pre>













## How to change the value of bit pointer parameter to point to the value of a bit in another signal

The bit pointer parameter points to the value of a bit in another signal, or can be fixed to 0 (FALSE) or 1 (TRUE). For the latter option, see page 29. The bit pointer parameter points to a bit value (0 or 1) of one bit in a 32-bit signal. The first bit from the left is bit number 31, and the first bit from the right is bit number 0. E.g. bit 01 stands for bit number  $2^1 = 2$ , the second bit from the right, and number 00 stands for bit number  $2^0 = 1$ , the first bit from the right.

When adjusting a bit pointer parameter on the control panel, POINTER is selected to define a source from another signal. A pointer value is given in format **P.xx.yy.zz**, where xx = Parameter group; yy = Parameter index, zz = Bit number.

For more information, see appropriate *Firmware Manual*.

Step	Action	Display
1.	Go to the Main menu by pressing  if you are in the Output mode, otherwise by pressing  repeatedly until you get to the Main menu.	<pre> LOC ↺ MAIN MENU ——— 1 PARAMETERS FAULT LOGGER TIME &amp; DATE EXIT   00:00   ENTER </pre>
2.	Go to the Parameters option by selecting PARAMETERS on the menu with keys  and  , and pressing  .	<pre> LOC ↺ PAR GROUPS ——— 01 01 ACTUAL VALUES 02 I/O VALUES 03 CONTROL VALUES 04 POS CTRL VALUES 06 DRIVE STATUS EXIT   00:00   SEL </pre>
3.	Select the appropriate parameter group with keys  and  . Here the bit pointer parameter 12.04 DI01 OUT PTR is used as an example.	<pre> LOC ↺ PAR GROUPS ——— 12 12 DIGITAL IO 13 ANALOGUE INPUTS 15 ANALOGUE OUTPUTS 16 SYSTEM 17 PANEL DISPLAY EXIT   00:00   SEL </pre>
4.	Press  to select the appropriate parameter group. Select the appropriate parameter with keys  and  . Current value of each parameter is shown below its name.	<pre> LOC ↺ PARAMETERS ——— 1201 DI01 CONF 1202 DI02 CONF 1203 DI03 CONF 1204 DI01 OUT PTR       P.01.01.00 EXIT   00:00   EDIT </pre>
5.	Press  .	<pre> LOC ↺ PAR EDIT ——— 1204 DI01 OUT PTR       Pointer CANCEL   00:00   NEXT </pre>
6.	Press  . Current value of the bit pointer parameter is shown, as well as the parameter group it points to.	<pre> LOC ↺ PAR EDIT ——— 1204 DI01 OUT PTR       P.01.01.00 01 ACTUAL VALUES CANCEL   00:00   NEXT </pre>

















Step	Action	Display
7.	Specify a new parameter group for the bit pointer parameter to point to with keys  and  . The parameter group changes respectively.	<pre> LOC ↻ PAR EDIT 1204 DI01 OUT PTR <b>P.06.01.00</b> 06 DRIVE STATUS [CANCEL] 00:00   NEXT </pre>
8.	<ul style="list-style-type: none"> <li>To continue, press .</li> <li>To cancel the new value and keep the original, press .</li> </ul> Specify a new parameter for the bit pointer parameter to point to with keys  and  . The parameter name changes respectively.	<pre> LOC ↻ PAR EDIT 1204 DI01 OUT PTR <b>P.06.01.00</b> 0601 STATUS WORD 1 [CANCEL] 00:00   NEXT </pre>
9.	<ul style="list-style-type: none"> <li>To continue, press .</li> <li>To cancel the new value and keep the original, press .</li> </ul> Specify a new bit for the bit pointer parameter to point to with keys  and  . The bit number and name (if defined) change respectively. Here bit 00 stands for bit number $2^0 = 1$ , the first bit from the right in a 32-bit signal.	<pre> LOC ↻ PAR EDIT 1204 DI01 OUT PTR <b>P.06.01.00</b> 00 READY [CANCEL] 00:00   SAVE </pre>
10.	<ul style="list-style-type: none"> <li>To save the new value for the bit pointer parameter, press .</li> <li>To cancel the new value and keep the original, press .</li> </ul> The new value is shown in the parameters list.	<pre> LOC ↻ PARAMETERS 1201 DI01 CONF 1202 DI02 CONF 1203 DI03 CONF <b>1204 DI01 OUT PTR</b> <b>P.06.01.00</b> [EXIT] 00:00   EDIT </pre>



### How to change the value of bit pointer parameter to fixed 0 (FALSE) or 1 (TRUE)

The bit pointer parameter can be fixed to constant value of 0 (FALSE) or 1 (TRUE).

When adjusting a bit pointer parameter on the control panel, CONST is selected in order to fix the value to 0 (displayed as C.FALSE.) or 1 (C.TRUE.).

For more information, see appropriate *Firmware Manual*.

Step	Action	Display
1.	Go to the Main menu by pressing  if you are in the Output mode, otherwise by pressing  repeatedly until you get to the Main menu.	<pre> LOC  MAIN MENU  —1 PARAMETERS FAULT LOGGER TIME &amp; DATE EXIT  00:00  ENTER </pre>
2.	Go to the Parameters option by selecting PARAMETERS on the menu with keys  and  , and pressing  .	<pre> LOC  PAR GROUPS—01 01 ACTUAL VALUES 02 I/O VALUES 03 CONTROL VALUES 04 POS CTRL VALUES 06 DRIVE STATUS EXIT  00:00  SEL </pre>
3.	Select the appropriate parameter group with keys  and  . Here the bit pointer parameter 12.04 DI01 OUT PTR is used as an example.	<pre> LOC  PAR GROUPS—12 12 DIGITAL IO 13 ANALOGUE INPUTS 15 ANALOGUE OUTPUTS 16 SYSTEM 17 PANEL DISPLAY EXIT  00:00  SEL </pre>
4.	Press  to select the appropriate parameter group. Select the appropriate parameter with keys  and  . Current value of each parameter is shown below its name.	<pre> LOC  PARAMETERS— 1201 DI01 CONF 1202 DI02 CONF 1203 DI03 CONF 1204 DI01 OUT PTR       P.06.02.02 EXIT  00:00  EDIT </pre>
5.	Press  .  Select CONST with keys  and  .	<pre> LOC  PAR EDIT— 1204 DI01 OUT PTR       Pointer CANCEL 00:00  NEXT  LOC  PAR EDIT— 1204 DI01 OUT PTR       Const CANCEL 00:00  NEXT </pre>
6.	Press  .	<pre> LOC  PAR EDIT— 1204 DI01 OUT PTR       C.FALSE [0] CANCEL 00:00  SAVE </pre>
7.	Specify a new constant value (TRUE or FALSE) for the bit pointer parameter with keys  and  .	<pre> LOC  PAR EDIT— 1204 DI01 OUT PTR       C.TRUE [1] CANCEL 00:00  SAVE </pre>











Step	Action	Display
8.	<ul style="list-style-type: none"> <li>• To continue, press .</li> <li>• To cancel the new value and keep the original, press .</li> </ul> <p>The new value is shown in the parameters list.</p>	<pre> LOC ↵ PARAMETERS 1201 DI01 CONF 1202 DI02 CONF 1203 DI03 CONF 1204 DI01 OUT PTR       C.TRUE EXIT   00:00   EDIT </pre>

## Fault Logger



In the Fault Logger option, you can:

- view the drive fault history
- see the details of the most recent faults
- start, stop, change the direction and switch between local and remote control.

### How to view faults

Step	Action	Display
1.	Go to the Main menu by pressing  if you are in the Output mode, otherwise by pressing  repeatedly until you get to the Main menu.	<pre> LOC ↻ MAIN MENU ——— 2 PARAMETERS <b>FAULT LOGGER</b> TIME &amp; DATE EXIT   00:00   ENTER </pre>
2.	Go to the Fault Logger option by selecting FAULT LOGGER on the menu with keys  and  , and pressing  . • If there are no faults in the fault history, corresponding text will be shown.	<pre> LOC ↻ MESSAGE ——— No fault history found </pre>
	<ul style="list-style-type: none"> <li>• If there is a fault history, the display shows the fault log starting with the most recent fault. The number on the row is the fault code according to which the causes and corrective actions are listed in appropriate <i>Firmware Manual</i>.</li> <li>• To see the details of a fault, select it with keys  and , and press .</li> <li>• Scroll the text with keys  and .</li> <li>• After reading it, press  to return to the previous display.</li> </ul>	<pre> LOC ↻ FAULT LOGGER — 1: 36: LOCAL CTRL LOSS 29.04.08 10:45:58 EXIT   00:00   DETAIL </pre> <pre> LOC ↻ LOCAL CTRL LOSS TIME 10:45:58 FAULT CODE 36 FAULT CODE EXTENSION EXIT   00:00   </pre>

### How to reset faults

Step	Action	Display
1.	When a fault occurs, text identifying the fault is shown. • To reset the fault, press  . • To return to the previous display, press  .	<pre> LOC ↻ FAULT ——— FAULT 36 LOCAL CTRL LOSS RESET   EXIT </pre>













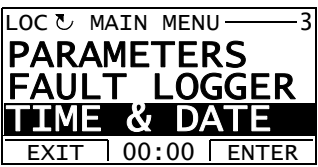



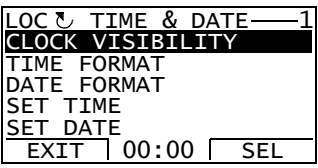









## Time & Date

In the Time & Date option, you can:







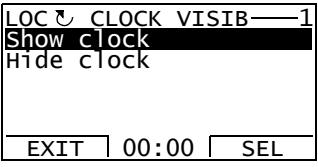
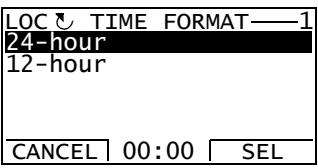
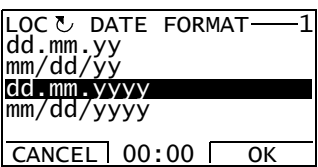
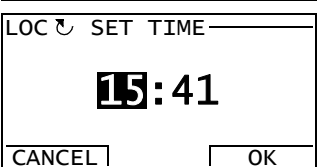









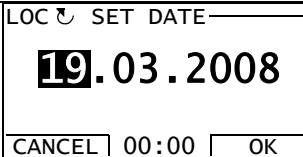



- show or hide the clock
- change date and time display formats
- set the date and time
- enable or disable automatic clock transitions according to the daylight saving changes
- start, stop, change the direction and switch between local and remote control.

The ACSM1 Control Panel contains a battery to ensure the function of the clock when the panel is not powered by the drive.

### How to show or hide the clock, change display formats, set the date and time and enable or disable clock transitions according to the daylight saving changes

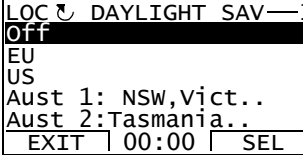
Step	Action	Display
1.	Go to the Main menu by pressing  if you are in the Output mode, otherwise by pressing  repeatedly until you get to the Main menu.	
2.	Go to the Time & Date option by selecting TIME & DATE on the menu with keys  and  , and pressing  .	
3.	<ul style="list-style-type: none"> <li>• To show (hide) the clock, select CLOCK VISIBILITY on the menu, press , select Show clock (Hide clock) with keys  and  and press , or, if you want to return to the previous display without making changes, press .</li> <li>• To specify the time format, select TIME FORMAT on the menu, press , and select a suitable format with keys  and . Press  to save or  to cancel your changes.</li> <li>• To specify the date format, select DATE FORMAT on the menu, press , and select a suitable format. Press  to save or  to cancel your changes.</li> <li>• To set the time, select SET TIME on the menu and press . Specify the hours with keys  and , and press . Then specify the minutes. Press  to save or  to cancel your changes.</li> </ul>	   

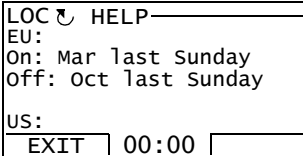

Step	Action	Display
	<ul style="list-style-type: none"> <li>To set the date, select SET DATE on the menu and press . Specify the first part of the date (day or month depending on the selected date format) with keys  and , and press . Repeat for the second part. After specifying the year, press . To cancel your changes, press .</li> </ul>	 <p>LOC  SET DATE—</p> <p><b>19.03.2008</b></p> <p>CANCEL 00:00 OK</p>
	<ul style="list-style-type: none"> <li>To enable or disable the automatic clock transitions according to the daylight saving changes, select DAYLIGHT SAVING on the menu and press . Pressing  opens the help that shows the beginning and end dates of the period during which daylight saving time is used in each country or area whose daylight saving changes you can select to be followed. Scroll the text with keys  and . To return to the previous display, press .</li> <li>To disable automatic clock transitions according to the daylight saving changes, select Off and press .</li> <li>To enable automatic clock transitions, select the country or area whose daylight saving changes are followed and press .</li> <li>To return to the previous display without making changes, press .</li> </ul>	 <p>LOC  DAYLIGHT SAV—1</p> <p><b>Off</b></p> <p>EU</p> <p>US</p> <p>Aust 1: NSW,Vict..</p> <p>Aust 2:Tasmania..</p> <p>EXIT 00:00 SEL</p>  <p>LOC  HELP—</p> <p>EU:</p> <p>On: Mar last Sunday</p> <p>Off: Oct last Sunday</p> <p>US:</p> <p>EXIT 00:00</p>

## Parameter Backup

The Parameter Backup option is used to export parameters from one drive to another or to make a backup of the drive parameters. Uploading stores all drive parameters, including up to four user sets, to the control panel. Selectable subsets of the backup file can then be restored/downloaded from the control panel to the same drive or another drive of the same type (e.g. ACSM1 Motion -> ACSM1 Motion and ACSM1 Speed -> ACSM1 Speed).

In the Parameter Backup option, you can:

- Copy all parameters from the drive to the control panel with MAKE BACKUP TO PANEL. This includes all defined user sets of parameters and internal (not adjustable by the user) parameters such as those changed by the ID Run.
- View the information about the backup stored in the control panel with SHOW BACKUP INFO. This includes e.g. version information etc. of the current backup file in the panel. It is useful to check this information when you are going to restore the parameters to another drive with RESTORE PARS ALL to ensure that the drives are compatible.
- Restore the full parameter set from the control panel to the drive using the RESTORE PARS ALL command. This writes all parameters, including the internal non-user-adjustable motor parameters, to the drive. It does NOT include the user sets of parameters.

---

















**Note:** Use this function only to restore the parameters from a backup or to restore parameters to systems that are compatible.

---

- Restore all parameters, except motor data, to the drive with RESTORE PARS NO-IDRUN.
- Restore only motor data parameters to the drive with RESTORE PARS IDRUN.
- Restore all user sets to the drive with RESTORE ALL USER SETS.
- Restore only user set 1...4 to the drive with RESTORE USER SET 1...RESTORE USER SET 4.

## How to backup and restore parameters





For all backup and restore functions available, see page 34.

Step	Action	Display
1.	Go to the Main menu by pressing  if you are in the Output mode, otherwise by pressing  repeatedly until you get to the Main menu.	<pre> LOC ↺ MAIN MENU 4 <b>FAULT LOGGER</b> <b>TIME &amp; DATE</b> <b>PAR BACKUP</b> EXIT   00:00   ENTER </pre>
2.	Go to the Parameter Backup option by selecting PAR BACKUP on the menu with keys  and  , and pressing  .	<pre> LOC ↺ PAR BACKUP 1 <b>MAKE BACKUP TO PANEL</b> SHOW BACKUP INFO RESTORE PARS ALL RESTORE PARS NO-IDRUN RESTORE PARS IDRUN EXIT   00:00   SEL </pre>
	<ul style="list-style-type: none"> <li>To copy all parameters (including user sets and internal parameters) from the drive to the control panel, select MAKE BACKUP TO PANEL on the Par Backup with keys  and , and press . Operation starts. Press  if you want to stop the operation.</li> </ul> <p>After the backup is completed, the display shows a message about the completion. Press  to return to the Par Backup.</p>	<pre> LOC ↺ PAR BACKUP Copying file 1/2 ABORT   00:00    LOC ↺ MESSAGE Parameter upload successful OK   00:00   </pre>
	<ul style="list-style-type: none"> <li>To perform restore functions, select the appropriate operation (here RESTORE PARS ALL is used as an example) on the Par Backup with keys  and .</li> <li>Press . Restoring starts.</li> <li>Backup interface version is checked. Scroll the text with keys  and .</li> <li>If you want to continue, press . Press  if you want to stop the operation. If the downloading is continued, the display shows a message about it.</li> <li>Downloading continues, drive is being restarted.</li> </ul>	<pre> LOC ↺ PAR BACKUP 3 MAKE BACKUP TO PANEL SHOW BACKUP INFO <b>RESTORE PARS ALL</b> RESTORE PARS NO-IDRUN RESTORE PARS IDRUN EXIT   00:00   SEL  LOC ↺ PAR BACKUP Initializing param. restore operation   00:00    LOC ↺ VERSION CHECK -1 BACKUP INTERFACE VER 0.2 0.2 OK FIRMWARE VERSION CANCEL   00:00   CONT  LOC ↺ PAR BACKUP Initializing param. restore operation   00:00    LOC ↺ PAR BACKUP Restarting drive   00:00   </pre>

Step	Action	Display
	<ul style="list-style-type: none"> <li>The display shows the transfer status as a percentage of completion.</li> <li>Downloading finishes.</li> </ul>	<div style="border: 1px solid black; padding: 2px;">                     LOC ↺ PAR BACKUP —                      Restoring/downloading                      all parameters   </div> <div style="border: 1px solid black; padding: 2px; margin-top: 5px;">                     LOC ↺ PAR BACKUP —                      Finishing restore                      operation                 </div>





*Trying to restore parameters between different product variants*





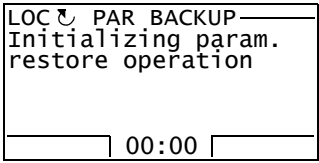

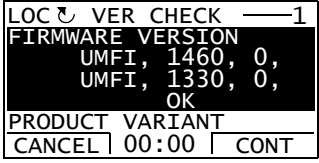
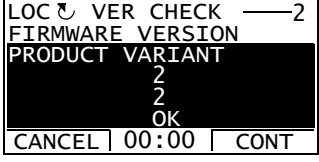
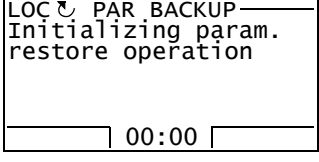
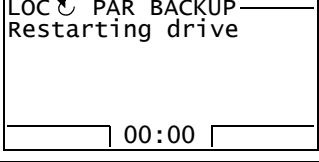
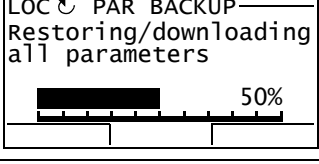
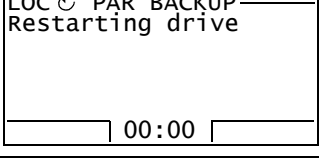
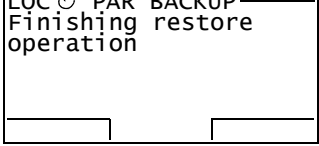

If you try to backup and restore parameters between different product variants (ACSM1 Speed and ACSM1 Motion), the panel shows you the following information about incompatible versions:

Step	Action	Display
1.	Restore operation starts normally.	<div style="border: 1px solid black; padding: 2px;">                     LOC ↺ PAR BACKUP —                      Initializing param.                      restore operation                        00:00                 </div>
2.	The panel shows a message about the version check failure. Continue by pressing  .	<div style="border: 1px solid black; padding: 2px;">                     LOC ↺ MESSAGE —                      Version check failed                        OK 00:00                 </div>
3.	The panel shows details about the version check. For details of the information fields shown on the control panel, see section <a href="#">How to view information about the backup</a> on page 41. You can scroll the information with keys  and  .	<div style="border: 1px solid black; padding: 2px;">                     LOC ↺ VER CHECK —1                      FIRMWARE VERSION                      UMFI, 1330, 0,                      UMFI, 1460, 0,                      OK                      PRODUCT VARIANT                      CANCEL 00:00                 </div>
4.	Press  to return to the Par Backup.	<div style="border: 1px solid black; padding: 2px;">                     LOC ↺ VER CHECK —2                      FIRMWARE VERSION                      PRODUCT VARIANT                      2                      1                      INCOMPATIBLE VERSION                      CANCEL 00:00                 </div>

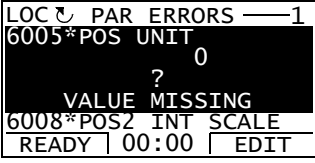
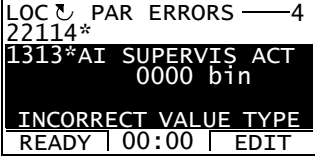
### Parameter errors

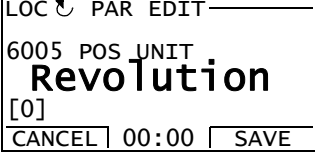

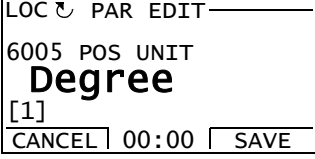
If you try to backup and restore parameters between different firmware versions, the panel shows you the following parameter error information:

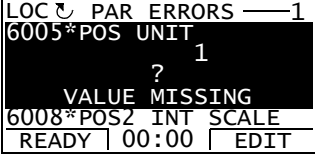
Step	Action	Display
1.	Restore operation starts normally.	
2.	Firmware version is checked. You can see on the panel that the firmware versions are not the same.  Scroll the text with keys  and  . To continue, press  . Press  to stop the operation.	 
3.	<ul style="list-style-type: none"> <li>If the downloading is continued, the display shows a message about it.</li> </ul>	
	<ul style="list-style-type: none"> <li>Downloading continues, drive is being restarted.</li> </ul>	
	<ul style="list-style-type: none"> <li>The display shows the transfer status as a percentage of completion.</li> </ul>	
	<ul style="list-style-type: none"> <li>Downloading continues.</li> </ul>	
	<ul style="list-style-type: none"> <li>Downloading finishes.</li> </ul>	

Step	Action	Display
4.	The panel shows a list of erroneous parameters.  You can scroll the parameters with keys  and  . The reason for parameter error is also shown.	 
5.	You can edit parameters by pressing  when EDIT command is visible. Parameter 60.05 POS UNIT is used as an example.  Edit the parameter as shown in section <a href="#">Parameters</a> on page 24.	
6.	Press  to save the new value.  Press  to return to the list of erroneous parameters.	
7.	The parameter value you chose is visible under the parameter name.  Press  when you have edited parameters.	

### Trying to restore a user set between different firmware versions

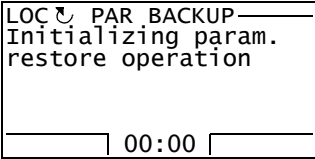

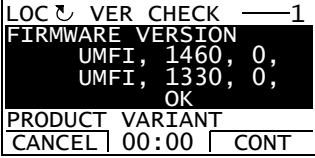
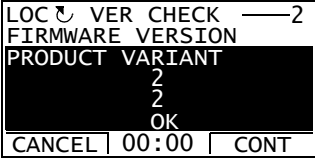

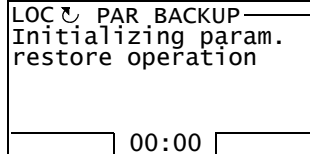
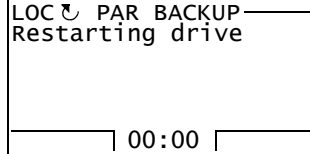
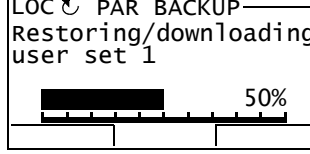
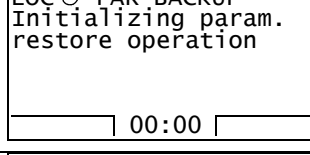
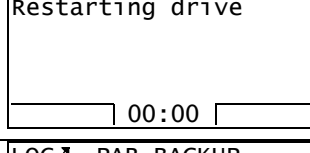
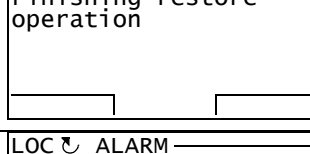
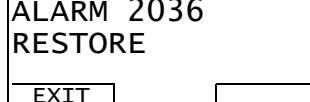



If you try to backup and restore a user set between different firmware versions, the panel shows you the following alarm information:

Step	Action	Display
1.	Restore operation starts normally.	
2.	Version check is also OK.  You can see on the panel that the firmware versions are not the same.  You can scroll the text with keys  and  .	 

Step	Action	Display
3.	• If the downloading is continued, the display shows a message about it.	
4.	• Downloading continues, drive is being restarted.	
5.	• The display shows the transfer status as a percentage of completion.	
6.	• Downloading continues.	
7.	• Downloading continues, drive is being restarted.	
8.	• Downloading finishes.	
9.	Panel shows a text identifying the alarm and returns to the Par Backup.	











*Trying to load a user set between different firmware versions*

If you try load a user set between different firmware versions, the panel shows you the following fault information:

Step	Action	Display
1.	Go to the Parameters option by selecting PARAMETERS on the main menu as shown in section <i>Parameters</i> on page 24. A user set is loaded through parameter 16.09 USER SET SEL. Select parameter group 16 SYSTEM with keys  and  .	<pre> LOC ↻ PAR GROUPS—16 11 START/STOP MODE 12 DIGITAL IO 13 ANALOGUE INPUTS 15 ANALOGUE OUTPUTS 16 SYSTEM EXIT   00:00   SEL                     </pre>
2.	Press  to select the parameter group 16. Select parameter 16.09 USER SET SEL with keys  and  . Current value of each parameter is shown below its name.	<pre> LOC ↻ PARAMETERS— 1603 PASS CODE 1604 PARAM RESTORE 1607 PARAM SAVE 1609 USER SET SEL       No request EXIT   00:00   EDIT                     </pre>
3.	Press  .  Select the user set you want to load with keys  and  .  Press  .	<pre> LOC ↻ PAR EDIT— 1609 USER SET SEL       No request [1] CANCEL   00:00   SAVE                     </pre> <pre> LOC ↻ PAR EDIT— 1609 USER SET SEL       Load set 1 [2] CANCEL   00:00   SAVE                     </pre>
4.	Panel shows a text identifying the fault.	<pre> LOC ↻ FAULT— FAULT 310 USERSET LOAD RESET              EXIT                     </pre>



### How to view information about the backup

Step	Action	Display
1.	Go to the Main menu by pressing  if you are in the Output mode, otherwise by pressing  repeatedly until you get to the Main menu.	<pre> LOC ↻ MAIN MENU —4 <b>FAULT LOGGER</b> <b>TIME &amp; DATE</b> <b>PAR BACKUP</b> EXIT   00:00   ENTER </pre>
2.	Go to the Par Backup option by selecting PAR BACKUP on the menu with keys  and  , and pressing  .	<pre> LOC ↻ PAR BACKUP —2 MAKE BACKUP TO PANEL <b>SHOW BACKUP INFO</b> RESTORE PARS ALL RESTORE PARS NO-IDRUN RESTORE PARS IDRUN EXIT   00:00   SEL </pre>
3.	Select SHOW BACKUP INFO on the Par Backup with keys  and  , and press  . The display shows the following information about the drive from where the backup was made:  BACKUP INTERFACE VER: Format version of the backup file FIRMWARE VERSION: Information on the firmware UMFI: Firmware of the ACSM1 drive 1330: Firmware version (e.g. 1.330) 0: Firmware patch version PRODUCT VARIANT: 1: ACSM1 Speed 2: ACSM1 Motion  You can scroll the information with keys  and  .	<pre> LOC ↻ BACKUP INFO — BACKUP INTERFACE VER 0.2 0.2 FIRMWARE VERSION UMFI, 1330, 0, EXIT   00:00   </pre> <pre> LOC ↻ BACKUP INFO — FIRMWARE VERSION UMFI, 1330, 0, UMFI, 1330, 0, PRODUCT VARIANT 2 EXIT   00:00   </pre>
4.	Press  to return to the Par Backup.	<pre> LOC ↻ PAR BACKUP —1 <b>MAKE BACKUP TO PANEL</b> SHOW BACKUP INFO RESTORE PARS ALL RESTORE PARS NO-IDRUN RESTORE PARS IDRUN EXIT   00:00   SEL </pre>

## Reference Edit

In the Reference Edit option, you can:

- accurately control the local reference value,
- start, stop, change the direction and switch between local and remote control.

Editing is allowed only in the LOC state, the option always edits the local reference value.

### How to edit reference value









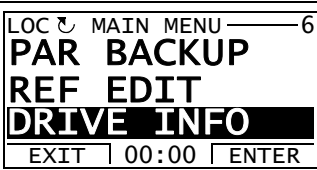

Step	Action	Display
1.	If the panel is in the remote control mode (REM shown on the status line), switch to local control (LOC shown on the status line) by pressing . Reference editing is not possible in remote control mode. The display shows a message about that, if you try to enter REF EDIT in the remote control mode.	
2.	Otherwise, go to the Main menu by pressing  if you are in the Output mode, otherwise by pressing  repeatedly until you get to the Main menu.	
3.	Go to the Reference Edit option by selecting REF EDIT on the menu with keys  and , and pressing .	
4.	Select the correct sign with keys  and , and press . Select the correct numbers with keys  and , and after each number is selected, press . If you do not select a number for a couple of seconds, the number you are editing moves on to the next one on the right.	
5.	After the last number is selected, press . Go to the Output mode by pressing . The selected reference value is shown in the status line.	

## Drive Info

In the Drive Info option, you can:

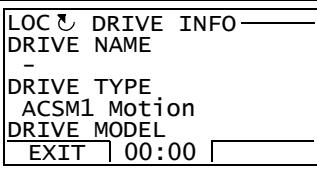
- view information on the drive,
- start, stop, change the direction and switch between local and remote control.

### How to view drive info

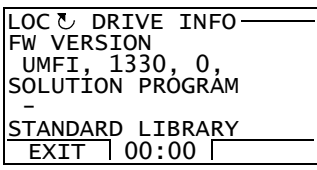
Step	Action	Display
1.	Go to the Main menu by pressing  if you are in the Output mode, otherwise by pressing  repeatedly until you get to the Main menu.	 <pre> LOC  MAIN MENU 6 PAR BACKUP REF EDIT DRIVE INFO EXIT 00:00 ENTER </pre>
2.	Go to the Drive info option by selecting DRIVE INFO on the menu with keys  and  , and pressing  .	 <pre> LOC  DRIVE INFO DRIVE NAME - DRIVE TYPE ACSM1 Motion DRIVE MODEL EXIT 00:00 </pre>
3.	<p>The display shows information about the drive. You can scroll the information with keys  and . <b>Note:</b> The information shown may vary according to the firmware version of the drive.</p> <p>DRIVE NAME: Drive name defined as a text in DriveStudio commissioning and maintenance tool</p> <p>DRIVE TYPE: Product variant, e.g. ACSM1 Speed or ACSM1 Motion</p> <p>DRIVE MODEL: Type code of the drive</p> <p>FW VERSION: See page 41.</p> <p>SOLUTION PROGRAM: Information on the active solution program</p> <p>STANDARD LIBRARY: Version information of the standard library in the firmware</p> <p>TECHNOLOGY LIBRARY: Optional. Version information of the technology library</p> <p>POWER UNIT SERNO: Serial number of the power stage (JPU)</p> <p>MEM UNIT HW SERNO: Serial number in manufacturing the memory unit (JMU)</p> <p>MEM UNIT CONFIG SERNO: Serial number in configuring the memory unit (JMU).</p> <p>Press  to return to the Main menu.</p>	 <pre> LOC  DRIVE INFO FW VERSION UMFI, 1330, 0, SOLUTION PROGRAM - STANDARD LIBRARY EXIT 00:00 </pre>







---

**ABB Oy**  
AC Drives  
P.O. Box 184  
FI-00381 HELSINKI  
FINLAND  
Telephone +358 10 22 11  
Fax +358 10 22 22681  
Internet [www.abb.com](http://www.abb.com)

3AUA000020131 Rev B / EN  
EFFECTIVE: 2009-08-12