

Low voltage AC drives

Solar pump drives
0.37 to 45 kW

Solar pump drive

Harnessing sun's energy to maximize pump delivery

Built-in MPPT

Maximum power point tracking functionality ensures that you get the most power output possible from your solar panel and maximizes the performance of your pump throughout the day.

Remote monitoring

With the addition of optional modules you can monitor and configure drive and application parameters from anywhere via Modbus RTU, Modbus TCP, Profinet and Ethernet IP protocols.

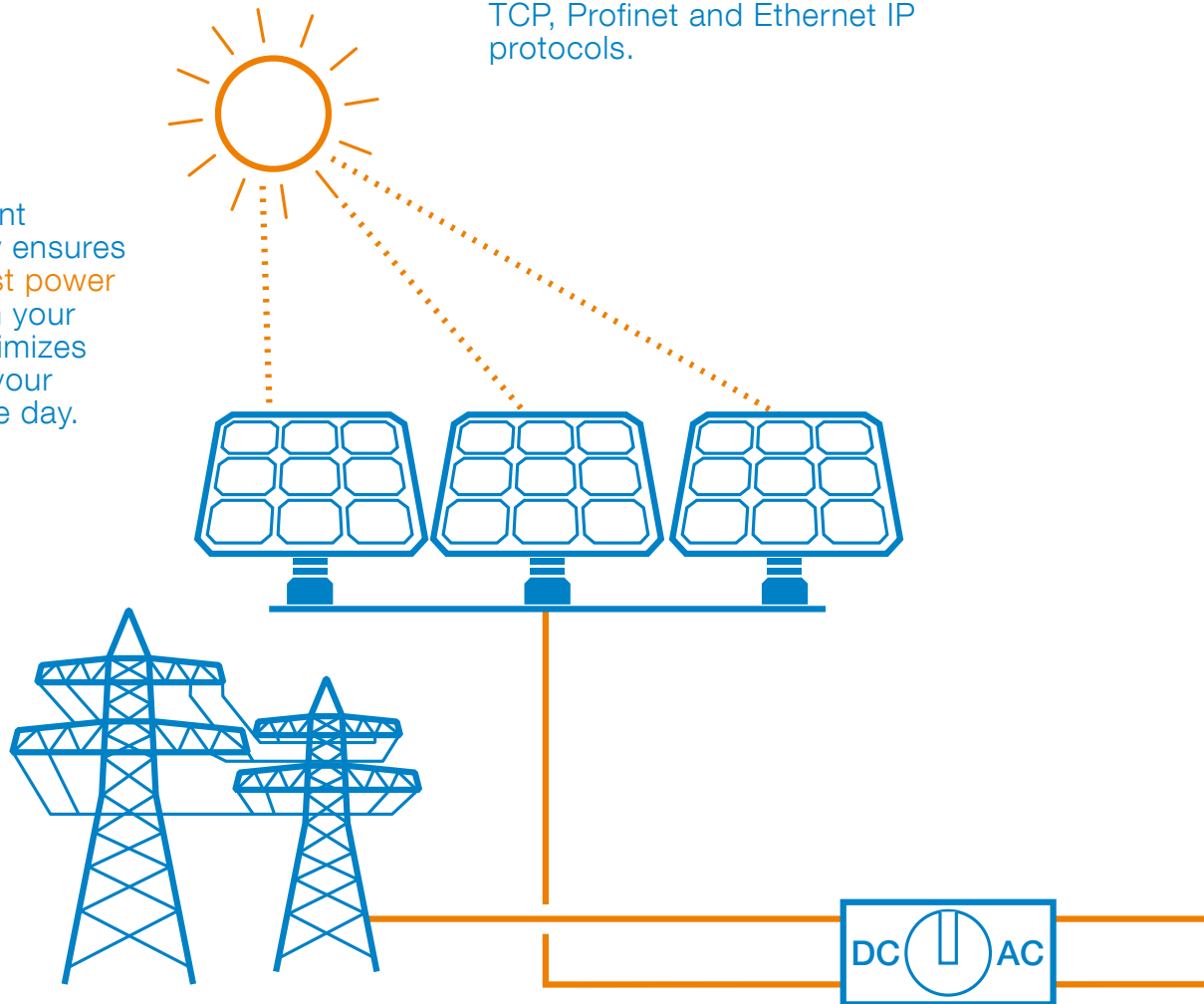
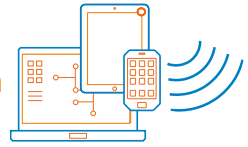

Best off-grid solution

Where electricity is very erratic and unpredictable, farmers need not to depend on grid electricity for their agricultural requirements.

Advanced control panel

The multilingual assistant control panel ensures easy drive programming. Real-time clock enables accurate fault logging and automatic start and stop of the drive when there is enough power available.

Multiple pump motors with a single drive control

Standard asynchronous motors as well as more efficient permanent magnet motors.

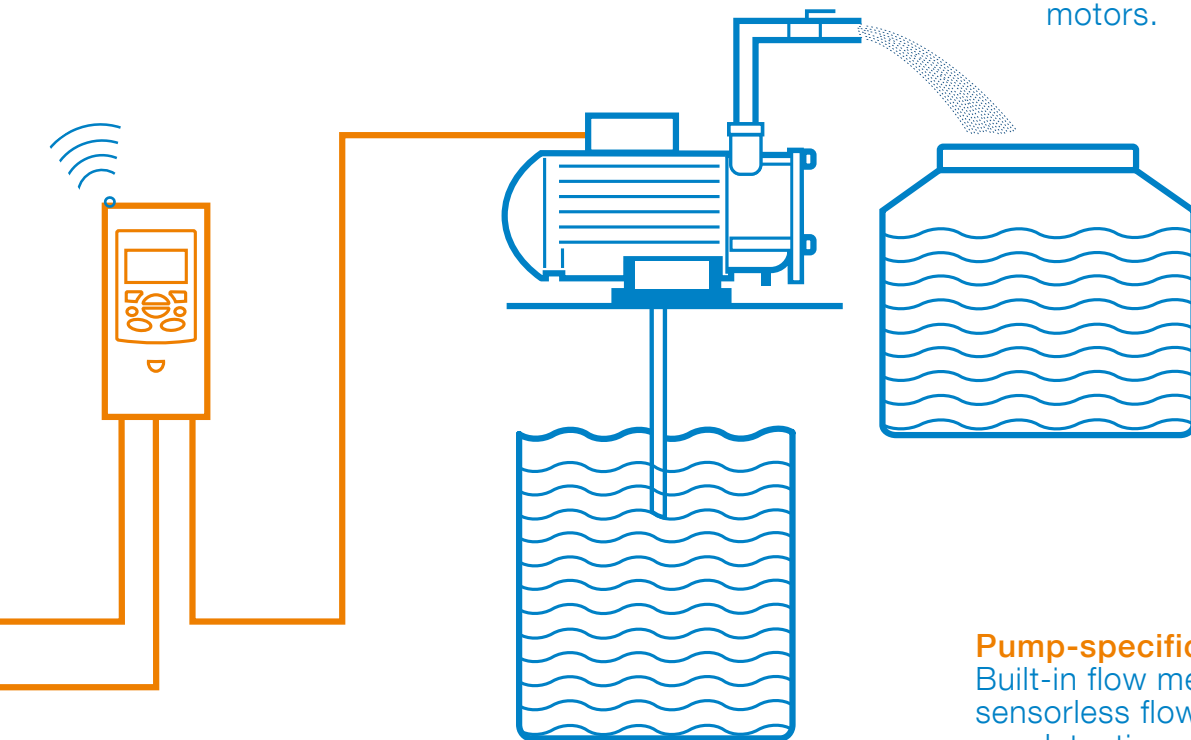

Pump-specific protection

Built-in flow measurement and sensorless flow calculation. Dry run detection can be configured to pause the pumping to protect the pump. Pump cleaning in reversing method can be programmed to maximize the pump operation.



Low-carbon economy

With utilization of solar power, ABB drives help in reducing your carbon footprint. The installed base of ABB's variable speed drives saved about 445 TWh in 2014 and reduced CO₂ emissions by 370 million tons.

Environmentally friendly off-grid solution

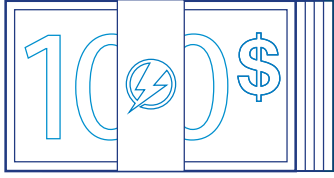

Save in energy costs and maximize productivity
ABB solar pump drives ensure reliable power supply throughout the day with on and off-grid compatibility



Reduce maintenance costs
The drives can be equipped with remote monitoring options, reducing maintenance trips to the site



Save environment
Harnessing the power of sun provides an environmentally friendly pumping without producing any CO₂ emissions

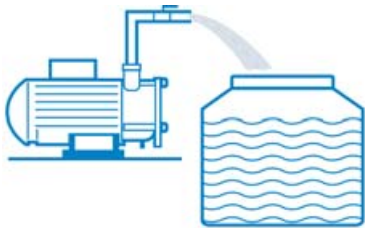

Reduce operational risk
Embedded pump-specific features such as dry run detection and pump cleaning in reversing method protect the pump

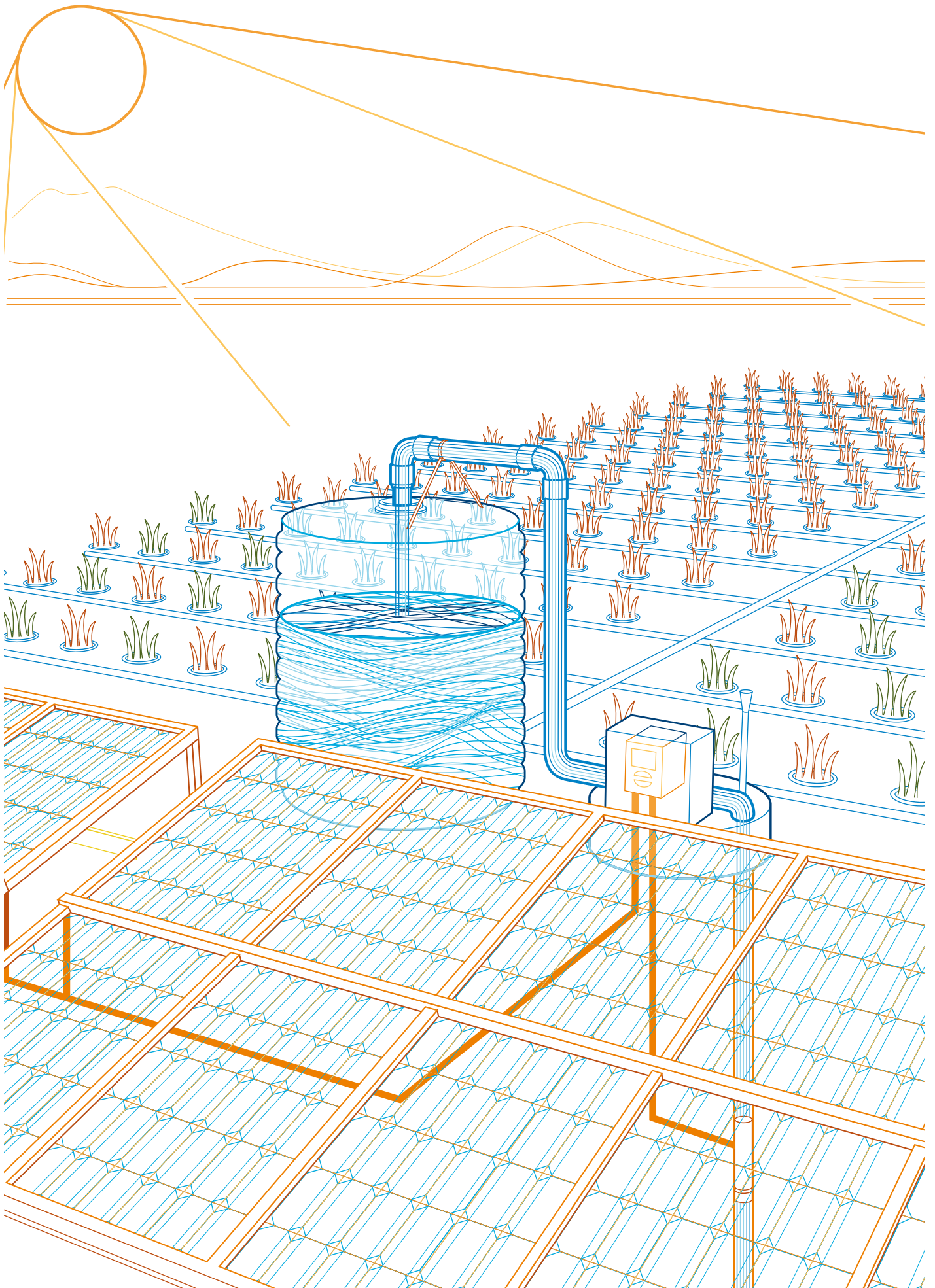

Selection and ordering

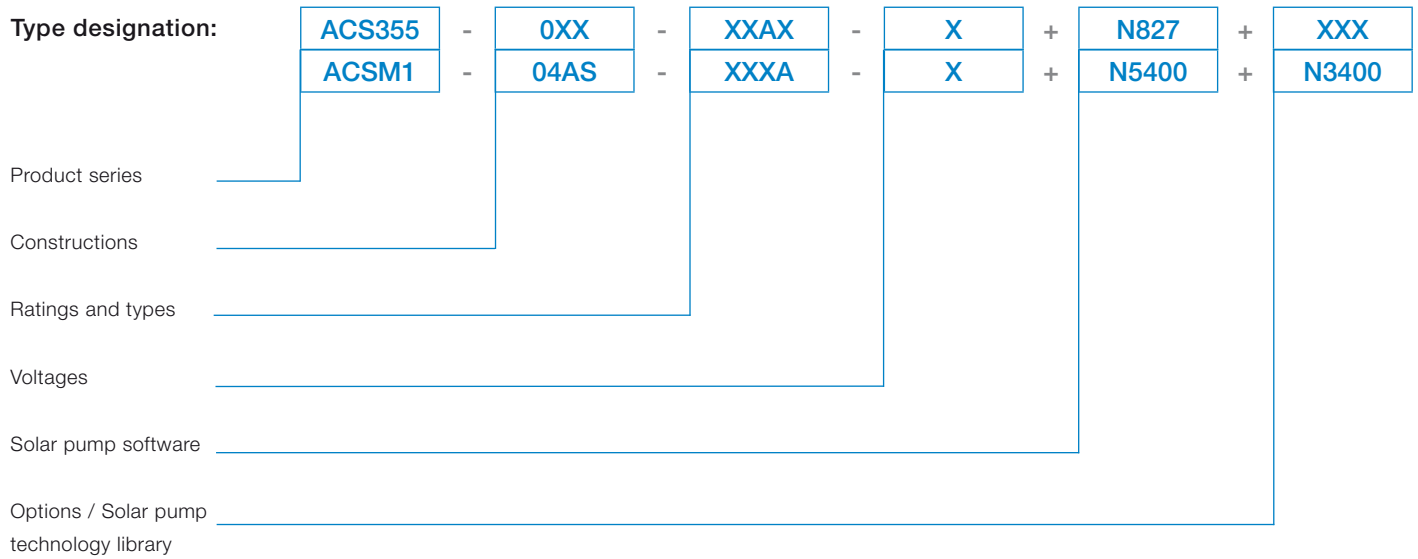

Type designation code

This is the unique reference number to identify your drive by power rating and frame size and can be used to determine the drive dimensions.

Voltages

The ACS355 is available in two voltage ranges:

2 = 125 to 400 V DC or 200 to 240 V AC
 4 = 250 to 800 V DC or 380 to 480 V AC

ACSM1 available in one voltage:

4 = 270 to 800 V DC or 380 to 480 V AC

Insert either “2” or “4”, depending upon your chosen voltage, into the type code shown.

Construction

“01E” within the type code varies depending upon on the drive phase and EMC filtering. Choose one from options on the next page

ACS355 0.37 to 18.5 kW

01 = 1-phase
 03 = 3-phase
 E = EMC filter connected, 50 Hz

ACSM1 5.5 to 45 kW

04 = 3-phase

Product compliance

- UL, cUL, CE, C-Tick and GOST R approvals
- Low Voltage Directive 73/23/EEC with supplements
- EMC Directive 89/336/EEC with supplements
- Quality assurance system ISO 9001
- Environmental system ISO 14001
- RoHS compliant

Ratings, types and voltages

ACS355	-	0XX	-	XXAX	-	X	+	N827	+	XXX
ACSM1	-	04AS	-	XXXXA	-	X	+	N5400	+	N3400

Ratings for ACS355 IP20			Type designation	Frame size
P_N kW	P_N hp	I_{2N} A		

1-phase AC supply, 125 to 400 V DC or 200 to 240 V AC

0.37	0.5	4.7	ACS355-01E-04A7-2	R1
0.75	1.0	6.7	ACS355-01E-06A7-2	R1
1.1	1.5	7.5	ACS355-01E-07A5-2	R2
1.5	2.0	9.8	ACS355-01E-09A8-2	R2

3-phase AC supply, 125 to 400 V DC or 200 to 240 V AC

0.37	0.5	3.5	ACS355-03E-03A5-2	R0
0.55	0.75	4.7	ACS355-03E-04A7-2	R1
0.75	1.0	6.7	ACS355-03E-06A7-2	R1
1.0	1.5	7.5	ACS355-03E-07A5-2	R1
1.5	2.0	9.8	ACS355-03E-09A8-2	R2
2.2	3.0	13.3	ACS355-03E-13A3-2	R2
3.0	4.0	17.6	ACS355-03E-17A6-2	R2
4.0	5.0	24.4	ACS355-03E-24A4-2	R3
5.5	7.5	31.0	ACS355-03E-31A0-2	R4
7.5	10.0	46.2	ACS355-03X-46A2-2	R4

3-phase AC supply, 250 to 800 V DC or 380 to 480 V AC

0.37	0.5	1.9	ACS355-03E-01A9-4	R0
0.55	0.75	2.4	ACS355-03E-02A4-4	R1
0.75	1.0	3.3	ACS355-03E-03A3-4	R1
1.1	1.5	4.1	ACS355-03E-04A1-4	R1
1.5	2.0	5.6	ACS355-03E-05A6-4	R1
2.2	3.0	7.3	ACS355-03E-07A3-4	R1
3.0	4.0	8.8	ACS355-03E-08A8-4	R1
4.0	5.0	12.5	ACS355-03E-12A5-4	R3
5.5	7.5	15.6	ACS355-03E-15A6-4	R3
7.5	10.0	23.1	ACS355-03E-23A1-4	R3
11.0	15.0	31.0	ACS355-03E-31A0-4	R4
15.0	20.0	38.0	ACS355-03E-38A0-4	R4
18.5	25.0	44.0	ACS355-03E-44A0-4	R4

Ratings for ACSM1 IP20			Type designation	Frame size
P_N kW	P_N hp	I_{2N} A		

3-phase AC supply, 270 to 800 V DC or 380 to 480 V AC

5.5	7.5	14	ACSM1-04AS-012A-4	B
7.5	10	18	ACSM1-04AS-016A-4	B
11	15	27	ACSM1-04AS-024A-4	C
15	20	35	ACSM1-04AS-031A-4	C
18.5	25	44	ACSM1-04AS-040A-4	C
22	30	50	ACSM1-04AS-046A-4	C
30	40	65	ACSM1-04AS-060A-4	D
37	50	80	ACSM1-04AS-073A-4	D
45	60	93	ACSM1-04AS-090A-4	D

Dimensions

Dimensioning

All solar pump drives are IP20 modules that need to be installed in an enclosure withstanding the local weather conditions.

ACS355 Cabinet-mounted drives (IP20/UL Open type)

Frame size	IP20 / UL open					
	H1 mm	H2 mm	H3 mm	W mm	D mm	Weight kg
R0	169	202	239	70	161	1.2
R1	169	202	239	70	161	1.2
R2	169	202	239	105	165	1.5
R3	169	202	236	169	169	2.5
R4	181	202	244	260	169	4.4

H1 = Height without fastenings and clamping plate
 H2 = Height with fastenings but without clamping plate
 H3 = Height with fastenings and clamping plate
 W = Width
 D1 = Standard depth

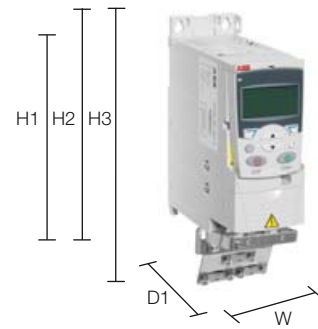

ACSM1 Cabinet-mounted drives (IP20/UL Open type)

Frame size	IP20 / UL open			Weight kg
	H mm	W mm	D mm	
B	380	100	223	5
C	467	165	225	10
D	467	220	225	17

Connection representation

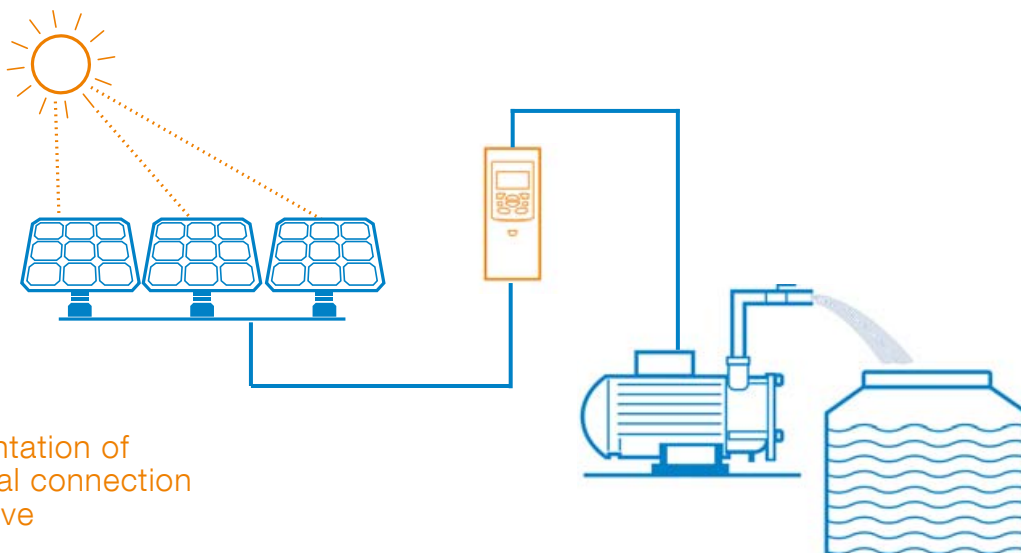

Representation of the typical connection of the drive

Cooling

Cooling

The ACS355 and ACSM1 drives are fitted with cooling fans as standard. The cooling air must be free from corrosive substances.

ACS355 and ACSM1 are drive modules that need to be built into a cabinet or electrical panel. Following typical heat dissipation values (peak losses at rated power) can be used to design the cabinet cooling. More accurate design values can be found from the respective user's manual.

Cooling air flow

Type designation	Frame size	Heat dissipation	Air flow
		[W]	m ³ /h
1-phase AC supply, 125 to 400 V DC or 200 to 240 V AC			
ACS355-01E-04A7-2	R1	72	24
ACS355-01E-06A7-2	R1	97	24
ACS355-01E-07A5-2	R2	101	21
ACS355-01E-09A8-2	R2	124	21
3-phase AC supply, 125 to 400 V DC or 200 to 240 V AC			
ACS355-03E-03A5-2	R0	54	– ¹⁾
ACS355-03E-04A7-2	R1	64	24
ACS355-03E-06A7-2	R1	86	24
ACS355-03E-07A5-2	R1	88	21
ACS355-03E-09A8-2	R2	111	21
ACS355-03E-13A3-2	R2	140	52
ACS355-03E-17A6-2	R2	180	52
ACS355-03E-24A4-2	R3	285	71
ACS355-03E-31A0-2	R4	328	96
ACS355-03E-46A2-2	R4	488	96
3-phase AC supply, 250 to 800 V DC or 380 to 480 V AC			
ACS355-03E-01A9-4	R0	40	– ¹⁾
ACS355-03E-02A4-4	R1	50	13
ACS355-03E-03A3-4	R1	60	13
ACS355-03E-04A1-4	R1	69	13
ACS355-03E-05A6-4	R1	90	19
ACS355-03E-07A3-4	R1	107	24
ACS355-03E-08A8-4	R1	127	24
ACS355-03E-12A5-4	R3	161	52
ACS355-03E-15A6-4	R3	204	52
ACS355-03E-23A1-4	R3	301	71
ACS355-03E-31A0-4	R4	408	96
ACS355-03E-38A0-4	R4	498	96
ACS355-03E-44A0-4	R4	588	96

¹⁾ Frame size R0 with free convection cooling

Cooling air flow

Type designation	Frame size	Heat dissipation	Air flow
		[W]	m ³ /h
3-phase AC supply, 270 to 800 V DC or 380 to 480 V AC			
ACSM1-04AS-012A-4	B	250	48
ACSM1-04AS-016A-4	B	318	48
ACSM1-04AS-024A-4	C	375	142
ACSM1-04AS-031A-4	C	485	142
ACSM1-04AS-040A-4	C	541	200
ACSM1-04AS-046A-4	C	646	200
ACSM1-04AS-060A-4	D	840	290
ACSM1-04AS-073A-4	D	1020	290
ACSM1-04AS-090A-4	D	1200	290

Free space requirements

Inside the cabinet following free space distances need to be met to ensure correct heat exchange.

Enclosure type	Space above	Space below	Space on left/right
	mm	mm	mm
ACS355 frames R0 to R4	75	75	0
ACSM1 frames B to D	200	300	0

Fuses

Fuses

Use standard fuses with ABB solar pump drives.

Each parallel string connected to ABB solar pump drives should be protected by the gPV fuses to prevent damage to the solar panels and to the panel cabling. Fuses should be dimensioned according to the panel manufacturer recommendations.

Standard DC fuses can be used in solar pump drive input to prevent excess damage in case of the drive internal short circuit. For DC side fuse connection see the table below.

With UR fuses, determine the rating by the maximum instantaneous DC current because fuses work rapidly. In practice, select fuses that are about twice the DC current calculated

from the solar pump drive rated power. With gG fuses take one size smaller rating.

An optional AC side gG fuse is mention if drive is operated from the grid instead of PV cells.

For input fuse connections in DC side UR or gG, see the table below. It is recommended to use ABB E90 PV fuse disconnectors in solar pumping applications.

With UR fuses, determine the rating by the maximum instantaneous DC current because fuses work quickly. In practice, select fuses for a current about two times higher than the DC current calculated from the nominal power. With gG fuses, take a rating one size smaller. An optional AC side gG fuse is also mentioned if the drive is operating in grid mode.

Fuse selection table

Type description	Frame size	IEC fuses		DC fuse	
		AC side [A]		PV side [A]	
		Fuse type		Fuse type	
		gG		UR	gG
1-phase AC supply, 125 to 400 V DC or 200 to 240 V AC					
ACS355-01E-04A7-2	R1	16		10	10
ACS355-01E-06A7-2	R1	16		10	10
ACS355-01E-07A5-2	R2	20		16	10
ACS355-01E-09A8-2	R2	25		16	16
3-phase AC supply, 125 to 400 V DC or 200 to 240 V AC					
ACS355-03E-03A5-2	R0	10		10	10
ACS355-03E-04A7-2	R1	10		10	10
ACS355-03E-06A7-2	R1	16		10	10
ACS355-03E-07A5-2	R1	16		16	10
ACS355-03E-09A8-2	R2	16		16	16
ACS355-03E-13A3-2	R2	25		25	25
ACS355-03E-17A6-2	R2	25		35	25
ACS355-03E-24A4-2	R3	63		35	35
ACS355-03E-31A0-2	R4	80		50	50
ACS355-03E-46A2-2	R4	100		80	63
3-phase AC supply, 250 to 800 V DC or 380 to 480 V AC					
ACS355-03E-01A9-4	R0	10		10	10
ACS355-03E-02A4-4	R1	10		10	10
ACS355-03E-03A3-4	R1	10		10	10
ACS355-03E-04A1-4	R1	16		10	10
ACS355-03E-05A6-4	R1	16		10	10
ACS355-03E-07A3-4	R1	16		16	10
ACS355-03E-08A8-4	R1	20		25	16
ACS355-03E-12A5-4	R3	25		25	16
ACS355-03E-15A6-4	R3	35		35	25
ACS355-03E-23A1-4	R3	50		50	35
ACS355-03E-31A0-4	R4	80		63	50
ACS355-03E-38A0-4	R4	100		80	50
ACS355-03E-44A0-4	R4	100		80	63

Fuse selection table

Type description	Frame size	IEC fuses		DC fuse	
		AC side [A]		PV side [A]	
		Fuse type		Fuse type	
		gG		gG	gG
3-phase AC supply, 270 to 800 V DC or 380 to 480 V AC					
ACSM1-04AS-012A-4	B	20		32	
ACSM1-04AS-016A-4	B	25		32	
ACSM1-04AS-024A-4	C	25		63	
ACSM1-04AS-031A-4	C	32		63	
ACSM1-04AS-040A-4	C	40		100	
ACSM1-04AS-046A-4	C	50		100	
ACSM1-04AS-060A-4	D	63		100	
ACSM1-04AS-073A-4	D	80		160	
ACSM1-04AS-090A-4	D	100		160	

Options

Connectivity and remote monitoring

Connectivity options

In order to improve connectivity of the solar pump drives either to remote monitoring, or to most common data acquisition (SCADA) applications, a set of FENA ethernet adapters are available. Ethernet adapters can be configured for Modbus/TCP, EtherNet/IP™ and PROFINET IO protocols.

FMBA-01 adapter for ACS355 solar pump drive and FSCA-01 adapter for ACSM1 solar pump drive offer Modbus RTU connectivity for more cost efficient monitoring setups.

Also PROFIBUS adapter FPBA-01 is available for PLC connections.

Connectivity options

Ordering code	Description	Type designation
+K466/68469422	One port ethernet adapter for ACS355	FENA-01
+K473/3AUA0000089107	One port ethernet adapter	FENA-11
+K475/3AUA0000089109	Two port ethernet adapter	FENA-21
+K458/68469881	Modbus RTU adapter for ACS355	FMBA-01
+K458/3AUA0000031336	Modbus RTU adapter for ACSM1	FSCA-01
+K454/68469325	PROFIBUS adapter	FPBA-01

NETA-21 remote monitoring tool

The remote monitoring tool, NETA-21, gives easy access to the drive via the Internet or local Ethernet network. NETA-21 comes with a built-in web server. Compatible with standard web browsers, it ensures easy access to a web based user interface. Through the web interface, the user can configure drive parameters, monitor drive log data, load levels, run time, energy consumption, I/O data and bearing temperatures of the motor connected to the drive.

Remote monitoring options

Ordering code	Description	Type designation
3AUA0000094517	2 x panel bus interface, 2 x 32 = max. 64 drives 2 x Ethernet interface SD memory card USB port for WLAN/3G	NETA-21



Contact us

For more information please contact your local ABB representative or visit:

www.abb.com/drives

www.abb.com/drivespartners

© Copyright 2016 ABB. All rights reserved.
Specifications subject to change without notice.

3AUA0000158884 REV D EN 28.9.2016