

PowerValue 11 RT 6-10 kVA



About this manual

The UPS system operates with mains, battery or bypass power. It contains components that carry high currents and voltages. When installed correctly, the UPS system is grounded to earth and IP 20 rated against electrical shock and foreign objects.

This user manual contains guidelines to check delivery, install and commission the UPS and is intended for people who plan the installation, install, commission and use or service the UPS. The reader is expected to be familiar with the fundamentals of electricity, wiring, electrical components and electrical schematic symbols.











FOLLOW THE INSTRUCTIONS IN THIS MANUAL DURING INSTALLATION, OPERATION AND MAINTENANCE OF THE UPS AND BATTERIES.

FAILURE TO FOLLOW THE INSTRUCTIONS MAY LEAD TO THE PRODUCT LOSING ITS WARRANTY.

Read this manual before performing any operations and store it for future reference.

Symbols

The following symbols are used in this user manual.

WARNING	WARNING INDICATES THE PRESENCE OF A HAZARD WHICH COULD RESULT IN SEVERE INJURY AND/OR SERIOUS DAMAGE TO THE SYSTEM
CAUTION	CAUTION INDICATES THE PRESENCE OF A HAZARD WHICH COULD RESULT IN MINOR INJURY AND/OR DAMAGE TO THE PRODUCT.
NOTE	NOTE INDICATES THE PRESENCE OF A HAZARD WHICH COULD LEAD TO PROPERTY DAMAGE.
	SAFETY WARNING: THE SYMBOL IS USED TO ALERT THE USER TO WARNINGS, CAUTIONS AND NOTES.
	DANGER: THE SYMBOL IS USED TO ALERT THE USER TO THE OCCURRENCE OF ELECTRICAL LIVE PARTS WITH HAZARDOUS VOLTAGES.
	Protective grounding terminal: A terminal which must be connected to earth ground prior to making any other connections to the equipment.
	A terminal to which or from which an alternating current or voltage (AC) may be applied or supplied.
	A terminal to which or from which a direct current or voltage (DC) may be applied or supplied
	Battery
	Power On, Idle or shutdown the UPS
	Overload indication
	Recycle
	Do not dispose with ordinary trash

Contents

1	Safety instructions	5
1.1	Operator precautions	5
1.2	Environmental Considerations	5
1.5	Operation	6
1.3	Declaration of Safety conformity and CE marking	6
1.4	Inquiries	6
2	Maintenance	7
3	Installation	8
3.1	Delivery, transportation, positioning and storage	8
3.2	Site planning and positioning	8
3.3	General characteristics	12
3.4	Electrical installation	14
3.5	Initial startup	20
3.6	Emergency power off (EPO)	20
3.7	Paralleling the units	21
3.8	Installation Checklist	24
4	Operation	25
4.1	Control Panel	25
4.2	Operating Mode	26
4.3	UPS start-up and shutdown	28
4.4	Display operation	29
5	Communication	35
5.1	RS-232 port	35
5.2	USB port	35
5.3	Network management card (Optional)	36
6	Troubleshooting	37
6.1	Fault identification and rectification	37
6.2	Accessing Alarms	37
	Appendix A	41
	Appendix B	42
	Appendix C: External Battery Modules (EBM) value calculation	43

1 Safety instructions



1.1 Operator precautions



Always follow the precautions and instructions described in this manual. Any deviations from the instructions may result in electrical shock or cause accidental load loss.



Only the following user operations are permitted:

- Use of the LCD control panel (LCD Display) and Maintenance Bypass (if present)
- Start up and shut down of the UPS (excluding the commissioning start up)
- Operation of additional connectivity devices

ABB DOES NOT TAKE ANY RESPONSIBILITY FOR DAMAGES CAUSED THROUGH INCORRECT MANIPULATIONS OF THE UPS SYSTEM.

	DANGER	DO NOT REMOVE ANY SCREWS FROM THE UPS SYSTEM OR FROM THE BATTERY CABINET: DANGER OF ELECTRICAL SHOCK.
	WARNING	

	DANGER	HIGH FAULT CURRENTS (LEAKAGE CURRENTS). BEFORE CONNECTING THE MAINS ENSURE THAT THE UPS IS GROUND!
	WARNING	

	DANGER	DISPLAY A WARNING LABEL ON ALL PRIMARY POWER ISOLATORS INSTALLED REMOTE FROM THE UPS AREA TO WARN ELECTRICAL MAINTENANCE PERSONNELS THAT THE CIRCUIT FEEDS A UPS.
	WARNING	MAKE SURE THAT WARNING LABEL CONTAINS THE FOLLOWING TEXT OR EQUIVALENT: "ISOLATE THE UPS (UNINTERRUPTIBLE POWER SUPPLY) BEFORE WORKING ON THIS CIRCUIT."

1.2 Environmental Considerations

To operate the UPS with optimal efficiency, your installation site should meet the environmental parameters outlined in this user manual. Excessive amount of dust or moisture in the operating environment may cause damage or lead to malfunction. The UPS should always be protected from the weather and sunshine. The operating environment must meet the weight, airflow, size and clearance requirements specified in the technical datasheet.

Under no circumstances install the UPS in an airtight room, in the presence of flammable gases, or in an environment exceeding the environmental requirements specified below. An ambient temperature of +20°C to +25°C is recommended to achieve a long life of the UPS and batteries. The cooling air entering the UPS must not exceed +40 °C and the humidity should be below 95% (non-condensing).

1.3 Declaration of Safety conformity and CE marking

PowerValue 11 RT 6-10 kVA is designed, manufactured and commercialized in accordance with the standard **EN ISO 9001** of Quality Management Systems.

These products are in conformity with the directives:

- **2014/35/EU** Low voltage directive
- **2014/30/EU** Electromagnetic Compatibility directive (EMC)
- **2011/65/EU** Restriction of the use of certain hazardous substances (RoHS) directive



and with the following product standards:

	Product Standards
Safety	IEC/EN 62040-1:2008+A1:2013
EMC	IEC/EN 62040-2:2006
RoHS	IEC/EN50581:2012

Table 1: Standards

1.4 Inquiries

Address inquiries about the UPS to the local ABB office or agent authorized by ABB. Note the type code and the serial number of the equipment before contacting ABB or authorized agent. The serial number is shown in the nameplate of the product. For further information on troubleshooting, see Chapter 6.

1.5 Operation



CAUTION

DO NOT DISCONNECT THE MAINS CABLE FROM THE UPS OR THE BUILDING WIRING SOCKET DURING OPERATION AS THIS REMOVES THE GROUND FROM THE UPS AND ALL CONNECTED LOADS.



NOTE

PRESS THE OFF BUTTON TO FULLY DISCONNECT THE UPS. WAIT UNTIL THE UPS IS ON BYPASS OR ON STAND-BY MODE BEFORE DISCONNECTING IT FROM THE MAINS.



NOTE

TO REDUCE THE RISK OF FIRE, CONNECT THE UPS TO A CIRCUIT PROVIDED WITH BRANCH CIRCUIT OVERCURRENT PROTECTION WITH AN AMPERE RATING IN ACCORDANCE WITH THE IEC/EN 60934 STANDARD OR YOUR LOCAL ELECTRICAL CODE.

SEE TECHNICAL SPECIFICATIONS FOR RECOMMENDATIONS.



NOTE

INDISCRIMINATE OPERATION OF SWITCHES MAY CAUSE OUTPUT LOSS OR DAMAGE TO EQUIPMENT.

This UPS can be connected to a maximum of four external battery enclosures.



WARNING

NEVER DISPOSE BATTERIES ON FIRE AS THEY MAY EXPLODE.



WARNING

DO NOT OPEN OR MUTILATE THE BATTERIES.



WARNING

RELEASED ELECTROLYTE IS HARMFUL TO THE SKIN AND EYES.

2 Maintenance

PowerValue 11 RT 6-10 kVA UPS only requires minimal maintenance.

Charge the UPS regularly to maximize the expected life of the battery. When connected to the mains power, the UPS charges the batteries and prevents the batteries from overcharging and over-discharging.

- Replace the batteries when the battery service life has been exceeded (3~5 years at 25°C ambient temperature). Contact local ABB or an agent authorized by ABB.
- Charge the UPS once every 4 to 6 months if it has not been used for a long time.
- In high temperature regions, charge and discharge the battery every 2 months. The standard charging time should be of at least 12 hours.
- Replace the battery when the discharge time is less than 50% of specified after full charge. Check the battery connection or contact your local dealer to order a new battery.



DANGER

COMPONENTS INSIDE THE UPS ARE CONNECTED TO THE BATTERY EVEN WHEN THE UPS IS DISCONNECTED FROM THE MAINS POWER SUPPLY.



WARNING



DANGER

DISCONNECT THE BATTERIES BEFORE CARRYING OUT ANY KIND OF SERVICE AND/OR MAINTENANCE. VERIFY THAT NO CURRENT IS PRESENT AND NO HAZARDOUS VOLTAGE EXISTS IN THE CAPACITOR OR BUS CAPACITOR TERMINALS.



WARNING



DANGER

THE BATTERY CIRCUIT IS NOT ISOLATED FROM THE INPUT VOLTAGE. HAZARDOUS VOLTAGES MAY OCCUR BETWEEN THE BATTERY TERMINALS AND THE GROUND. VERIFY THAT NO VOLTAGE IS PRESENT BEFORE SERVICING.



WARNING



DANGER



WARNING

A BATTERY CAN PRESENT A RISK OF ELECTRICAL SHOCK AND HIGH SHORT CIRCUIT CURRENT. THE FOLLOWING PRECAUTIONS SHOULD BE OBSERVED WHEN WORKING ON BATTERIES:

- REMOVE WATCHES, RINGS OR OTHER METAL OBJECTS
- MAKE USE OF PROPER PPE (PERSONAL PROTECTION EQUIPMENT) AS PER LOCAL POLICIES AND RULES
 - WEAR FLAME/ARC RESISTANT WHOLE BODY CLOTHING
 - WEAR SUITABLE VOLTAGE RATED GLOVES
 - USE SAFETY DIELECTRIC FOOTWEAR
 - WEAR ARC FLASH FACE SHIELD
 - USE VOLTAGE RATED TOOLS
- DO NOT LAY TOOLS OR METAL PARTS ON TOP OF BATTERIES
- DISCONNECT THE CHARGING SOURCE PRIOR TO CONNECTING OR DISCONNECTING BATTERY TERMINALS.



CAUTION

REPLACE BATTERIES WITH THE SAME NUMBER AND SAME TYPE OF BATTERIES.



CAUTION

REPLACE FUSES ONLY BY DEVICES OF THE SAME TYPE AND OF THE SAME AMPERAGE TO AVOID FIRE HAZARDS.

3 Installation

3.1 Delivery, transportation, positioning and storage

3.1.1 Receipt of the UPS and visual inspection

When receiving the UPS, carefully examine the packing container and the UPS for any signs of physical damage. In case of damage, notify the carrier immediately.

The packing container of the UPS protects it from mechanical and environmental damage. To increase the protection, the UPS is wrapped in a plastic sheet. Keep the packaging for later re-use.

3.1.2 Unpacking list

After examining the package, open the carton box and check the following items are included:

- 1 x User manual
- 2 x UPS stands (support)
- 4 x M4 round screw (UPS stands)
- 1 x IEC C13-C14 cable
- 1 x monitoring software CD
- 1 x 15-pin communication cable (for parallel systems)
- 1 x USB cable

Rack mounting accessories (full rack mounting kit to purchase separately):

- 2 x 90° rack mounting brackets
- 4 x M6 clip nuts
- 12 x M6 screws
- 4 x M4 screws

Examine the UPS for any signs of damage and ensure that the received UPS corresponds to the material indicated in the delivery note. Notify your carrier or supplier immediately in case of any damage.

3.1.3 Storage of UPS

If you plan to store the UPS prior to use, keep the UPS in a dry, clean and cool storage room with an ambient temperature between (-15 °C to +60°C) and humidity of less than 95% non-condensing. If the packing container has been removed, protect the UPS from dust. Keep the UPS always in upright position and do not drop the equipment.

3.2 Site planning and positioning

3.2.1 Planning before the installation

Install the unit to a position where any danger to the UPS is minimized to ensure a long service life:

- Install the UPS indoors.
- Leave 50cm of space on each side of the cabinet to enable cooling airflow and ensure that the circulation of air to the ventilation slits is not obstructed.
- Avoid excessively high temperature and excessive moisture.
- Make sure that the surface is solid and flat.

3.2.2 Positioning

PowerValue 11 RT can be mounted in a rack or installed as a standalone configuration.



WARNING

WATER CONDENSING MAY OCCUR IF THE UPS IS UNPACKED IN A VERY LOW TEMPERATURE. IN THIS CASE IT IS NECESSARY TO WAIT UNTIL THE UPS IS FULLY DRIED INSIDE OUT BEFORE PROCEEDING INSTALLATION AND USE TO AVOID HAZARDS AND ELECTRIC SHOCK, WAIT UNTIL THE UPS IS FULLY DRY BOTH INSIDE AND OUTSIDE BEFORE INSTALLING.

3.2.3 Rack mount installation

Note that you need a rack mounting kit (purchased separately) for this operation.

To install the UPS to a rack:

1. Identify the rail holes in the rack for positioning the cabinet. Position the rails in the bottom of the 3U space for 6kVA units and 5U space for 10kVA units.
2. Slide the cabinet into the rack as shown in Figure 1.

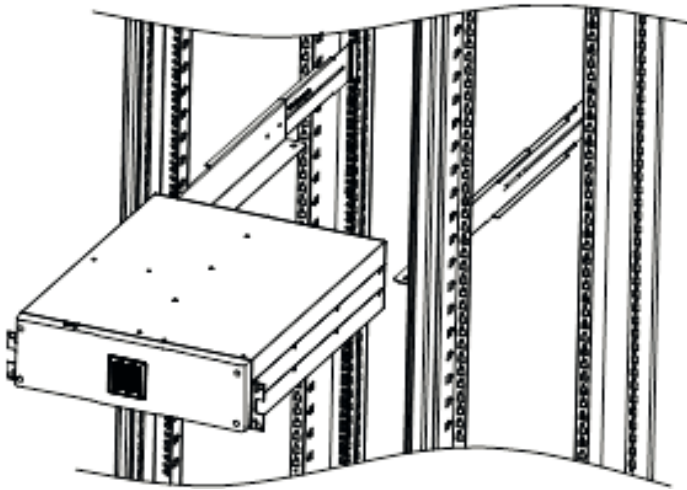

Figure 1: Rack mount installation

If installing additional UPS units, repeat the steps above for each cabinet.

3.2.2.1 Connecting the external battery modules

PowerValue 11 RT 6kVA

To connect the external battery modules:

1. Remove the front panels of the UPS and of the external battery modules.
2. Plug the external battery enclosure cable into the UPS battery connector as shown in Figure 2.

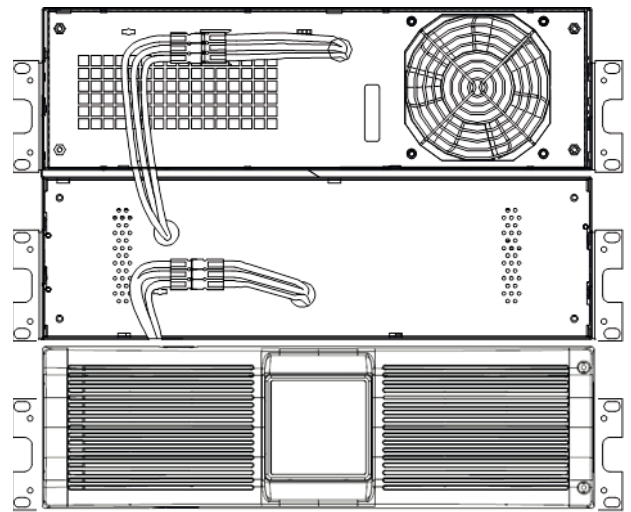

Figure 2: Battery module connections

3. Position and screw on the UPS and the battery module front panels.

PowerValue 11 RT 10kVA

To connect the external battery modules:

1. Plug the battery module cable into the UPS battery connector in the rear panel of the UPS as shown in Figure 3.

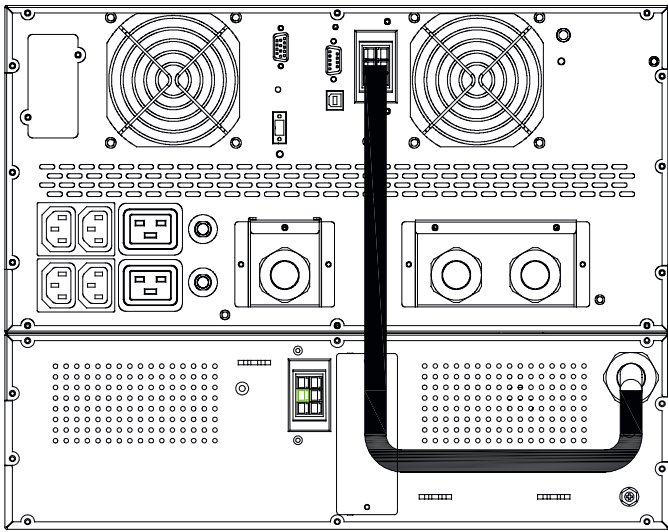

Figure 3: Battery Module Connections

3.2.2.2 Standalone / Tower Installation

PowerValue 11 RT 6 kVA

To install the UPS in a vertical (tower) position:

1. Carefully rotate the LCD control panel 90° to the right in the UPS and in the battery modules as shown in Figure 4.

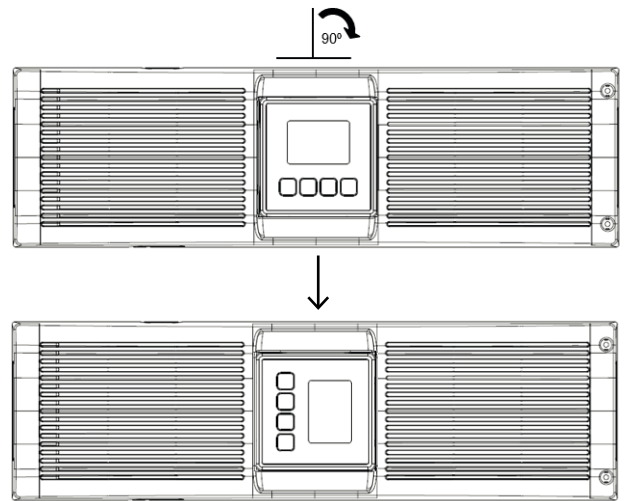



Figure 4: Display rotation

NOTE UP TO FOUR EXTERNAL BATTERY ENCLOSURES CAN BE CONNECTED TO THE UPS IN THE SAME WAY AS SHOWN ABOVE.

NOTE AFTER CONNECTING THE BATTERY ENCLOSURES, CONFIGURE THE NUMBER OF BATTERY MODULES IN THE CONTROL PANEL (FOR MORE INFORMATION SEE CHAPTER 4.4.2.5). SEE APPENDIX C FOR FURTHER DETAILS.

2. Place the units to a vertical position.
3. Screw the supports to the sides of the unit as shown in Figure 5.

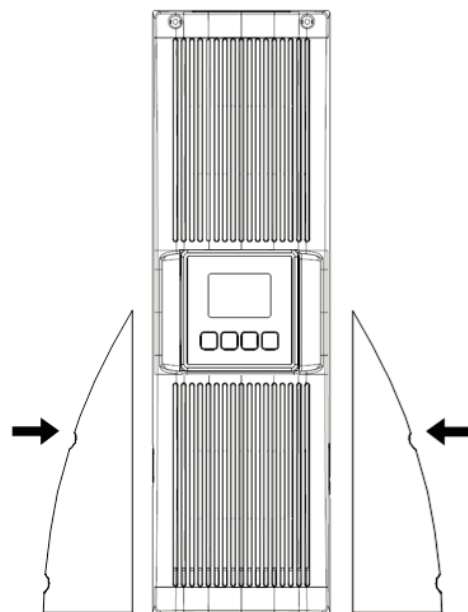

Figure 5: Support positioning

PowerValue 11 RT 10 kVA

To install the UPS in a vertical (tower) position:

1. Carefully rotate the LCD control panel 90° to the right in the top and bottom front panels as shown in Figure 6.

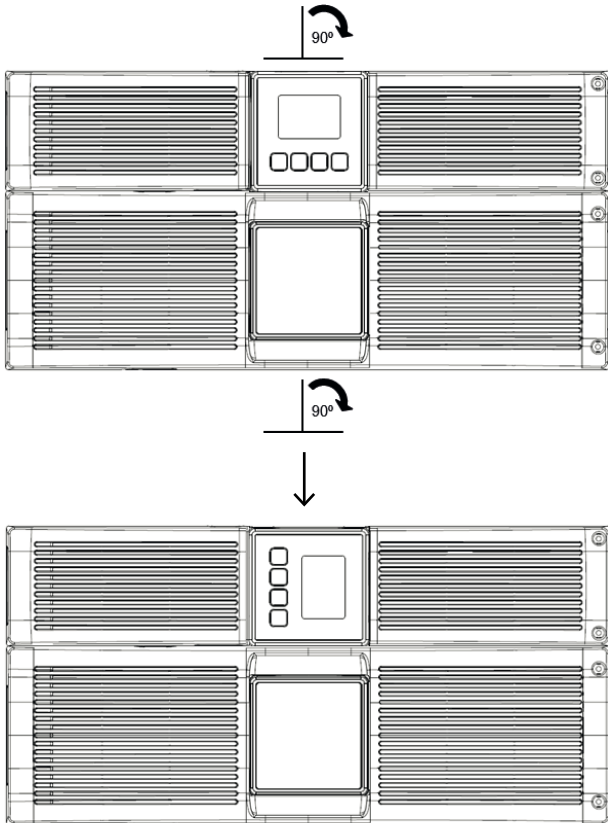

Figure 6: Display rotation

2. Place the units to a vertical position.
3. Screw the supports to the sides of the unit as shown in Figure 7.

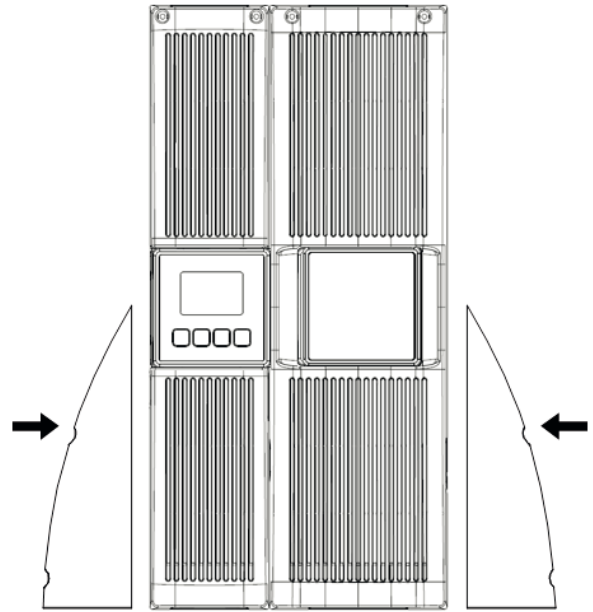

Figure 7: Support positioning

3.3 General characteristics

3.3.1 Front panel

Figure 8 shows the front panel of the UPS.

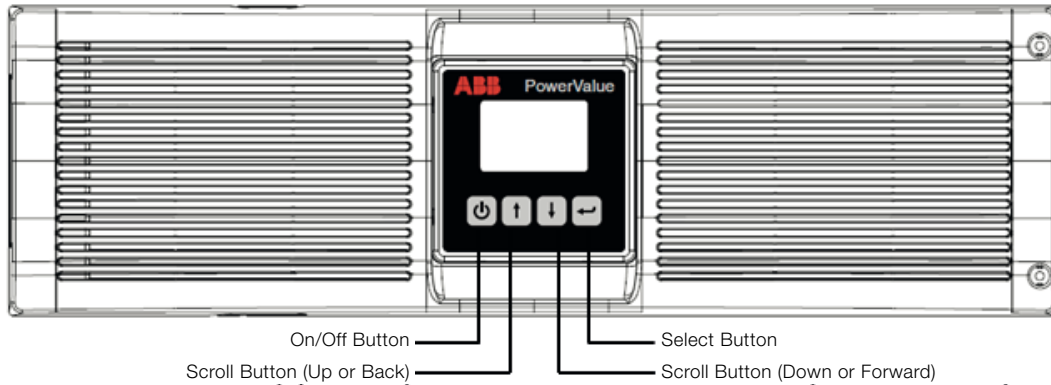

Figure 8: UPS front panel

3.3.2 Rear panel

Table 2 and Figures 9, and Table 3 and Figure 10 show the connectors and ports in the UPS rear panel.

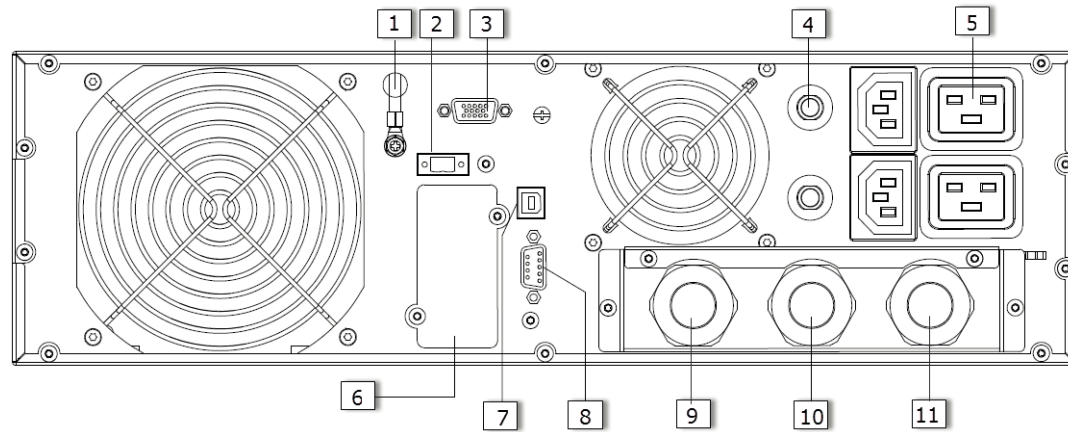

Figure 9: PowerValue 11 RT 6 kVA rear view

1	GND contact
2	EPO
3	Parallel port
4	Output circuit breaker
5	Output sockets
6	SNMP/ AS400 slot
7	USB
8	RS232
9	Bypass
10	AC input
11	AC output

Table 2: PowerValue 11 RT 6 kVA rear panel connectors and ports

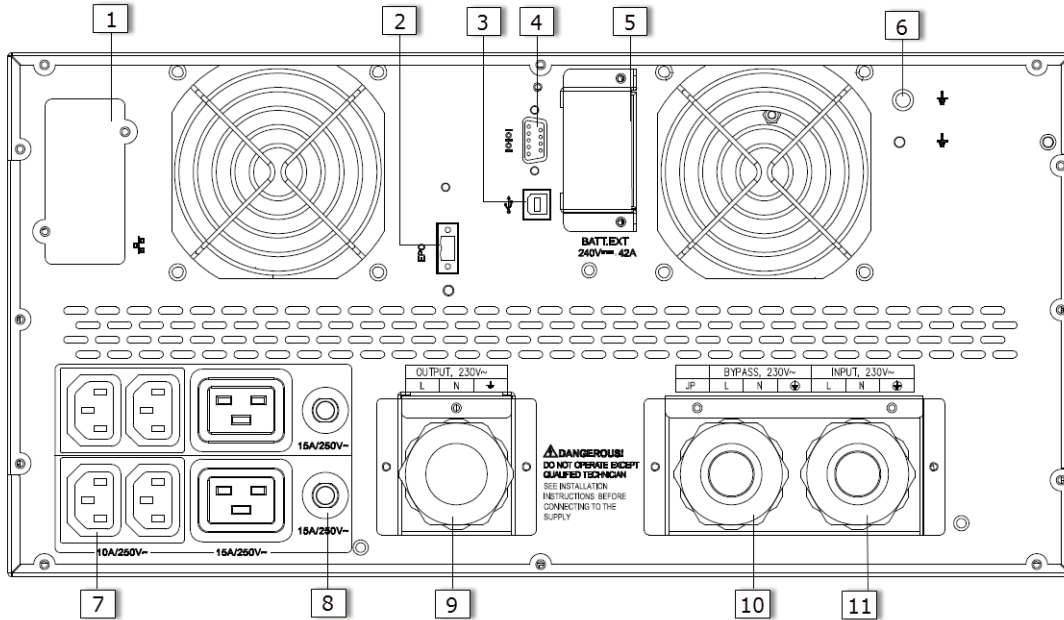

Figure 10: PowerValue 11 RT 10 kVA rear view

1	SNMP/ AS400 slot
2	EPO
3	USB
4	Parallel port
5	Battery connector
6	GND contact
7	Output sockets
8	Output circuit breaker
9	AC output
10	Bypass
11	AC input

Table 3: PowerValue 11 RT 10 kVA rear panel connectors and ports

3.4 Electrical installation

3.4.1 Commissioning

The commissioning of the UPS includes the connection of the UPS and batteries, the verification of the electrical installation and operating environment of the UPS, and the controlled start-up and testing of the UPS and customer training.

 **CAUTION** DO NOT OPERATE IN CASE OF PRESENCE OF WATER OR MOISTURE.

 **DANGER** WHEN OPENING OR REMOVING THE UPS COVERS YOU ARE EXPOSED TO DANGEROUS VOLTAGES.

 **WARNING**

3.4.2 Recommended cable sections and fuse ratings

When selecting the cable cross sections and the protective devices, follow the recommendations in the technical specifications document or follow local standards.

ABB recommends that an external isolating device is installed between the mains input and UPS as shown in Figure 11 to protect against back-feed currents.

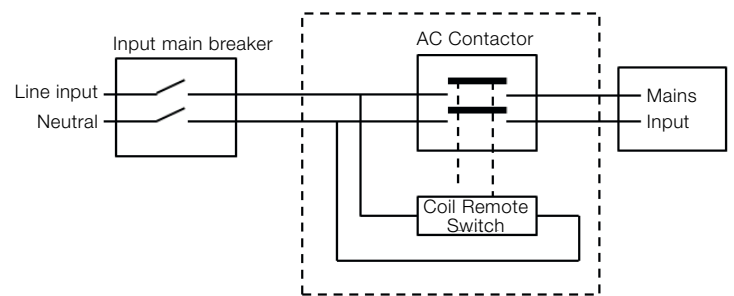

AC Contactor: 208-240V, 35A (PowerValue 11 RT 6 kVA)
208-240V, 50A (PowerValue 11 RT 10 kVA)

Figure 11: External back-feed isolation

 **DANGER** RISK OF BACKFEED VOLTAGE. ISOLATE THE UPS BY INSTALLING AN EXTERNAL ISOLATING DEVICE BETWEEN THE MAINS INPUT AND THE UPS.

 **WARNING** BEFORE OPERATING ON THIS CIRCUIT, CHECK FOR HAZARDOUS VOLTAGE.

3.4.3 Connections

To access the terminal blocks, remove the 2 screws from the terminal block cover as shown in Figures 12 and 13.

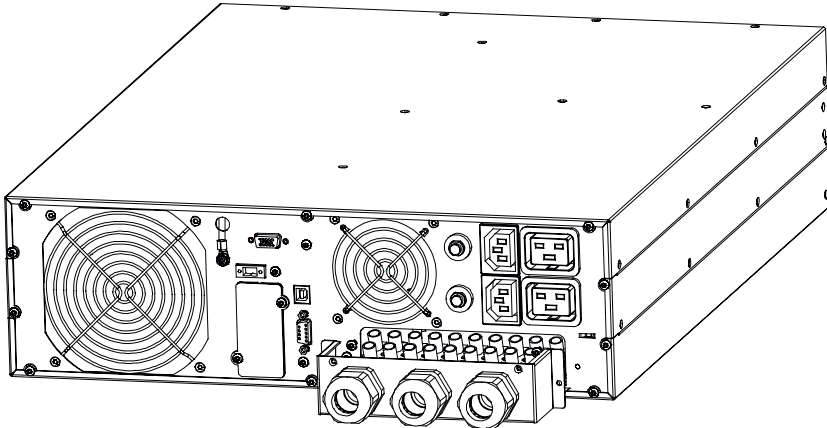

Figure 12: PowerValue 11 RT 6 kVA Terminal block

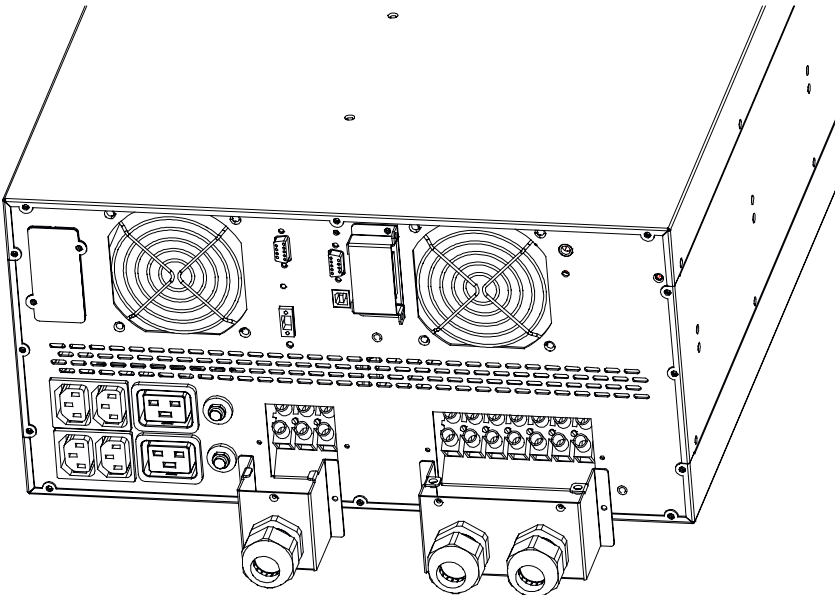

Figure 13: PowerValue 11 RT 10 kVA Terminal block

Single input feed connections

In the single input feed configuration, there is a single AC input to the UPS (inverter and bypass).

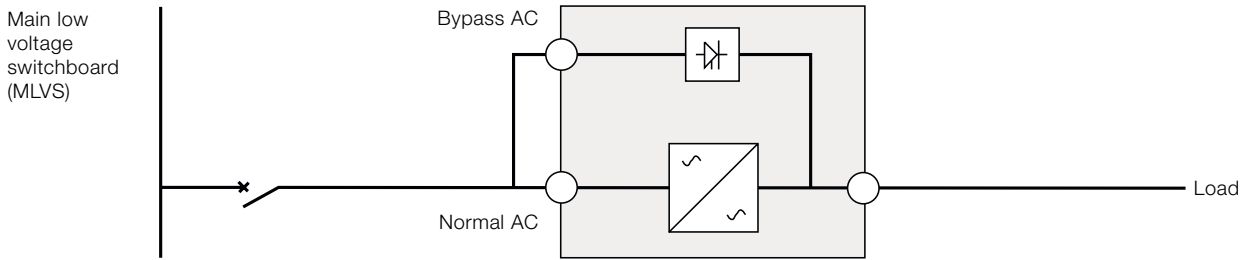



Figure 14: UPS diagram with single input feed



CAUTION MAKE SURE THAT THE EARTH WIRE IS CONNECTED.

To connect the UPS cables:

1. Connect a jumper between terminals JP and L.
2. Connect the input and output cables

Use appropriate tools and terminal splices to make sure that the contact between the wires and the terminal blocks is reliable.

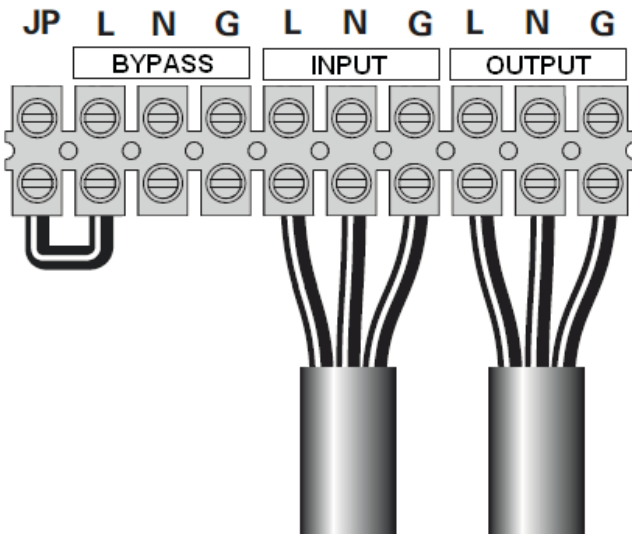

Figure 15: Single input feed connections for 6kVA units

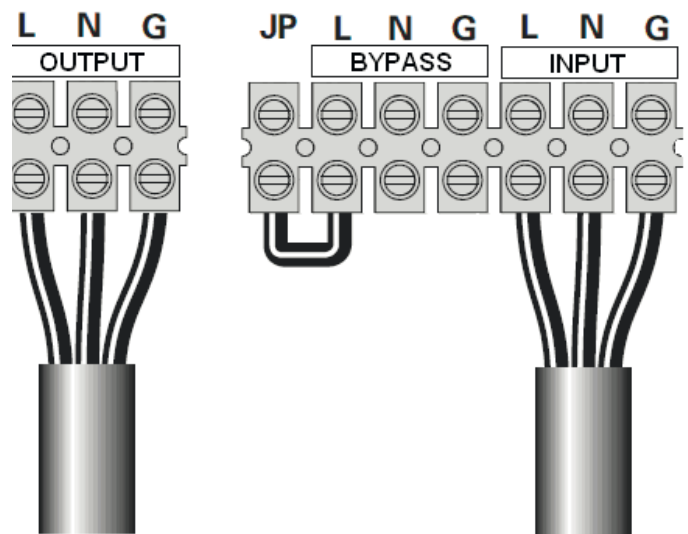

Figure 16: Single input feed connections for 10 kVA units

Dual input feed connections

In the dual input feed configuration, two separate AC inputs are connected to the UPS (one for the inverter and one for the bypass).

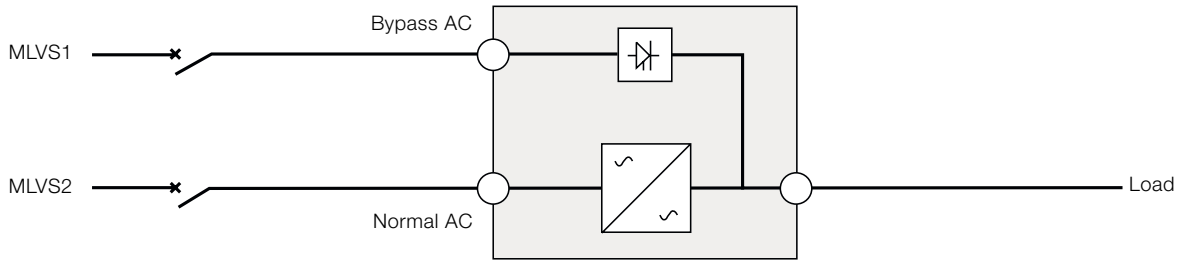

Figure 17: UPS Diagram with Dual Input Feed

When the Earth system of the inputs are different, a transformer should be connected to the inputs. Figure 18, Figure 19, and Figure 20 show the alternative ways of connecting the inputs to the transformers.

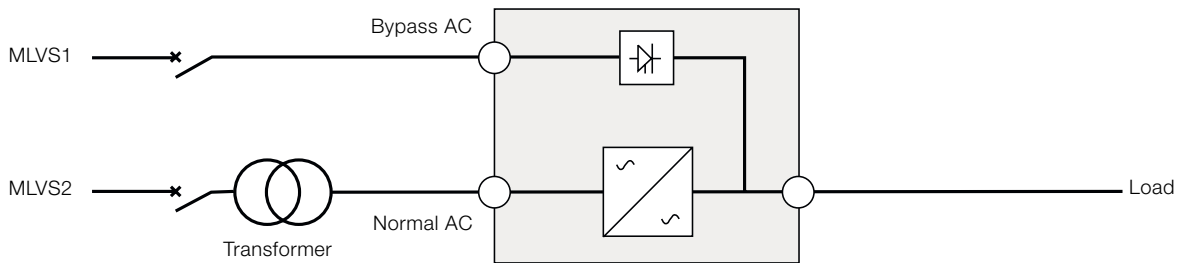

Figure 18: UPS with transformer in the normal AC input

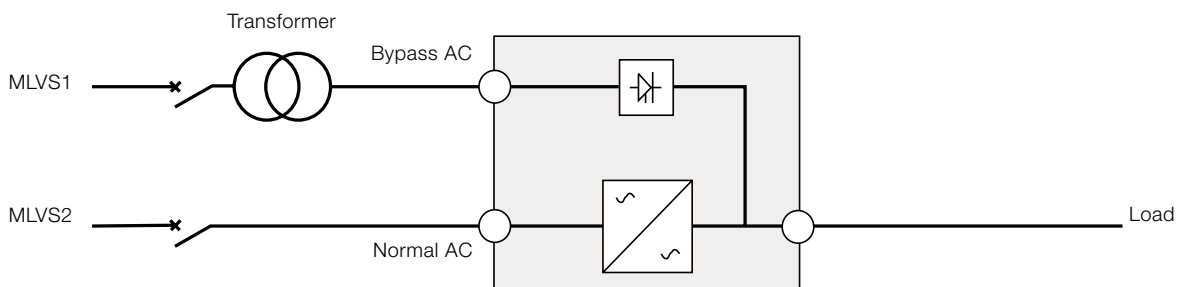

Figure 19: UPS with transformer in the bypass input

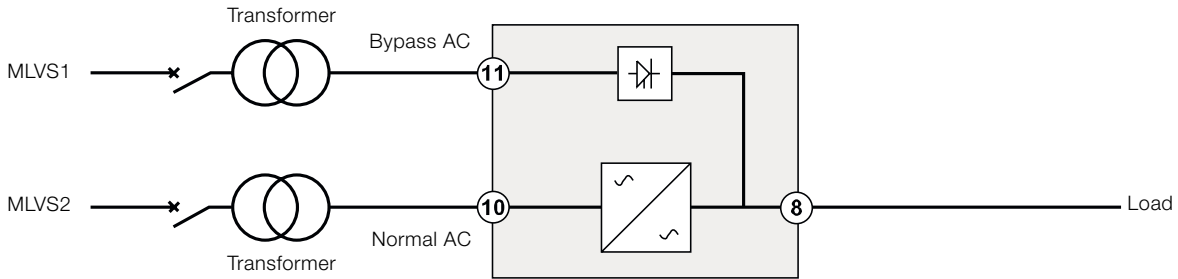



Figure 20: UPS with transformer in normal and bypass inputs



MAKE SURE THAT THE EARTH WIRE IS CONNECTED.

CAUTION

To connect the UPS cables:

1. Ensure that the jumper JP is disconnected.
2. Connect the input, output and bypass cables.

Use appropriate tools and terminal splices to ensure that the contact between the wires and the terminal blocks is reliable.

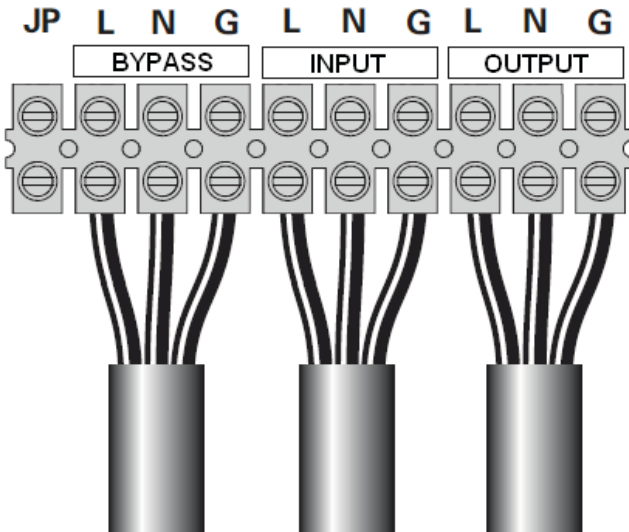

Figure 21: Dual input feed connections for 6kVA units

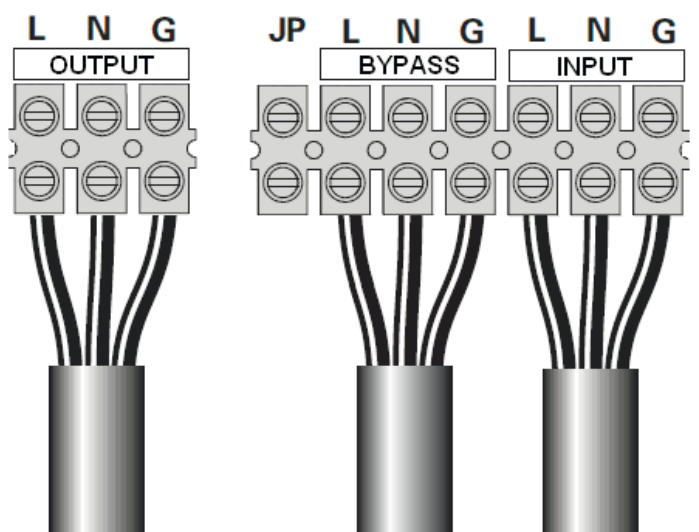

Figure 22: Dual input feed connections for 10kVA units

Frequency converter connections

PowerValue 11 RT can work as a frequency converter, in which case only the input and output should be connected as shown in Figure 23, Figure 24 and Figure 25.

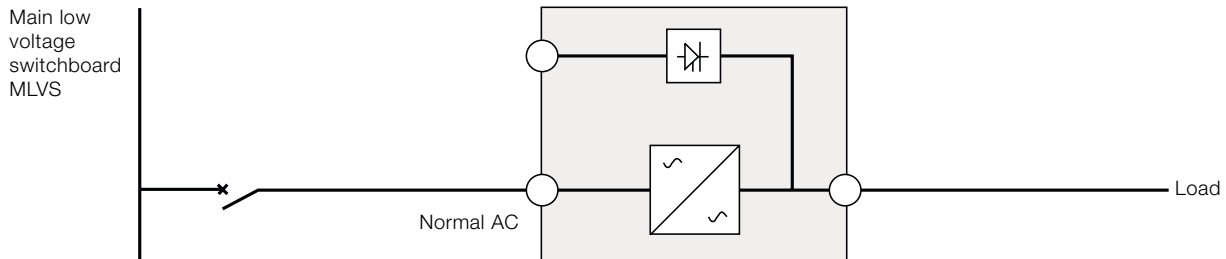

Figure 23: UPS diagram as a frequency converter

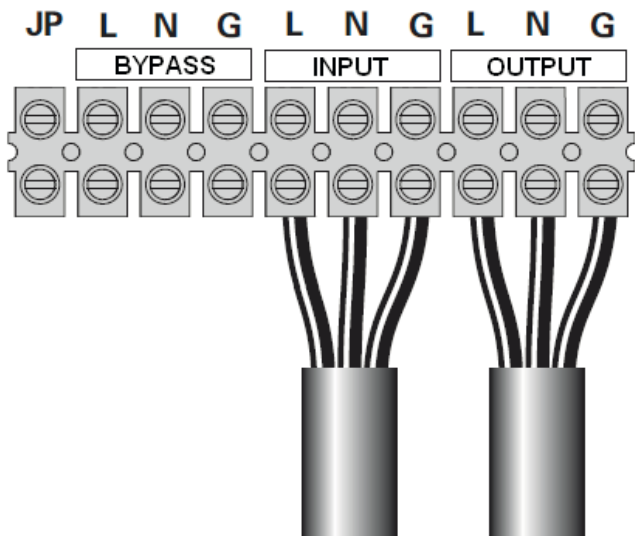

Figure 24: Frequency converter connections for 6kVA units

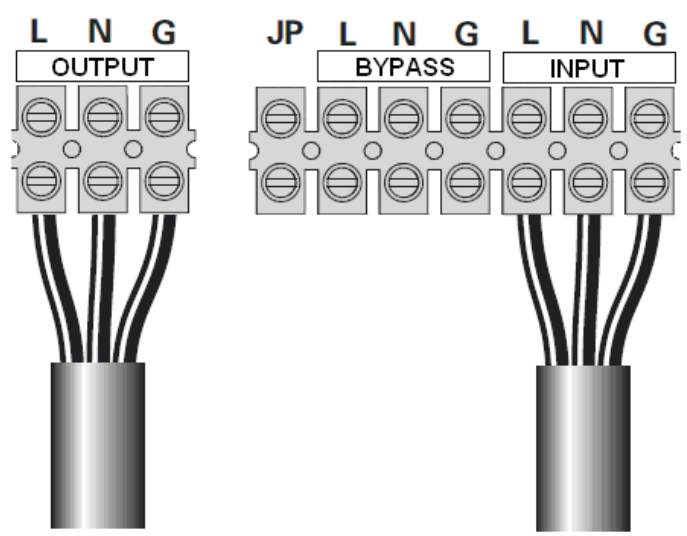



Figure 25: Frequency converter connections for 10kVA units



CAUTION

INDUCTIVE LOADS (FOR EXAMPLE MONITORS AND LASER PRINTERS) HAVE A VERY HIGH POWER CONSUMPTION AT START-UP. IF CONNECTED TO THE UPS, THE START-UP POWER OF SUCH LOADS MUST BE TAKEN INTO CONSIDERATION WHEN CALCULATING THE CAPACITY OF THE UPS TO PREVENT THE UPS FROM BEING OVERLOADED AND TURNED OFF.

3.5 Initial startup



SWITCH OFF THE CONNECTED LOADS BEFORE TURNING ON THE UPS. SWITCH ON THE LOADS ONE BY ONE AFTER THE UPS IS TURNED ON.

CAUTION SWITCH OFF ALL OF THE CONNECTED LOADS BEFORE TURNING OFF THE UPS.

To start up the UPS:

1. Verify that the total equipment rating does not exceed the UPS capacity.
2. Check that all cables are connected correctly and well-fixed mechanically.
3. Set the upstream circuit breaker (not included) to the “power-on” position (ON). The UPS LCD panel will illuminate and show a welcome screen.
4. The UPS transfers to bypass-mode.
5. Keep the power-on button  on the UPS LCD panel pressed for at least three seconds.
6. Check the UPS display for active alarms or notices. Solve any active alarms. For more information, see “Troubleshooting” in Chapter 6.
7. Verify that the UPS is operating normally and that the loads are powered.
8. Adjust the date and time settings. For more information, see Chapter 4.4.2.5



NOTE

AT THE INITIAL STARTUP, THE UPS SETS THE SYSTEM FREQUENCY ACCORDING TO THE FREQUENCY IN THE INPUT LINE (INPUT FREQUENCY AUTO-SENSING IS ENABLED BY DEFAULT). AFTER INITIAL STARTUP, AUTO-SENSING IS DISABLED UNTIL MANUALLY RE-ENABLED THROUGH THE OUTPUT FREQUENCY SETTINGS.



NOTE

AT INITIAL STARTUP, THE INPUT VOLTAGE AUTO-SENSING IS DISABLED BY DEFAULT. AFTER MANUALLY ENABLED IN THE VOLTAGE SETTINGS, THE UPS OUTPUT VOLTAGE WILL BE SET ACCORDINGLY TO THE INPUT VOLTAGE. AFTER A SUBSEQUENT STARTUP, AUTO-SENSING WILL BE DISABLED UNTIL MANUALLY RE-ENABLED IN THE OUTPUT VOLTAGE SETTINGS.

9. If you connect the REPO port, test this function by activating the external REPO switch and verifying that its status changes on the UPS display.

3.6 Emergency power off (EPO)

The EPO connector can be used to block the output of the UPS in case of an emergency. The EPO connector can be configured as Normally closed (NC) or Normally opened (NO) through the USB or RS232 port.

By default, the EPO connector is Normally closed (NC) by a jumper in the rear panel. If the jumper is removed, the UPS output will not supply energy to the load until the EPO status is changed.

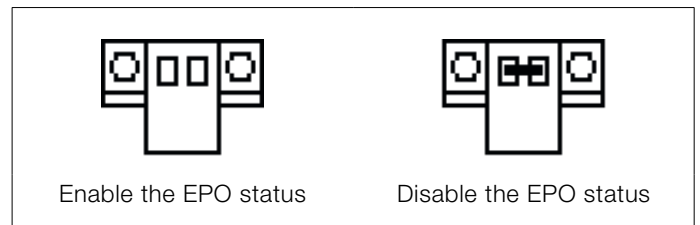

Figure 26: EPO connector

To return to normal status, the EPO connector must be closed. Enter the LCD menu to clear the EPO status (for more information, see Chapter 4.4.2.3). The UPS alarm is cleared and bypass mode is recovered. Set the UPS to inverter mode manually.

3.7 Paralleling the units

Up to 2 UPS units can be connected in parallel with PowerValue 11 RT 6-10 kVA to obtain output power sharing and power redundancy.

3.7.1 Output wiring requirements

The following requirements must be met for output wiring:

- When the distance between the UPS in parallel and the breaker panel is lower than 10 meters, the length difference between input and output cables of the UPS must be lower than 20%.
- When the distance between the UPS in parallel and the breaker panel is more than 10 meters, the length difference between input and output cables of the UPS must be lower than 5%.

3.7.2 Installing a new parallel system

To install a new parallel UPS system:

1. Prepare the input and output wires, the input and output breakers and the parallel cable. For more information, see Chapter 3.4.2
2. Parallel the units with the 15-pin communication cable provided with the UPS.
3. Connect the External Battery modules independently to each UPS.
4. Connect the input and output wires as shown in Figure 27. Note that all breakers should be opened.

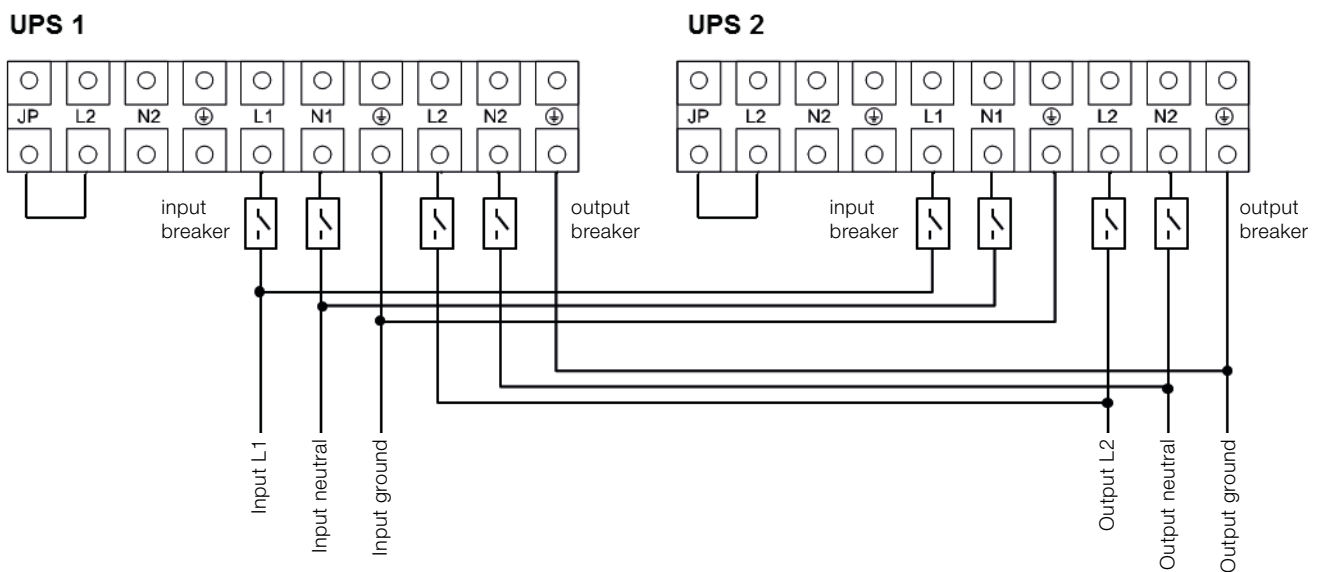

Figure 27: Parallel system wiring diagram – PowerValue 11 RT 6kVA and 10kVA

5. Turn on the mains breakers and the input (I/P) breakers for the two parallel UPS.
6. Keep the power-on button pressed for longer than 1 second in one UPS. The system will start up and go to online-mode.
7. Regulate the output voltage of each UPS separately and check that the output voltage difference between the two UPS units is lower than 0.5V.
 - If the output voltage difference is higher than 0.5V, the UPS voltage needs to be regulated.
 - If the output voltage difference is lower than 0.5V, switch on the output breakers for both UPS units separately and switch on the main output (O/P) breakers.
8. Transfer the mains mechanical or static switch to the UPS. The system will then run in parallel.

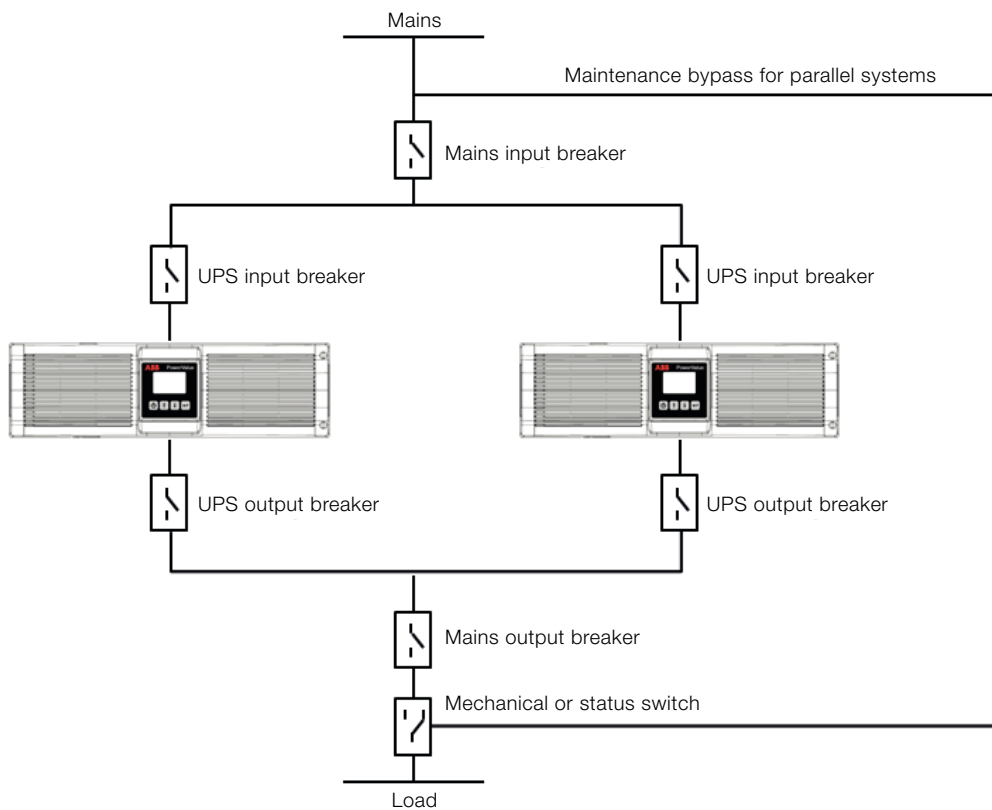

Figure 28: Parallel system installation diagram

3.7.3 Adding a UPS in parallel to an existing UPS

To add a UPS in parallel to an existing UPS:

1. Install a main maintenance mechanical switch or static switch to the parallel system.
2. Regulate the output voltage of the new UPS. Check that the output voltage difference between the new UPS and the existing one is lower than 0.5V.
3. Ensure that the bypass of the existing UPS is normal and the bypass setting is "enabled", then press the power-on button to turn off the UPS. The UPS will work in bypass-mode.
4. Set the main maintenance switch or static switch from "UPS" to "BPS".
5. Switch off the mains output breaker, the UPS output breaker, the UPS input breaker and mains input breaker. The UPS will shut down.
6. Connect the cable and wire of the added UPS as shown in Figure 27 and Figure 28.
7. Switch on each UPS input breaker and mains input breaker and check that every UPS works in bypass-mode.
8. Switch on the mains output breaker and the UPS output breaker.
9. Transfer the main maintenance switch or static switch from "BPS" to "UPS".
10. Press the power-on button of one UPS and each UPS will turn on. Both UPS will then work in parallel in online-mode.

3.7.4 Removing a single UPS from a parallel system

To remove a single UPS from a parallel system:

1. Install a main maintenance mechanical switch for the parallel system.
2. Ensure that bypass is normal and the bypass setting is "enabled".
3. Press the power-on button to turn off both UPS's. The overall UPS system will work in bypass-mode.
4. Transfer the main maintenance switch or static switch from "UPS" to "BPS"
5. Switch off the UPS output breaker and the UPS input breaker for both UPS's. Switch off the input mains breaker. The UPS's will shut down.
6. Switch off the mains output breaker.
7. Remove the chosen UPS, cables and wires.
8. Switch on the input breaker and mains input breaker of the remaining UPS, and make sure the UPS works in bypass-mode.
9. Switch on the UPS output breaker and mains output breaker.
10. Transfer the main maintenance switch or static switch from "BPS" to "UPS"
11. Press the power-on button to turn on the UPS. The UPS will start up and run in online-mode.

3.8 Installation Checklist

- All packing materials and restraints have been removed from all modules.
- Each unit in the UPS system is placed in the installed location.
- All conduits and cables are properly routed to the UPS and auxiliary cabinets.
- All power cables are properly sized and terminated.
- A ground conductor is properly installed.
- Battery enclosure is installed.
- Air conditioning equipment is installed and operating correctly.
- The area around the installed UPS system is clean and dust-free.
- Adequate workspace exists around the UPS and other cabinets.
- Adequate lighting is provided around all UPS equipment.
- Any optional accessories are mounted in their installed location and properly wired.
- Start-up and operational checks have been performed by authorized service personnel.
- All network connections are completed.

4 Operation

This chapter describes how the UPS is operated through the LCD display.

The user can:

- Operate the LCD display
- Start up and shut down the UPS (excluding the commissioning start up)
- Operate additional SNMP adapters and their software

4.1 Control Panel

The user-friendly control panel has two parts:

- selection keys
- power management LCD display (PMD)

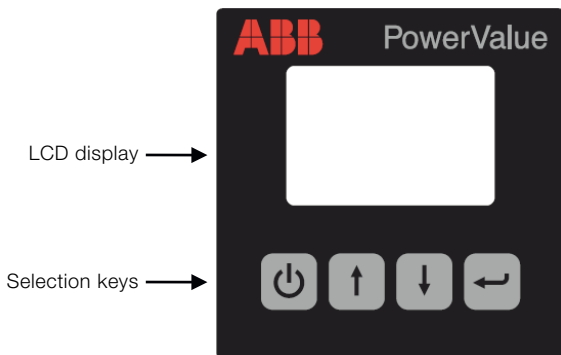

Figure 29: Control panel

4.1.1 Selection Keys





Button	Function	Illustration
	Power on/off	Turn the UPS on and off or change operating mode.
	Scroll up	Enter/exit the menus and scroll across the screens.
	Scroll down	Scroll down the menu.
	Select / Edit	Select and confirm settings.

Table 4: UPS selection keys

4.1.2 LCD display

The LCD display shows an overview of the status of the UPS:

- Input
- Output
- Battery
- load parameters
- working mode
- settings on voltage
- frequency
- bypass presence.

The display has two main backlight colors. During normal operation the display has a blue background with white text. In case of a critical alarm, the backlight color changes to orange with dark text.

A buzzer indicates UPS status. Table 5 lists the buzzer status meanings

UPS condition	Buzzer status
Active fault	Continuous
Active warning	Beep every second
Battery	UPS on battery: Beep every 4 seconds Low battery: buzzer beeps every second
Bypass	Beep every 2 minutes
Overload	Beep twice every second

Table 5: Definition of alarms

When powering on, the LCD display shows the UPS status. The UPS will also return to this default screen when no buttons have been pressed for 15 minutes.

The status screen shows the following information:

- Status summary, including operating mode and load information
- Alarm status, if present (including fault and warning information)
- Battery and charger status (including battery voltage, charge level and charger status)
- Current runtime information

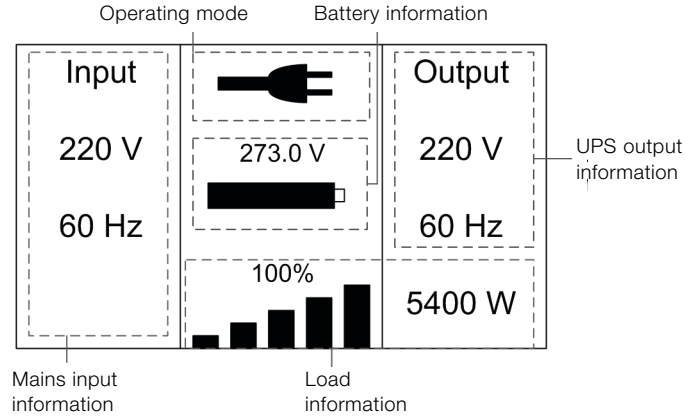

Figure 30: The default LCD display

For more information on how to use the LCD, see Chapter 4.4.

4.2 Operating Mode

Symbols indicate the status and the operating mode of the UPS. Symbols appear in the position shown in Figure 31.

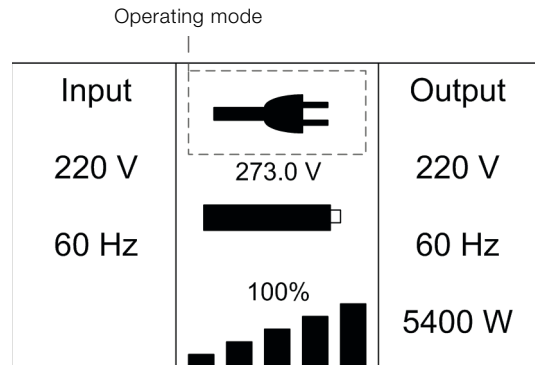

Figure 31: Operating mode











Status	Symbol	Description
Online-mode		UPS is running through the inverter (online-mode)
Battery-mode		UPS is running on battery. The alarm buzzer sounds every 4 seconds.
Bypass-mode		The power used by the load is supplied from the mains power via an internal filter. Note that if there is a power failure and the UPS is on bypass, it will not transfer back to mains or to battery-mode. In bypass-mode the alarm buzzer will sound every 2 minutes.
Bypass without output		UPS is running in bypass but there is no power in the output.
ECO-mode (HE: High efficiency-mode)		After the UPS is turned on, the power used by the load is supplied from the mains via an internal filter if its power is in an acceptable range. This guarantees higher efficiency of the UPS. In case of a mains failure, the UPS transfers to Online-mode or Battery-mode and the load is supplied continuously. Note: ECO-mode can be enabled through the LCD settings or through the monitoring software. Warning: The transfer time of UPS output from ECO-mode to battery-mode is 10ms and not recommended for sensitive loads.
Converter-mode		In converter-mode, the UPS runs with fixed output frequency (50Hz or 60Hz). In case of a mains failure, the UPS transfers to battery-mode and the load is supplied continuously. Note: - Converter-mode function can be enabled through the LCD settings or the monitoring software. - The load is de-rated to 70% in converter-mode.
Warning		Warnings indicate abnormal situations that do not stop the UPS from working. The UPS continues running but the user should perform corrective actions. For more information, see Chapter 6.
Fault		In case of failure, the UPS may disconnect the load or transfer to bypass depending on the cause of the failure. The UPS alarm sounds a continuous signal and the backlight of the UPS will turn red. For more information, see Chapter 6.
Overload		When the UPS is on overload, an alarm sounds twice every second. Disconnect unnecessary loads one by one to decrease the load. The load should be lower than 90% of its nominal power capacity in order to stop alarming.
Battery test		UPS is performing a battery test.
Battery disconnected		The battery is disconnected or defective. The UPS alarm sounds.

Table 6: Symbols in operating mode

4.3 UPS start-up and shutdown



NOTE

THE FIRST TIME THE UPS IS STARTED UP, IT MUST BE CONNECTED TO THE UTILITY.

4.3.1 UPS start-up

To start up the UPS with mains supply:

1. Check that all cables are connected correctly and well-fixed mechanically.
2. Keep the power-on button pressed for longer than 1 second. The fans are activated and the UPS will load for a few seconds.
3. The UPS performs a self-test and the LCD shows the default UPS status screen.



NOTE

THE BYPASS-MODE IS ENABLED BY DEFAULT AND CAN BE CONFIGURED THROUGH THE USER'S SETTINGS (FOR MORE INFORMATION, SEE TABLE 7).

To start up the UPS without mains supply (cold start):

1. Check that all cables are connected correctly and well-fixed mechanically.
2. Keep the power-on button pressed for longer than 1 second. The UPS is powered on, the fans are activated and the LCD is turned on. The UPS performs a self-test and shows the default UPS status screen.
3. Keep the power-on button pressed for longer than 1 second. The alarm buzzer sounds for 1 second and the UPS starts up.
4. After a few seconds, the UPS transfers to battery-mode. When the UPS is supplied with power from the mains, the UPS transfers to online-mode without interruption in the output of the UPS.

4.3.2 UPS shutdown

To shut down the UPS with mains supply:

1. If the UPS is working on bypass-mode, go to step 3.
2. If the UPS is on online-mode, keep the power-on button pressed for more than 3 seconds. The alarm buzzer will sound and the UPS will transfer to bypass-mode.



CAUTION

THE OUTPUT IS STILL ENERGIZED.

3. Disconnect the mains power supply. The display will shut down and the output voltage will be removed from the UPS output terminal.
4. In case bypass has been disabled through the Settings menu, keep the power-on button pressed for longer than 3 seconds to shut down the UPS. The unit will transfer from online to stand-by mode. Disconnect the input power cable and the display will shut down.

To shut down the UPS without mains supply:

1. To power off the UPS, keep the power on/off button pressed for more than 3 seconds. The alarm buzzer will sound for 3 seconds and the output power will be immediately cut-off.
2. The display will shut down and the output voltage will be removed from the UPS output terminal.

4.4 Display operation

Information on the status of the UPS, measurements, events and general information on the UPS are available through the LCD display. This chapter describes how to navigate through the display and how to adjust the user settings.

4.4.1 Changing the operating-mode

To change the operating-mode, the power-on button is used as follows:

- From online-mode to bypass-mode: Press the power-on button for 3 seconds.
- From bypass-mode to online-mode: Press the power-on button for 3 seconds.
- From bypass-mode to battery: Disconnect the power supply cable and press the power-on button for 3 seconds.
- From battery-mode to online-mode: Connect the power supply to the UPS and it will transfer automatically to online-mode.



NOTE

IF BYPASS IS DISABLED IN THE SETTINGS MENU AFTER PRESSING THE POWER-ON BUTTON FOR 3 SECONDS, THE UPS GOES FROM ONLINE MODE TO STAND-BY MODE.

4.4.2 Navigation

Use the scroll buttons to navigate through the UPS screens. From the main screen (UPS status screen), press \uparrow or \downarrow for information on alarm, parallel system and battery.

From the main screen, keep \uparrow pressed for longer than 1 second to enter the main menu.

The main menu has the following submenus:

- UPS status
- event log
- measurements
- control
- identification
- settings.

Figure 32 shows how to navigate through the menus and submenus.

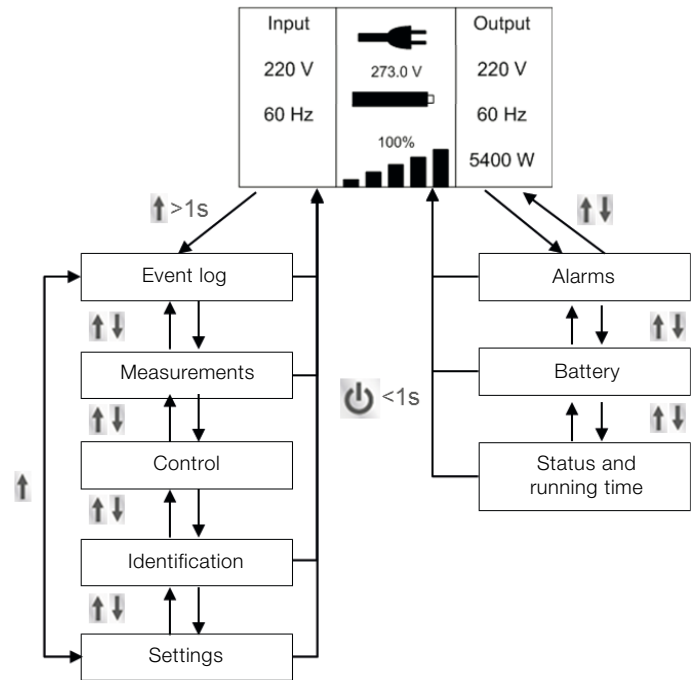

Figure 32: Main menu tree

4.4.2.1 Event log

To enter the event log menu, press \leftarrow . The last 50 events, alarms and faults occurred in the UPS are displayed. The alarms are indicated by the corresponding event code and operating time of UPS. To navigate through the events and alarms, press \uparrow or \downarrow .

4.4.2.2 Measurements

To enter the measurements menu, press \leftarrow . Several measurements are displayed in the menu including output voltage, frequency, current, load capacity, input voltage and frequency. To navigate through the measurements, press \uparrow or \downarrow . To return to the previous menu (event log), press \uparrow for longer than 1 second.

4.4.2.3 Control

Using the Control menu, you can control some features of the UPS. To modify the parameters, press . Then scroll up or down to modify the parameters. To confirm the selection, keep pressed for longer than 1 second.

Table 7 shows the operations available in the Control menu.

Control	Description	Possible values	Default values
Buzzer mute	Mute the UPS sound	No/Yes	No
Single UPS turn off	Turn off one UPS in a parallel system	No/Yes	No
Single UPS battery test	Initiate test of the batteries of a single UPS	Battery test running / passed / failed / interrupted / aborted	Battery not tested
Parallel UPS battery test	Initiate test of the batteries of a group of UPSs		
Clear EPO status	Remove UPS from emergency power off status	No/Yes	No
Reset fault state	Reset warning, alarming status and buzzer	No/Yes	No
Clear event log	Reset all the events from the log file	No/Yes	No
Restore factory settings	Recover all settings in the LCD menu and the EPO polarity and locks the DC start-up (can be executed only when UPS is in bypass mode)	No/Yes	No

Table 7: UPS control menu



NOTE WHEN THE CLEAR EPO STATUS IS ENABLED, THE UPS WILL STOP ALARMING AND WILL RECOVER IN BYPASS-MODE. IN THIS CASE, THE UPS NEEDS BE TURNED ON MANUALLY.

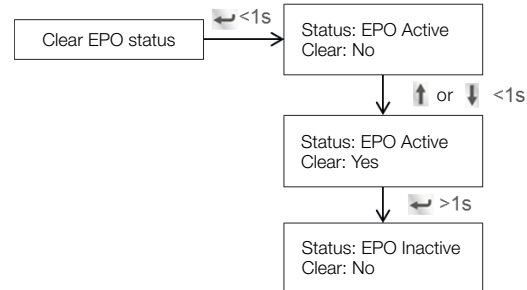



Figure 33: Example: clearing EPO status



NOTE MAKE SURE THAT THE EPO SIGNAL IS INACTIVE OR THE LCD WILL SHOW THAT THE EPO ACTIVE STATUS COULD NOT BE CLEARED.

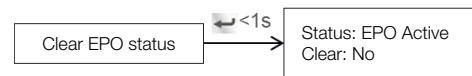



Figure 34: Clear EPO status



NOTE RESET FAULT STATUS: WHEN A FAILURE OCCURS, THE UPS GOES TO FAULT-MODE AND THE BUZZER ALARM SOUNDS. AFTER CHECKING THE REASON OF THE FAILURE AND TAKING THE APPROPRIATE CORRECTIVE ACTIONS, ENTER THIS MENU TO RESET THE ERROR STATUS AND RECOVER THE NORMAL STATUS. THE ALARM WILL STOP AND THE UPS WILL TRANSFER TO BYPASS-MODE.

Figure 35 shows an overview on how to navigate the control menu.

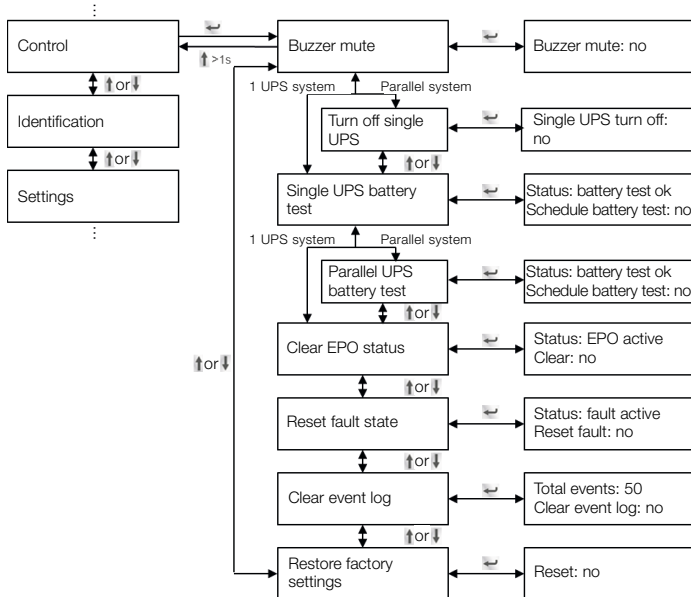

Figure 35: Control menu tree

4.4.2.4 Identification

The identification menu shows the UPS serial number, firmware serial number and model type. Press to navigate through the Identification menu. Press for longer than one second to return to the previous main menu.

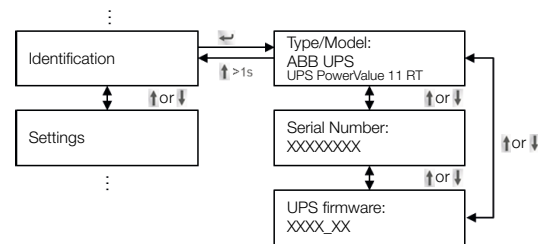

Figure 36: Identification menu tree

4.4.2.5 Settings



Contact your local distributor for further information before using the settings.

Some settings in the Settings menu impact the performance of the UPS and others enable and disable functions within the UPS. Failures and reduced protection can occur if the equipment is not set in an adequate way.



NOTE

MOST SETTINGS SHOULD BE DONE ONLY WHEN THE UPS IN BYPASS-MODE.

If the password is enabled, enter the password **USER** by pressing the buttons ,  and . The password is used mainly to protect against unwanted modifications in the Settings menu.

The available operations are listed in Table 8.

Submenu item	Description	Optional Values	Default value
Language	Select menu language	Chinese/English	English
User password*	Protects against settings modifications	enabled/disabled	disabled
Audio alarm	Enable/disable alarm sounds	enabled/disabled	enabled
Output voltage	Define local rated output voltage	208/220/230/240V	230V
Output frequency	Define local rated output frequency	autosensing/50/60Hz	autosensing
Power strategy** or Running mode	Define the UPS running mode as normal, ECO-mode (or HE high efficiency) and converter mode	normal/high efficiency/converter	normal
DC start	Start the UPS from the batteries (without mains power)	enabled/disabled	enabled
Site wiring fault alarm	Phase and neutral cables are connected in reversed positions.	enabled/disabled	enabled
Ambient temperature warning	Temperature is over the limit supported by the UPS	enabled/disabled	enabled
Automatic battery tests period	Define the frequency of the battery tests	0-31 days	7days
Auto restart	After UPS shuts down (low battery capacity), the UPS restarts automatically when mains power is recovered.	enabled/disabled	enabled
Automatic overload restart	The UPS is automatically restarted if it shut downs due to overload.	enabled/disabled	enabled
Auto bypass	Automatic bypass can be disabled for countries where the power supply is very unstable. UPS runs only online or on battery.	enabled/disabled	enabled
Short circuit clearance	- When enabled, short circuit will last for 4s before cutting off the output. If short circuit is removed during this time, the UPS will continue to run normally. - When disabled, short circuit will only last for 100ms before UPS output is cut off.	enabled/disabled	disabled
Redundancy lost (in parallel UPS systems)	One of the parallel units has been disconnected from the system	enable/disabled	enabled
Bypass voltage low limit	When the voltage in the bypass is below this limit, the UPS changes running mode.	120~215V	184V
Bypass voltage high limit	When the voltage in the bypass is above this limit, the UPS changes running mode.	245~276V	264V
Bypass frequency low limit	When the frequency in the bypass is below this limit, the UPS changes running mode.	1%~10%	10%
Bypass frequency high limit	When the frequency in the bypass is above this limit, the UPS changes running mode.	1%~10%	10%
ECO mode (HE) voltage low limit	When the voltage in the bypass is below this limit, the UPS changes running mode.	5%~10%	5%
ECO mode (HE) voltage high limit	When the voltage in the bypass is above this limit, the UPS changes running mode.	5%~10%	5%
ECO mode (HE) frequency low limit	When the frequency in the bypass is below this limit, the UPS changes running mode.	1%~10%	5%
ECO mode (HE) frequency high limit	When the frequency in the bypass is above this limit, the UPS changes running mode.	1%~10%	5%
External Battery module***	Define the number of battery modules. If number is higher than 4, it should be configured through the monitoring software	0-4	0
Set running time	Set the UPS running time mainly used for test purposes	Day:hour:minute:second 0000:0000:00~9999 23:59:59	Running time
LCD contrast	Changes the light contrast in the LCD panel	-5~+5	0

**Read Chapter 4.2, before using ECO-mode (HE mode) or converter function.

***Ensure that real battery quantity is same as the settings not to damage the batteries (see Appendix C).

Table 8: Settings menu

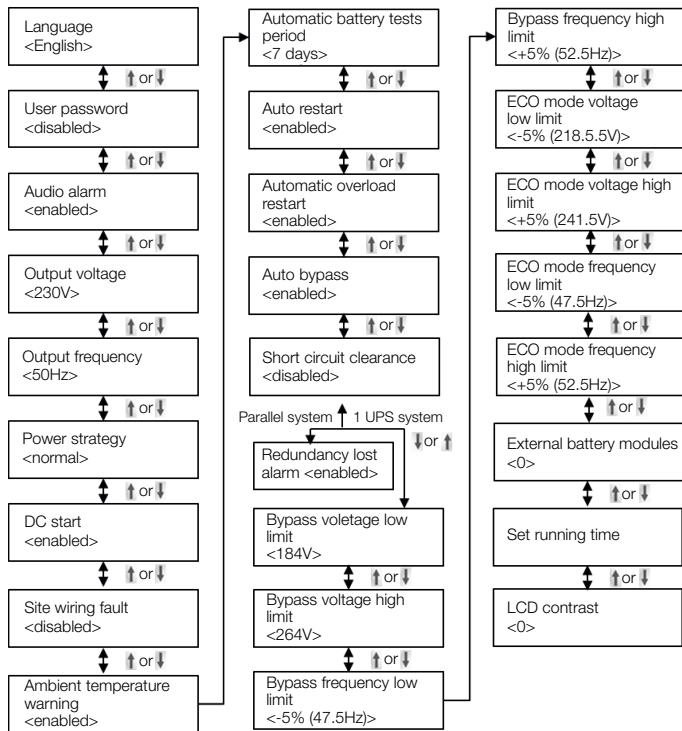

Figure 37: Setting menu tree

Example: Setting the rated output voltage value (Figure 38). Note that the UPS must be in bypass to change this parameter.

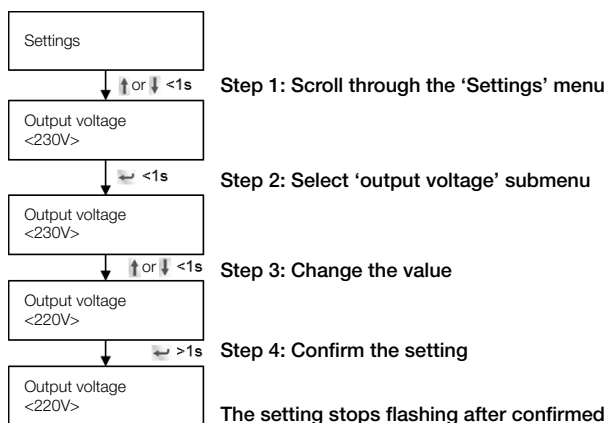

Figure 38: Setting rated output voltage value

5 Communication

A USB and an RS-232 port are available to enable the communication between the UPS and a remote computer/ station. Only one communication port can be active at a time and the priority is given to the USB port.

Once the communication cable is installed, the power management software can exchange information with the UPS. The software collects information from the UPS and indicates the status of the device, the power quality of the mains and the battery autonomy of the units.

In case of a power failure and a predicted shutdown of the UPS due to low battery autonomies, the monitoring system is capable of saving the data in the load and of initiating the shutdown of the equipment connected to the UPS..

5.1 RS-232 port

The UPS has an RS-232 port for UPS monitoring, control and firmware updates. To establish communication between the UPS and a computer, connect one end of the serial communication cable to the RS-232 port on the UPS and the other end to the RS-232 port of a computer.

The cable pins for the RS-232 communication port are described in Figure 39 and in Table 9.

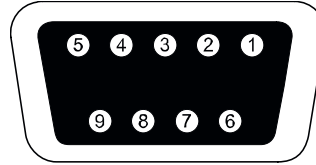

Figure 39: RS-232 Communication Port (DB-9 Connector)

Pin	Signal Name	Function	Direction from UPS
1	DCD	Battery low signal	Out
2	RxD	Transmit to external device	Out
3	TxD	Receive from external device	In
4	DTR	PnP from external device	In
5	GND	Signal common	--
6	DSR	To external device	Out
7	RTS	No connection	In
8	CTS	On battery signal	Out
9	RI	V _{DC} power	Out

Table 9: Communication port pin assignment

5.2 USB port

The UPS can communicate with USB-compliant computers that run power management software. To establish communication between the UPS and a computer, connect the USB cable to the USB port on the UPS. Connect the other end of the cable to the USB port on a computer.

5.3 Network management card (Optional)

PowerValue 11 RT is equipped with an intelligent slot for optional cards for remote management of the UPS through internet/intranet. Either of the following accessories can be installed in the intelligent slot:

- **SNMP Card** – SNMP, HTTP and monitoring capabilities through a Web browser interface.
- **AS400 Card** – AS400 card for AS400 communication protocol.

5.3.1 Installing a serial network management card (optional)

Each UPS has a communication slot for an optional serial network management (SNMP) card. After installing an SNMP card, an environmental monitoring probe can be connected to the UPS.



NOTE

THE UPS DOES NOT HAVE TO BE SHUTDOWN BEFORE INSTALLING A COMMUNICATION CARD.

To install a network management card:

1. Remove the two screws that protect the communication slot of the UPS.
2. Insert the SNMP card into the communication slot.
3. Screw the SNMP card onto the slot using the screws removed in step 1.

Compatible SNMP cards: CS141 Basic, CS141 ModBus, CS141 Advanced, WinPower

For more information on the SNMP Cards, see the SNMP user's manual. For more details about parameters available when using an SNMP card with PowerValue 11 RT, see Appendix A and B.

5.3.2 Monitoring Software

The UPS can be monitored using software. The software provides a remote and safe shutdown for multi-client systems in case of absence of power in the output of the UPS. Instructions on how to install the software are provided with the network management cards.

For more information, contact your local supplier.

6 Troubleshooting

6.1 Fault identification and rectification

Alarms and events indicate warnings and notify of errors or potential failures in the system. The output of the UPS is not necessarily affected in case of an alarm but taking the correct actions may prevent loss of power to the load.

6.2 Accessing Alarms

The control panel provides troubleshooting information from two main menus:





- UPS status menu: Access to all active alarms
- Event Log menu: Access to the most recent 50 events, which may include active and closed alarms

UPS status menu

From the UPS Status menu, you can access the following screens for troubleshooting information:

- **Status summary:** The status summary screen provides information on both operation-mode and load. During normal operation the display has a blue background with white text. In case of a critical alarm, the backlight color changes to orange with dark text.
- **Alarm:** A separate screen appears for each active notice or alarm.
- **Battery status:** The battery status screen indicates the battery charge-mode, the percentage of the battery that is charged and runtime with the present load.

To access troubleshooting information using the UPS status menu screen:





1. Press  for longer than 1 second to go to the UPS status menu screen.
2. Press  to access the UPS Status main screen.
3. Press  to access the notice and alarm screens.
4. The UPS Status main screen shows load information. The status icon indicates the UPS operating-mode.
5. Press  to scroll through the notice and alarm information.
6. After scrolling through all alarms, press  to access the battery status screen.

Event log menu

From the Event Log menu, you can access the latest 50 alarms, events and notices, arranged from newest to oldest. Events and alarms are logged in the Event Log when they occur and, if applicable, when they are cleared:

- Events are silent conditions that are recorded in the Event Log as status information. Events do not require a response.
- Alarms, including active alarms, are recorded in the Event Log. Active alarms are announced by either an intermittent beep or a continuous sound. Examples are “Fan locked” and “Heat sink temperature high.” Active alarms require a response.

To access troubleshooting information using the Event Log menu:

1. Press  for one second to go to the main menu selection and scroll down to the Event Log menu using .
2. Press  to enter the Event Log list.
3. Scroll through the listed events, notices, and alarms using  or .



NOTE

THE MOST RECENT EVENTS ARE DISPLAYED ON TOP OF THE LIST (FOR EXAMPLE 1/50).

Alarm or Event	Possible cause	Remedy
Utility Abnormal Alarm Code: 02	The input mains is out of the UPS tolerance range	Check input mains condition
Site Wiring Fault Alarm Code: 04	Site Fault detection is supported on all-models when a Grounding Neutral connection is present. Alarm will trigger when the difference between ground and neutral voltage is >15V.	Site Fault detection should be enabled by default. It can be enabled / disabled from the LCD settings menu. Reconnect all input wires
Battery Disconnect Alarm Code:11	Battery voltage is lower than the batteries disconnected level defined for this UPS. There could be a blown fuse, intermittent battery connection or disconnected battery cable.	Verify that all batteries are properly connected. If the condition persists, contact your service representative
Battery low Alarm Code:12	The UPS is in battery-mode and the battery autonomy is running low.	This warning is approximate and the actual time to shut down may vary. Depending on the UPS load and the number of external battery modules (EXBAT), the "Battery Low" warning may occur before the batteries reach 25% capacity
Service Battery Alarm Code:13	A battery string failure has been detected and the battery charger has been disabled until its replacement	Contact your service representative
Charger Fail Alarm Code:15	Indicates a charger failure	The UPS charger is turned off until the next startup. Contact your service representative
Battery Over Voltage Alarm Code:16	Indicates that the battery voltage is too high	The UPS will turn off the charger until the battery voltage is normal
BUS Over Voltage Alarm Code:21	Indicates an over voltage in the BUS of the UPS.	The UPS transfers to Bypass-mode if supporting the load
BUS Under Voltage Alarm Code:22	Indicates an under voltage in the BUS of the UPS.	The UPS transfers to Bypass-mode if supporting the load
BUS Unbalance Alarm Code:23	Indicates that the positive BUS voltage and negative BUS voltage are not symmetric	The UPS transfers to Bypass-mode if supporting the load
BUS Short Alarm Code:24	Indicates that the BUS voltage decreases very fast	Contact your service representative
BUS Softstart Fail Alarm Code:25	Indicates that the BUS could not perform a soft start successfully	Contact your service representative
Output Short Circuit Alarm Code:31	Indicates that the UPS has detected abnormally low impedance placed on its output (considered as a short circuit)	Remove all the loads. Turn off the UPS. Check if UPS output and loads are short circuited. Ensure short circuits are removed before turning the UPS on again.
Inv Over Voltage Alarm Code:32	Indicates an inverter over voltage	The UPS transfers to bypass-mode if supporting the load
Inv Under Voltage Alarm Code:33	Indicates an inverter under voltage	The UPS transfers to bypass-mode if supporting the load
Inv Softstart Fail Alarm Code:34	Indicates that the inverter could not perform a soft start successfully	Contact your service representative
Output Overload Alarm Code:41	Output is in overload.	Remove some of the load from the UPS. The UPS continues to operate, but may switch to bypass-mode or shutdown if the load increases. The alarm resets when the condition becomes inactive.
Inv Overload Fault Alarm Code:42	UPS has been transferred to bypass or fault-mode caused by a high overload in inverter-mode	The UPS transfers to battery-mode if supporting the load. Remove some of the load from the UPS
Byp Overload Fault Alarm Code:43	UPS has cut off the output and transferred to fault-mode because of overload in bypass-mode or HE-mode.	Remove some of the load from the UPS
Battery-mode Alarm Code: 62	A utility failure has occurred and the UPS is in battery-mode.	The UPS is running in battery-mode. Prepare your equipment for shutdown.
Eco-mode Alarm Code: 63	The UPS is on bypass while operating on the High Efficiency setting.	The equipment operated in bypass as standard when in High Efficiency operation. Battery-mode is available and your equipment is protected.
EPO Active Alarm Code: 71	The external contacts in the rear of the UPS are configured for EPO operation and they have been activated.	Check the EPO connector status
ON Maintenance Bypass Alarm Code: 72	UPS was manually switched to bypass and will remain in bypass until manually transferred out of bypass	Check the maintain bypass switch status
Heat sink Over Temperature Alarm Code: 81	Indicates that the temperature of heat sink is too high indicating an over temperature of the UPS.	Transfer the UPS to Bypass-mode. If the condition persists, shut down the UPS. Clear vents and remove any heat sources. Allow the UPS to cool. Ensure the airflow around the UPS is not obstructed. Restart the UPS.

Alarm or Event	Possible cause	Remedy
Ambient Over Temperature Alarm Code:82	Indicates that the ambient temperature is higher than the operation temperature on specification	Change the positioning of the UPS or use an adequate air conditioning system.
Fan Failure Alarm Code:84	Indicates that the fan is not working properly.	Check fans of UPS
Back feed Alarm Code:93	UPS has an unexpected bypass current on battery-mode	Transfer to maintenance bypass and call service.
Fatal Eeprom Fault Alarm Code:A3	Indicates that the UPS could not read the Eeprom successfully	Contact your service representative
Negative power Fault Alarm Code: E1	Parallel system: power from one UPS flows from the parallel output into the other UPS in the system (negative power)	If the parallel system is in redundant-mode, only the UPS with the failure will transfer to fault-mode without output. Other UPS will still support the load. If the parallel system is not redundant and the load cannot be supported by the other UPS, all units in the parallel system will transfer to fault-mode.
Parallel cable loss Alarm Code: E2	Parallel system: Parallel cable disconnected	Connect the parallel cable
Parallel system battery status Alarm Code: E6	UPS1 batteries connected, UPS2 batteries disconnected	Check battery connections
Line input different Alarm Code: E7	Parallel system: UPS1 line ok, UPS2 line lost	Check the input line

Always have the following information available when calling the after-sales service department:

1. Model number and serial number
2. Date on which the problem occurred
3. LCD/LED display information and buzzer alarm status
4. Mains power condition, load type and capacity, environment temperature and ventilation condition
5. Information on external battery pack (battery capacity, quantity)

Appendix A

CS141 SNMP card available parameters (valid for CS141 Basic, CS141 ModBus, CS141 Advanced).

The parameters available for CS141 SNMP cards are shown below.

Parameter	Units	Type	Available interface	Modbus register
Measurement Parameters				
Input Voltage	V	Input	Webserver / Modbus	104
Input Frequency	Hz	Input	Webserver / Modbus	111
Output Voltage	V	Output	Webserver / Modbus	97
Output Load Percentage	%	Output	Webserver / Modbus	100
Battery Voltage	V	Battery	Webserver / Modbus	110
Battery Capacity	%	Battery	Webserver / Modbus	103
Temperature	°C	Environmental	Webserver / Modbus	107
UPS Status Information				
On shutdown			Webserver / Modbus	109
On inverter			Webserver / Modbus	109
On battery			Webserver / Modbus	109
UPS Alarms				
Battery Low			Webserver / Modbus	117
Input Bad			Webserver / Modbus	120
On Bypass			Webserver / Modbus	123
General Fault			Webserver / Modbus	132
Test In Progress			Webserver / Modbus	138
Shutdown imminent			Webserver / Modbus	137
Diagnose test failed			Webserver / Modbus	133

Appendix B

Winpower SNMP card available parameters (webserver interface)

The parameters available from WinPower SNMP cards are shown below.

Parameter	Type	View
UPS Status	General, status	UPS Monitoring >> UPS Status
UPS Temperature	General, measurement	UPS Monitoring >> UPS Status
Voltage	Input, measurement	UPS Monitoring >> UPS Status
Frequency	Input, measurement	UPS Monitoring >> UPS Status
Load (%)	Output, measurement	UPS Monitoring >> UPS Status
Voltage	Output, measurement	UPS Monitoring >> UPS Status
Frequency	Output, measurement	UPS Monitoring >> UPS Status
Battery Status	Battery, status	UPS Monitoring >> UPS Status
Capacity (%)	Battery, measurement	UPS Monitoring >> UPS Status
Voltage	Battery, measurement	UPS Monitoring >> UPS Status
Time on Battery	Battery, measurement	UPS Monitoring >> UPS Status
Output Rating Voltage	Output, Rating	UPS Monitoring >> UPS Parameters
Output Frequency Rating	Output, Rating	UPS Monitoring >> UPS Parameters
Output Rating VA	Output, Rating	UPS Monitoring >> UPS Parameters
UPS Model	Additional UPS Information	UPS Monitoring >> UPS Identification
UPS Description	Additional UPS Information	UPS Monitoring >> UPS Identification
Firmware Version	Additional Network card Information	UPS Monitoring >> UPS Identification
MAC Address	Additional Network card Information	UPS Monitoring >> UPS Identification

Appendix C: External Battery Modules (EBM) value calculation

Introduction

The battery configuration is described in the following way:
“number of battery strings” x (“number of 12V battery blocks”
x “battery capacity”)

UPS internal battery configuration

UPS Model	Battery configuration
UPS PowerValue 11 RT 6 kVA	no internal
UPS PowerValue 11 RT 10 kVA	no internal

External Battery Module (EBM) battery configuration

EBM	Battery configuration
EBM for PowerValue 11 RT 6 kVA	1 x (15 x 9.0Ah)
EBM for PowerValue 11 RT 10 kVA	1 x (20 x 9.0Ah)

Standard EBM value setting through LCD display and RS232
(M is the total nr of standard EBM connected, $M \geq 1$)

UPS Model	LCD display (path: Settings → Password (USER) → External battery modules)	RS232 (command: SASV03[value]<cr>
PowerValue 11 RT 6 kVA	$M * 9 / 5 - 1$	$M * 9 / 5$
PowerValue 11 RT 10 kVA	$M - 1$	M

Settings with a customized battery pack of N Ah capacity,
through LCD display and RS232 (take only the integer part)

UPS Model	LCD display (path: Settings → Password (USER) → External battery modules)	RS232 (command: SASV03[value]<cr>
PowerValue 11 RT 6 kVA	$N / 5 - 1$	N/5
PowerValue 11 RT 10 kVA	$N / 9 - 1$	N/9

Contact us

www.abb.com/ups
ups.sales@ch.abb.com

© Copyright ABB. All rights reserved.
Specification subjects to change without notice.



614-00798-03

