

# Multifunctional three-phase monitoring relays

## CM-MPS

### CM-MPS.43

The three-phase monitoring relay CM-MPS.43 monitors the phase parameters phase sequence, phase failure, over- and undervoltage as well as phase unbalance.

The device can be used for mains with a frequency of 45-440 Hz and is available with two different terminal versions. You can choose between the proven screw connection technology (double-chamber cage connection terminals) and the completely tool-free Easy Connect Technology (push-in terminals).

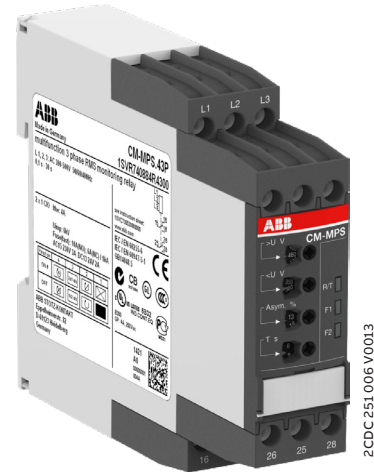

## Characteristics

- Monitoring of three-phase mains for phase sequence (can be switched off), phase failure, over- and undervoltage as well as phase unbalance
- Suitable for railway applications
- TRMS measuring principle
- Automatic phase sequence correction configurable
- Can be used for mains with a frequency of 45 to 440 Hz
- Threshold values for over- and undervoltage as well as phase unbalance are adjustable as absolute values
- Tripping delay  $T_V$  can be adjusted or switched off by means of a logarithmic scale (0 s; 0,1-30 s)
- ON-delayed or OFF-delayed tripping delay selectable
- Powered by the measuring circuit
- Precise adjustment by front-face operating controls
- Screw connection technology or Easy Connect Technology available
- Housing material for highest fire protection classification UL 94 V-0
- Tool-free mounting on DIN rail as well as demounting
- 1 x 2 or 2 x 1 c/o (SPDT) contacts configurable
- 22.5 mm (0.89 in) width
- 3 LEDs for the indication of operational states

## Order data

### Three-phase monitoring relays

Type	Rated control supply voltage = measuring voltage	Connection technology	Order code
CM-MPS.43P	3 x 300-500 V AC	Push-in terminals	1SVR740884R4300
CM-MPS.43S		Screw terminals	1SVR730884R4300

### Accessories

Type	Description	Order code
ADP.01	Adapter for screw mounting	1SVR430029R0100
MAR.12	Marker label for devices with DIP switches	1SVR730006R0000
COV.11	Sealable transparent cover	1SVR730005R0100

# Connection technology

Maintenance free Easy Connect Technology with push-in terminals

Type designation CM-xxS.yyP

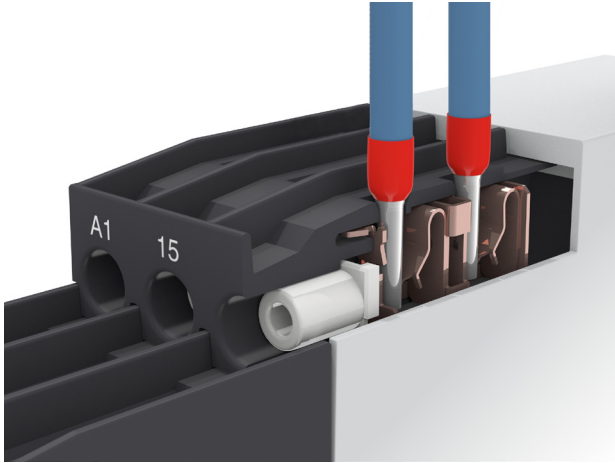

## Push-in terminals

- Tool-free connection of rigid and flexible wires with wire end ferrule
- Easy connection of flexible wires without wire end ferrule by opening the terminals
- No retightening necessary
- One operation lever for opening both connection terminals
- For triggering the lever and disconnecting of wires you can use the same tool (Screwdriver according to DIN ISO 2380-1 Form A 0.8 x 4 mm (0.0315 x 0.157 in), DIN ISO 8764-1 PZ1  $\varnothing$  4.5 mm (0.177 in))
- Constant spring force on terminal point independent of the applied wire type, wire size or ambient conditions (e. g. vibrations or temperature changes)
- Opening for testing the electrical contacting
- Gas-tight

Approved screw connection technology with double-chamber cage connection terminals

Type designation CM-xxS.yyS

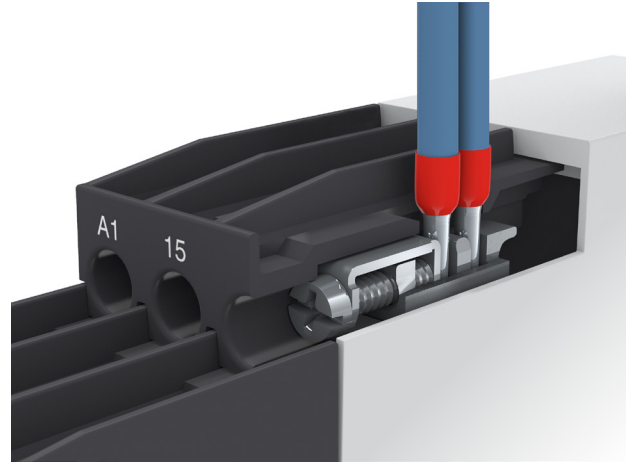

## Double-chamber cage connection terminals

- Terminal spaces for different wire sizes
- One screw for opening and closing of both cages
- Pozidrive screws for pan- or crosshead screwdrivers according to DIN ISO 2380-1 Form A 0.8 x 4 mm (0.0315 x 0.157 in), DIN ISO 8764-1 PZ1  $\varnothing$  4.5 mm (0.177 in)

Both the Easy Connect Technology with push-in terminals and screw connection technology with double-chamber cage connection terminals have the same connection geometry as well as terminal position.

# Functions

## Operating controls

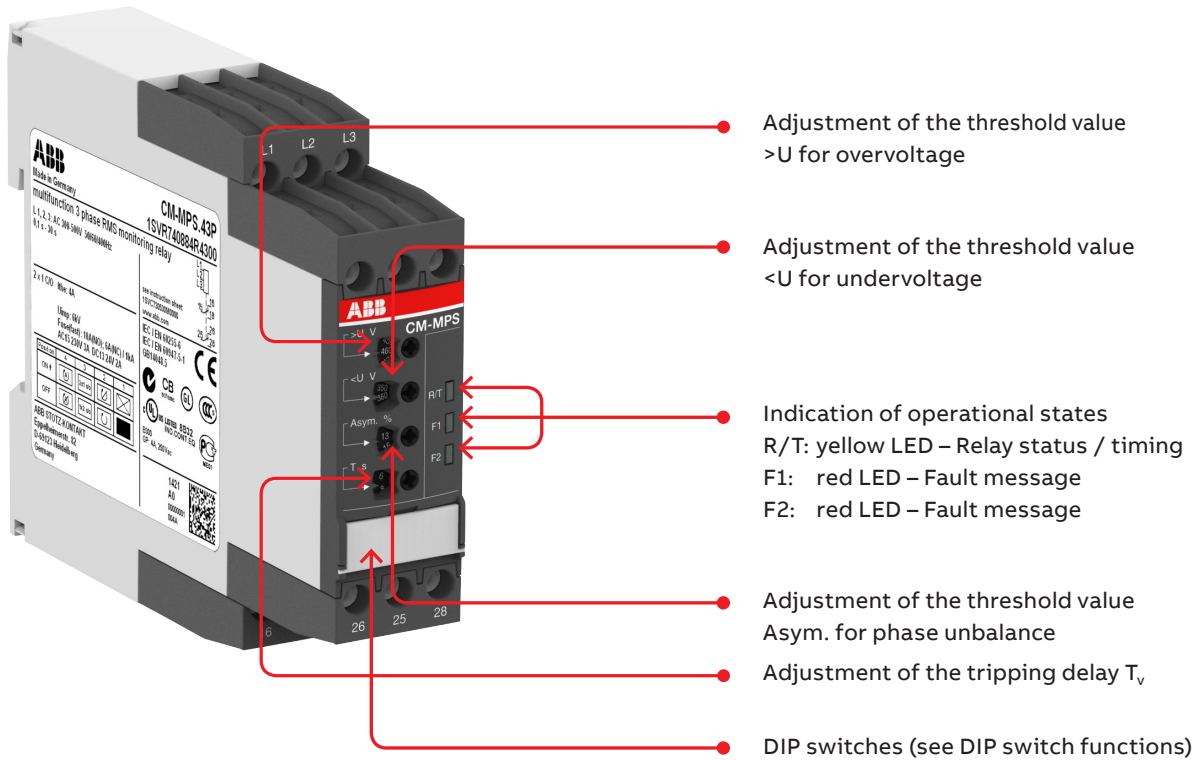

## Application

The three-phase monitoring relay CM-MPS.43 is designed for use in three-phase mains for monitoring the phase parameters phase sequence, phase failure, over- and undervoltage as well as phase unbalance. The device can be used for mains with a frequency of 45-440 Hz.

The CM-MPS.43 provides an adjustable tripping delay and works according to the closed-circuit principle.

## Operating mode

The unit is adjusted with front-face operating controls. The selection of ON-  or OFF-  delay, phase sequence monitoring activated  or phase sequence monitoring deactivated , 2 x 1 c/o  or 1 x 2 c/o  (SPDT) contacts as well as automatic phase sequence correction activated  or automatic phase sequence correction deactivated  is made with DIP switches. Potentiometers, with direct reading scale, allow the adjustment of the threshold values for overvoltage (>U), undervoltage (<U), phase unbalance (Asym %) and the tripping delay  $T_v$ . The tripping delay  $T_v$  is adjustable with a range from instantaneous to a 30 s delay. Timing is displayed by a flashing yellow LED labelled R/T.

For monitoring single-phase mains, all three external conductors (L1, L2, L3) have to be jumpered and connected as one single conductor. Phase sequence monitoring has to be deactivated and the threshold value for phase unbalance has to be set to the maximum (25 %).

# Adjustment potentiometer

## Threshold values

By means of three separate potentiometers with direct reading scales, the threshold values for over- and undervoltage as well as for phase unbalance can be adjusted within the measuring range.















Measuring range for overvoltage	Measuring range for undervoltage	Measuring range for phase unbalance
3 x 420-500 V AC	3 x 300-380 V AC	2-25 % of average of phase voltages

## Tripping delay $T_v$

The tripping delay  $T_v$  can be adjusted within a range of 0.1 to 30 s by means of a potentiometer with logarithmic scale. By turning to the left stop, the tripping delay can be switched off.

# Indication of operational states

## LEDs, status information and fault messages

Operational state	R/T: LED yellow	F1: LED red	F2: LED red
Control supply voltage applied, output relay energized		-	-
Tripping delay $T_v$ active		-	-
Phase failure	-		
Phase sequence	-	 alternating	
Overvoltage	-		-
Undervoltage	-	-	
Phase unbalance	-		
Interruption of the neutral	-		
Adjustment error <sup>1)</sup>			

<sup>1)</sup>

Possible misadjustments of the front-face operating controls:

Overlapping of the threshold values: The threshold value for overvoltage is set to a smaller value than the threshold value for undervoltage.

DIP switch 3 = OFF and DIP switch 4 = ON: Automatic phase sequence correction is activated and selected operating mode is 1 x 2 c/o (SPDT) contacts  
DIP switch 2 and 4 = ON: Phase sequence detection is deactivated and the automatic phase sequence correction is activated.

# Function descriptions / diagrams

## Phase sequence and phase failure monitoring

Applying control supply voltage begins the fixed start-up delay  $T_s$ . When  $T_s$  is complete and all phases are present with correct voltage, the output relays energize and the yellow LED R/T is on.

### Phase sequence monitoring

If phase sequence monitoring is activated (DIP switch 2 = OFF), the output relays de-energize as soon as a phase sequence error occurs. The fault is displayed by alternated flashing of the LEDs F1 and F2. The output relays re-energize automatically as soon as the phase sequence is correct again.

If phase sequence monitoring is deactivated (DIP switch 2 = ON), a phase sequence error will not cause tripping of the relays. The output relays do not change state and the LEDs F1 and F2 don't flash.

### Phase failure monitoring:

The output relays de-energize instantaneously if a phase failure occurs. The fault is indicated by lighting up of LED F1 and flashing of LED F2. The output relays re-energize automatically as soon as the voltage returns to the tolerance range.

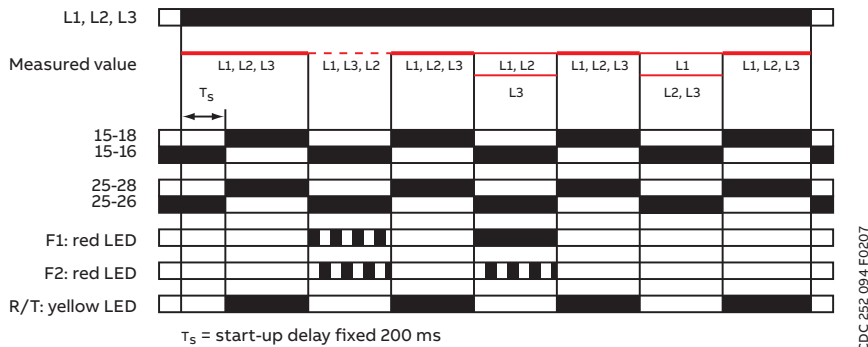

## Over- and undervoltage monitoring 1 x 2 c/o (SPDT) contacts 1x2 c/o

Applying control supply voltage begins the fixed start-up delay  $T_s$ . When  $T_s$  is complete and all phases are present with correct voltage and with correct phase sequence, the output relays energize and the yellow LED R/T is on.

### Type of tripping delay = ON-delay ON-delay

If the voltage to be monitored exceeds or falls below the set threshold value, the output relays de-energize after the set tripping delay  $T_v$  is complete. The LED R/T flashes during timing and turns off as soon as the output relays de-energize. The output relays re-energize automatically as soon as the voltage returns to the tolerance range, taking into account a fixed hysteresis of 5 %. The LED R/T is on.

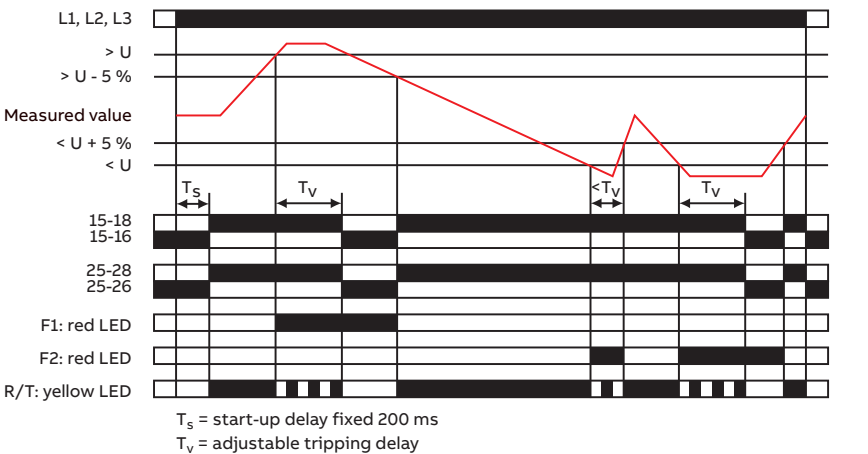

**Type of tripping delay = OFF-delay** ■

If the voltage to be monitored exceeds or falls below the set threshold value, the output relays de-energize instantaneously and the LED R/T turns off.

As soon as the voltage returns to the tolerance range, taking into account a fixed hysteresis of 5 %, the output relays re-energize automatically after the set tripping delay  $T_v$  is complete. The LED R/T flashes during timing and turns steady when timing is complete.

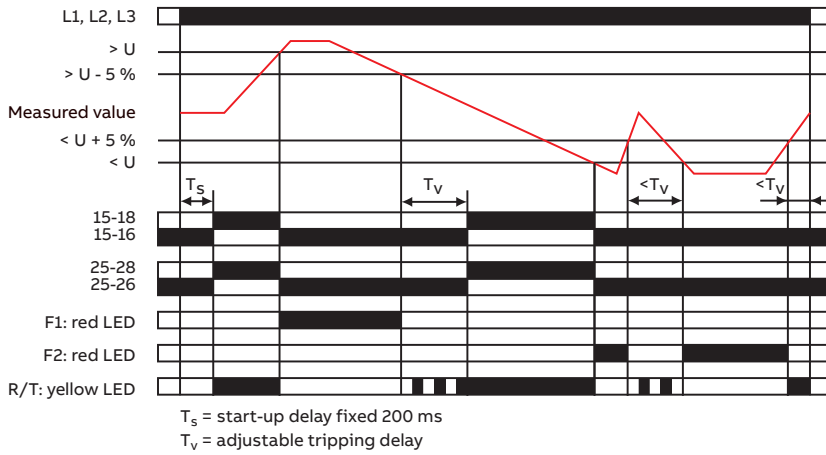

2CDC 252 091 F0207

**Over- and undervoltage monitoring 2 x 1 c/o (SPDT) contacts** 2x1 c/o

Applying control supply voltage begins the fixed start-up delay  $T_s$ . When  $T_s$  is complete and all phases are present with correct voltage and with correct phase sequence, the output relays energize. The yellow LED R/T is on as long as at least one output relay is energized.

**Type of tripping delay = ON-delay** ☒

If the voltage to be monitored exceeds or falls below the set threshold value, output relay R1 (overvoltage) or output relay R2 (undervoltage) de-energizes after the set tripping delay  $T_v$  is complete. The LED R/T flashes during timing.

The corresponding output relay re-energizes automatically as soon as the voltage returns to the tolerance range, taking into account a fixed hysteresis of 5 %.

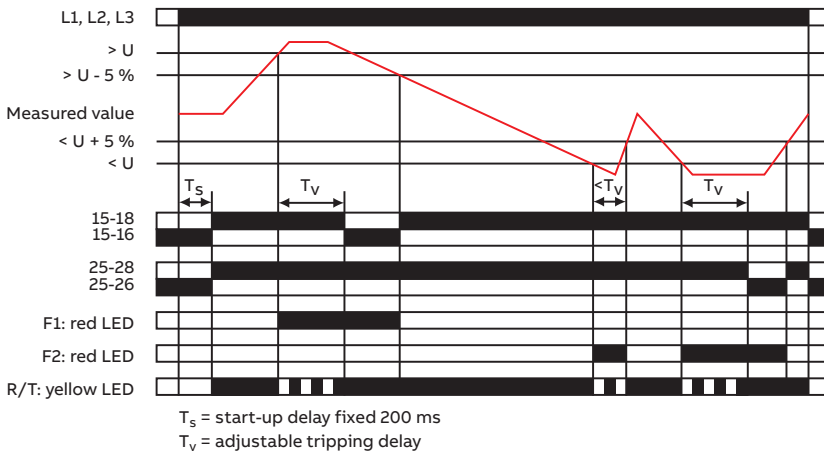

2CDC 252 006 F0207

**Type of tripping delay = OFF-delay** ■

If the voltage to be monitored exceeds or falls below the set threshold value, output relay R1 (overvoltage) or output relay R2 (undervoltage) de-energizes instantaneously.

As soon as the voltage returns to the tolerance range, taking into account a fixed hysteresis of 5 %, the corresponding output relay re-energizes automatically after the set tripping delay  $T_v$  is complete. The LED R/T flashes during timing.

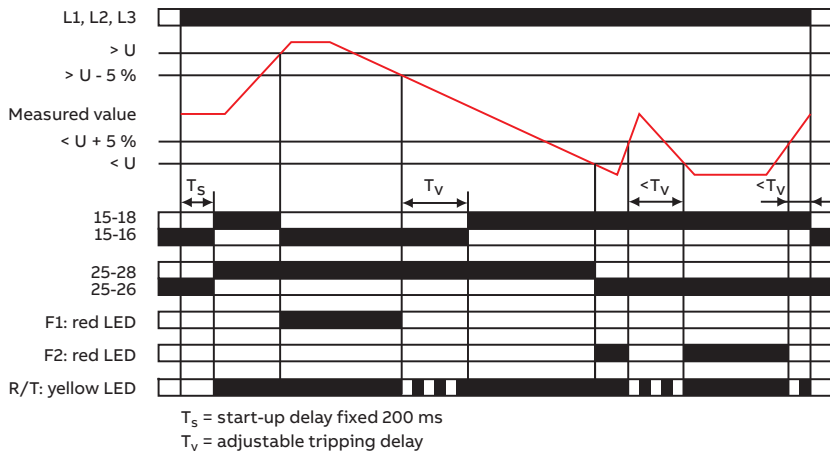

**Phase unbalance monitoring**

Applying control supply voltage begins the fixed start-up delay  $T_s$ . When  $T_s$  is complete and all phases are present with correct voltage and with correct phase sequence, the output relays energize and the yellow LED R/T is on.

**Type of tripping delay = ON-delay**  

If the voltage to be monitored exceeds or falls below the set phase unbalance threshold value, the output relays de-energize after the set tripping delay  $T_v$  is complete. The LED R/T flashes during timing and turns off as soon as the output relays de-energize.

The output relays re-energize automatically as soon as the voltage returns to the tolerance range, taking into account a fixed hysteresis of 20 %. The LED R/T is on.

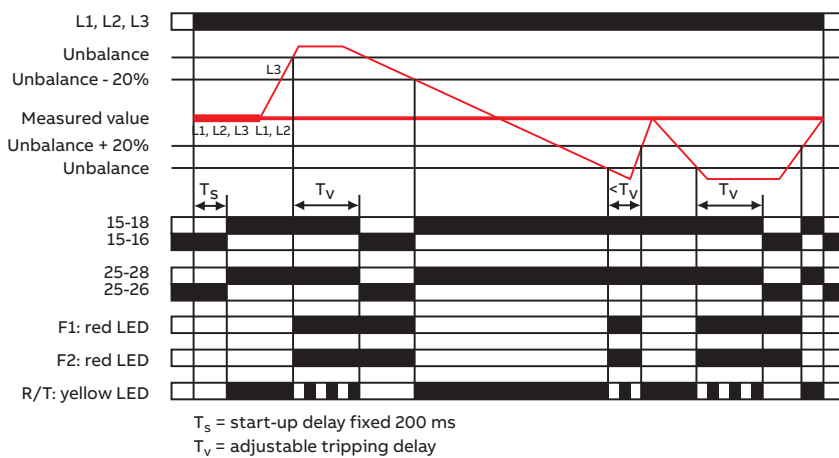

**Type of tripping delay = OFF-delay**

If the voltage to be monitored exceeds or falls below the set phase unbalance threshold value, the output relays de-energize instantaneously and the LED R/T turns off.

As soon as the voltage returns to the tolerance range, taking into account a fixed hysteresis of 20 %, the output relays re-energize automatically after the set tripping delay  $T_V$  is complete. The LED R/T flashes during timing and turns steady when timing is complete.

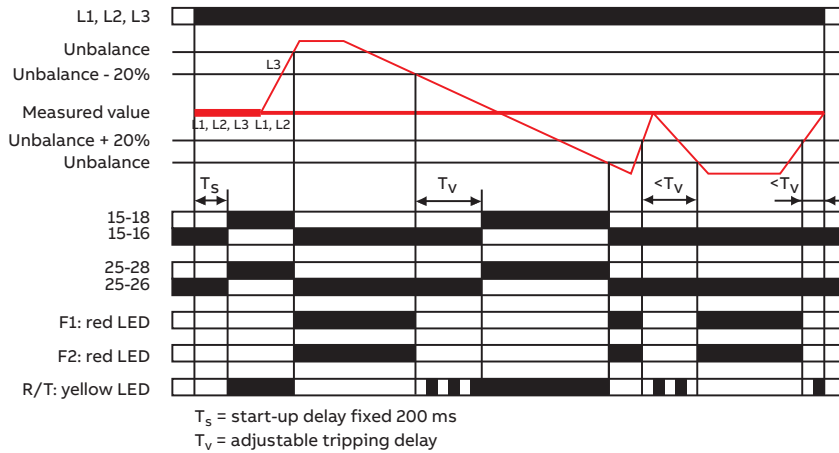

2CDC 252 093 F0207

**Automatic phase sequence correction**

This function can be selected only if phase sequence monitoring is activated  (DIP switch 2 = ON) and operating mode 2 x 1 c/o (SPDT) contact  is selected (DIP switch 3 = OFF).

Applying control supply voltage begins the fixed start-up delay  $T_{s1}$ . When  $T_{s1}$  is complete and all phases are present with correct voltage, output relay R1 energizes. Output relay R2 energizes when the fixed start-up delay  $T_{s2}$  is complete and all phases are present with correct phase sequence. Output relay R2 remains de-energized if the phase sequence is incorrect. If the voltage to be monitored exceeds or falls below the set threshold values for phase unbalance, over- or undervoltage or if a phase failure occurs, output relay R1 de-energizes and the LEDs F1 and F2 indicate the fault.

Output relay R2 is responsive only to a false phase sequence. In conjunction with a reversing contactor combination, this enables an automatic correction of the rotation direction. See circuit diagrams.

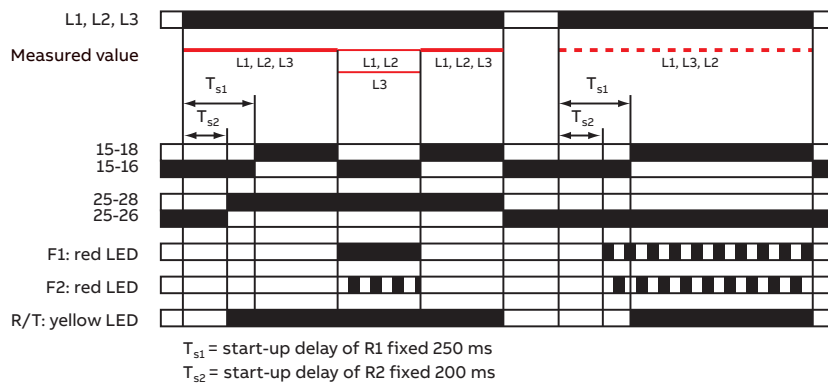

2CDC 252 085 F0107

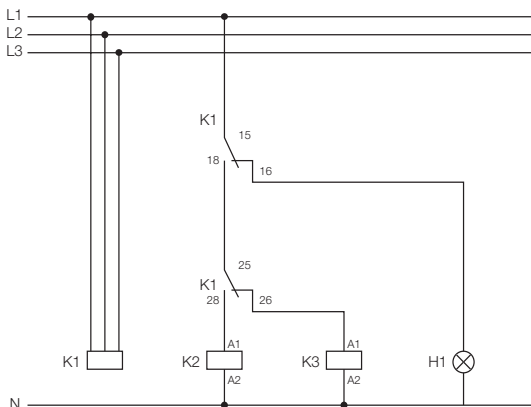

Control circuit diagram (K1 = CM-MPS.43)

2CDC 253 009F0014

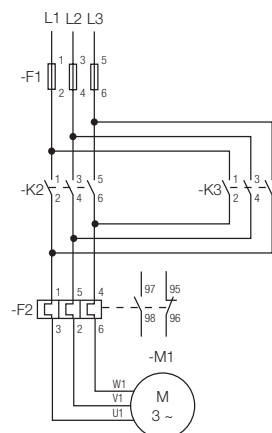

Power circuit diagram

2CDC 252 087 F0b07



# Electrical connection

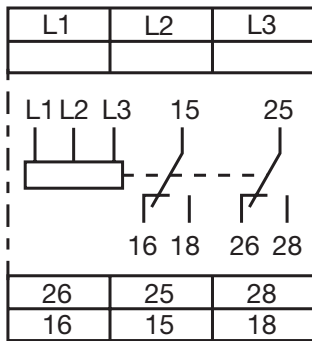

L1, L2, L3      Control supply voltage = measuring voltage  
 15-16/18      Output contacts - closed-circuit principle  
 25-26/28

2CDC 252 037 F0008

Connection diagram CM-MPS.43

# DIP switches

Position	4	3	2	1
ON ↑		2x1 c/o		
OFF		1x2 c/o		

2CDC 252 041 F0008

1 Timing function	ON	ON-delayed : In case of a fault, the de-energizing of the output relays and the respective fault message are suppressed for the adjusted tripping delay $T_v$ .
	OFF	OFF-delayed : In case of a fault, the output relays de-energize instantaneously and a fault message is displayed and stored for the length of the adjusted tripping delay $T_v$ . Thereby, also momentary undervoltage conditions are recognized.
2 Phase sequence monitoring	ON	Phase sequence monitoring deactivated : Phase sequence errors will not cause tripping of the relays.
	OFF	Phase sequence monitoring activated : The output relays de-energize as soon as a phase sequence error occurs. The output relays re-energize automatically as soon as the phase sequence is correct again.
3 Operating principle of the output relays	ON	2x1 c/o (SPDT) contact : Depending on the configuration of automatic phase sequence correction and on the fault type, the output relays R1 (15-16/18) and R2 (25-26/28) react differently, if operating principle 2x1 c/o (SPDT) contact is selected. Automatic phase sequence correction deactivated : <ul style="list-style-type: none"> <li>Overvoltage: only 1st c/o (SPDT) contact R1 (15-16/18) switches</li> <li>Undervoltage: only 2nd c/o (SPDT) contact R2 (25-26/28) switches</li> <li>Phase unbalance, phase sequence, phase failure, interrupted neutral: both output relays R1 (15-16/18) and R2 (25-26/28) react synchronously</li> </ul> Automatic phase sequence correction activated : <ul style="list-style-type: none"> <li>Overvoltage, undervoltage, phase unbalance, phase failure, interrupted neutral: only 1st c/o (SPDT) contact R1 (15-16/18) switches</li> <li>Phase sequence: only 2nd c/o (SPDT) contact R2 (25-26/28) switches</li> </ul> Operating principle 2x1 c/o (SPDT) contact is mandatory if automatic phase sequence correction is activated.
	OFF	1x2 c/o (SPDT) contacts : If operating principle 1x2 c/o (SPDT) contacts is selected, both output relays R1 (15-16/18) and R2 (25-26/28) react synchronously, independent of the fault type.
4 Automatic phase sequence correction	ON	Phase sequence correction activated : In conjunction with a reversing contactor combination, it is ensured that the correct phase sequence is applied to the input terminals of the load.
	OFF	Phase sequence correction deactivated : No automatic phase sequence correction in case of phase sequence error.

# Technical data

Data at  $T_a = 25\text{ °C}$  and rated values, unless otherwise indicated

## Input circuit

Type	CM-MPS.43
Supply circuit = measuring circuit	L1, L2, L3
Rated control supply voltage $U_s$ = measuring voltage	3 x 300-500 V AC
Rated control supply voltage $U_s$ tolerance	-15...+10 %
Rated frequency	50/60/400 Hz
Frequency range	45-440 Hz
Typical current / power consumption	5 mA / 4 VA (400 V AC)

Measuring circuit	L1, L2, L3	
Monitoring functions	Phase failure	■
	Phase sequence	can be switched off
	Automatic phase sequence correction	configurable
	Over-/undervoltage	■
	Phase unbalance	■
	Interrupted neutral	■
Measuring range	Overvoltage	3 x 420-500 V AC
	Undervoltage	3 x 300-380 V AC
	Phase unbalance	2-25 % of average of phase voltages
Thresholds	Overvoltage	adjustable within measuring range
	Undervoltage	adjustable within measuring range
	Phase unbalance (switch-off value)	adjustable within measuring range
Tolerance of the adjusted threshold value	6% of full-scale value	
Hysteresis related to the threshold value	Over-/undervoltage	fixed 5 %
	Phase unbalance	fixed 20 %
Rated frequency of the measuring signal	50/60/400 Hz	
Frequency range of the measuring signal	45-440 Hz	
Maximum measuring cycle time	100 ms	
Accuracy within the rated control supply voltage tolerance	$\Delta U \leq 0.5\%$	
Accuracy within the temperature range	$\Delta U \leq 0.06\% / \text{°C}$	
Measuring method	True RMS	

Timing circuit	
Start-up delay $T_s$ and $T_{s2}$	fixed 200 ms
Start-up delay $T_{s1}$	fixed 250 ms
Tripping delay $T_v$	ON- or OFF-delay 0 s; 0.1-30 s adjustable
Repeat accuracy (constant parameters)	$< \pm 0.2\%$
Accuracy within the rated control supply voltage tolerance	$\Delta t \leq 0.5\%$
Accuracy within the temperature range	$\Delta t \leq 0.06\% / \text{°C}$

## User interface

Indication of operational states		
Relay status / timing	R/T	yellow LED
Fault message	F1	red LED
Fault message	F2	red LED

Details see table 'LEDs, status information and fault messages' on page 4 and 'Function descriptions / diagrams' on page 5.

## Output circuits

		15-16/18, 25-26/28
Kind of output	15-16/18 25-26/28	relays, 1 x 2 or 2 x 1 (SPDT) contact(s) configurable
Operating principle		closed-circuit principle <sup>1)</sup>
Contact material		AgNi alloy, Cd free
Rated operational voltage U <sub>e</sub>		250 V
Minimum switching voltage / Minimum switching current		24 V / 10 mA
Maximum switching voltage / Maximum switching current		see load limit curves
Rated operational current I <sub>e</sub>	AC-12 (resistive) at 230 V	4 A
	AC-15 (inductive) at 230 V	3 A
	DC-12 (resistive) at 24 V	4 A
	DC-13 (inductive) at 24 V	2 A
AC rating (UL 508)	Utilization category (Control Circuit Rating Code)	B 300
	max. rated operational voltage	300 V AC
	max. continuous thermal current at B 300	5 A
	max. making/breaking apparent power at B 300	3600/360 VA
Mechanical lifetime		30 x 10 <sup>6</sup> switching cycles
Electrical lifetime	AC-12, 230 V, 4 A	0.1 x 10 <sup>6</sup> switching cycles
Maximum fuse rating to achieve short-circuit protection	n/c contact	6 A fast-acting
	n/o contact	10 A fast-acting

## General data

MTBF		on request	
Duty time		100 %	
Dimensions		see 'Dimensional drawings'	
Weight		<b>Screw connection technology</b>	<b>Easy Connect Technology (push-in)</b>
	net weight	0.148 kg (0.327 lb)	0.137 kg (0.302 lb)
	gross weight	0.173 kg (0.381 lb)	0.162 kg (0.357 lb)
Mounting		DIN rail (IEC/EN 60715), snap-on mounting without any tool	
Mounting position		any	
Minimum distance to other units	horizontal	10 mm (0.39 in)	
Material of housing		UL 94 V-0	
Degree of protection	housing	IP50	
	terminals	IP20	

<sup>1)</sup> Closed-circuit principle: Output relay(s) de-energize(s) if measured value exceeds or falls below the adjusted threshold value.

## Electrical connection

		Screw connection technology	Easy Connect Technology (push-in)
Connecting capacity	fine-strand with(out) wire end ferrule	1 x 0.5-2.5 mm <sup>2</sup> (1 x 18-14 AWG) 2 x 0.5-1.5 mm <sup>2</sup> (2 x 18-16 AWG)	2 x 0.5-1.5 mm <sup>2</sup> (2 x 18-16 AWG)
	rigid	1 x 0.5-4 mm <sup>2</sup> (1 x 20-12 AWG) 2 x 0.5-2.5 mm <sup>2</sup> (2 x 20-14 AWG)	2 x 0.5-1.5 mm <sup>2</sup> (2 x 20-16 AWG)
Stripping length		8 mm (0.32 in)	
Tightening torque		0.6 - 0.8 Nm (7.08 lb.in)	-

## Environmental data

Ambient temperature ranges	operation	-25...+60 °C
	storage	-40...+85 °C
Damp heat, cyclic (IEC/EN 60068-2-30)		6 x 24 cycle, 55 °C, 95 % RH
Climatic class		3K3
Vibration, sinusoidal		Class 2
Shock		Class 2

## Isolation data

Type		
Rated insulation voltage $U_i$	input circuit / output circuit	600 V
	output circuit 1 / output circuit 2	300 V
Rated impulse withstand voltage $U_{imp}$	input circuit / output circuit	6 kV, 1.2/50 $\mu$ s
	output circuit 1 / output circuit 2	4 kV, 1.2/50 $\mu$ s
Basic insulation	input circuit / output circuit	600 V
Protective separation (IEC/EN 61140, EN 50178)	input circuit / output circuit	-
Pollution degree		3
Overvoltage category		III

## Standards / Directives

Standards	IEC/EN 60947-5-1, IEC/EN 60255-27, EN 50178
Low Voltage Directive	2014/35/EU
EMC directive	2014/30/EU
RoHS directive	2011/65/EU

## Railway application standards

EN 50155, IEC 60571 "Railway applications – Electronic equipment used on rolling stock"	temperature class	T3	
	supply voltage category	S1, S2, C1*), C2*)	
IEC/EN 61373 "Railway applications – Rolling stock equipment – Shock and vibration tests"		Category 1, Class B	
EN 45545-2 Railway applications – Fire protection on railway vehicles – part 2: Requirements for fire behavior of materials and components	ISO 4589-2	LOI 32.3 %	
	NF X-70-100-1	C.I.T. (T12) 0.45	Level 4 (2 kV L-L)
	EN ISO 5659-2	Ds max (T10.03) 104	
NF F 16-101: Rolling stock. Fire behaviour. Materials choosing NF F 16-102: Railway rolling stock. Fire behaviour. Materials choosing, application for electric equipment		I2 / F2	
DIN 5510-2 Preventive fire protection in railway vehicles. Part 2: Fire behaviour and fire side effects of materials and parts		fulfilled	

\*) only applicable for devices with DC supply

## Electromagnetic compatibility

Interference immunity to		IEC/EN 61000-6-2
electrostatic discharge	IEC/EN 61000-4-2	Level 3 (6 kV / 8 kV)
radiated, radio-frequency, electromagnetic field	IEC/EN 61000-4-3	Level 3 (10 V/m)
electrical fast transient / burst	IEC/EN 61000-4-4	Level 3 (2 kV / 2 kHz)
surge	IEC/EN 61000-4-5	Level 4 (2 kV L-L)
conducted disturbances, induced by radio-frequency fields	IEC/EN 61000-4-6	Level 3 (10 V)
harmonics and interharmonics	IEC/EN 61000-4-13	Class 3
Interference emission		IEC/EN 61000-6-3
high-frequency radiated	IEC/CISPR 22, EN 55022	Class B
high-frequency conducted	IEC/CISPR 22, EN 55022	Class B

# Technical diagrams

## Load limit curves

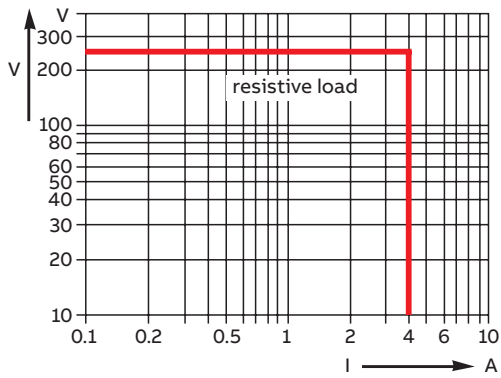

AC load (resistive)

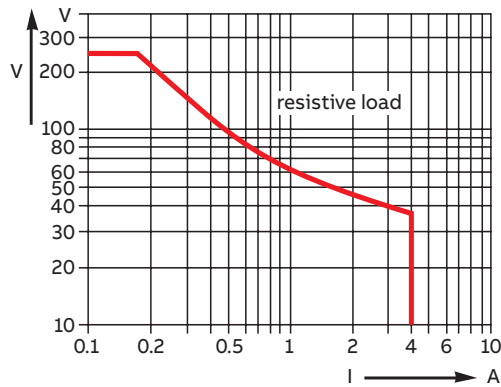

DC load (resistive)

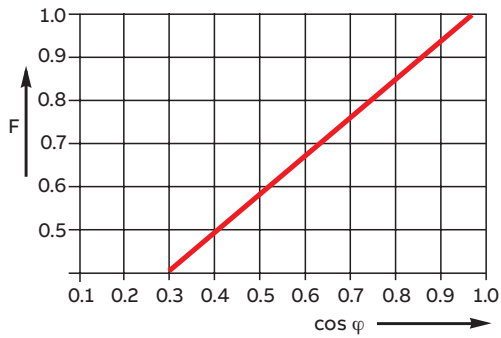

Derating factor F for inductive AC load

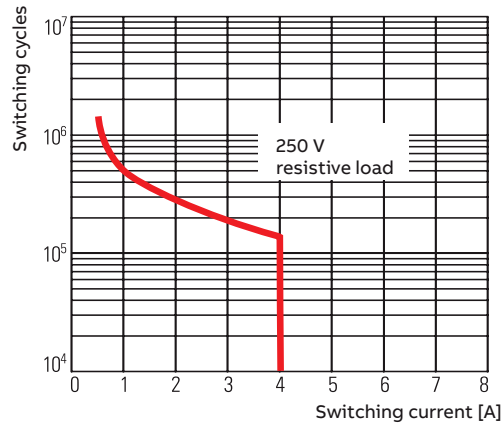

Contact lifetime

# Dimensional drawings

in mm and inches

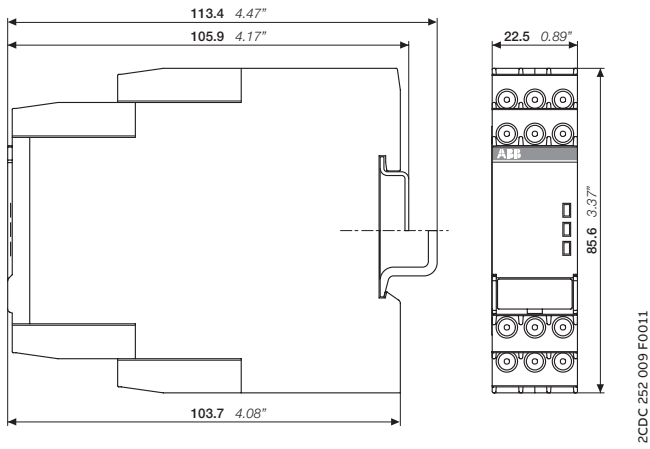

2CDC 252 009 F0011

# Accessories

in mm and inches

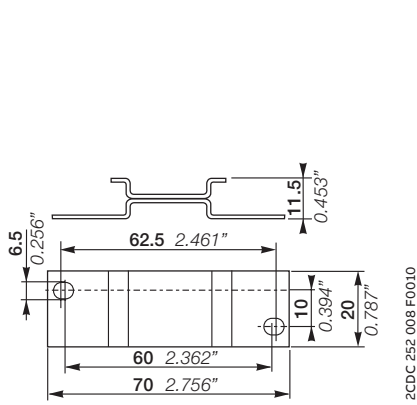

2CDC 252 008 F0010

ADP.01 - Adapter for screw mounting

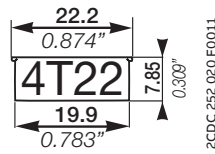

2CDC 252 020 F0011

MAR.12 - Marker label for devices with DIP switches

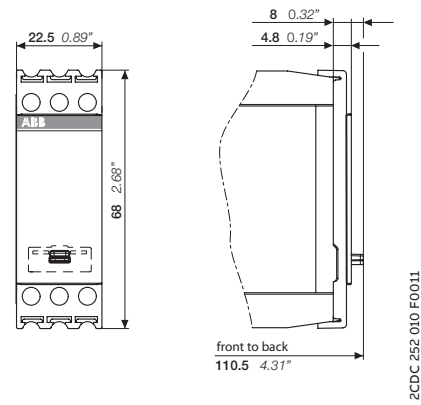

2CDC 252 010 F0011

COV.11 - Sealable transparent cover

## Further documentation

Document title	Document type	Document number
Electronic relays and controls	Catalog	2CDC 110 004 C02xx
CM-MPS.23, CM-MPS.43, CM-MPN.52, CM-MPN.62, CM-MPN.72	Instruction manual	1SVC 730 530 M0000

You can find the documentation on the internet at [www.abb.com/lowvoltage](http://www.abb.com/lowvoltage)  
 -> Automation, control and protection -> Electronic relays and controls -> Measuring and monitoring relays.

## CAD system files

You can find the CAD files for CAD systems at <http://abb-control-products.partcommunity.com>  
 -> Low Voltage Products & Systems -> Control Products -> Electronic Relays and Controls.



---

**ABB STOTZ-KONTAKT GmbH**  
Eppelheimer Strasse 82  
69123 Heidelberg, Germany

**[abb.com/lowvoltage](http://abb.com/lowvoltage)**

---

We reserve the right to make technical changes or modify the contents of this document without prior notice. With regard to purchase orders, the agreed particulars shall prevail. ABB Ltd. does not accept any responsibility whatsoever for potential errors or possible lack of information in this document.

We reserve all rights in this document and in the subject matter and illustrations contained therein. Any reproduction, disclosure to third parties or utilization of its contents – in whole or in parts – is forbidden without prior written consent of ABB Ltd. Copyright© 2020 ABB Ltd. All rights reserved