



Technical catalogue

SACE Emax DC

Low voltage air circuit-breakers
for direct current applications



Index

SACE Emax DC circuit-breakers	2
SACE Emax DC switch-disconnectors	6
Versions and connections	7
Dissipated powers	8
Temperature derating	9
Protection trip units and trip curves	11
Accessories	25
Overall dimensions	26
Electric wiring diagrams	35
Selection Emax DC	44
Ordering codes	50
Ordering examples	88

SACE Emax DC circuit-breakers

The SACE Emax range of low voltage circuit-breakers is completed by the new SACE Emax DC series of circuit-breakers for direct current applications complying with the IEC60947-2 Standard. Thanks to the exclusive technology applied to the new SACE PR123/DC and PR122/DC trip units, the SACE Emax DC range allows all installation requirements to be met and protection up to 1000V DC / 5000A.

With connection of three interruption poles in series, the rated voltage which can be reached is 750V DC, whereas with four poles in series this rises to 1000V DC.

The withdrawable circuit-breakers must be associated with the fixed parts in a special version for applications at 750/1000V DC.

Common data

Voltages		
Rated service voltage Ue	[V-]	1000
Rated insulation voltage Ui	[V]	1000
Rated impulse withstand voltage Uimp	[kV]	12
Operating temperature		
	[°C]	-25...+70
Storage temperature		
	[°C]	-40...+70
Number of poles		3 - 4
Versions		Fixed - Withdrawable



		E2		E3		E4		E6	
		B	N	N	H	S	H	H	
Levels of performance									
Rated uninterrupted current (at 40 °C) Iu	[A]	800		800					
	[A]	1000		1000					
	[A]	1250		1250					
	[A]	1600	1600	1600	1600	1600			
	[A]			2000	2000	2000			
	[A]			2500	2500	2500			
	[A]						3200	3200	3200
	[A]								4000
	[A]								5000
Rated ultimate short-circuit breaking current Icu according to the application network		See pages 3, 4 and 5							
Rated service short-circuit breaking current Ics	[%Icu] [kA]	100%	100%	100%	100%	100%	100%	100%	100%
Rated short-time withstand current Icw (0.5s)									
@ 500 V DC (3p)	[kA]	35	50	60	65	75	100	100	
@ 750 V DC (3p)	[kA]	25	25	40	40	65	65	65	
@ 750 V DC (4p)	[kA]	25	40	50	50	65	65	65	
@ 1000 V DC (4p)	[kA]	25	25	35	40	50	65	65	
Rated short-circuit making current Icm	[%Icu] [kA]	100%	100%	100%	100%	100%	100%	100%	100%
Category of use (according to CEI EN 60947-2)		B	B	B	B	B	B	B	B
Isolation behaviour (according to CEI EN 60947-2)		■	■	■	■	■	■	■	■
Overcurrent protection									
Electronic trip units for DC applications		■	■	■	■	■	■	■	■
Operating times									
Closing time (max)	[ms]	80	80	80	80	80	80	80	80
Breaking time for I>Icw (max) ⁽¹⁾	[ms]	60	60	60	60	60	60	60	60
Overall dimensions									
Fixed: H = 418 mm - D = 302 mm - W (3/4 poles)	[mm]	296/386	296/386	404/530	404/530	566/656	566/656	782/908	
Withdrawable: H = 461 mm - D = 396.5 mm - W (3/4 poles)	[mm]	324/414	324/414	432/558	432/558	594/684	594/684	810/936	
Weights									
Fixed 3/4 poles	[kg]	50/61	50/61	66/80	66/80	97/117	97/117	140/160	
Withdrawable 3/4 poles (including the fixed part)	[kg]	50/61	50/61	66/80	66/80	147/165	147/165	210/240	

(1) Without intentional delays.

		E2		E3		E4		E6					
		800 1000 1250	1600	800 1000 1250	1600	2000 2500	1600 2000	2500 3200	3200	4000 5000			
Life with regular maintenance	N. operations												
Mechanical	x 1000	25	25	20	20	20	20	15	15	15	12	12	12
Electrical	1000V DC x 1000	15	10	12	10	9	7	7	7	7	5	4	2

SACE Emax DC circuit-breakers

Rated ultimate short-circuit breaking current I_{cu} according to the type of network

Insulated network ⁽¹⁾

Rated voltage (U _e)			≤ 500	≤ 750	≤ 1000	
isolation			■	■	■	
protection			■	■	■	
PR122/DC			■	■	■	
PR123/DC			■	■	■	
I_{cu} ⁽²⁾			[kA]	[kA]	[kA]	
E2	B	800	35	25	25	
		1000				
		1250				
N	1600	50	25	40	25	
	1600					
E3	N	800	60	40	50	
		1000				
		1250				
		1600				
		2000				
	H	2500	65 ⁽³⁾	40	50	40
		1600				
E4	S	2000	75	65	65	
		2500				
		3200				
	H	3200	100	65	65	65
E6	H	3200	100	65	65	
		4000				
		5000				

⁽¹⁾ the possibility of a double earth fault is considered negligible with this type of pole connections. For further information, see QT5: "ABB circuit-breakers for direct current applications".

⁽²⁾ I_{cu} with L/R = 15ms according to IEC 60946-2 Standard. For I_{cu} with L/R = 5ms and L/R = 30ms, ask ABB.

⁽³⁾ 85kA only if supplied from lower terminals and specifying the following extracode at the ordering stage: 1SDA067148R1. I_{cs} =65kA.

SACE Emax DC circuit-breakers

Rated ultimate short-circuit breaking current I_{cu} according to the type of network

Network with earthed negative polarity⁽¹⁾

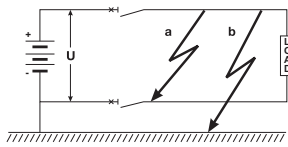
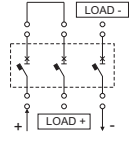
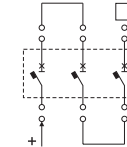
Rated voltage (U_e)		$\leq 500^{(2)}$			
					
isolation		■		■	
protection		■		■	
PR122/DC		■		■	
PR123/DC		■		■	
type of fault ⁽³⁾		a	b	a	b
poles in series affected by the fault		3	2	4	3
$I_{cu}^{(4)}$		[kA]		[kA]	
E2	B	800			
		1000			
		1250	35	20	35
	N	1600			
		1600	50	25	50
E3	N	800			
		1000			
		1250			
		1600	60	30	60
		2000			
	H	1600			
		2000	65 ⁽⁶⁾	40	65 ⁽⁶⁾
E4	S	1600			
		2000	100	50	100
		2500			
	H	3200	100	65	100
		3200			
E6	H	3200	100	65	100
		4000			
		5000			

⁽¹⁾ for networks with positive earthed polarity, ask ABB.

⁽²⁾ for higher voltages, ask ABB.

⁽³⁾ for further information, see QT5: "ABB circuit-breakers for direct current applications".

⁽⁴⁾ I_{cu} with $L/R = 15\text{ms}$ according to IEC 60946-2 Standard. For I_{cu} with $L/R = 5\text{ms}$ and $L/R = 30\text{ms}$, ask ABB.

⁽⁶⁾ 85kA only if supplied from lower terminals and specifying the following extracode at the ordering stage: 1SDA067148R1. $I_{cs}=65\text{kA}$.

Network with the mid-point earthed

Rated voltage (Ue)		≤ 500			≤ 500			≤ 750			≤ 1000		
PR122/DC		-			-			-			-		
PR123/DC		■			■			■			■		
type of fault		a	b	c	a	b	c	a	b	c	a	b	c
poles in series affected by the fault		3	2 (U/2)	1 (U/2)	4	2 (U/2)	2 (U/2)	4	2 (U/2)	2 (U/2)	4	2 (U/2)	2 (U/2)
Icu ⁽¹⁾		[kA]			[kA]			[kA]			[kA]		
E2	B	800											
		1000	35	35	18	35	35	35	25	25	25	25	25
		1250											
E3	N	1600	50	50	25	50	50	50	40	40	40	25	25
		800											
		1000											
E4	S	1250	60	60	30	60	60	60	50	50	50	35	35
		1600											
		2000											
E6	H	2500	65 ⁽²⁾	65	40	65 ⁽²⁾	65 ⁽²⁾	65 ⁽²⁾	50	50	50	40	40
		1600											
		2000											
E4	H	2500	75	75	35	75	75	75	65	65	65	50	50
		3200											
		3200	100	100	50	100	100	100	65	65	65	65	65
E6	H	3200	100	100	65	100	100	100	65	65	65	65	65
		4000											
		5000											

⁽¹⁾ Icu with L/R = 15ms according to IEC 60946-2 Standard. For Icu with L/R = 5ms and L/R = 30ms, ask ABB.

⁽²⁾ 85kA only if supplied from below and specifying the following extracode at the ordering stage: 1SDA067148R1. Ics=65kA.

SACE Emax switch-disconnectors

ABB SACE has developed the SACE Emax/E MS range of switch-disconnectors for direct current applications up to 1000V complying with the international IEC60947-3 Standard. These circuit-breakers are particularly suitable for use as bus-ties or main switch-disconnectors in direct current plants, such as applications in the field of electric traction.

The range makes it possible to cover any installation requirement up to 1000V DC / 6300A. The circuit-breakers are available in the fixed or withdrawable version and in the three-pole or four-pole version.

With connection of three breaking poles in series, the rated voltage which can be reached is 750V DC, whereas with four poles in series this rises to 1000V DC.

The switch-disconnectors in the SACE Emax/E MS range keep all the overall dimensions and fixing points of the circuit-breakers of the standard range unchanged. The withdrawable circuit-breakers must be associated with the fixed parts in a special version for applications at 750/1000V DC.

		E1B/E MS		E2N/E MS		E3H/E MS		E4H/E MS		E6H/E MS	
Rated current (at 40 °C) I_u	[A]	800		1250		1250		3200		5000	
	[A]	1250		1600		1600		4000		6300	
	[A]			2000		2000					
	[A]					2500					
	[A]					3200					
Poles		3	4	3	4	3	4	3	4	3	4
Rated service voltage U_e	[V]	750	1000	750	1000	750	1000	750	1000	750	1000
Rated insulation voltage U_i	[V]	1000	1000	1000	1000	1000	1000	1000	1000	1000	1000
Rated impulse withstand voltage U_{imp}	[kV]	12	12	12	12	12	12	12	12	12	12
Rated short-time withstand current I_{cw} (1s)	[kA]	20	20*	25	25*	40	40*	65	65	65	65
Rated making current I_{cm}	[%I _{cw}]	100	100	100	100	100	100	100	100	100	100

Note: By means of an extreme protection relay with maximum timing of 500 ms, the I_{cu} breaking current is the same as the I_{cw} value (1s).

* The performances at 750 V are:
 for E1B/E MS I_{cw}=25kA
 for E2N/E MS I_{cw}=40kA
 for E3H/E MS I_{cw}=50kA

Versions and connections

Versions and connections

The Emax DC circuit-breakers are available in the fixed or withdrawable, three-pole or four-pole versions.

All Emax circuit-breakers for direct current have several poles in series involved in breaking the fault, for this reason special connections busbar (known as “U connection kit”) are mounted on the circuit-breaker terminals.

Selection of the power supply side, from the lower or upper terminals, must only be made at the time of ordering and cannot be modified later by the customer.

The fixed circuit-breakers are fitted with vertical terminals, whereas it is possible to select between vertical and horizontal terminals for circuit-breakers in the withdrawable version.

Fixed circuit-breaker

Vertical rear terminals

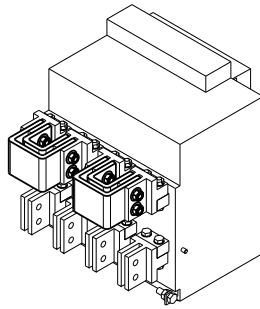

Power supply from lower terminals

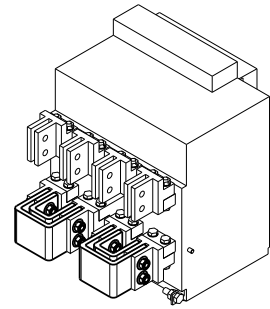

Power supply from upper terminals

Withdrawable circuit-breaker

Vertical rear terminals

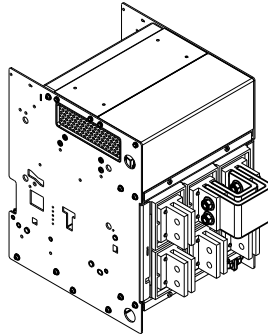

Power supply from lower terminals

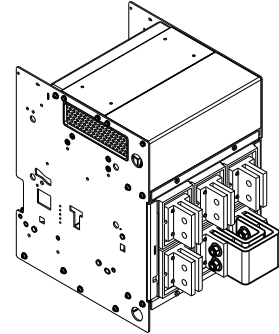

Power supply from upper terminals

Horizontal rear terminals

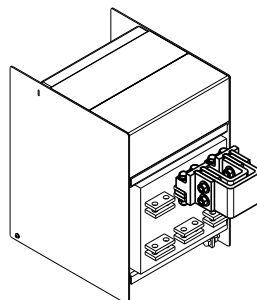

Power supply from lower terminals

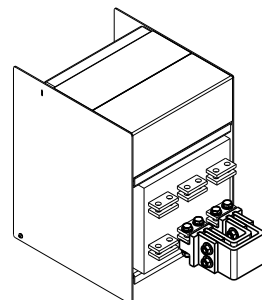

Power supply from upper terminals

Power losses

The power losses for Emax DC circuit-breakers are given below according to:

- range;
- trip unit;
- version;
- number of poles;
- lu.

Emax DC power losses [W]				lu [A]									
	Trip unit	Version	poles	800	1000	1250	1600	2000	2500	3200	4000	5000	
E2	PR122/DC	F	3p	42	60	94	136						
		W	3p	66	98	152	232						
		F	4p	51	75	117	174						
		W	4p	83	125	195	302						
	PR123/DC	F	3p	54	113	176	156						
		W	3p	78	113	176	252						
		F	4p	64	140	219	195						
		W	4p	96	140	219	323						
E3	PR122/DC	F	3p	32	61	95	123	216	338				
		W	3p	47	69	108	207	248	388				
		F	4p	38	87	123	184	288	450				
		W	4p	59	87	136	205	320	500				
	PR123/DC	F	3p	50	68	106	138	216	338				
		W	3p	60	84	131	179	280	438				
		F	4p	55	86	134	184	288	450				
		W	4p	65	102	159	225	352	550				
E4	PR122/DC	F	3p					120	188	271			
		W	3p					195	305	463			
		F	4p					136	234	348			
		W	4p					236	391	604			
	PR123/DC	F	3p					150	234	312			
		W	3p					225	352	504			
		F	4p					180	281	389			
		W	4p					280	438	645			
E6	PR122/DC	F	3p							154	304	475	
		W	3p							276	496	775	
		F	4p							246	384	600	
		W	4p							410	640	1000	
	PR123/DC	F	3p								236	368	575
		W	3p								358	560	875
		F	4p								287	448	700
		W	4p								451	704	1100

Temperature derating

The following graphs show derating as a function of temperature for Emax DC circuit-breakers.

E2 DC

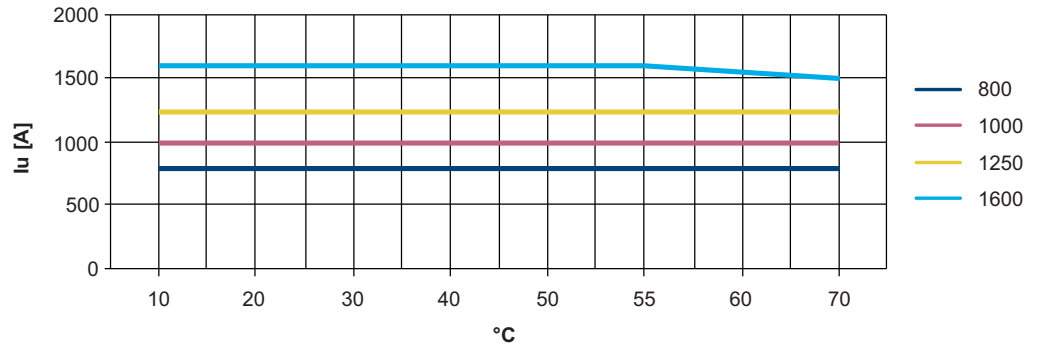

E2 DC	800		1000		1250		1600	
°C	%	A	%	A	%	A	%	A
10	100%	800	100%	1000	100%	1250	100%	1600
20	100%	800	100%	1000	100%	1250	100%	1600
30	100%	800	100%	1000	100%	1250	100%	1600
40	100%	800	100%	1000	100%	1250	100%	1600
50	100%	800	100%	1000	100%	1250	100%	1600
55	100%	800	100%	1000	100%	1250	100%	1600
60	100%	800	100%	1000	100%	1250	98%	1567
70	100%	800	100%	1000	100%	1250	94%	1500

E3 DC

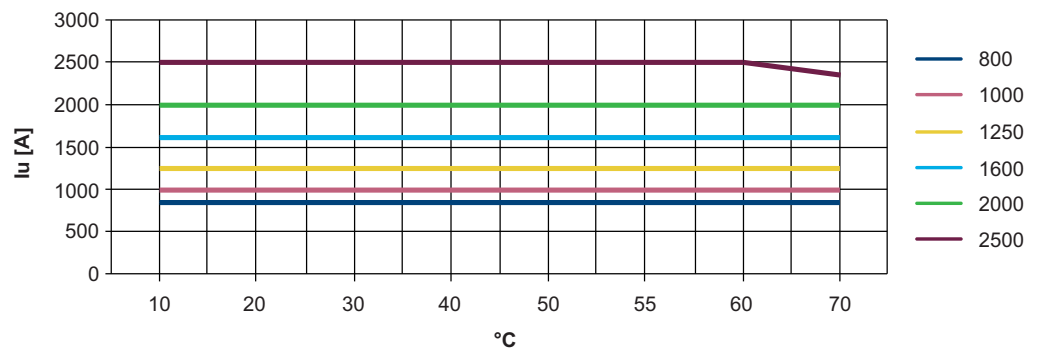

E3 DC	800		1000		1250		1600		2000		2500	
°C	%	A	%	A	%	A	%	A	%	A	%	A
10	100%	800	100%	1000	100%	1250	100%	1600	100%	2000	100%	2500
20	100%	800	100%	1000	100%	1250	100%	1600	100%	2000	100%	2500
30	100%	800	100%	1000	100%	1250	100%	1600	100%	2000	100%	2500
40	100%	800	100%	1000	100%	1250	100%	1600	100%	2000	100%	2500
50	100%	800	100%	1000	100%	1250	100%	1600	100%	2000	100%	2500
55	100%	800	100%	1000	100%	1250	100%	1600	100%	2000	100%	2500
60	100%	800	100%	1000	100%	1250	100%	1600	100%	2000	100%	2500
70	100%	800	100%	1000	100%	1250	100%	1600	100%	2000	94%	2350

Temperature derating

E4 DC

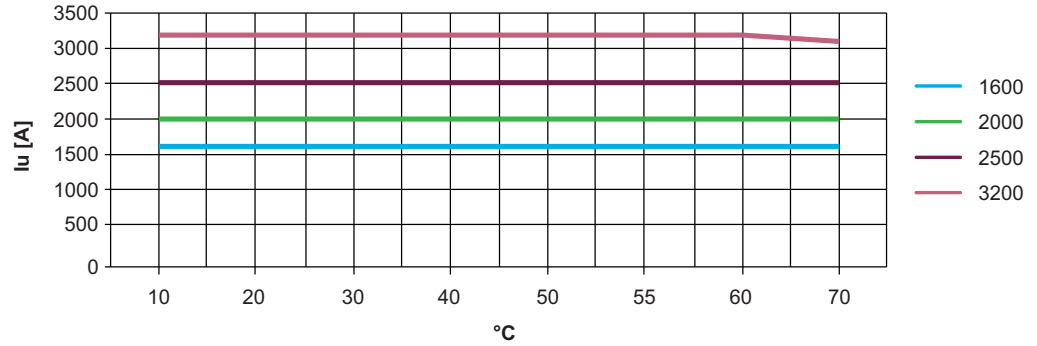

E4 DC	1600		2000		2500		3200	
°C	%	A	%	A	%	A	%	A
10	100%	1600	100%	2000	100%	2500	100%	3200
20	100%	1600	100%	2000	100%	2500	100%	3200
30	100%	1600	100%	2000	100%	2500	100%	3200
40	100%	1600	100%	2000	100%	2500	100%	3200
50	100%	1600	100%	2000	100%	2500	100%	3200
55	100%	1600	100%	2000	100%	2500	100%	3200
60	100%	1600	100%	2000	100%	2500	100%	3200
70	100%	1600	100%	2000	100%	2500	97%	3100

E6 DC

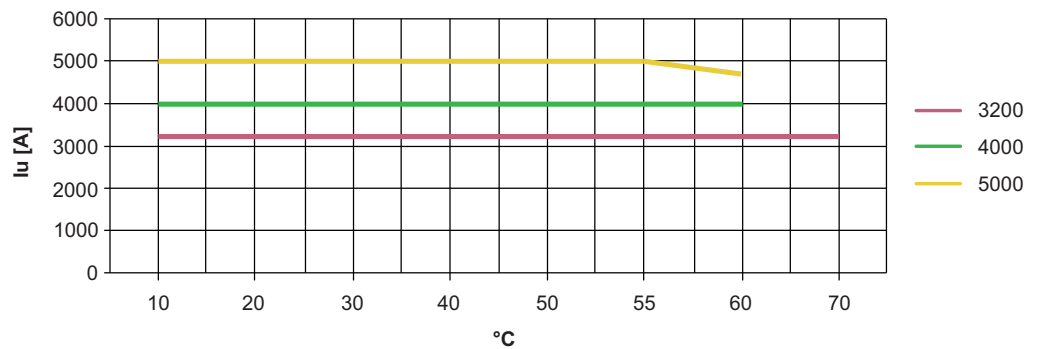

E6 DC	3200		4000		5000	
°C	%	A	%	A	%	A
0	100%	3200	100%	4000	100%	5000
10	100%	3200	100%	4000	100%	5000
20	100%	3200	100%	4000	100%	5000
30	100%	3200	100%	4000	100%	5000
40	100%	3200	100%	4000	100%	5000
50	100%	3200	100%	4000	100%	5000
55	100%	3200	100%	4000	100%	5000
60	100%	3200	100%	4000	100%	5000
70	100%	3200	100%	4000	96%	4800

Protection trip units and trip curves

PR122/DC

Characteristics

PR122/DC is the new electronic trip unit for the Emax DC series. The wide range of protection functions, together with the wide variety of trip thresholds and times, make them suitable for protection of insulated networks or networks with earthed negative polarity. Information about the unit and programming are particularly simple and intuitive thanks to the LCD graphic display.

The PR122/DC trip unit offers the following protection functions:

- overload (L);
- selective short-circuit (S);
- thermal memory for L and S (cable protection);
- instantaneous short-circuit (I);
- overtemperature (OT);
- zone selectivity for S;
- load control (K);
- starting threshold.



Protection trip units and trip curves

PR122/DC

Protection functions and setting values - PR122/DC

Function	Trip threshold	Threshold step	Trip time	Time step	Poss. excl.	Relation t=f(I)	Thermal memory	Zone selectivity
L Protection against overload Tolerance ⁽²⁾	$I_1 = 0.4 \dots 1 \times I_n$ Trip unit between 1.05 and 1.3 x I1	$0.01 \times I_n$	With current $I_f = 3 \times I_1$ $t_1 = 3 \text{ s} \dots 102 \text{ s}^{(1)}$ $\pm 10\%$, $I_f \leq 6 \times I_n$ $\pm 20\%$, $I_f > 6 \times I_n$	3 s	–	IEC60255-8	■	–
S Selective protection against short-circuit Tolerance ⁽²⁾	$I_2 = 0.6 \dots 10 \times I_n$ $\pm 7\%$, $I_f \leq 6 \times I_n$ $\pm 10\%$, $I_f > 6 \times I_n$	$0.1 \times I_n$	With current $I_f > I_2$ $t_2 = 0.05 \text{ s} \dots 0.35 \text{ s}$ $t_{2sel} = 0.04 \text{ s} \dots 0.2 \text{ s}$ The best of the two data: $\pm 10\%$ or $\pm 40 \text{ ms}$	0.01 s 0.01 s	■	$t=k$	–	■
Tolerance ⁽²⁾	$I_2 = 0.6 \dots 10 \times I_n$ $\pm 7\%$, $I_f \leq 6 \times I_n$ $\pm 10\%$, $I_f > 6 \times I_n$	$0.1 \times I_n$	With current $I_f \geq 10 \times I_n$ $t_2 = 0.05 \text{ s} \dots 0.35 \text{ s}$ $\pm 15\%$, $I_f \leq 6 \times I_n$ $\pm 20\%$, $I_f > 6 \times I_n$	0.01 s	■	$t=k/I^2$	■	–
I Protection against instantaneous short-circuit Tolerance ⁽²⁾	$I_3 = 1.5 \dots 10 \times I_n$ $\pm 10\%$	$0.1 \times I_n$	Instantaneous $\leq 30 \text{ ms}$	–	■	$t=k$	–	–
OT Protection against overtemperature	Cannot be set	–	Instantaneous	–	–	$t=k$	–	–

(1) The minimum trip value is 0.5 s, regardless of the type of curve set

(2) These tolerances are valid in the following hypotheses:

- trip unit supplied entirely by the voltage module and/or auxiliary power supply (without start-up)
- trip time set $\geq 100 \text{ ms}$

For all cases not contemplated by the above hypotheses, the following tolerance values are valid:

	Trip threshold	Trip time
L	Trip between 1.05 and 1.25 x I1	$\pm 20\%$
S	$\pm 10\%$	$\pm 20\%$
I	$\pm 15\%$	$\leq 60 \text{ ms}$

With plant voltages higher than or equal to 100V, the PR122/DC electronic trip unit guarantees protection without the need of an auxiliary power supply (24V DC).

The PR122/DC electronic trip unit can, in fact, always be equipped with the PR120/V module able to supply the trip unit with plant voltages between 250V DC and 1000V DC.

For voltages between 100V DC and 250V DC, it is necessary to order the PR120/LV module, specifying the extracode 1SDA066223R1.

The following table shows the cases when it is possible to use the measurement modules (PR120/V and PR120/LV):

Ue [V]	12	100	250	1000
PR120/LV:	PR120/LV + Vaux	PR120/LV	NO	
PR120/V:	PR120/V + Vaux	PR120/V + Vaux	PR120/V	

When there is an auxiliary power supply, see the table below for the overall consumption values.

	PR122/DC	PR120/D-M	PR120/K
Auxiliary power supply (galvanically insulated)	24V DC \pm 20%	from PR122/DC	from PR122/DC
Maximum ripple	5%		
Inrush current @ 24V	\sim 10A for 5 ms		
Rated power @ 24V	\sim 3 W	+1.5 W	+1.5 W

When Emax DC circuit-breakers are used in plants with capacitor banks with possible back-to-back inrush currents $\geq 3xI_n$, it is necessary to use a 24V DC galvanically insulated auxiliary power supply.

Emax DC circuit-breakers are normally supplied with power input from lower terminals, i.e. the PR120/V-PR120/LV internal connection is on the lower terminals, whereas the U connections are on the upper terminals:

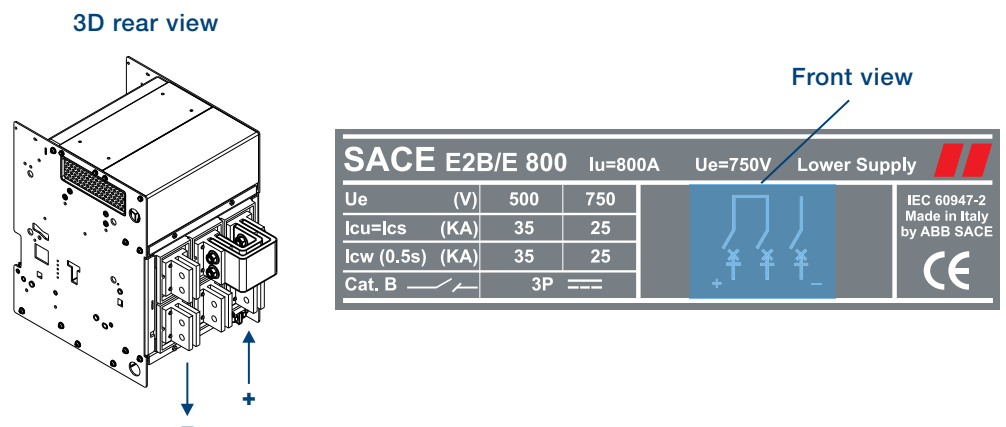

For power supply from upper terminals, refer to the Code Section for ordering.

Protection is guaranteed even when the electronic trip unit is not powered thanks to the PR120/DC module which always equips the PR122/DC.

Protection trip units and trip curves

PR122/DC

Functions L-S-I

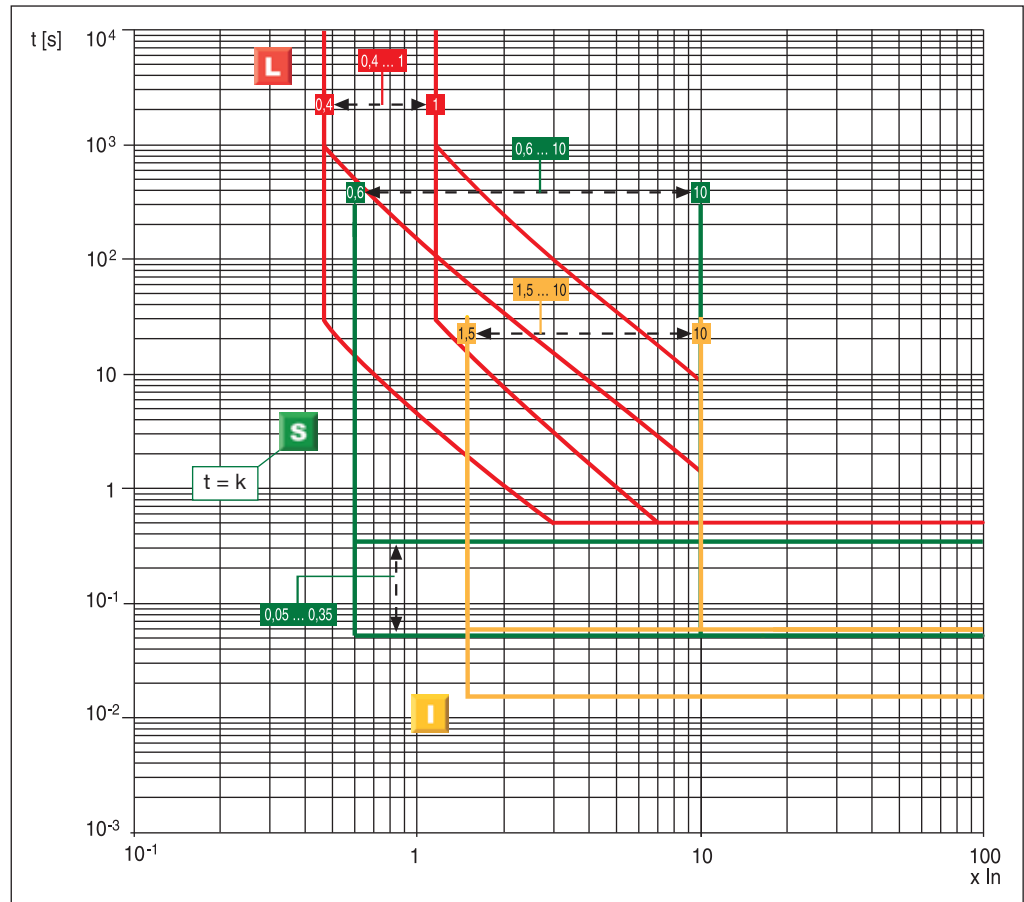

1SDC200012D0202

Functions L-S-I

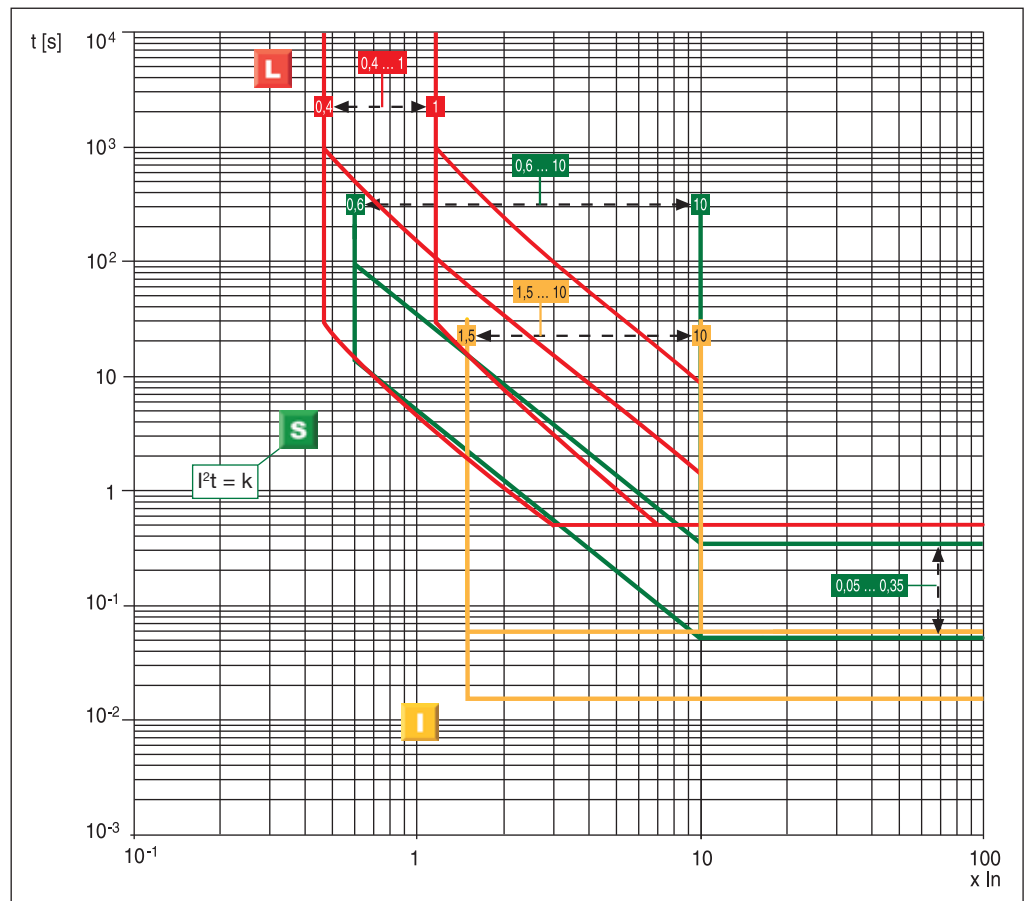

1SDC200012D0202

Protection trip units and trip curves

PR123/DC

Characteristics

With the PR123/DC electronic protection trip unit, the range of trip units available for the Emax DC series of circuit-breakers is completed.

PR123/DC is a high-performing trip unit capable of carrying out a complete set of protections, measurements, indications, data storage and circuit-breaker control functions.

PR123/DC not only offers protection but also measurement of current and voltage of both polarities (+ and -), thus being suitable for any type of network.

The front interface of the unit, common to PR122/DC, is extremely simple thanks to the aid of the LCD graphic display.

The PR123/DC trip unit offers the following protection functions:

- overload (L);
- selective short-circuit (S);
- thermal memory for L and S (cable protection);
- instantaneous short-circuit (I);
- earth fault with adjustable delay (G);
- polarity unbalance (U);
- protection against overtemperature (OT);
- load control (K);
- undervoltage (UV);
- overvoltage (OV);
- active power reversal (RP);
- double set of parameters (Dual Setting);
- zone selectivity for S and G;
- starting thresholds for protection S and I.



1SDC20012D0202

Protection trip units and trip curves

PR123/DC

Protection functions and setting values - PR123/DC

Function	Trip threshold	Threshold step	Trip time	Time step	Poss. excl.	Relation t=f(I)	Thermal memory	Zone selectivity
L Protection against overload Tolerance ⁽²⁾	$I1 = 0.4...1 \times I_n$ Trip between 1.05 and $1.3 \times I1$	$0.01 \times I_n$	With current $I = 3 \times I1$ $t1 = 3 \text{ s}...102 \text{ s}^{(1)}$ $\pm 10\%$ $I_f \leq 6 \times I_n$ $\pm 20\%$ $I_f > 6 \times I_n$	3 s	–	IEC60255-8	■	–
S Selective protection against short-circuit Tolerance ⁽²⁾	$I2 = 0.6...10 \times I_n$ $\pm 7\%$ $I_f \leq 6 \times I_n$ $\pm 10\%$ $I_f > 6 \times I_n$	$0.1 \times I_n$	With current $I > I2$ $t2 = 0.05 \text{ s}...0.35 \text{ s}$ $t2_{sel} = 0.04 \text{ s}...0.2 \text{ s}$ The best of the two data: $\pm 10\%$ or $\pm 40 \text{ ms}$	0.01 s 0.01 s	■	$t=k$	–	■
Tolerance ⁽²⁾	$I2 = 0.6...10 \times I_n$ $\pm 7\%$ $I_f \leq 6 \times I_n$ $\pm 10\%$ $I_f > 6 \times I_n$	$0.1 \times I_n$	With current $I = 10 \times I1$ $t2 = 0.05 \text{ s}...0.35 \text{ s}$ $\pm 15\%$ $I_f \leq 6 \times I_n$ $\pm 20\%$ $I_f > 6 \times I_n$	0.01 s	■	$t=k/I^2$	■	–
S₂ Selective protection against short-circuit Tolerance ⁽²⁾	$I2 = 0.6...10 \times I_n$ $\pm 7\%$ $I_f \leq 6 \times I_n$ $\pm 10\%$ $I_f > 6 \times I_n$	$0.1 \times I_n$	With current $I > I2$ $t2 = 0.05 \text{ s}...0.35 \text{ s}$ The best of the two data: $\pm 10\%$ or $\pm 40 \text{ ms}$	0.01 s	■	$t=k$	–	■
I Protection against instantaneous short-circuit Tolerance ⁽²⁾	$I3 = 1.5...10 \times I_n$ $\pm 10\%$	$0.1 \times I_n$	Instantaneous $\leq 30 \text{ ms}$	–	■	$t=k$	–	–
G Protection against earth fault Tolerance ⁽²⁾	$I4 = 0.2...1 \times I_n$ $\pm 7\%$	$0.02 \times I_n$	With current $I > I4$ $t4 = 0.1 \text{ s}...1 \text{ s}$ $t4_{sel} = 0.04 \text{ s}...0.2 \text{ s}$ The best of the two data: $\pm 10\%$ or $\pm 40 \text{ ms}$	0.05 s 0.01 s	■	$t=k$	–	■
Tolerance ⁽²⁾	$I4 = 0.2...1 \times I_n$ $\pm 7\%$	$0.02 \times I_n$	$t4 = 0.1 \text{ s}...1 \text{ s}$ (with $I=4 \times I4$) $\pm 15\%$	0.05 s	■	$t=k/I^2$	–	–
U Protection against phase unbalance Tolerance ⁽²⁾	$I6 = 5\%...90\%$ $\pm 10\%$	5%	$t6 = 0.5 \text{ s}...60 \text{ s}$ The best of the two data: $\pm 20\%$ or $\pm 100 \text{ ms}$	0.5 s	■	$t=k$	–	–
OT Protection against overtemperature	Cannot be set	–	Instantaneous	–	–	$t=k$	–	–
UV Undervoltage protection Tolerance ⁽²⁾	$U8 = 0.5...0.95 \times U_n$ $\pm 5\%$	$0.01 \times I_n$	With voltage $U < U8$ $t8 = 0.1 \text{ s}...5 \text{ s}$ The best of the two data: $\pm 20\%$ or $\pm 40 \text{ ms}$	0.1 s	■	$t=k$	–	–
OV Overvoltage protection Tolerance ⁽²⁾	$U9 = 1.05...1.2 \times U_n$ $\pm 5\%$	$0.01 \times I_n$	With voltage $U < U9$ $t9 = 0.1 \text{ s}...5 \text{ s}$ The best of the two data: $\pm 20\%$ or $\pm 40 \text{ ms}$	0.1 s	■	$t=k$	–	–
RP Protection against reversal of power Tolerance ⁽²⁾	$P11 = -0.3...-0.1 \times P_n$ $\pm 10\%$	$0.02 \times P_n$	At power $P < P11$ $t11 = 0.5 \text{ s}...25 \text{ s}$ The best of the two data: $\pm 10\%$ or $\pm 100 \text{ ms}$	0.1 s	■	$t=k$	–	–

(1) The minimum trip value is 0.5 s, regardless of the type of curve set

(2) These tolerances are valid with the following hypothesis:

- trip unit supplied from the voltage module and/or auxiliary power supply (without start-up)
- trip time set $\geq 100 \text{ ms}$

For all cases not contemplated by the above hypothesis, the following tolerance values are valid:

	Trip threshold	Trip time
L	Trip between 1.05 and $1.3 \times I1$	$\pm 20\%$
S	$\pm 10\%$	$\pm 20\%$
I	$\pm 15\%$	$\leq 60 \text{ ms}$
G	$\pm 15\%$	$\pm 20\%$
Altri	$\pm 20\%$	

With plant voltages higher than or equal to 100V, the PR123/DC electronic trip unit guarantees protection without the need of an auxiliary power supply (24V DC).

The PR123/DC electronic trip unit is, in fact, always fitted with the PR120/V module able to supply the trip unit with plant voltages between 250V DC and 1000V DC.

For voltages between 100V DC and 250V DC, it is necessary to request the PR120/LV module, specifying the extracode 1SDA066223R1.

The following table shows the possible cases of use of the measurement modules (PR120/V and PR120/LV):

Ue [V]	12	100	250	1000
PR120/LV:	PR120/LV + Vaux	PR120/LV	NO	
PR120/V:	PR120/V + Vaux	PR120/V + Vaux	PR120/V	

When there is an auxiliary power supply, see the table given below for the overall consumption values.

	PR123/DC	PR120/D-M	PR120/K
Auxiliary power supply (galvanically insulated)	24V DC \pm 20%	from PR123/DC	from PR123/DC
Maximum ripple	5%		
Inrush current @ 24V	\sim 10A for 5 ms		
Rated power @ 24V	\sim 3 W	+1,5 W	+1,5 W

When Emax DC circuit-breakers are used in plants with capacitor banks with possible inrush back-to-back currents $\geq 3xI_n$, it is necessary to use a 24V DC galvanically insulated auxiliary power supply.

The range of Emax DC circuit-breakers is normally supplied with power input from lower terminals, i.e. the PR120/V-PR120/LV internal connection is on the lower terminals, whereas the U connections are on the upper terminals:

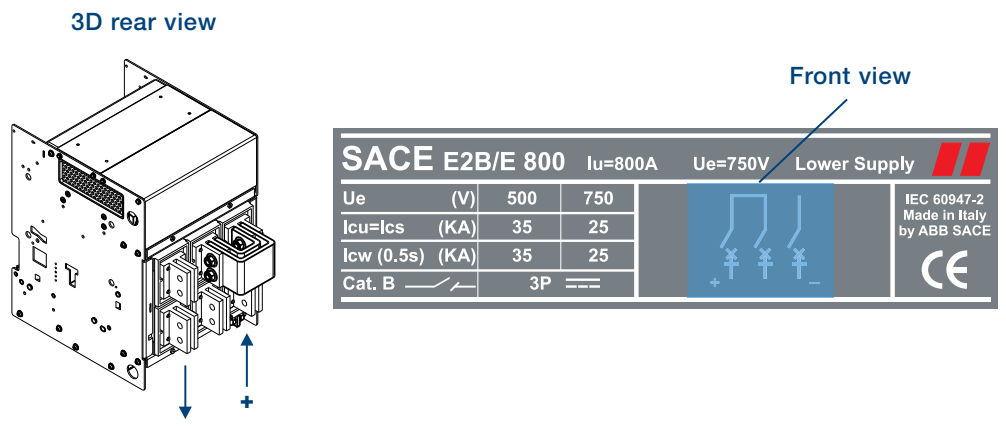

For power input to the upper terminals, refer to the ordering Code Section.

Protection is guaranteed even when there is no power supply to the electronic trip unit thanks to the PR120/DC module, which always equips the PR123/DC.

Protection trip units and trip curves

PR123/DC

Functions L-S-I

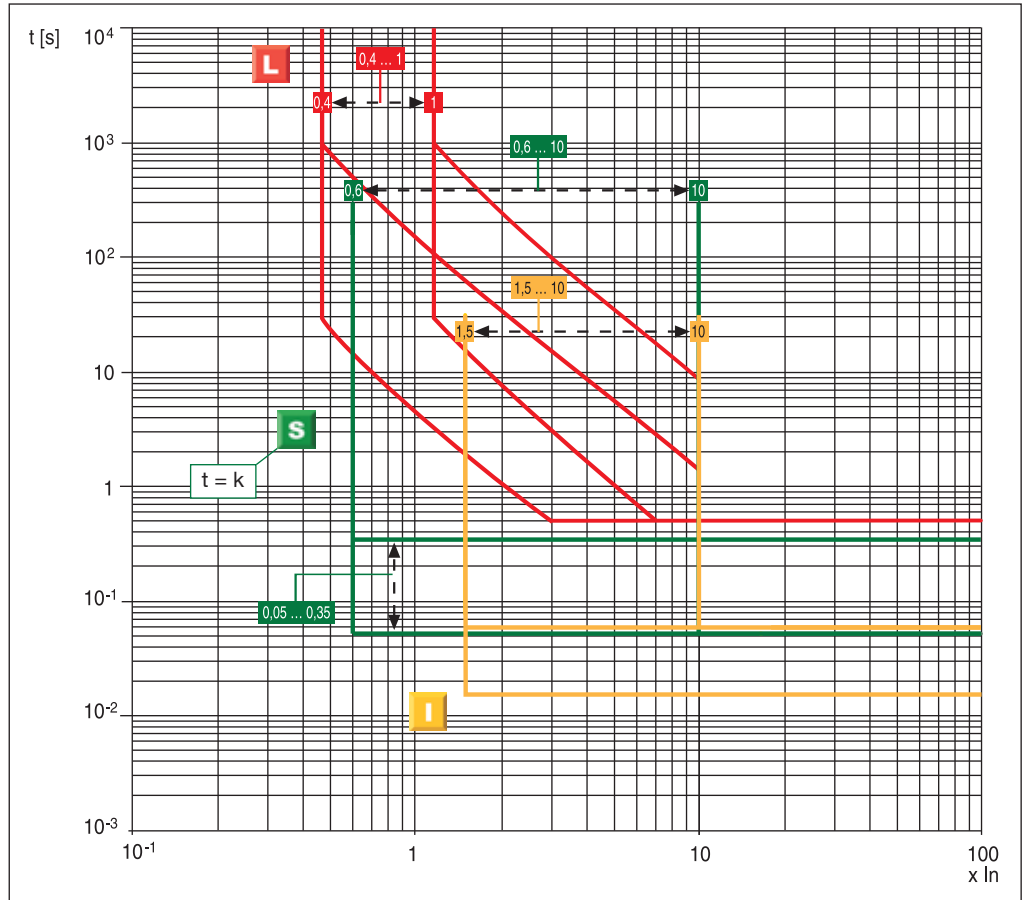

1SDCC0009F0001

Functions L-S-I

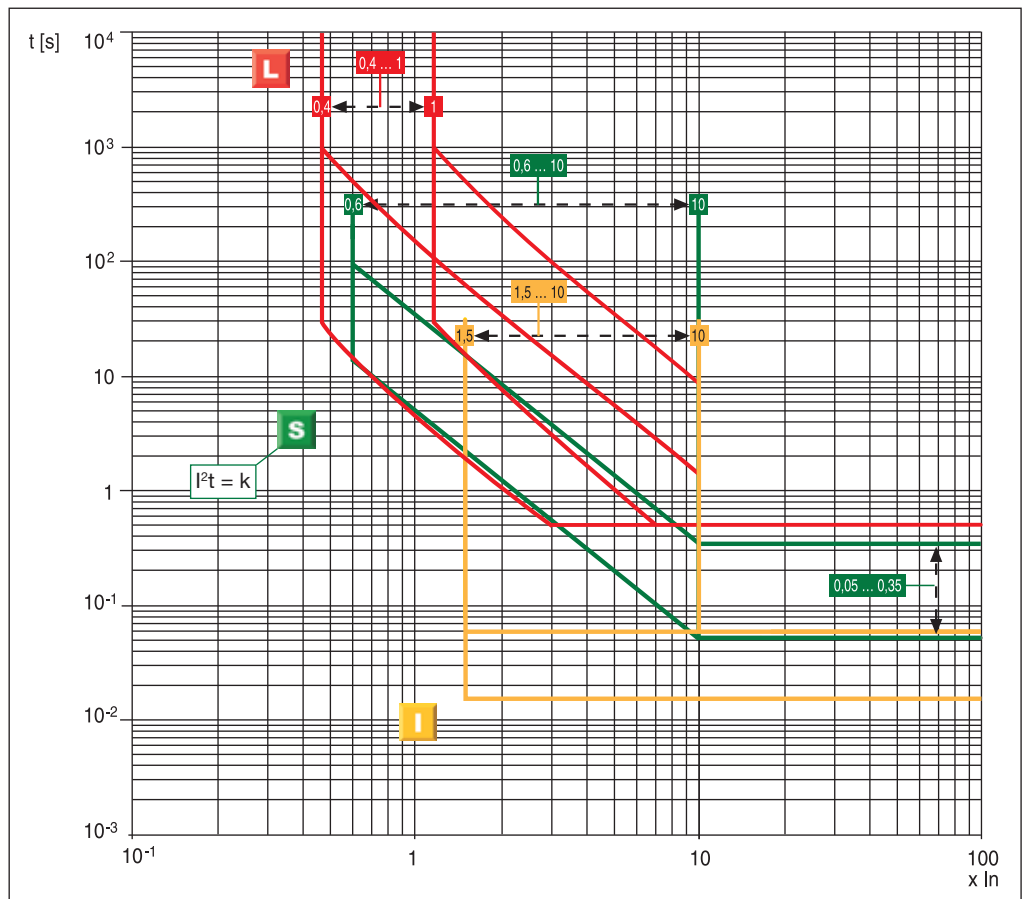

1SDCC0009F0001

Function G

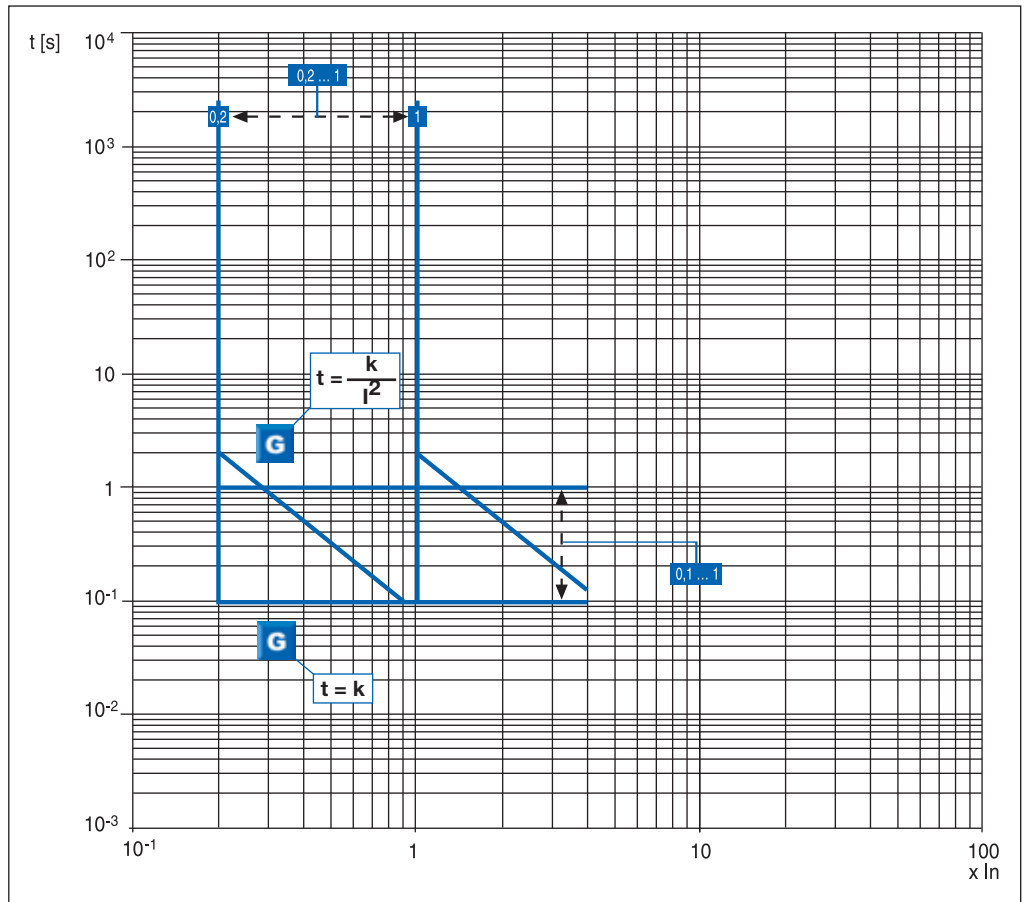

Function U

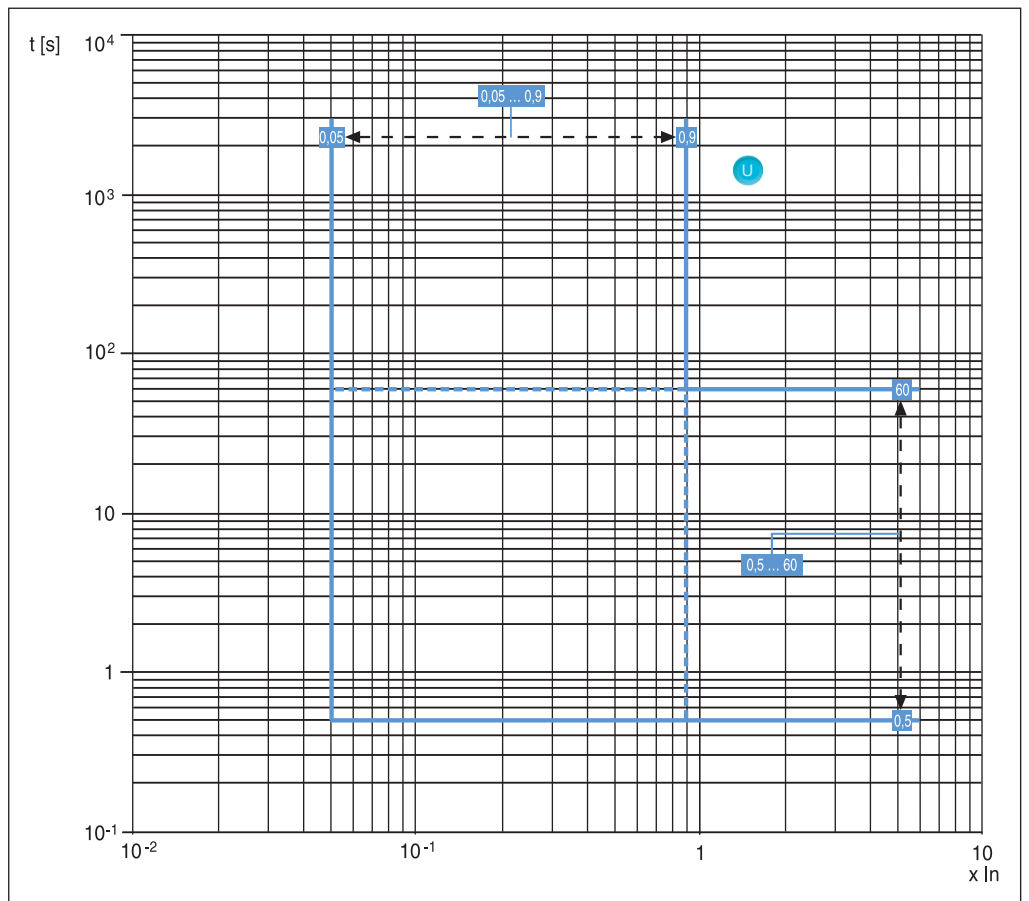

Protection trip units and trip curves

PR123/DC

Function RP

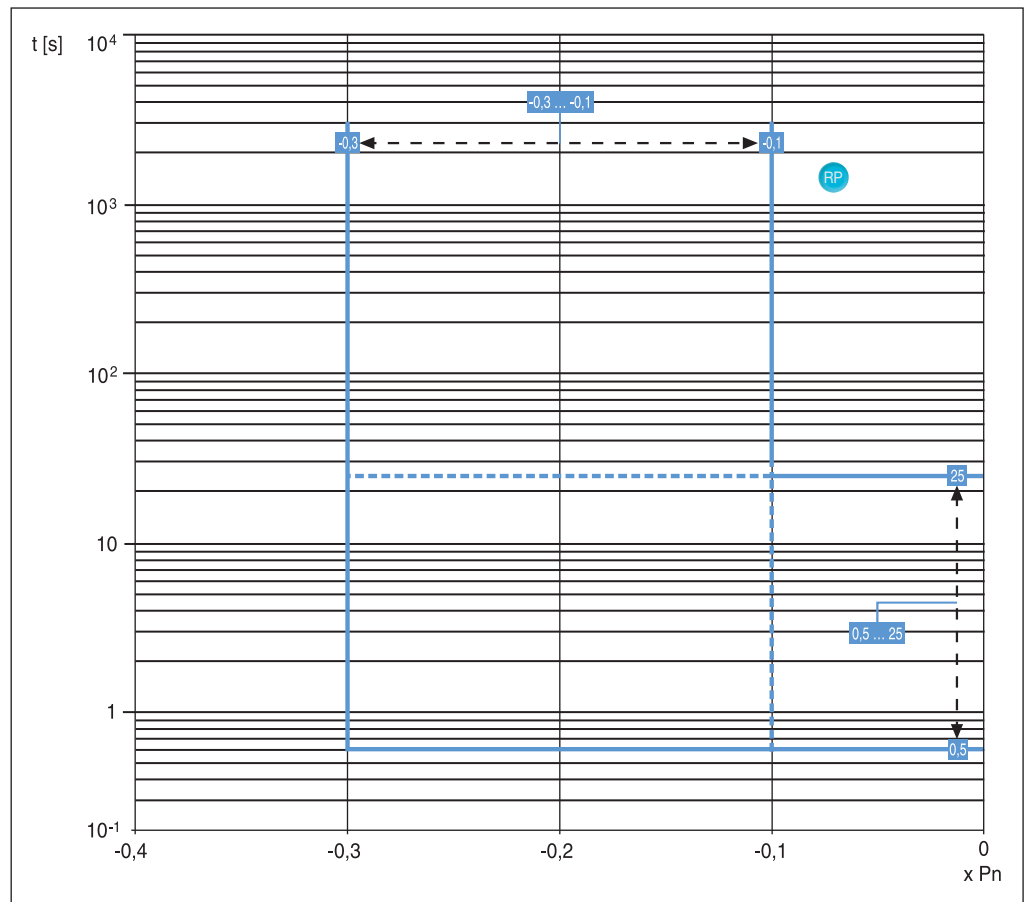

1SDC200013R0001

Function UV

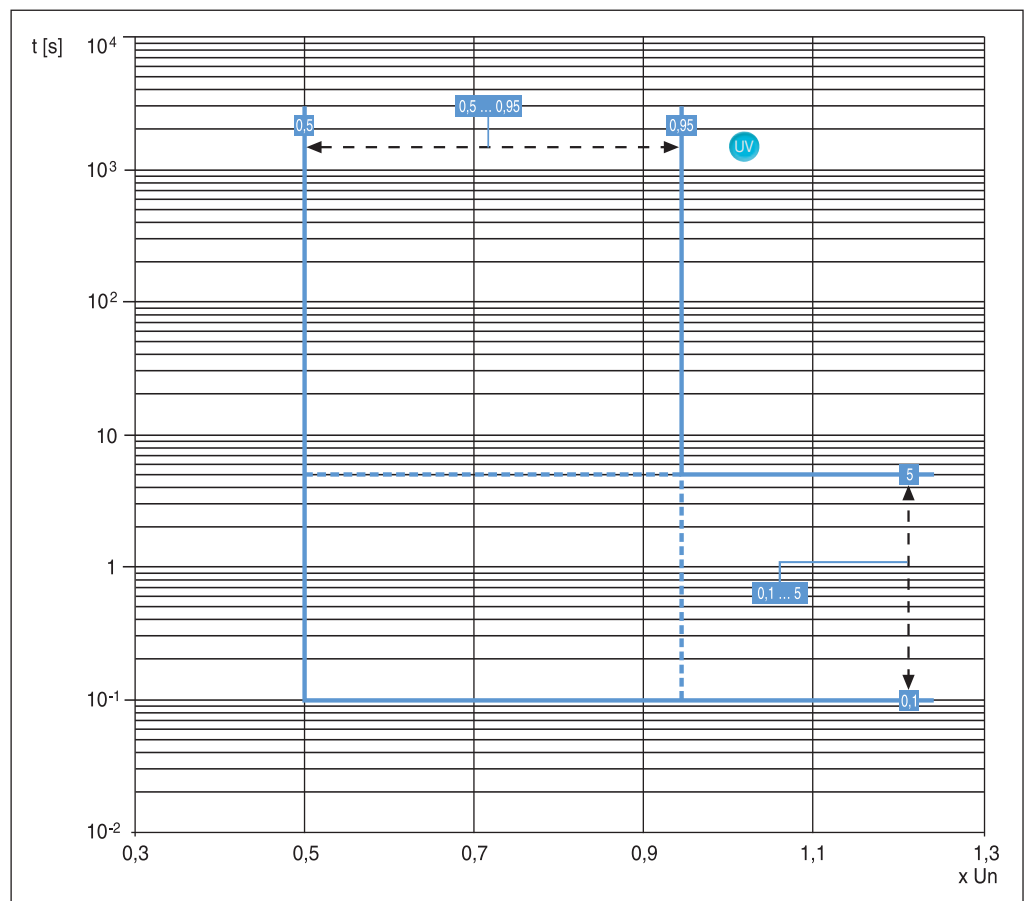

1SDC200014R0001

Function OV

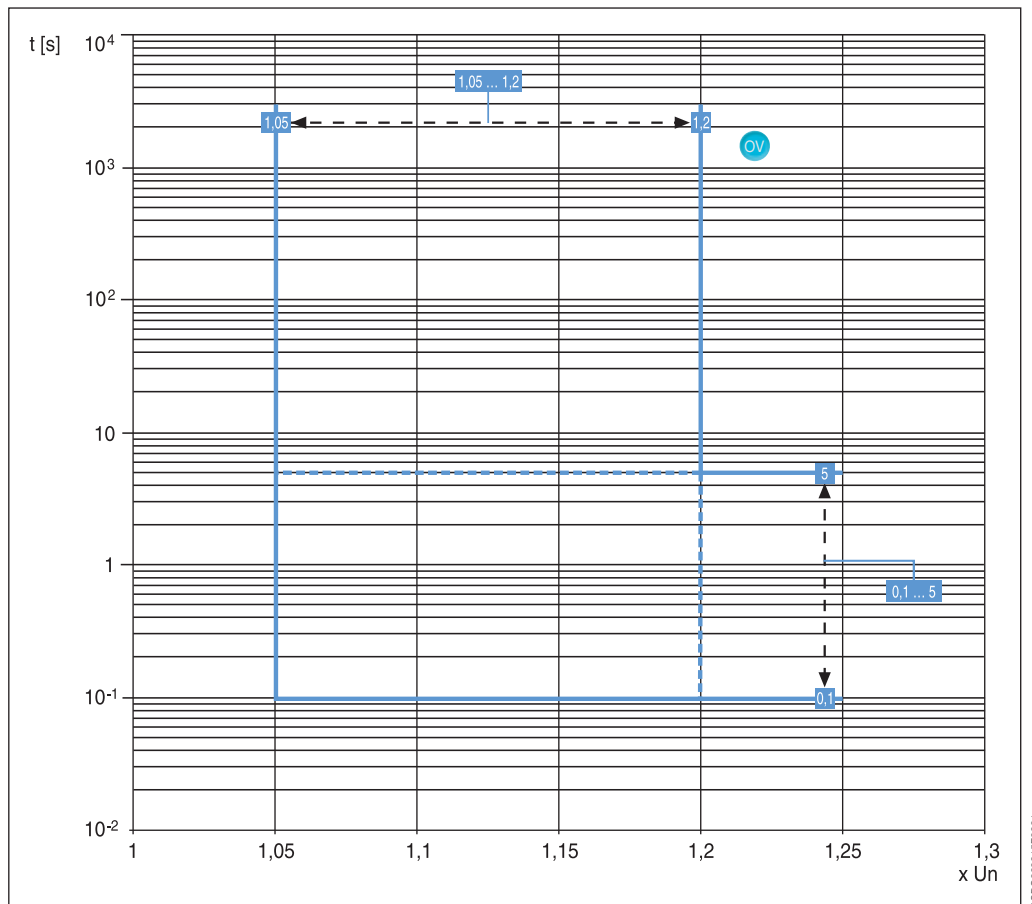

1SDC20012D0202

Protection trip units and trip curves

PR122/DC and PR123/DC: optional modules

The PR122/DC and PR123/DC electronic trip units can be fitted with the following optional modules, which are already available on the PR122/P and PR123/P electronic devices for alternating current applications.

Code	Internal	Description	PR122/DC PR123/DC
1SDA058255R1	PR120/K	Internal indication module (4 outputs with independent terminals)	■
1SDA058256R1	PR120/K	Internal indication module (4 outputs + input with common terminal)	■
1SDA058254R1	PR120/D-M	Modbus RTU communication module	■
1SDA065223R1 ⁽¹⁾	PR120/LV	Measurement module for low voltage (100...250V DC)	■

⁽¹⁾ Extracode to be specified with the circuit-breaker code to order the PR120/LV low voltage measurement module instead of the PR120/LV. The PR120/LV measurement module and the PR120/DC override protection module are always supplied with the electronic trip units.

Code	External	Description	PR122/DC PR123/DC
1SDA058258R1	PR030/B	Power supply unit	■
1SDA058259R1	BT030-USB	External wireless communication unit (without wires)	■
1SDA048964R1	PR010/T	External test unit	■
1SDA059146R1	PR021/K	External indication unit	■

Protection trip units and trip curves

Measurement

PR122/DC

The following measurements are available:

- Current;
- Instantaneous value of the current over a period of time (data logger);
- Maintenance: Number of operations, percentage of contact wear, storage of opening data (last 20 trips and 80 events);
- Historical data of the maximum values of current reading.

PR123/DC

- Current;
- Maintenance: Number of operations, percentage of contact wear, storage of opening data (last 20 trips and 80 events);
- Voltage;
- Instantaneous value of the current/voltage over a period of time (Data Logger);
- Power;
- Energy;
- Historical data of the maximum values of current reading, the maximum voltage and the minimum voltage, the total maximum value and the average value of the power.

Protection trip units and trip curves

Functions

The functions available on the PR122/DC and PR123/DC electronic trip units fitted with Modbus PR120/D-M communication module are listed in the following table.

	PR122/DC + PR120/D-M	PR123/DC + PR120/D-M
Communication functions		
Protocol	Modbus RTU	Modbus RTU
Physical layer	RS-485	RS-485
Maximum baud rate	19200 bps	19200 bps
Measurement functions		
Currents	■	■
Ground current		■
Voltage		■
Power		■
Energy		■
Indication functions		
LED: Auxiliary power supply, pre-alarm, alarm	■	■
Temperature	■	■
Indication for L, S, I (and G only with PR123/DC)	■	■
Data available		
Circuit-breaker status (open-closed)	■	■
Circuit-breaker position (racked-in, racked-out)	■	■
Mode (local, remote)	■	■
Protection parameters set	■	■
Load control parameters	■	■
Alarms		
Protection L	■	■
Protection S	■	■
Protection I	■	■
Protection G		■
Fault release mechanism failure	■	■
Under- and overvoltage protection (timing and trip)		■
Reverse power protection (timing and trip)		■
Maintenance		
Total number of operations	■	■
Total number of trips	■	■
Number of trip tests	■	■
Number of manual operations	■	■
Number of separate trips for each protection function	■	■
Contact wear (%)	■	■
Recording data of the last 20 trips	■	■
Controls		
Circuit-breaker open/close	■	■
Reset alarms	■	■
Setting of curves and protection thresholds	■	■
Synchronize system time	■	■
Events		
Status changes in circuit-breaker protections and all alarms	■	■

Accessories

Electrical and mechanical accessories

Accessories*

The SACE Emax DC family of circuit-breakers can be fitted with the following electrical and mechanical accessories, which are already available for the standard family of circuit-breakers for alternating current applications.

Ranges	Circuit-breakers		Switch-disconnectors for applications up to 1000V DC	
	Fixed	Withdrawable	Fixed	Withdrawable
1a) Shunt opening/closing release (YO/YC) and second opening release (YO2)	■	■	■	■
1b) SOR test unit (test unit)	■	■	■	■
2a) Undervoltage release (YU)	■	■	■	■
2b) Time-delay device for undervoltage release (D)	■	■	■	■
3) Geared motor for automatic charging of the closing springs (M)	■	■	■	■
4a) Electrical signalling of electronic trip unit tripped	■	■		
4b) Electrical signalling of electronic trip unit tripped with remote resetting control		■	■	
5b) External supplementary electrical signalling of circuit-breaker open/closed	■	■	■	■
5c) Electrical signalling of circuit-breaker racked-in/racked-out test/racked-out		■		■
5d) Signalling contact for closing springs charged	■	■	■	■
5e) Signalling contact for undervoltage release de-energised (C. Aux YU)	■	■	■	■
7) Mechanical operation counter	■	■	■	■
8a) Lock in open position: key	■	■	■	■
8b) Lock in open position: padlocks	■	■	■	■
8c) Circuit-breaker lock in racked-in/racked-out/test isolated position		■		■
8d) Accessories for lock in of racked-out/test isolated position		■		■
8e) Accessory for shutters padlock device		■		■
8f) Mechanical lock for compartment door	■	■	■	■
9a) Protection for opening and closing pushbuttons	■	■	■	■
9b) IP54 door protection	■	■	■	■
10) Interlock between circuit-breakers	■	■	■	■

CAPTION

- Optional accessory on fixed circuit-breaker or on moving part
- Optional accessory on fixed part
- Optional accessory on moving part

* For further information on the accessories, please consult the Emax catalogue: Circuit-breakers \ low voltage air.

Overall dimensions

Fixed circuit-breaker

Basic version with vertical rear terminals

POWER SUPPLY FROM UPPER TERMINALS ⑥

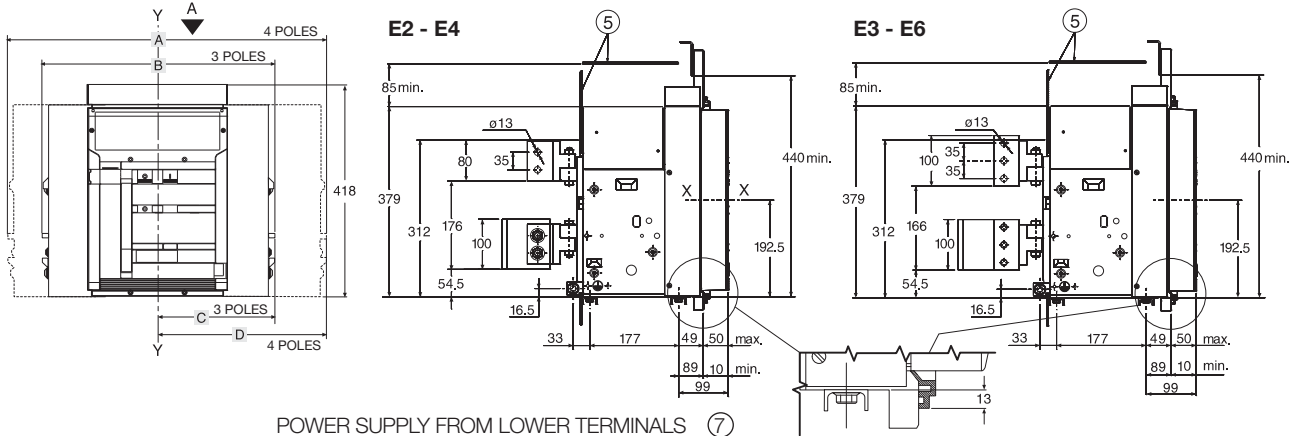

POWER SUPPLY FROM LOWER TERMINALS ⑦

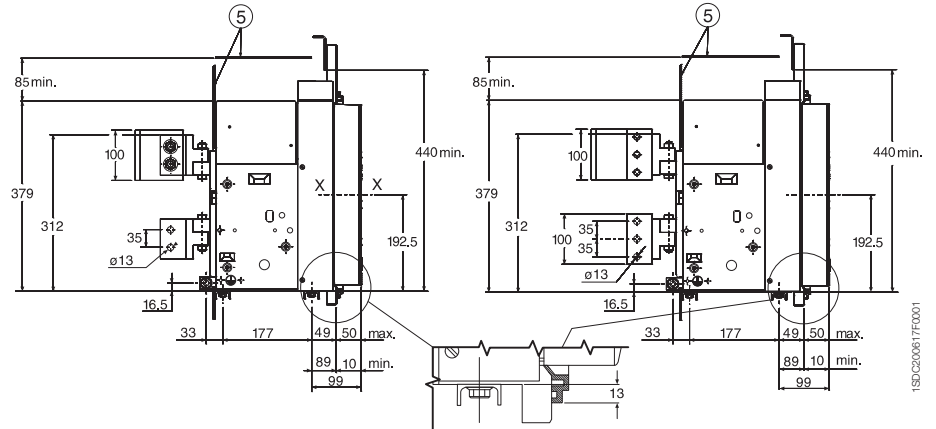

Caption

- ① Inside edge of compartment door
- ② Partition (where provided)
- ③ Circuit-breaker fixing M10 drilling (use M10 screws)
- ④ N. 1 M12 screw (E1, E2, E3) or n. 2 M12 screws (E4, E6) for earthing (included in the supply)
- ⑤ Insulating or metallic wall
- ⑥ For power input to the UPPER terminals – PR120/V internal connection on the upper terminals and rear U connection kit on the lower terminals
- ⑦ For power input to the LOWER terminals – PR120/V internal connection on the lower terminals and rear U connection kit on the upper terminals

E2 III
View A

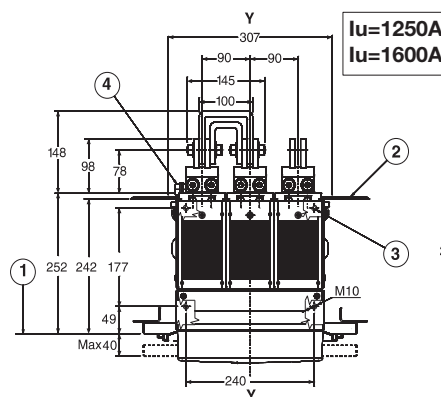

E2 IV
View A

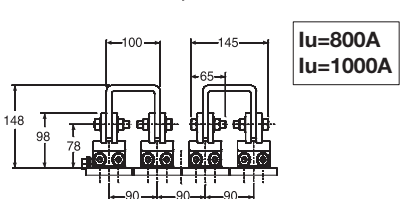
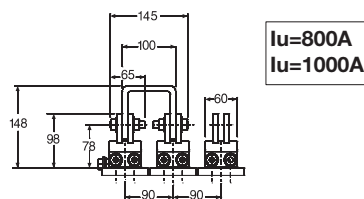
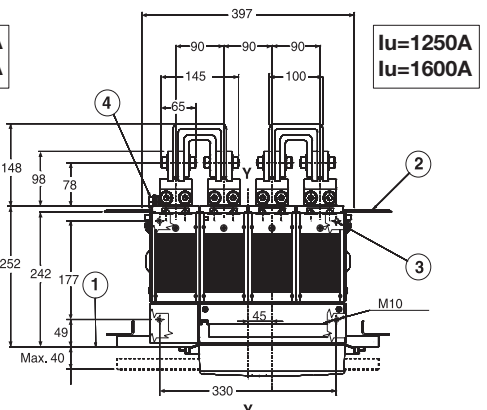

	A	B	C	D
E2	386	296	148	148
E3	530	404	202	202
E4	746	566	238	328
E6	1034	782	328	454

E3 III
View A

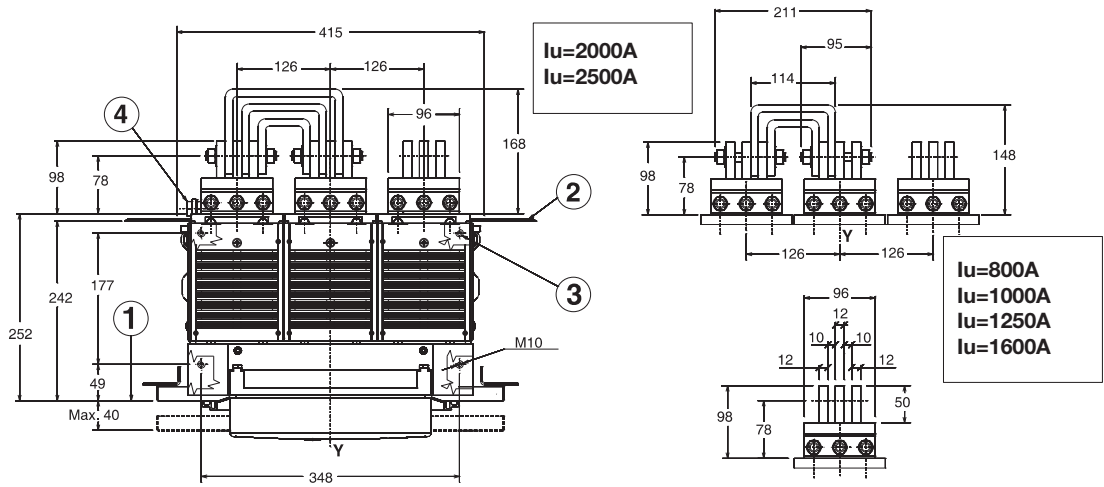

E3 IV
View A

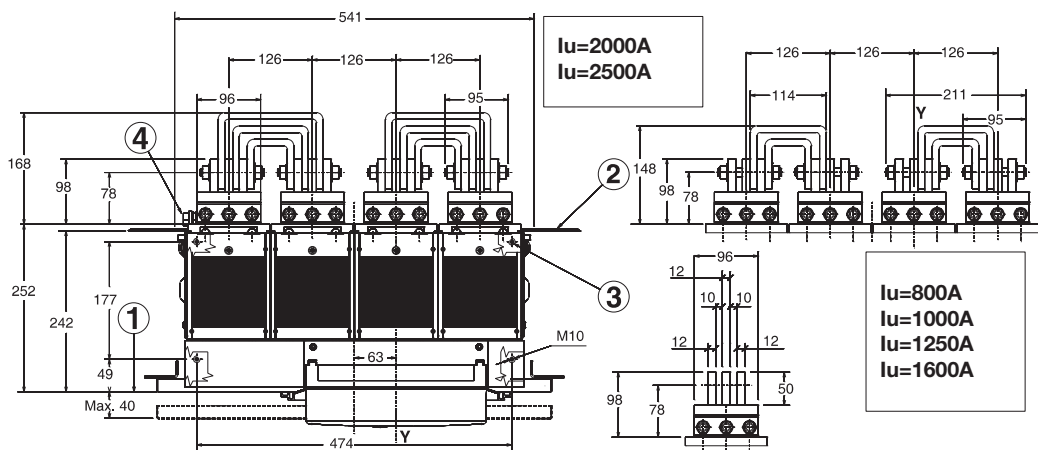

E4 III
View A

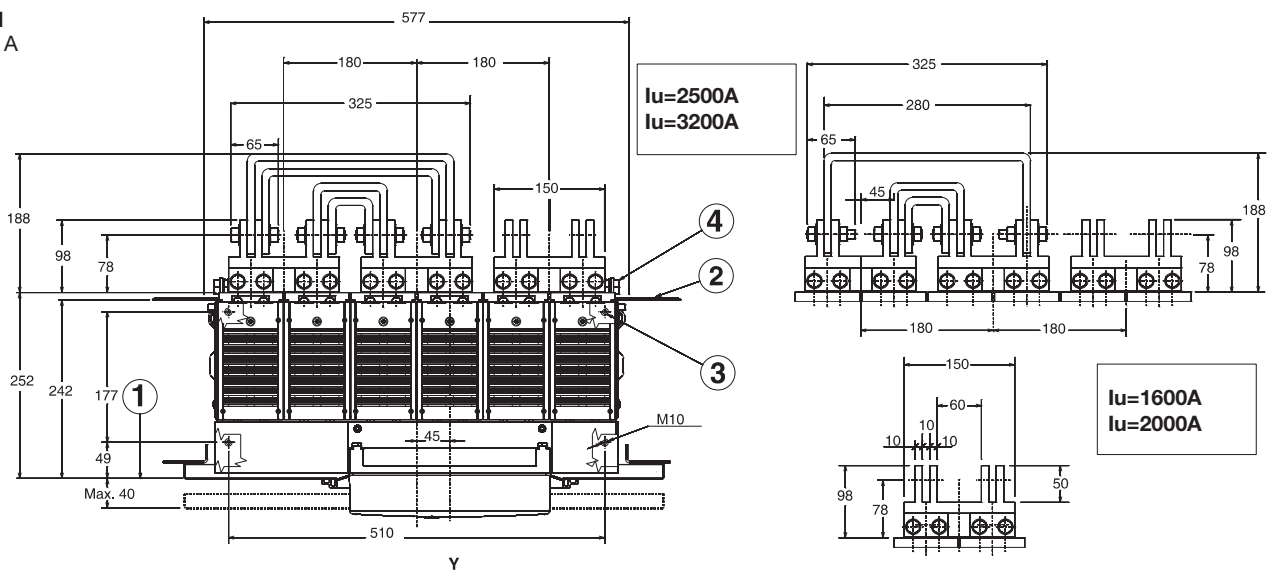

Overall dimensions

Fixed circuit-breaker

Basic version with vertical rear terminals

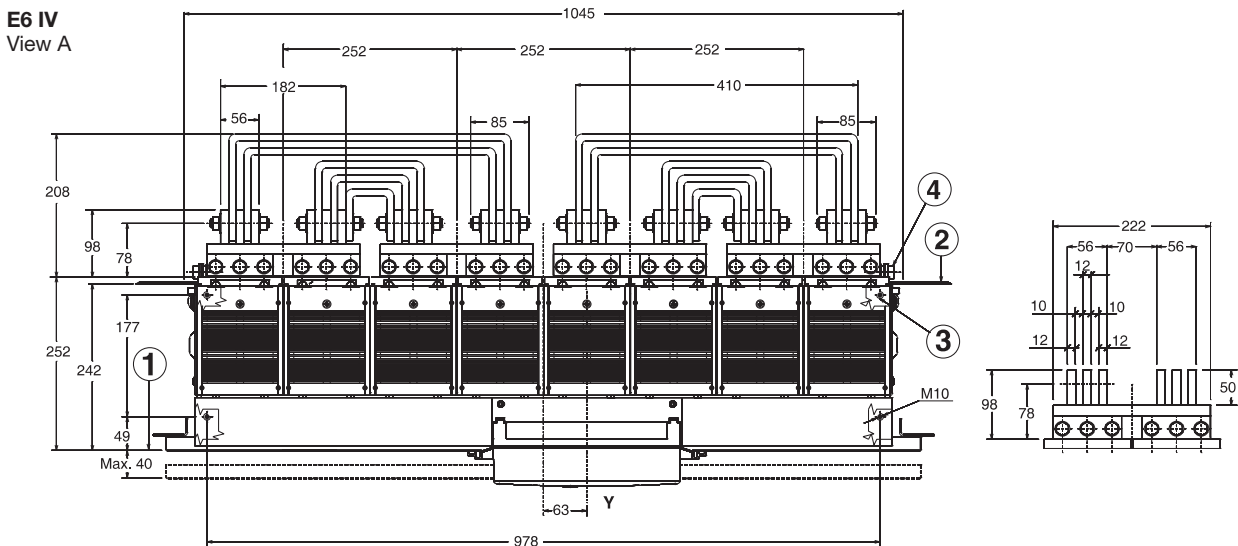
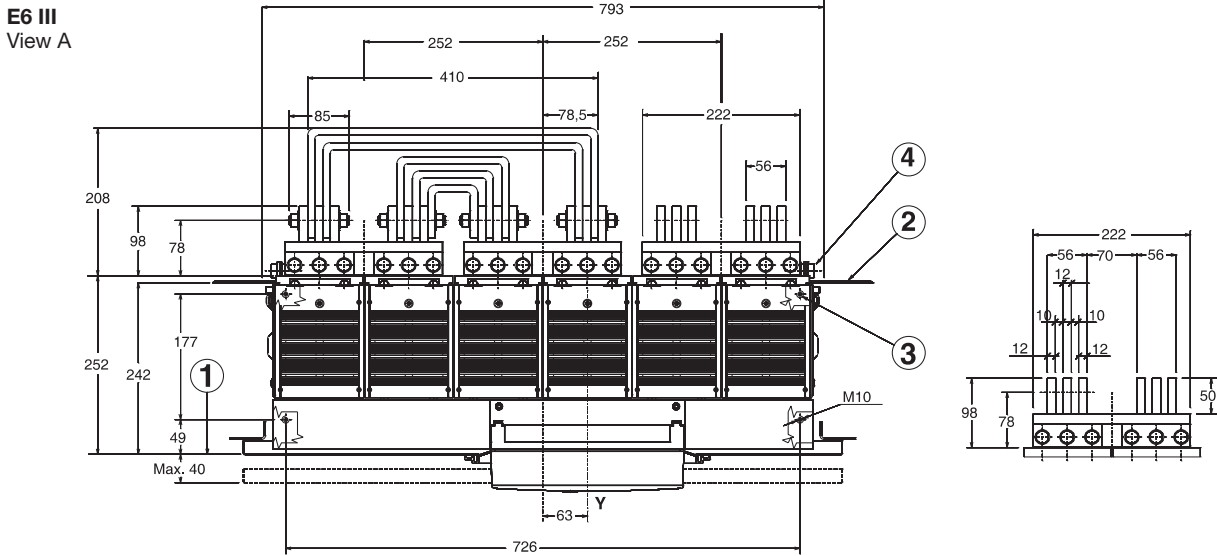
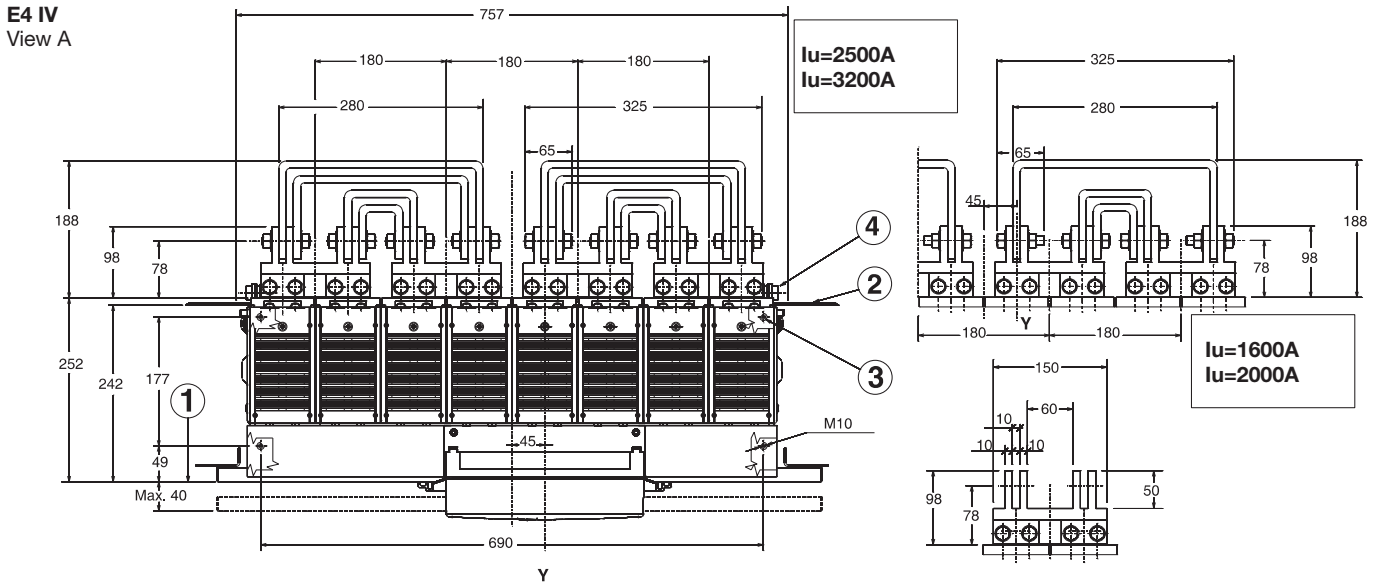

1SDC200012D02001

Compartment dimensions

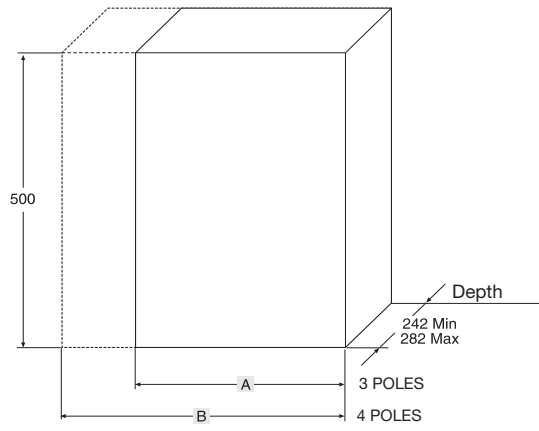

	A	B
E2	400	490
E3	500	630
E4	700	880
E6	1000	1260

Through-holes for flexible cables for mechanical interlocks

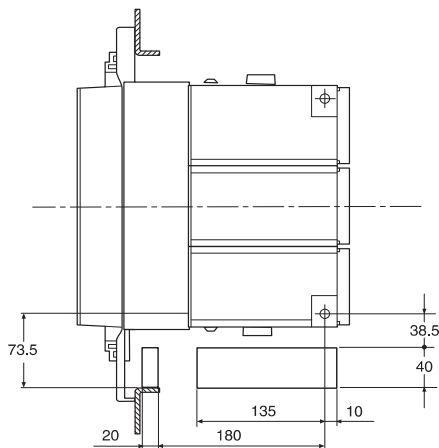

Drilling of compartment door

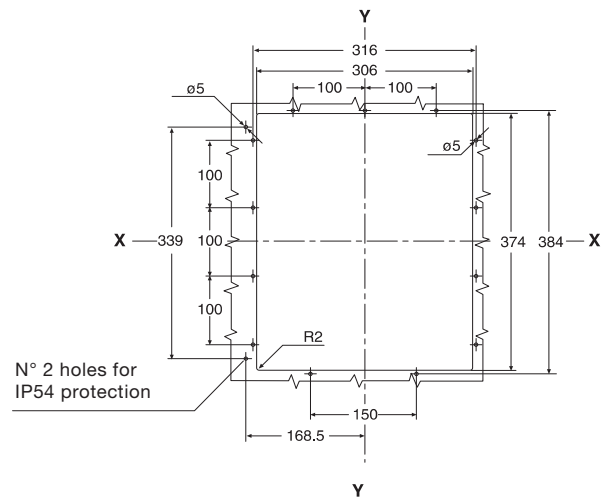

1SDC200012D0001

Overall dimensions

Withdrawable circuit-breaker

Basic version with rear vertical terminals

POWER SUPPLY FROM UPPER TERMINALS ⑥

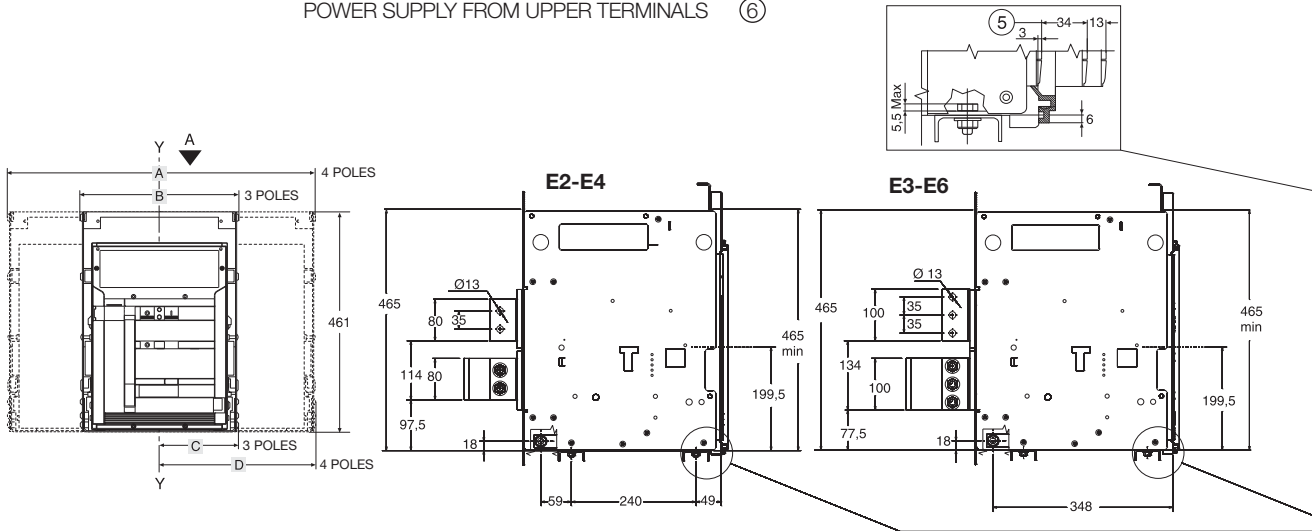

POWER SUPPLY FROM LOWER TERMINALS ⑦

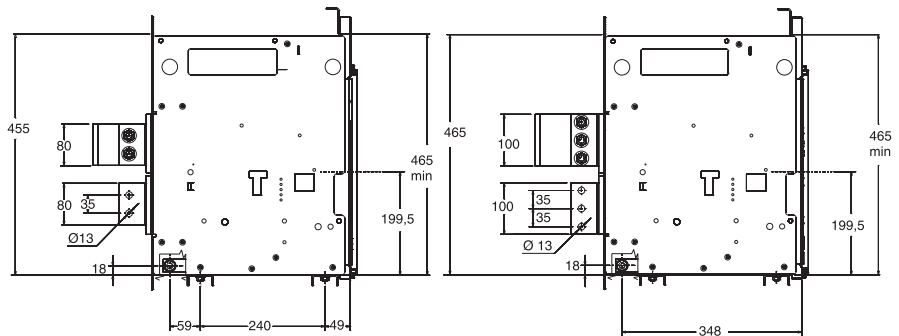

Caption

- ① Inside edge of compartment door
- ② Segregation (where provided)
- ③ Circuit-breaker fixing M10 drilling (use M10 screws)
- ④ N. 1 M12 screw (E1, E2, E3) or n. 2 M12 screws (E4, E6) for earthing (included in the supply)
- ⑤ Insulating wall or insulated metal wall
- ⑥ For power input to the UPPER terminals – PR120/V internal connection on the upper terminals and rear U connection kit on the lower terminals
- ⑦ For power input to the LOWER terminals – PR120/V internal connection on the lower terminals and rear U connection kit on the upper terminals

E2 III
View A

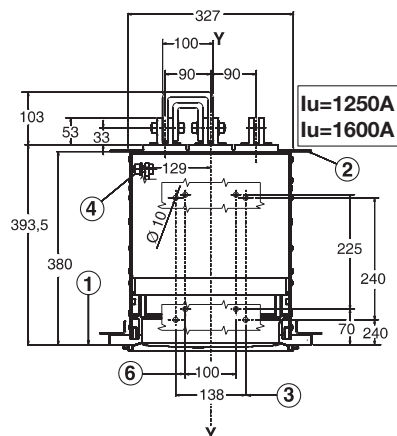

E2 IV
View A

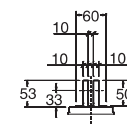
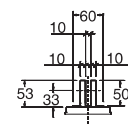
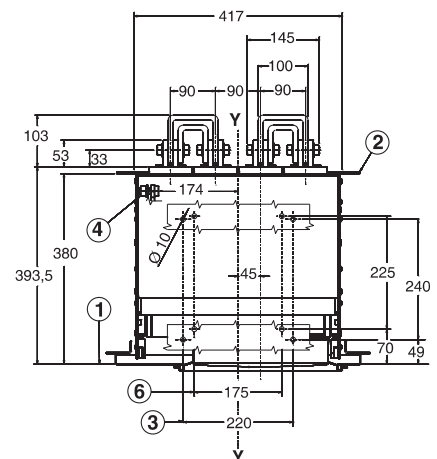

	A	B	C	D
E2	414	324	162	162
E3	558	432	216	216
E4	774	594	252	342
E6	1062	810	342	468

E3 III
View A

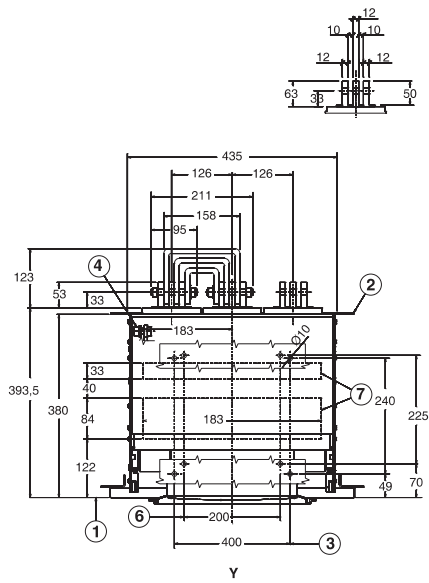

E3 IV
View A

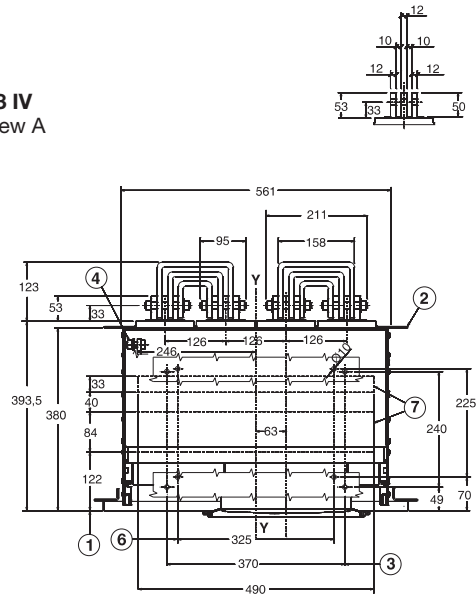

E4 III
View A

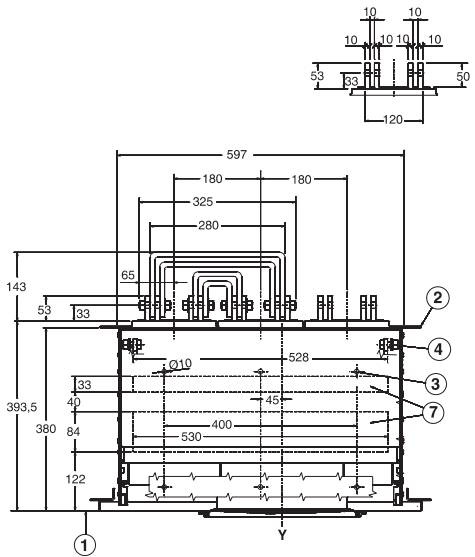

E4 IV
View A

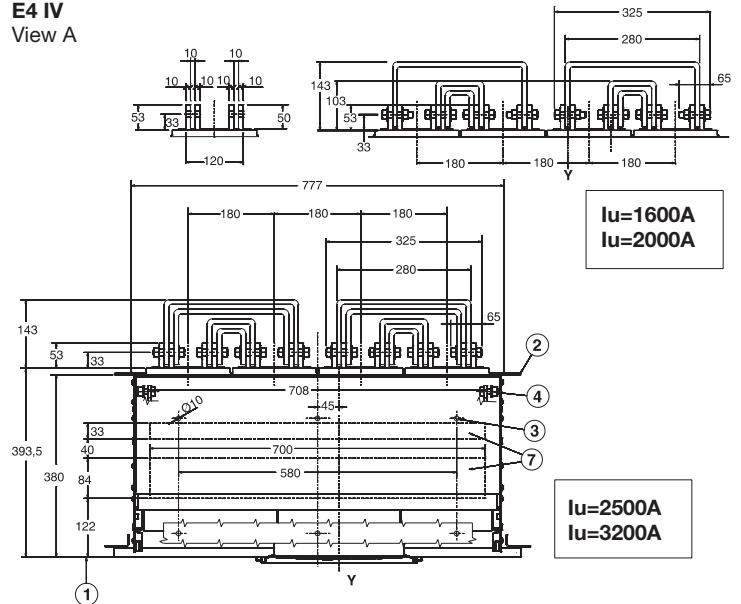

E6 III
View A

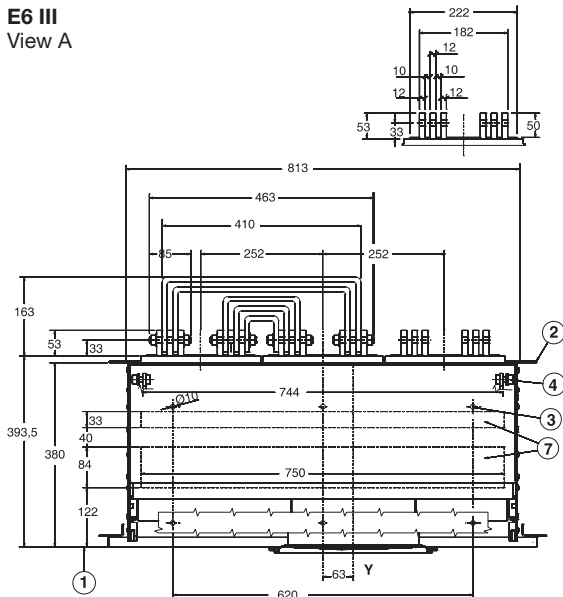

E6 IV
View A

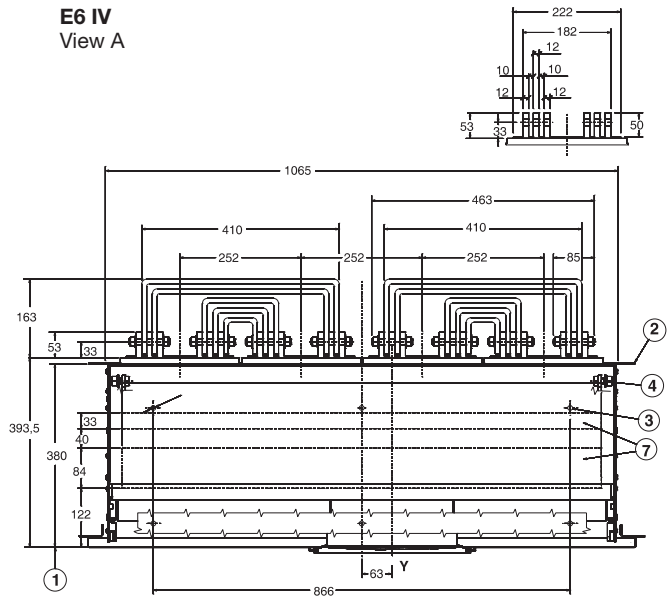

Overall dimensions

Withdrawable circuit-breaker

Basic version with rear horizontal terminals

POWER SUPPLY FROM UPPER TERMINALS ⑥

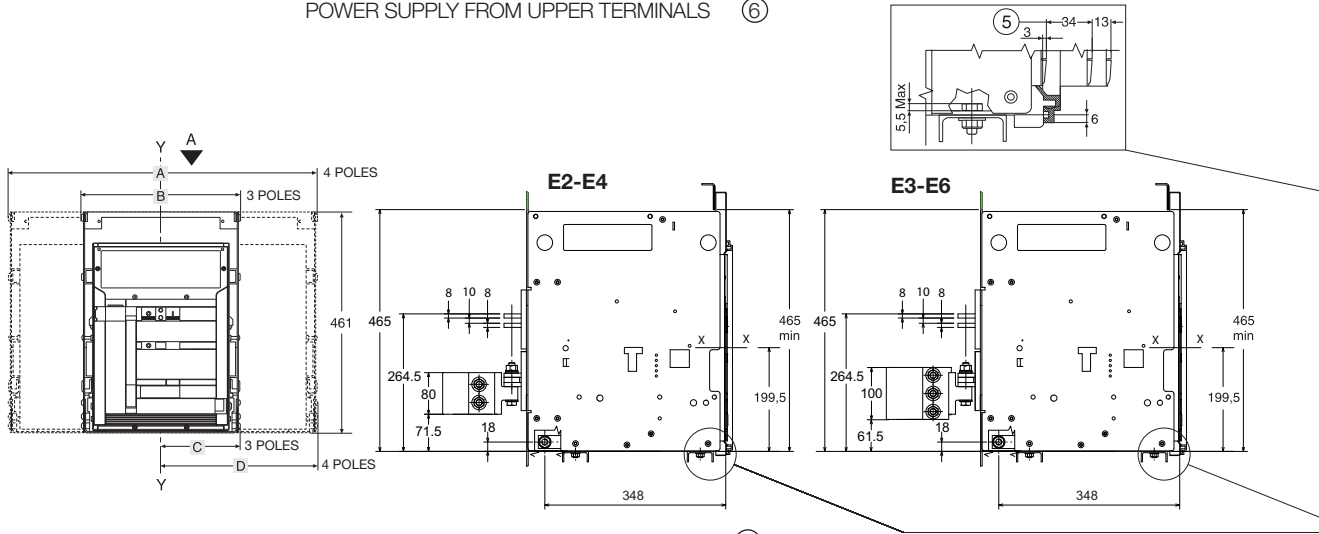

POWER SUPPLY FROM LOWER TERMINALS ⑦

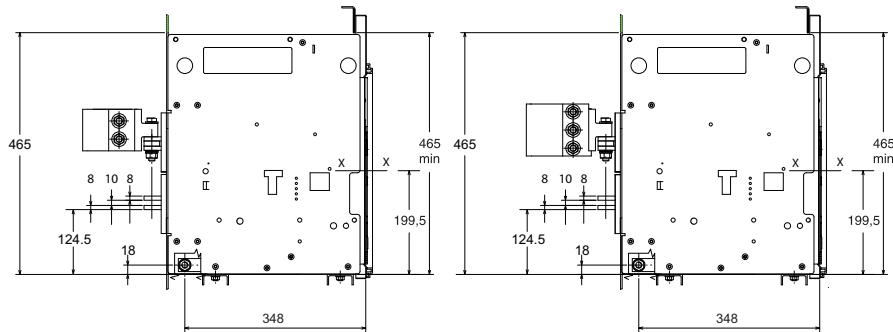

Caption

- ① Inside edge of compartment door
- ② Segregation (where provided)
- ③ Circuit-breaker fixing M10 drilling (use M10 screws)
- ④ N. 1 M12 screw (E1, E2, E3) or n. 2 M12 screws (E4, E6) for earthing (included in the supply)
- ⑤ Insulating wall or insulated metal wall
- ⑥ For power input to the UPPER terminals – PR120/V internal connection on the upper terminals and rear U connection kit on the lower terminals
- ⑦ For power input to the LOWER terminals – PR120/V internal connection on the lower terminals and rear U connection kit on the upper terminals

E2 III
View A

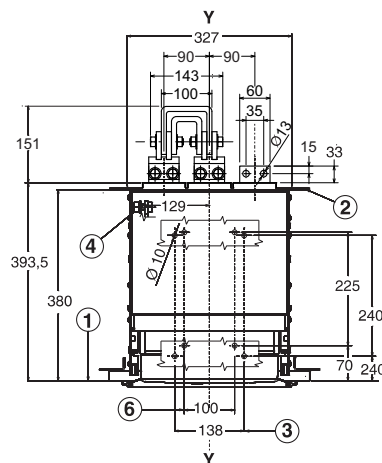

E2 IV
View A

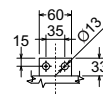
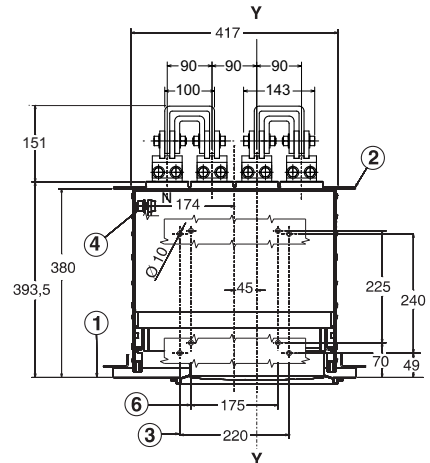

	A	B	C	D
E2	414	324	162	162
E3	558	432	216	216
E4	774	594	252	342
E6	1062	810	342	468

E3 III
View A

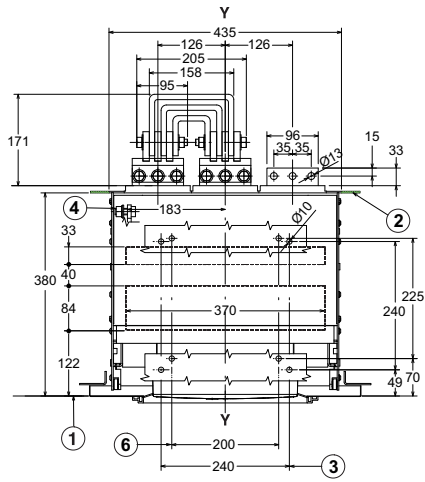

E3 IV
View A

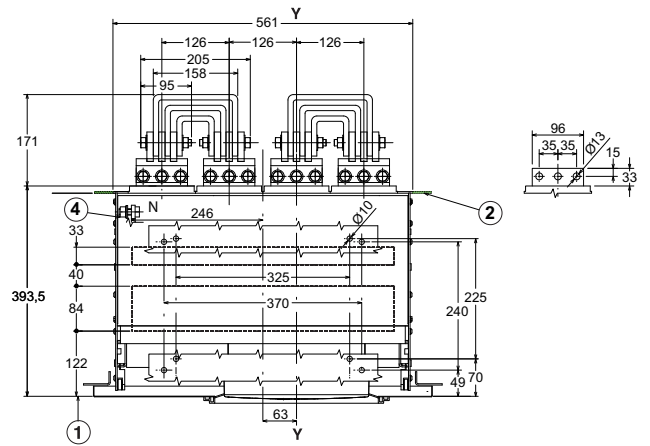

E4 III
View A

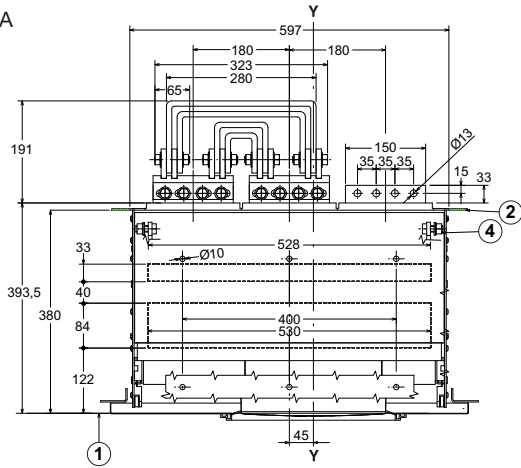

E4 IV
View A

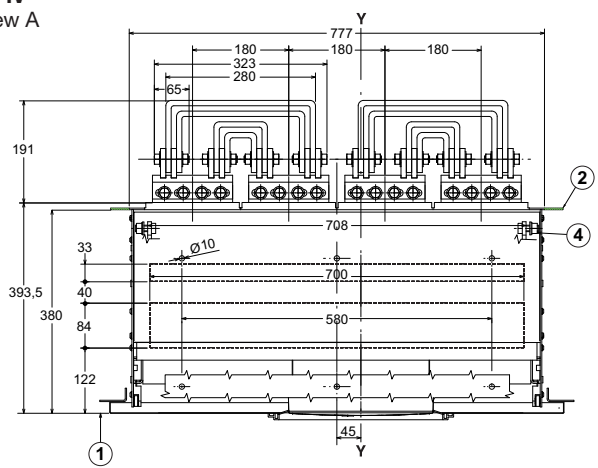

E6 III
View A

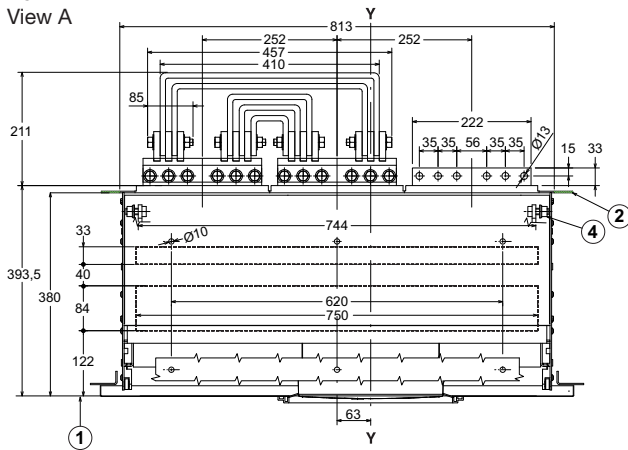

E6 IV
View A

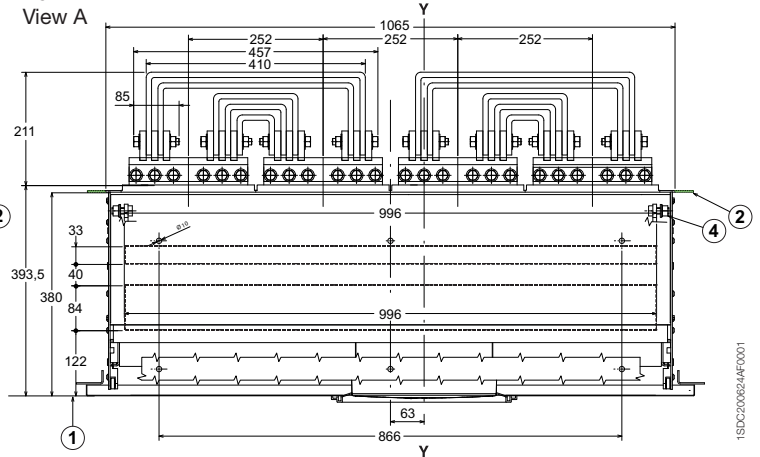

1SDC200012D0201

Overall dimensions

Circuit-breaker accessories

Compartment dimensions

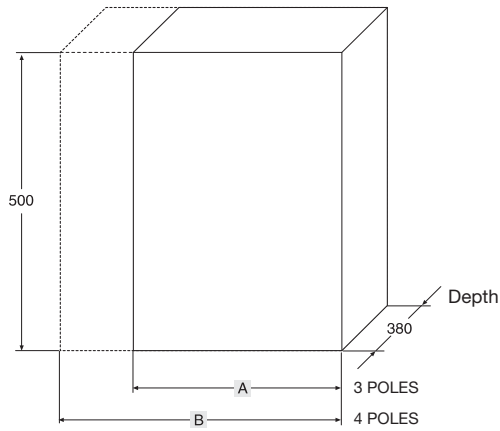

	A	B
E2	400	490
E3	500	630
E4	700	880
E6	1000	1260

Through-holes for flexible cables for mechanical interlocks

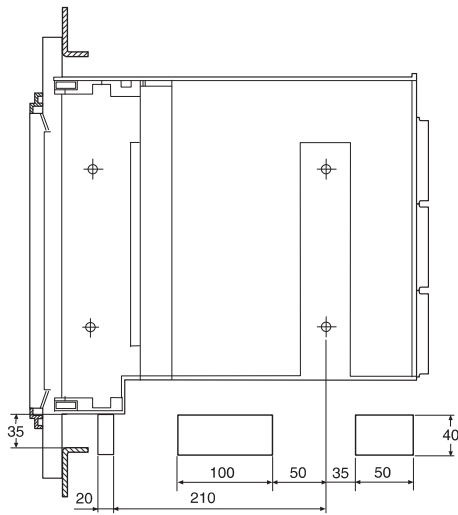

Drilling of compartment door

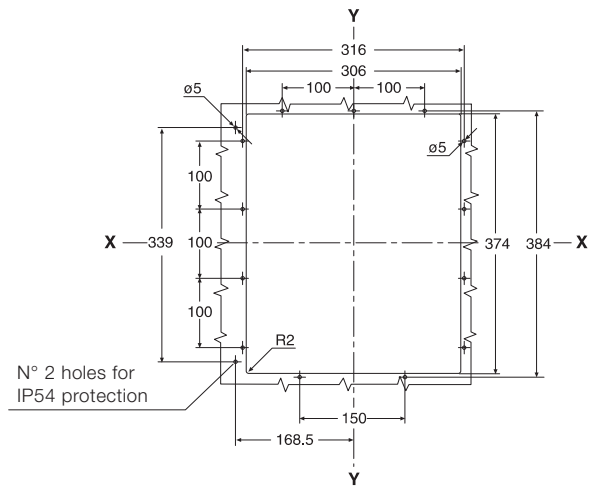

Mechanical compartment door lock

Compartment door drilling

	A	
	3 poles	4 poles
E2	180	180
E3	234	234
E4	270	360
E6	360	486

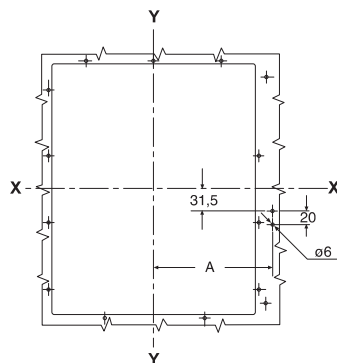

Minimum distance between circuit-breaker and switchboard wall

Fixed version

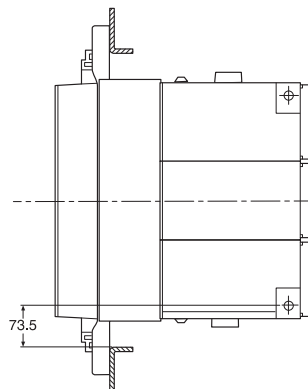

Withdrawable version

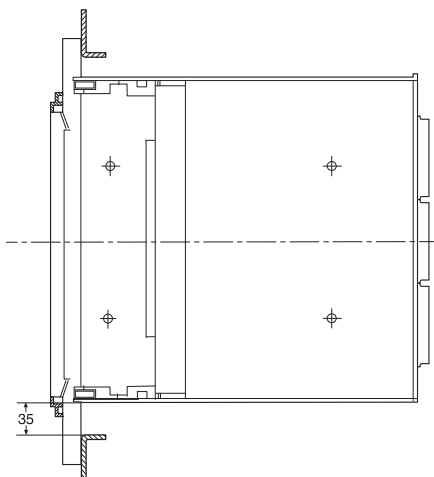

Electric wiring diagrams

Information for reading

Warning

Before installing the circuit-breaker, carefully read note F on the circuit diagrams.

Operating status shown

The circuit diagram is for the following conditions:

- withdrawable circuit-breaker, open and racked-in
- circuits de-energised
- releases not tripped
- motor operating mechanism with springs discharged.

Versions

Though the diagram shows a circuit-breaker in withdrawable version, it can be applied to a fixed version circuit-breaker as well.

Fixed version

The control circuits are fitted between terminals XV (connector X is not supplied).
With this version, the applications indicated in figures 31 and 32 cannot be provided.

Withdrawable version

The control circuits are fitted between the poles of connector X (terminal box XV is not supplied).

Version with PR122/DC electronic trip unit

Version with PR123/DC electronic trip unit

Caption

□	= Circuit diagram figure number
*	= See note indicated by letter
A1	= Circuit-breaker accessories
A3	= Accessories applied to the fixed part of the circuit-breaker (for withdrawable version only)
A4	= Example switchgear and connections for control and signalling, outside the circuit-breaker
D	= Electronic time-delay device of the undervoltage release, outside the circuit-breaker
F1	= Delayed-trip fuse
K51	= PR122/DC, PR123/DC electronic trip unit with the following protection functions: <ul style="list-style-type: none">- L overload protection with inverse long time-delay trip - setting I1- S short-circuit protection with inverse or definite short time-delay trip - setting I2- I short-circuit protection with instantaneous time-delay trip - setting I3- G earth fault protection with inverse short time-delay trip - setting I4
K51/1...8	= Contacts of the PR021/K signalling unit
K51/GZin	= Zone selectivity: input for protection G (only with Uaux. and PR123/DC trip unit)
K51/GZout	= Zone selectivity: output for protection G (only with Uaux. and PR123/DC trip unit)
K51/IN1	= Digital programmable input (available only with Uaux and PR122/DC or PR123/DC trip unit with indicator module PR120/K)
K51/P1...P4	= Programmable electrical signalling (available only with Uaux and PR122/DC or PR123/DC trip unit with indicator module PR120/K)
K51/SZin	= Zone selectivity: input for protection S (only with Uaux. And PR123/DC trip unit)
K51/SZout	= Zone selectivity: output for protection S (only with Uaux. And PR123/DC trip unit)
K51/YC	= Closing control from PR122/DC or PR123/DC electronic trip unit with communication module PR120/D-M
K51/YO	= Opening control from PR122/DC or PR123/DC electronic trip unit with communication module PR120/D-M
M	= Motor for charging the closing springs
Q	= Circuit-breaker
Q/1...27	= Circuit-breaker auxiliary contacts
S33M/1...3	= Limit contacts for spring-charging motor
S43	= Switch for setting remote/local control
S51	= Contact for electrical signalling of circuit-breaker open due to tripping of the overcurrent release. The circuit-breaker may be closed only after pressing the reset pushbutton, or after energizing the coil for electrical reset (if available).
S75E/1...4	= Contacts for electrical signalling of circuit-breaker in racked-out position (only with withdrawable circuit-breakers)
S75I/1...5	= Contacts for electrical signalling of circuit-breaker in racked-in position (only with withdrawable circuit-breakers)
S75T/1...4	= Contacts for electrical signalling of circuit-breaker in test isolated position (only with withdrawable circuit-breakers)
SC	= Pushbutton or contact for closing the circuit-breaker
SO	= Pushbutton or contact for opening the circuit-breaker
SO1	= Pushbutton or contact for opening the circuit-breaker with delayed trip
SO2	= Pushbutton or contact for opening the circuit-breaker with instantaneous trip
SR	= Pushbutton or contact for electrical circuit-breaker reset

Electric wiring diagrams

Information for reading

W1	= Serial interface with control system (external bus): EIA RS485 interface (see note E)
W2	= Serial interface with the accessories of PR122/DC and PR123/DC trip units (internal bus)
X	= Delivery connector for auxiliary circuits of withdrawable version circuit-breaker
X1...X7	= Connectors for the accessories of the circuit-breaker
XF	= Delivery terminal box for the position contacts of the withdrawable circuit-breaker (located on the fixed part of the circuit-breaker)
XK1	= Connector for power circuits of PR122/DC and PR123/DC trip units
XK2 - XK3	= Connectors for auxiliary circuits of PR122/DC and PR123/DC trip units
XK4	= Connector signalling open/closed contact
XK5	= Connector for PR120/V module
XO	= Connector for YO1 release
XV	= Delivery terminal box for the auxiliary circuits of the fixed circuit-breaker
YC	= Shunt closing release
YO	= Shunt opening release
YO1	= Overcurrent shunt opening release
YO2	= Second shunt opening release (see note Q)
YR	= Coil to electrically reset the circuit-breaker
YU	= Undervoltage release (see notes B and Q)

Description of figures

Fig. 1	= Motor circuit to charge the closing springs.
Fig. 2	= Circuit of shunt closing release.
Fig. 4	= Shunt opening release.
Fig. 6	= Instantaneous undervoltage release (see notes B and Q).
Fig. 7	= Undervoltage release with electronic time-delay device, outside the circuit-breaker (see notes B and Q)
Fig. 8	= Second shunt opening release (see note Q).
Fig. 11	= Contact for electrical signalling of springs charged.
Fig. 12	= Contact for electrical signalling of undervoltage release energized (see notes B and S).
Fig. 13	= Contact for electrical signalling of circuit-breaker open due to tripping of the overcurrent release. The circuit-breaker may be closed only after pressing the reset pushbutton.
Fig. 14	= Contact for electrical signalling of circuit-breaker open due to tripping of the overcurrent release and electrical reset coil. The circuit-breaker may be closed only after pressing the reset pushbutton or energizing the coil.
Fig. 21	= First set of circuit-breaker auxiliary contacts.
Fig. 22	= Second set of circuit-breaker auxiliary contacts (see note V).
Fig. 23	= Third set of supplementary auxiliary contacts outside the circuit-breaker.
Fig. 31	= First set of contacts for electrical signalling of circuit-breaker in racked-in, test isolated, racked-out position.
Fig. 32	= Second set of contacts for electrical signalling of circuit-breaker in racked-in, test isolated, racked-out position.
Fig. 42	= Auxiliary circuits of PR122/DC and PR123/DC trip units (see notes F, M and V).
Fig. 45	= Circuits of the communication module PR120/D-M of the PR122/DC and PR123/DC trip units (optional, see note E).
Fig. 46	= Circuits of the indicator module PR120/K of the PR122/DC and PR123/DC trip units - connection 1 (optional; see note V).
Fig. 47	= Circuits of the indicator module PR120/K of the PR122/DC and PR123/DC trip units - connection 2 (optional; see note V).
Fig. 62	= Circuits of the PR021/K signalling module (outside the circuit-breaker)

Incompatibilities

The circuits indicated in the following figures cannot be supplied simultaneously on the same circuit-breaker:







6 - 7 - 8
13 - 14
22 - 46 - 47

Notes

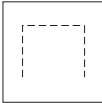
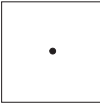
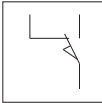
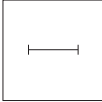
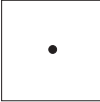
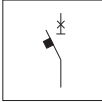
- A) The circuit-breaker is only fitted with the accessories specified in the ABB SACE order acknowledgement. Consult this catalogue for information on how to make out an order.
- B) The undervoltage release is supplied for operation using a power supply branched on the supply side of the circuit-breaker or from an independent source. The circuit-breaker can only close when the release is energized (there is a mechanical lock on closing). If the same power supply is used for the closing and undervoltage releases and the circuit-breaker is required to close automatically when the auxiliary power supply comes back on, a 30 ms delay must be introduced between the undervoltage release accept signal and the energizing of the closing release. This may be achieved using an external circuit comprising a permanent make contact, the contact shown in fig. 12 and a time-delay relay.
- E) MODBUS map is available in the RE1134001 document
- F) The auxiliary voltage U_{aux} allows actuation of all operations of the PR122/DC and PR123/DC trip units. Having requested a U_{aux} insulated from earth, one must use "galvanically separated converters" in compliance with IEC 60950 (UL 1950) or equivalent standards that ensure a common mode current or leakage current (see IEC 478/1, CEI 22/3) not greater than 3.5 mA, IEC 60364-41 and CEI 64-8.
- N) With PR122/DC and PR123/DC trip units, the connections to the zone selectivity inputs and outputs must be made with a two-pole shielded and stranded cable (see user manual), no more than 300 m long. The shield must be earthed on the selectivity input side.
- P) With PR122/DC and PR123/DC trip units with communication module PR120/D-M, the power supply for coils YO and YC must not be taken from the main power supply. The coils can be controlled directly from contacts K51/YO and K51/YC with maximum voltages of 110-120 V DC and 240-250 V AC.
- Q) The second opening release may be installed as an alternative to the undervoltage release.
- S) Also available in the version with normally-closed contact
- V) If fig. 22 is present (second set of auxiliary contacts) simultaneously as PR122/DC or PR123/DC release, the contacts for the zone selectivity in fig. 42 (K51/Zin, K51/Zout, K51/Gzin and K51/Gzout) are not wired. In addition, the indicator module PR120/K in figures 46 and 47 cannot be supplied

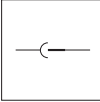
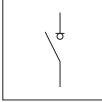
Electric wiring diagrams

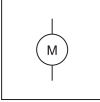
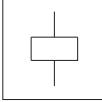
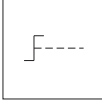
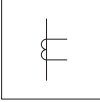
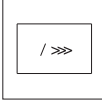
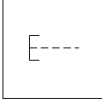
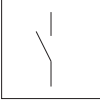
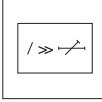
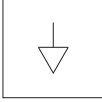
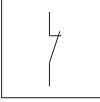
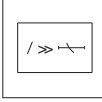
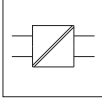
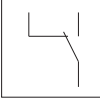
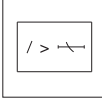
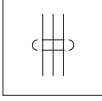
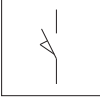
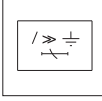
Graphic Symbols (IEC 606 7 and CEI 3- 4 ... 3-26 Standards)

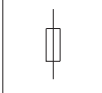
	Screen (can be drawn in any shape)		Connection of conductors		Changeover make before break position contact (limit switch)
	Timing		Terminal or clamp		Circuit-breaker-isolator with automatic opening
	Mechanical connection		Socket and plug (female and male)		Switch-disconnector
	Manual mechanical operating mechanism (general case)		Motor (general symbol)		Control coil (general symbol)
	Rotary operating mechanism		Current transformer		Instantaneous overcurrent relay
	Operating mechanism with pushbutton		Closing contact		Overcurrent relay with adjustable short time-delay characteristic
	Equipotentiality		Opening contact		Overcurrent relay with short inverse time-delay characteristic
	Galvanically separated converter		Changeover make before break position contact		Overcurrent relay with long inverse time-delay characteristic
	Shielded cable conductors (e.g. three conductors)		Closing position contact (limit switch)		Overcurrent relay for earth fault with short inverse time characteristic
	Conductors or corded cables (e.g. 3 conductors)		Opening position contact (limit switch)		Fuse (general symbol)

1SDC000028F0001

Electric wiring diagrams

Circuit-breakers

State of operation

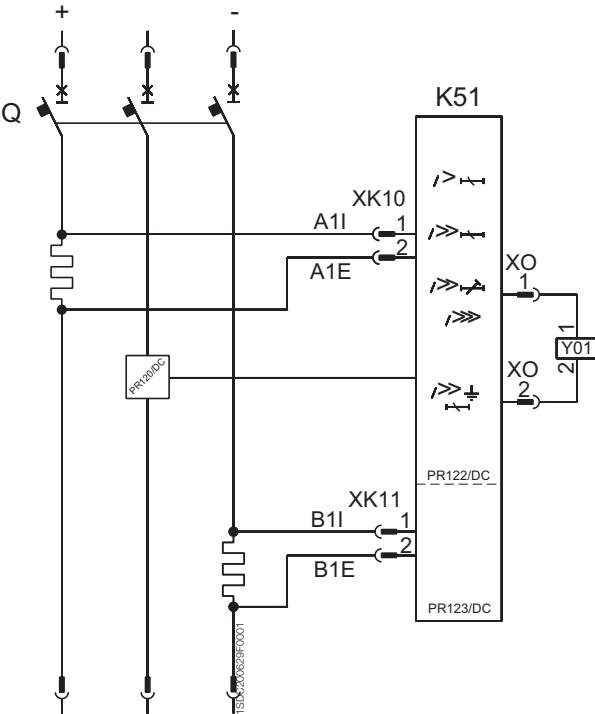

Three-pole circuit-breaker with electronic PR122/DC or PR123/DC trip unit

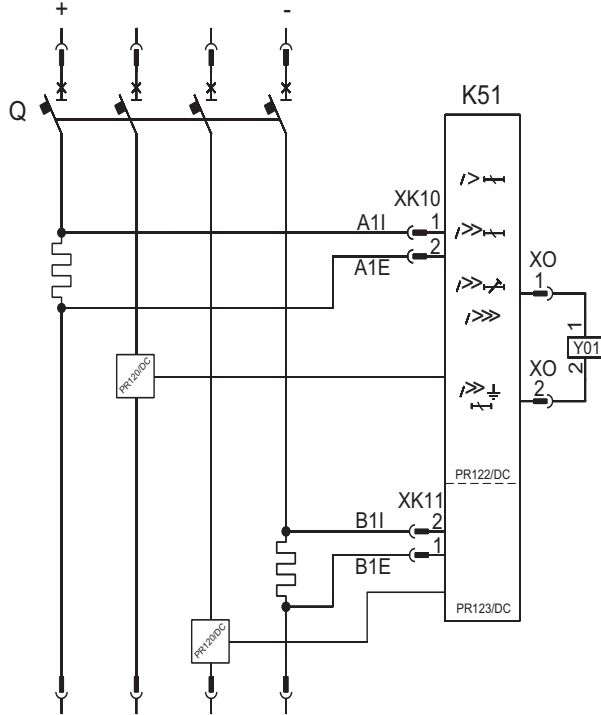

Four-pole circuit-breaker with electronic PR122/DC or PR123/DC trip unit

1SDC200012D0202

Electric wiring diagrams

Circuit-breakers

Motor operator, shunt opening, closing and undervoltage releases

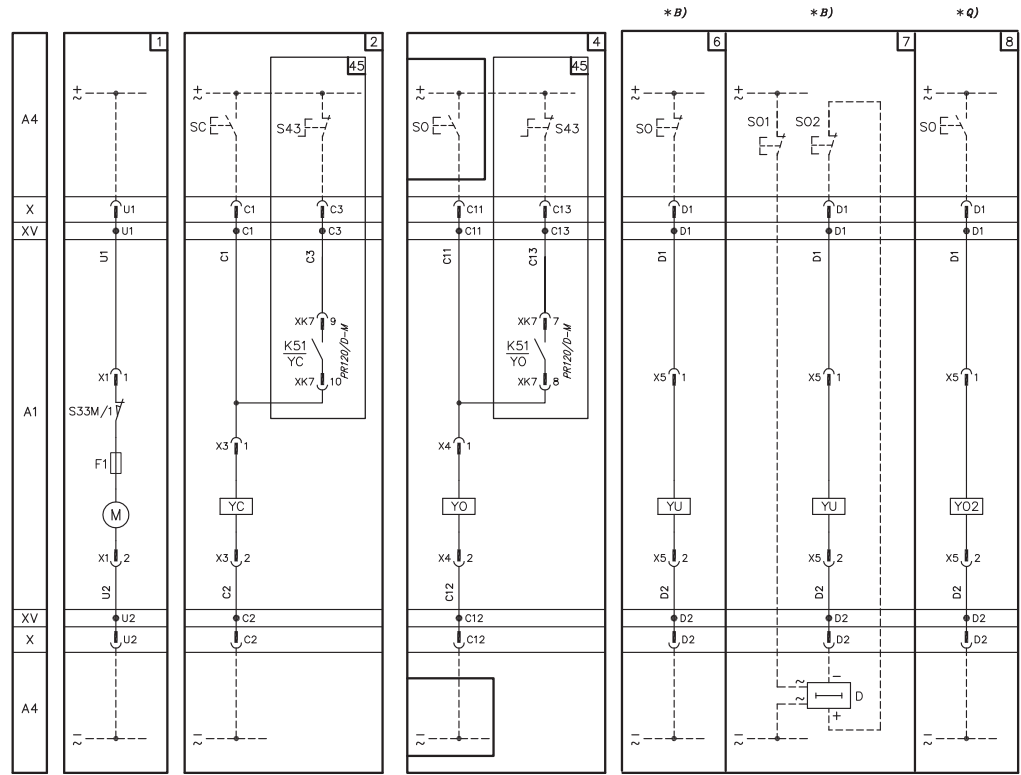

1SDC200039F0001

Signalling contacts

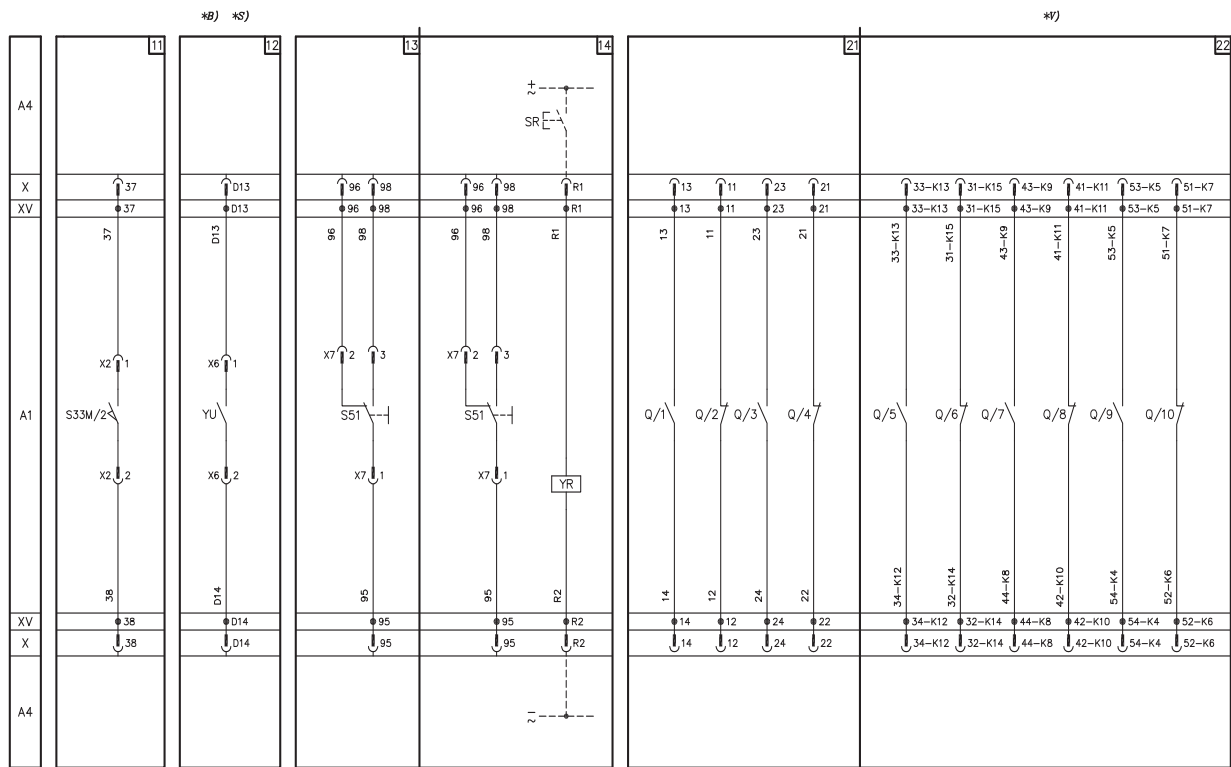

1SDC200039F0001

Signalling contacts

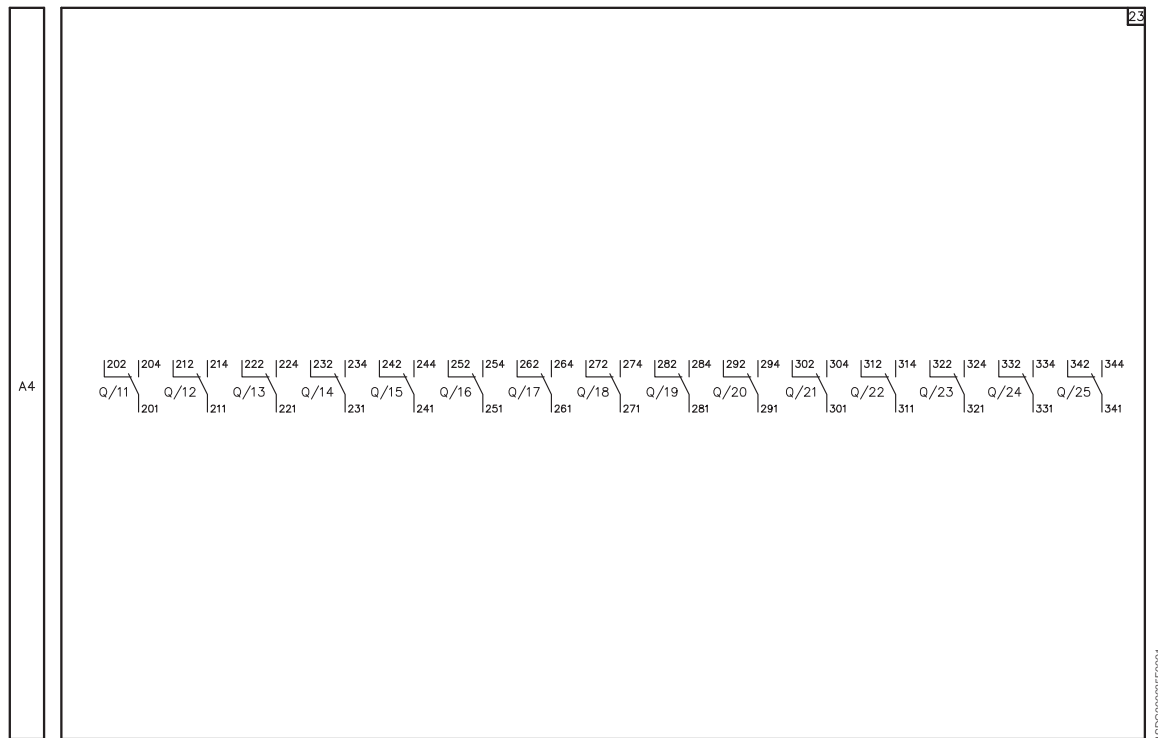

1SDC200012D020

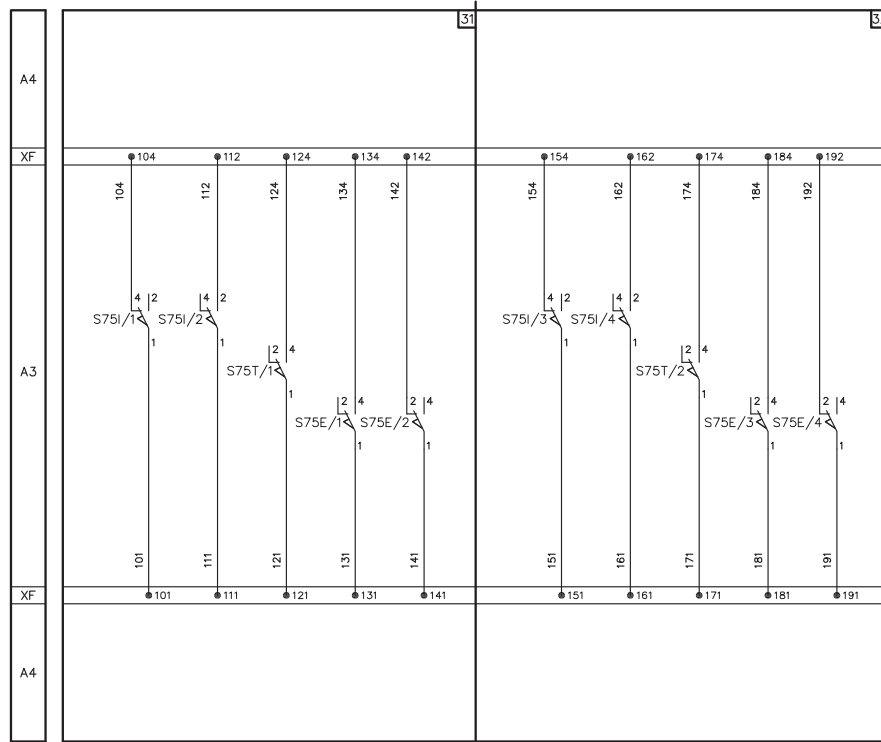

1SDC200012D020

Electric wiring diagrams

Circuit-breakers

Auxiliary circuits of the PR122/DC and PR123/DC trip units

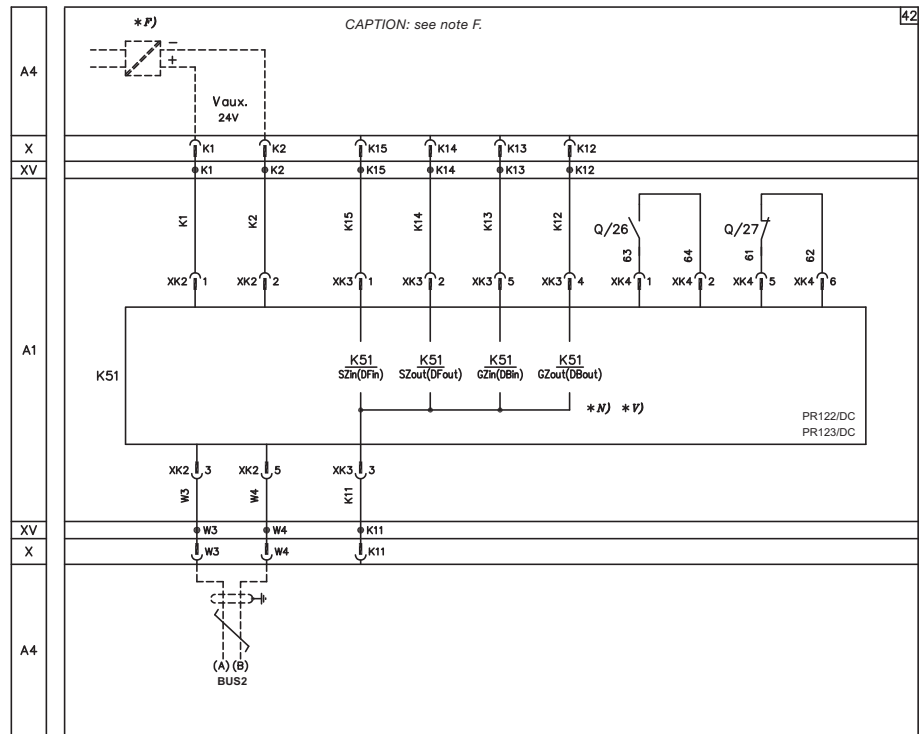

PR120/D-M communication module

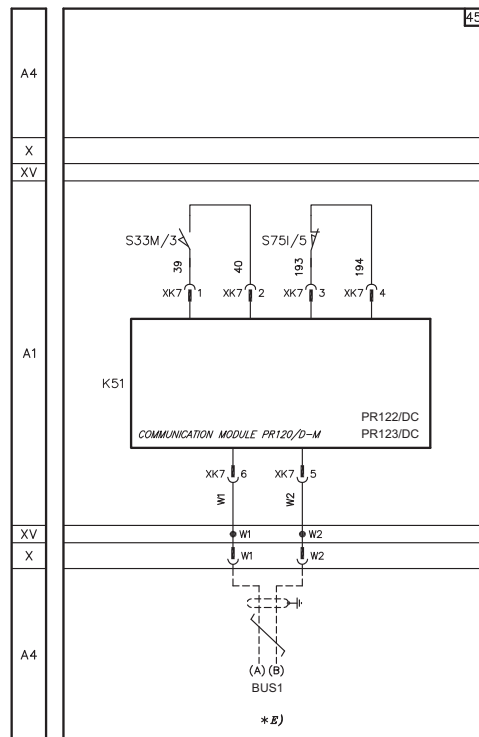

PR120/K signalling module

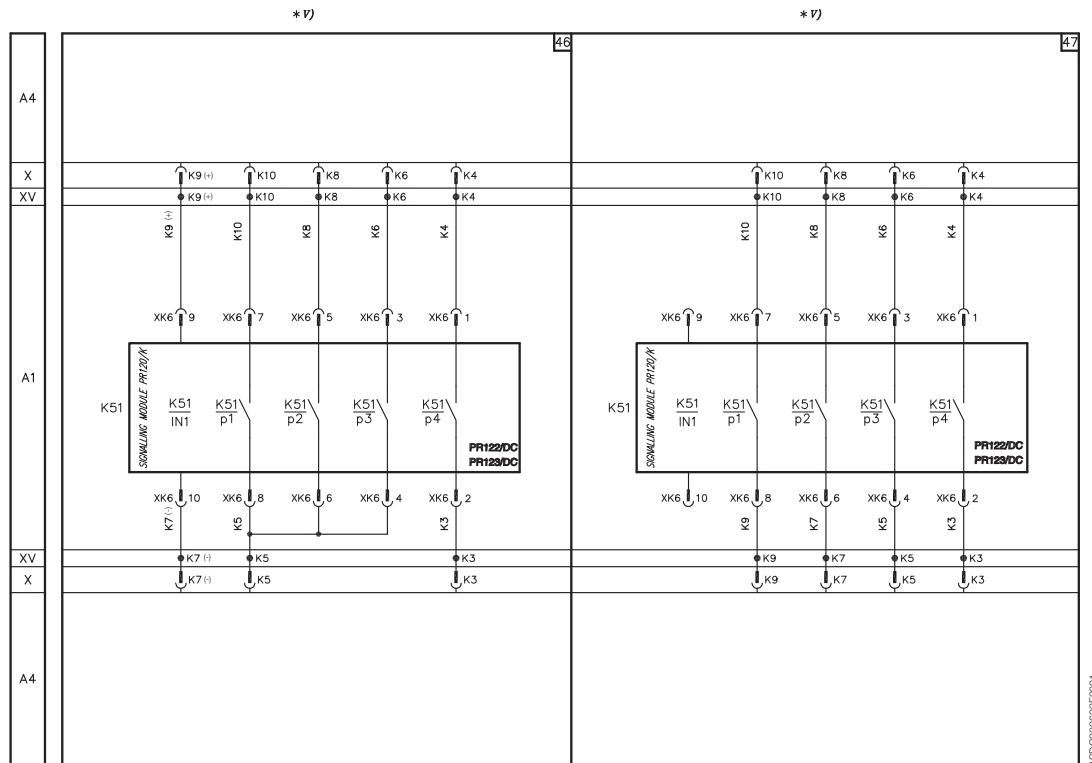

PR021/K signalling unit

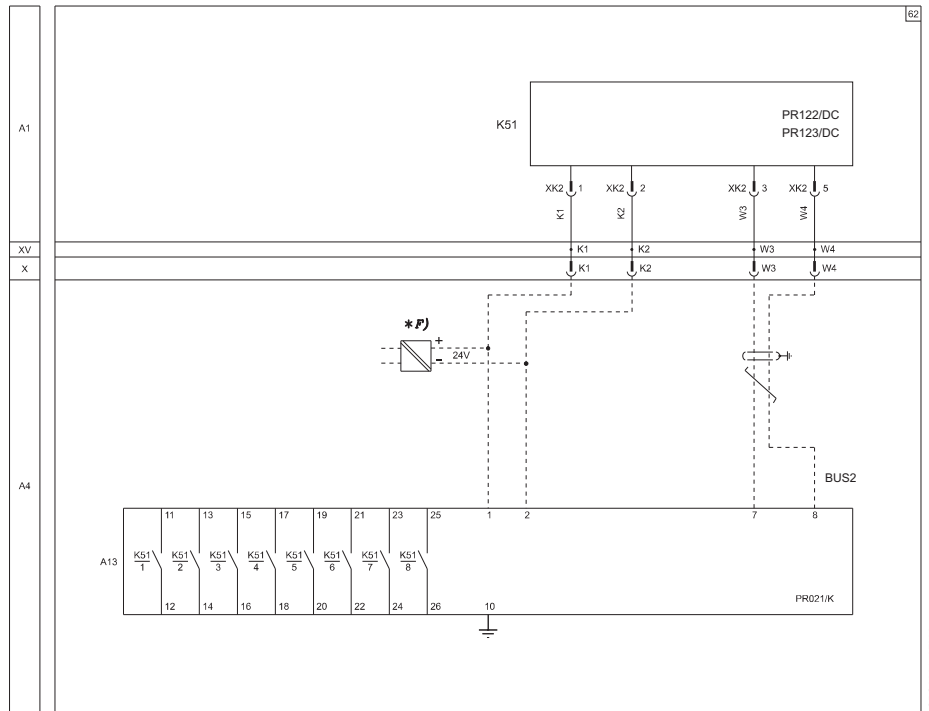





Selection of Emax DC

Emax DC circuit-breakers must be selected according to:

- 1) Type of network;
- 2) Rated current (I_u);
- 3) Rated voltage (U_e);
- 4) Short-circuit current (I_{cu});
- 5) Poles;
- 6) Version (Fixed - F - or Withdrawable - W);
- 7) Power supply (from the upper or lower terminals).

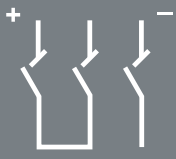



Plates:

POWER SUPPLY FROM UPPER TERMINALS

SACE E2B/E 800				$I_u=800A$	$U_e=750V$	Upper Supply	
U_e	(V)	500	750			IEC 60947-2 Made in Italy by ABB SACE 	
$I_{cu}=I_{cs}$	(KA)	35	25				
I_{cw} (0.5s)	(KA)	35	25				
Cat. B		3P 					

1SDC20009F0001

POWER SUPPLY FROM THE LOWER TERMINALS

SACE E2B/E 800				$I_u=800A$	$U_e=750V$	Lower Supply	
U_e	(V)	500	750			IEC 60947-2 Made in Italy by ABB SACE 	
$I_{cu}=I_{cs}$	(KA)	35	25				
I_{cw} (0.5s)	(KA)	35	25				
Cat. B		3P 					

1SDC20009F0001

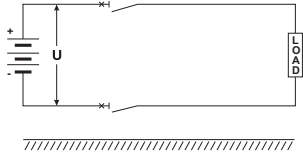
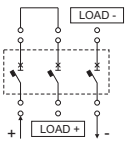
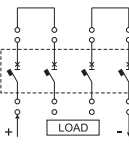
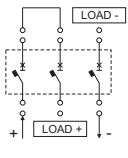
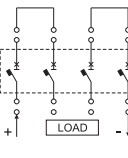
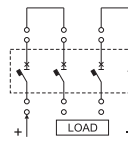
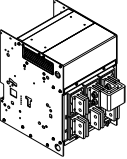
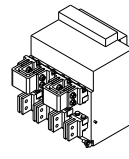
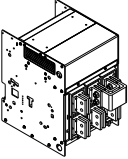
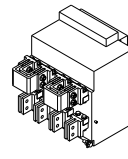
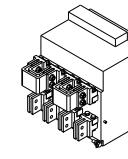
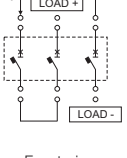
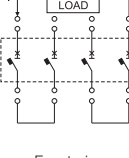
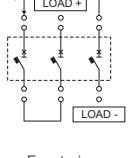
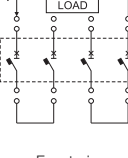
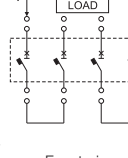
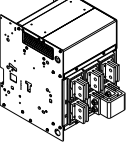
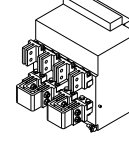
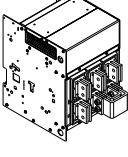
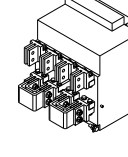
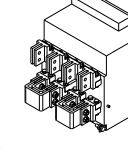
INSULATED NETWORK					
	Rated voltage (Ue)	Ue ≤ 500		500V ≤ Ue ≤ 750V	750V ≤ Ue ≤ 1000V
POLES	3p	4p	3p	4p	4p
Power supply from lower terminals (Lower Supply)	 Front view	 Front view	 Front view	 Front view	 Front view
	 3D rear view	 3D rear view	 3D rear view	 3D rear view	 3D rear view
Power supply from upper terminals (Upper Supply)	 Front view	 Front view	 Front view	 Front view	 Front view
	 3D rear view	 3D rear view	 3D rear view	 3D rear view	 3D rear view
PR122/DC	■	■	■	■	■
PR123/DC	■	■	■	■	■

Selection of Emax DC

NETWORK WITH EARTHED MID-POINT				
	Rated voltage (Ue)	Ue ≤ 500V	500V ≤ Ue ≤ 750V	750V ≤ Ue ≤ 1000V
Poles	3p	4p	4p	4p
Power supply from lower terminals (Lower Supply)	<p>Front view</p>	<p>Front view</p>	<p>Front view</p>	<p>Front view</p>
	<p>3D rear view</p>	<p>3D rear view</p>	<p>3D rear view</p>	<p>3D rear view</p>
Power supply from upper terminals (Upper Supply)	<p>Front view</p>	<p>Front view</p>	<p>Front view</p>	<p>Front view</p>
	<p>3D rear view</p>	<p>3D rear view</p>	<p>3D rear view</p>	<p>3D rear view</p>
PR123/DC	■	■	■	■

The following tables show the possible configurations according to the type of network:

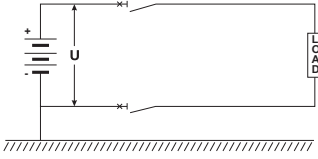
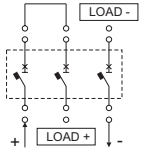
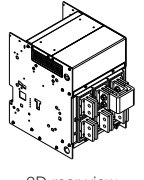
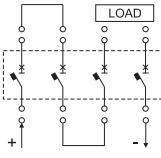
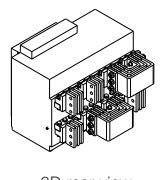
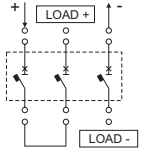
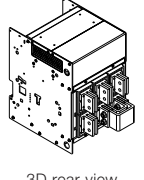
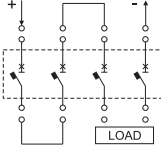
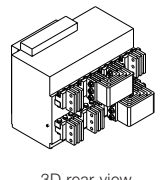
<p>NETWORK WITH EARTHED NEGATIVE POLARITY</p>		
<p>Rated voltage (Ue)</p>	<p>$U_e \leq 500$ ¹⁾</p>	
<p>Poles</p>	<p>3p</p>	<p>4p</p>
<p>Power supply from lower terminals (Lower Supply)</p>	 <p>Front view</p>  <p>3D rear view</p>	 <p>Front view</p>  <p>3D rear view</p>
<p>Power supply from upper terminals (Upper Supply)</p>	 <p>Front view</p>  <p>3D rear view</p>	 <p>Front view</p>  <p>3D rear view</p>
<p>PR122/DC</p>	<p>■</p>	<p>■</p>
<p>PR123/DC</p>	<p>■</p>	<p>■</p>

1) For higher voltages, ask ABB SACE

It is necessary to specify the 1SDA068806R1 extracode for the special dedicated configuration with 4 poles.

Selection of Emax DC

Ordering Rules

Fixed circuit-breaker (F)

ABB SACE delivers the circuit-breaker in the standard configuration supplied from lower terminals.

CODE

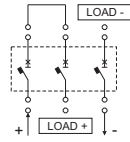

To change the power supply side from lower terminals to the upper ones, it is necessary to specify the 1SDA058251R1 extracode.

CODE + 1SDA058251R1

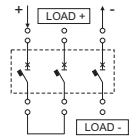

In the case of a network with earthed negative polarity and a four-pole circuit-breaker (4p), it is always necessary to specify the 1SDA068806R1 extracode

Supplied from lower terminals

CODE + 1SDA068806R1

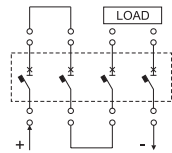

Supplied from upper terminals

CODE + 1SDA058251R1 + 1SDA068806R1

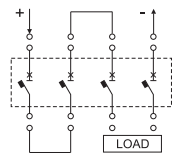

Withdrawable circuit-breaker (W)

MOVING PART

For the moving part in withdrawable circuit-breakers supplied from lower terminals, it is sufficient to indicate the circuit-breaker code only. The voltage sockets are therefore positioned on the lower terminals.

CODE

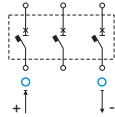

If supplied from the upper terminals, it is necessary to have the voltage sockets onto the upper terminals, specifying the 1SDA058251R1 extracode:

CODE + 1SDA058251R1

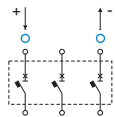

In the case of a network with earthed negative polarity and 4p circuit-breaker, the 1SDA068806R1 extracode must be specified in addition in order to have 3 poles in series on the positive pole.

FIXED PART

The configuration of the fixed part for Emax DC circuit-breakers must be defined starting with the fixed parts for special applications up to 750/1000V DC and adding the "U" connection kit:

Power supply from lower terminals

CODE FOR FIXED PART with vertical terminals + 1SDA065169R1

or

CODE FOR FIXED PART with horizontal terminals + 1SDA067149R1

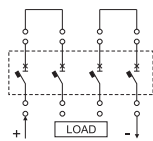

Power supply from upper terminals

CODE FOR FIXED PART with vertical terminals + 1SDA065619R1

or

CODE FOR FIXED PART with horizontal terminals + 1SDA067150R1

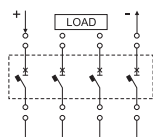

In the case of a network with earthed negative polarity and 4p circuit-breaker, the 1SDA068806R1 extracode must be specified in addition in order to have 3 poles in series on the positive pole.

Ordering codes

Insulated network - Lower power supply

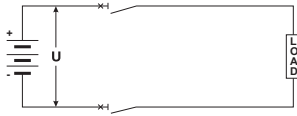

		1SDA0...R1
U _e	U _e < 100V	Vaux is compulsory
	100V ≤ U _e ≤ 250V	Specific extracode for PR120/LV
	250V ≤ U _e ≤ 1000V	PR120/V
		65223



Vertical terminals					1SDA0...R1
Size	Poles	Front view	lu	Performance	Code
E2 Fixed F-VR	3p		800	B	64580
			1000	B	64581
			1250	B	64582
			1600	B	64583
	4p		800	N	64584
			1000	B	64585
			1250	B	64586
			1600	B	64587
			1600	B	64588
			1600	N	64589
E3 Fixed F-VR	3p		800	N	64600
			1000	N	64601
			1250	N	64602
			1600	N	64603
			1600	H	64606
			2000	N	64604
			2000	H	64607
	4p		2500	N	64605
			2500	H	64608
			800	N	64609
			1000	N	64610
			1250	N	64611
			1600	N	64612
			1600	H	64615
E4 Fixed F-VR	3p		2000	N	64613
			2000	H	64616
			2500	N	64614
			2500	H	64617
	4p		1600	S	64636
			1600	S	64641
			2000	S	64642
			2000	S	64643
E6 Fixed F-VR	3p		2500	S	64644
			2500	S	64645
			3200	H	64645
			3200	H	64656
			3200	H	64657
	4p		5000	H	64658
			5000	H	64659
			3200	H	64659
			4000	H	64660
			4000	H	64661

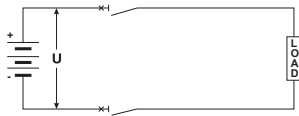

Ue	$U_e < 100V$	Vaux is compulsory	1SDA0...R1
	$100V \leq U_e \leq 250V$	Specific extracode for PR120/LV	65223
	$250V \leq U_e \leq 1000V$	PR120/V	



Vertical terminals

Size	Poles	Front view	Iu	Performance	1SDA0...R1 Code
E2 Fixed F-VR	3p		800	B	64668
			1000	B	64669
			1250	B	64670
			1600	B	64671
	4p		800	N	64672
			1000	B	64673
			1250	B	64674
E3 Fixed F-VR	3p		1250	B	64675
			1600	B	64676
			2000	B	64677
			2500	B	64678
			800	N	64688
			1000	N	64689
			1250	N	64690
	4p		1600	N	64691
			2000	H	64694
			2500	N	64692
			800	N	64695
			1000	N	64693
			1250	H	64696
			1600	N	64697
E4 Fixed F-VR	3p		1000	N	64698
			1250	N	64699
			1600	N	64700
			2000	N	64703
	4p		2000	H	64701
			2500	N	64702
			3200	H	64704
			3200	H	64705
E6 Fixed F-VR	3p		1600	S	64724
			2000	S	64725
			2500	S	64726
	4p		3200	S	64727
			3200	H	64728
			1600	S	64729
			2000	S	64730
			2500	S	64731
			3200	S	64732
3p		3200	H	64733	
		3200	H	64744	
		4000	H	64745	
		5000	H	64746	
		4p		3200	H
4000	H			64748	
5000	H			64749	

Ordering codes

Insulated network - Upper power supply

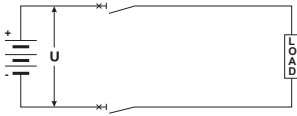

		1SDA0...R1
U _e	U _e < 100V	Vaux is compulsory
	100V ≤ U _e ≤ 250V	Specific extracode for PR120/LV
	250V ≤ U _e ≤ 1000V	PR120/V
		65223



Vertical terminals

Size	Poles	Front view	I _u	Performance	1SDA0...R1 Code	+	1SDA0...R1 Extracode
E2 Fixed F-VR	3p		800	B	64580	+	58251
			1000	B	64581		
			1250	B	64582		
			1600	B	64583		
			1600	N	64584		
	4p		800	B	64585	+	58251
			1000	B	64586		
			1250	B	64587		
			1600	B	64588		
			1600	N	64589		
E3 Fixed F-VR	3p		800	N	64600	+	58251
			1000	N	64601		
			1250	N	64602		
			1600	N	64603		
			1600	H	64606		
	4p		2000	N	64604	+	58251
			2000	H	64607		
			2500	N	64605		
			2500	H	64608		
			800	N	64609		
E4 Fixed F-VR	3p		1000	N	64610	+	58251
			1250	N	64611		
			1600	N	64612		
			2000	H	64615		
			2000	N	64613		
	4p		2500	H	64616	+	58251
			2500	N	64614		
			1600	S	64636		
			2000	S	64637		
			2500	S	64638		
E6 Fixed F-VR	3p		3200	H	64640	+	58251
			4000	H	64656		
			5000	H	64657		
			3200	H	64658		
			3200	H	64659		
	4p		4000	H	64660	+	58251
			4000	H	64661		

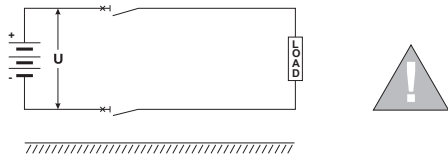

U_e	U _e <100V	Vaux is compulsory	1SDA0...R1
	100V≤U _e ≤250V	Specific extracode for PR120/LV	65223
	250V≤U _e ≤1000V	PR120/V	



Vertical terminals

Size	Poles	Front view	I _u	Performance	Code	+	1SDA0...R1 Extracode
E2 Fixed F-VR	3p		800	B	64668	+	58251
			1000	B	64669		
			1250	B	64670		
			1600	B	64671		
			1600	N	64672		
	4p		800	B	64673	+	58251
			1000	B	64674		
			1250	B	64675		
			1600	B	64676		
			1600	N	64677		
E3 Fixed F-VR	3p		800	N	64688	+	58251
			1000	N	64689		
			1250	N	64690		
			1600	N	64691		
			1600	H	64694		
	4p		2000	N	64692	+	58251
			2500	H	64695		
			2500	N	64693		
			800	N	64697		
			1000	N	64698		
E4 Fixed F-VR	3p		1250	N	64699	+	58251
			1600	N	64700		
			2000	H	64703		
			2000	N	64701		
			2500	H	64704		
	4p		2500	N	64702	+	58251
			1600	S	64724		
			2000	S	64725		
			2500	S	64726		
			3200	S	64727		
E6 Fixed F-VR	3p		3200	H	64728	+	58251
			4000	H	64745		
			5000	H	64746		
			3200	H	64747		
			4000	H	64748		
	4p		4000	H	64749	+	58251

Ordering codes

Insulated network - Lower power supply

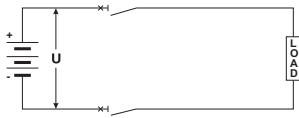

			1SDA0...R1
Ue	Ue < 100V	Vaux is compulsory	
	100V ≤ Ue ≤ 250V	Specific extracode for PR120/LV	65223
	250V ≤ Ue ≤ 1000V	PR120/V	



Vertical terminals				MP		Fixed part		
				1SDA0...R1		1SDA0...R1	+	1SDA0...R1
Size	Poles	Front view	Iu	Performance	Code			Extracode
E2 Withdrawable W-VR	3p		800	B	64590	59895	+	65169
			1000	B	64591			
			1250	B	64592			
	4p		1600	B	64593	59906	+	65169
			800	N	64594			
			1000	B	64595			
E3 Withdrawable W-VR	3p		1250	B	64596	59896	+	65169
			1600	B	64597			
			1000	N	64598			
			1250	N	64599			
			1600	N	64618			
			2000	H	64619			
	4p		1250	N	64620	59907	+	65169
			1600	N	64621			
			2000	H	64622			
			2500	N	64623			
			800	N	64624			
			1000	N	64625			
E4 Withdrawable W-VR	3p		1250	N	64626	59897	+	65169
			1600	H	64627			
			2000	S	64628			
			2500	S	64629			
	4p		1600	N	64630	59137	+	65169
			2000	H	64631			
			2500	S	64632			
			3200	S	64633			
E6 Withdrawable W-VR	3p		1600	S	64634	59140	+	65169
			2000	H	64635			
			2500	H	64636			
	4p		3200	H	64637	59143	+	65169
			4000	H	64638			
			5000	H	64639			

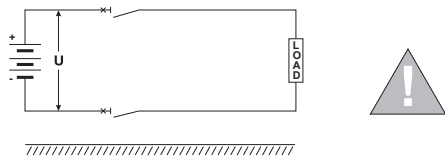

			1SDA0...R1
Ue	$Ue < 100V$	Vaux is compulsory	
	$100V \leq Ue \leq 250V$	Specific extracode for PR120/LV	65223
	$250V \leq Ue \leq 1000V$	PR120/V	



Vertical terminals					MP	Fixed part						
Size	Poles	Front view	Iu	Performance	Code	1SDA0...R1	+	1SDA0...R1				
						Code	+	Extracode				
E2 Withdrawable W-VR	3p		800	B	64678	59895	+	65169				
			1000	B	64679							
			1250	B	64680							
	1600	B	64681									
	800	B	64683									
	1000	B	64684									
E3 Withdrawable W-VR	3p		1250	B	64685	59906	+	65169				
			1600	B	64686							
			2000	N	64687							
	800	N	64706									
	1000	N	64707									
	1250	N	64708									
E4 Withdrawable W-VR	3p		1600	N	64709	59896	+	65169				
			2000	H	64712							
			2500	N	64710							
			800	H	64713							
			1000	N	64711							
			1250	H	64714							
	E5 Withdrawable W-VR	3p		1600	N				64715	59907	+	65169
				2000	N				64716			
				2500	N				64717			
		1600	N	64718								
		2000	H	64721								
		2500	N	64719								
E6 Withdrawable W-VR	3p		2000	H	64722	59137	+	65169				
			2500	N	64720							
			3200	H	64723							
	1600	S	64734									
	2000	S	64735									
	2500	S	64736									
E7 Withdrawable W-VR	3p		3200	S	64737	59897	+	65169				
			4000	H	64738							
			5000	H	64739							
	1600	S	64740									
	2000	S	64741									
	2500	S	64742									
E8 Withdrawable W-VR	3p		3200	H	64743	59140	+	65169				
			4000	H	64751							
			5000	H	64752							
E9 Withdrawable W-VR	4p		3200	H	64753	59143	+	65169				
			4000	H	64754							
			5000	H	64755							

Ordering codes

Insulated network - Upper power supply

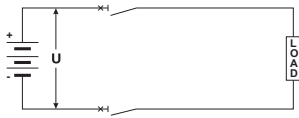

									1SDA0...R1
U _e	U _e < 100V								
	100V ≤ U _e ≤ 250V								65223
	250V ≤ U _e ≤ 1000V								



Vertical terminals				MP				Fixed part		
Size	Poles	Front view	I _u	Performance	Code	+	Extracode	1SDA0...R1	+	1SDA0...R1
								Code		Extracode
E2 Withdrawable W-VR	3p		800	B	64590	+	58251	59895	+	65619
			1000	B	64591	+				
			1250	B	64592	+				
			1600	B	64593	+				
				N	64594	+				
				N	64594	+				
	4p		800	B	64595	+	58251	59906	+	65619
			1000	B	64596	+				
			1250	B	64597	+				
			1600	B	64598	+				
				N	64599	+				
				N	64599	+				
E3 Withdrawable W-VR	3p		800	N	64618	+	58251	59896	+	65619
			1000	N	64619	+				
			1250	N	64620	+				
			1600	N	64621	+				
				H	64624	+				
				N	64622	+				
	4p		2000	H	64625	+	58251	59907	+	65619
			2500	N	64623	+				
				H	64626	+				
			800	N	64627	+				
			1000	N	64628	+				
			1250	N	62629	+				
E4 Withdrawable W-VR	3p		1600	S	64646	+	58251	59897	+	65619
			2000	S	64647	+				
			2500	S	64648	+				
			3200	S	64649	+				
				H	64650	+				
				H	64650	+				
4p		1600	S	64651	+	58251	59137	+	65619	
		2000	S	64652	+					
		2500	S	64653	+					
		3200	S	64654	+					
			H	64655	+					
			H	64655	+					
E6 Withdrawable W-VR	3p		3200	H	64662	+	58251	59140	+	65619
			4000	H	64663	+				
			5000	H	64664	+				
	4p		3200	H	64665	+	58251	59143	+	65619
			4000	H	64666	+				
			5000	H	64667	+				

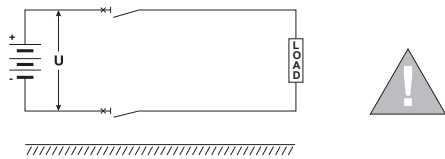

			1SDA0...R1
Ue	$Ue < 100V$	Vaux is compulsory	
	$100V \leq Ue \leq 250V$	Specific extracode for PR120/LV	65223
	$250V \leq Ue \leq 1000V$	PR120/V	



Vertical terminals				MP			Fixed part			
Size	Poles	Front view	Iu	Performance	Code	+	Extracode	Code	+	Extracode
E2 Withdrawable W-VR	3p		800	B	64678	+	58251	59895	+	65619
			1000	B	64679	+				
			1250	B	64680	+				
	4p		1600	B	64681	+				
			800	B	64683	+				
			1000	B	64684	+				
E3 Withdrawable W-VR	3p		1250	B	64685	+				
			1600	B	64686	+				
			800	N	64682	+				
			1000	N	64683	+				
			1250	N	64687	+				
			1600	N	64688	+				
	4p		800	N	64706	+				
			1000	N	64707	+				
			1250	N	64708	+				
			1600	N	64709	+				
			2000	H	64712	+				
			2500	N	64711	+				
E4 Withdrawable W-VR	3p		800	H	64713	+				
			1000	N	64714	+				
			1250	N	64715	+				
			1600	N	64716	+				
			2000	N	64717	+				
	4p		1250	N	64718	+				
			1600	N	64718	+				
			2000	H	64721	+				
			2500	N	64719	+				
			2000	H	64722	+				
E6 Withdrawable W-VR	3p		2500	N	64720	+				
			3200	H	64723	+				
			1600	S	64734	+				
			2000	S	64735	+				
	4p		2500	S	64736	+				
			3200	S	64737	+				
			1600	S	64739	+				
			2000	S	64740	+				
3p		2500	S	64741	+					
		3200	S	64742	+					
		3200	H	64743	+					
		4000	H	64751	+					
		5000	H	64752	+					
4p		3200	H	64753	+					
		4000	H	64754	+					
		5000	H	64755	+					

Ordering codes

Insulated network - Lower power supply

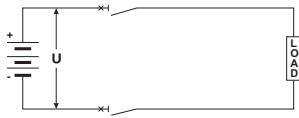

			1SDA0...R1
Ue	$Ue < 100V$	Vaux is compulsory	
	$100V \leq Ue \leq 250V$	Specific extracode for PR120/LV	65223
	$250V \leq Ue \leq 1000V$	PR120/V	



Horizontal terminals					MP	Fixed part							
Size	Poles	Front view	Iu	Performance	Code	1SDA0...R1	+	1SDA0...R1					
					Code			Extracode					
E2 Withdrawable W-HR	3p		800	B	64590	59891	+	67149					
			1000	B	64591								
			1250	B	64592								
	4p	1600	B	64593									
		800	B	64594									
		1000	B	64595									
E3 Withdrawable W-HR	3p		1250	B	64596	59903	+	67149					
			1600	B	64597								
			800	B	64598								
			1000	B	64599								
			1250	N	64599								
			1600	N	64599								
	4p	800	N	64618	59892				+	67149			
		1000	N	64619									
		1250	N	64620									
		1600	N	64621									
		2000	H	64624									
		2500	N	64622									
E4 Withdrawable W-HR	3p		2000	H		64625	59904	+			67149		
			2500	N		64623							
			800	H		64626							
			1000	N		64627							
			1250	N		64628							
			1600	N		62629							
	4p	1600	N	64630	59893	+			67149				
		2000	H	64633									
		2000	N	64631									
		2500	H	64634									
		2500	N	64632									
		2500	H	64635									
E5 Withdrawable W-HR	3p		1600	S			64646	59136		+	67149		
			2000	S			64647						
			2500	S			64648						
	4p	3200	S	64649			59139					+	67149
		1600	H	64650									
		2000	S	64651									
3p	2500	S	64652	59136	+	67149							
	3200	S	64653										
	3200	H	64654										
E6 Withdrawable W-HR	3p		3200				H	64655	59142	+	67149		
			4000				H	64662					
			5000				H	64664					
	4p	3200	H	64665	59139	+	67149						
		4000	H	64663									
		5000	H	64666									
4p	4000	H	64666	59142				+	67149				
	5000	H	64667										
	5000	H	64667										

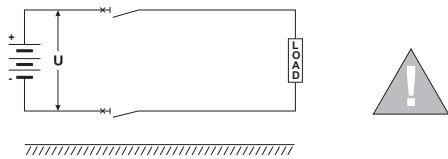

			1SDA0...R1
Ue	$Ue < 100V$	Vaux is compulsory	
	$100V \leq Ue \leq 250V$	Specific extracode for PR120/LV	65223
	$250V \leq Ue \leq 1000V$	PR120/V	



Horizontal terminals					MP	Fixed part					
Size	Poles	Front view	Iu	Performance	Code	1SDA0...R1	+	1SDA0...R1			
						Code	+	Extracode			
E2 Withdrawable W-HR	3p		800	B	64678	59891	+	67149			
			1000	B	64679						
			1250	B	64680						
	1600	B	64681								
	1600	N	64682								
	1600	N	64683								
4p		800	B	64683	59903	+	67149				
		1000	B	64684							
		1250	B	64685							
		1600	B	64686							
		1600	N	64687							
		1600	N	64688							
E3 Withdrawable W-HR	3p		800	N	64706	59892	+	67149			
			1000	N	64707						
			1250	N	64708						
			1600	N	64709						
			2000	H	64712						
			2000	N	64710						
	2500	N	64711								
	4p		800	N	64715				59904	+	67149
			1000	N	64716						
			1250	N	64717						
			1600	N	64718						
			2000	H	64721						
2000			N	64719							
E4 Withdrawable W-HR	3p		1600	S	64734	59893	+	67149			
			2000	S	64735						
			2500	S	64736						
	3200	S	64737								
	3200	H	64738								
	3200	H	64739								
4p		1600	S	64739	59136	+	67149				
		2000	S	64740							
		2500	S	64741							
3200	S	64742									
3200	H	64743									
3200	H	64744									
E6 Withdrawable W-HR	3p		3200	H	64750	59139	+	67149			
			4000	H	64751						
	5000	H	64752								
	4p		3200	H	64753				59142	+	67149
			4000	H	64754						
5000	H	64755									

Ordering codes

Insulated network - Upper power supply

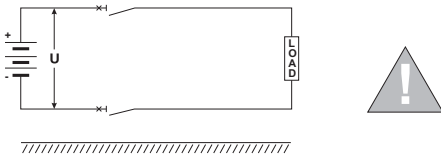

			1SDA0...R1
U _e	U _e < 100V	Vaux is compulsory	
	100V ≤ U _e ≤ 250V	Specific extracode for PR120/LV	65223
	250V ≤ U _e ≤ 1000V	PR120/V	



Horizontal terminals				MP				Fixed part		
Size	Poles	Front view	I _u	Performance	1SDA0...R1 Code	+	1SDA0...R1 Extracode	1SDA0...R1 Code	+	1SDA0...R1 Extracode
E2 Withdrawable W-HR	3p		800	B	64590	+	58251	59891	+	67150
			1000	B	64591	+				
			1250	B	64592	+				
	4p	1600	B	64593	+					
		800	N	64594	+					
		1000	B	64595	+					
E3 Withdrawable W-HR	3p		1000	B	64596	+	58251	59903	+	67150
			1250	B	64597	+				
			1600	B	64598	+				
			1600	N	64599	+				
			800	N	64618	+				
			1000	N	64619	+				
	4p	1250	N	64620	+					
		1600	N	64621	+					
		2000	H	64622	+					
		2500	N	64623	+					
		800	H	64624	+					
		1000	N	64625	+					
E4 Withdrawable W-HR	3p		1250	N	64626	+	58251	59892	+	67150
			1600	N	64627	+				
			2000	N	64628	+				
			2500	N	64629	+				
			800	N	64630	+				
			1000	N	64631	+				
	4p	1250	N	64632	+					
		1600	H	64633	+					
		2000	N	64634	+					
		2500	H	64635	+					
		1600	S	64646	+					
		2000	S	64647	+					
E5 Withdrawable W-HR	3p		2500	S	64648	+	58251	59893	+	67150
			3200	S	64649	+				
			1600	H	64650	+				
	4p	1600	S	64651	+					
		2000	S	64652	+					
		2500	S	64653	+					
E6 Withdrawable W-HR	3p		3200	S	64654	+	58251	59136	+	67150
			4000	H	64655	+				
			5000	H	64662	+				
	4p	3200	H	64663	+					
		4000	H	64664	+					
		5000	H	64665	+					
4p	3200	H	64666	+						
	4000	H	64667	+						
	5000	H	64668	+						

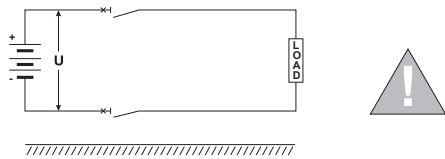

			1SDA0...R1
Ue	Ue < 100V	Vaux is compulsory	
	100V ≤ Ue ≤ 250V	Specific extracode for PR120/LV	65223
	250V ≤ Ue ≤ 1000V	PR120/V	



Horizontal terminals				MP			Fixed part			
Size	Poles	Front view	Iu	Performance	1SDA0...R1 Code	+ Extracode	1SDA0...R1 Code	+ Extracode		
E2 Withdrawable W-HR	3p		800	B	64678	+	58251	59891	+	67150
			1000	B	64679	+				
			1250	B	64680	+				
	4p	1600	B	64681	+					
		800	B	64683	+					
		1000	B	64684	+					
E3 Withdrawable W-HR	3p		1250	B	64685	+				
			1600	B	64686	+				
			800	N	64687	+				
			1000	N	64706	+				
			1250	N	64707	+				
			1600	N	64708	+				
	4p	2000	N	64709	+					
		800	H	64712	+					
		1000	N	64710	+					
		1250	H	64713	+					
		1600	N	64711	+					
		2000	H	64714	+					
E4 Withdrawable W-HR	3p		2500	N	64715	+				
			800	N	64716	+				
			1000	N	64717	+				
			1250	N	64718	+				
	4p	1600	N	64718	+					
		2000	H	64721	+					
		2500	N	64719	+					
		800	H	64722	+					
		1000	N	64720	+					
		1250	H	64723	+					
E6 Withdrawable W-HR	3p		1600	S	64734	+				
			2000	S	64735	+				
			2500	S	64736	+				
			3200	S	64737	+				
	4p	3200	H	64738	+					
		1600	S	64739	+					
		2000	S	64740	+					
		2500	S	64741	+					
E6 Withdrawable W-HR	3p		3200	S	64742	+				
			3200	H	64743	+				
	4p		3200	H	64750	+				
			4000	H	64751	+				
			5000	H	64752	+				
4p		3200	H	64753	+					
		4000	H	64754	+					
5000	H	64755	+							

Ordering codes

Network mid-point earthed - Lower power supply

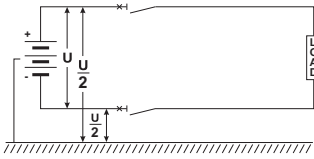

			1SDA0...R1
U_e	U _e < 100V	Vaux is compulsory	
	100V ≤ U _e ≤ 250V	Specific extracode for PR120/LV	65223
	250V ≤ U _e ≤ 1000V	PR120/V	



Vertical terminals				1SDA0...R1	
Size	Poles	Front view	I _u	Performance	Code
E2 Fixed F-VR	3p		800	B	64668
			1000	B	64669
			1250	B	64670
			1600	B	64671
			1600	N	64672
	4p		800	B	64673
			1000	B	64674
			1250	B	64675
			1600	B	64676
			1600	N	64677
E3 Fixed F-VR	3p		800	N	64688
			1000	N	64689
			1250	N	64690
			1600	N	64691
			1600	H	64694
	4p		2000	N	64692
			2500	H	64695
			2500	N	64693
			2500	H	64696
			2500	N	64697
E4 Fixed F-VR	3p		1000	N	64698
			1250	N	64699
			1600	N	64700
			1600	H	64703
			2000	N	64701
	4p		2000	H	64704
			2500	N	64702
			2500	H	64705
			1600	S	64724
			2000	S	64725
E6 Fixed F-VR	3p		2500	S	64726
			3200	S	64727
			3200	H	64728
			1600	S	64729
			2000	S	64730
	4p		2500	S	64731
			3200	S	64732
			3200	H	64733
			3200	H	64744
			4000	H	64745
4p		5000	H	64746	
		3200	H	64747	
		4000	H	64748	
			5000	H	64749

Ordering codes

Network mid-point earthed - Upper power supply

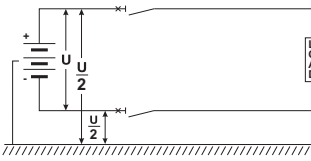

U _e	U _e < 100V	Vaux is compulsory	1SDA0...R1
	100V ≤ U _e ≤ 250V	Specific extracode for PR120/LV	65223
	250V ≤ U _e ≤ 1000V	PR120/V	



Vertical terminals				1SDA0...R1	1SDA0...R1	
Size	Poles	Front view	I _u	Performance	Code + Extracode	
E2 Fixed F-VR	3p		800	B	64668 +	58251
			1000	B	64669 +	
			1250	B	64670 +	
			1600	B	64671 +	
				N	64672 +	
				N	64673 +	
	4p		800	B	64673 +	58251
			1000	B	64674 +	
			1250	B	64675 +	
			1600	B	64676 +	
				N	64677 +	
				N	64678 +	
E3 Fixed F-VR	3p		800	N	64688 +	58251
			1000	N	64689 +	
			1250	N	64690 +	
			1600	N	64691 +	
				H	64694 +	
			2000	N	64692 +	
				H	64695 +	
			2500	N	64693 +	
				H	64696 +	
	4p		800	N	64697 +	58251
			1000	N	64698 +	
			1250	N	64699 +	
			1600	N	64700 +	
				H	64703 +	
			2000	N	64701 +	
				H	64704 +	
			2500	N	64702 +	
				H	64705 +	
E4 Fixed F-VR	3p		1600	S	64724 +	58251
			2000	S	64725 +	
			2500	S	64726 +	
			3200	S	64727 +	
				H	64728 +	
				H	64729 +	
	4p		1600	S	64729 +	58251
			2000	S	64730 +	
			2500	S	64731 +	
			3200	S	64732 +	
				H	64733 +	
				H	64734 +	
E6 Fixed F-VR	3p		3200	H	64744 +	58251
			4000	H	64745 +	
			5000	H	64746 +	
	4p		3200	H	64747 +	58251
			4000	H	64748 +	
			5000	H	64749 +	

Ordering codes

Network mid-point earthed - Lower power supply

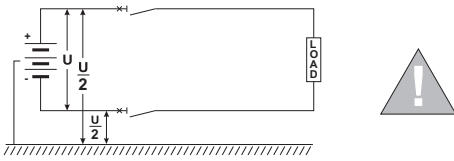

		1SDA0...R1
U _e	U _e < 100V	V _{aux} is compulsory
	100V ≤ U _e ≤ 250V	Specific extracode for PR120/LV
	250V ≤ U _e ≤ 1000V	PR120/V
		65223



Vertical terminals			MP		Fixed part						
					1SDA0...R1	1SDA0...R1	1SDA0...R1				
Size	Poles	Front view	I _u	Performance	Code	Code	+	Extracode			
E2 Withdrawable W-VR	3p		800	B	64678	59895	+	65169			
			1000	B	64679						
			1250	B	64680						
	4p		1600	B	64681	59906	+	65169			
			800	N	64682						
			800	B	64683						
1000			B	64684							
1250			B	64685							
1600			B	64686							
E3 Withdrawable W-VR	3p		1600	N	64687	59896	+	65169			
			800	N	64706						
			1000	N	64707						
			1250	N	64708						
			1600	N	64709						
			2000	H	64712						
	4p		2000	N	64710	59907	+	65169			
			2500	H	64713						
			800	N	64711						
			1000	H	64714						
			1250	N	64715						
			1600	N	64716						
E4 Withdrawable W-VR	3p		1600	N	64717	59897	+	65169			
			2000	S	64718						
			2500	S	64719						
	4p		3200	S	64720				59137	+	65169
			1600	H	64721						
			2000	S	64722						
E6 Withdrawable W-VR	3p		2500	H	64723	59140	+	65169			
			3200	H	64724						
			4000	H	64725						
	4p		3200	H	64726				59143	+	65169
			4000	H	64727						
			5000	H	64728						

Ordering codes

Network mid-point earthed - Upper power supply

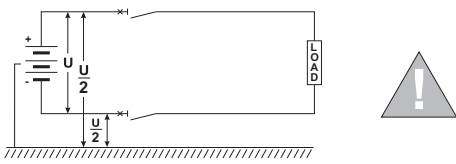

			1SDA0...R1
Ue	Ue < 100V	Vaux is compulsory	
	100V ≤ Ue ≤ 250V	Specific extracode for PR120/LV	65223
	250V ≤ Ue ≤ 1000V	PR120/V	



Vertical terminals			MP				Fixed part							
Size	Poles	Front view	Iu	Performance	1SDA0...R1 Code	+ Extracode	1SDA0...R1 Code	+ Extracode						
E2 Withdrawable W-VR	3p		800	B	64678	+	58251	59895	+	65619				
			1000	B	64679	+								
			1250	B	64680	+								
	4p	1600	B	64681	+									
		800	B	64683	+									
		1000	B	64684	+									
E3 Withdrawable W-VR	3p		1250	B	64685	+	58251	59906	+	65619				
			1600	B	64686	+								
			800	N	64682	+								
			1000	N	64683	+								
			1250	N	64687	+								
			1600	N	64688	+								
	4p	800	N	64706	+									
		1000	N	64707	+									
		1250	N	64708	+									
		1600	N	64709	+									
		2000	N	64710	+									
		2500	N	64711	+									
E4 Withdrawable W-VR	3p		800	H	64712	+	58251	59896	+	65619				
			1000	H	64713	+								
			1250	H	64714	+								
			1600	H	64715	+								
			2000	H	64716	+								
			2500	H	64717	+								
	4p	800	N	64718	+									
		1000	N	64719	+									
		1250	N	64720	+									
		1600	N	64721	+									
		2000	N	64722	+									
		2500	N	64723	+									
E6 Withdrawable W-VR	3p		1600	S	64734	+	58251	59897	+	65619				
			2000	S	64735	+								
			2500	S	64736	+								
	4p	3200	S	64737	+									
		1600	H	64738	+									
		2000	H	64739	+									
E4 Withdrawable W-VR	3p		2500	S	64740	+	58251	59137	+	65619				
			3200	S	64741	+								
			4000	S	64742	+								
	4p	3200	H	64743	+									
		3200	H	64750	+									
		4000	H	64751	+									
E6 Withdrawable W-VR	3p		5000	H	64752	+	58251	59140	+	65619				
			3200	H	64753	+								
			4000	H	64754	+								
E6 Withdrawable W-VR	4p		5000	H	64755	+					58251	59143	+	65619
			3200	H	64756	+								
			4000	H	64757	+								

Ordering codes

Network mid-point earthed - Lower power supply

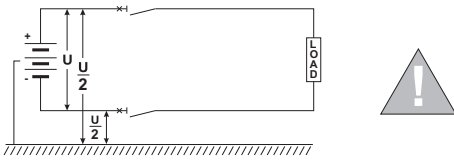

		1SDA0...R1
U _e	U _e < 100V	Vaux is compulsory
	100V ≤ U _e ≤ 250V	Specific extracode for PR120/LV
	250V ≤ U _e ≤ 1000V	PR120/V
		65223



Vertical terminals			MP		Fixed part			
					1SDA0...R1	1SDA0...R1	1SDA0...R1	
Size	Poles	Front view	I _u	Performance	Code	Code	+	Extracode
E2 Withdrawable W-HR	3p		800	B	64678	59891	+	67149
			1000	B	64679			
			1250	B	64680			
	4p		1600	B	64681	59903	+	67149
			800	B	64683			
			1000	B	64684			
E3 Withdrawable W-HR	3p		1250	B	64685	59892	+	67149
			1600	B	64686			
			1600	N	64682			
			2000	N	64687			
			2500	N	64706			
			2500	N	64707			
	4p		1250	N	64708	59904	+	67149
			1600	N	64709			
			1600	H	64712			
			2000	N	64710			
			2000	H	64713			
			2500	N	64711			
E4 Withdrawable W-HR	3p		800	H	64714	59893	+	67149
			1000	N	64715			
			1250	N	64716			
	4p		1250	N	64717	59136	+	67149
			1600	N	64718			
			2000	N	64719			
E6 Withdrawable W-HR	3p		2500	H	64721	59139	+	67149
			2000	H	64722			
			2500	N	64720			
	4p		3200	H	64723	59142	+	67149
			3200	S	64734			
			3200	S	64735			
E6 Withdrawable W-HR	3p		3200	S	64736	59139	+	67149
			4000	S	64737			
			5000	S	64738			
	4p		3200	H	64739	59142	+	67149
			4000	S	64740			
			5000	S	64741			
4p		3200	H	64742	59142	+	67149	
		4000	H	64743				
		5000	H	64743				

Ordering codes

Network mid-point earthed - Upper power supply

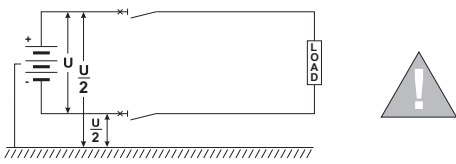

			1SDA0...R1
Ue	Ue < 100V	Vaux is compulsory	
	100V ≤ Ue ≤ 250V	Specific extracode for PR120/LV	65223
	250V ≤ Ue ≤ 1000V	PR120/V	



Vertical terminals			MP				Fixed part			
Size	Poles	Front view	Iu	Performance	1SDA0...R1 Code	+	1SDA0...R1 Extracode	1SDA0...R1 Code	+	1SDA0...R1 Extracode
E2 Withdrawable W-HR	3p		800	B	64678	+	58251	59891	+	67150
			1000	B	64679	+				
			1250	B	64680	+				
	4p	3p		1600	B	64681		+		
					N	64682		+		
				800	B	64683		+		
4p		4p		1000	B	64684	+			
				1250	B	64685	+			
				1600	B	64686	+			
	E3 Withdrawable W-HR	3p			N	64687	+			
				800	N	64706	+			
				1000	N	64707	+			
1250				N	64708	+				
1600				N	64709	+				
2000				N	64710	+				
4p		4p		2500	N	64711	+			
					H	64712	+			
				800	N	64713	+			
				1000	N	64714	+			
				1250	N	64715	+			
				1600	N	64716	+			
E4 Withdrawable W-HR	3p		2000	N	64717	+				
				H	64718	+				
			1600	N	64719	+				
			2000	N	64720	+				
			2500	N	64721	+				
				H	64722	+				
	4p	4p		2500	N	64723	+			
				1600	S	64734	+			
				2000	S	64735	+			
				2500	S	64736	+			
				3200	S	64737	+			
					H	64738	+			
E6 Withdrawable W-HR	3p		1600	S	64739	+				
			2000	S	64740	+				
			2500	S	64741	+				
	4p	4p		3200	S	64742	+			
					H	64743	+			
				3200	H	64744	+			
E6 Withdrawable W-HR	3p		3200	H	64745	+				
			4000	H	64751	+				
	4p	4p		5000	H	64752	+			
				3200	H	64753	+			
				4000	H	64754	+			
	H	64755	+							

Ordering codes

Network with earthed negative polarity - Lower power supply

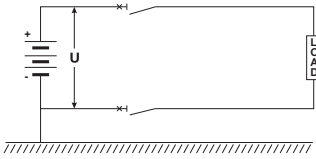

					1SDA0...R1
U _e	U _e < 100V	Vaux is compulsory			
	100V ≤ U _e ≤ 250V	Specific extracode for PR120/LV			65223
	250V ≤ U _e ≤ 500V*	PR120/V			

* For higher voltages, contact ABB



Vertical terminals					1SDA0...R1	1SDA0...R1		
Size	Poles	Front view	I _u	Performance	Code	+ Extracode		
E2 Fixed F-VR	3p		800	B	64580	+	-	
			1000	B	64581	+		
			1250	B	64582	+		
			1600	B	64583	+		
				N	64584	+		
				N	64585	+		
	4p		800	B	64585	+		68806
			1000	B	64586	+		
			1250	B	64587	+		
			1600	B	64588	+		
				N	64589	+		
				N	64589	+		
E3 Fixed F-VR	3p		800	N	64600	+	-	
			1000	N	64601	+		
			1250	N	64602	+		
			1600	N	64603	+		
			2000	H	64606	+		
				N	64604	+		
				H	64607	+		
				N	64605	+		
				H	64608	+		
	4p		800	N	64609	+	68806	
			1000	N	64610	+		
			1250	N	64611	+		
			1600	N	64612	+		
			2000	H	64615	+		
				N	64613	+		
				H	64616	+		
				N	64614	+		
				H	64617	+		
E4 Fixed F-VR	3p		1600	S	64636	+	-	
			2000	S	64637	+		
			2500	S	64638	+		
			3200	S	64639	+		
				H	64640	+		
				H	64640	+		
	4p		1600	S	64641	+	68806	
			2000	S	64642	+		
			2500	S	64643	+		
			3200	S	64644	+		
				H	64645	+		
				H	64645	+		
E6 Fixed F-VR	3p		3200	H	64656	+	-	
			4000	H	64657	+		
			5000	H	64658	+		
				H	64658	+		
				H	64659	+		
				H	64659	+		
	4p		3200	H	64659	+	68806	
			4000	H	64660	+		
			5000	H	64661	+		

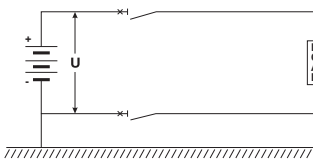

							1SDA0...R1
Ue	Ue < 100V	Vaux is compulsory					
	100V ≤ Ue ≤ 250V	Specific extracode for PR120/LV					65223
	250V ≤ Ue ≤ 500V*	PR120/V					

* For higher voltages, contact ABB



Vertical terminals					1SDA0...R1		1SDA0...R1	
Size	Poles	Front view	Iu	Performance	Code	+	Extracode	
E2 Fixed F-VR	3p		800	B	64668	+	-	
			1000	B	64669	+		
			1250	B	64670	+		
			1600	B	64671	+		
				N	64672	+		
				N	64673	+		
	4p		800	B	64673	+		68806
			1000	B	64674	+		
			1250	B	64675	+		
			1600	B	64676	+		
				N	64677	+		
				N	64678	+		
E3 Fixed F-VR	3p		800	N	64688	+	-	
			1000	N	64689	+		
			1250	N	64690	+		
			1600	N	64691	+		
			2000	H	64694	+		
				N	64692	+		
				H	64695	+		
				N	64693	+		
				H	64696	+		
	4p		800	N	64697	+		68806
			1000	N	64698	+		
			1250	N	64699	+		
			1600	N	64700	+		
			2000	H	64703	+		
				N	64701	+		
				H	64704	+		
				N	64702	+		
				H	64705	+		
E4 Fixed F-VR	3p		1600	S	64724	+	-	
			2000	S	64725	+		
			2500	S	64726	+		
			3200	S	64727	+		
				H	64728	+		
				H	64729	+		
	4p		1600	S	64729	+		68806
			2000	S	64730	+		
			2500	S	64731	+		
			3200	S	64732	+		
				H	64733	+		
				H	64734	+		
E6 Fixed F-VR	3p		3200	H	64744	+	-	
			4000	H	64745	+		
			5000	H	64746	+		
	4p		3200	H	64747	+		68806
			4000	H	64748	+		
			5000	H	64749	+		

Ordering codes

Network with earthed negative polarity - Upper power supply

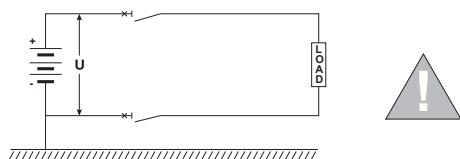

		1SDA0...R1
Ue	Ue < 100V	Vaux is compulsory
	100V ≤ Ue ≤ 250V	Specific extracode for PR120/LV
	250V ≤ Ue ≤ 500V*	PR120/V

* For higher voltages, contact ABB



Vertical terminals

Size	Poles	Front view	Iu	Performance	1SDA0...R1	+	1SDA0...R1	+	1SDA0...R1	
					Code		Extracode		Extracode	
E2 Fixed F-VR	3p		800	B	64580	+	58251	+	-	
			1000	B	64581	+		+		
			1250	B	64582	+		+		
			1600	B	64583	+		+		
	4p		800	B	64585	+	58251	+	68806	
			1000	B	64586	+		+		
			1250	B	64587	+		+		
			1600	B	64588	+		+		
	E3 Fixed F-VR	3p		800	N	64600	+	58251	+	-
				1000	N	64601	+		+	
				1250	N	64602	+		+	
				1600	N	64603	+		+	
2000				N	64604	+	+			
2500				N	64605	+	+			
4p			800	N	64609	+	58251	+	68806	
			1000	N	64610	+		+		
			1250	N	64611	+		+		
			1600	N	64612	+		+		
			2000	H	64615	+		+		
			2500	H	64617	+		+		
E4 Fixed F-VR	3p		1600	S	64636	+	58251	+	-	
			2000	S	64637	+		+		
			2500	S	64638	+		+		
			3200	S	64639	+		+		
	4p		1600	S	64641	+	58251	+	68806	
			2000	S	64642	+		+		
			2500	S	64643	+		+		
			3200	S	64644	+		+		
	3p		3200	H	64645	+	58251	+	-	
			4000	H	64656	+		+		
			5000	H	64658	+		+		
			3200	H	64659	+		+		
4p		4000	H	64660	+	58251	+	68806		
		5000	H	64661	+		+			

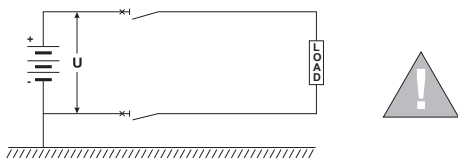

Ue	Ue < 100V	Vaux is compulsory	1SDA0...R1
	100V ≤ Ue ≤ 250V	Specific extracode for PR120/LV	65223
	250V ≤ Ue ≤ 500V*	PR120/V	

* For higher voltages, contact ABB



Vertical terminals

Size	Poles	Front view	Iu	Performance	Code	+	1SDA0...R1 Extracode	+	1SDA0...R1 Extracode	
E2 Fixed F-VR	3p		800	B	64668	+	58251	+	-	
			1000	B	64669	+		+		
			1250	B	64670	+		+		
			1600	B	64671	+		+		
	4p		800	B	64673	+	58251	+	68806	
			1000	B	64674	+		+		
			1250	B	64675	+		+		
			1600	B	64676	+		+		
	E3 Fixed F-VR	3p		800	N	64688	+	58251	+	-
				1000	N	64689	+		+	
				1250	N	64690	+		+	
				1600	N	64691	+		+	
2000				H	64694	+	+			
2500				N	64692	+	+			
4p			800	N	64697	+	58251	+	68806	
			1000	N	64698	+		+		
			1250	N	64699	+		+		
			1600	N	64700	+		+		
			2000	H	64703	+		+		
			2500	N	64701	+		+		
E4 Fixed F-VR	3p		1600	S	64724	+	58251	+	-	
			2000	S	64725	+		+		
			2500	S	64726	+		+		
			3200	S	64727	+		+		
	4p		1600	H	64728	+	58251	+	68806	
			2000	S	64729	+		+		
			2500	S	64730	+		+		
			3200	S	64731	+		+		
	3p		3200	H	64732	+	58251	+	-	
			4000	H	64733	+		+		
			5000	H	64734	+		+		
			3200	H	64744	+		+		
4p		3200	H	64745	+	58251	+	68806		
		4000	H	64746	+		+			
		5000	H	64747	+		+			
		3200	H	64748	+		+			
E6 Fixed F-VR	4p		4000	H	64749	+	58251	+	68806	
			5000	H	64748	+		+		
			5000	H	64749	+		+		
			5000	H	64749	+		+		

Ordering codes

Network with earthed negative polarity - Lower power supply

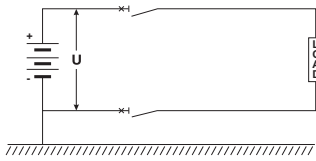

		1SDA0...R1
U _e	U _e < 100V	Vaux is compulsory
	100V ≤ U _e ≤ 250V	Specific extracode for PR120/LV
	250V ≤ U _e ≤ 500V*	PR120/V

* For higher voltages, contact ABB



Vertical terminals			MP				Fixed part					
			1SDA0...R1		1SDA0...R1		1SDA0...R1		1SDA0...R1			
Size	Poles	Front view	I _u	Performance	Code	+	Extracode	Code	+	Extracode	+	Extracode
E2 Withdrawable W-VR	3p		800	B	64590	+	-	59895	+	65169	+	-
			1000	B	64591	+						
			1250	B	64592	+						
	4p		1600	B	64593	+						
			800	N	64594	+						
			1000	B	64595	+						
E3 Withdrawable W-VR	3p		1000	B	64596	+	68806	59906	+	65169	+	68806
			1250	B	64597	+						
			1600	B	64598	+						
	4p		1600	N	64599	+						
			800	N	64618	+						
			1000	N	64619	+						
E4 Withdrawable W-VR	3p		1250	N	64620	+	-	59896	+	65169	+	-
			1600	N	64621	+						
			2000	H	64622	+						
	4p		2500	N	64623	+						
			800	N	64624	+						
			1000	H	64625	+						
E5 Withdrawable W-VR	3p		1250	N	64626	+	68806	59907	+	65169	+	68806
			1600	N	64627	+						
			2000	N	64628	+						
	4p		1250	N	62629	+						
			1600	N	64630	+						
			2000	H	64631	+						
E6 Withdrawable W-VR	3p		2000	H	64632	+	-	59140	+	65169	+	-
			2500	H	64633	+						
			3200	H	64634	+						
	4p		2500	N	64635	+						
			1600	S	64646	+						
			2000	S	64647	+						
E7 Withdrawable W-VR	3p		2500	S	64648	+	68806	59137	+	65169	+	68806
			3200	S	64649	+						
			1600	H	64650	+						
	4p		2000	S	64651	+						
			2500	S	64652	+						
			3200	S	64653	+						
E8 Withdrawable W-VR	3p		3200	H	64654	+	-	59143	+	65169	+	68806
			4000	H	64655	+						
			5000	H	64662	+						
	4p		3200	H	64663	+						
			4000	H	64664	+						
			5000	H	64665	+						
E9 Withdrawable W-VR	4p		4000	H	64666	+	68806	59143	+	65169	+	68806
			4000	H	64667	+						
			5000	H	64667	+						

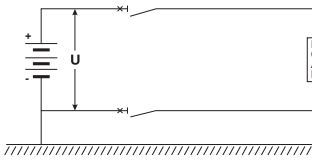

Ue	Ue < 100V	Vaux is compulsory
	100V ≤ Ue ≤ 250V	Specific extracode for PR120/LV
	250V ≤ Ue ≤ 500V*	PR120/V

* For higher voltages, contact ABB

1SDA0...R1

65223



PR123/DC

Vertical terminals				MP			Fixed part						
Size	Poles	Front view	Iu	Performance	1SDA0...R1 Code	+	1SDA0...R1 Extracode	1SDA0...R1 Code	+	1SDA0...R1 Extracode	+	1SDA0...R1 Extracode	
E2 Withdrawable W-VR	3p		800	B	64678	+	-	59895	+	65169	+	-	
			1000	B	64679	+							
			1250	B	64680	+							
			1600	B	64681	+							
	4p		800	B	64683	+		68806	59906	+	65169	+	68806
			1000	B	64684	+							
			1250	B	64685	+							
			1600	B	64686	+							
E3 Withdrawable W-VR	3p		800	N	64706	+	-	59896	+	65169	+	-	
			1000	N	64707	+							
			1250	N	64708	+							
			1600	N	64709	+							
			2000	H	64712	+							
			2500	N	64711	+							
	4p		800	N	64715	+		68806	59907	+	65169	+	68806
			1000	N	64716	+							
			1250	N	64717	+							
			1600	N	64718	+							
			2000	H	64721	+							
			2500	N	64719	+							
E4 Withdrawable W-VR	3p		1600	S	64734	+	-	59897	+	65169	+	-	
			2000	S	64735	+							
			2500	S	64736	+							
			3200	S	64737	+							
	4p		1600	H	64738	+		68806	59137	+	65169	+	68806
			2000	S	64739	+							
			2500	S	64740	+							
			3200	S	64741	+							
E6 Withdrawable W-VR	3p		3200	H	64742	+	-	59140	+	65169	+	-	
			4000	H	64751	+							
			5000	H	64752	+							
	4p		3200	H	64743	+		68806	59143	+	65169	+	68806
			4000	H	64754	+							
			5000	H	64755	+							

Ordering codes

Network with earthed negative polarity - Upper power supply

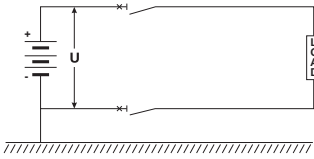

		1SDA0...R1
U_e	U _e < 100V	Vaux is compulsory
	100V ≤ U _e ≤ 250V	Specific extracode for PR120/LV
	250V ≤ U _e ≤ 500V*	PR120/V
* For higher voltages, contact ABB		65223



Vertical terminals				MP			Fixed part							
				1SDA0...R1	1SDA0...R1	1SDA0...R1	1SDA0...R1	1SDA0...R1	1SDA0...R1					
Size	Poles	Front view	I _u	Performance	Code	+ Extracode	+ Extracode	Code	+ Extracode	+ Extracode				
E2 Withdrawable W-VR	3p		800	B	64590	+								
			1000	B	64591	+								
			1250	B	64592	+	58251	+	-	59895	+	65619	+	-
			1600	B	64593	+								
	4p		800	B	64595	+								
			1000	B	64596	+								
			1250	B	64597	+	58251	+	68806	59906	+	65619	+	68806
			1600	B	64598	+								
E3 Withdrawable W-VR	3p		800	N	64618	+								
			1000	N	64619	+								
			1250	N	64620	+								
			1600	N	64621	+								
			2000	H	64624	+	58251	+	-	59896	+	65619	+	-
	4p		2500	N	64622	+								
			800	H	64625	+								
			1000	N	64623	+								
			1250	N	64626	+								
			1600	N	64627	+								
E4 Withdrawable W-VR	3p		1000	N	64628	+								
			1250	N	62629	+								
			1600	N	64630	+								
			2000	H	64633	+	58251	+	68806	59907	+	65619	+	68806
	4p		2500	N	64631	+								
			2000	H	64634	+								
			3200	N	64632	+								
			1600	S	64635	+								
E6 Withdrawable W-VR	3p		1600	S	64646	+								
			2000	S	64647	+								
			2500	S	64648	+	58251	+	-	59897	+	65619	+	-
			3200	S	64649	+								
	4p		3200	H	64650	+								
			1600	S	64651	+								
			2000	S	64652	+								
			2500	S	64653	+	58251	+	68806	59137	+	65619	+	68806
3p		3200	H	64654	+									
		4000	H	64655	+									
		3200	H	64662	+									
		4000	H	64663	+	58251	+	-	59140	+	65619	+	-	
		5000	H	64664	+									
4p		3200	H	64665	+									
		4000	H	64666	+	58251	+	68806	59143	+	65619	+	68806	
		5000	H	64667	+									

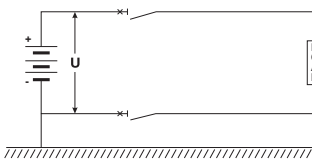

			1SDA0...R1
Ue	Ue < 100V	Vaux is compulsory	
	100V ≤ Ue ≤ 250V	Specific extracode for PR120/LV	65223
	250V ≤ Ue ≤ 500V*	PR120/V	

* For higher voltages, contact ABB



Vertical terminals				MP			Fixed part				
				1SDA0...R1	1SDA0...R1	1SDA0...R1	1SDA0...R1	1SDA0...R1	1SDA0...R1		
Size	Poles	Front view	Iu	Performance	Code	Extracode	Extracode	Code	Extracode	Extracode	
E2 Withdrawable W-VR	3p		800	B	64678						
			1000	B	64679						
			1250	B	64680		58251	-	59895	65619	-
	4p		1600	N	64681						
			800	B	64682						
			1000	B	64683						
E3 Withdrawable W-VR	3p		1250	B	64684						
			1250	B	64685		58251	68806	59906	65619	68806
			1600	B	64686						
			1600	N	64687						
			800	N	64706						
			1000	N	64707						
	4p		1250	N	64708						
			1600	N	64709						
			2000	H	64712		58251	-	59896	65619	-
			2000	N	64710						
			2000	H	64713						
			2500	N	64711						
E4 Withdrawable W-VR	3p		800	H	64714						
			800	N	64715						
			1000	N	64716						
			1250	N	64717						
			1600	N	64718						
			2000	H	64721		58251	68806	59907	65619	68806
	4p		2000	N	64719						
			2500	H	64722						
			2500	N	64720						
			2500	H	64723						
			1600	S	64734						
			2000	S	64735						
E6 Withdrawable W-VR	3p		2500	S	64736		58251	-	59897	65619	-
			3200	S	64737						
			3200	H	64738						
	4p		1600	S	64739						
			2000	S	64740						
			2500	S	64741		58251	68806	59137	65619	68806
3p		3200	S	64742							
		3200	H	64743							
		3200	H	64750							
		4000	H	64751		58251	-	59140	65619	-	
		5000	H	64752							
4p		3200	H	64753							
		4000	H	64754		58251	68806	59143	65619	68806	
		5000	H	64755							

Ordering codes

Network with earthed negative polarity - Lower power supply

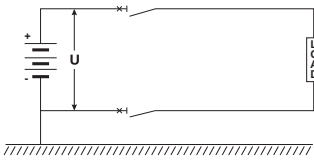

		1SDA0...R1
U _e	U _e < 100V	Vaux is compulsory
	100V ≤ U _e ≤ 250V	Specific extracode for PR120/LV
	250V ≤ U _e ≤ 500V*	PR120/V

* For higher voltages, contact ABB



Horizontal terminals			MP				Fixed part					
Size	Poles	Front view	I _u	Performance	Code	+	Extracode	Code	+	Extracode	+	Extracode
E2 Withdrawable W-HR	3p		800	B	64590	+	68806	59891	+	67149	+	-
			1000	B	64591	+						
			1250	B	64592	+						
			1600	B	64593	+						
	4p		800	B	64595	+						
			1000	B	64596	+						
			1250	B	64597	+						
			1600	B	64598	+						
E3 Withdrawable W-HR	3p		800	N	64618	+	68806	59892	+	67149	+	-
			1000	N	64619	+						
			1250	N	64620	+						
			1600	N	64621	+						
			2000	H	64624	+						
	4p		2500	N	64622	+						
			2500	H	64625	+						
			2500	N	64623	+						
			2500	H	64626	+						
			800	N	64627	+						
E4 Withdrawable W-HR	3p		1000	N	64628	+	68806	59904	+	67149	+	68806
			1250	N	62629	+						
			1600	N	64630	+						
			2000	H	64633	+						
	4p		2000	N	64631	+						
			2500	H	64634	+						
			2500	N	64632	+						
			2500	H	64635	+						
E6 Withdrawable W-HR	3p		1600	S	64646	+	68806	59136	+	67149	+	68806
			2000	S	64647	+						
			2500	S	64648	+						
			3200	S	64649	+						
	4p		3200	H	64650	+						
			1600	S	64651	+						
			2000	S	64652	+						
			2500	S	64653	+						
E6 Withdrawable W-HR	3p		3200	H	64654	+	68806	59139	+	67149	+	-
			4000	H	64663	+						
			5000	H	64664	+						
	4p		3200	H	64665	+						
			4000	H	64666	+						
5000	H	64667	+									

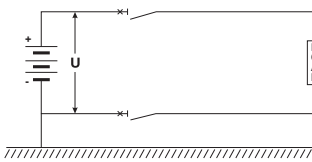

Ue	Ue < 100V	Vaux is compulsory	1SDA0...R1
	100V ≤ Ue ≤ 250V	Specific extracode for PR120/LV	65223
	250V ≤ Ue ≤ 500V*	PR120/V	

* For higher voltages, contact ABB



Horizontal terminals				MP				Fixed part					
Size	Poles	Front view	Iu	Performance	Code	+	Extracode	Code	+	Extracode	+	Extracode	
E2 Withdrawable W-HR	3p		800	B	64678	+							
			1000	B	64679	+							
			1250	B	64680	+		-	59891	+	67149	+	-
			1600	B	64681	+							
	4p		800	B	64683	+							
			1000	B	64684	+							
			1250	B	64685	+	68806		59903	+	67149	+	68806
			1600	B	64686	+							
E3 Withdrawable W-HR	3p		800	N	64706	+							
			1000	N	64707	+							
			1250	N	64708	+							
			1600	N	64709	+							
			2000	H	64712	+		-	59892	+	67149	+	-
	4p		2500	N	64711	+							
			800	N	64715	+							
			1000	N	64716	+							
			1250	N	64717	+							
			1600	H	64721	+	68806		59904	+	67149	+	68806
E4 Withdrawable W-HR	3p		2000	N	64710	+							
			2500	H	64713	+							
			3200	S	64737	+							
			1600	S	64734	+							
	4p		2000	S	64735	+							
			2500	S	64736	+							
			3200	H	64738	+							
			1600	S	64739	+							
E6 Withdrawable W-HR	3p		2000	S	64740	+							
			2500	S	64741	+	68806		59136	+	67149	+	68806
			3200	H	64742	+							
	4p		3200	H	64743	+							
			3200	H	64750	+							
			4000	H	64751	+		-	59139	+	67149	+	-
4p		5000	H	64752	+								
		3200	H	64753	+								
		4000	H	64754	+	68806		59142	+	67149	+	68806	
			5000	H	64755	+							

Ordering codes

Network with earthed negative polarity - Upper power supply

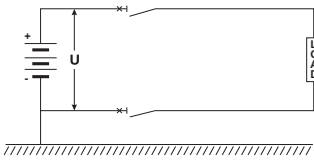

			1SDA0...R1
U _e	U _e < 100V	Vaux is compulsory	
	100V ≤ U _e ≤ 250V	Specific extracode for PR120/LV	65223
	250V ≤ U _e ≤ 500V*	PR120/V	

* For higher voltages, contact ABB



Horizontal terminals				MP			Fixed part							
Size	Poles	Front view	I _u	Performance	1SDA0...R1	1SDA0...R1	1SDA0...R1	1SDA0...R1	1SDA0...R1	1SDA0...R1				
				Code	+	Extracode	+	Extracode	+	Extracode				
E2 Withdrawable W-HR	3p		800	B	64590	+		+						
			1000	B	64591	+		+						
			1250	B	64592	+	58251	+	-	59891	+	67150		
	4p		800	B	64595	+		+						
			1000	B	64596	+		+						
			1250	B	64597	+	58251	+	68806	59903	+	67150	+	68806
E3 Withdrawable W-HR	3p		1600	N	64593	+		+						
			1600	N	64594	+		+						
			1600	N	64594	+		+						
			1600	N	64594	+		+						
			1600	N	64594	+		+						
	4p		800	B	64595	+		+						
			1000	B	64596	+		+						
			1250	B	64597	+	58251	+	68806	59903	+	67150	+	68806
			1600	B	64598	+		+						
			1600	N	64599	+		+						
E4 Withdrawable W-HR	3p		800	N	64618	+		+						
			1000	N	64619	+		+						
			1250	N	64620	+		+						
			1600	N	64621	+		+						
			1600	H	64624	+	58251	+	-	59892	+	67150	+	-
	4p		2000	N	64622	+		+						
			2000	H	64625	+		+						
			2500	N	64623	+		+						
			2500	H	64626	+		+						
			800	N	64627	+		+						
E6 Withdrawable W-HR	3p		1000	N	64628	+		+						
			1250	N	62629	+		+						
			1600	N	64630	+		+						
			1600	H	64633	+	58251	+	68806	59904	+	67150	+	68806
			2000	N	64631	+		+						
	4p		2000	H	64634	+		+						
			2500	N	64632	+		+						
			2500	H	64635	+		+						
			1600	S	64646	+		+						
			2000	S	64647	+		+						
E5 Withdrawable W-HR	3p		2500	S	64648	+	58251	+	-	59893	+	67150	+	-
			3200	S	64649	+		+						
			3200	H	64650	+		+						
			1600	S	64651	+		+						
			2000	S	64652	+		+						
	4p		2500	S	64653	+	58251	+	68806	59136	+	67150	+	68806
			3200	S	64654	+		+						
			3200	H	64655	+		+						
			3200	H	64662	+		+						
			4000	H	64663	+	58251	+	-	59139	+	67150	+	-
E6 Withdrawable W-HR	3p		5000	H	64664	+		+						
			3200	H	64665	+		+						
			3200	H	64665	+		+						
4p		4000	H	64666	+	58251	+	68806	59142	+	67150	+	68806	
		5000	H	64667	+		+							

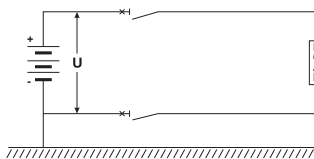

			1SDA0...R1
Ue	Ue<100V	Vaux is compulsory	
	100V≤Ue≤250V	Specific extracode for PR120/LV	65223
	250V≤Ue≤500V*	PR120/V	

* For higher voltages, contact ABB



Horizontal terminals				MP			Fixed part				
				1SDA0...R1	1SDA0...R1	1SDA0...R1	1SDA0...R1	1SDA0...R1	1SDA0...R1		
Size	Poles	Front view	Iu	Performance	Code	Extracode	Extracode	Code	Extracode	Extracode	
E2 Withdrawable W-HR	3p		800	B	64678						
			1000	B	64679						
			1250	B	64680		58251	-	59891	67150	-
			1600	B	64681						
	4p		800	B	64683						
			1000	B	64684						
			1250	B	64685		58251	68806	59903	67150	68806
			1600	B	64686						
E3 Withdrawable W-HR	3p		800	N	64706						
			1000	N	64707						
			1250	N	64708						
			1600	N	64709						
			2000	N	64710		58251	-	59892	67150	-
			2500	H	64711						
	4p		800	N	64715						
			1000	N	64716						
			1250	N	64717						
			1600	N	64718						
			2000	H	64721		58251	68806	59904	67150	68806
			2500	H	64722						
E4 Withdrawable W-HR	3p		1600	S	64734						
			2000	S	64735						
			2500	S	64736		58251	-	59893	67150	-
			3200	S	64737						
	4p		1600	H	64738						
			2000	S	64739						
			2500	S	64740						
			3200	S	64741		58251	68806	59136	67150	68806
E6 Withdrawable W-HR	3p		3200	H	64742						
			4000	H	64743						
			5000	H	64750		58251	-	59139	67150	-
			5000	H	64751						
	4p		3200	H	64752						
			4000	H	64753						
			5000	H	64754		58251	68806	59142	67150	68806
			5000	H	64755						

Ordering codes

SACE Emax switch-disconnectors for applications up to 1000V DC

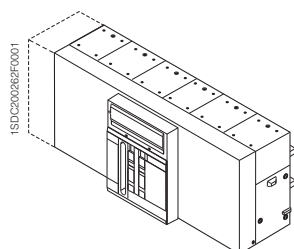
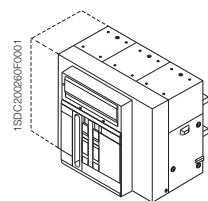
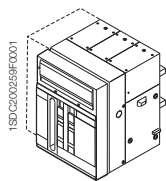

		1SDA.....R1 3 Poles 750V DC	4 Poles 1000V DC
E1B/E MS 08 Fixed (F)	Iu (40 °C) = 800 A Icw (1 s) = 20 kA HR = Horizontal rear terminals	059041	059042
E1B/E MS 12 Fixed (F)	Iu (40 °C) = 1250 A Icw (1 s) = 20 kA HR = Horizontal rear terminals	059043	059044
E1B/E MS 08 Withdrawable (W) - MP	Iu (40 °C) = 800 A Icw (1 s) = 20 kA MP = Moving part	059045	059046
E1B/E MS 12 Withdrawable (W) - MP	Iu (40 °C) = 1250 A Icw (1 s) = 20 kA MP = Moving part	059047	059048
E2N/E MS 12 Fixed (F)	Iu (40 °C) = 1250 A Icw (1 s) = 25 kA HR = Horizontal rear terminals	059049	059050
E2N/E MS 16 Fixed (F)	Iu (40 °C) = 1600 A Icw (1 s) = 25 kA HR = Horizontal rear terminals	059051	059052
E2N/E MS 20 Fixed (F)	Iu (40 °C) = 2000 A Icw (1 s) = 25 kA HR = Horizontal rear terminals	059053	059054
E2N/E MS 12 Withdrawable (W) - MP	Iu (40 °C) = 1250 A Icw (1 s) = 25 kA MP = Moving part	059055	059056
E2N/E MS 16 Withdrawable (W) - MP	Iu (40 °C) = 1600 A Icw (1 s) = 25 kA MP = Moving part	059057	059058
E2N/E MS 20 Withdrawable (W) - MP	Iu (40 °C) = 2000 A Icw (1 s) = 25 kA MP = Moving part	059059	059060
E3H/E MS 12 Fixed (F)	Iu (40 °C) = 1250 A Icw (1 s) = 40 kA HR = Horizontal rear terminals	059061	059062
E3H/E MS 16 Fixed (F)	Iu (40 °C) = 1600 A Icw (1 s) = 40 kA HR = Horizontal rear terminals	059063	059064
E3H/E MS 20 Fixed (F)	Iu (40 °C) = 2000 A Icw (1 s) = 40 kA HR = Horizontal rear terminals	059065	059066
E3H/E MS 25 Fixed (F)	Iu (40 °C) = 2500 A Icw (1 s) = 40 kA HR = Horizontal rear terminals	059067	059068
E3H/E MS 32 Fixed (F)	Iu (40 °C) = 3200 A Icw (1 s) = 40 kA HR = Horizontal rear terminals	059069	059070
E3H/E MS 12 Withdrawable (W) - MP	Iu (40 °C) = 1250 A Icw (1 s) = 40 kA MP = Moving part	059071	059072
E3H/E MS 16 Withdrawable (W) - MP	Iu (40 °C) = 1600 A Icw (1 s) = 40 kA MP = Moving part	059073	059074
E3H/E MS 20 Withdrawable (W) - MP	Iu (40 °C) = 2000 A Icw (1 s) = 40 kA MP = Moving part	059075	059076
E3H/E MS 25 Withdrawable (W) - MP	Iu (40 °C) = 2500 A Icw (1 s) = 40 kA MP = Moving part	059077	059078
E3H/E MS 32 Withdrawable (W) - MP	Iu (40 °C) = 3200 A Icw (1 s) = 40 kA MP = Moving part	059079	059080
E4H/E MS 32 Fixed (F)	Iu (40 °C) = 3200 A Icw (1 s) = 65 kA HR = Horizontal rear terminals	059081	058911
E4H/E MS 40 Fixed (F)	Iu (40 °C) = 4000 A Icw (1 s) = 65 kA HR = Horizontal rear terminals	059082	058913
E4H/E MS 32 Withdrawable (W) - MP	Iu (40 °C) = 3200 A Icw (1 s) = 65 kA MP = Moving part	059083	058912
E4H/E MS 40 Withdrawable (W) - MP	Iu (40 °C) = 4000 A Icw (1 s) = 65 kA MP = Moving part	059084	058914
E6H/E MS 40 Fixed (F)	Iu (40 °C) = 4000 A Icw (1 s) = 65 kA HR = Horizontal rear terminals	058915	058921
E6H/E MS 50 Fixed (F)	Iu (40 °C) = 5000 A Icw (1 s) = 65 kA HR = Horizontal rear terminals	058917	058923
E6H/E MS 63 Fixed (F)	Iu (40 °C) = 6300 A Icw (1 s) = 65 kA HR = Horizontal rear terminals	058919	058925
E6H/E MS 40 Withdrawable (W) - MP	Iu (40 °C) = 4000 A Icw (1 s) = 65 kA MP = Moving part	058916	058922
E6H/E MS 50 Withdrawable (W) - MP	Iu (40 °C) = 5000 A Icw (1 s) = 65 kA MP = Moving part	058918	058924
E6H/E MS 63 Withdrawable (W) - MP	Iu (40 °C) = 6300 A Icw (1 s) = 65 kA MP = Moving part	058920	058926

Ordering codes

Fixed parts for SACE Emax switch-disconnectors for applications up to 1000V DC

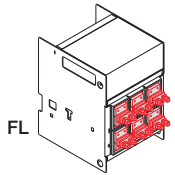
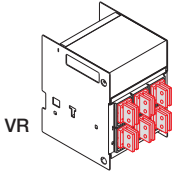
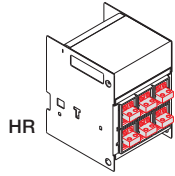

		1SDA.....R1	
		3 Poles 750V DC	4 Poles 1000V DC
E1 MS/E Withdrawable (W) - FP	FP = Fixed part		
	HR	059890	059902
	VR	059894	059905
E2 MS/E Withdrawable (W) - FP	FP = Fixed part		
	HR	059891	059903
	VR	059895	059906
E3 MS/E Withdrawable (W) - FP	FP = Fixed part		
	HR	059892	059904
	VR	059896	059907
E4 MS/E Withdrawable (W) - FP	FP = Fixed part		
	HR	059893	059136
	VR	059897	059137
E6 MS/E Withdrawable (W) - FP	FP = Fixed part		
	HR	059139	059142
	VR	059140	059143
	FL	059141	059144

Ordering codes

SACE Emax DC accessories

Electrical accessories

1SDA...R1



Undervoltage release - YU (2a)

E2/6 DC	24V DC	038286
E2/6 DC	30V AC / DC	038287
E2/6 DC	48V AC / DC	038288
E2/6 DC	60V AC / DC	038289
E2/6 DC	110...120V AC / DC	038290
E2/6 DC	120...127V AC / DC	038291
E2/6 DC	220...240V AC / DC	038292
E2/6 DC	240...250V AC / DC	038293
E2/6 DC	380...400V AC	038294
E2/6 DC	440...480V AC	038295

Note: the shunt opening (YO) and closing (YC) releases are constructionally identical and therefore interchangeable. Their function is linked to the assembly position on the circuit-breaker.



Electronic time-delay device for undervoltage release - D (2b)

E2/6 DC	24V DC	050157
E2/6 DC	30V AC / DC	050158
E2/6 DC	48V AC / DC	050159
E2/6 DC	60V AC / DC	050160
E2/6 DC	110...120V AC / DC	050161
E2/6 DC	120...127V AC / DC	050162
E2/6 DC	220...240V AC / DC	050163
E2/6 DC	240...250V AC / DC	050164
E2/6 DC	380...400V AC	050165
E2/6 DC	440...480V AC	050166

Note: supplied with support for special releases.



Shunt closing release - YC (1a)

E2/6 DC	24V DC	038296
E2/6 DC	30V AC / DC	038297
E2/6 DC	48V AC / DC	038298
E2/6 DC	60V AC / DC	038299
E2/6 DC	110...120V AC / DC	038300
E2/6 DC	120...127V AC / DC	038301
E2/6 DC	220...240V AC / DC	038302
E2/6 DC	240...250V AC / DC	038303
E2/6 DC	380...400V AC	038304
E2/6 DC	440...480V AC	038305

Note: the shunt opening (YO) and closing (YC) releases are constructionally identical and therefore interchangeable. Their function is linked to the assembly position on the circuit-breaker.

SOR Test Unit - (1b)

E2/6 DC		050228
---------	--	--------



Undervoltage release - YU (2a)

E2/6 DC	24V DC	038306
E2/6 DC	30V AC / DC	038307
E2/6 DC	48V AC / DC	038308
E2/6 DC	60V AC / DC	038309
E2/6 DC	110...120V AC / DC	038310
E2/6 DC	120...127V AC / DC	038311
E2/6 DC	220...240V AC / DC	038312
E2/6 DC	240...250V AC / DC	038313
E2/6 DC	380...400V AC	038314
E2/6 DC	440...480V AC	038315

**Electronic time-delay device for undervoltage release - D (2b)**

E2/6 DC	24...30V DC	038316
E2/6 DC	48V AC / DC	038317
E2/6 DC	60V AC / DC	038318
E2/6 DC	110...127V AC / DC	038319
E2/6 DC	220...250V AC / DC	038320

**Geared motor for automatic charging of the closing springs - M (3)**

E2/6 DC	24...30V AC / DC	038321
E2/6 DC	48...60V AC / DC	038322
E2/6 DC	100...130V AC / DC	038323
E2/6 DC	220...250V AC / DC	038324

Note: it is always supplied with limit contact and microswitch for indication of closing springs charged (accessory 5d)

Overcurrent release trip indication - (4a)

E2/6 DC		058260
---------	--	--------

Electrical indication of overcurrent release trip by remote control - (4b)

E2/6 DC	220...240V AC/DC	058261
E2/6 DC	110...130V AC/DC	058262
E2/6 DC	24...30V AC/DC	058263

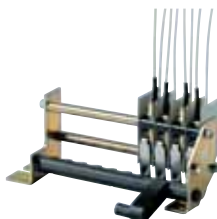
**Electrical indication of circuit-breaker open/closed - Q1 ... 10 - (5a)**

E2/6 DC - PR122-3/DC	4 auxiliary contacts (2NO+2NC+2PR122-3)	068801 (c)
E2/6 DC - PR122-3/DC	4 auxiliary contacts (2NO+2NC+2PR122-3) for digital signals	068802
E2/6 DC - PR122-3/DC	10 auxiliary contacts (5NO+5NC+2PR122-3 - installed)	068803 (a)
E2/6 DC - PR122-3/DC	10 auxiliary contacts (5NO+5NC+2PR122-3 - not installed)	068804 (b)
E2/6 DC - PR122-3/DC	10 auxiliary contacts (5NO+5NC+2PR122-3) for digital signals	068805

Note: (a) Can only be ordered mounted with circuit-breakers.
 (b) Can only be ordered loose in the case of circuit-breakers.
 (c) Already included for circuit-breakers with PR122/DC and PR123/DC. Can only be ordered as loose accessories.

Additional external electrical indication of circuit-breaker open/closed - Q11 ... 25 - (5b)

E2/6 DC	15 additional auxiliary contacts (version for fixed/ withdrawable racked-in)	043475 (a)
E2/6 DC	15 additional auxiliary contacts (version for withdrawable racked-in/ test)	048827
E2/6 DC	15 additional auxiliary contacts for digital signals (version for fixed/withdrawable racked-in)	050145 (a)
E2/6 DC	15 additional auxiliary contacts for digital signals (version for withdrawable racked-in/ test)	050151

Note: Outside the circuit-breaker. To be requested in alternative to the different types of interlocks (accessory 10) and to the mechanical compartment door lock (accessory 8f).
 (a) For fixed version, also request the interlock plate (accessory 10.4).

Ordering codes

SACE Emax DC accessories

1SDA...R1
3 poles 4 poles



Electrical indication of circuit-breaker racked-in/isolated test/isolated S75 - (5c)

E2/6 DC	5 auxiliary contacts	038361	038361
E1-E2	10 auxiliary contacts	038360	043467
E3	10 auxiliary contacts	043468	043469
E4-E6	10 auxiliary contacts	043470	043470
E2/6 DC	5 auxiliary contacts for digital signals	050146	050146
E1-E2	10 auxiliary contacts for digital signals	050147	050148
E4-6	10 auxiliary contacts for digital signals	050147	050147
E3	10 auxiliary contacts for digital signals	050149	050150



Signalling contact for closing springs charged S33 M/2- (5d)

E2/6 DC			038325
---------	--	--	--------

Note: already supplied with the geared motor for automatic charging of the closing springs.



Contact for signalling undervoltage release de-energised - (5e)

E2/6 DC	1 normally closed contact		038341
E2/6 DC	1 normally open contact		038340

Mechanical accessories

1SDA...R1

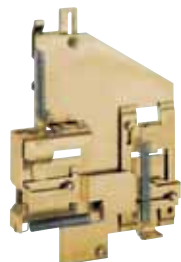

Mechanical operation counter - (7)

E2/6 DC		038345
---------	--	--------

Locks in open position - (8a-8b)

with key (8a)

E2/6 DC	for 1 circuit-breaker (different keys)	058271
E2/6 DC	for groups of circuit-breakers (same keys N.20005)	058270
E2/6 DC	for groups of circuit-breakers (same keys N.20006)	058274
E2/6 DC	for groups of circuit-breakers (same keys N.20007)	058273
E2/6 DC	for groups of circuit-breakers (same keys N.20008)	058272
E2/6 DC	for groups of circuit-breakers (same keys N.20009)	064503

with padlocks (8b)

E2/6 DC	ø 4 mm	038351 (a)
E2/6 DC	ø 8 mm	064504

Note: (a) to be requested in alternative to the opening and closing pushbutton protection (accessory 9a).

Circuit-breaker lock in racked-in/test/racked-out position - (8c)

E2/6 DC	for 1 circuit-breaker (different keys and with padlocks Ø 4mm)	058278
E2/6 DC	for groups of circuit-breakers (same keys N.2005 and with padlocks Ø 4mm)	058277
E2/6 DC	for groups of circuit-breakers (same keys N.2006 and with padlocks Ø 4mm)	058281
E2/6 DC	for groups of circuit-breakers (same keys N.2007 and with padlocks Ø 4mm)	058280
E2/6 DC	for groups of circuit-breakers (same keys N.2008 and with padlocks Ø 4mm)	058279
E2/6 DC	for groups of circuit-breakers (same keys N.2009 and with padlocks Ø 4mm)	064505
E2/6 DC	for 1 circuit-breaker (same keys N.2009 and with padlocks Ø 6mm)	064506
E2/6 DC	for groups of circuit-breakers (same keys N.2005 and with padlocks Ø 6mm)	064507
E2/6 DC	for groups of circuit-breakers (same keys N.2006 and with padlocks Ø 6mm)	064508
E2/6 DC	for groups of circuit-breakers (same keys N.2007 and with padlocks Ø 6mm)	064509
E2/6 DC	for groups of circuit-breakers (same keys N.2008 and with padlocks Ø 6mm)	064510
E2/6 DC	for groups of circuit-breakers (same keys N.2009 and with padlocks Ø 6mm)	064511

Padlocks

E2/6 DC	Ø 8mm	064512
---------	-------	--------

Preset for key lock

RONIS

Cap preset		058315
Lock in open position		058276
Lock in racked-in/test/racked-out position		058314

CASTELL

Lock in open position		058275
-----------------------	--	--------

Accessory for lock in test/racked-out position - (8d)

E1/6		038357
------	--	--------

Note: to be requested for completion of the circuit-breaker lock in racked-in / test / racked-out position (accessory 8c)

Accessory for shutter padlock lock - (8e)

E2/6 DC		038363
---------	--	--------

Mechanical compartment door lock - (8f)

E2/6 DC		045039
---------	--	--------

Note:

- to be requested with interlock for fixed circuit-breaker/moving part of withdrawable circuit-breaker (accessory 10.2)
- for fixed version, also request interlock plate 10.4
- to be ordered in alternative to the cable interlocks (accessory 10.1), and in alternative to the 15 additional auxiliary contacts (accessory 5b).

Ordering codes

SACE Emax DC accessories

1SDA...R1



Opening and closing pushbutton protection - (9a)

E2/6 DC		038343
---------	--	--------

Note: to be requested in alternative to the lock with padlocks in open position (accessory 8b).



IP54 Door protection - (9b)

E2/6 DC	Different keys	038344
E2/6 DC	Same keys	065622

Protection for sealable relay - (9c)

E2/6 DC for PR121		058316
E2/6 DC for PR122/PR123		058317

Mechanical interlock - (10)

10.1 Interlock cables for fixed circuit-breakers or fixed parts

E2/6 DC	A - horizontal	038329
E2/6 DC	B - horizontal	038330
E2/6 DC	C - horizontal	038331
E2/6 DC	D - horizontal	038332
E2/6 DC	A - vertical	038333
E2/6 DC	B - vertical	038334
E2/6 DC	C - vertical	038335
E2/6 DC	D - vertical	038336

Note: request one type of cable for each interlock. To be requested on one of the fixed circuit-breakers or on one of the fixed parts.

10.1 Extended interlock cables for fixed circuit-breakers or fixed parts

E2/6 DC	A - horizontal extended cables	066090
E2/6 DC	B - horizontal extended cables	066091
E2/6 DC	C - horizontal extended cables	066092
E2/6 DC	D - horizontal extended cables	066093
E2/6 DC	A - vertical extended cables	066094
E2/6 DC	B - vertical extended cables	066095
E2/6 DC	C - vertical extended cables	066096
E2/6 DC	D - vertical extended cables	066097

Note: request one type of cable for each interlock. To be requested on one of the fixed circuit-breakers or on one of the fixed parts.

1SDA...R1
3 poles 4 poles

10.3 Interlock for fixed circuit-breaker/moving part of withdrawable circuit-breaker

E1-E2	038366	038366
E3	038367	038367
E4	038368	043466
E6	043466	038369

Note: request an accessory for each fixed circuit-breaker/moving part of withdrawable circuit-breaker.

10.4 Interlock for fixed circuit-breaker/interlock part of withdrawable

E2/6 DC	Interlock A / B / D	038364
E2/6 DC	Interlock C	038365

Note: request an accessory for each fixed circuit-breaker/moving part of withdrawable circuit-breaker.

10.5 Interlock plate for fixed circuit-breaker

E2/6 DC		038358
---------	--	--------

Note: only request for fixed circuit-breaker.

Auxiliary units

1SDA...R1



PR010/T test and programming unit

E2/6 DC	PR010/T	048964
---------	---------	--------

PR021/K indication unit

E2/6 DC	PR021/K	059146
---------	---------	--------

PR120/K indication module

E2/6 DC	PR120/K (4 Outputs with independent terminals)	058255
E2/6 DC	PR120/K (4 Outputs + 1 Input with one terminal in common)	058256



PR120/LV voltage measurement module for $100V \leq U_e \leq 250V$

E2/6 DC	PR120/LV	065223
---------	----------	--------

Note: Each Emax DC circuit-breaker has the PR120/V voltage measurement module included. The PR120/LV is used for $100V < U_e < 250V$

PR120/D-M (Modbus RTU) communication module

E1/6	PR120/D-M	058254
------	-----------	--------

BT030-USB

E1/6	BT030-USB	058259
------	-----------	--------

Ordering Examples

Selection of an Emax DC circuit-breaker depends on the plant requirements:

a. Plant requirements:

- Type of network: insulated network
- Rated current (I_u): 800A
- Rated voltage (U_e): 110V
- Short-circuit current: I_{cu}= 20kA
- Version: Withdrawable (W)
- Power supply: from lower terminals
- Protections required of the trip unit: LSI
- Terminals: horizontal rear (HR)

Insulated network⁽¹⁾

Rated voltage (U _e)			≤ 500	≤ 750	≤ 1000
isolation			■	■	■
protection			■	■	■
PR122/DC			■	■	■
PR123/DC			■	■	■
I _{cu} ⁽²⁾			[kA]	[kA]	[kA]
E2	B	800	35	25	25
		1000			
		1250			
		1600			
E3	N	1600	50	25	25
		800			
		1000			
		1250			
	H	1600	65 ⁽³⁾	40	50
		2000			
		2500			
E4	S	1600	75	65	65
		2000			
		2500			
	H	3200			
E6	H	3200			
		4000	100	65	65
5000					

⁽¹⁾ the possibility of a double earth fault is considered negligible with this type of pole connections. For further information, see QT5: "ABB circuit-breakers for direct current applications".

⁽²⁾ I_{cu} with L/R = 15ms according to IEC 60946-2 Standard. For I_{cu} with L/R = 5ms and L/R = 30ms, ask ABB.

⁽³⁾ 85kA only if supplied from below and specifying the following extracode at the ordering stage: 1SDA067148R1. I_{cs}=65kA.

According to plant requirements, the choice falls on E2B 3p because it has a value of $I_{cu} \geq 20kA$, 800A rated current and is fitted with PR122/DC.

As for all the withdrawable version circuit-breakers, both the moving part and the fixed part must be ordered:

Moving part: as the standard solution, ABB SACE supplies the Emax DC moving parts with voltage sockets located on the lower terminals, according to power supply from these same terminals.

Fixed part: The same fixed parts with horizontal terminals as the switch-disconnectors are used for special direct current applications (MS/E) up to 750V DC if they are 3p, up to 1000V DC if they are 4p.

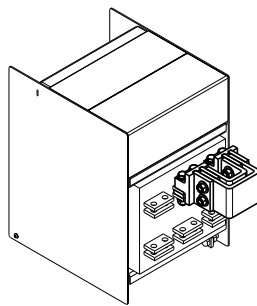

3D rear view

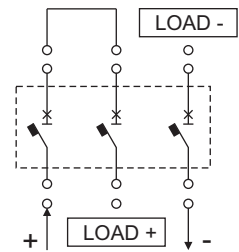

Front view

Emax DC fixed E2B 3pole with horizontal terminals (HR)

1SDA064590R1	E2B 800 PR122/DC-In=800A MP
+	
1SDA065223R1	EXTRACODE for voltage $100V \leq U_e \leq 250V$
1SDA059891R1	FIXED PART E2 3p HR
+	
1SDA067149R1	EXTRACODE for power supply from lower terminals

Ordering Examples

Plant requirements:

- Type of network: with mid-point earthed
- Rated current (I_u): 2500A
- Rated voltage (U_e): 1000V
- Short-circuit current (I_{cu}): 30kA
- Version: Fixed (F)
- Power supply: from the vertical upper terminals

Network with the mid-point earthed

Rated voltage (U _e)			≤ 500			≤ 500			≤ 750			≤ 1000		
PR122/DC			-			-			-			-		
PR123/DC			■			■			■			■		
type of fault			a	b	c	a	b	c	a	b	c	a	b	c
poles in series affected by the fault			3	2 (U/2)	1 (U/2)	4	2 (U/2)	2 (U/2)	4	2 (U/2)	2 (U/2)	4	2 (U/2)	2 (U/2)
I _{cu} ⁽¹⁾			[kA]			[kA]			[kA]			[kA]		
E2	B	800												
		1000												
		1250	35	35	18	35	35	35	25	25	25	25	25	25
		1600												
E3	N	1600	50	50	25	50	50	50	40	40	40	25	25	25
		800												
		1000												
		1250	60	60	30	60	60	60	50	50	50	35	35	35
		2000												
E4	H	1600												
		2000	65 ⁽²⁾	65	40	65 ⁽²⁾	65 ⁽²⁾	65 ⁽²⁾	50	50	50	40	40	40
		2500												
		3200												
E6	H	1600												
		2000	75	75	35	75	75	75	65	65	65	50	50	50
		2500												
E6	H	3200	100	100	50	100	100	100	65	65	65	65	65	65
		4000												
		5000												

⁽¹⁾ I_{cu} with L/R = 15ms according to IEC 60946-2 Standard. For I_{cu} with L/R = 5ms and L/R = 30ms, ask ABB.

⁽²⁾ 85kA only if supplied from below and specifying the following extracode at the ordering stage: 1SDA067148R1. I_{cs}=65kA.

According to plant requirements, the choice falls on E3N because it has a value of $I_{cu} \geq 30kA$ and 2500A rated current. Since a voltage $U_e \geq 750V$ is required, the version with 4 poles is necessary.

E3N20 PR123/DC 4p power supply from the upper terminals

As the standard solution, ABB SACE supplies fixed direct current circuit-breakers supplied from the lower terminals. In the case of power supply from upper terminals, it is necessary to specify the 1SDA058251R1 extracode at the time of ordering.

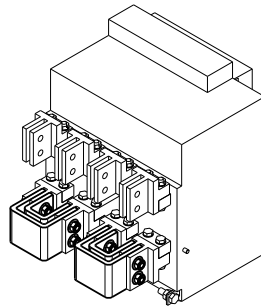

3D rear view

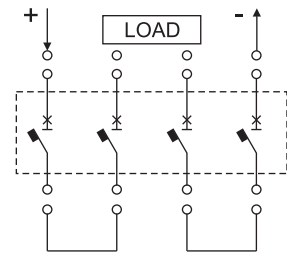

Front view

Emax DC E4S /DC 4p power with upper supply

1SDA064702R1	E3N 2500 PR123/DC-In=2500A 4p F VR
+	
1SDA058251R1	Extracode for power supply from upper terminals

Ordering Examples

Plant requirements:

- Type of network: with earthed negative polarity
- Rated current (I_u): 1600A
- Rated voltage (U_e): 400V
- Short-circuit current (I_{cu}): 65kA also in the case of type "b" fault
- Version: Withdrawable (W)
- Power supply: from lower terminals
- Vertical terminals
- Protections: LSIG

Network with earthed negative polarity ⁽¹⁾

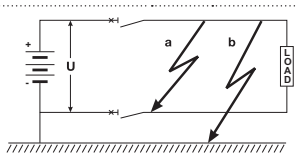
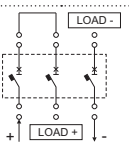
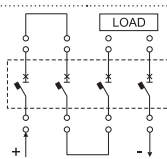
Rated voltage (U _e)		≤ 500 ⁽²⁾				
						
isolation		■		■		
protection		■		■		
PR122/DC		■		■		
PR123/DC		■		■		
type of fault ⁽³⁾		a		b		
poles in series affected by the fault		3		2		
I _{cu} ⁽⁴⁾		[kA]		[kA]		
E2	B	800	35	20	35	35
		1000				
		1250				
		1600				
E3	N	1600	60	30	60	60
		800				
		1000				
		1250				
E3	H	1600	65 ⁽⁵⁾	40	65 ⁽⁵⁾	65 ⁽⁵⁾
		2000				
		2500				
		1600				
E4	S	2000	100	50	100	100
		2500				
		3200				
		3200				
E6	H	3200	100	65	100	100
		4000				
		5000				

⁽¹⁾ for networks with positive earthed polarity, ask ABB.

⁽²⁾ for higher voltages, ask ABB.

⁽³⁾ for further information, see QT5: "ABB circuit-breakers for direct current applications".

⁽⁴⁾ I_{cu} with L/R = 15ms according to IEC 60946-2 Standard. For I_{cu} with L/R = 5ms and L/R = 30ms, ask ABB.

⁽⁵⁾ 85kA only if supplied from below and specifying the following extracode at the ordering stage: 1SDA067148R1. I_{cs}=65kA.

According to plant requirements, the choice falls on E3H because it has a value of I_{cu} (up to 500V) $\geq 65kA$ and 1600A rated current, 4 poles.

E3H 16 PR123/DC 4p F VR

As the standard solution, ABB SACE supplies fixed direct current circuit-breakers supplied from lower terminals. The 4-pole configuration for network with earthed negative polarity requires a special extracode which makes it possible to have 3 poles in series on the positive polarity (not earthed): 1SDA068806R1.

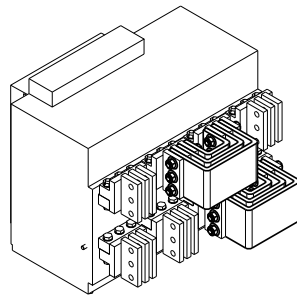

3D rear view

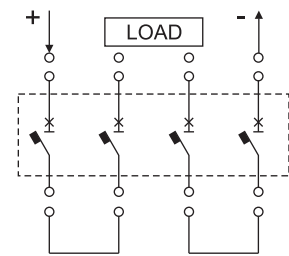

Front view

Emax DC E3H 16 PR123/DC 4p power upper supply with horizontal terminals (HR)

1SDA064703R1 : E3H 1600 PR123/DC- $I_n=1600$ 4p F

+

1SDA068806R1 : Extracode for special connection with 3 poles in series on the positive polarity (not earthed)

Notes

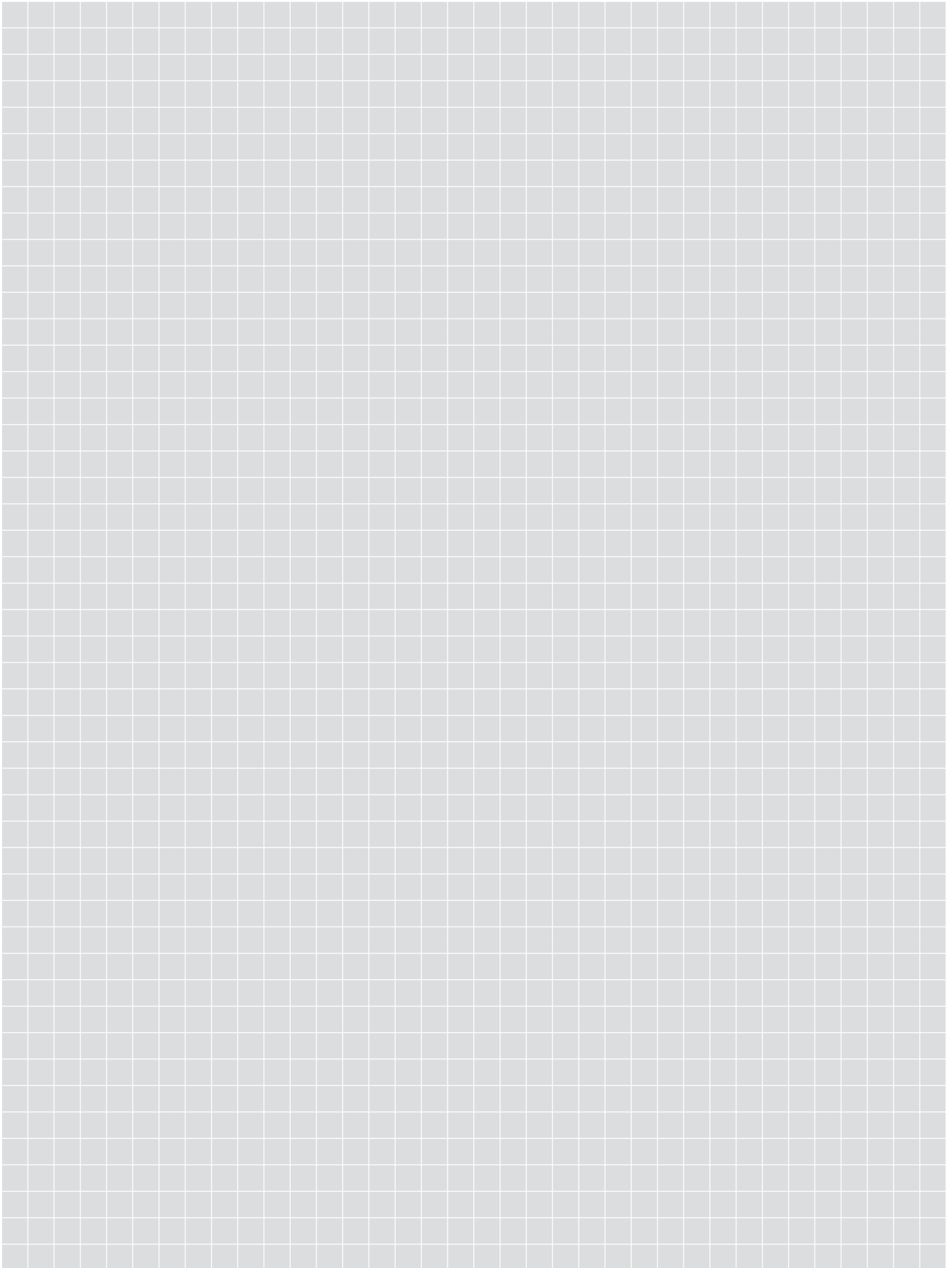

Notes

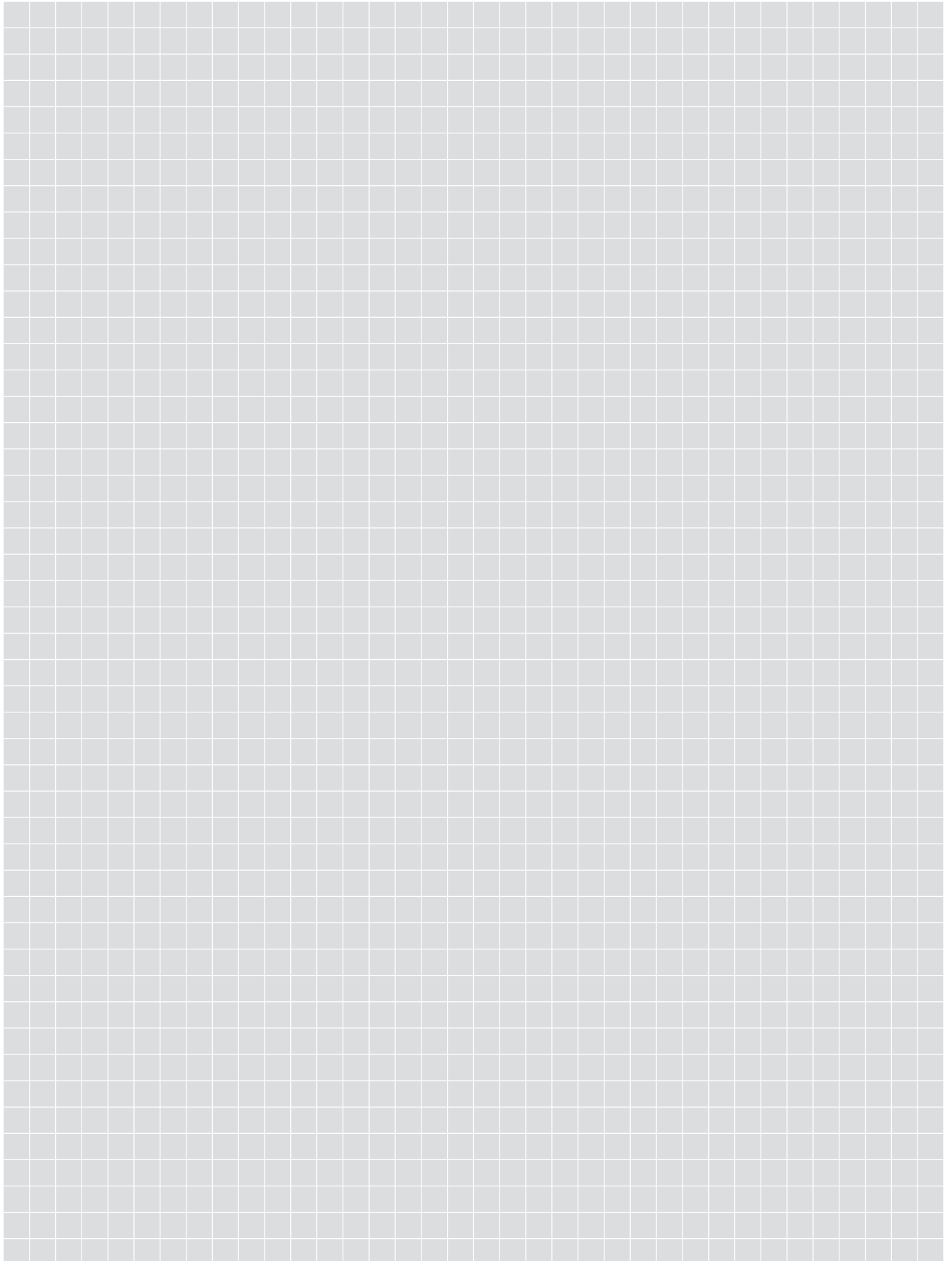

Notes

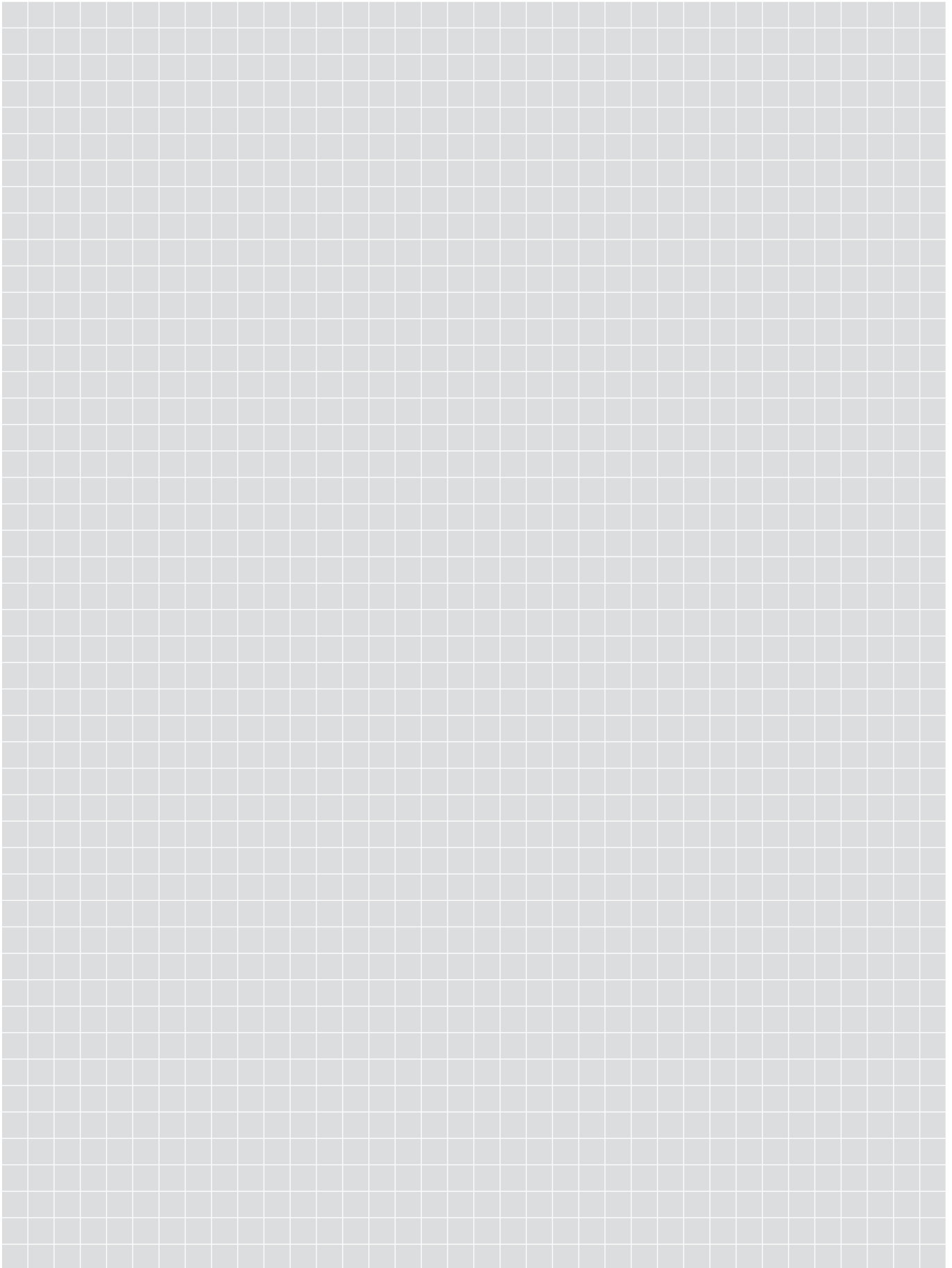

Contact us

ABB SACE

A division of ABB S.p.A.

L.V. Breakers

Via Baioni, 35

24123 Bergamo

Phone: +39 035 395.111

Fax: +39 035 395.306-433

www.abb.com

The data and illustrations are not binding. We reserve the right to modify the contents of this document on the basis of technical development of the products, without prior notice.

Copyright 2010 ABB.
All rights reserved.

1SDC200012D0202 - 01/10 - 5.000 - CAL

Power and productivity
for a better world™

