



The ABB-Welcome door entry system Example systems and instructions

Contents

General instructions	5
Explanation of symbols	5
Connection principles	6
Connections and settings of the devices	9
Commissioning and settings	19
Dimensions	24

Adaptability

One solution for all needs

The comprehensive and well-designed ABB-Welcome system offers a solution for all needs and situations in both new construction and renovation projects.

Whether you are working on a house or an apartment building, or a site requiring special security, ABB-Welcome fulfills your wishes. With the two-wire bus system of the ABB-Welcome door entry system, the installation work, commissioning and everyday use are trouble-free. ABB-Welcome is an ideal solution for all needs, fulfilling the dreams of designers, installers and end users.

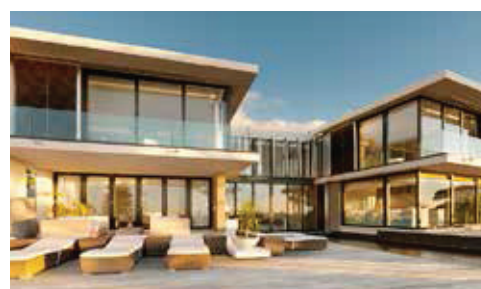

General instructions

- All wires must be connected to hardware at both ends, meaning that there will be no loose ends.
- Do not position the central unit near transformers or coils.
- Do not position the bus lines of the door entry system near 230V/380V cables.
- Do not use any other pairs of the bus line for controlling electronic locks.
- Only use one cable type for all bus lines.
- Only use one pair in multiconductor cables, i.e. no doubling or multiple connections.
- Use a twisted pair of at least 0.8 mm² (e.g. KLMA 2 x 0.8 mm²).
- The bus voltage must be at least 21 V at the last device on the bus.

Explanation of symbols



Video/audio indoor unit

VIDEO/AUDIO

RC-ON Terminal resistor on



Outdoor unit

RC-OFF Terminal resistor off



Electronic lock



Indoor video distributor



Front door



Outdoor video distributor



2 x KLM(A) 0.8 mm²



Central unit



Mini-sized central unit

Connection in series

2 x KLM(A) 0.8 mm²

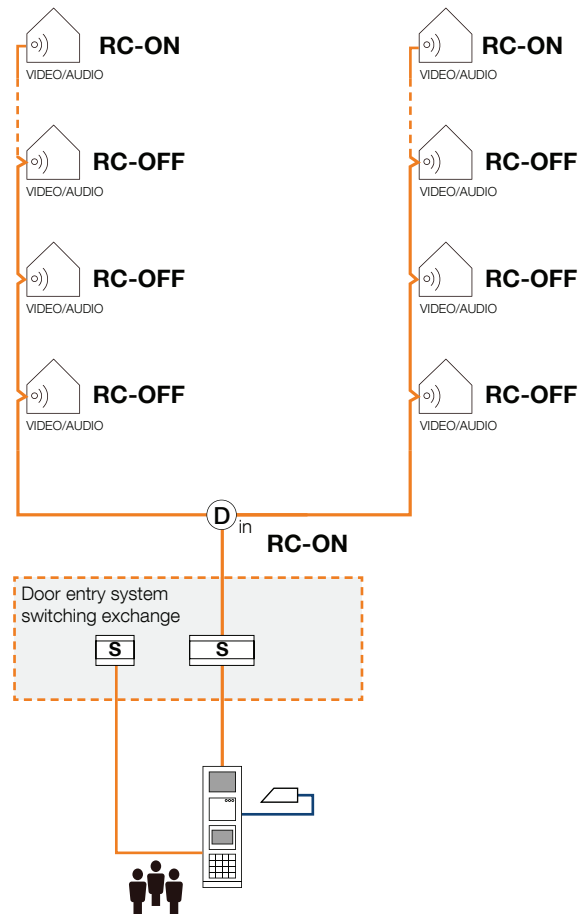

The central unit can supply approximately 40 devices. If each outdoor unit has an auxiliary power source, the maximum number of devices is approximately 60. In larger systems, the devices are divided into areas of suitable size with a line coupler. The exact numbers of devices and the required auxiliary power sources depend on the cable lengths and types, as well as other conditions.

Branched connection

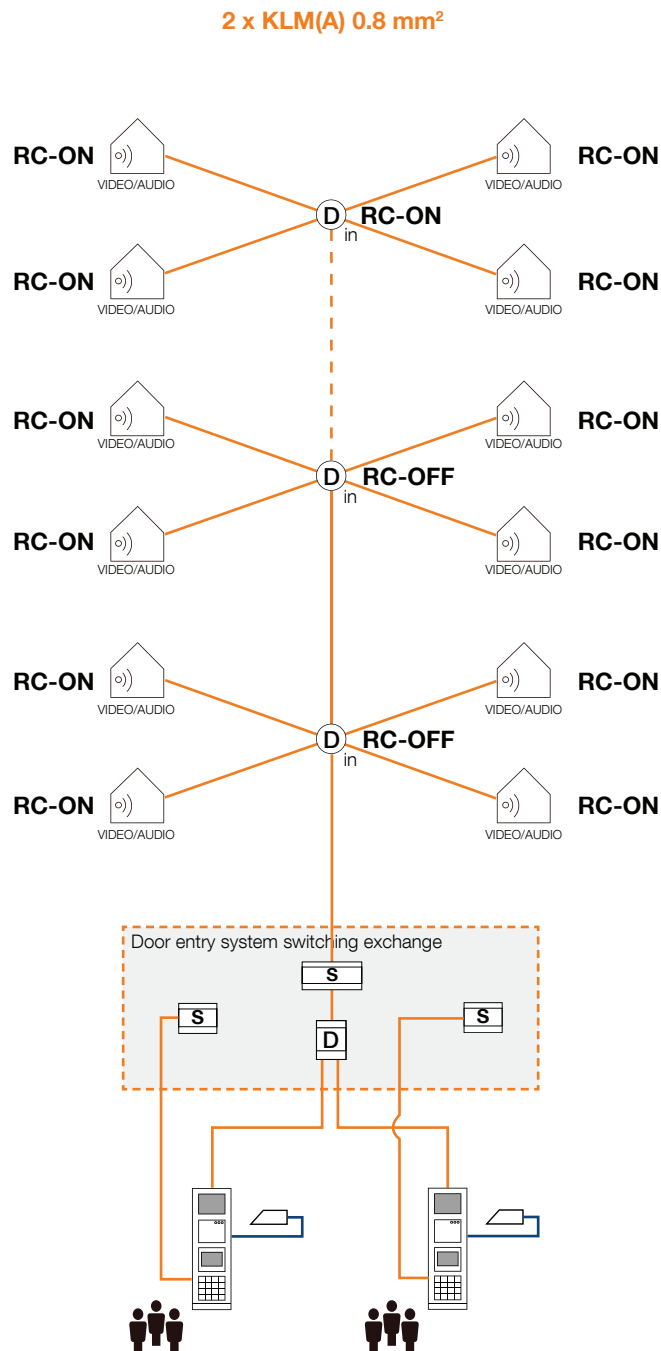

The central unit can supply approximately 40 devices. If each outdoor unit has an auxiliary power source, the maximum number of devices is approximately 60. In larger systems, the devices are divided into areas of suitable size with a line coupler. The exact numbers of devices and the required auxiliary power sources depend on the cable lengths and types, as well as other conditions.

Combined connection

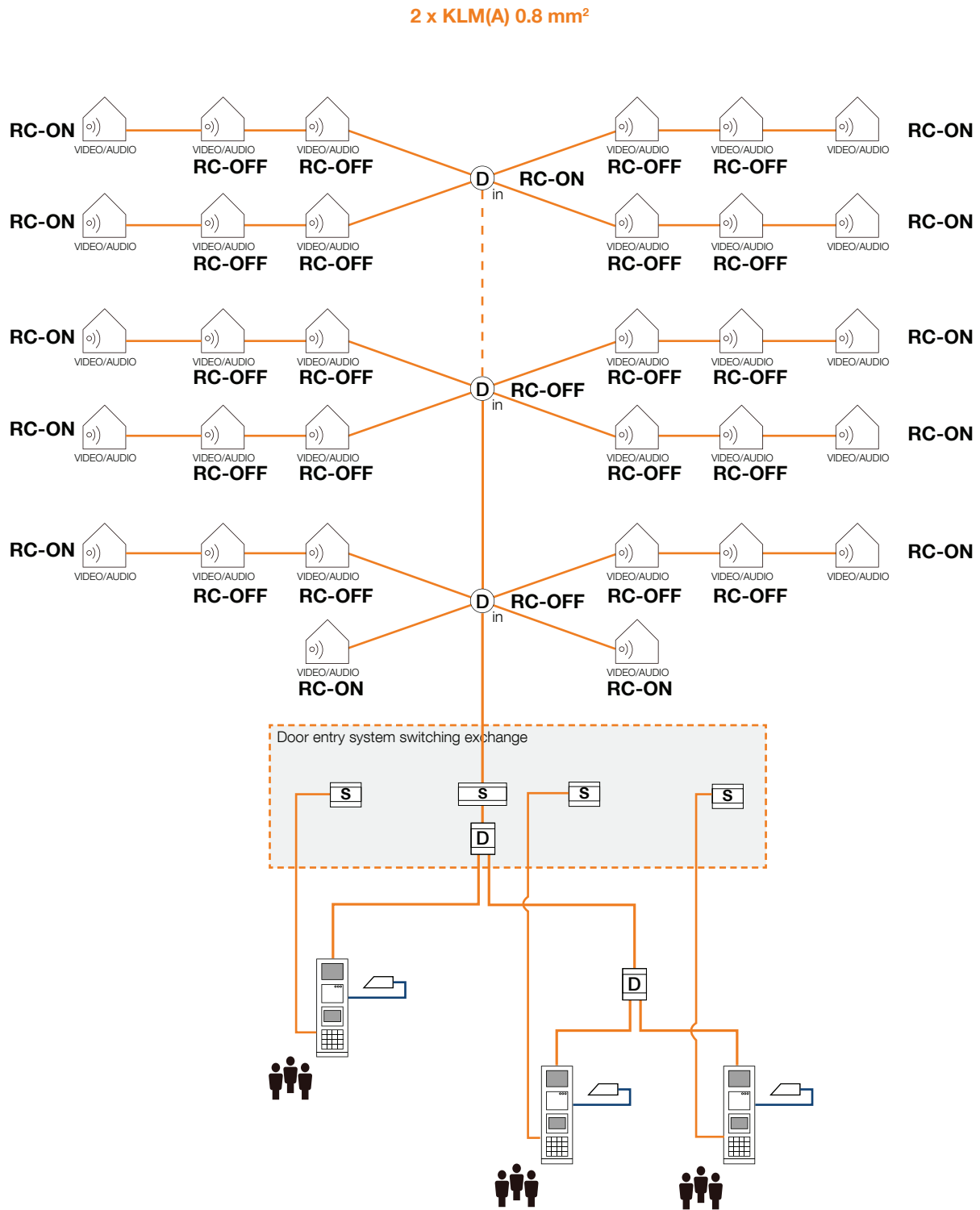

The central unit can supply approximately 40 devices. If each outdoor unit has an auxiliary power source, the maximum number of devices is approximately 60. In larger systems, the devices are divided into areas of suitable size with a line coupler. The exact numbers of devices and the required auxiliary power sources depend on the cable lengths and types, as well as other conditions.

Connections and settings of the devices

Module wiring

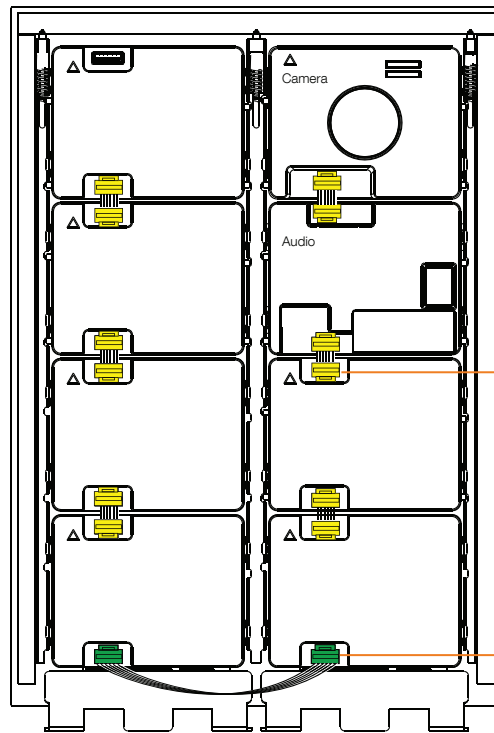
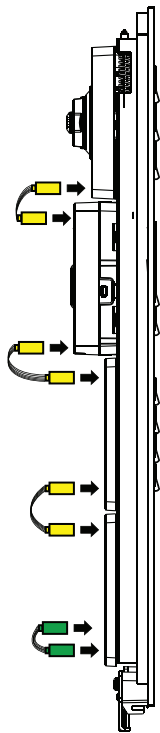

Flat cables are always included in the module delivery.

The connecting cable is included with the 2/3 and 2/4 front plates.

The 51021J connecting accessory for cover frames can be ordered separately when using a rain cover 51027RH.

M251022A-A - audio module 1-button

Back

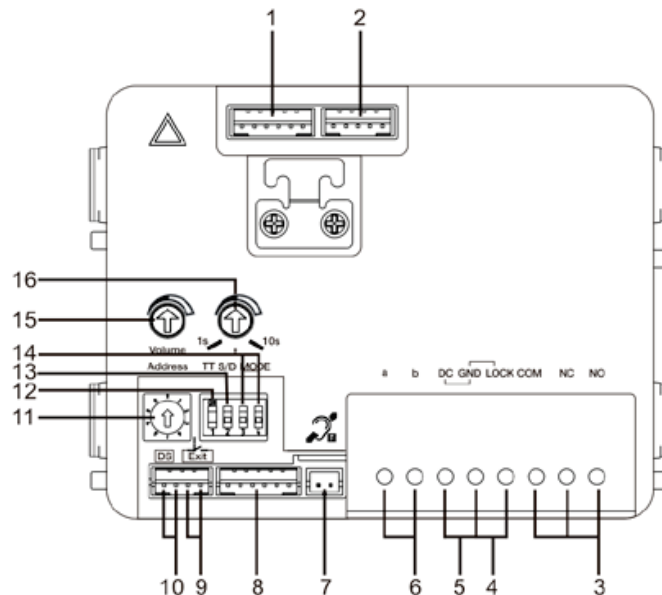

1. Camera module connection
2. The device's software update connector
3. Connectors (COM-NC-NO) for potential-free output, electronic lock (max. 30 VAC/DC 1 A), door opening with programmable button no. 1.
4. Connectors (LOCK-GND) for electronic lock (18 V 4 A impulse, 250 mA hold), opening the door with the  button.
5. Connectors (DC-GND) for auxiliary power supply
6. Connectors (a-b) for the bus connection
7. Induction loop connector
8. Connector for the next module
9. Connector for the exit button
10. Connector for the door status checking sensors
11. Rotary switch for setting the outdoor unit (1–9) address
12. Set the button feedback sounds: ON/OFF
13. Set the buttons in single or double column mode (ON = double column; OFF= single column)
14. Set the functions of the first and second button.
3-> OFF, 4-> OFF = call the indoor unit / call the indoor unit;
3-> ON, 4-> OFF = switch the lights on / call the indoor unit;
3-> OFF, 4-> ON = call the control unit / call the indoor unit;
3-> ON, 4-> ON = switch the lights on / call the control unit
15. Adjust the speaker volume
16. Adjust the lock opening time, 1–10 seconds (available with a lock connected through LOCK-GND)

Front

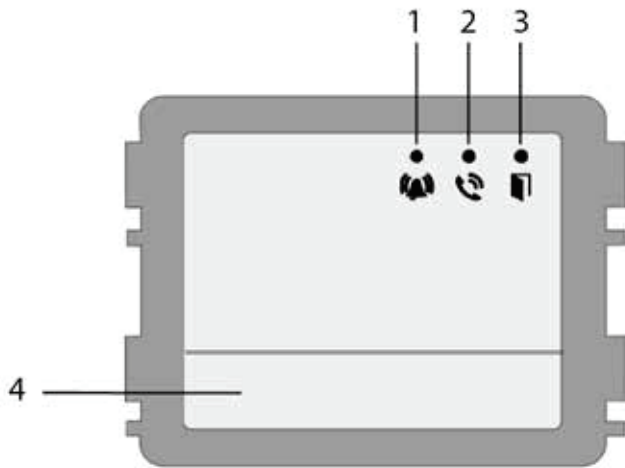

1. LED is blinking slowly, indicating a connected call. LED is blinking fast, indicating that the system is busy.
2. LED is lit, indicating a potential connection.
3. LED is on, indicating that the door lock has been released.
4. Dial button

M251021P3 and M251021P4 3/6 and 4/8 button module

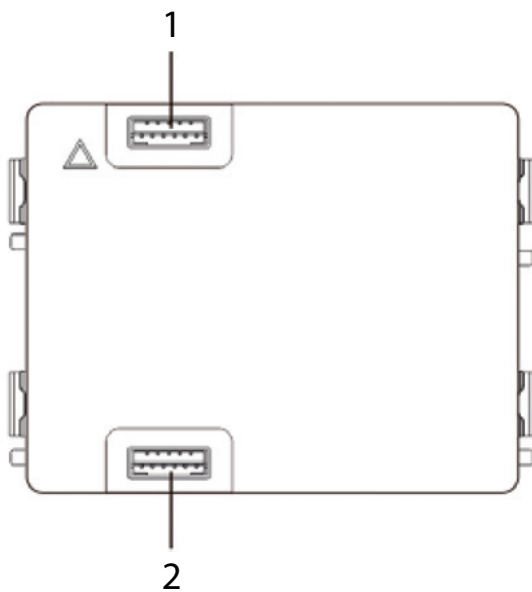

1. Connector for the previous module
2. Connector for the next module

M251021K-A Keyboard module

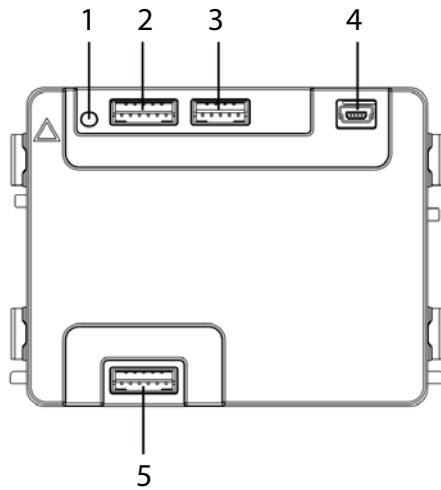

1. Programming button
2. Connector for the previous module
3. The device's software update connector
4. USB connector for connecting to a computer: load/read a file
5. Connector for the next module

M251021C Camera module

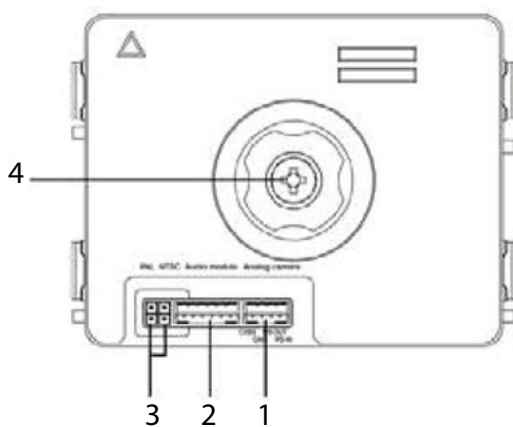

1. Connector for an additional analog camera
2. Audio module connector
3. Jumper switch for setting the video format: PAL/NTSC
4. Adjust the display area of the camera $\pm 15^\circ$ in the horizontal/vertical direction

M251021CR

Display module with ID card reader

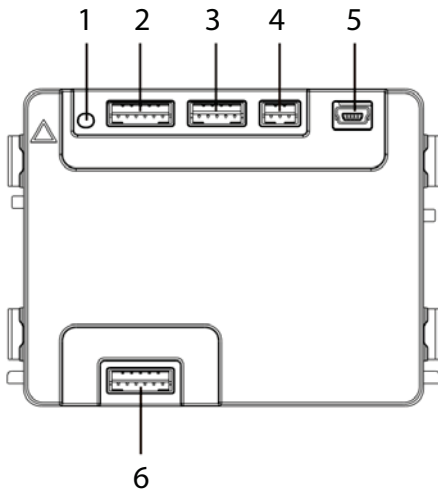

1. Programming button
2. Connector for the previous module
3. The device's software update connector
4. Connector for connecting the Wiegand access control system
5. USB connector for connecting to a computer: load/read a file
6. Connector for the next module

51021DN

Nameplate module

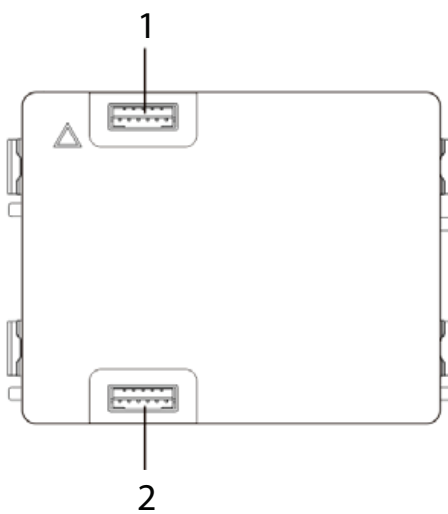

1. Connector for the previous module
2. Connector for the next module

M22003-W Audio handset

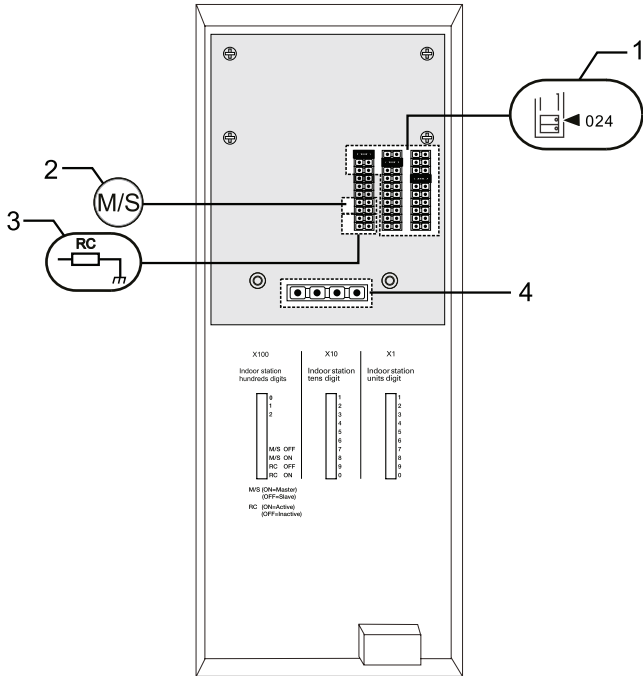

1. X100 X10 X1

Jumper switches for setting the indoor unit address, e.g. 024.

2. The master/slave function

Only one indoor unit at each address is a "master" (the jumper switch set to "M/S on").

3. Terminal resistor RC ON/OFF

For video and combined video/audio installations, the jumper switch must be set to "RC ON" in the last device on the line.

4. a b = Bus connectors

 = Doorbell connection

M22313-W Video display hands-free 4.3"

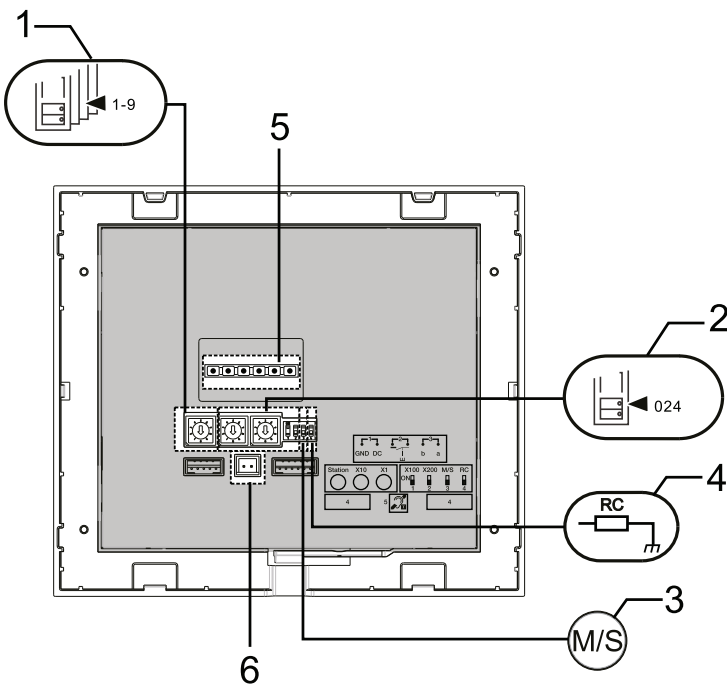

1. Station

Selector for setting the outdoor unit address

2. X10 X1

A rotary switch for setting the address (first and second digit) in the indoor unit

3. The master/slave function

Only one indoor unit at each address is a "master" (the dip switch must be set to "M/S on").

4. Terminal resistor RC ON/OFF

For video and combined video/audio installations, the dip switch must be set to "RC ON" in the last device on the line.

5. a b = Bus connectors

 = Doorbell connection

DC GND = Auxiliary power source connection

6. Induction loop connector

M2303 Guard unit 4.3"

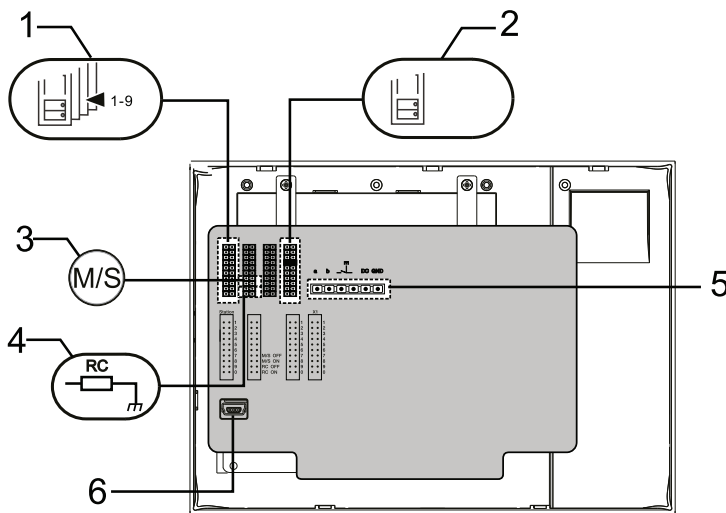

1. Station

The jumper switch is used to set the address of the primary outdoor unit.

2. X1

The jumper switch is used to set the address of the guard unit.

3. The master/slave function

Only one guard unit in each building must be set to the Master state (the jumper switch set to "M/S on").

4. Terminal resistor RC ON/OFF

For video or video/audio installations, "RC" must be "ON" in the last unit of each line.

5. a b = Bus connectors

 = Doorbell connection

 = Auxiliary power source connection

6. USB connection

For connecting to a computer: load/read a file

M2300 Central unit

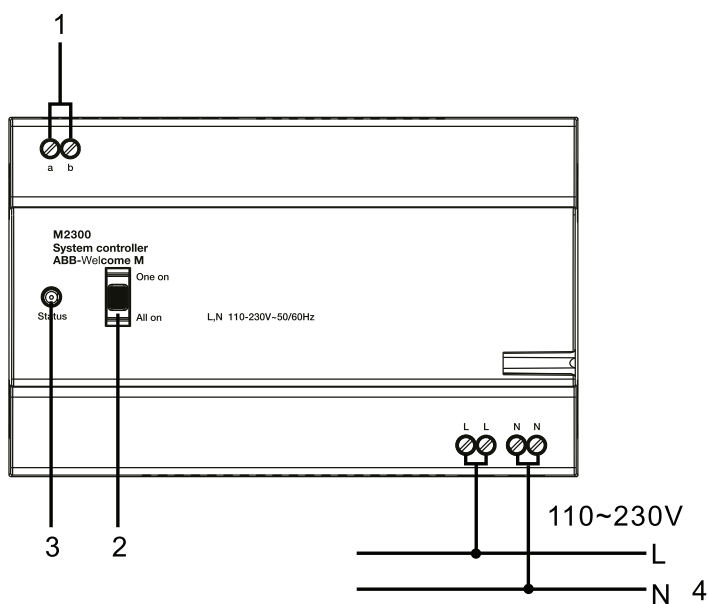



1. Bus

2. Selection of operating mode:

One on = the master device alarms

All on = master and slave devices alarm

3. Status indicator LED

 Ready to operate  Bus activity  Fault

4. Mains voltage

M2301

Mini-sized central unit

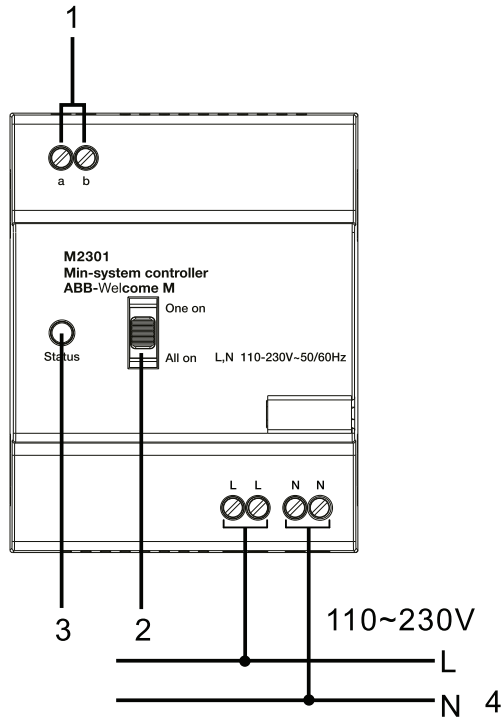

1. Bus

2. Selection of operating mode:

One on = the master device alarms

All on = master and slave devices alarm

3. Status indicator LED



Ready to operate



Bus activity



Fault

4. Mains voltage

83342-500

IP-Gateway

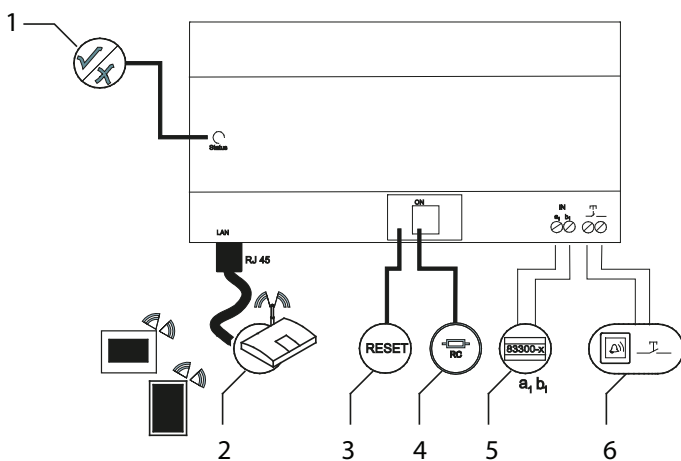

1. Status indicator LED



Ready to operate



Bus activity



Fault

2. LAN connection

3. Reset button

4. Terminal resistor RC ON/OFF

5. System center / internal bus

6. Doorbell button

M2305 Relay

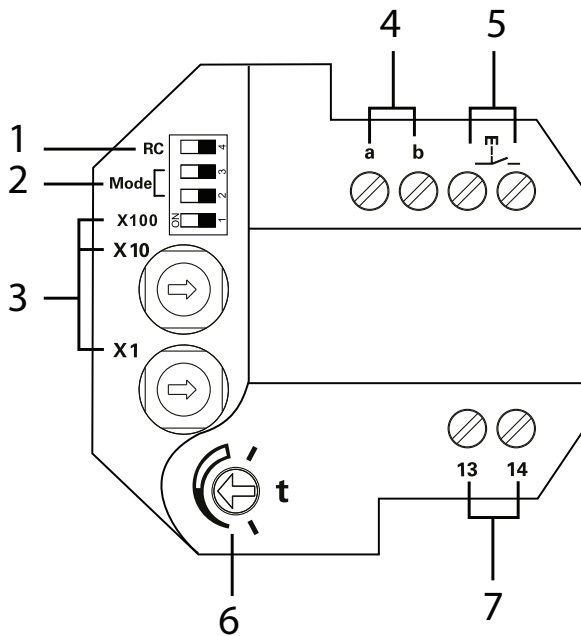

1. Terminal resistor RC ON/OFF

For video and combined video/audio installations, the dip switch must be set to "RC ON" in the last device on the line.

2. Selection of operating mode:

- **Call repeat:** 2->OFF, 3->OFF
- **Door opening button:** 2->OFF, 3->ON
- **Time-delay relay:** 2->ON, 3->OFF

3. Rotary switches for setting the address

4. Bus in/out

5. Screw terminals

For the exit button or an additional doorbell

6. Adjustment of the delay of the relay

7. Potential-free output for a door opening mechanism or a light

M2302 Line coupler

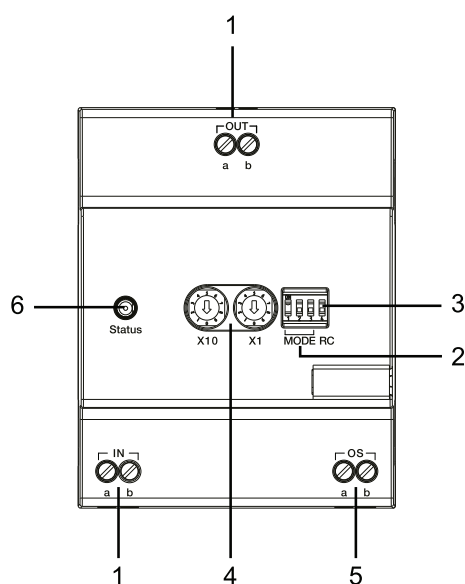

1. Bus in/out

2. Operating settings

3. Terminal resistor RC ON/OFF

For video and combined video/audio installations, the terminal resistor of the last device of each branch must be set on ("RC ON").

4. Rotary switches for setting the address

5. Screw terminals for the outdoor unit

Or, bus input when used as a line amplifier

6. Status indicator LED

 Ready to operate
  Bus activity
  Fault

M2304 Indoor video distributor

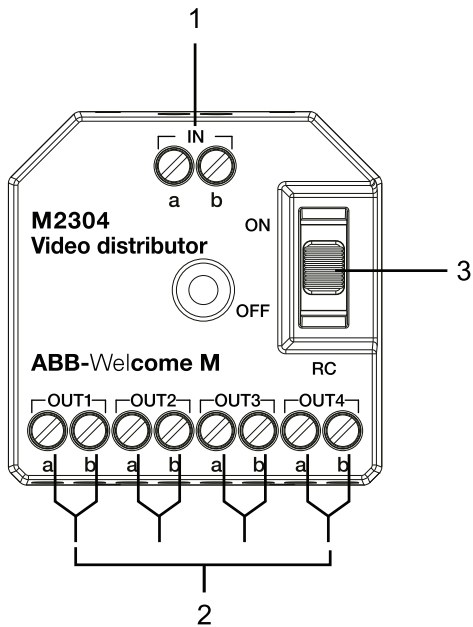

1. Bus

2. Four outputs

3. Terminal resistor RC ON/OFF

For video or video/audio installations, "RC" must be "ON" in the last unit of each line.

83325/2-500 Video distributor for outdoor units

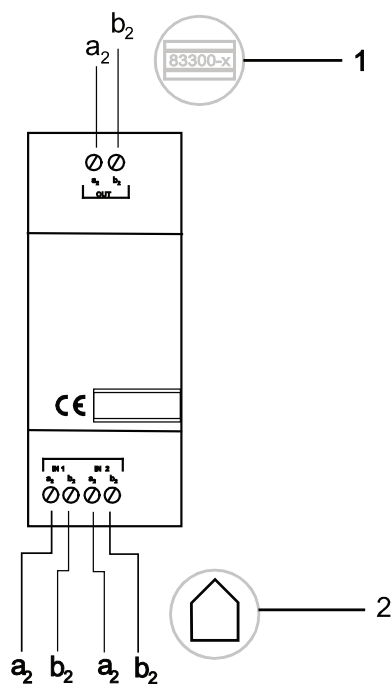

1. Bus towards the central unit

2. Buses towards the outdoor units

Commissioning and settings

System settings

First, change the system code for a new one:



Door opening code



RFID tag

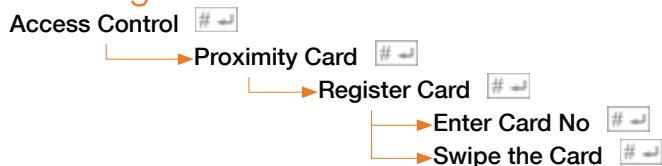

Residents' names

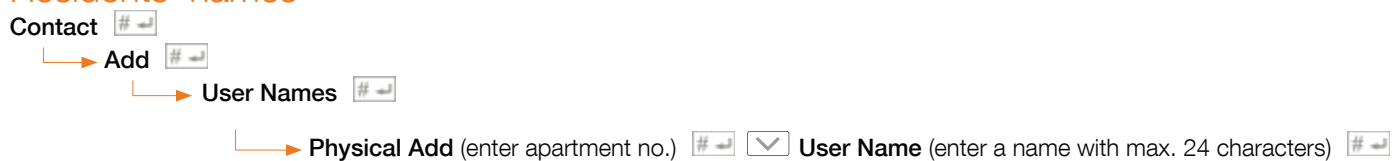

Date and time



Language

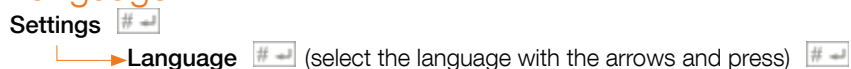

Welcome message

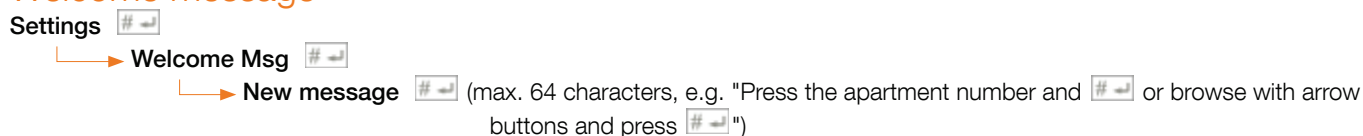

Door opening time

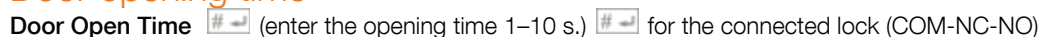

Glossary

Access Control	= Access control
Door OpenCode	= Door opening code
Modify	= Modify
New Password	= New password
Re-Enter	= Re-Enter
Proximity Card	= Access card
Register Card	= Register
Enter Card No	= Card number
Swipe the Card	= Swipe the card
Contact	= Contact
Add	= Add
Physical Add	= Number address
User Name	= User name
Settings	= Settings
Date&Time	= Date and time
Language	= Language
Welcome Msg	= Welcome message
New Message	= New message
Choose Door	= Choose door
Door Open Time	= Opening time

Commissioning and settings

Outdoor unit



Calling the apartment:

You can make a call by dialing the number of the apartment.
To cancel the call, use the  button.

Alternatively, you can select the apartment from the menu using the up and down menu buttons and pressing the Handset button. The display shows the apartment number or the resident's name, if defined for the display.

The outdoor unit provides audio guidance.

After your call has been answered, you can talk to the person in the apartment. If there is an indoor unit with a display inside the house, the image from the outside is also shown in the apartment.

Opening the door with a : _ _ _ _ _ 



The signal lights indicate the status:



Blinking slowly: Call in progress



Blinking rapidly: The system is busy



On: Voice connection to the apartment open



On: The front door is open

Commissioning and settings

Audio handset



1. Audio handset

Pick up the handset and answer the call. End the call by replacing the handset.

2. Opening the electronic lock on the front door

Opens the door for the specified time. The button can also include other functions. See the detailed instructions.

3. Programmable buttons 1 and 2

Enable additional functionality. See the detailed instructions. Can be programmed to open the door, another door, switch on a light, etc.

4. Volume (at the side)

Normal, low and silent.

5. Red signal light (LED)

 Blinking rapidly: The door is open for longer than usual if the door switch has been installed

 Blinking slowly: Any button has been pressed.

 On: The ring tone is silent.

6. Blue signal light (LED)

 Blinking rapidly: The system is busy

 Blinking slowly: Incoming call

7. Induction loop

Amplifies the handset volume if a hearing aid is being used.

Commissioning and settings

4.3" display



Menu/settings: if necessary, see the detailed instructions.

- 1: Intercom settings
- 2: Relay control (additional function)
- 3: Programmable button, intercom
- 4: Call forwarding
- 5: Automatic door opening
- 6: Set door opening code
- 7: Select ring tone
- 8: Ring tone volume
- 9: Date and time
- 10: Automatic full screen mode
- 11: Intercom blocking list
- 12: Event log
- 13: Language settings
- 14: Information
- 15: Reset factory settings

1. **Display 4,3" hands-free**
2. **Answer and make a call**
3. **Open the door**
Opens the door for the specified time.
4. **Make a call to the front door**
 - During the call, it is possible to take a picture of the situation by pressing the button down for a longer period.
 - Blinking: An unanswered call has been received. A picture of the caller and the time of the call have been stored.
5. **Mute**
 - Mute incoming calls.
 - Reject an incoming call by pressing this button.
 - Mute the microphone during a call with this button.
 - The light is lit when the function is on.
6. **Programmable button**
 - See the detailed instructions.
 - Can be programmed to open another door, switch on a light, call a security guard, etc.
7. **Menu/settings**
Use with the buttons indicated on the display.
8. **Induction loop**
Amplifies the speaker volume if a hearing aid is being used.

Commissioning and settings

Control unit



Menu/settings and additional functionality: see the detailed instructions in the unit's own manual.

1. Display 4.3"

2. Open the door

Opens the door for the specified time.

3. Make a call to the front door

During the call, it is possible to take a picture of the situation by pressing the button longer.

Blinking: An unanswered call has been received. A picture of the caller and the time of the call have been stored.

4. Mute

- Mute incoming calls.
- Reject an incoming call by pressing this button.
- Mute the microphone during a call with this button.
- The light is lit when the function is on.

5. Programmable button 1

Enable additional functionality. See the detailed instructions.

6. Programmable button 2

Enable additional functionality. See the detailed instructions.

7. Menu/settings

Navigate in the menu using the buttons indicated on the display.

8. Audio handset

Dimensions

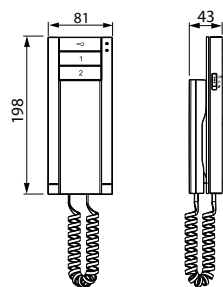

M22003-W

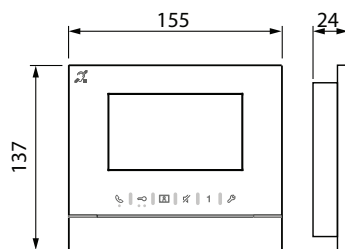

M22313-W

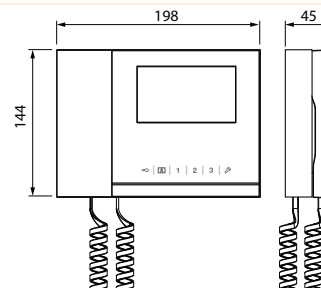

M2303

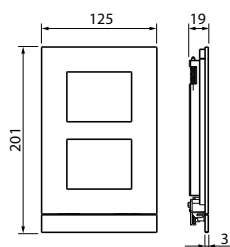

51022CF-A

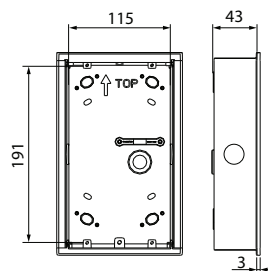

41022F

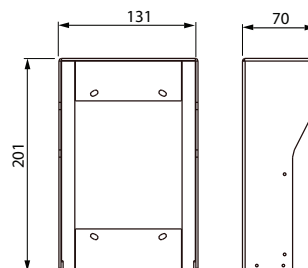

51022RH

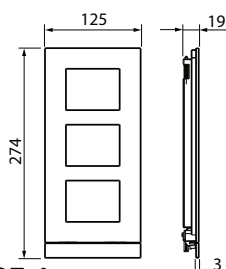

51023CF-A

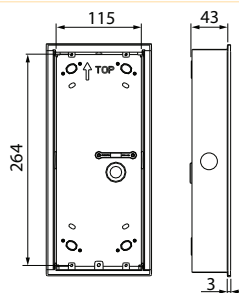

41023F

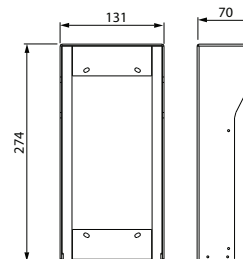

51023RH

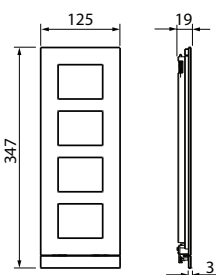

51024CF-A

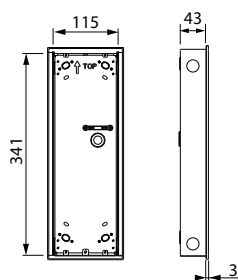

41024F

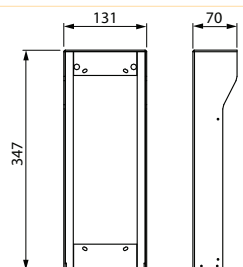

51024RH

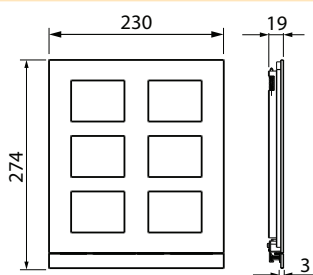

51025CF-A

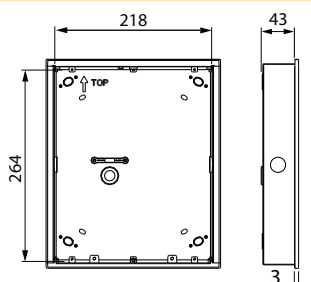

41025F

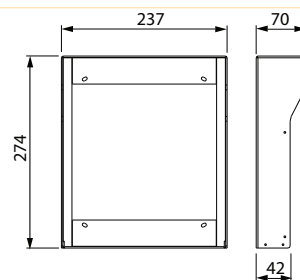

51025RH

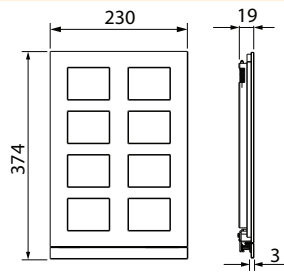

51026CF-A

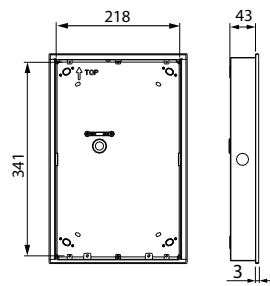

41026F

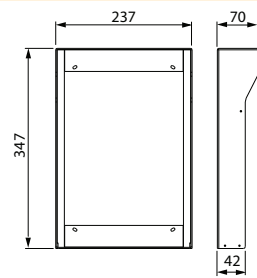

51026RH

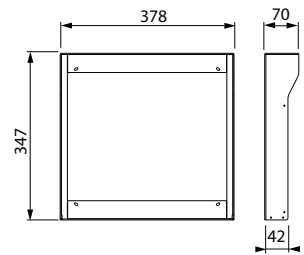

51027RH

Notes

A series of horizontal dotted lines for taking notes.

Contact information

ABB Oy

P.O. Box 16 (Porvoon Sisäkehä 2)

FI-06101 Porvoo, Finland

Tel. +358 10 22 11

www.installationmaterials.com

