USER GUIDE

MAN0152 rev 9

ABB FusionAir Smart Sensor Application Guide



Style conventions used in this document:

UI Text: Text that represents elements of the UI such as button names, menu options etc. is presented with a grey background and border, in Tahoma font which is traditionally used in Windows UIs. For example:

Ok

Standard Terms (Jargon): Text that is not English Language but instead refers to industry standard concepts such as Strategy, BACnet, or Analog Input is represents in slightly condensed font. For example:

BACnet

Code: Text that represents File paths, Code snippets or text file configuration settings is presented in fixed-width font, with a grey background and border. For example:

```
$config_file = c:\CYLON\settings\config.txt
```

Parameter values: Text that represents values to be entered into UI fields or displayed in dialogs is represented in fixed-width font with a shaded background. For example

10°C

Product Names: Text that represents a product name is represented in bold colored text. For example

INTEGRA™

Company Brand names: Brands that are not product names are represented by bold slightly compressed text:

ABB Active Energy

PC Keyboard keys: Text representing an instruction to press a particular key on the keyboard is enclosed in square brackets and in bold font. For example:

[Ctrl]+[1]

1	DESCRIPTION	
2	INSTALLATION AND OPERATION GUIDE	
	Mounting	5
	Installation	6
	Cleaning	7
	CO ₂ Sensor Auto-Calibration	7
	Addressing	7
	Wiring.....	8
	User Controls and display	11
	Temperature Setpoint Control	12
	Fan Speed Control	13
	Lighting Control	14
	Sunblind Control	14
3	USE CASES	
	Unoccupied Room	15
	Preparing indoor air quality for occupancy	16
	Room ready for Occupancy	16
	Maintaining Room Air Quality	17
4	APPLICATIONS	
	8.1.1.1 Single Setpoint Control.....	19
	8.1.1.2 Dual Setpoint Control.....	20
	8.1.1.3 Four Setpoint Control	21
	8.1.1.4 Humidify-Dehumidify.....	22
	8.1.1.5 Accent Lights	23
	8.1.1.6 Lighting Scene Control	24
	8.1.1.7 Light Control Sensor Override.....	25
	8.1.1.8 sunblind Control	26
	8.1.1.9 ECO Leaf	27
	8.1.2.0 CO ₂ and VOC Control.....	28
	8.1.2.1 3-Stage Fan Control.....	29
	8.1.2.2 Analog Fan Control.....	30
	8.1.2.3 Digital Dry Contacts	31
	8.1.2.4 Side Button	32
	8.2.1.1 Sample Strategy	33
	Heating/cooling Setpoints	33
	CO ₂ Monitoring.....	33
	Humidity Monitoring.....	33
	Fan Command	34
	ECO Leaf	34
	Lighting Control	34
	sunblind Control.....	34

ABB FusionAir Smart Sensor | Description

1 Description

The ABB FusionAir Smart Sensor series provides a slim, compact, and visually appealing room control display with a high-definition capacitive touch backlit LCD display for use with ABB's Cylon® FLXeon and CB Line BACnet® field controllers. The intelligent temperature and humidity sensor allow users to view and adjust selected parameters within the field controller to which it is connected. Other sensing options available for integration with the CXpro^{HD} control Strategy are CO₂ or Volatile Organic Compound (VOC) sensing, 2 digital inputs for the addition of inputs such as remote Passive Infra-Red (PIR) occupancy detection, room occupancy key card or separate light switch.

This document describes installing and operating the device. Programming and Configuration is dealt with in *MAN0139 CBV-2U4-3T and CBV-2U4-2T-N User Guide* and *MAN0148_FBi User Guide*.

2 Installation and Operation Guide

MOUNTING

- Install the ABB FusionAir Smart Sensor on an easily accessible interior wall, approximately 60" (1.5 m) above the floor in an area of average room temperature
- Avoid direct sunlight or other heat sources (e.g. the area above radiators or other heat-emitting equipment)
- Avoid locations behind doors, on outside walls and above or below air discharge grills and diffusers

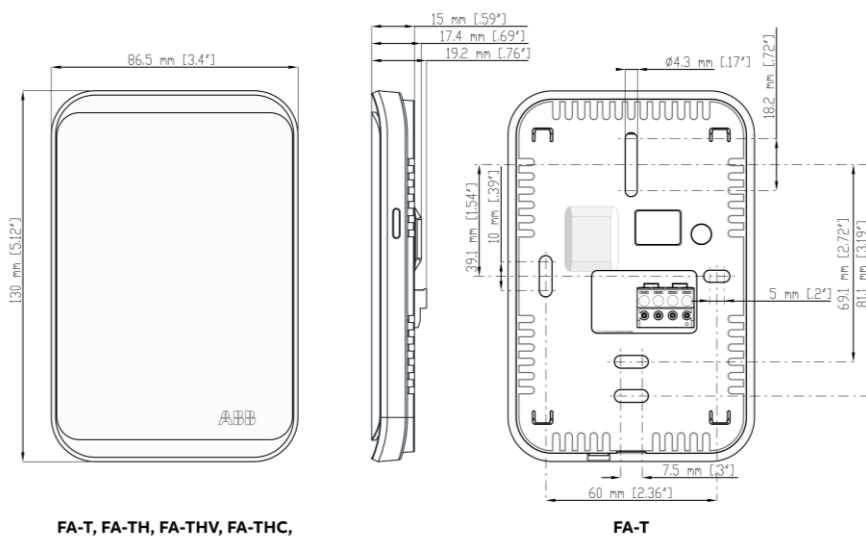
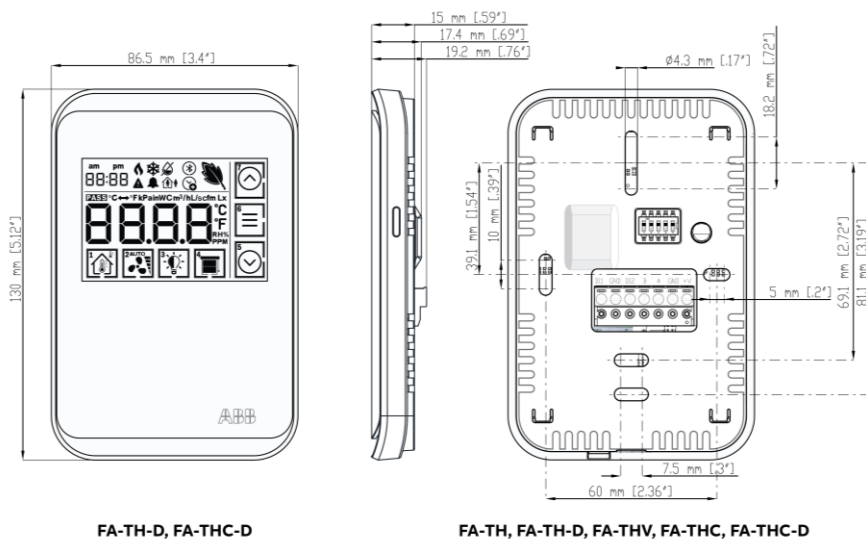

Note : The model number labels are located on the PCB assembly

INSTALLATION

1. Install a 4-core cable (24 AWG min. for a single FusionAir, 18 AWG min. for multi-device bus, max. bus length 328 ft. / 100 m) from the associated controller sensor bus and sensor power connections to a flush-mounting wall box compatible with the mounting plate.
2. Connect the 4-core cable to the field controller and to the terminals of the FusionAir device according to the wiring diagrams below. Set the address of the FusionAir device (see Addressing below).
3. Attach the mounting plate to the flush-mounting box. Make sure the mounting screw heads do not stand out more than 0.2" (5 mm) off the surface of the mounting plate.
4. Align the body of the FusionAir device with the clips on the mounting plate and press gently until the front panel of the device is fully connected.

IMPORTANT NOTICE AND SAFETY ADVICE

This device is for use as an operating control. It is NOT a safety device. Where a device failure endangers human life and/or property, it is the responsibility of the client, installer and system designer to add additional safety devices to prevent a system failure caused by such a device failure.

Ignoring specifications and local regulations may cause equipment damage and endangers life and property. Tampering with the device or misapplication will void warranty.

FCCID: 2A2UMFA2101

IC: 27950-FA2101

Note : The approvals number label is located on the inside of the back cover

This device complies with part 15 of the FCC Rules. Operation is subject to the following two conditions:

- (1) This device may not cause harmful interference, and
- (2) this device must accept any interference received, including interference that may cause undesired operation.

WARNING: Changes or modifications not expressly approved by the party responsible for compliance could void the user's authority to operate the equipment.

This device contains licence-exempt transmitter(s)/receiver(s) that comply with **Innovation, Science and Economic Development Canada's** licence-exempt RSS(s). Operation is subject to the following two conditions:

- (1) This device may not cause interference.
- (2) This device must accept any interference, including interference that may cause undesired operation of the device.

L'émetteur/récepteur exempt de licence contenu dans le présent appareil est conforme aux **CNR d'Innovation, Sciences et Développement économique Canada** applicables aux appareils radio exempts de licence.

L'exploitation est autorisée aux deux conditions suivantes :

- (1) L'appareil ne doit pas produire de brouillage;
- (2) L'appareil doit accepter tout brouillage radioélectrique subi, même si le brouillage est susceptible d'en compromettre le fonctionnement.

Radiation Exposure Statement:

This equipment complies with FCC/ ISED radiation exposure limits set forth for an uncontrolled environment. This equipment should be installed and operated with greater than 20cm between the radiator & your body.

Déclaration d'exposition aux radiations:

Cet équipement est conforme aux limites d'exposition aux rayonnements ISED établies pour un environnement non contrôlé. Cet équipement doit être installé et utilisé à plus de 20 cm entre le radiateur et votre corps.

CLEANING

Whenever cleaning the FusionAir device, remember to take account of the following:

- Clean screen surface with a clean damp microfiber cloth (lukewarm water and a mild soap/detergent)
- Dry with a clean soft cloth to prevent water spotting and streaks from forming
- Do not spray the product or use chemical cleaning agents, thinners, benzene or acetone

CO₂ SENSOR AUTO-CALIBRATION

CO₂ sensors use an automatic calibration algorithm to give consistency between sensors.

The FusionAir CO₂ sensor is factory-calibrated for initial operation. The algorithm becomes active after 24 hours of continuous operation, and continues to maintain accuracy as long as the sensor is periodically exposed to the reference background CO₂ level (which is around 400 ppm); generally this is achieved by a room being unoccupied overnight. This should happen at least four times in 21 days.

ADDRESSING

Multiple FusionAir device can be connected to a single sensor control bus. Each connected device must be assigned a unique address. This is set using the DIP switch on the back of the device

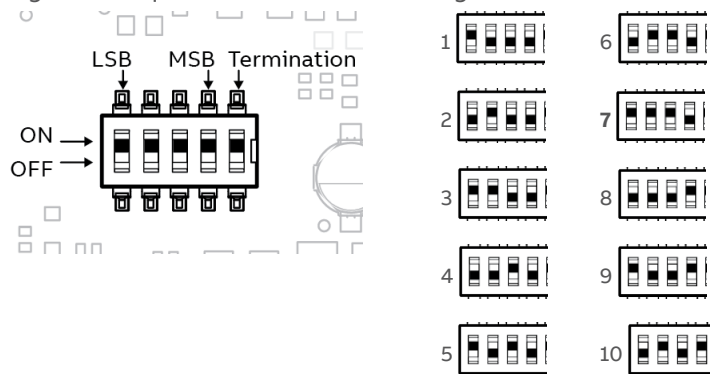

The address must be between 1 and the maximum number of FusionAir devices supported by the controller to which it is connected:

Controller	Maximum number of FusionAir Sensors that can be connected to the Sensor Bus
FBXi Series	10
CBXi Series	10
CBX Series	4
FBVi-2U4-4T	10
CBV-2U4-3T(-N)	4
CBT-4T4-2U1R	4
CBT-3T6-5R	4
CBT-4T4-4T	0

See the controller datasheet for more information.

The address must be within the controller's range, but gaps in the addressing of multiple devices are allowed.

Note: The FusionAir device reads the dip switch settings when power is applied. Changing the DIP will not take effect during operation. The device must be disconnected and re-connected for this change to be effective.

WIRING

Terminal block pinout:

FA-TH, FA-THV, FA-THC, FA-THD, FA-THVD, FA-THCD

Digital Inputs | RS485 | 24 V DC

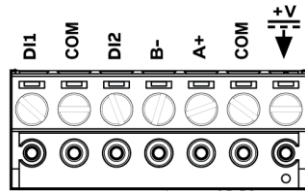

FA-T only

Push Switch | 10K3A1

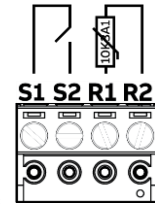

Single FusionAir per controller

Connect terminals 1...4 to the Sensor port on the CBX / CBXi / FLXeon controller.

Optionally connect terminals 5...7 to external digital signals such as Occupancy or Room Key Card.

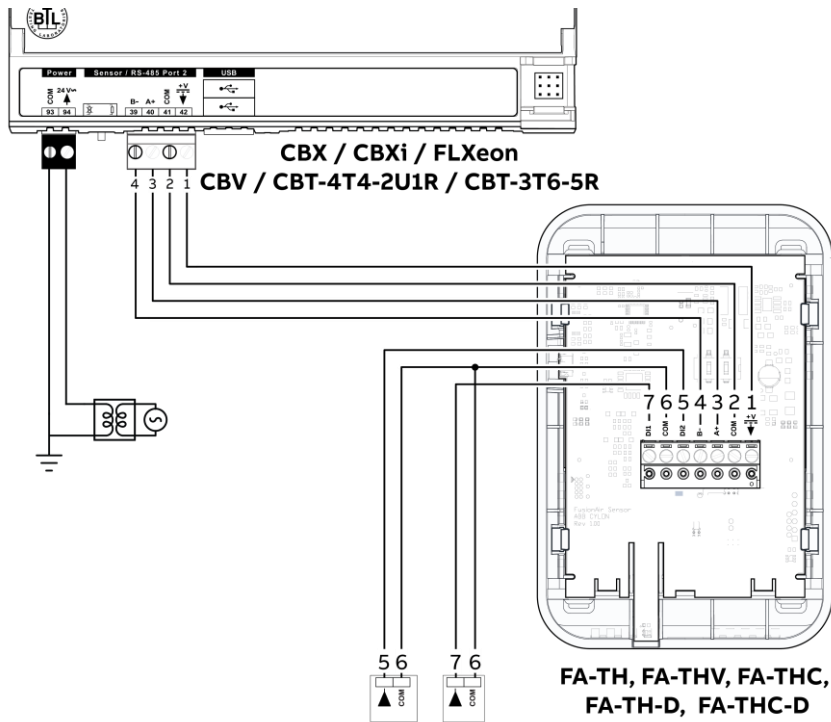

Multiple FusionAir per controller

Daisy-chain terminals 1...4 as shown below.

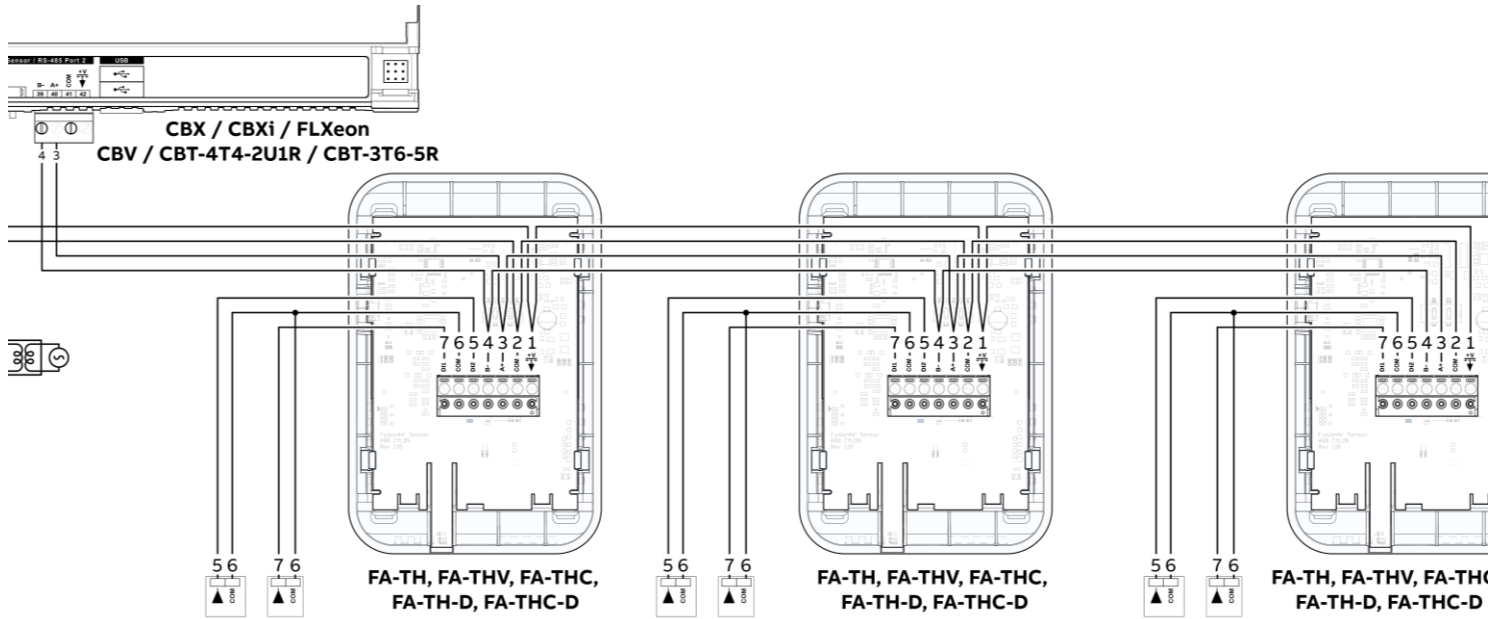

Note: To allow for potential current requirements for multiple sensors when accent lights are used, it is recommended that the power lines (terminals 1 and 2) are connected to the Controller's 24 V power supply whenever multiple FusionAir devices are on a single RS-485 bus.

Power Considerations for FusionAir with Older controllers

The CBXi range of controllers was updated with increased power on the Sensor bus. The CBX range did not receive this upgrade. As a result, CBX and some older CBXi, FBXi and FBVi controllers do not supply sufficient power on their sensor port for a FusionAir Sensor using its LED accent lights at full power. It is recommended that in these cases the FusionAir devices are connected to an external power source as described in *Multiple FusionAir per controller* above.

The Sensor port on following controllers can supply power for a single FusionAir device with full accent lights:

- CBT-4T4-2U1R
- CBT-3T6-5R
- CBV-2U4-3T
- CBXi-8R8 and CBXi-8R8-H from serial number **CBXixxxxxG** onwards
- FBXi-X256 from serial number **FBXixxxxxG** onwards
- FBVi-2U4-4T from serial number **FBVixxxxxD** onwards

For the following controllers however, the power line for the sensors should be taken from an external 24 V source:

- CBX-8R8 and CBX-8R8-H
- CBXi-8R8 and CBXi-8R8-H serial number **CBXixxxxxF** or earlier
- FBXi-X256 serial number **FBXixxxxxF** or earlier
- FBVi-2U4-4T serial number **FBVixxxxxD** or earlier.

FA-T (Passive sensor)

The passive variant of FusionAir, **FA-T** does not connect to the sensor bus, and so does not use the FusionAir module in **CXpro^{HD}**. Instead, the **FA-T**'s 10K3A1 temperature sensor and side switch can be connected directly to 4 terminals on the Controller as shown below, one analog input and one digital input.

The digital input is a push-button on the side of the **FusionAir** device, and can be used for example to over-ride a schedule for 1hr or override until next value change.

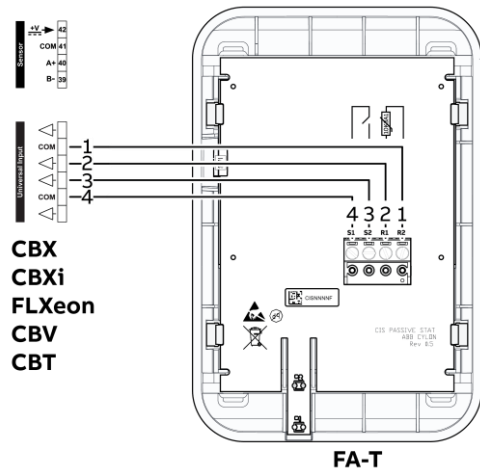

Alternatively they can be connected to a single analog input as shown below. Logic in the Controller Strategy can be used to detect when the switch is pressed (contact closed).

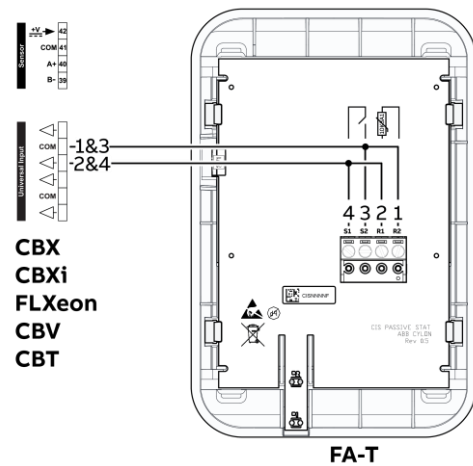

USER CONTROLS AND DISPLAY

The ABB FusionAir Smart Sensor has a high-definition capacitive touch LCD display LCD with Variable Backlight. There are a number of fixed symbols and four 7-segment characters as shown below:

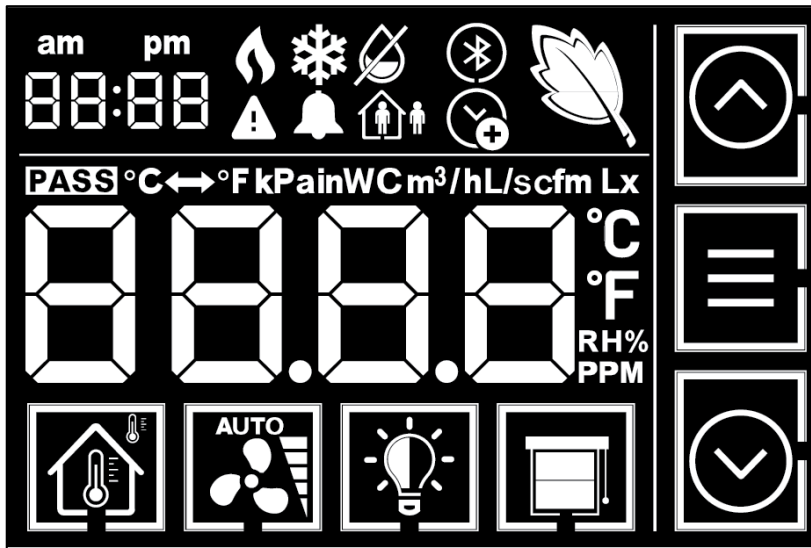

On the right-hand side and bottom of the FusionAir display there are 7 Capacitive touch regions, used as buttons to select functions and adjust setpoints as illustrated in the following sections.

Note: A version of each FusionAir variant is available *without* an LCD display for using in areas where local adjustment is not required, for example public places such as schools. They can also be used as secondary interfaces such as outside an office to indicate whether or not it is safe to enter. Status and Setpoint adjustment for these FusionAir variants can be undertaken through a Bluetooth phone app interface.





There is a physical push-button on the right-hand edge of the FusionAir Smart Sensor. This can be configured (in the CXpro^{HD} strategy) for any purpose such as the override of a setpoint for a period of time, or to step through lighting scenes.





← Physical push-button

TEMPERATURE SETPOINT CONTROL

If the Controller Strategy has been configured to permit it, the user can adjust the temperature setpoint or occupancy status. To use **Setpoint Mode**:

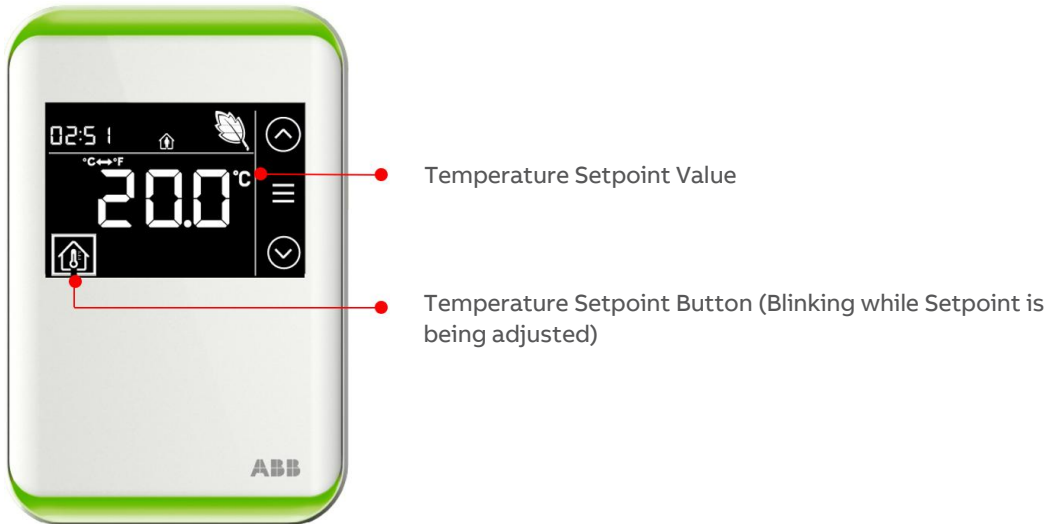
- Press the temperature button  to display the active setpoint (this will also wake the screen, if necessary)
- Press the up button  or down button  to adjust the setpoint value by the span defined in the Controller configuration until the desired temperature setpoint is displayed





Note: In Temperature Setpoint mode, pressing the menu button  between the up and down buttons changes the display units (°C to °F or °F to °C).

Changing the units in this way does not affect the values used in the Controller Strategy. Values are converted locally in the FusionAir device for display only.

FAN SPEED CONTROL

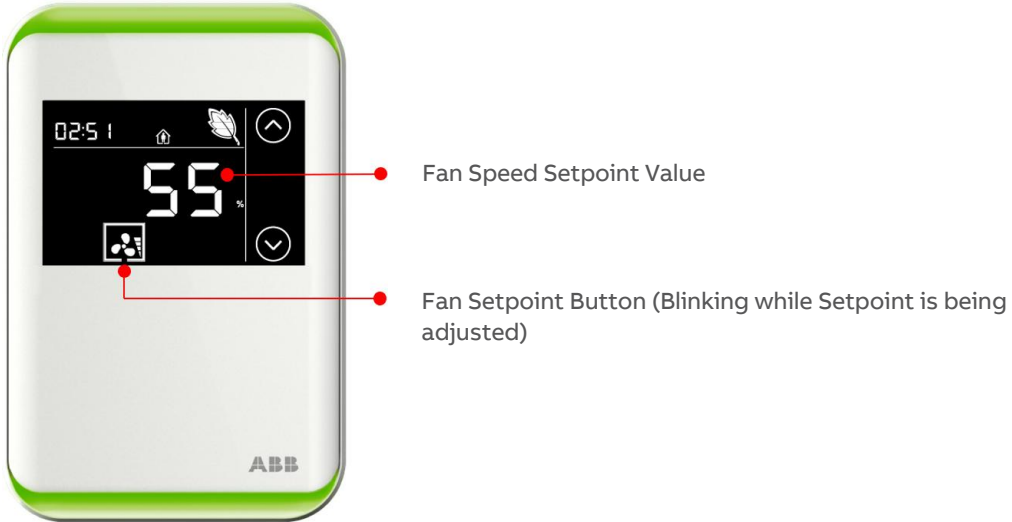

If the Controller Strategy has been configured to permit it, the user can adjust the fan speed. To use Fan Mode :

- Press the fan button  to display the current fan speed setpoint (this will also wake the screen, if necessary)
- Pressing the fan button additional times offers options for the fan speed to be 0% or 100% as well as automatic control or full manual control
- When manual control is active the up and down buttons   will appear allowing precise fan speed control



LIGHTING CONTROL

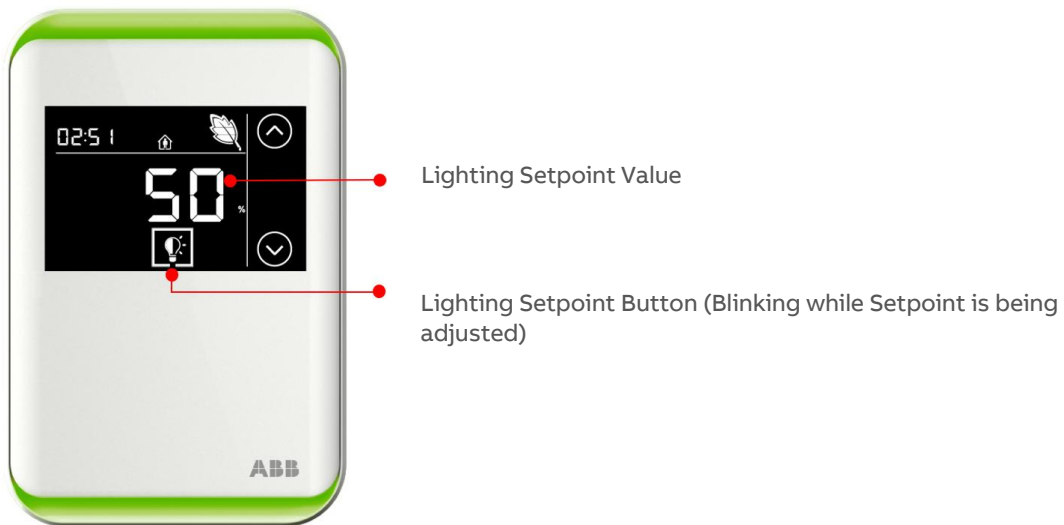

If the Controller Strategy has been configured to permit it, the user can adjust lighting levels through the connected Controller (FusionAir does not communicate directly with KNX). To use **Lighting Mode** :

- Press the lighting button  to display the current lighting setpoint (this will also wake the screen, if necessary)
- Pressing the lighting button additional times offers options for the lighting setpoint to be 0% or 100% as well as full manual control or, if configured in the Strategy, automatic control through a lux sensor connected directly to the Controller.
- When manual control is active the up and down buttons   will appear allowing precise lighting control



SUNBLIND CONTROL

If the Controller Strategy has been configured to permit it, the user can adjust window sunblinds through the connected Controller (FusionAir does not communicate directly with KNX). To use **Sunblind Mode** :

- Press the sunblind button  to display the current sunblind position setpoint (this will also wake the screen, if necessary)
- Pressing the sunblind button additional times offers options for the sunblinds to be completely closed or completely open as well as fully automatic control or manual control
- When manual control is active the up and down buttons   will appear allowing precise overrides

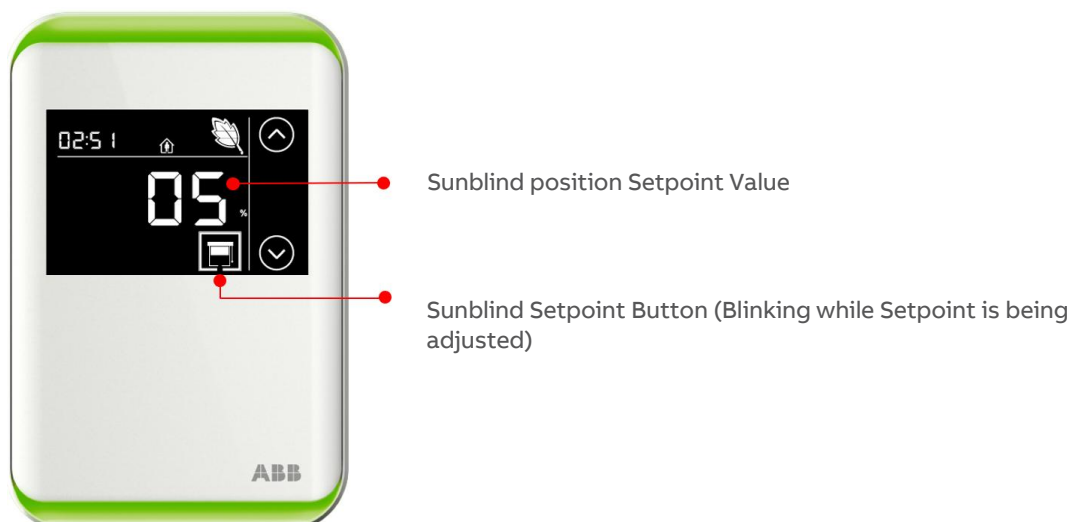

3 Use Cases

The ABB FusionAir Smart Sensor can be configured to operate in any way required by the Strategy in the controller to which it is connected.

The following sections illustrate one suggested use case in order to show the features of the FusionAir device. The accent colors have no predefined meaning and are fully customizable within the Controller Strategy, but in these examples the colors Red, Blue and Green are used as:

- Red: Warning; Room environment is outside the defined 'safe use' parameters
- Blue: System responding to bring the room within defined parameters
- Green: Room within defined 'safe use' parameters

The example use case is an office with Temperature control and occupancy input, with the FusionAir CO₂ sensing option used to determine Air Quality status. The FusionAir device is located inside the room, and the Accent lights enable the room status to be detected visually. The room status could be represented outside the room using a secondary FusionAir Smart Sensor located outside the room, for example a non-display variant.

It is possible also to access the FusionAir display through Bluetooth using a dedicated phone app so that the room status can be determined remotely, and the room settings changed without touching the device, or even entering the room.

UNOCCUPIED ROOM

If the room was unoccupied, the Controller Strategy could be configured so that the sensor indicates (for example) the following:

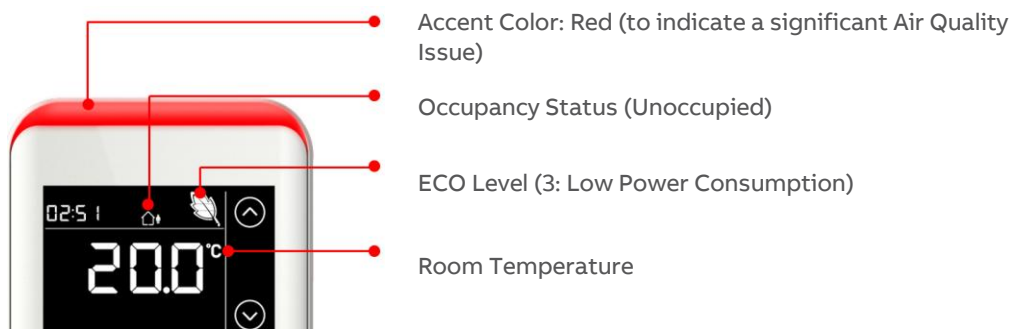

PREPARING INDOOR AIR QUALITY FOR OCCUPANCY

The Controller Strategy might be configured so that if occupancy was expected (e.g. by a schedule) the room control system could act to prepare the room for occupancy and the sensor could indicate (for example) the following:

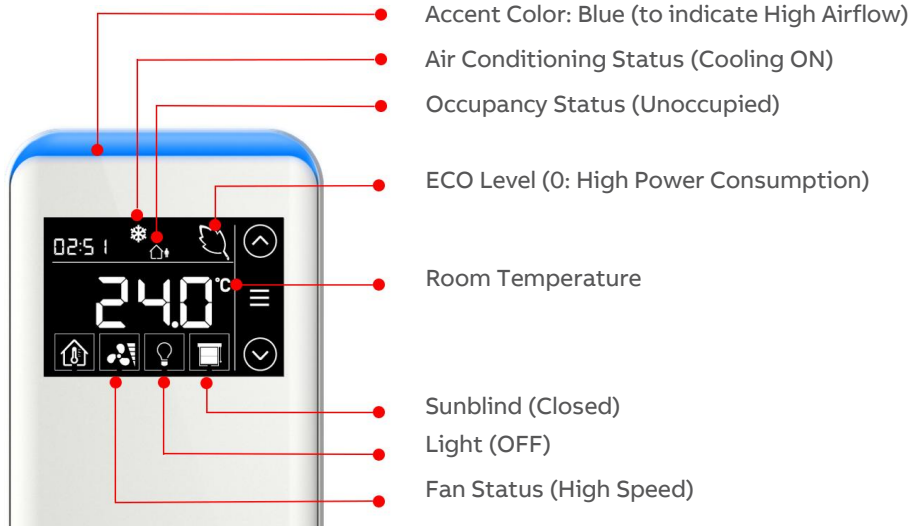

ROOM READY FOR OCCUPANCY

When the room air quality is acceptable for occupancy (according to local health and safety policy) the Controller Strategy could be configured to display (for example) the following on the FusionAir device:

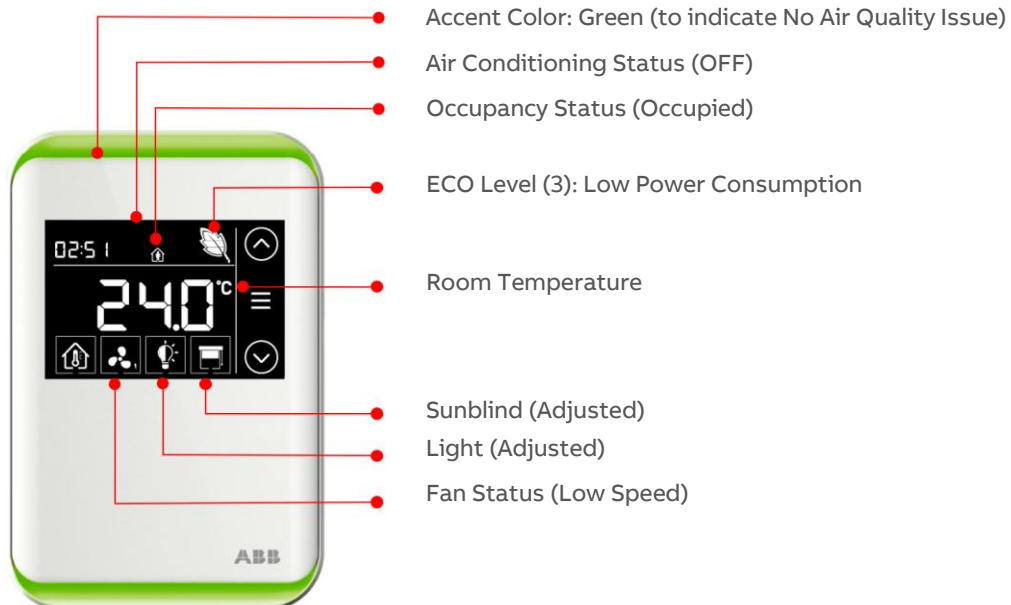

MAINTAINING ROOM AIR QUALITY

During occupancy it is possible that the air quality or other room conditions might go outside the levels required by the Controller Strategy. In such a case, the Strategy could act to restore the air quality, and display (for example) the following on the FusionAir device:

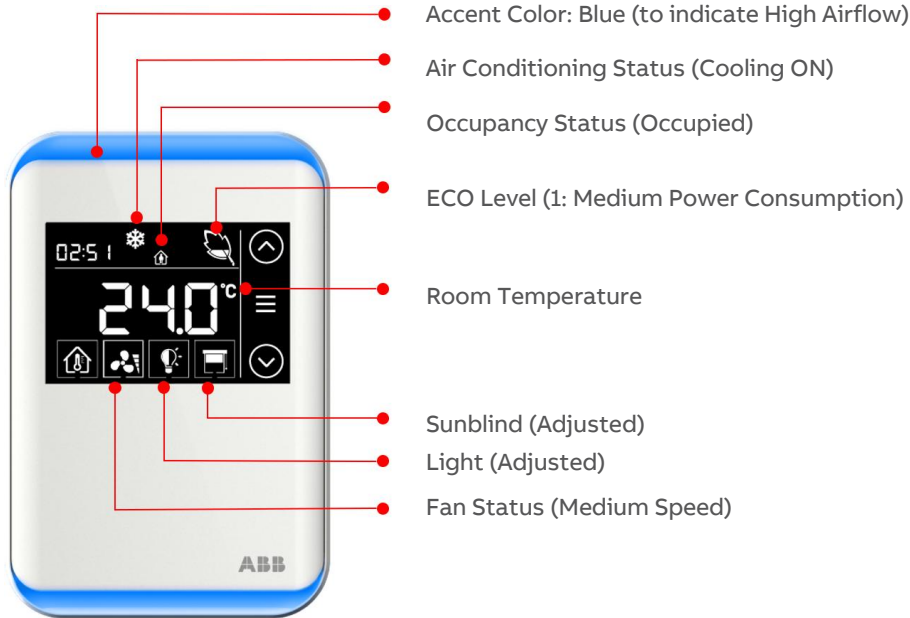

AIR QUALITY (CO₂ OR VOC)

FusionAir variants are available with either CO₂ or VOC sensor, which can provide reassurance to occupants that rooms have been ventilated and are ready with high air quality

Press the Menu button  to show the CO₂ or VOC reading. For example, the display could be configured to display as shown below:

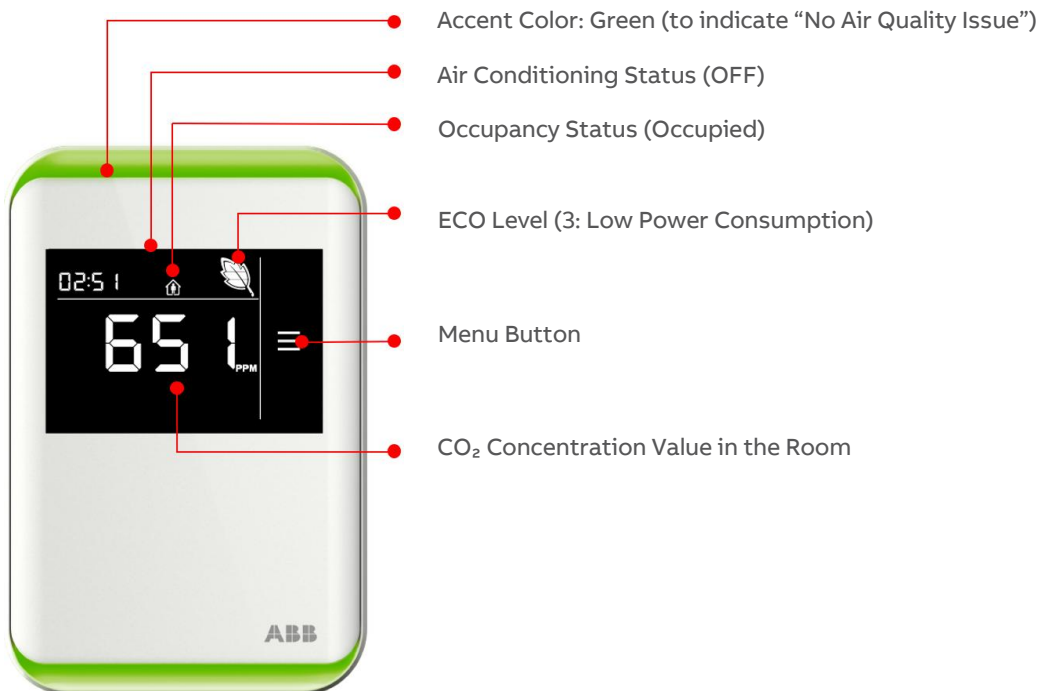

HUMIDITY

FusionAir variants are available with a Humidity sensor, to facilitate control of the room’s humidity to create a comfortable environment based on your use-case.

Press the Menu button  to show the Humidity reading. For example, the display could be configured to display as shown below:

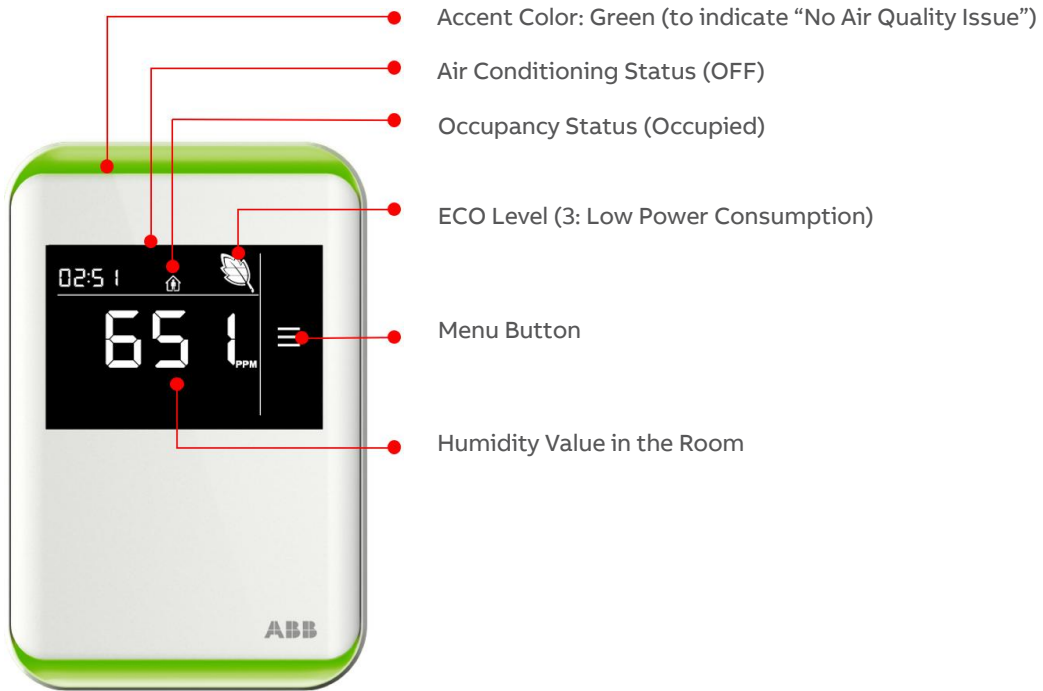

4 Applications

The following examples are available in the FusionAir section of the Sample Applications library in CXpro^{HD}. They illustrate different ways in which standard control sequences can be made compatible with FusionAir, and FusionAir-specific features can be implemented in the Strategy of any supported Controller.

- 008 - Fusion Sensor
- 8111 - Single Setpoint Zone Control
- 8112 - Dual Setpoint Zone Control
- 8113 - Four Setpoint Zone Control
- 8114 - Humidify-Dehumidify
- 8115 - Accent Lights
- 8116 - Lighting Scene Control
- 8117 - Light Control Sensor Ovr
- 8118 - Blind Control
- 8119 - ECO Leaf
- 8120 - CO2 Control
- 8121 - 3-Stage Fan Control
- 8122 - Analog Fan Control
- 8123 - Digital Dry Contacts
- 8124 - Side Button
- 8211 - Sample Strategy

8.1.1.1 SINGLE SETPOINT CONTROL

For basic temperature control applications, a single setpoint can be used to control a room with both heating and cooling capability. In CXpro^{HD} sample control Strategy 8.1.1.1,

- The heating and cooling setpoints are calculated by an offset, with the single setpoint used as the midpoint.
- The Fusion Sensor will display the calculated heating setpoint when in heating mode and show the calculated cooling setpoint when in cooling or vent mode.
- If the user overrides the setpoint at the sensor, the calculated setpoints will be incremented or decremented and the adjusted setpoint will be used for calculating heating and cooling capacity. The overridden setpoint will reset to the calculated setpoints after the Setpoint Override Duration time has expired.

Single Setpoint Example

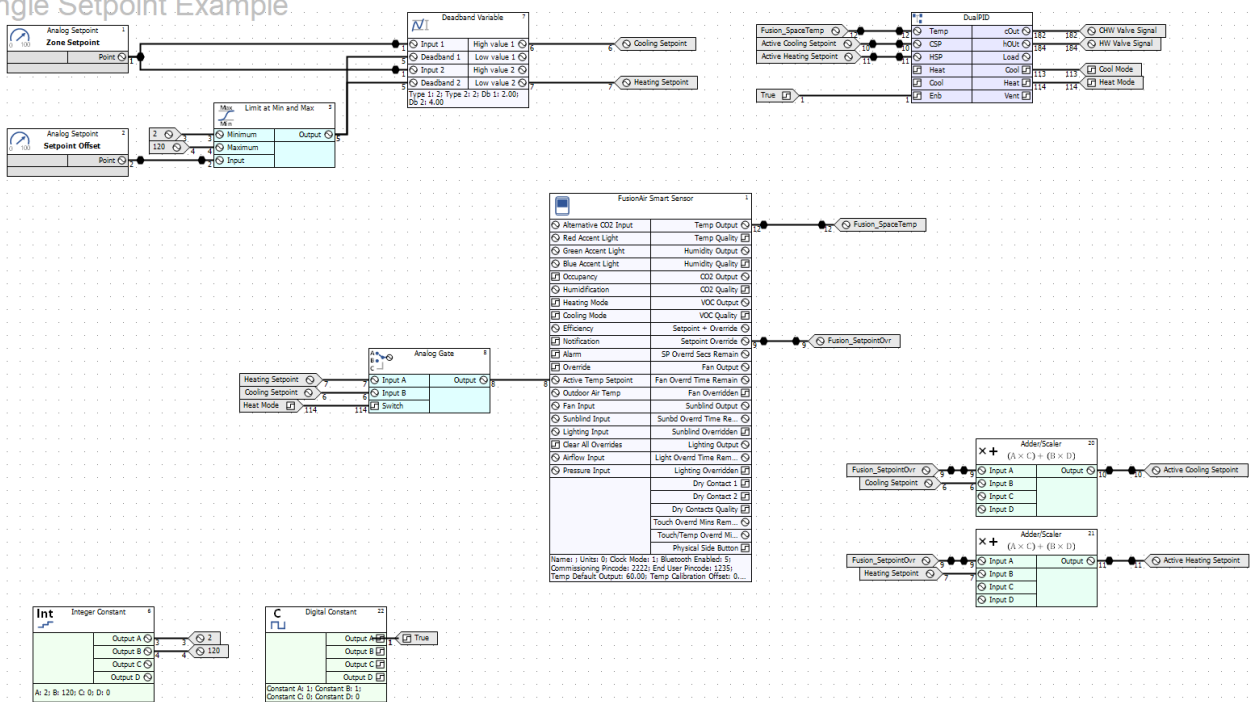

8.1.1.2 DUAL SETPOINT CONTROL

CXpro^{HD} sample control Strategy 8.1.1.2 shows dual setpoints being used to control a room with both heating and cooling capability. This is a useful application for heating / cooling control where occupancy isn't required.

- The heating and cooling setpoints are set separately. A macro prevents the heating setpoint going above the cooling setpoint, or the cooling setpoint going below the heating setpoint.
- The FusionAir Smart Sensor will display the calculated heating setpoint when in heating mode, and show the calculated cooling setpoint when in cooling or vent mode.
- If the user overrides the setpoint at the sensor, the heating and cooling setpoints will be incremented or decremented and the adjusted setpoint will be used for calculating heating and cooling capacity.
The overridden setpoint will reset to the heating and cooling setpoints after the Setpoint Override Duration time has expired.

Dual Setpoint Example

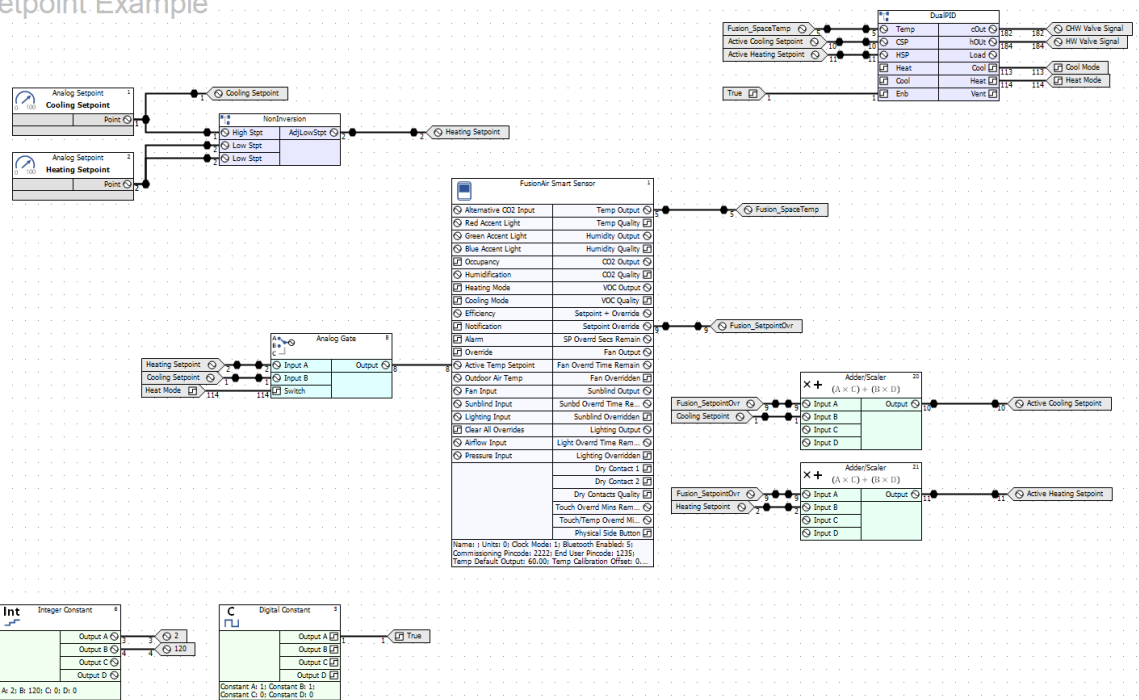

8.1.1.3 FOUR SETPOINT CONTROL

In ABB VAV Strategies it is common to use 4 setpoints:

1. occupied cooling
2. occupied heating
3. unoccupied cooling
4. unoccupied heating

CXpro^{HD} sample control Strategy 8.1.1.3 shows and example of how this could be implemented:

- Occupancy is used to determine if the occupied heating and setpoints or if the unoccupied heating and cooling setpoints are used. A macro prevents the heating setpoint going above the cooling setpoint, or the cooling setpoint going below the heating setpoint.
- The Fusion Sensor will display the occupied heating setpoint when in heating mode and show the occupied cooling setpoint when in cooling or vent mode.
- If the user overrides the setpoint at the sensor, the occupied heating and cooling setpoints will be incremented or decremented and the adjusted setpoint will be used for calculating heating and cooling capacity. The overridden setpoint will reset to the occupied heating and cooling setpoints after the Setpoint Override Duration time has expired.

When the FusionAir Smart Sensor is touched, the room is set to occupied.

Four Setpoint Example

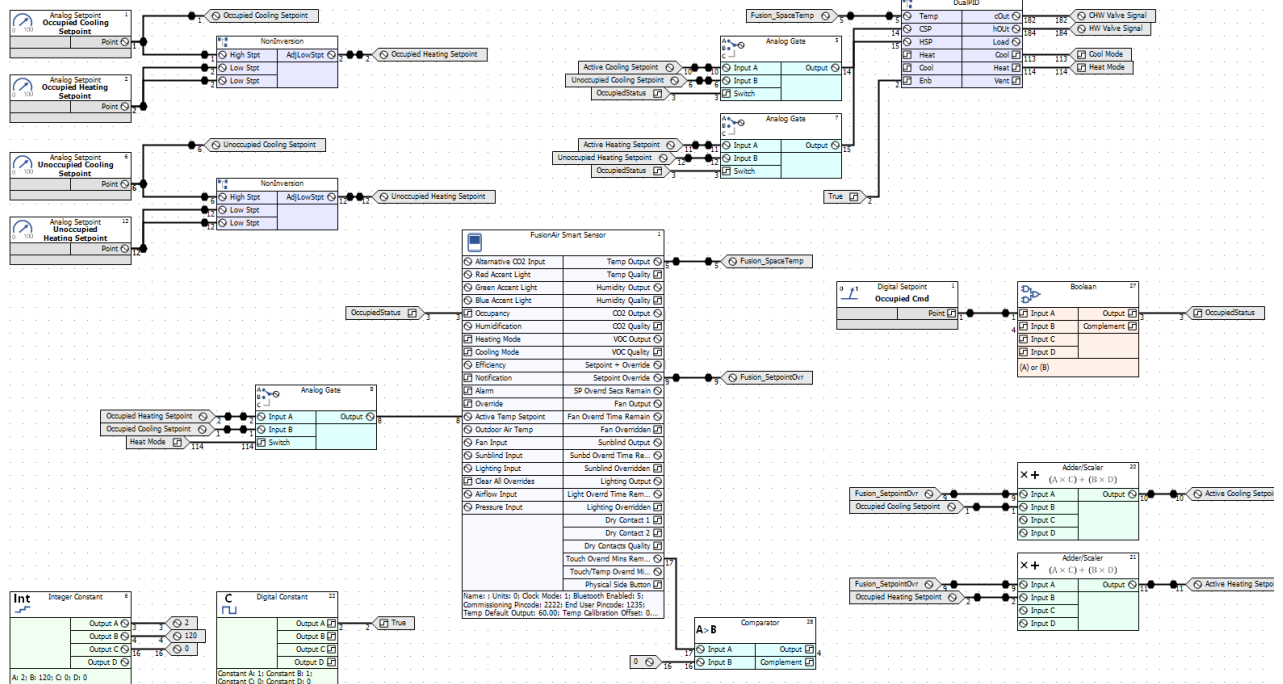

8.1.1.4 HUMIDIFY-DEHUMIDIFY

The FusionAir Smart Sensor can detect the humidity level which can be used in humidification and dehumidification applications.

In CXpro^{HD} sample control Strategy 8.1.1.4:

- When the humidity level rises above the Dehumidify Setpoint + Offset, a digital point will enable the room to dehumidify.
- When the humidity level falls below the Dehumidify Setpoint - Offset, the digital point will be disabled.
- When the humidity level falls below the Humidify Setpoint - Offset, a digital point will enable the room to humidify.
- When the humidity level rises above the Humidify Setpoint + Offset, or if the high duct humidity alarm is triggered, the humidify digital point will be disabled.

Humidify-Dehumidify

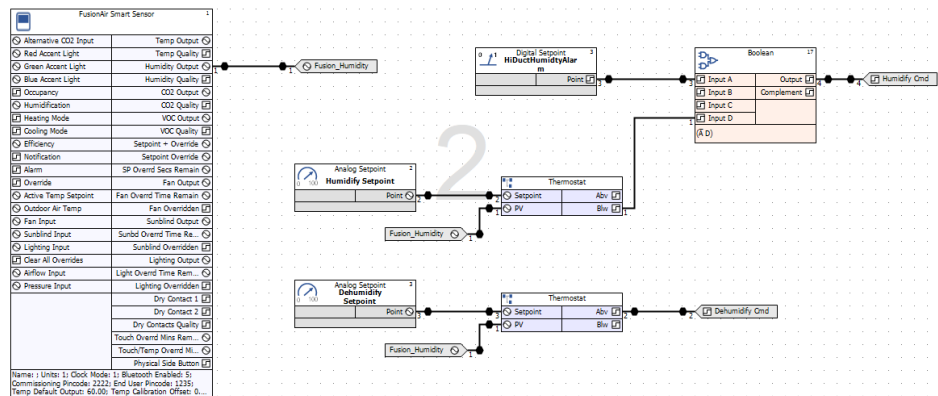

8.1.1.5 ACCENT LIGHTS

The FusionAir Smart Sensor’s LED lighting provides a full range of RGB colors for all sorts of applications, such as architectural accent lighting or to display unsafe conditions for the occupants of the room.

In CXpro^{HD} sample control Strategy 8.1.1.5, which aims to control CO₂ levels in the environment, the accent lights are triggered by the measured level of CO₂ displaying different colors for 3 levels:

- If the CO₂ level is higher than the CO₂ Setpoint + CO₂ Offset, the accent lights will turn red. The supply fan will ramp up based on the amount of offset.
- If the CO₂ level is lower than the CO₂ Setpoint – CO₂ Offset, the accent lights will turn green. The supply fan will ramp down based on the amount of offset.
- If the CO₂ level is within the CO₂ Offset range, the accent lights will turn blue. The supply fan will ramp based on current CO₂ level.
- On an increase in the difference between temperature from temperature setpoint, the supply fan speed will increase.
- On a decrease in the difference between temperature from temperature setpoint, the supply fan will decrease.

Fusion Sensor

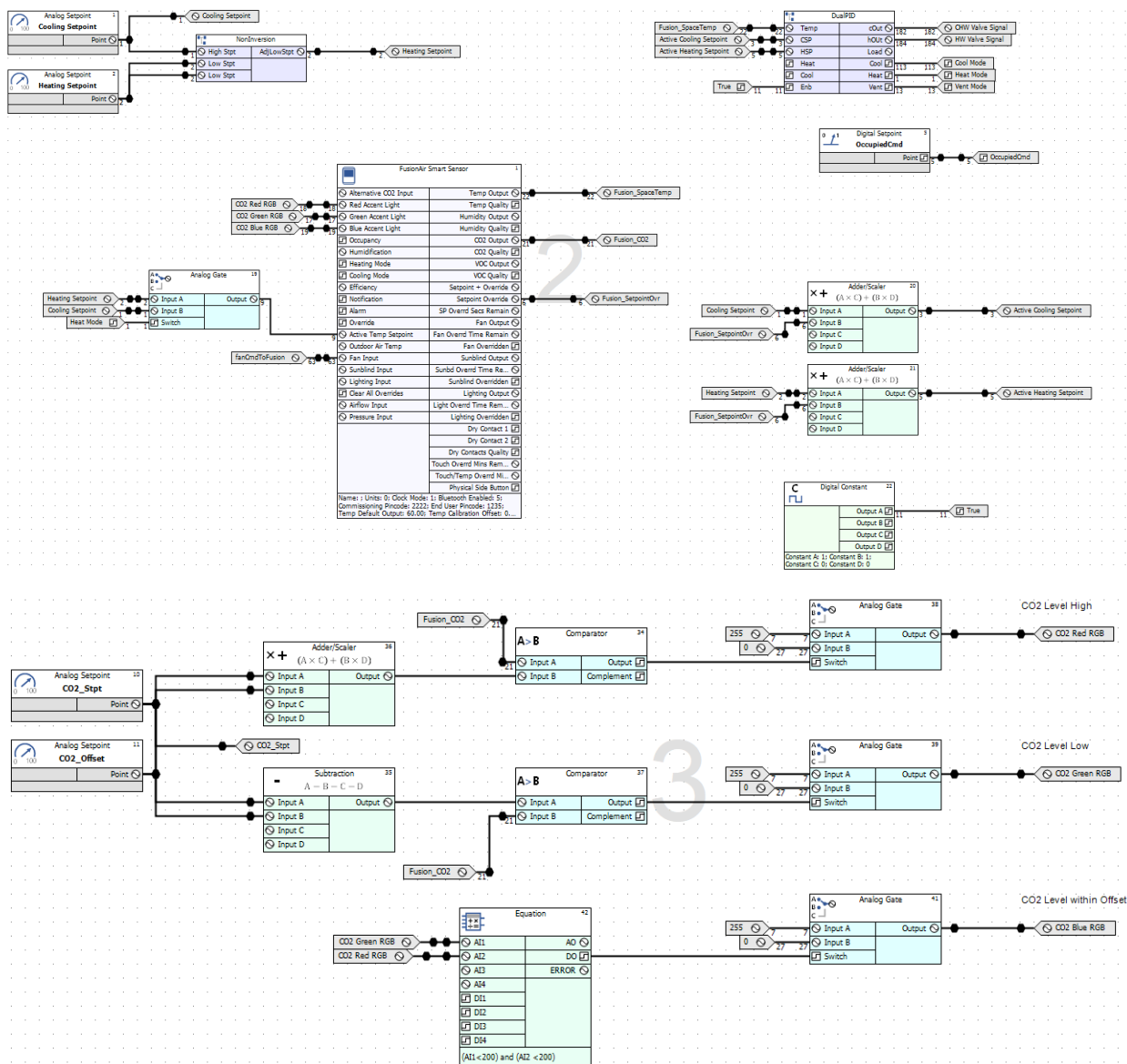

8.1.1.6 LIGHTING SCENE CONTROL

CXpro^{HD} sample control Strategy 8.1.1.6 simulates a conference room with different lighting scenes for meetings and presentations. The Strategy switches between the scenes when the physical button on the side of the FusionAir



← Physical push-button

The Conference room has 3 areas:

1. Area 1 – Border of room with dimmable lights
2. Area 2 – Front of room with 2-stage ceiling light fixtures
3. Area 3 – Back of room with 2-stage ceiling light fixtures

The Strategy switches between 5 scenes:

	Scene 0	Scene 1	Scene 2	Scene 3	Scene 4
Area 1	0%	100%	50%	0%	50%
Area 2	both stages OFF	both stages ON	OFF	both stages ON	1 stage ON
Area 3	both stages OFF	both stages ON	1 stage ON	both stages ON	1 stage ON

Pressing the Physical side button will increase the scene selection by 1. Once **Scene 4** is reached, pressing it again will start again at **Scene 0**.

If `Occupied Cmd BV6` is set to false, the lights will reset to **Scene 0**. `Occupied Cmd BV6` must be set to true to enable lighting Scene selection.

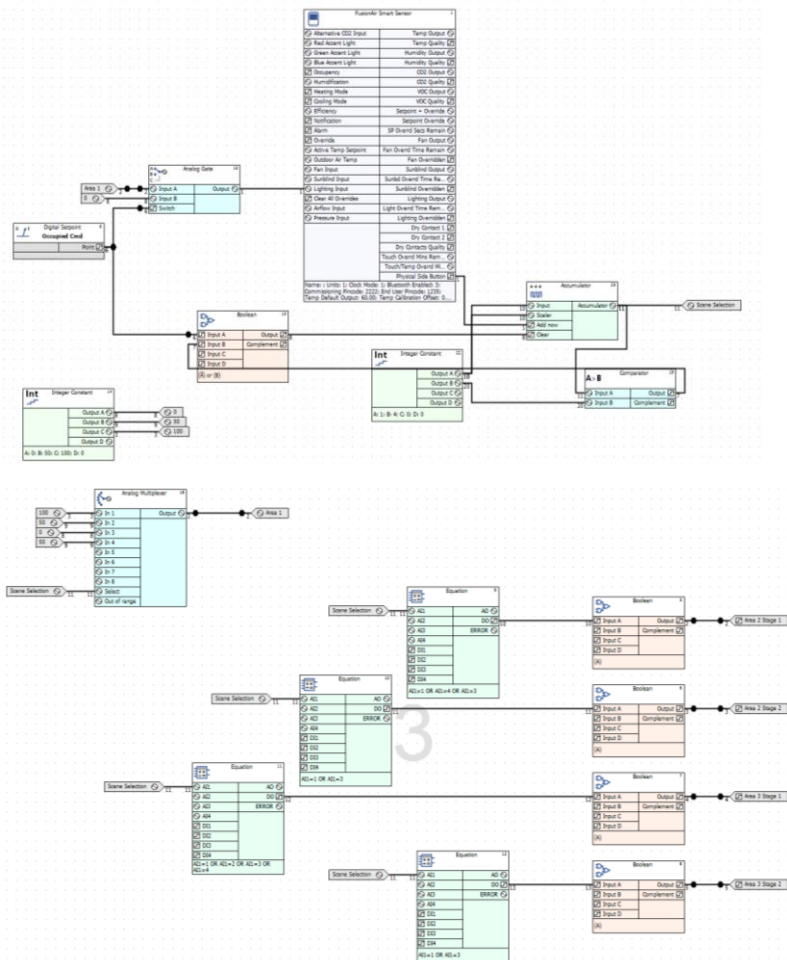

8.1.1.7 LIGHT CONTROL SENSOR OVERRIDE

CXpro^{HD} sample control Strategy 8.1.1.7 illustrates how dimmable lighting could be controlled through the FusionAir Smart Sensor using an external lux sensor.

As the amount of light in the room increases, the lighting will be reset to a lower level.

The lighting level can be overridden at the sensor for a set period of time.

Fusion Sensor

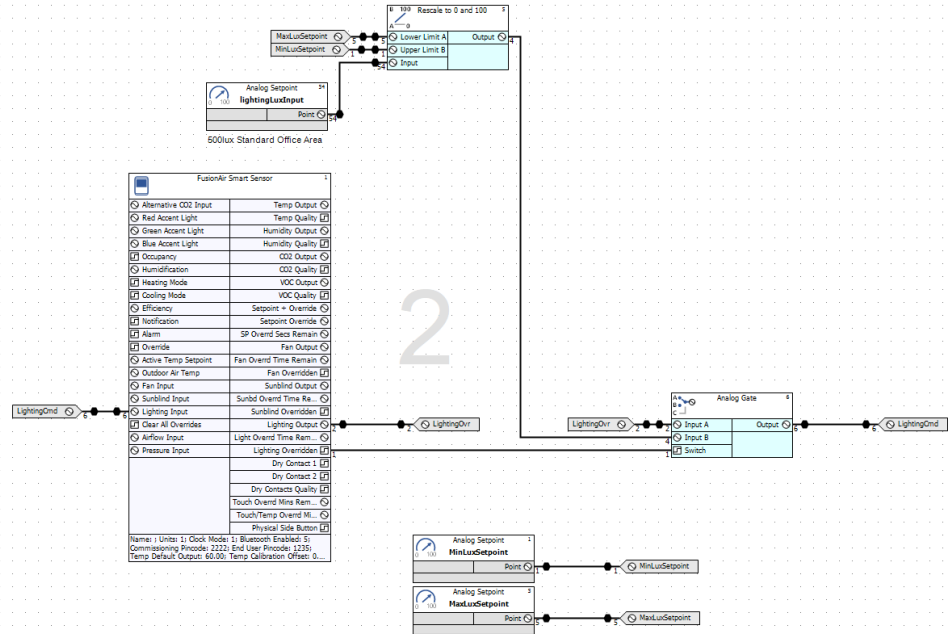

8.1.1.8 SUNBLIND CONTROL

CXpro^{HD} sample control Strategy 8.1.1.8 shows 3 types of sunblind control with the FusionAir Smart Sensor using an external lux sensor. The sensor can be used to manually override sunblind control sequences set up in the Strategy. In a similar manner to lighting in the previous sections, sunblind control can also be applied to conference rooms for meetings and presentations, or general ambient light control.

The type of control applied to the sunblinds is selected by setting AV56 `blindControl` to one of 3 values:

0 = allow the user to override the sunblind position through the FusionAir Smart Sensor.

1 = adjust the sunblind position based on a set light level in the room.

- As the light level increases, the sunblinds will close.
- As the light level decreases, the sunblinds will open.

2 = the lower sunblinds will be at minimum position. The upper sunblinds will adjust to a set light level in the room.

- As the light level increases, the sunblinds will close.
- As the light level decreases, the sunblinds will open.

Fusion Sensor

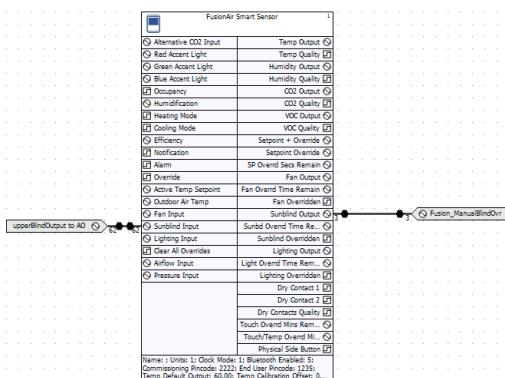

Lighting Example

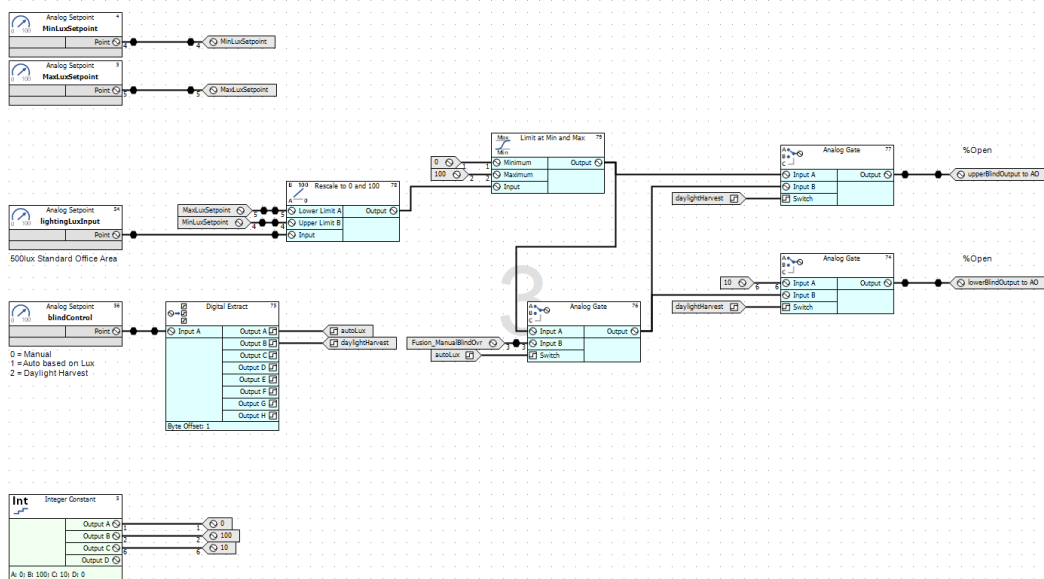

8.1.1.9 ECO LEAF

The ECO Leaf icon is intended to show operational efficiency. It can be used when site specifications require you to inform room occupants of the efficiency of the HVAC equipment.

CXpro^{HD} sample control Strategy 8.1.1.9 shows how the ECO leaf can be made to depend on setpoint overrides and fan speed.

If the temperature setpoint is overridden or if the heating or cooling is enabled, the efficiency will be reduced by a calculated leaf amount:

- If the fan speed is below 20%, the efficiency will not be affected.
- If the fan speed is between 21% and 60%, the efficiency will be reduced by 1 leaf.
- If the fan speed is above 60%, the efficiency will be reduced by 2 leaves.

Fusion Sensor

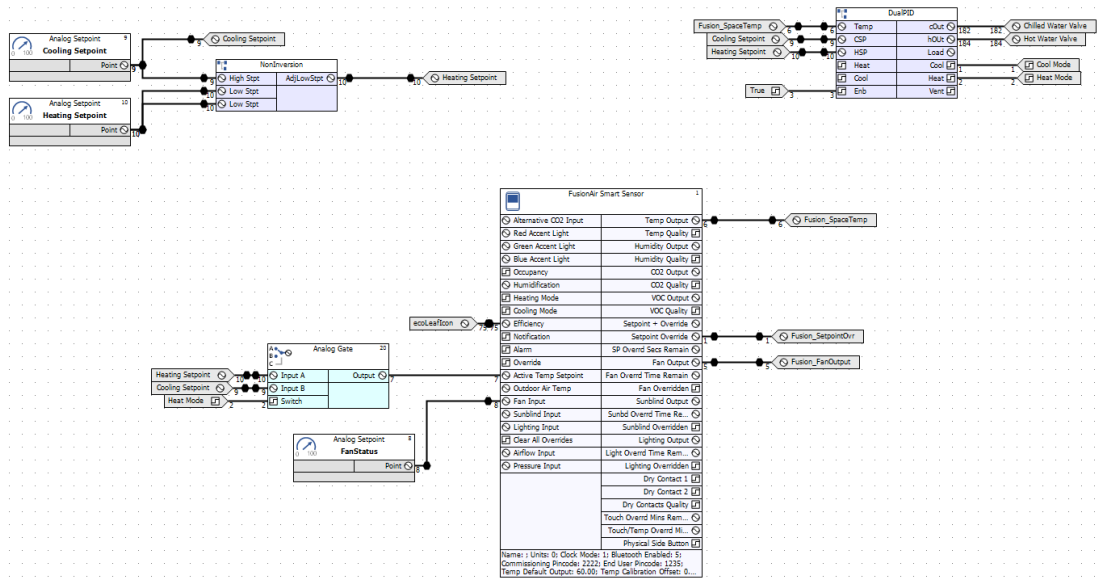

ECO Leaf Example

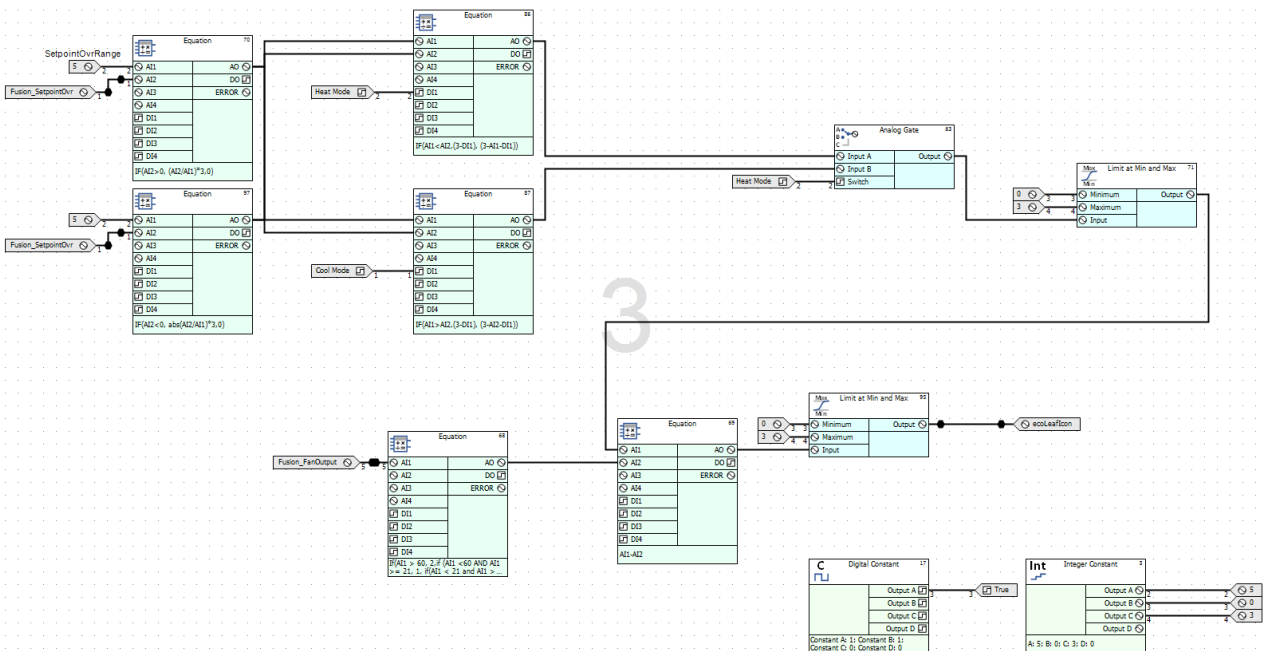

8.1.2.0 CO₂ AND VOC CONTROL

The Fusion Sensor will detect CO₂ and VOC levels, which can be used for monitoring safe air quality conditions in the room.

In CXpro^{HD} sample control Strategy 8.1.2.0, if the CO₂ level rises above the setpoint, the signal will increase until the damper reaches maximum position. If the CO₂ level falls below the setpoint, the signal will decrease until the damper reaches minimum position.

The CO₂ signal is used along with an Economizer sequence based on mixed air temperature. If the outside air temperature is within the temperature range to economize the room, the damper will modulate to maintain mixed air temperature:

- If the mixed air temperature rises above setpoint, the damper will modulate open.
- If the mixed air temperature falls below setpoint, the damper will modulate closed.

Fusion Sensor

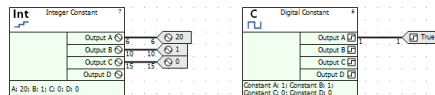
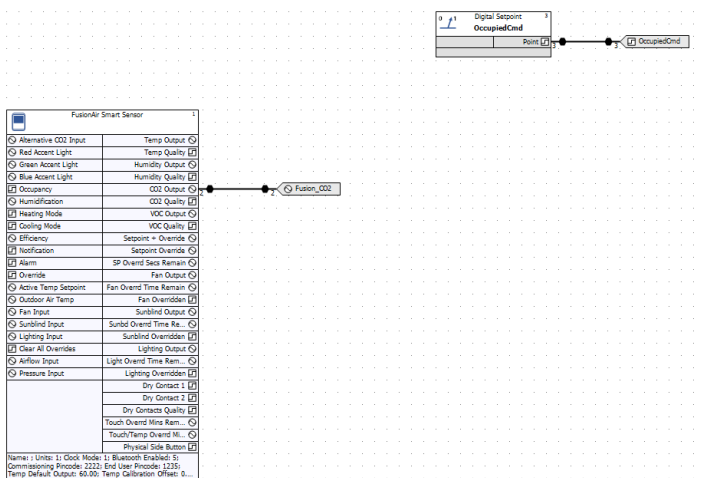

CO₂ Example

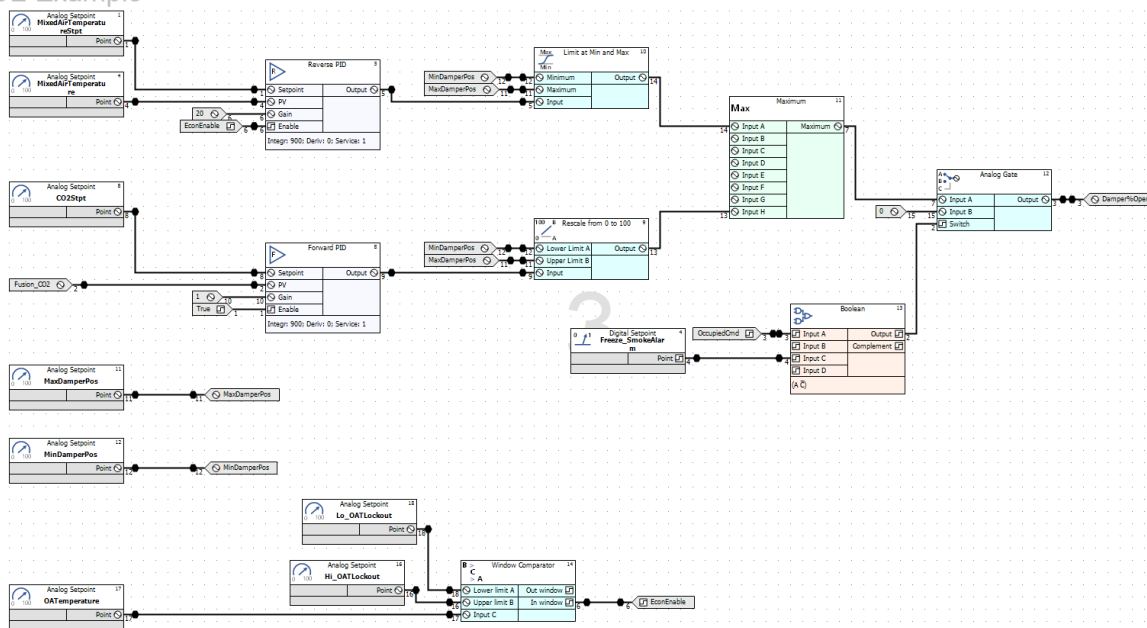

8.1.2.1 3-STAGE FAN CONTROL

CXpro^{HD} sample control Strategy 8.1.2.1 is an example of 3-Speed fan control that is often used in applications such as fancoils and unit vents in hotels and classrooms.

There are 3 states of fan operation, set AV25 FanOperation to one of the following:

0 = At minimum the fan will be always running at the lowest speed.

1 = The fan will only run based on the current heating and cooling demand. The higher the heating or cooling demand, the higher the fan speed. The lower the heating or cooling demand, the lower the fan speed.

2 = The fan speed will be manually set by the user. If the Fan Operation is set to 2, set AV12 ManualFanCmd to one of the following:

- 0 = Fan is Off
- 1 = Fan is at low speed
- 2 = Fan is at medium speed
- 3 = Fan is at high speed
- 4 = Fan speed is overridden at the fusion sensor

Fusion Sensor

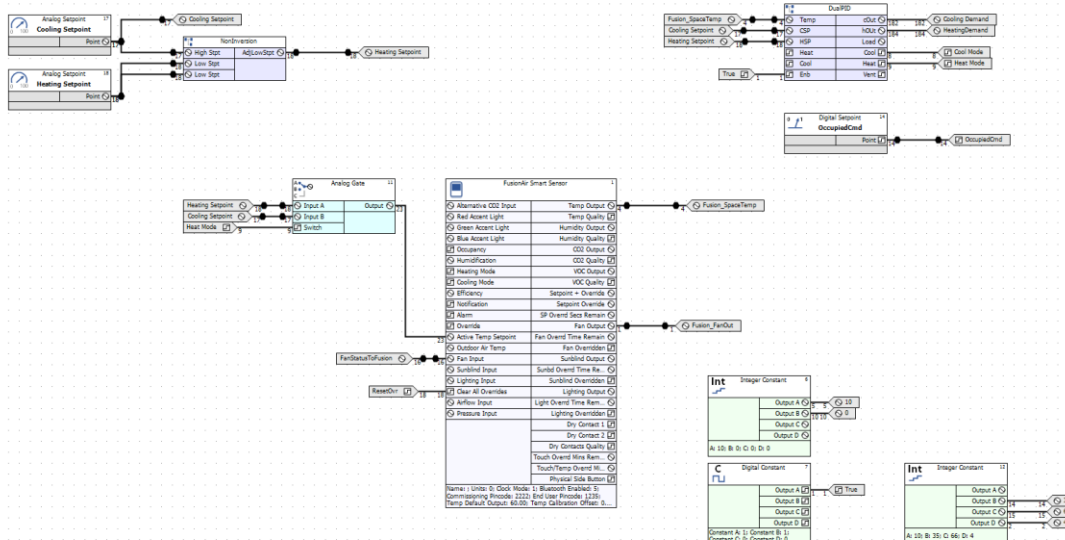

Fan Control

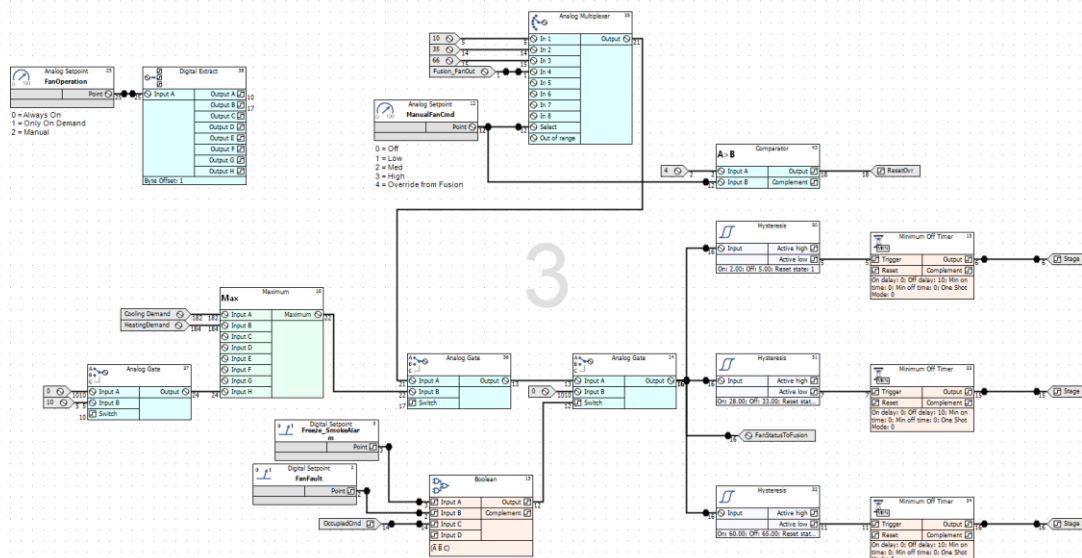

8.1.2.2 ANALOG FAN CONTROL

CXpro^{HD} sample control Strategy 8.1.2.2 illustrates how fan speed can be based on duct pressure, using an external duct pressure sensor. In this example,

- If the duct pressure rises above the setpoint, the signal will increase until the fan reaches maximum speed.
- If the duct pressure falls below the pressure setpoint, the signal will decrease until the fan reaches minimum speed.

Fusion Sensor

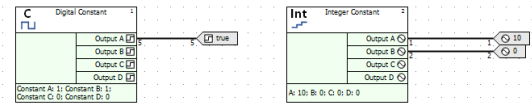
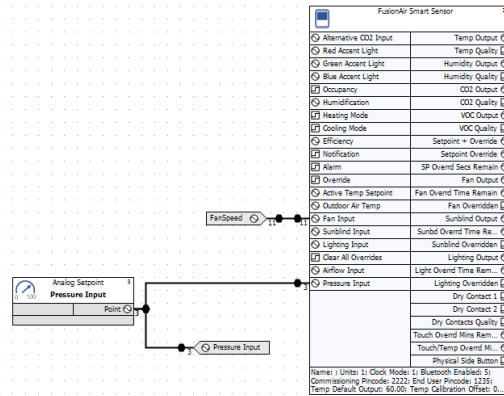

Fan Control

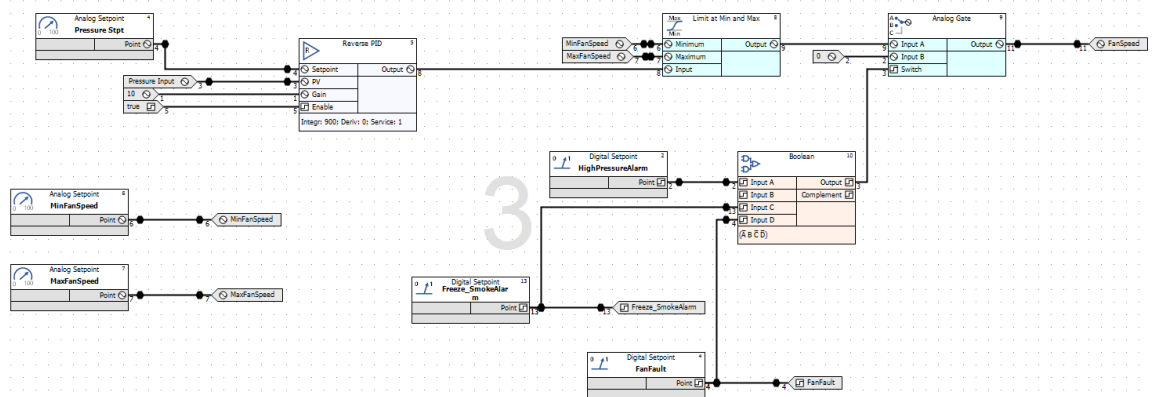

8.1.2.3 DIGITAL DRY CONTACTS

The two digital inputs (dry contacts) on the sensor can be used to detect occupancy, light switch, room card, window open/closed etc. CXpro^{HD} sample control Strategy 8.1.2.3 uses the example of a room card and window contact.

- When the user scans a room card in the hotel room, both the lighting and HVAC are energized.
- If the window contact is open, indicating that the window has been opened, the HVAC is automatically de-energized.
- Once the window contact is closed, the HVAC will be re-enabled.

Room Control

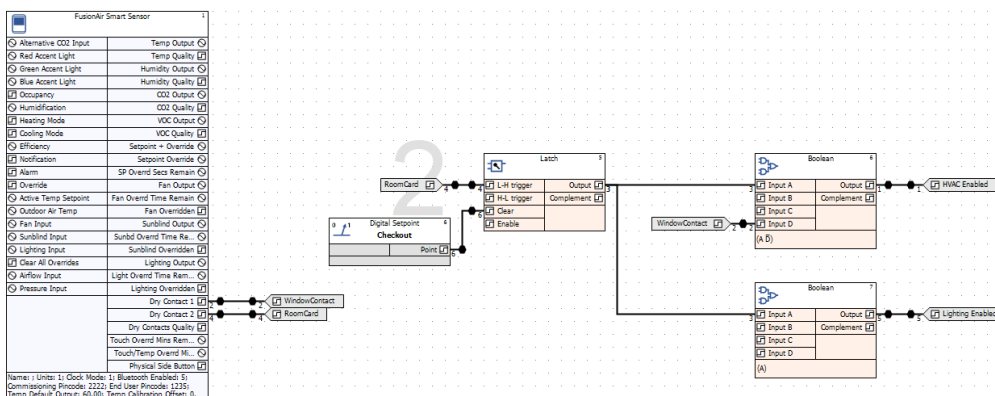

8.1.2.4 SIDE BUTTON

CXpro^{HD} sample control Strategy 8.1.2.4 uses the side push button as an occupancy override.

- When the side button is pressed, a digital occupancy override will be set to 0n.
- The occupancy override will remain on until the number of minutes set in AV1 `OccupancyOverrideTime` have elapsed.



← Physical push-button

Once the time has elapsed, the digital occupancy override will be set to 0ff.

Side Button Example

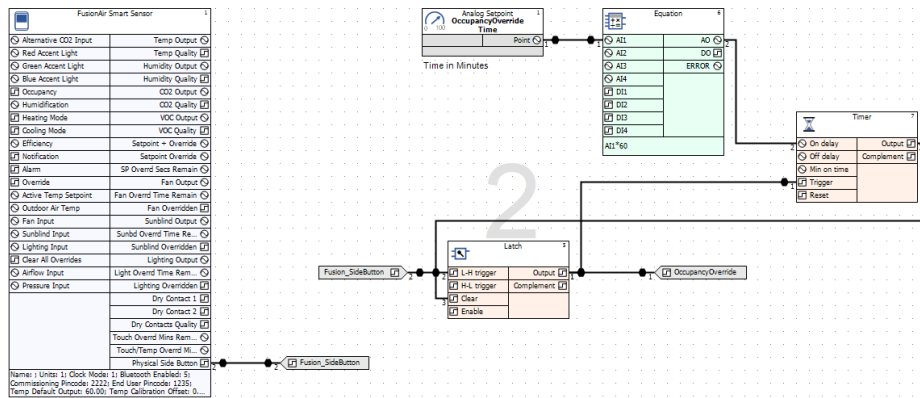

8.2.1.1 SAMPLE STRATEGY

CXpro^{HD} sample control Strategy 8.2.1.1 combines several of the preceding samples to demonstrate a complete FusionAir-compatible Strategy.

HEATING/COOLING SETPOINTS

This sample Strategy uses the 4 setpoint model:

1. occupied cooling
 2. occupied heating
 3. unoccupied cooling
 4. unoccupied heating
- Occupancy is used to determine if the occupied heating and setpoints or if the unoccupied heating and cooling setpoints are used.
A macro prevents the heating setpoint going above the cooling setpoint, or the cooling setpoint going below the heating setpoint.
 - The Fusion Sensor will display the occupied heating setpoint when in heating mode and show the occupied cooling setpoint when in cooling or vent mode.
 - If the user overrides the setpoint at the sensor, the occupied heating and cooling setpoints will be incremented or decremented and the adjusted setpoint will be used for calculating heating and cooling capacity.
The overridden setpoint will reset to the occupied heating and cooling setpoints after the Setpoint Override Duration time has expired.

The unoccupied setpoints are used when the room is unoccupied and are not adjustable from the FusionAir Smart Sensor.

When the FusionAir Smart Sensor is touched, the room is set to be occupied.

CO₂ MONITORING

This sample Strategy uses the color of the accent lights on the FusionAir Smart Sensor to indicate CO₂ levels.

In addition, the supply fan operation will be controlled to improve CO₂ levels when required.

- If the CO₂ level is higher than the CO₂ Setpoint + CO₂ Offset, the accent lights will turn Red. The supply fan will ramp up based on the amount of offset.
- If the CO₂ level is lower than the CO₂ Setpoint – CO₂ Offset, the accent lights will turn Green. The supply fan will ramp down based on the amount of offset.
- If the CO₂ level is within the CO₂ Offset range, the accent lights will turn Blue. The supply fan will ramp based on current CO₂ level.

HUMIDITY MONITORING

In this sample Strategy, Humidity is controlled for both humidification and dehumidification situations.

- When the humidity level rises above the Dehumidify Setpoint, a digital point will enable the room to dehumidify. When the humidity level falls below the Dehumidify Setpoint - Offset, the digital point will be disabled.
- When the humidity level falls below the Humidify Setpoint - Offset, a digital point will enable the room to humidify. When the humidity level rises above the Humidify Setpoint - Offset, or if the high duct humidity alarm is triggered, the humidify digital point will be disabled.

FAN COMMAND

In this sample Strategy, the fan is programmed to control humidity, CO₂ and room temperature.

- As the room humidity is offset from setpoint from 0...10%, and the room is dehumidifying or humidifying, a signal from 0...100% will be sent to the fan command.
- As the room CO₂ is offset from setpoint from -200 to 300 ppm, a signal from 0...100% will be sent to the fan command.
- As the room temperature is offset from setpoint from 1 to 5 degrees, and the room is in heating or cooling mode, a signal from 0...100 will be sent to the fan command.

ECO LEAF

In this sample Strategy, the ECO Leaf will provide indication of how efficient the HVAC equipment is operating.

If the temperature setpoint is overridden or if the heating or cooling is enabled, the efficiency will be reduced by a calculated leaf amount:

- If the fan speed is below 20%, the efficiency will not be affected.
- If the fan speed is between 21% and 60%, the efficiency will be reduced by 1 leaf.
- If the fan speed is above 60%, the efficiency will be reduced by 2 leaves.

LIGHTING CONTROL

The lighting Control section of this sample Strategy, generates a 0...100% lighting signal to control dimmable lighting, with the ability to override the setting from the sensor.

- When the room is occupied, the lighting level will be set based on the signal from an external Light Level sensor (AV64 Lighting Level).
- The user can override the lighting command for up to 120 minutes.
- When the room is unoccupied, the lighting level will go to 0%.

SUNBLIND CONTROL

In this sample Strategy, the type of control to be applied to window sunblinds is selected by setting AV56 blindControl to one of the following 3 values:

0 = allow the user to override the sunblind position through the FusionAir Smart Sensor.

1 = adjust the sunblind position based on a set light level in the room.

- As the light level increases, the sunblinds will close.
- As the light level decreases, the sunblinds will open.

2 = The lower sunblinds will be at minimum position. The upper blinds will adjust to a set light level in the room.

- As the light level increases, the sunblinds will close.
- As the light level decreases, the sunblinds will open.

Setpoint Control

Fusion Sensor

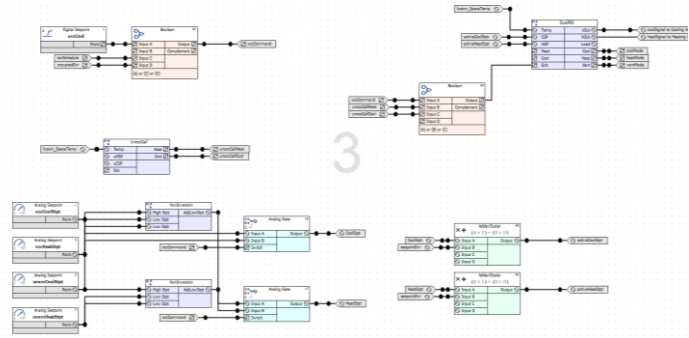
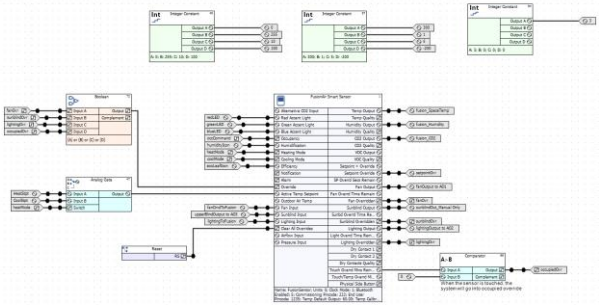

CO2

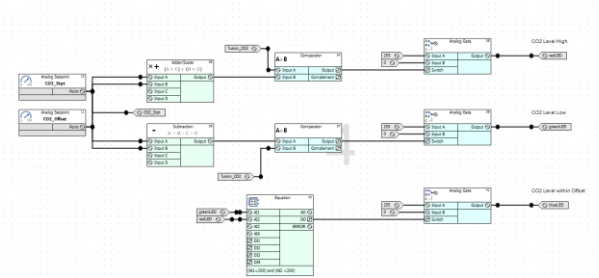

Humidity

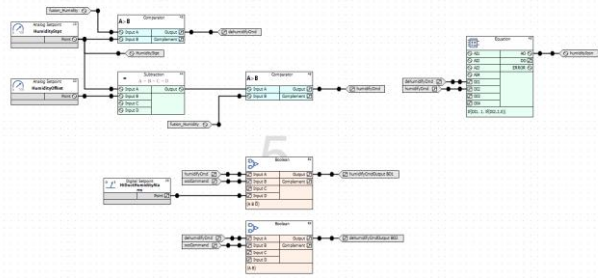

Fan

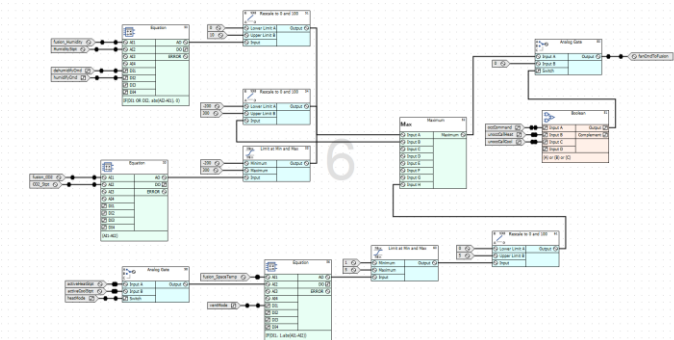

EcoLeaf

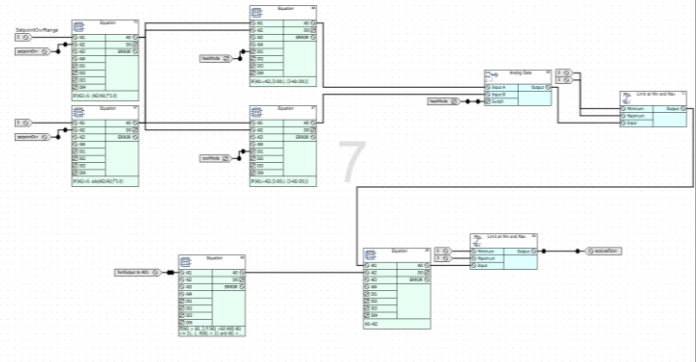

Lighting & Blinds





ABB CYLON CONTROLS

Clonshaugh Business &
Technology Park
Clonshaugh
Dublin 17
Ireland

Tel.: +353 1 245 0500
Fax: +353 1 245 0501
Email: info@cylon.com

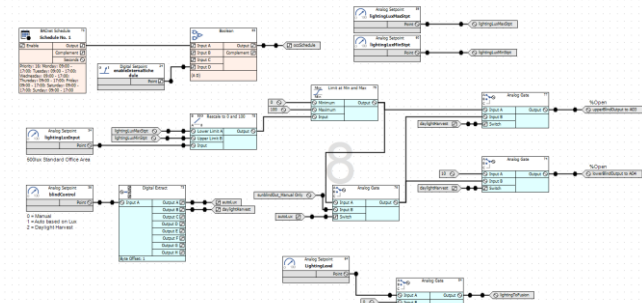
ABB CYLON CONTROLS

ONE TECHNOLOGY LANE
EXPORT,
PA 15632

Tel.: +1 724 733-2000
Fax: +1 724 327-6124