

ABB INSTRUMENTATION

The Company

ABB Instrumentation is an established world force in the design and manufacture of instrumentation for industrial process control, flow measurement, gas and liquid analysis and environmental applications.

As a part of ABB, a world leader in process automation technology, we offer customers application expertise, service and support worldwide.

We are committed to teamwork, high quality manufacturing, advanced technology and unrivalled service and support.

The quality, accuracy and performance of the Company's products result from over 100 years experience, combined with a continuous program of innovative design and development to incorporate the latest technology.

The NAMAS Calibration Laboratory No. 0255 is just one of the ten flow calibration plants operated by the Company, and is indicative of ABB Instrumentation's dedication to quality and accuracy.

BS EN ISO 9001



St Neots, U.K. – Cert. No. Q5907
Stonehouse, U.K. – Cert. No. FM 21106

EN 29001 (ISO 9001)



Lenno, Italy – Cert. No. 9/90A



Stonehouse, U.K.

Use of Instructions



Warning.

An instruction that draws attention to the risk of injury or death.



Note.

Clarification of an instruction or additional information.



Caution.

An instruction that draws attention to the risk of damage to the product, process or surroundings.



Information.

Further reference for more detailed information or technical details.

Although **Warning** hazards are related to personal injury, and **Caution** hazards are associated with equipment or property damage, it must be understood that operation of damaged equipment could, under certain operational conditions, result in degraded process system performance leading to personal injury or death. Therefore, comply fully with all **Warning** and **Caution** notices.

Information in this manual is intended only to assist our customers in the efficient operation of our equipment. Use of this manual for any other purpose is specifically prohibited and its contents are not to be reproduced in full or part without prior approval of Technical Communications Department, ABB Instrumentation.

Health and Safety

To ensure that our products are safe and without risk to health, the following points must be noted:

1. The relevant sections of these instructions must be read carefully before proceeding.
2. Warning labels on containers and packages must be observed.
3. Installation, operation, maintenance and servicing must only be carried out by suitably trained personnel and in accordance with the information given.
4. Normal safety precautions must be taken to avoid the possibility of an accident occurring when operating in conditions of high pressure and/or temperature.
5. Chemicals must be stored away from heat, protected from temperature extremes and powders kept dry. Normal safe handling procedures must be used.
6. When disposing of chemicals ensure that no two chemicals are mixed.

Safety advice concerning the use of the equipment described in this manual or any relevant hazard data sheets (where applicable) may be obtained from the Company address on the back cover, together with servicing and spares information.

CONTENTS

1 INTRODUCTION

2 INSTALLATION
 2.1 Siting
 2.2 Serial Communication Adaptor for Personal Computers

3 ELECTRICAL CONNECTIONS
 3.1 RS422 Connections
 3.2 RS423 Connections

4 SETTING UP
 4.1 Preparation
 4.2 Selecting the Transmission Mode and Termination Resistors
 4.3 Selecting the Transmission Speed (Baud Rate)

5 PROTOCOL4

6 PROGRAMMING
 6.1 Serial Data Communication Page

7 COMMUNICATION
 7.1 Instrument Status
 7.2 Communication between Master and Slaves
 7.3 Command Format for Simple Supervisory Systems Using a Computer Terminal (Protocol 1)
 7.4 Reply Format for Simple Supervisory Systems
 7.5 Examples of Simple Communication in Protocol
 7.6 Command Format for Protocol 2 Using a Host Computer
 7.7 Reply Format for Protocol 2 Using a Host Computer
 7.8 Examples of Complex Communication in Protocol 2

8 OPERATION

9 SPECIFICATION

10 IDENTIFICATION

APPENDICES 20
 A1 The American Standard Code for Information Interchange (ASCII)
 A2 Simple Basic Communication Programme
 A3 Block Check Characters
 A3.1 BCC Example for a Simple Supervisory System (Protocol 1)
 A3.2 BCC Example for a Host Computer Controlled System (Protocol 2)

Page

1 INTRODUCTION

1 The EIL8230 series of microprocessor-based ion-selective electrode monitors is extended by the addition of a serial data communication option which allows addressing and reprogramming via a host computer.

3
3 Serial data communication is a technique of sending data in a serial digital form, along a pair of cables, between two pieces of electronic equipment.

3 Since a series of pulses are used for transmission and reception, a code must be utilised to convert alphabetic-, numeric- and symbolic-characters into a corresponding pulse pattern. The code generally used is the American Standard Code for Information Interchange (ASCII), in which each character is allocated a seven-bit binary code. ASCII also includes a series of control characters which can be used to perform specific functions, e.g. carriage return, line feed etc. – see Appendix A1 on page 20.

4
4
4 A ‘frame’ normally consists of one start bit, the seven-bit ASCII code, a parity bit and one or two stop bits and is transmitted in serial format as shown in Fig. 1.1. A logic ‘1’ level is known as the MARK condition or IDLE state. The beginning of data transmission is signalled by a transition to a logic ‘0’ level known as the SPACE condition or ACTIVE state. One bit at logic ‘1’ serves as the prefix, or start bit, of the data transmission. Seven bits of the ASCII data are then transmitted in succession, starting with the least significant bit (LSB) and finishing with the most significant bit (MSB). The parity bit is additional to the seven-bit ASCII character and is used for error detection – see overleaf. One or two stop bits in the MARK condition denote the end of character transmission. The EIL8230 series of microprocessor-based ion-selective electrode monitors utilise only one stop bit and do not function correctly with two.

6
6
13
15
16
16 With analogue transmission various standards are defined for current and voltage levels, e.g. 4 to 20mA. Similar standards also exist for serial data communication and these define the electrical characteristics of the transmission lines.

18
19 The main standard used for serial data communication since the late 1960’s has been RS232, which was set up by the American Electronic Industry Association (EIA). Various refinements have been introduced over the years; version RS232C being the most widely accepted. With the RS232 system, one line is connected to common (0V) and the signal line is driven to –12V (logic ‘1’) or +12V (logic ‘0’). This method of transmission line driving is known as ‘single-ended’.

20
22
22 Because of limitations of the RS232C standard, i.e. speed of transmission, length of transmission line and differing- potential common line errors, a differential transmission system was adopted. The new system is designated RS422 and utilises two signal lines and an optional common line.

22
22 With the RS422 standard the signal lines are driven differentially; thus allowing faster speed of transmission, longer transmission

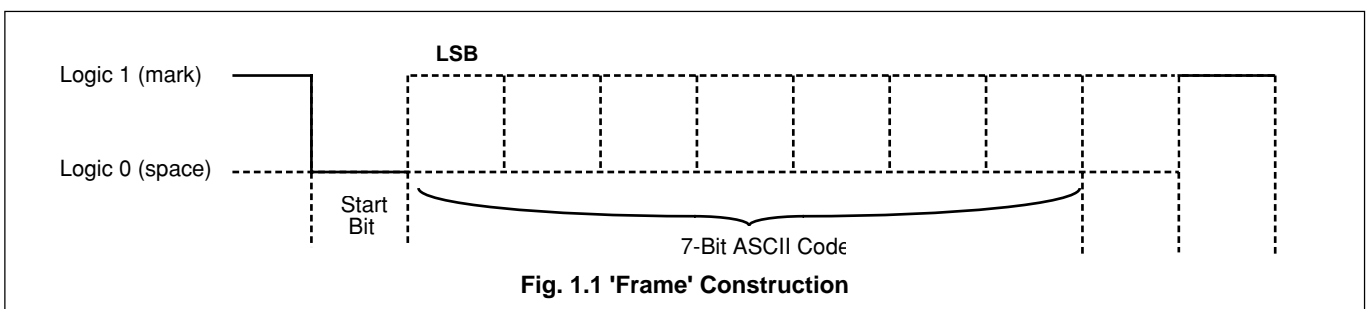

lines and also reducing the possibility of electrical interference. For RS422 transmission a +5V supply is used, with logic levels as follows:

- a) For logic '1' (MARK condition or IDLE state) the 'A' terminal of the transmitter is negative (0V) with respect to the 'B' terminal (+5V).
- b) For logic '0' (SPACE condition or ACTIVE state) the 'A' terminal of the transmitter is positive (+5V) with respect to the 'B' terminal (0V).

To accommodate compatibility with existing equipment operating to the RS232C standard, a new standard, designated RS423, has been derived. The RS423 standard has the transmission drivers operating in a 'single-ended' configuration but the voltage levels used are +5V and -5V. The receiver is connected in a differential mode, thus partially eliminating ground-loop interference problems. It is therefore possible to communicate between an instrument operating to the RS232C standard and another operating to the RS423 standard. For RS423 transmission the +5V and -5V supply is used with logic levels as follows:

- a) For logic '1' (MARK condition or IDLE state) the 'A' terminal of the transmitter is negative (-5V) with respect to the common (0V).
- b) For logic '0' (SPACE condition or ACTIVE state) the 'A' terminal of the transmitter is positive (+5V) with respect to the common (0V).

The logic state is thus identical to that of the RS232C standard but with lower voltage levels.

The speed of data transmission is defined as the baud rate and is measured in bits per second. Standard baud rates are 1200, 2400, 4800 and 9600 baud.

A simple error checking method has been devised, known as parity. The parity bit is a one-bit code which is transmitted in addition to the ASCII character. It can detect only one error per character, since two errors may cancel out. Parity is calculated by finding the sum of logic '1's in the character and either:

- a) Setting the parity bit to logic '1' if the sum is odd, or logic '0' if the sum is even, when using even parity.
- or
- b) Setting the parity bit to logic '0' if the sum is odd, or logic '1' if the sum is even, when using odd parity.

The block check character (BCC) is an additional form of checking and is the arithmetic sum of all the characters in a complete message (excluding parity bits) – see Appendix A3 on page 22.

Error detection is achieved by comparison of the BCC's of the transmitted and received messages.

Unless otherwise requested the instrument is supplied with the following standard settings:

- RS422 standard – see Section 4.2
- Simple Protocol (Protocol 1)
- Instrument identification 01 (Identity 01)
- No Parity (Parity NONE)
- No Block Check Character (Block Chr Check OFF)
- 2400 Baud Rate (Baud Rate 2400)

This supplement must be read in conjunction with the EIL8230 Operating Instructions (IM/8230), Issue 2 onwards.

2 INSTALLATION

2.1 Siting

Observe the limitations outlined in the Operating Instructions (IM/8230). The maximum serial data transmission line length is 1200m for RS422 systems or 600m for RS423 systems.

2.2 Serial Communication Adaptors for Personal Computers

An RS422/485 communications adaptor board is required for serial links. It is strongly recommended that the card used has galvanic isolation to protect the computer from lightning damage and increase immunity from noise pick-up from cables. The following OPTO22 boards are recommended for use with the EIL8230 series serial instruments.

Part No.	Computer Type
AC24	XT Bus IBM PC compatible
AC24 AT	AT Bus IBM PC compatible
AC34	Microchannel IBM PC

The following 'Jumper' selections are required on OPTO22 boards (usually supplied as the default configuration):

- RX and TX** – Install line termination jumper
Install pull-up and pull-down jumpers.
- CTS and RTS** – Disable jumper installed.

Select board address and interrupts as described in the OPTO22 manual.

3 ELECTRICAL CONNECTIONS

All connections, apart from those for serial data communication, are made as shown in Section 3 of the Operating Instructions (IM/8230).

The type of cable used is dependent on the transmission speed and cable length.

Up to 6m (all speeds) – standard screened or twisted pair cable.

Up to 300m – twin twisted pair with overall foil screen and an integral drain wire, e.g. Belden 9502 or equivalent.

Up to 1200m – twin twisted pair with separate foil screens and integral drain wires fore each pair, e.g. Belden 9729 or equivalent.

3.1 RS422 Connections – Figs. 3.1 and 3.2

Connect the monitors in parallel as shown in the schematic diagram – Fig. 3.1. The RS422 standard quotes connection of ten slaves (EIL8230 series of microprocessor-based ion-selective electrode monitors) maximum to any one driver (computer terminal or host computer). However, this number can be increased if the driver's serial port permits.

Make serial data connections as shown in Fig. 3.2. Use four-core screened cable consisting of two twisted screened pairs, one pair for transmission and one pair for reception, of maximum length 1200m.

N.B. Transmission line termination resistors are required on the last 8230 monitor in the chain – see Fig. 3.1. The resistors are selected by plug-in links within the instrument – see Section 4 overleaf.

3.2 RS423 Connections – Fig. 3.3

In the RS423 mode, only one EIL8230 series of microprocessor-based ion-selective electrode monitor can be connected to the host computer. Make serial data connections as shown in Fig. 3.3. Use two-core screened cable consisting of a twisted pair with an overall screen, of maximum length 600m.

4 SETTING UP

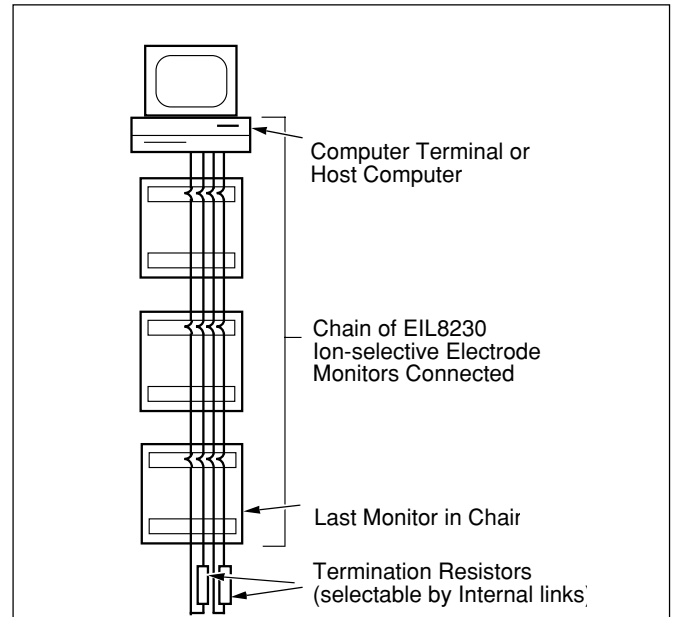

Fig. 3.1 RS422 Connections – Schematic Diagram

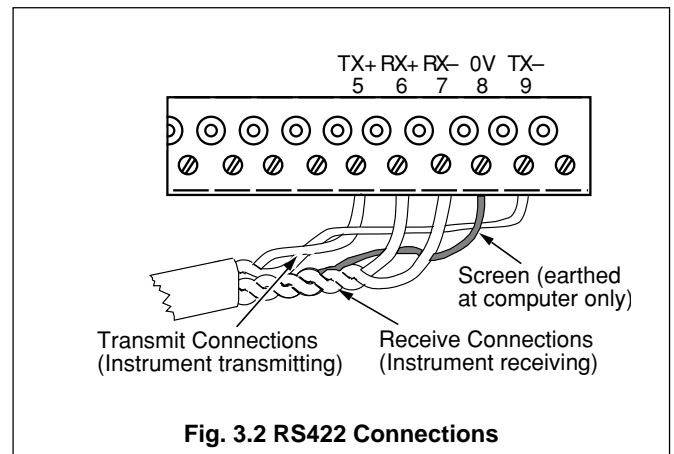

Fig. 3.2 RS422 Connections

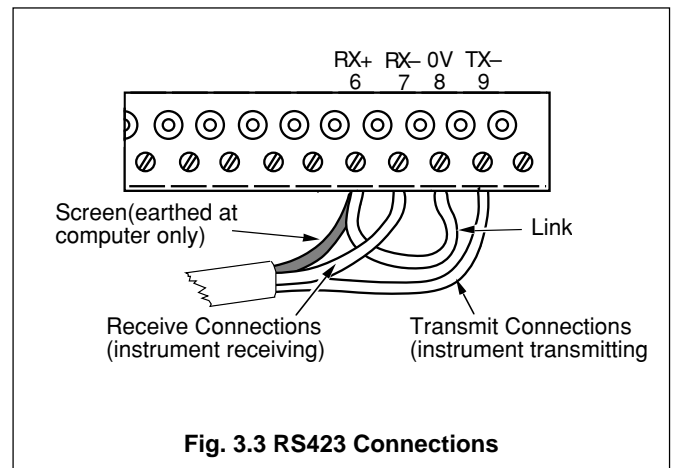

Fig. 3.3 RS423 Connections

For all aspects other than serial data transmission the controller is set up as shown in the Operating Instructions (IM/8230). Unless otherwise requested, the instrument is despatched in the RS422 mode, with a transmission rate of 2400 baud and transmission line termination resistors linked-out. If these settings are not appropriate to the application, they may be altered as detailed in the following sections.

4.1 Preparation

Switch off the supply.

Refer to Figs. 1.1 and 4.3 in the Operating Instructions (IM/8230).

Release the 'case locks' and open the main case (Fig. 1.1).

On the microprocessor unit open the lower panel, lift up the front section and remove the p.c.b. protection plate (Fig. 4.3).

4.2 Selecting the Transmission Mode and Termination Resistors – Fig. 4.1

The transmission mode (RS422 or RS423) and termination resistors (linked-in or -out) are selected via plug-in links located on the serial interface p.c.b. The termination resistors ensure correct line impedance for RS422 communication.

- ① Remove the p.c.b. tie-bar.
- ② Identify the serial interface p.c.b. located in the 'OUTPUT MODULE 2' position.
- ③ Unplug the p.c.b.
- ④ Identify the plug-in links on 'PL 3'.
- ⑤ Position the two upper links for the transmission mode required (RS422 or RS423).
- ⑥ Position the two lower links for termination resistors:
Link-in for RS422 communication (see **Note**).
Link-out for RS423 communication.

Note. For RS422 communication the termination resistors must be linked-in on the **last** EIL8230 ion-selective electrode monitor in the chain only – see Fig. 3.1. The resistors must be linked-out on all other monitors in the chain.

- ⑦ Refit the p.c.b., tie-bar and protection plate (wall-/pipe-mounted instruments only).

Proceed to the following section.

4.3 Selecting the Transmission Speed (Baud Rate) – Fig. 4.1

The baud rate is determined by a plug-in link on the processor p.c.b.

- ⑧ Identify the plug-in link.
- ⑨ Position the link for the baud rate required.

On completion, reverse the procedure outlined in Section 4.1 above.

5 PROTOCOL

Protocol is the format in which data is transmitted or received.

The master (computer terminal) to slave (EIL8230 ion-selective electrode monitor) protocol for a simple supervisory system (Protocol 1) is:

Command – Identification – Parameter . . . Limiter (' ') – see Figs. 7.2 and 7.3 (on pages 12 and 13) for command and reply formats, respectively.

The master (host computer) to slave (EIL8230 ion-selective electrode monitor) protocol for a more complex host computer system (Protocol 2) is:

Start transmission (STX) – Command – Identification . . . End transmission (ETX) – see Figs. 7.4 and 7.5 (on pages 15 and 16) for command and reply formats, respectively.

It is important to note that the above two systems have different protocols.

The protocols used for serial data communication on EIL8230 ion-selective electrode monitors have the following characteristics:

Protocol 1 – This is a simple protocol without echo. The command does not appear on the VDU. When the EIL8230 ion-selective electrode monitor has received a complete message, it transmits the **reply only** back to the VDU.

Protocol 2 – This is a complex protocol based on ANSI-X3.28-1976-2.S-A4. Transmissions of commands and processing of the subsequent replies must be incorporated into the host computer programme – see Appendix A2 on page 22.

The EIL8230 ion-selective electrode monitor (slave) can be controlled by a host computer (master) in either a simple supervisory system or a fully host-computer controlled system. The system language (protocol) depends on the system used. Any of the two protocol levels, above, can be selected – see Section 6 on page 6.

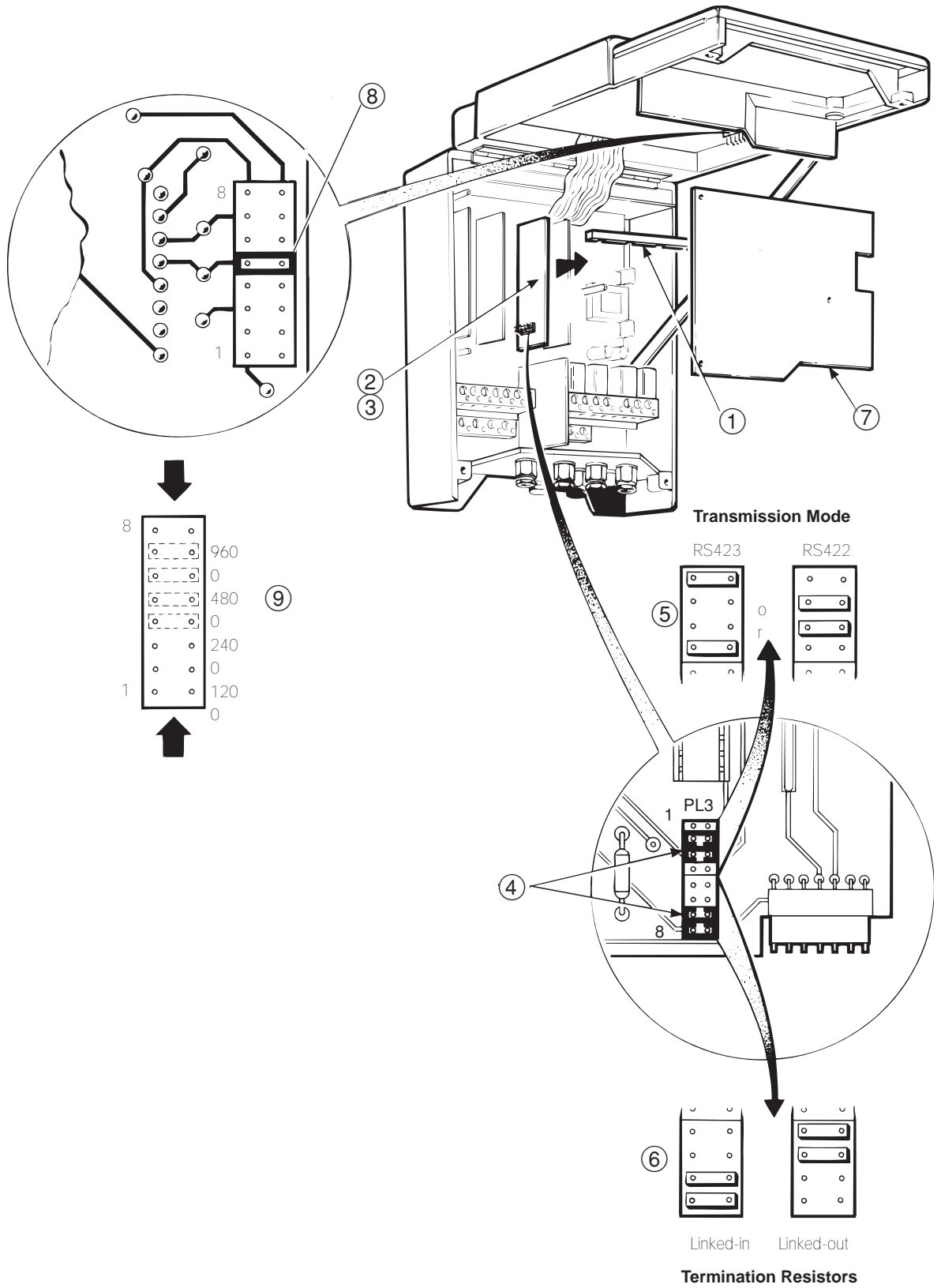

Fig. 4.1 Plug-in Link Locations for Transmission Modes and Termination Resistors

PROGRAMMING

The general programming procedure is the same as for the standard instrument but an **Serial Data Communication Page** inserted before the **Set Up Clock Page** and all reference to Output 2 has been removed from the **Current Output** and **Calibration** pages. Fig. S7 (page 8) shows the modified programme chart.

Serial Data Communication Page

SERIAL INTERFACE

Page Header – **Set Up Inp**



Advance to next parameter

Protocol X

Protocol

View Change

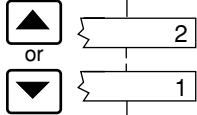

Complex protocc
Simple protocol without ecl

Enter

Store



Advance to next parameter

Identity XX

Instrument Identity

View Change

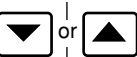

Assign the instrument an identification number (1 to 99) **RS422 Connections** page S3. The wide range of identification values (1 to 99) allows for connection of EIL8230 ion-selective electrode monitors than one communication channel.

Enter

Store



Advance to next parameter

Parity XXXX

Parity

View Change



Set the parity to comply with that of the computer terminal or host computer

Enter

Store



Advance to next parameter

Block Chr Check XXX

Block Check Character

View Change

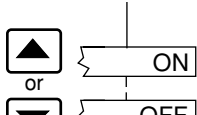

Check whether or not block checking is required (see Appendix A3 on page 22).

Block checking enabled
Block checking disabled

Enter

Store



Advance to next parameter

Continued on next page

Continued from previous page

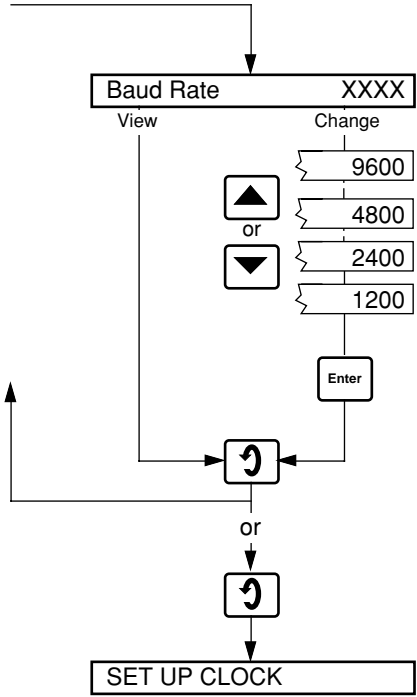

Baud Rate
Select the same baud rate as already set by links on the serial interface p.c.t
– see SECTION 4.3 on page 4.

Store

Return to display of 'SERIAL INTERFA'

or

Advance to display of 'CALIBRATIC

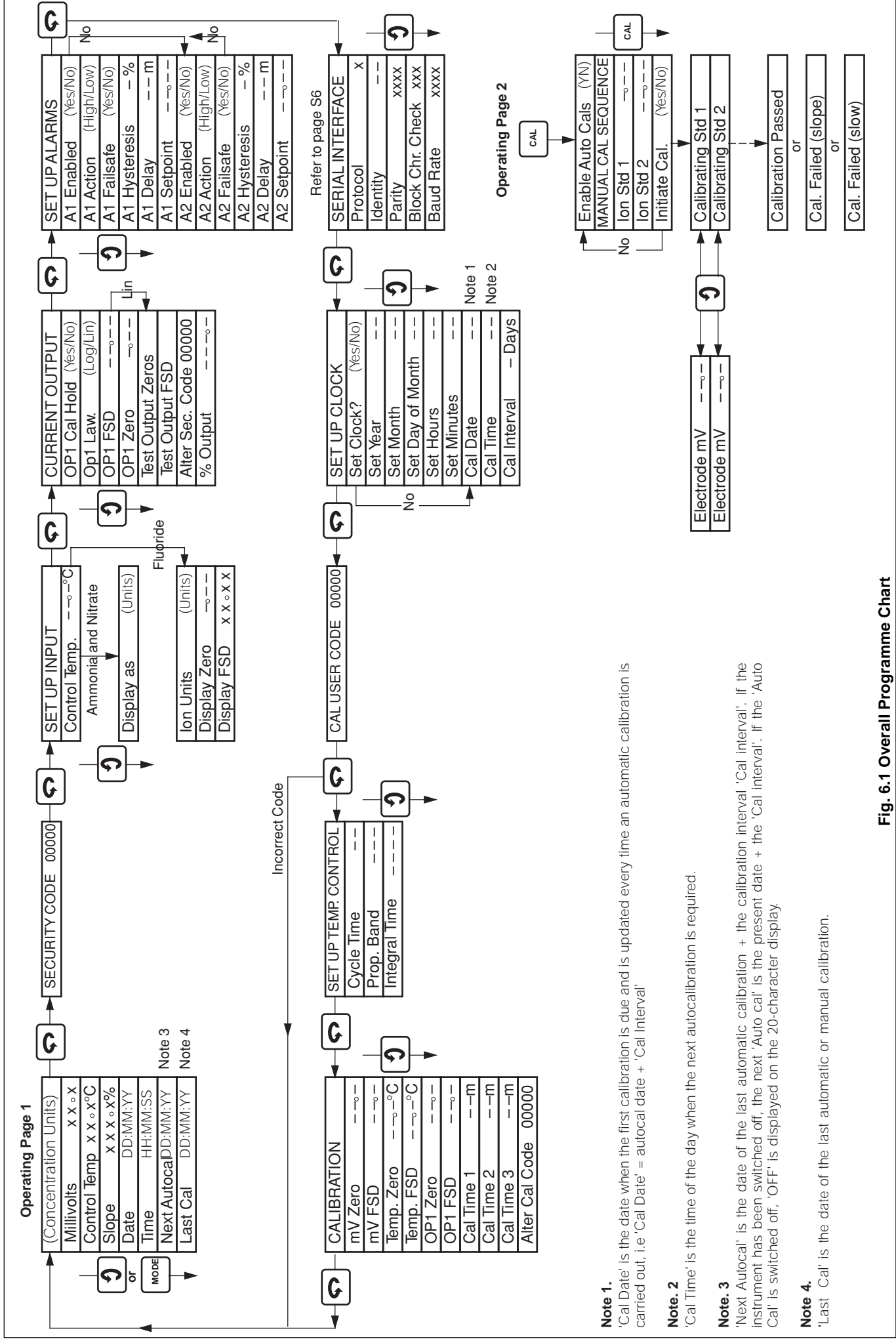

Fig. 6.1 Overall Programme Chart

7 COMMUNICATION

Parameter	Mnemonic	Used With Command				Reply Interpretation
		'Read'	'Write' (+ Required Data)	'Change' (+ Sign '+ ' or '-')	'Set' (+ Instruction Character)	
Measured Ion Value	I1	Yes	No	No	No	Value is between Display Zero and Display Span.
Measured Millivolts	M1	Yes	No	No	No	+400 to -400
Measured Temperature	RT	Yes	No	No	N	Measured temperature.
Slope	SL	Yes	No	No	No	0 to 120%, typically 100%
Date	DT	Yes	No	No	No	Day, Month and Year (DD:MM:YY)
TimeTM	Yes	No	No	No	Hours, Minutes (HH:MM)	
Next Autocal	NC	Yes	No	No	No	Day, Month and Year (DD:MM:YY)
Calibration Time	NT	Yes	No	No	No	Hours, Minutes (HH:MM)
Last Calibration Date	LC	Yes	No	No	No	Day, Month and Year (DD:MM:YY)
Instrument Type	IT	Yes	No	No	No	Flu=Fluoride, Amo=Ammonia or Nit=Nitrate,
Control Temperature	CT	Yes	No	No	No	30 to 45°C
Display as (8232 only)	DA	Yes	No	No	Yes	(NH ₃) Ammonia, (NH ₄) Ammonium or (N) Nitrogen
Display as (8236 only)	DN	Yes	No	No	Yes	(NO ₃) Nitrate (N) Nitrogen
Ion Units	IU	Yes	No	No	No	ppm, mg/l or mg/kg
Display Zero	DZ	Yes	No	No	No	See Table 7.2.
Display FSD	DS	Yes	No	No	No	Fixed at 2 decades above Display Zero, see Table 7.2.
OP1 Cal Hold	OH	Yes	No	No	No	Yes or No
OP1 Law	OL	Yes	No	No	No	Log or Lin
OP1 FSD	OS	Yes	Yes	Yes	No	Programmable between Display Zero and Display Span.
OP1 Zero	OZ	Yes	Yes	Yes	No	Programmable between Display Zero and Display Span.
Alarm 1:						
Enabled	E1	Yes	No	No	No	N=No, Y=Yes
Action	A1	Yes	No	No	No	High or Low
Fail-safe	F1	Yes	No	No	No	Yes or No
Hysteresis	H1	Yes	No	No	No	0 to 5%
Delay	D1	Yes	No	No	No	0 to 60 minutes
Set Point	S1	Yes	Yes	Yes	No	Programmable between Display Zero and Display Span.
Alarm 2:						
Enabled	E2	Yes	No	No	Yes	N = No, Y = Yes
Action	A2	Yes	No	No	No	High or Low
Fail-safe	F2	Yes	No	No	No	Yes or No
Hysteresis	H2	Yes	No	No	No	0 to 5%
Delay	D2	Yes	No	No	No	0 to 60 seconds
Set Point	S2	Yes	Yes	Yes	No	Programmable between Display Zero and Display Span.
Programme Clock	PC	Yes	No	No	Yes	N = No, Y = Yes
Set Year	SY	Yes	Yes	Yes	No	0 to 99
Set Month	SM	Yes	Yes	Yes	No	1 to 12
Set Day of Month	SD	Yes	Yes	Yes	No	1 to 31
Set Hours	SH	Yes	Yes	Yes	No	0 to 23
Set Minutes	SN	Yes	Yes	Yes	No	0 to 59
Calibration Date:						
Year	CY	Yes	Yes	Yes	No	0 to 99
Month	CM	Yes	Yes	Yes	No	1 to 12
Day	CD	Yes	Yes	Yes	No	1 to 31
Hours	CH	Yes	Yes	Yes	No	0 to 23
Minutes	CN	Yes	Yes	Yes	No	0 to 59
Calibration Interval	CP	Yes	Yes	Yes	No	1 to 7 days

Table 7.1 Parameter Mnemonics

Parameter	Mnemonic	Used With Command				Reply Interpretation
		'Read'	'Write' (+ Required Data)	'Change' (+ Sign '+ ' or '-')	'Set' (+ Instruction Character)	
Enable Auto Calibration	EC	Yes	No	No	Yes	N = No, Y = Yes
Ion Standard 1	C1	Yes	Yes	Yes	No	Programmable between Display Zero and Display Span.
Ion Standard 2	C2	Yes	Yes	Yes	No	Programmable between Display Zero and Display Span.
Initiate Manual Calibration	CA	Yes	No	No	Yes	L to initiate manual calibration
Hold Mode	HM	Yes	No	No	No	I = In or O = Out
Status Condition	ST	Yes	No	No	No	See Section 7.1 opposite.
Non-volatile Condition	NV	Yes	No	No	Yes	D = Disabled, E = Enabled

Table 7.1 Parameter Mnemonics (continued)

N.B.

If the non-volatile memory is used (i.e. NV = enabled) to store any parameter changes made via the serial link to ensure that the information is retained during mains interruption or power-down. The memory used is rated at 10⁴ write cycles per register and each register is assigned a particular parameter, e.g. alarm 1 set point, calibration time etc. If the number of write cycles to any particular register exceeds this value, the register's contents may not be retained.

Monitor Type	Display Zero	Display Span
Fluoride (8231)	0.10	10.00
	0.20	20.00
	0.50	50.00
	1.0	100.0
	2.0	200.0
	5.0	500.0
	10	1000
Nitrate as (N) (8236)	0.20	20.00
	0.50	50.00
	1.0	100.0
	2.0	200.0
	5.0	500.0
	10	1000
Nitrate (8236)	1.0	100.0
	2.0	200.0
	5.0	500.0
	10	1000
	20	2000
	50	5000
Ammonia (8232)	0.05	5.00
	0.10	10.00
	0.20	20.00
	0.50	50.00
	1.0	100.0
	2.0	200.0
	5.0	500.0
	10	1000

Table 7.2 Display Ranges

Error Code	Error
01	Invalid command – not 'Read' (R), 'Change' (C), 'Write' (W) or 'Set' (S).
02	Invalid 'Read' parameter – parameter cannot be used with the 'Read' (R) command (see Table 7.1).
03	Invalid 'Write' parameter – parameter cannot be used with the 'Write' (W) command (see Table 7.1).
04	Too many characters entered into buffer – transmitted message is greater than 12 characters long.
05	Invalid decimal point position – some parameters do not have a decimal point position – see Section 6 in the Operating Instructions (IM/8230).
06	Invalid 'Change' parameter – parameter cannot be used with the 'Change' (C) command (see Table 7.1).
07	No sign in 'Change' command – the 'Change' value must be preceded by either '+' or '-'.
08	'Write' (W) or 'Change' (C) value not within instrument limits.
09	Non-numeric character entered – the data (up to five characters) must not contain a non-numeric character.
10	Invalid 'Set' parameter – parameter cannot be used with the 'Set' (S) command (see Table 7.1).
12	Mnemonic used with 'Set' command has been followed by incorrect instruction character, e.g. 'F1' must be followed by 'N', 'A' or 'B'.
15	Received block check character error – see Appendix A3.
16	No start control character (STX) in complex protocol.
17	Received parity check error – see Section 1.
18	Overrun on framing error detected in receiving data.
20	No data on 'Write' (W) or 'Change' (C) command.
21	More than one decimal point in data.
22	No data after decimal point.
23	More than five characters in data field.
26	Invalid characters in 'Read' (R) or 'Set' (S) command.

Table 7.3 Error Codes

7.1 Instrument Status

The instrument status is sent as decimal number. To interpret this information convert to binary then refer to Fig. 8 (0 = clear, 1 = set).

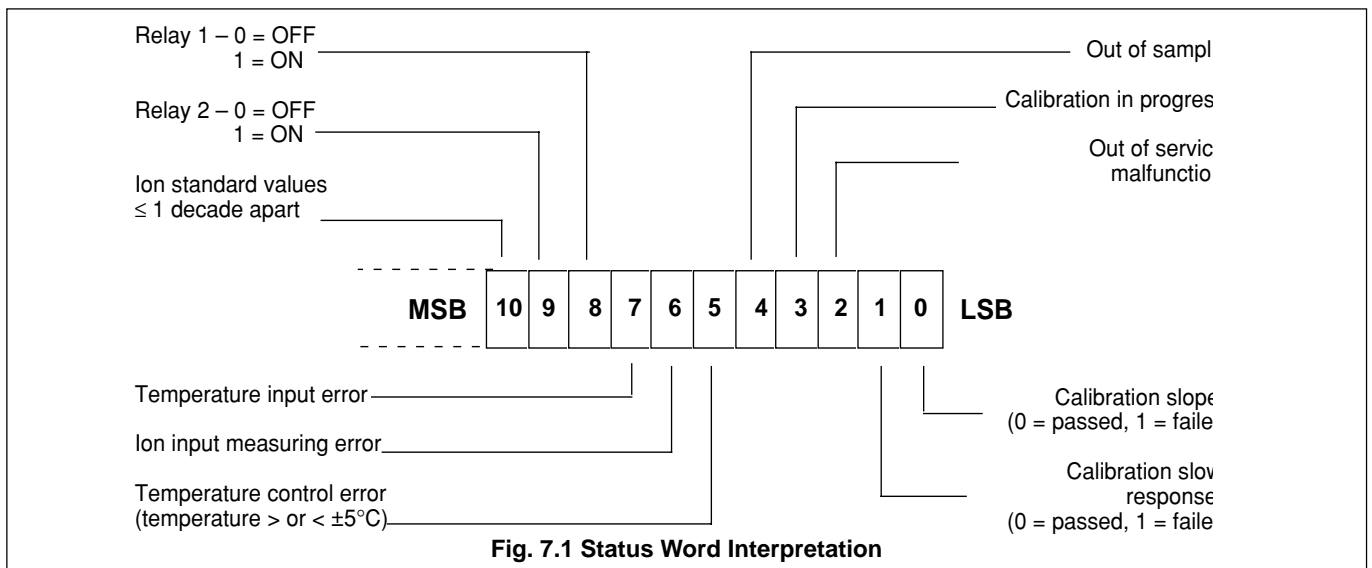

Example. Refer to Fig. 7.1.

The number sent via the serial link is 264:

convert to binary 264 decimal = 00100001000 binary,

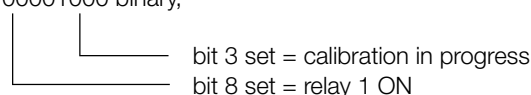

7 COMMUNICATION (continued)

7.2 Communication Between Master and Slaves

The commands from the master are coded as single characters as follows:

R = 'Read' (read parameters)

C = 'Change' (used to change parameter values stored in the non-volatile memory †)

W = 'Write' (used to write new parameter values stored in the non-volatile memory †)

S = 'Set' (used to set and reset functions)

†Parameters are stored in the non-volatile memory only if it is enabled, otherwise they are stored in the RAM.

The mnemonics for the EIL8230 ion-selective electrode monitor parameters consist of two characters – see Table 7.1 on page 9. Note that some can be read and changed, some read and set/reset and some can only be read.

7.3 Command Format for Simple Supervisory Systems Using a Computer Terminal (Protocol 1) – Fig. 7.2

Entries are made directly from the computer terminal using the command format shown in Figs. 7.2a, 7.2b and 7.2c for commands 'Read', 'Change/Write' and 'Set', respectively.

Format **term clarification** is as follows:

Command – one character R, C, W or S – see Section 7.2, above.

Instrument Identification – two characters identifying the EIL8230 ion-selective electrode monitor, 01 to 99.

Parameter – two character mnemonic selected from Table 7.1 on page 9.

Sign – one character:

'+' – parameter value is to be increased (not required with 'Write' command)

'-' – Parameter value is to be decreased or is negative

Data – up to five characters (including decimal point) used to write a new parameter value or to specify the amount by which a parameter value is to be increased or decreased.

Block Check Character (BCC) – one character, the arithmetic sum of the complete message (excluding parity bits), transmitted by the computer terminal for error detection – see Appendix A3 on page 22.

Limiter – one character (always '*') signifying the end of data transmission.

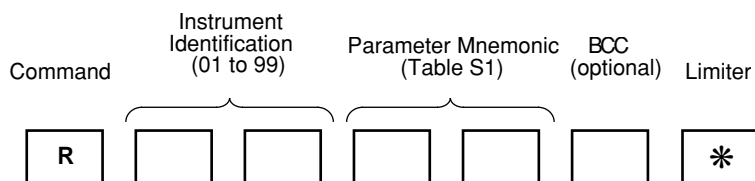

Fig. 7.2a 'Read' Command Format

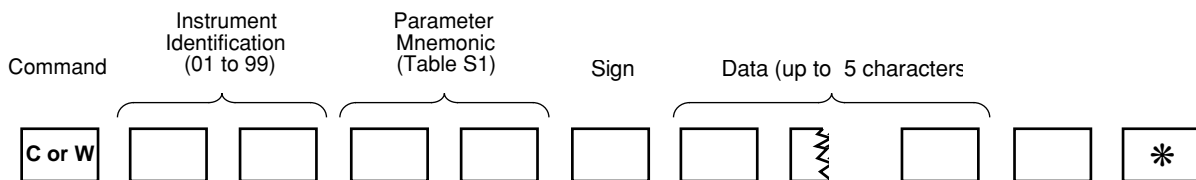

Fig. 7.2b 'Change/Write' Command Format

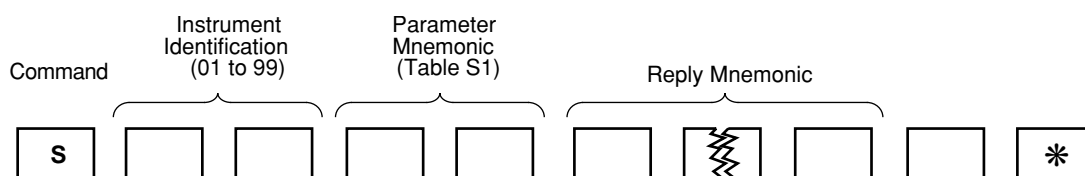

Fig. 7.2c 'Set' Command Format

7.4 Reply Format for Simple Supervisory Systems – Fig.7.3

The EIL8230 ion-selective electrode monitor replies to the command using the reply format shown in Figs. 7.3a and 7.3b for the 'Read/Change/Write' and 'Set' commands, respectively; if the command is understood. Fig. 7.3c shows the reply format for a command that is not understood. Format term clarification is as follows:

Header – one character:

- ':' – message understood
- '?' – message not understood

Instrument Identification – two characters identifying the monitor, 01 to 99.

Parameter – two characters:

- Mnemonic as for the original command
- message understood
- Error code (see Table 7.3 on page 11)
- message not understood

Sign – one character:

- No character – parameter value has been increased or is positive
- '–' – parameter value has been decreased or is negative

Data – up to five characters (including decimal point) showing the new parameter value or the amount by which a parameter value has been increased/decreased.

Error Code – two character mnemonic – see Table 7.3 on page 11.

Block Check Character (BCC) – one character, the arithmetic sum of the complete message (excluding parity bits), transmitted by the

instrument for error detection – see Appendix A3 on page 22.

7.5 Examples of Simple Communication in Protocol 1

The following examples show typical master-to-slave transmissions and the subsequent slave-to-master replies. For **Parameter** and **Error Code** interpretations refer to Tables 7.1 and 7.3, on pages 9 and 11, respectively.

a) Command – **R0111***

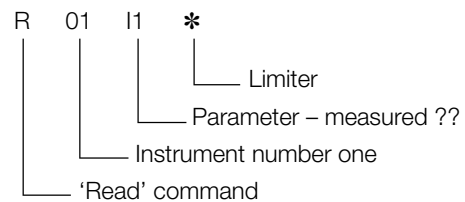

Reply – **:0111500**

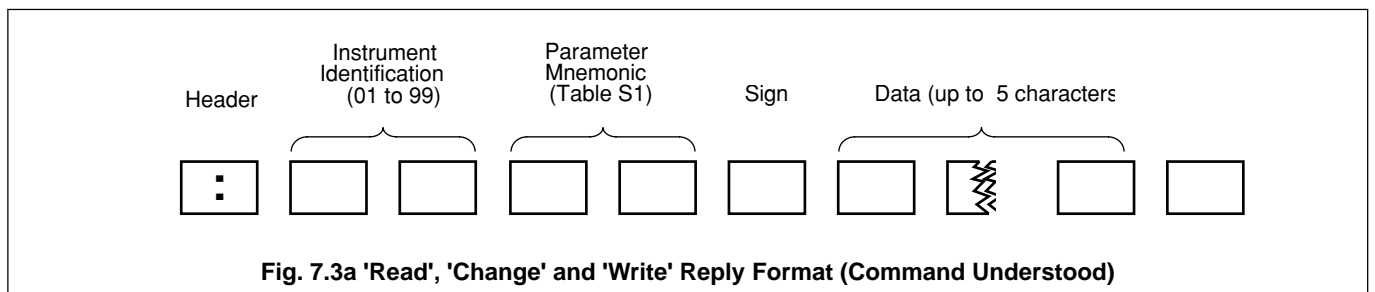
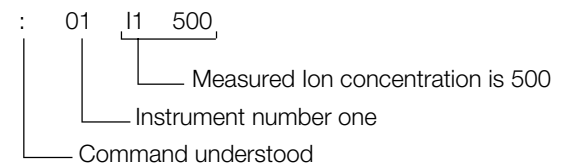

Fig. 7.3a 'Read', 'Change' and 'Write' Reply Format (Command Understood)

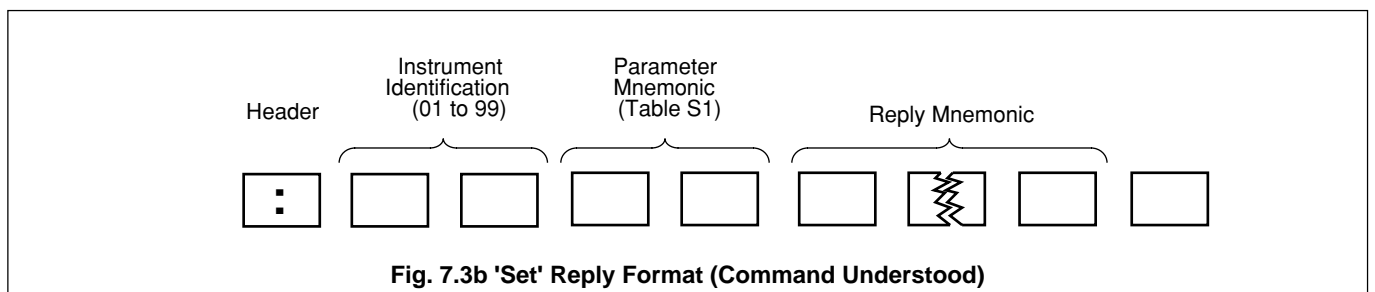

Fig. 7.3b 'Set' Reply Format (Command Understood)

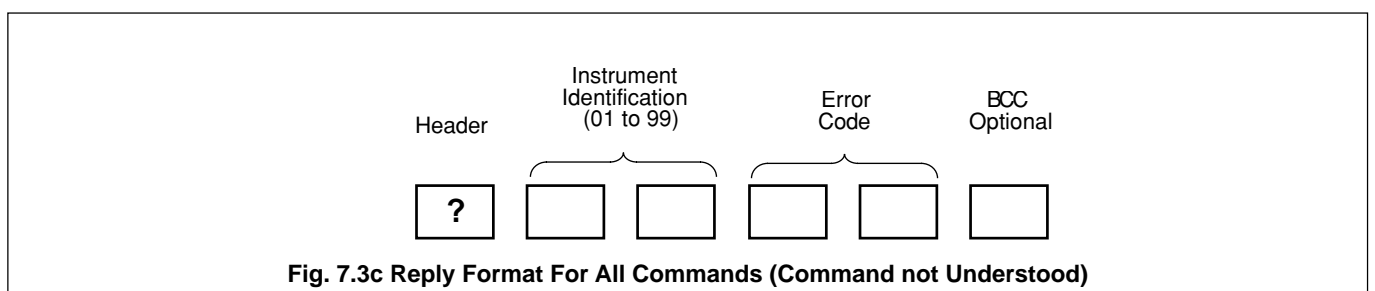
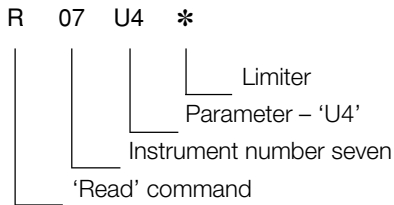
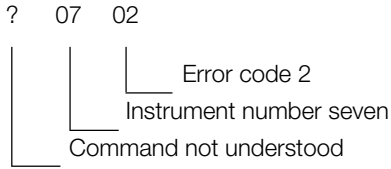

Fig. 7.3c Reply Format For All Commands (Command not Understood)

b) Command – **R07U4***



Reply – **?0702**



i.e. 'U4' in original Command is not a recognised 'Read' parameter – see Table 7.3.

c) Command – **C02S1+20***

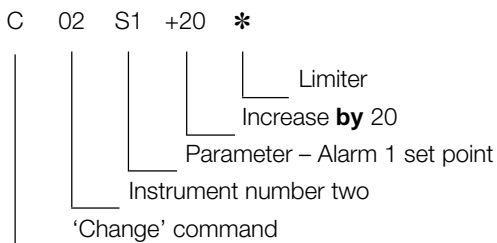

Reply – **:02S1500**

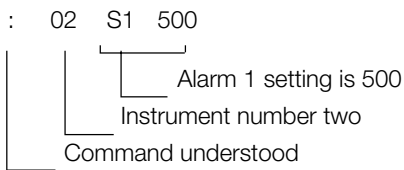

i.e. adding 20 to an original set point setting of 480.

d) Command – **C08S2300***

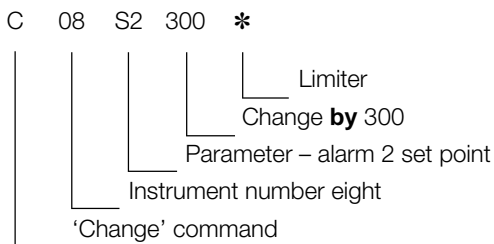

Reply – **?0807**

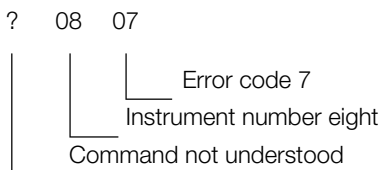

i.e. '300' in original Command must be used with a '+' or '-' sign – see Table 7.3.

e) Command – **S05HMO***

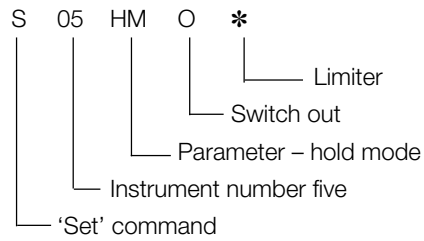

Reply – **:05HMOU**

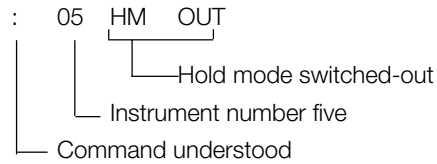

f) Command – **S12S15.00***

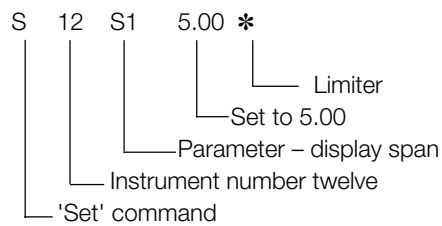

Reply – **?1210**

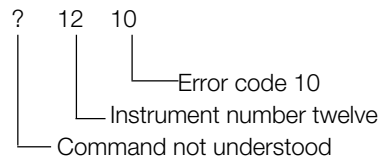

i.e. 'S1' in the original command is not a recognised 'Set' parameter – see Table 7.3.

g) Command – **W17OS100***

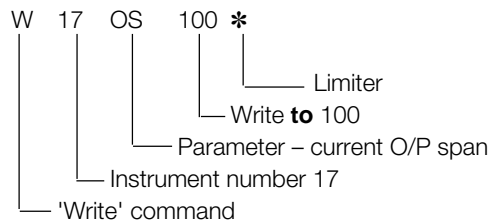

Reply – **:17OS100**

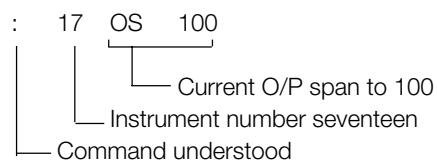

h) Command – **W10SY120***

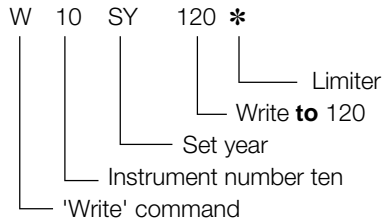

Reply – **?1008**

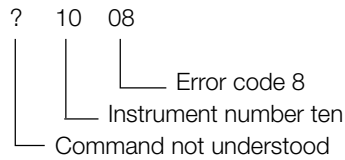

i.e. SY in the original command is outside the limits of 0 to 99

7.6 Command Format for Protocol 2 Using a Host Computer

Protocol 2 is based on ANSI-X3.28-1976-2.5-A4. Entries are made directly from the host computer using the command format shown in Figs. 7.4a, 7.4b and 7.4c for commands 'Read', 'Change/Write' and 'Set', respectively. Format **term clarification** is as follows:

Start – one ASCII control character (always 'STX') signifying the start of transmission.

Command – one character, R, C, W, or S – see **Communication Between Master and Slaves** on page 11.

Instrument Identification – two characters identifying the EIL8230 ion-selective electrode monitor, 01 to 99.

Parameter – two character mnemonic selected from Table 7.1 on page 9.

Sign – one character:

'+' – Parameter value is to be increased (not required with 'Write' command)

'-' – Parameter value is to be decreased or is negative

Data – up to five characters (including decimal point) used to write a new parameter value or to specify the amount by which the parameter value is to be increased or decreased.

Limiter – one character (always 'ETX') signifying the end of data transmission.

Block Check Character (BCC) – one character, the arithmetic sum of the complete message (excluding parity bits), transmitted by the host computer for error detection – see Appendix A3 on page 22.

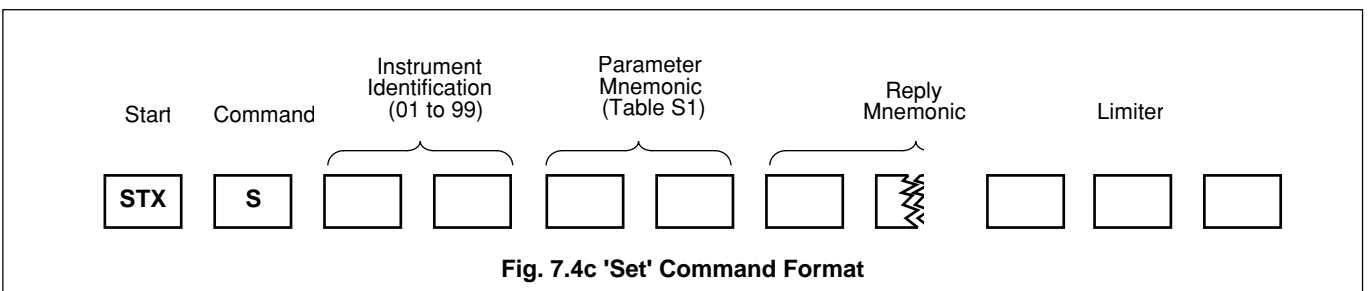
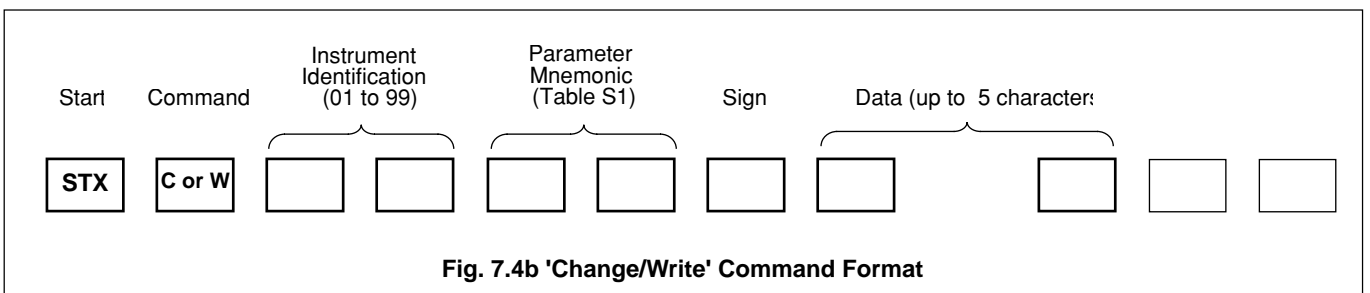
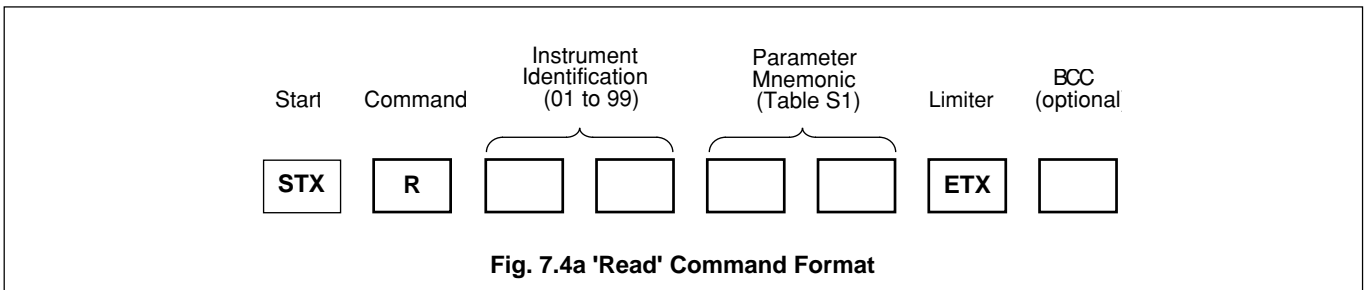

7.7 Reply Format for Protocol 2 Using a Host Computer

The EIL8230 ion-selective electrode monitor replies to the command using the reply format shown in Figs. 7.5a and 7.5b for a command that is understood or is not understood, respectively. Format **term clarification** is as follows:

Instrument Identification – two characters identifying the EIL8230 ion-selective electrode monitor, 01 to 99.

Data – up to five characters (including decimal point) showing the new parameter value or the amount by which a parameter value has been increased/decreased.

Error Code – two character mnemonic – see Table 7.3 on page 11.

Reply – one ASCII control character (see Appendix A1 on page 20).

- 'ACK' – command understood
- 'NAK' – command not understood

Block Check Character (BCC) – one character, the arithmetic sum of the complete message (excluding parity bits), transmitted by the monitor for error detection – see Section 11 on page 20.

7.8 Examples of Complex Communication in Protocol 2

The following examples show typical master-to-slave transmissions and the subsequent slave-to-master replies. For **Parameter** and **Error Code** interpretations refer to Tables 7.1 and 7.3, on pages 9 and 11, respectively.

a) Command – **STXR06RTETX**

STX R 06 RT ETX

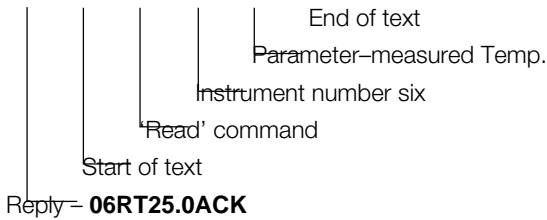

06 RT 25.0 ACK

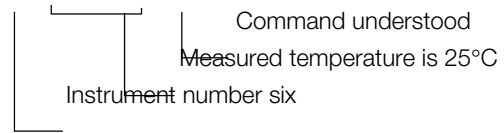

b) Command – **STXR07IXETX**

STX R 07 IX ETX

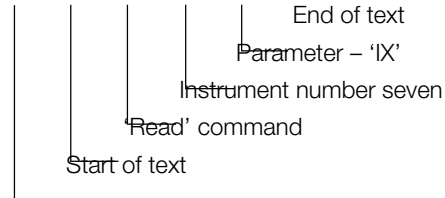

Reply – **0702NAK**

07 02 NAK

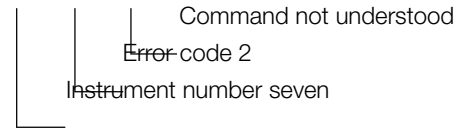

i.e. 'IX' in the original Command is not a recognised 'Read' parameter – see Table 7.3.

c) Command – **STXC03S2-50ETX**

STX C 03 S2 -50 ETX

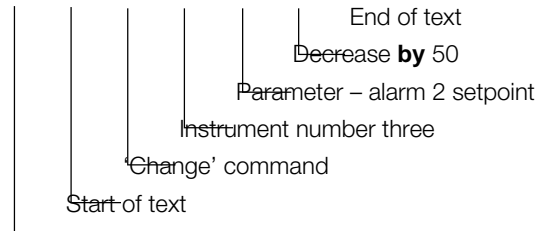

Reply – **03S225.0ACK**

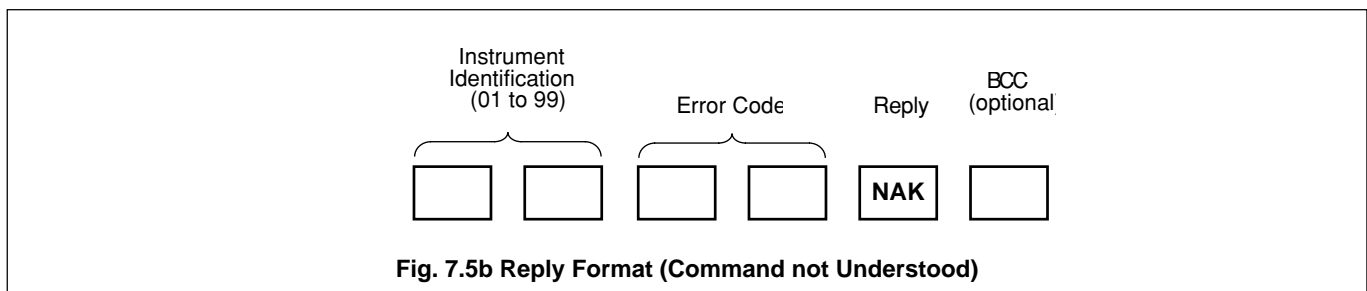
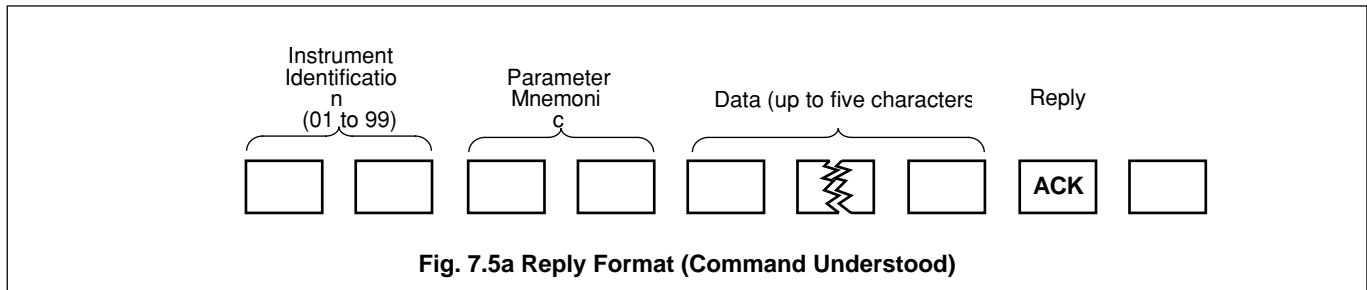

03 S2 25.0 ACK

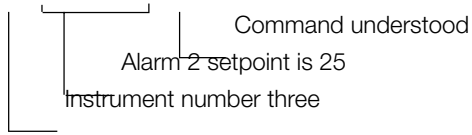

i.e. subtracting 50 from an original alarm 2 set point of 75.

d) Command – **STXC09SD+30ETX**

STX C 09 SD +30 ETX

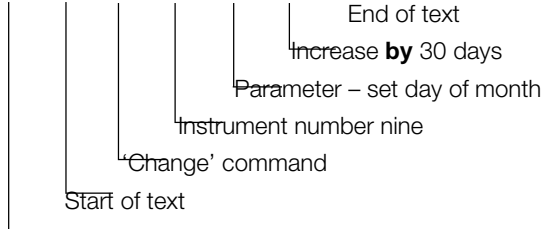

Reply – **0908NAK**

09 08 NAK

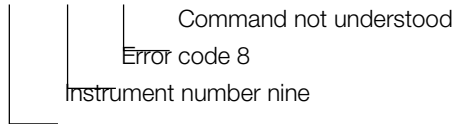

i.e. by adding 30 seconds to the day of the month the day of the month has been exceeded.

e) Command – **STXS16E1YETX**

STX S 16 E1 Y ETX

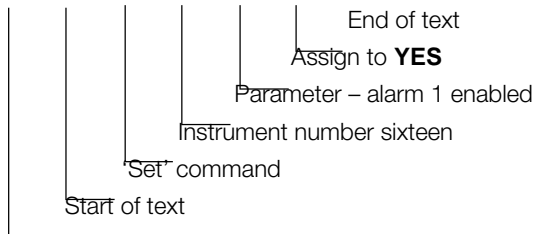

Reply – **16E1 YESACK**

16 E1 YES ACK

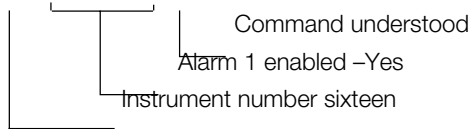

f) Command – **STXS20HFIETX**

STX S 20 HF I ETX

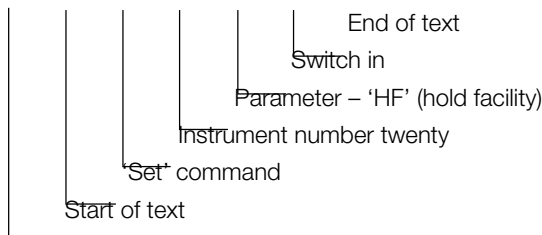

Reply – **2011NAK**

20 11 NAK

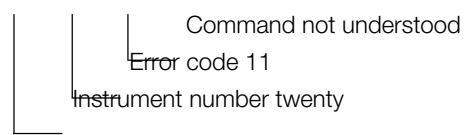

i.e. 'HF' in the original command is not a recognised 'Set' parameter – see Table 7.3. The 'HM' (hold mode) mnemonic is required in this instance.

g) Command – **STXW11S170ETX**

STX W 11 S1 70 ETX

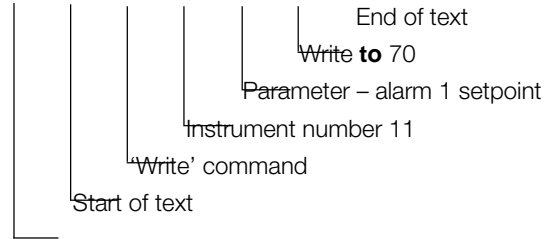

Reply – **11S170ACK**

11 S1 70 ACK

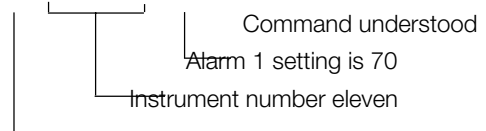

h) Command – **STXW05D120ETX**

STX W 05 D1 20 ETX

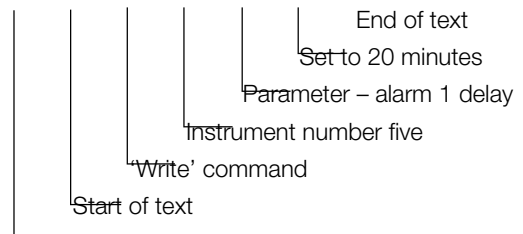

Reply – **0503NAK**

05 03 NAK

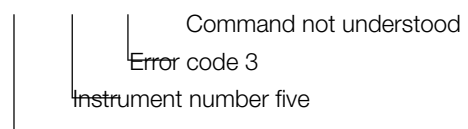

i.e. 'D1' in the original command is not a recognised 'Write' parameter – see Tables 7.1 and 7.3.

8 OPERATION

Before attempting any serial communication, first ensure that the EIL8230 ion-selective electrode monitor(s) connected to the host computer by serial link are functioning correctly. For correct operation refer the the Operating Instructions IM/8230.

N.B. If the digital display is flashing the instrument is in the overrange or underrange condition and the serial link to that particular instrument is disrupted.

Ensure that the serial data connections to EIL8230 ion-selective electrode monitor(s) have been made correctly with respect to the host computer interface. If the above check appears satisfactory, test the serial communication by sending an appropriate message from the host computer to an instrument and observe if the instrument replies; thus establishing communication. If communication is not established, check that the host computer interface is correctly set up and that the plug-in links within each instrument are correctly positioned – see Section 4 on page 4. Check that the parameters programmed in the instrument's **Serial Data Communication Page** are compatible with those of the host computer – see page 6.

N.B. For a **host computer**, e.g. IBM PC or AT, temporarily set the instrument's protocol level to '1' and run the **Simple Basic Communication Programme** – see page 22.

If communication is still not possible, check the serial link voltage levels as detailed under **RS422** and **RS423**, following.

RS422– with the communication link in the 'MARK' condition, i.e. no communication in progress, check the following voltages at the instrument's terminal block:

Terminal 5	—	>3V	} With respect to terminal 8
Terminal 6	—	>3V	
Terminal 7	—	0V	
Terminal 9	—	0V	

If the above voltages are not obtained, check that the host computer interface has pull-up and pull-down resistors connected as shown in Fig. 8.1.

RS423 – with the communication link in the 'MARK' condition, i.e. no communication in progress, check the following voltages at the instrument's terminal block:

Terminal 7	—	<-3V	} With respect to terminal 8
Terminal 9	—	<-3V	

If the above voltages are not obtained, check the host computer interface.

Once serial communication has been established, the application programme for the host computer can be written and entered.

N.B. If no reply is received from the instrument within 500ms, retransmit the command. If after five command re-entries a satisfactory reply has not been received, the communication link has been broken and must be rechecked – see above.

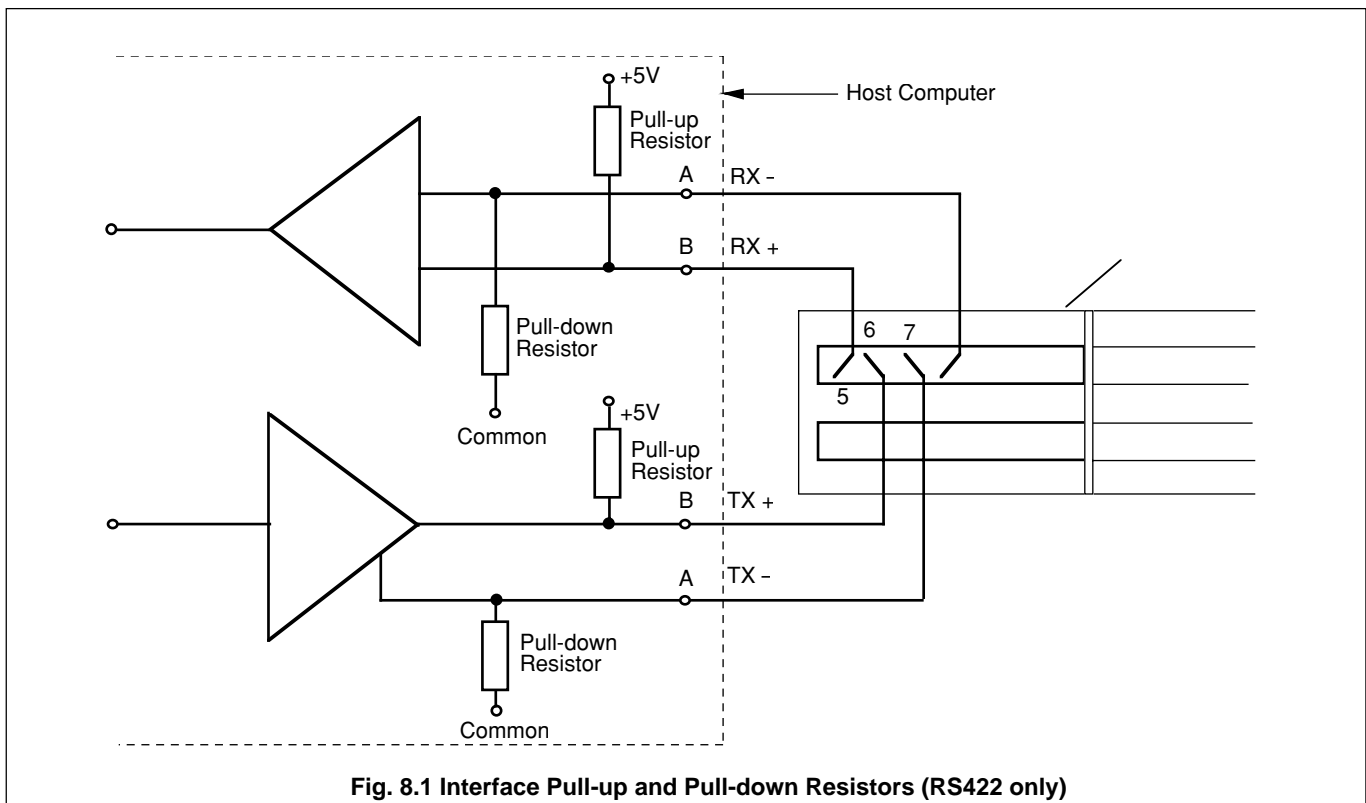

Fig. 8.1 Interface Pull-up and Pull-down Resistors (RS422 only)

9 SPECIFICATION

As detailed in the Operating Instructions (IM/8230), with the following additions:

EIA communication standards RS422 and RS423		
Protocol levels	Simple without echo Complex	} Selectable via front panel switches
Parity	None Odd Even	
Block check character	On Off	
Transmission line length: RS422 RS423	1200m max. 600m max.	
Transmission speeds	1200 baud 2400 baud 4800 baud 9600 baud	} Selectable via plug-in links and front panel switches

10 IDENTIFICATION

Basic Type No.	Version	Current Outputs	Voltage	Current Outputs	Language
Code Characters 1,2	3,4	5	6	7	8
82 Ion-selective Electrode Monitor	31 Fluoride	0 4 to 20mA	0 240V 50/60Hz	1 One current output	0 English
	32 Ammonia	1 0 to 1mA	1 110V 50/60Hz	2 Two current outputs	1 German
	36 Nitrate	2 0 to 10mA 3 0 to 20mA		3 One current output & one serial output	

Table 9.1 Interpretation of Instrument Code Number

APPENDICES

A1 The American Standard Code for Information Interchange (ASCII)

Character	Significance	Decimal	Hexadecimal	Binary
NUL	Null, Operation	0	00	0000000
SOH	Start of Heading	1	01	0000001
STX	Start of Text	2	02	0000010
ETX	End of Text	3	03	0000011
EOT	End of Transmission	4	04	0000100
ENQ	Enquiry	5	05	0000101
ACK	Acknowledgement	6	06	0000110
BEL	Bell	7	07	0000111
BS	Backspace	8	08	0001000
HT	Horizontal Tabulation	9	09	0001001
LF	Line Feed	10	0A	0001010
VT	Vertical Tabulation	11	0B	0001011
FF	Form Feed	12	0C	0001100
CR	Carriage Return	13	0D	0001101
SO	Shift Out	14	0E	0001110
SI	Shift In	15	0F	0001111
DLE	Data Link Escape	16	10	0010000
DC1	Device Control 1	17	11	0010001
DC2	Device Control 2	18	12	0010010
DC3	Device Control 3	19	13	0010011
DC4	Device Control 4	20	14	0010100
NAK	Negative Acknowledge	21	15	0010101
SYN	Synchronous Idle	22	16	0010110
ETB	End of Transm. Block	23	17	0010111
CAN	Cancel	24	18	0011000
EM	End of Medium	25	19	0011001
SUB	Substitute Character	26	1A	0011010
ESC	Escape	27	1B	0011011
FS	File Separator	28	1C	0011100
GS	Group Separator	29	1D	0011101
RS	Record Separator	30	1E	0011110
US	Unit Separator	31	1F	0011111
SP	Space	32	20	0100000
!	33	21	0100001
"	34	22	0100010
#	Number detection	35	23	0100011
\$	Other currency symbol	36	24	0100100
%	37	25	0100101
&	38	26	0100110
'	39	27	0100111
(.....	40	28	0101000
)	41	29	0101001
*	42	2A	0101010
+	43	2B	0101011
,	44	2C	0101100
-	45	2D	0101101
.	46	2E	0101110
/	47	2F	0101111
0	48	30	0110000
1	49	31	0110001
2	50	32	0110010
3	51	33	0110011
4	52	34	0110100
5	53	35	0110101
6	54	36	0110110
7	55	37	0110111
8	56	38	0111000
9	57	39	0111001
:	58	3A	0111010
;	59	3B	0111011
<	60	3C	0111100
=	61	3D	0111101
>	62	3E	0111110
?	63	3F	0111111
@	64	40	1000000

A1 The American Standard Code for Information Interchange (continued)

Character	Significance	Decimal	Hexadecimal	Binary
A	65	41	1000001
B	66	42	1000010
C	67	43	1000011
D	68	44	1000100
E	69	45	1000101
F	70	46	1000110
G	71	47	1000111
H	72	48	1001000
I	73	49	1001001
J	74	4A	1001010
K	75	4B	1001011
L	76	4C	1001100
M	77	4D	1001101
N	78	4E	1001110
O	79	4F	1001111
P	80	50	1010000
Q	81	51	1010001
R	82	52	1010010
S	83	53	1010011
T	84	54	1010100
U	85	55	1010101
V	86	56	1010110
W	87	57	1010111
X	88	58	1011000
Y	89	59	1011001
Z	90	5A	1011010
[.....	91	5B	1011011
\	92	5C	1011100
]	93	5D	1011101
^	94	5E	1011110
--	95	5F	1011111
`	96	60	1100000
a	97	61	1100001
b	98	62	1100010
c	99	63	1100011
d	100	64	1100100
e	101	65	1100101
f	102	66	1100110
g	103	67	1100111
h	104	68	1101000
i	105	69	1101001
j	106	6A	1101010
k	107	6B	1101011
l	108	6C	1101100
m	109	6D	1101101
n	110	6E	1101110
o	111	6F	1101111
p	112	70	1110000
q	113	71	1110001
r	114	72	1110010
s	115	73	1110011
t	116	74	1110100
u	117	75	1110101
v	118	76	1110110
w	119	77	1110111
x	120	78	1111000
y	121	79	1111001
z	122	7A	1111010
{	123	7B	1111011
	124	7C	1111100
}	125	7D	1111101
~	126	7E	1111110
DEL	Delete	127	7F	1111111

A2 Simple Basic Communication Programme

```

10 REM ABB Kent-Taylor Limited
20 REM serial simulation program
30 REM use instruments in protocol 1
40 REM
50 CLS
60 OPEN "COM1:2400,N,8,1,RS,CS,CD,DS" AS 1
70 OPEN "SCRN:" FOR OUTPUT AS 2
80 LOCATE 1,1,1
90 B$=INKEY$: IF B$ < " " THEN PRINT #1,B$;
100 IF EOF(1) THEN 90
110 A$=INPUT$(LOC(1),#1)
120 LFP=0
130 LFP=INSTR(LFP+1,A$,CHR$(10))
140 IF LFP>0 THEN MID$(A$,LFP,1)=" ":GOTO 130
150 PRINT #2,A$;:IF LOC(1)>0 THEN 110
160 GOTO 90
170 CLS
180 CLOSE
190 RESUME

```

Before attempting to communicate using the above programme, first enter a limiter (*) to reset the master / slave communication.

N.B. If the non-volatile memory is used (i.e. NV = enabled) to store any parameter changes made via the serial link to ensure that the information is retained during mains interruption or power-down. The memory used is rated at 10^4 write cycles per register and each register is assigned a particular parameter, e.g. alarm 1 set point, calibration time etc. If the number of write cycles to any particular register exceeds this value, the register's contents may not be retained.

A3 Block Check Characters

The block check character (BCC) transmitted is determined by the seven least significant bits in the binary arithmetic sum of a complete message (excluding parity bits). All characters transmitted before the BCC must be included in the arithmetic sum. Refer to Appendix A1 for ASCII characters.

A3.1 BCC Example for a Simple Supervisory System

(Protocol 1)

Message – W19S1100[BCC]*

Find the ASCII decimal equivalent of each character in the message, calculate the decimal arithmetic sum and hence obtain the binary arithmetic sum.

W	=	87	} Arithmetic sum = 470 decimal = 111010110 binary
1	=	49	
9	=	57	
S	=	83	
1	=	49	
1	=	49	
0	=	48	
0	=	48	

Only the seven least significant bits (LSB) of the binary arithmetic sum are required to determine the BCC:

MSB	LSB
111010110	
└──────────┘	
'V' is the BCC transmitted – see Appendix A1.	

A3.2 BCC Example for a Host Computer Controlled System (Protocol 2)

Message – STXRO3A2ETX[BCC]

Find the ASCII decimal equivalent of each character in the message, calculate the decimal arithmetic sum and hence obtain the binary arithmetic sum.

STX	=	2	} Arithmetic sum = 301 decimal = 100101101 binary
R	=	82	
0	=	48	
3	=	51	
A	=	65	
2	=	50	
ETX	=	3	

Only the seven least significant bits (LSB) of the binary arithmetic sum are required to determine the BCC:

MSB	LSB
100101101	
└──────────┘	
'-' is the BCC transmitted – see Appendix A1.	

Notes.

Notes.

PRODUCTS & CUSTOMER SUPPORT

A Comprehensive Instrumentation Range

Analytical Instrumentation

- **Transmitters**
On-line pH, conductivity, and dissolved oxygen transmitters and associated sensing systems.
- **Sensors**
pH, redox, selective ion, conductivity and dissolved oxygen.
- **Laboratory Instrumentation**
pH and dissolved oxygen meters and associated sensors.
- **Water Analyzers**
For water quality monitoring in environmental, power generation and general industrial applications including: pH, conductivity, ammonia, nitrate, phosphate, silica, sodium, chloride, fluoride, dissolved oxygen and hydrazine.
- **Gas Analyzers**
Zirconia, katharometers, hydrogen purity and purge-gas monitors, thermal conductivity.

Controllers & Recorders

- **Controllers**
Digital display, electronic, pneumatic. Discrete single-loop and multi-loop controllers which can be linked to a common display station, process computer or personal computer.
- **Recorders**
Circular and strip-chart types (single and multi-point) for temperature, pressure, flow and many other process measurements.

Electronic Transmitters

- **Smart & Analog Transmitters**
For draft, differential, gauge and absolute pressure measurement. Also, liquid level and temperature.
- **I to P Converters and Field Indicators**

Flow Metering

- **Magnetic Flowmeters**
Electromagnetic, insertion type probes and watermeters.
- **Turbine Flowmeters**
- **Wedge Flow Elements**
- **Mass Flow Meters**
Transmitters, sensors, controllers and batch/display units.

Level Control

- **Submersible, Capacitance & Conductivity.**

Pneumatic Instrumentation

- **Transmitters**
- **Indicating Controllers**
- **Recording Controllers**

Customer Support

ABB Instrumentation provides a comprehensive after sales service via a Worldwide Service Organization. Contact one of the following offices for details on your nearest Service and Repair Centre.

United Kingdom

ABB Instrumentation Limited
Tel: +44 (0)1480 475321
Fax: +44 (0)1480 470787

United States of America

ABB Automation Inc.
Instrumentation Division
Tel: +1 215-674-6000
Fax: +1 215-674-7183

Italy

ABB Instrumentation SpA
Tel: +39 (0) 344 58111
Fax: +39 (0) 344 58278

Client Warranty

Prior to installation, the equipment referred to in this manual must be stored in a clean, dry environment, in accordance with the Company's published specification. Periodic checks must be made on the equipment's condition.

In the event of a failure under warranty, the following documentation must be provided as substantiation:

1. A listing evidencing process operation and alarm logs at time of failure.
2. Copies of operating and maintenance records relating to the alleged faulty unit.



The Company's policy is one of continuous product improvement and the right is reserved to modify the information contained herein without notice.

© ABB 1999

Printed in UK (9.99)

IM/8230-SER Issue 1

ABB Instrumentation Ltd

St. Neots
Cams.
England, PE19 8EU
Tel: +44 (0) 1480 475321
Fax: +44 (0) 1480 217948

**ABB Automation Inc.
Instrumentation Division**

125 E. County Line Road
Warminster, PA 18974 USA
Tel: +1 215-674-6000
Fax: +1 215-674-7183

ABB Instrumentation SpA

22016 Lenno
Como
Italy
Tel: +39 (0) 344 58111
Fax: +39 (0) 344 58278