

REF620_NAFAAAA3FFxxxAx1xx

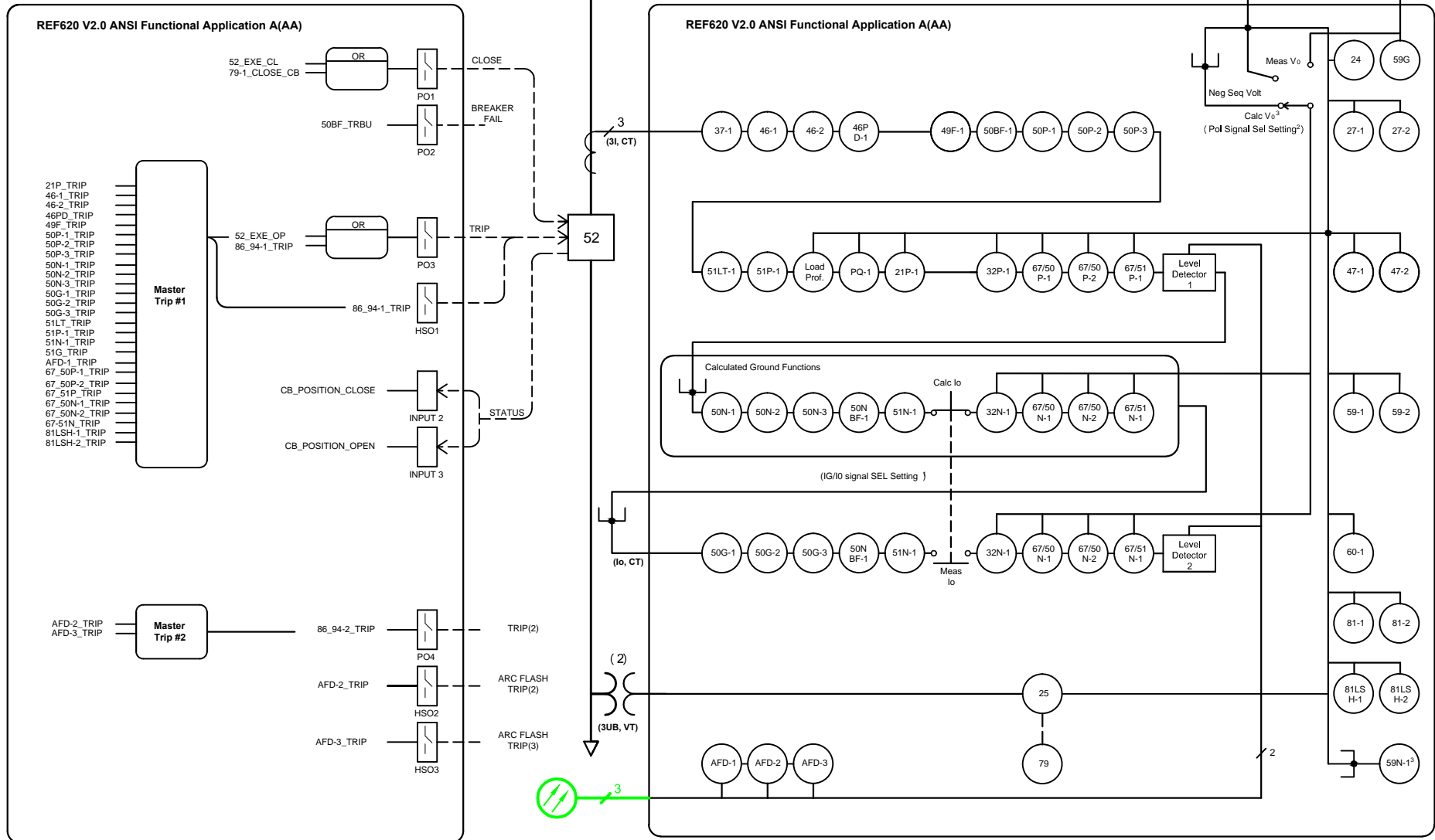

General Note:
 Functions shown in this drawing are for a distribution feeder application (87LOZ REF function is not shown).

- Notes:**
- Latched pushbutton switch emulates drop down menu for "IG/I0 signal Sel" parameter in PCM600. Switch position shown for default setting (Calc Io).
 - Rotary switch emulates drop down menu for "Pol Signal Sel" parameter setting in PCM600. Switch position shown for default setting (Calculated Vo).
 - "Pol Signal Sel" parameter setting Calc Vo, and 59N-1 function not applicable for open delta connected VTs.



REF620_NAFAAAA3FFxxxAx1xx

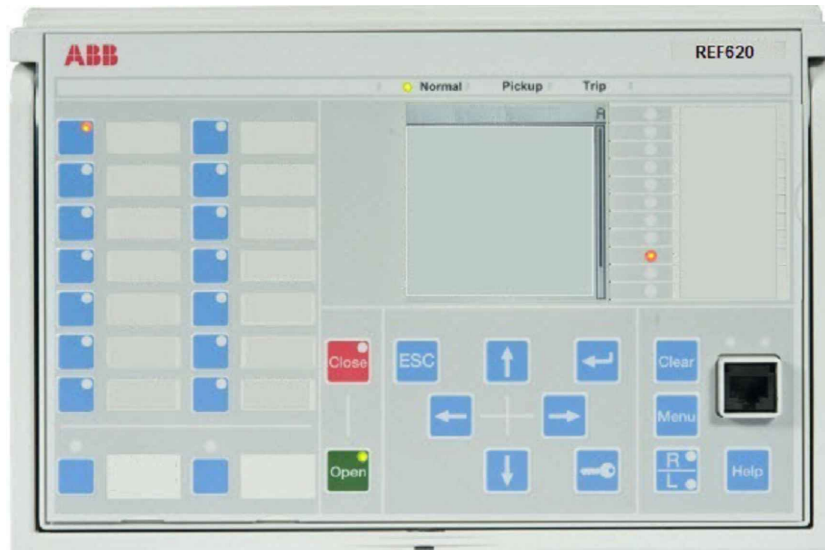

FT-1/TS1
Style No: 837A407G01
Code No: 083

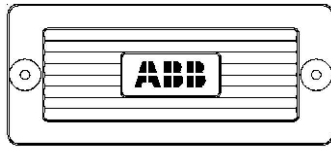

FT-1/TS2
Style No: 129A501G01
Code No: 001

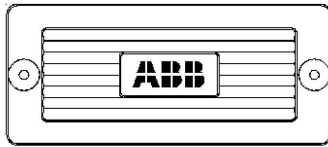

FT-1/TS3
Style No: 129A501G01
Code No: 001

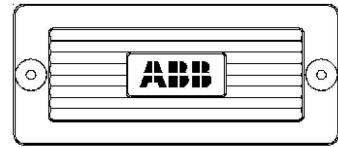

PHASE CURRENT ■ IA
PHASE CURRENT ■ IB
PHASE CURRENT ■ IC
GROUND CURRENT ■ IG
RELAY POS. VDC
RELAY NEG. VDC

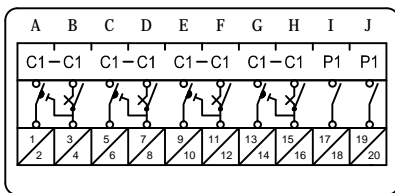

(CURRENTS AND POWER SUPPLY)

52_EXE_CL79-1_CLOSE_CB(PO1)
50BF_TRBU(PO2)
86_94-1_TRIP/82_EXE_OP(PO3)
86_94-2_TRIP(PO4)
86_94-1_TRIP(HSO1)
AFD-2_TRIP(HSO2)
AFD-3_TRIP(HSO3)
CB_POSITION_CLOSE(IN2)
CB_POSITION_OPEN(IN3)
EXTERNAL AR BLOCKING(IN4)

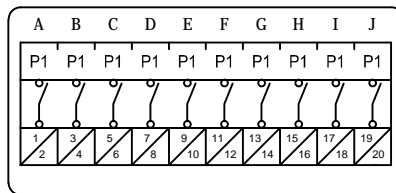

(BINARY I/O AND HIGH SPEED OUTPUTS)

PHASE VOLTAGE ■ VA
PHASE VOLTAGE ■ VB
PHASE VOLTAGE ■ VC
GROUND VOLTAGE ■ VG
SYNCH VOLTAGE ■ VS

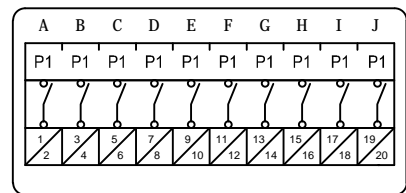

(POTENTIALS)

General Notes:

1. Style and code numbers for FT-1 switches provide black covers and handles, screw terminals and standard depth. Poles selection follows arrangement shown in this drawing set. For custom designs, different selection options can be made by using FT-1 configurator at ft1switch.com
2. Refer to 620 series ANSI Installation Manual for relay and cutout dimensions (Document ID: 1MAC457436-IB, Revision: A, Product version 2.0)

TITLE: **FRONT PANEL ELEVATION**

SOFTWARE TYPE:
AUTOCAD 2014

© Copyright 2015 ABB
All rights reserved
ABB Protective Relays and Switches, Coral Springs FL U.S.A.

SIZE DWG. NO.
A

1MAC505788-DR

REV.
A



RELAY ORDER CODE: **NAFAAAA3FFxxxAx1xx**

SHEET 2 OF 7

REF620_NAFAAAA3FFxxxAx1xx

DC SCHEMATIC: INPUTS

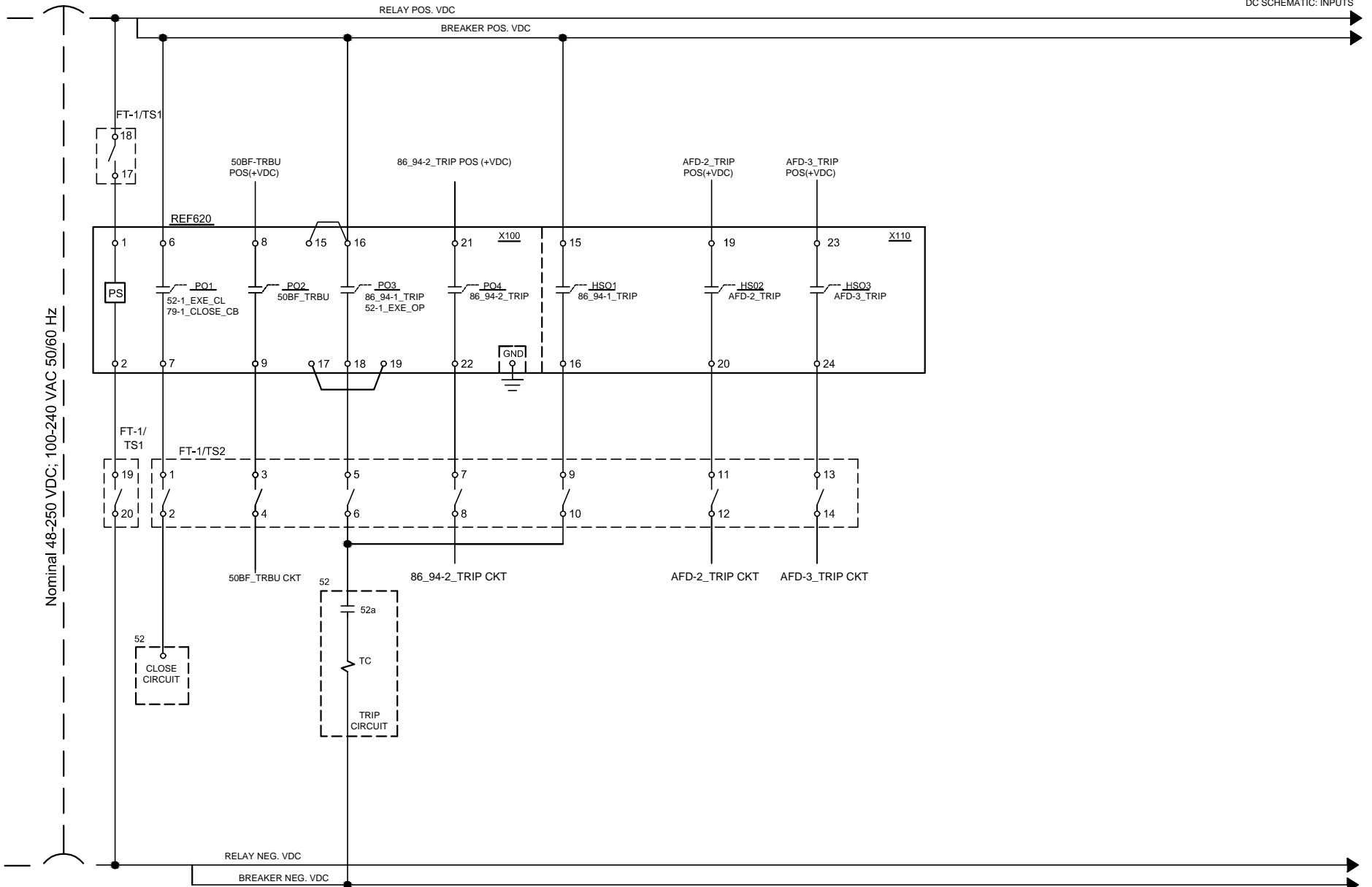

DC SCHEMATIC: INPUTS

General Notes:

1. Binary I/O shown is from default PCM600 Application Configuration Tool (ACT). Connections shown are typical though more connections may be needed for specific application.

2. Connections are Trip Circuit Supervision without an external resistor. For this application the Trip Circuit Monitoring function is blocked when the circuit breaker is open. Refer to technical manual for connections with and external resistor to monitor trip coil when breaker is open or closed.

TITLE: DC SCHEMATIC-PS & OUTPUTS (TYPICAL)

SOFTWARE TYPE:

AUTOCAD 2014

© Copyright 2015 ABB
All rights reserved

SIZE DWG. NO.

A

1MAC505788-DR

REV.

A



RELAY ORDER CODE: NAFAAAA3FFxxxAx1xx

ABB Protective Relays and Switches, Coral Springs FL, U.S.A.

SCALE:

SHEET 4 OF 7

REF620_NAFAAAA3FFxxxAx1xx

DC SCHEMATIC: POWER
SUPPLY
AND OUTPUTS

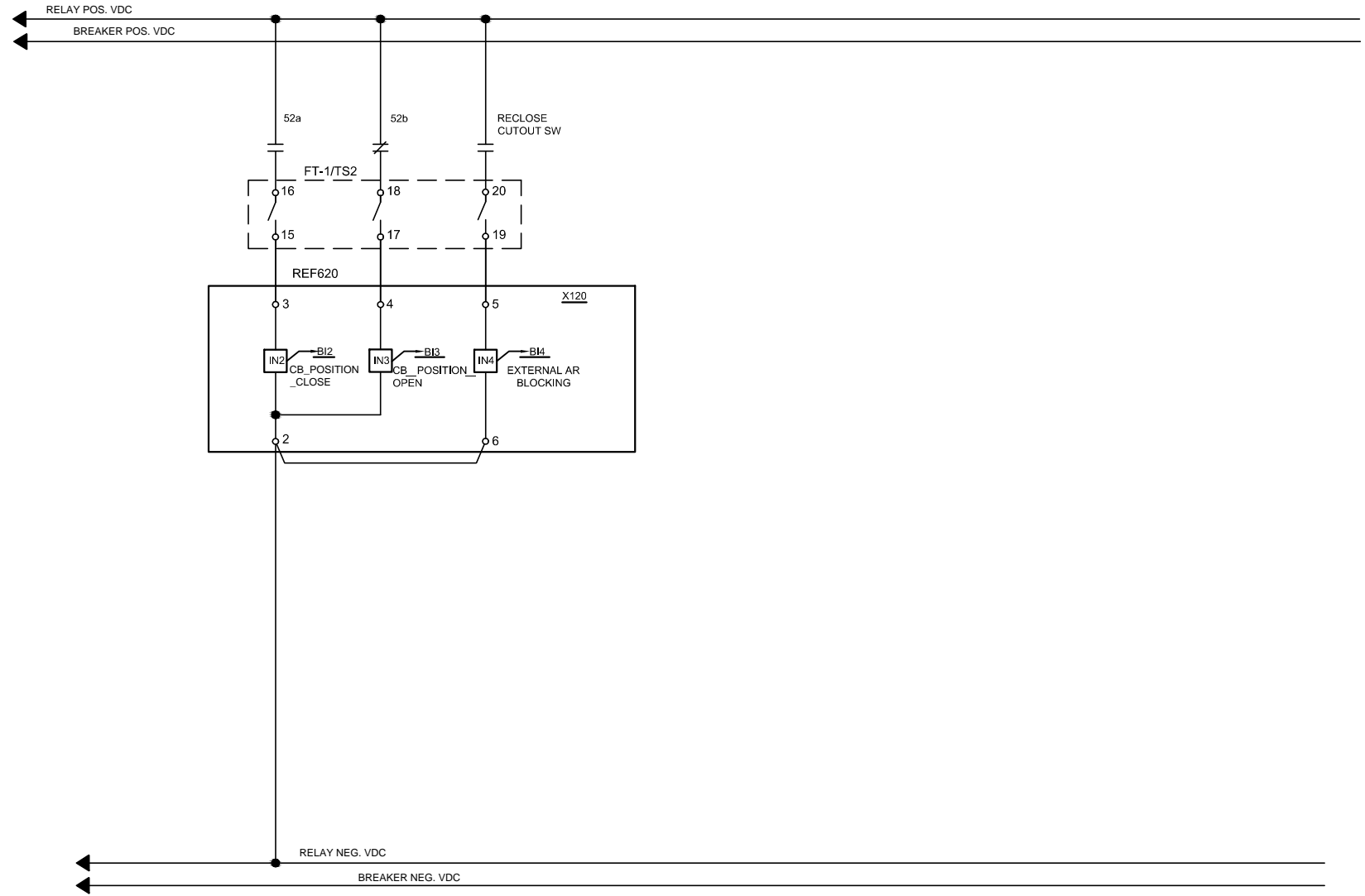

DC SCHEMATIC: POWER
SUPPLY
AND OUTPUTS

TITLE: DC SCHEMATIC - INPUTS (TYPICAL)

RELAY ORDER CODE: NAFAAAA3FFxxxAx1xx

SOFTWARE TYPE:
AUTOCAD 2014

© Copyright 2015 ABB
All rights reserved

SIZE DWG. NO.
A

1MAC505788-DR

REV.
A

ABB Protective Relays and Switches, Coral Springs FL, U.S.A.

SCALE:

SHEET 5 OF 7



REF620_NAFAAAA3FFxxxAx1xx

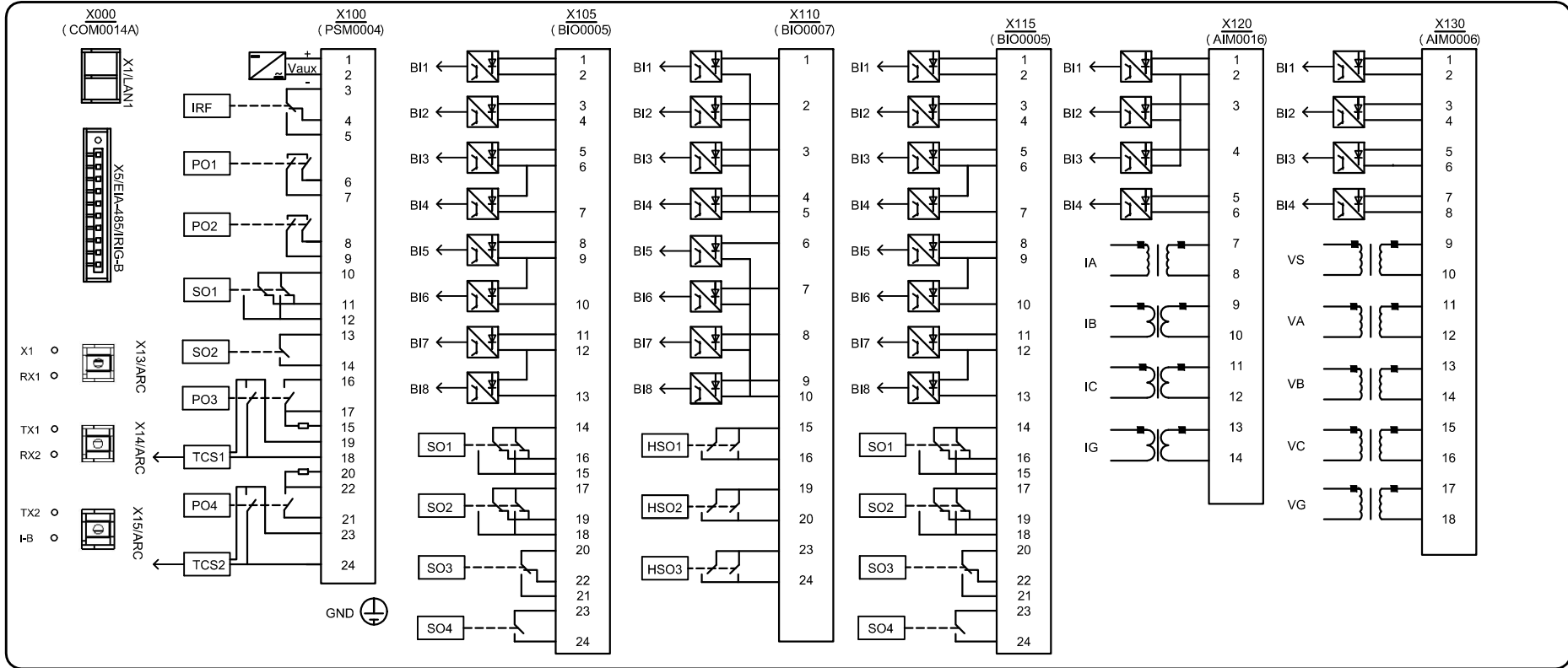

RR
REF620

X000-X1:
X000-X5:
X000-X13:
X000-X14:
X000-X15:

X100-1: UU17
X100-2: UU19
X100-3:
X100-4:
X100-5:
X100-6:
X100-7: TT1
X100-8:
X100-9: TT3
X100-10:
X100-11:
X100-12:
X100-13:
X100-14:
X100-15: X100-16
X100-16: X100-15
X100-17: X100-19
X100-18: TT5
X100-19: X100-17
X100-20:
X100-21:
X100-22: TT7
X100-23:
X100-24:

X105-1:
X105-2:
X105-3:
X105-4:
X105-5:
X105-6:
X105-7:
X105-8:
X105-9:
X105-10:
X105-11:
X105-12:
X105-13:
X105-14:
X105-15:
X105-16:
X105-17:
X105-18:
X105-19:
X105-20:
X105-21:
X105-22:
X105-23:
X105-24:

X110-1:
X110-2:
X110-3:
X110-4:
X110-5:
X110-6:
X110-7:
X110-8:
X110-9:
X110-10:
X110-11:
X110-12:
X110-13:
X110-14:
X110-15:
X110-16: TT9
X110-17:
X110-18:
X110-19:
X110-20: TT11
X110-21:
X110-22:
X110-23:
X110-24: TT13

X115-1:
X115-2:
X115-3:
X115-4:
X115-5:
X115-6:
X115-7:
X115-8:
X115-9:
X115-10:
X115-11:
X115-12:
X115-13:
X115-14:
X115-15:
X115-16:
X115-17:
X115-18:
X115-19:
X115-20:
X115-21:
X115-22:
X115-23:
X115-24:

X120-1:
X120-2: X120-6
X120-3: TT15
X120-4: TT17
X120-5: TT19
X120-6: X120-2
X120-7: UU3
X120-8: UU1
X120-9: UU7
X120-10: UU5
X120-11: UU11
X120-12: UU9
X120-13: UU15
X120-14: UU13

X130-1:
X130-2:
X130-3: TT15
X130-4:
X130-5: TT19
X130-6:
X130-7:
X130-8:
X130-9: SS13
X130-10: SS15
X130-11: SS1
X130-12: X130-14
X130-13: SS3
X130-14: X130-12, X130-16
X130-15: SS5
X130-16: X130-14
X130-17: SS9
X130-18: SS11

GND:

REF620_NAFAAAA3FFxxxAx1xx

RR_X130-10
 RR_X130-9
 RR_X130-18
 RR_X130-17
 RR_X130-15
 RR_X130-13
 RR_X130-11

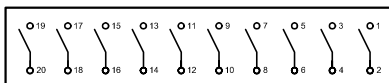

SS
 FT-1/TS3

RR_X120-5
 RR_X120-4
 RR_X120-3
 RR_X110-24
 RR_X110-20
 RR_X110-16
 RR_X100-22
 RR_X100-18
 RR_X100-9
 RR_X100-7

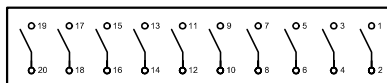

TT
 FT-1/TS2

RR_X100-2
 RR_X100-1
 RR_X120-13
 RR_X120-14
 RR_X120-11
 RR_X120-12
 RR_X120-9
 RR_X120-10
 RR_X120-7
 RR_X120-8

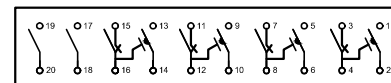

UU
 FT-1/TS1

UU10

UU6, UU16

UU2, UU10

UU6