

OPTIONS FOR ABB DRIVES, CONVERTERS AND INVERTERS

# FAIO-01 analog I/O extension module

## User's manual





# FAIO-01 analog I/O extension module

User's manual

Table of contents



1. Safety instructions



4. Installation



5. Start-up





# Table of contents

---

## **1 Safety instructions**

Contents of this chapter .....	7
Use of warnings .....	7
Safety in installation .....	8

## **2 Introduction to the manual**

Contents of this chapter .....	9
Target audience .....	9
Compatibility .....	9
Terms and abbreviations .....	10

## **3 Hardware description**

Contents of this chapter .....	11
Product overview .....	11
Layout .....	12

## **4 Installation**

Contents of this chapter .....	15
Unpacking and examining the delivery .....	15
Installing the module .....	15
...onto the drive control unit .....	16
...onto an extension adapter module .....	17
Selecting the input mode, voltage range and signal type .....	17
General cabling instructions .....	18
Wiring .....	18
Connection example for motor winding temperature measurement .....	18
Connection example for external devices .....	19

## **5 Start-up**

Contents of this chapter .....	21
Before you start .....	21
Setting the parameters .....	22
Example – Primary control program .....	22

---



## 6 Diagnostics

Contents of this chapter .....	23
Faults and warning messages .....	23
LEDs .....	23

## 7 Technical data

Contents of this chapter .....	25
Data .....	25
Degree of protection .....	25
Ambient conditions .....	25
Package .....	25
Hardware settings .....	26
A/D conversion resolution .....	26
Isolation areas .....	26
Analog inputs and outputs .....	27
Power supply .....	27
General .....	27
Dimensions .....	28

## Further information



# 1

## Safety instructions

---

### Contents of this chapter

The chapter contains the warning symbols used in this manual and the safety instructions which you must obey when you install or connect an optional module to a drive, converter or inverter. If you ignore the safety instructions, injury, death or damage can occur. Read this chapter before you start the installation.

### Use of warnings

Warnings tell you about conditions which can cause injury or death, or damage to the equipment. They also tell you how to prevent the danger. Notes draw attention to a particular condition or fact, or give information on a subject.

The manual uses these warning symbols:





**WARNING!**

Electricity warning tells about hazards from electricity which can cause injury or death, or damage to the equipment.

---



**WARNING!**

General warning tells about conditions, other than those caused by electricity, which can cause injury or death, or damage to the equipment.

---

## Safety in installation

These instructions are for all who install or connect an optional module to a drive, converter or inverter and need to open its front cover or door to do the work.

---



**WARNING!**

Obey these instructions. If you ignore them, injury or death, or damage to the equipment can occur. If you are not a qualified electrical professional, do not do electrical installation or maintenance work. Go through these steps before you begin any installation or maintenance work.

---

- Disconnect the drive, converter or inverter from all possible power sources. After you have disconnected the drive, converter or inverter, always wait for 5 minutes to let the intermediate circuit capacitors discharge before you continue.
  - Disconnect all dangerous voltages connected to other control signal connectors in reach. For example, it is possible that 230 V AC is connected from outside to a relay output or digital input of the drive, converter or inverter.
  - Always use a multimeter to make sure that there are no parts under voltage in reach. The impedance of the multimeter must be at least 1 Mohm.
-



# 2

## Introduction to the manual

---

### Contents of this chapter

This chapter introduces this manual.

### Target audience

This manual is intended for people who plan the installation, install, commission, use and service the extension module. Before you do work on the module, read this manual and the applicable drive, converter or inverter manual that contains the hardware and safety instructions for the product in question.

You are expected to know the fundamentals of electricity, wiring, electrical components and electrical schematic symbols.

The manual is written for readers worldwide. Both SI and imperial units are shown.

### Compatibility

See the appropriate hardware manual.

---

## Terms and abbreviations

Term	Description
Drive	Frequency converter for controlling AC motors
EMC	Electromagnetic compatibility
FAIO-01	Optional analog I/O extension module

## 3

# Hardware description

---

## Contents of this chapter

This chapter gives a short description of the extension module.

## Product overview

The FAIO-01 analog I/O extension module expands the analog inputs and outputs of the drive control unit. It has two bipolar/unipolar current/voltage inputs and two unipolar current outputs. In the bipolar mode, the inputs can handle positive and negative signals. In the unipolar mode, the inputs can handle positive signals only. The way the drive interprets the negative range of the inputs depends on the parameter settings of the drive, see the firmware manual.

FAIO-01 has basic insulation against the drive control unit ground, but together with basic-insulated motor temperature sensors, FAIO-01 forms double insulation. This allows you to measure, for example, motor winding temperature without a double or reinforced insulation requirement on the measuring element.

---



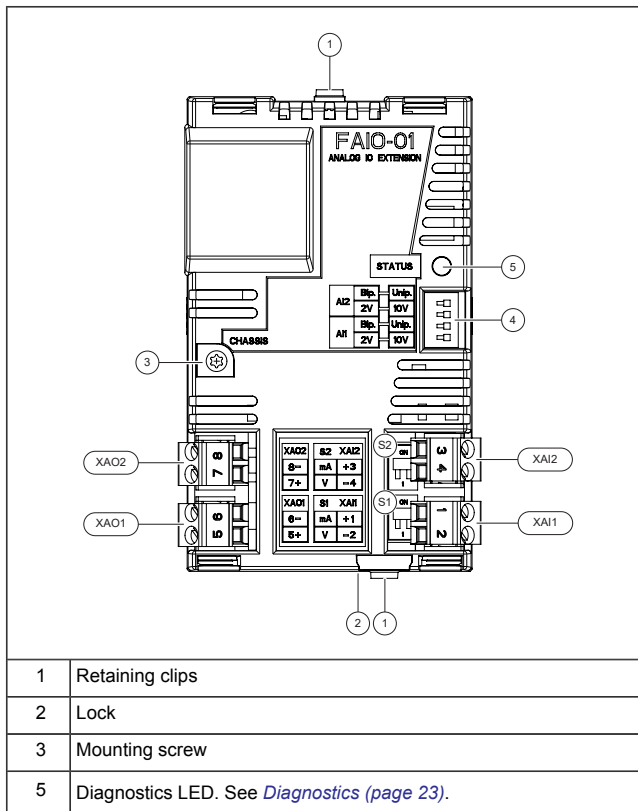

The extension module makes the signal and power connection to the drive through a 20-pin connector.





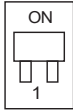

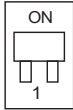

## Layout

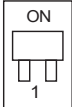

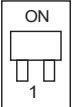
DIP switches			
4	DIP switches for input mode (unipolar or bipolar) and voltage range selection		
S1	DIP switch for XAI1 input signal type selection: current or voltage.		
S2	DIP switch for XAI2 input signal type selection: current or voltage.		
Analog inputs			
XAI1	1	+1	Analog input 1 positive terminal
	2	-2	Analog input 1 negative terminal
XAI2	3	+3	Analog input 2 positive terminal
	4	-4	Analog input 2 negative terminal
Analog outputs			
XAO1	5	+5	Analog output 1 positive terminal
	6	-6	Analog output 1 negative terminal
XAO2	7	+7	Analog output 2 positive terminal
	8	+8	Analog output 2 negative terminal

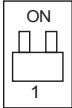
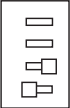
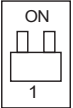
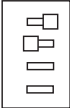
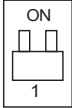
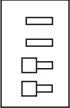
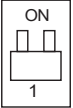
The table below shows the possible current and voltage ranges for the input signals and the corresponding DIP switch positions.

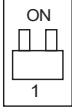
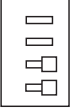
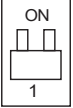
Input signal range	XAI1		XAI2	
	Switch S1	Switches (4) *	Switch S2	Switches (4) *
0 ... 20 mA (default)				

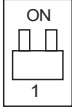
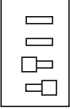
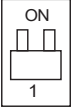
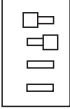
Input signal range	XAI1		XAI2	
	Switch S1	Switches (4) *	Switch S2	Switches (4) *
$\pm 0 \dots 20 \text{ mA}$				
$0 \dots 2 \text{ V}$				
$\pm 0 \dots 2 \text{ V}$				
$0 \dots 10 \text{ V}$				
$\pm 0 \dots 10 \text{ V}$				

\* The voltage range switches are not in use when the corresponding input is operating in the current mode.

## 4

# Installation

---

## Contents of this chapter

This chapter contains a delivery checklist and instructions on installing the extension module.

## Unpacking and examining the delivery

1. Open the option package.
2. Make sure that the package contains:
  - FAIO-01 analog I/O extension module
  - this manual.
3. Make sure that there are no signs of damage.

## Installing the module

---

**WARNING!**

Obey the safety instructions given in chapter *Safety instructions* (page 7). If you ignore the safety instructions,

injury or death, or damage damage to the equipment can occur.

---

■ **...onto the drive control unit**

1. Pull out the lock.
2. Put the module carefully into its position on the drive until the retaining clips lock it into position.
3. Push in the lock.
4. Tighten the screw to 0.8 N·m.

**Note:** The screw tightens the connections and grounds the module. It is necessary for fulfilling the EMC requirements and for proper operation of the module.

---



**WARNING!**

Do not tighten the screw tighter than 0.8 N·m. Too big torque value breaks the thread.

---



See the applicable drive manual for further instructions on how to install the module to the drive.

---



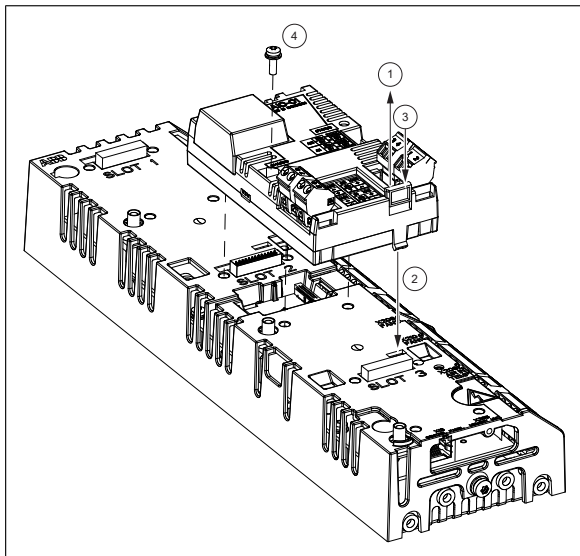

### ■ ...onto an extension adapter module

See *FEA-03 extension adapter module user's manual* (3AUA0000115811 [English]).

## Selecting the input mode, voltage range and signal type

Set the necessary DIP switches to applicable positions. See [Layout \(page 12\)](#). Use a small screwdriver.

## General cabling instructions

Use 0.5 ... 2.5 mm<sup>2</sup> twisted pair shielded cable with an applicable voltage rating.

Do not route signal cables parallel to power cables.

## Wiring

Connect the external control cables to the applicable module terminals.

### ■ Connection example for motor winding temperature measurement

This example shows how to connect three Pt100 sensors for motor temperature measurement between the analog inputs and outputs.

Do not connect both ends of the cable shields directly to ground. If a capacitor cannot be used at one end, leave that end of the shield unconnected.

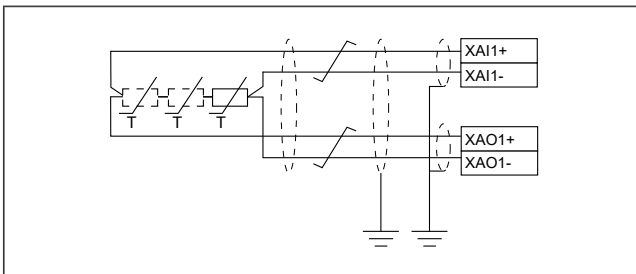

## ■ Connection example for external devices

This example shows how to connect transducers to the analog inputs and indicators to the analog outputs.

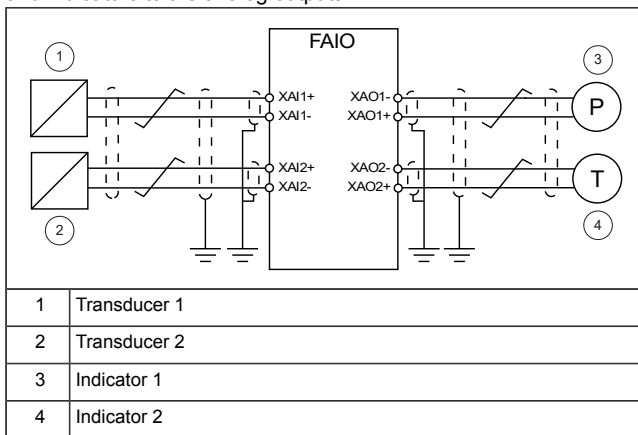



## 5

# Start-up

---

## Contents of this chapter

This chapter contains instructions on starting up the extension module.

### Before you start

1. Make sure that you have set the DIP switches to applicable positions.  
See section *Selecting the input mode, voltage range and signal type (page 17)*.
2. Make sure that you have completed these start-up tasks for the drive:
  - Checks and settings with no voltage connected
  - Powering up the drive
  - Setting up the drive control program.

See the applicable drive hardware manual.

---

## Setting the parameters

The extension module is started up through drive parameters. For example, in ACS880 Primary control program the parameters for I/O extension modules are located in parameter groups 14...16. For other programs, see the applicable firmware manual.

### ■ Example – Primary control program

1. Power up the drive.
2. Specify the slot into which the extension module is installed on the drive control unit (*14.02 Module 1 location*).
3. Activate the communication between the extension module and the drive (*14.01 Module 1 type*).

You can now see the parameters of the extension module in group 14.

4. Make sure that the drive finds the correct extension module (*14.03 Module 1 status*)
5. Set the parameters of the extension module to applicable values. The settings must correspond to the DIP switch settings and the wiring of the extension module.
6. If you want to use an input of the extension module as a signal source, choose the setting *Other* in the source selector parameter, and then specify the applicable value parameter in group 14.

**Example:** To connect supervision 1 to AI1 of the extension module:

- Select the mode of the supervision function (*32.05 Supervision function 1*).
  - Set limits for the supervision function (*32.09 Supervision 1 low* and *32.10 Supervision 1 high*).
  - Select the supervision action (*32.06 Supervision 1 action*).
  - Connect *32.07 Supervision 1 signal* to *14.27 AI1 scaled value*.
7. Set the rest of the required drive parameters to applicable values.

For more detailed information on the parameters, see the drive firmware manual.

---

## 6

# Diagnostics

---

## Contents of this chapter

This chapter shows how to trace faults with the status LEDs on the extension module.

## Faults and warning messages

For the fault and warning messages concerning the extension module, see the drive firmware manual.

## LEDs

The extension module has one diagnostic LED.

Color	Description
Green	The extension module is powered up.
Red	There is no communication with the drive control unit or the extension module has detected some other error.

---





# 7

## Technical data

---

### Contents of this chapter

This chapter contains the technical data of the extension module.

### Data

- **Degree of protection**

IP20

- **Ambient conditions**

The applicable ambient conditions specified for the drive in its manuals are in effect.

- **Package**

Cardboard. Plastic wrapping: Antistatic air bubble sheet (PE).

---

## ■ Hardware settings

- One DIP switch per input for selection between unipolar mode (default) and bipolar mode
- One DIP switch per input for input voltage range selection
- One DIP switch (S1 and S2) per input for selection between current signal (default) or voltage signal

## ■ A/D conversion resolution

- Bipolar mode: 15 data bits (+ 1 sign bit)
- Unipolar mode: 16 data bits

## ■ Isolation areas

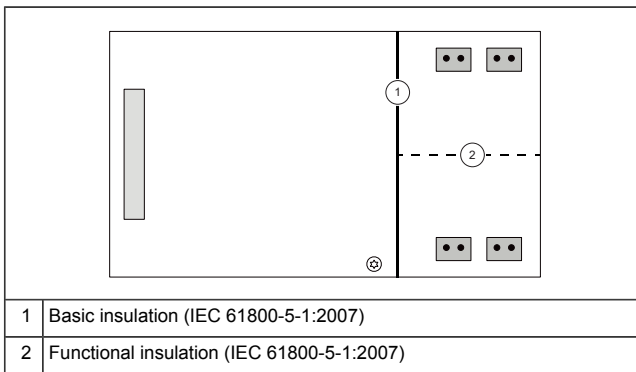

## ■ Analog inputs and outputs

<p>Analog inputs (XAI1:+1...-2, XAI2:+3...-4)</p>	<p>Connector pitch 5 mm, wire size max. 2.5 mm<sup>2</sup></p> <p>Input ranges: (-20) 0...20 mA (default), (-2) 0...2 V, (-10) 0...10 V</p> <p>Input impedance: 100 ohm (current), ≥ 200 ohm (voltage)</p> <p>Inaccuracy: ±0.2% of input and ±0.1% of Full Scale Range at 25 °C</p> <p>Inaccuracy for Pt100 sensors: 5 °C (9 °F)</p> <p>Basic insulation against the control unit ground (earth): functional insulation against the analog outputs</p> <p>Common mode rejection rating (CMRR): ±15 V</p> <p>Hardware filtering time constant: 0.2 ms</p>
<p>Analog outputs (XAO1:+5...-6, XAO2:+7...-8)</p>	<p>Connector pitch 5 mm, wire size max. 2.5 mm<sup>2</sup></p> <p>Output range: 0...20 mA</p> <p>Load resistance max.: 700 ohm</p> <p>Inaccuracy: ±0.2% of output and ±0.1% of Full Scale Range at 25 °C</p> <p>Basic insulation against the control unit ground (earth): functional insulation against the analog inputs</p>

## ■ Power supply

<p>Analog outputs (XAO1:+5...-6, XAO2:+7...-8)</p>	<p>+3.3 V and 24 V (supplied by the drive control unit or the FEA-03 extension adapter module)</p> <p>Max. power consumption: 50 mA at 3.3 V, 0.3 A at 24 V</p>
--	---

## ■ General

- Complies with standards EN 61800-3, EN 61800-5-1, UL508C
- CULus listed
- Printed circuit board conformal coated

## Dimensions

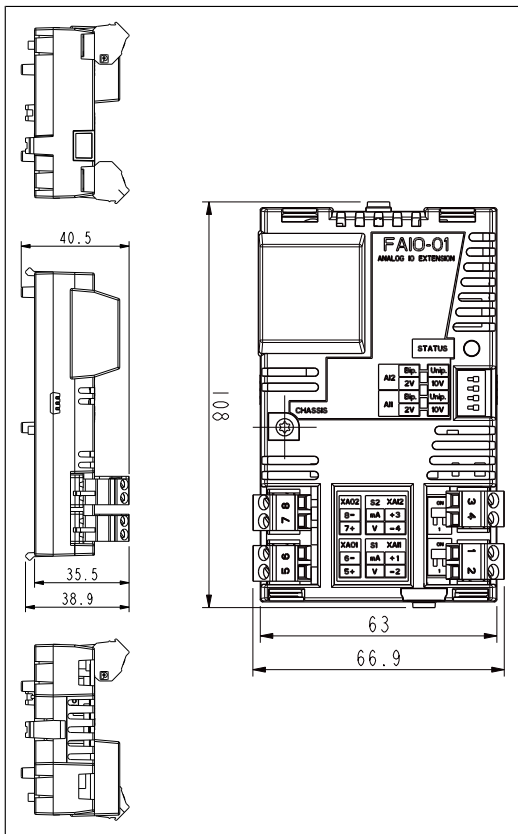

Dimensions in mm

---

## Further information

### Product and service inquiries

Address any inquiries about the product to your local ABB representative, quoting the type designation and serial number of the unit in question. A listing of ABB sales, support and service contacts can be found by navigating to [www.abb.com/searchchannels](http://www.abb.com/searchchannels).

### Product training

For information on ABB product training, navigate to [new.abb.com/service/training](http://new.abb.com/service/training).

### Providing feedback on ABB manuals

Your comments on our manuals are welcome. Navigate to [new.abb.com/drives/manuals-feedback-form](http://new.abb.com/drives/manuals-feedback-form).

### Document library on the Internet

You can find manuals and other product documents in PDF format on the Internet at [www.abb.com/drives/documents](http://www.abb.com/drives/documents).



[www.abb.com/drives](http://www.abb.com/drives)



3AUA0000124968C