

Multifunctional three-phase monitoring relays

CM-MPS

CM-MPS.11 and CM-MPS.31

The three-phase monitoring relays CM-MPS.x1 monitor the phase parameters phase sequence, phase failure, over- and undervoltage as well as phase unbalance.

All devices are available with two different terminal versions. You can choose between the proven screw connection technology (double-chamber cage connection terminals) and the completely tool-free Easy Connect Technology (push-in terminals).

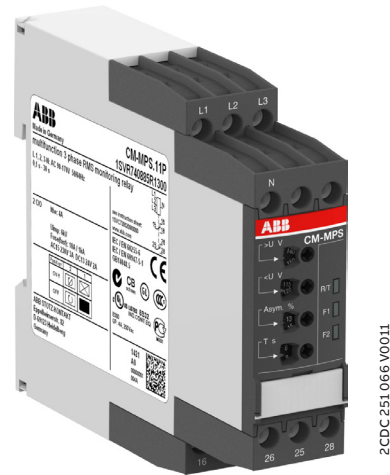

2CDC 251 066 V0011

Characteristics

- Monitoring of three-phase mains for phase sequence (can be switched off), phase failure, over- and undervoltage as well as phase unbalance
- TRMS measuring principle
- Interrupted neutral monitoring (CM-MPS.11)
- CM-MPS.11 can also be used to monitor single-phase mains
- Threshold values for over- and undervoltage as well as phase unbalance are adjustable as absolute values
- Tripping delay T_v can be adjusted or switched off by means of a logarithmic scale (0 s; 0.1-30 s)
- ON-delayed or OFF-delayed tripping delay selectable
- Powered by the measuring circuit
- Precise adjustment by front-face operating controls
- Screw connection technology or Easy Connect Technology available
- Housing material for highest fire protection classification UL 94 V-0
- Tool-free mounting on DIN rail as well as demounting
- 2 c/o (SPDT) contacts
- 22.5 mm (0.89 in) width
- 3 LEDs for the indication of operational states

Order data

Three-phase monitoring relays

Type	Rated control supply voltage = measuring voltage	Interrupted neutral monitoring	Connection technology	Order code
CM-MPS.11P	3 x 90-170 V AC	yes	Push-in terminals	1SVR740885R1300
CM-MPS.11S		yes	Screw terminals	1SVR730885R1300
CM-MPS.31P	3 x 160-300 V AC	no	Push-in terminals	1SVR740884R1300
CM-MPS.31S		no	Screw terminals	1SVR730884R1300

Accessories

Type	Description	Order code
ADP.01	Adapter for screw mounting	1SVR430029R0100
MAR.12	Marker label for devices with DIP switches	1SVR730006R0000
COV.11	Sealable transparent cover	1SVR730005R0100

Connection technology

Maintenance free Easy Connect Technology with push-in terminals

Type designation CM-xxS.yyP

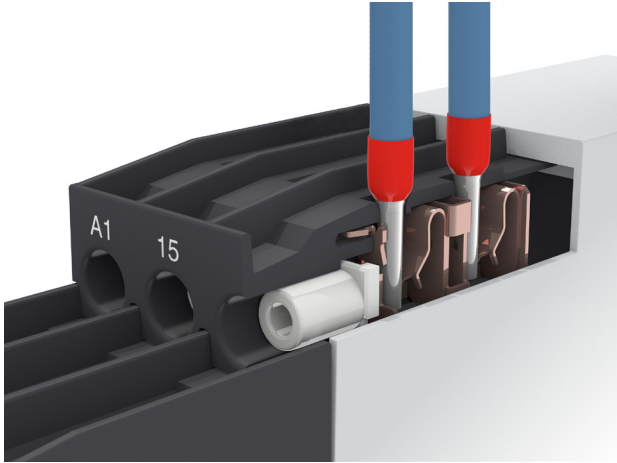

Push-in terminals

- Tool-free connection of rigid and flexible wires with wire end ferrule
- Easy connection of flexible wires without wire end ferrule by opening the terminals
- No retightening necessary
- One operation lever for opening both connection terminals
- For triggering the lever and disconnecting of wires you can use the same tool (Screwdriver according to DIN ISO 2380-1 Form A 0.8 x 4 mm (0.0315 x 0.157 in), DIN ISO 8764-1 PZ1 \varnothing 4.5 mm (0.177 in))
- Constant spring force on terminal point independent of the applied wire type, wire size or ambient conditions (e. g. vibrations or temperature changes)
- Opening for testing the electrical contacting
- Gas-tight

Approved screw connection technology with double-chamber cage connection terminals

Type designation CM-xxS.yyS

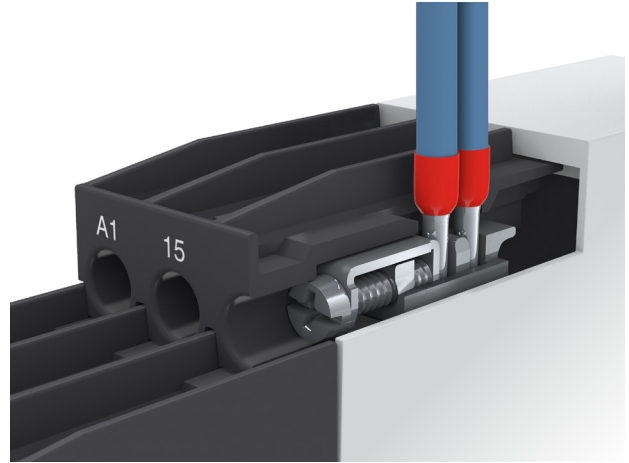

Double-chamber cage connection terminals

- Terminal spaces for different wire sizes
- One screw for opening and closing of both cages
- Pozidrive screws for pan- or crosshead screwdrivers according to DIN ISO 2380-1 Form A 0.8 x 4 mm (0.0315 x 0.157 in), DIN ISO 8764-1 PZ1 \varnothing 4.5 mm (0.177 in)

Both the Easy Connect Technology with push-in terminals and screw connection technology with double-chamber cage connection terminals have the same connection geometry as well as terminal position.

Functions

Operating controls

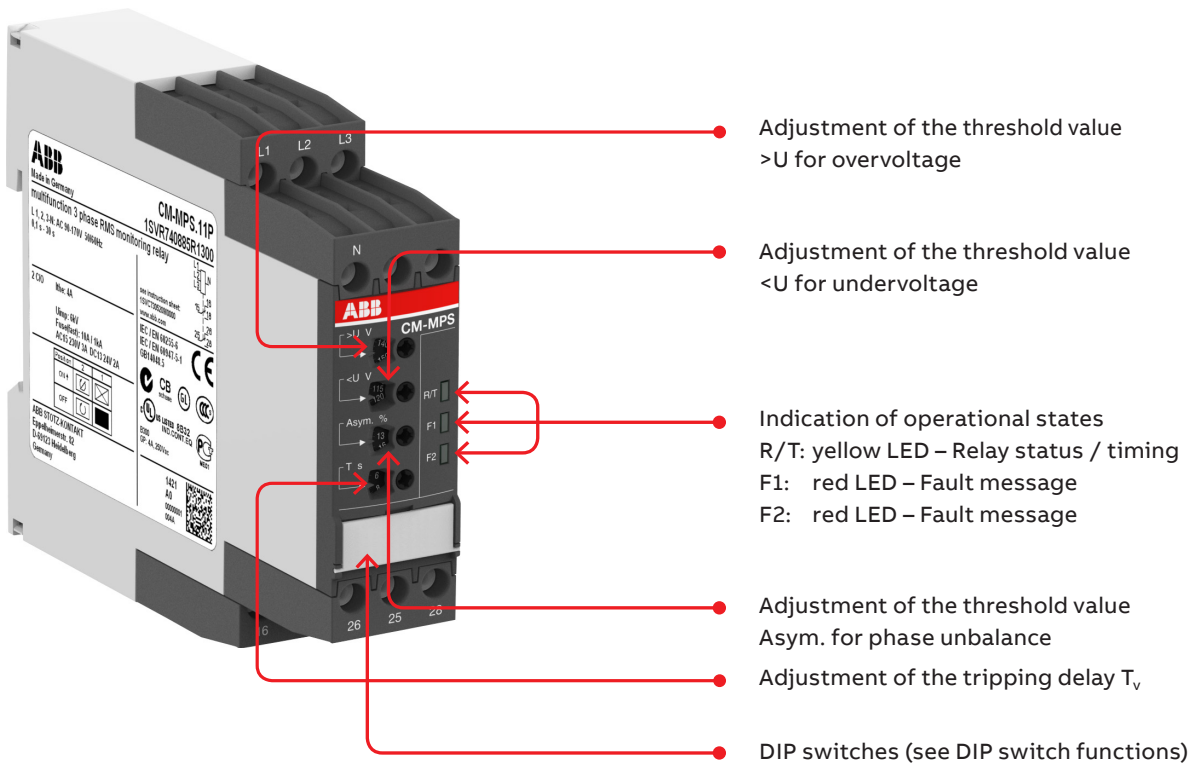

Application

The three-phase monitoring relays CM-MPS.x1 are designed for use in three-phase mains for monitoring the phase parameters phase sequence, phase failure, over- and undervoltage as well as phase unbalance. The CM-MPS.11 also monitors the neutral for interruption and is suitable for monitoring single-phase mains.

The CM-MPS.x1 provide an adjustable tripping delay and work according to the closed-circuit principle.

Operating mode

The CM-MPS.x1 have 2 c/o (SPDT) contacts and are available for 3-wire AC systems (CM-MPS.31) and 4-wire AC systems (CM-MPS.11).

The units are adjusted with front-face operating controls. The selection of ON- or OFF- delay and phase sequence monitoring activated or phase sequence monitoring deactivated is made with DIP switches. Potentiometers, with direct reading scale, allow the adjustment of the threshold values for overvoltage ($>U$), undervoltage ($<U$), phase unbalance (Asym. %) and the tripping delay T_v . The tripping delay T_v is adjustable over a range of instantaneous to a 30 s delay. Timing is displayed by a flashing yellow LED labelled R/T.

For monitoring single-phase mains, all three external conductors (L1, L2, L3) have to be jumpered and connected as one single conductor. Phase sequence monitoring has to be deactivated and the threshold value for phase unbalance has to be set to the maximum (25 %).

Adjustment potentiometer

Threshold values

By means of three separate potentiometers with direct reading scales, the threshold values for over- and undervoltage as well as for phase unbalance can be adjusted within the measuring range.













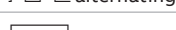

	Measuring range for overvoltage	Measuring range for undervoltage	Measuring range for phase unbalance
CM-MPS.11	3 x 120-170 V AC	3 x 90-130 V AC	2-25 % of average of phase voltages
CM-MPS.31	3 x 220-300 V AC	3 x 160-230 V AC	

Tripping delay T_v

The tripping delay T_v can be adjusted within a range of 0.1 to 30 s by means of a potentiometer with logarithmic scale. By turning to the left stop, the tripping delay can be switched off.

Indication of operational states

LEDs, status information and fault messages

Operational state	R/T: LED yellow	F1: LED red	F2: LED red
Control supply voltage applied, output relay energized		-	-
Tripping delay T_v active		-	-
Phase failure	-		
Phase sequence	-	 alternating	
Overvoltage	-		-
Undervoltage	-	-	
Phase unbalance	-		
Interruption of the neutral	-		
Adjustment error ¹⁾			

¹⁾

Possible misadjustments of the front-face operating controls:

Overlapping of the threshold values: The threshold value for overvoltage is set to a smaller value than the threshold value for undervoltage.

DIP switch 3 = OFF and DIP switch 4 = ON: Automatic phase sequence correction is activated and selected operating mode is 1 x 2 c/o (SPDT) contacts.

DIP switch 2 and 4 = ON: Phase sequence detection is deactivated and the automatic phase sequence correction is activated.

Function descriptions / diagrams

Interrupted neutral monitoring

The interruption of the neutral in the main to be monitored is detected by means of phase unbalance evaluation. If the star point is displaced by asymmetrical load in the three-phase main, an interrupted neutral will be detected. Determined by the system, in case of unloaded neutral, i.e. symmetrical load between all three phases, it may happen that an interruption of the neutral will not be detected.

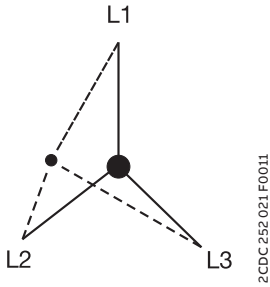

Phase sequence and phase failure monitoring

Applying control supply voltage begins the fixed start-up delay T_s . When T_s is complete and all phases are present with correct voltage, the output relays energize and the yellow LED R/T is on.

Phase sequence monitoring

If phase sequence monitoring is activated (DIP switch 2 = OFF), the output relays de-energize as soon as a phase sequence error occurs. The fault is displayed by alternated flashing of the LEDs F1 and F2. The output relays re-energize automatically as soon as the phase sequence is correct again.

If phase sequence monitoring is deactivated (DIP switch 2 = ON), a phase sequence error will not cause tripping of the relays. The output relays do not change state and the LEDs F1 and F2 don't flash.

Phase failure monitoring

The output relays de-energize instantaneously if a phase failure occurs. The fault is indicated by lighting up of LED F1 and flashing of LED F2. The output relays re-energize automatically as soon as the voltage returns to the tolerance range.

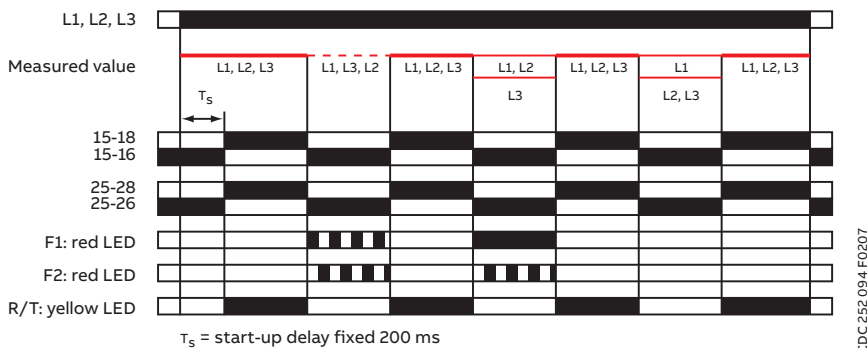

Over- and undervoltage monitoring 1 x 2 c/o (SPDT) contacts 1x2 c/o

Applying control supply voltage begins the fixed start-up delay T_s . When T_s is complete and all phases are present with correct voltage and with correct phase sequence, the output relays energize and the yellow LED R/T is on.

Type of tripping delay = ON-delay ☒

If the voltage to be monitored exceeds or falls below the set threshold value, the output relays de-energize after the set tripping delay T_v is complete. The LED R/T flashes during timing and turns off as soon as the output relays de-energize. The output relays re-energize automatically as soon as the voltage returns to the tolerance range, taking into account a fixed hysteresis of 5 %. The LED R/T is on.

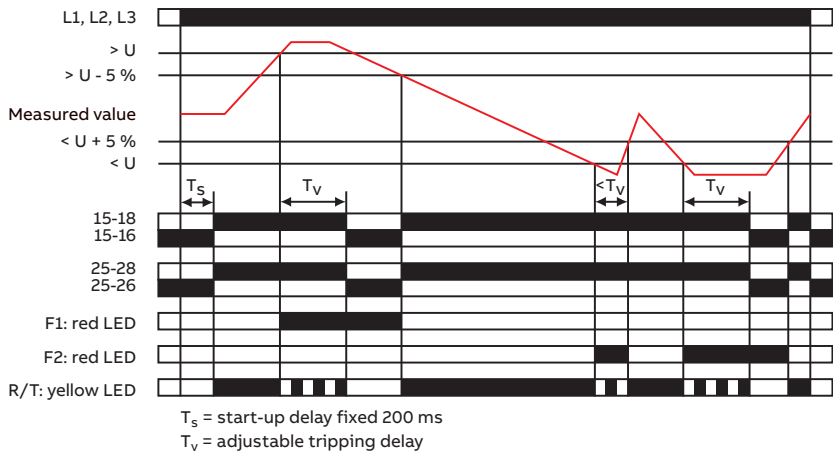

2CDC252 090 F0207

Type of tripping delay = OFF-delay ■

If the voltage to be monitored exceeds or falls below the set threshold value, the output relays de-energize instantaneously and the LED R/T turns off.

As soon as the voltage returns to the tolerance range, taking into account a fixed hysteresis of 5 %, the output relays re-energize automatically after the set tripping delay T_v is complete. The LED R/T flashes during timing and turns steady when timing is complete.

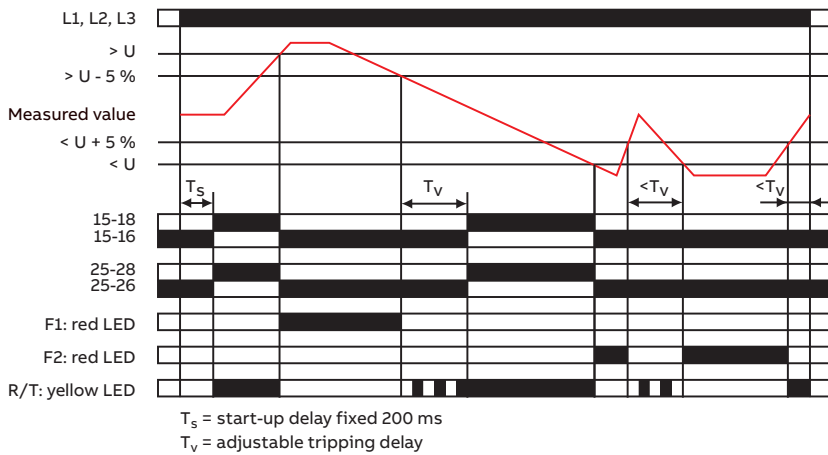

2CDC 252 091 F0207

Phase unbalance monitoring

Applying control supply voltage begins the fixed start-up delay T_s . When T_s is complete and all phases are present with correct voltage and with correct phase sequence, the output relays energize and the yellow LED R/T is on.

Type of tripping delay = ON-delay ☒

If the voltage to be monitored exceeds or falls below the set phase unbalance threshold value, the output relays de-energize after the set tripping delay T_v is complete. The LED R/T flashes during timing and turns off as soon as the output relays de-energize.

The output relays re-energize automatically as soon as the voltage returns to the tolerance range, taking into account a fixed hysteresis of 20 %. The LED R/T is on.

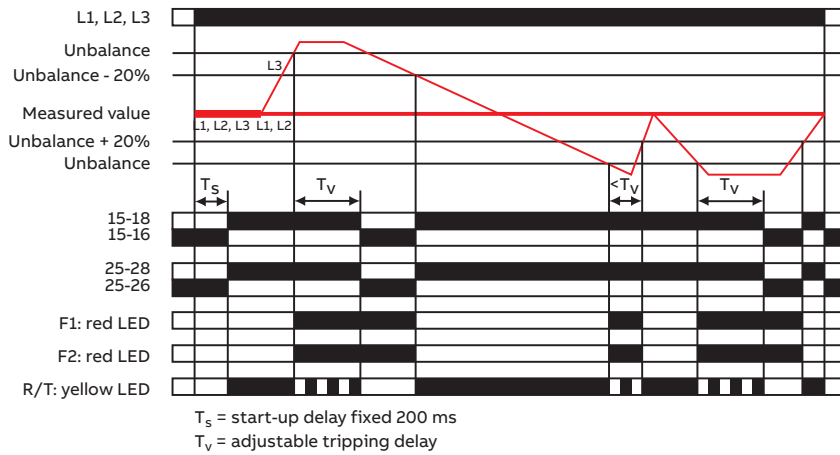

2CDC 252 092 F0207

Type of tripping delay = OFF-delay ■

If the voltage to be monitored exceeds or falls below the set phase unbalance threshold value, the output relays de-energize instantaneously and the LED R/T turns off.

As soon as the voltage returns to the tolerance range, taking into account a fixed hysteresis of 20 %, the output relays re-energize automatically after the set tripping delay T_v is complete. The LED R/T flashes during timing and turns steady when timing is complete.

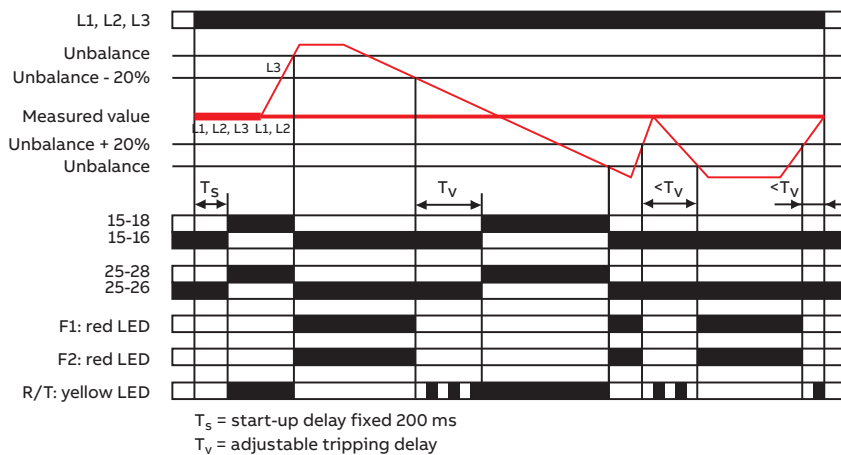

2CDC 252 093 F0207

Electrical connection

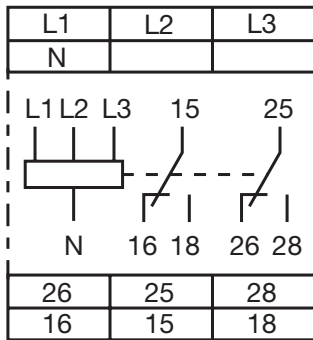

Connection diagram CM-MPS.11

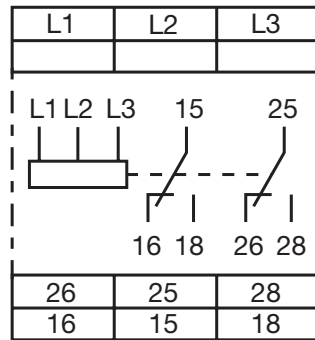

Connection diagram CM-MPS.31

L1, L2, L3, (N) Control supply voltage = measuring voltage
 15-16/18 Output contacts - closed-circuit principle
 25-26/28

DIP switches

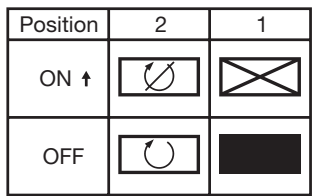

1 Timing function	ON	ON-delayed	In case of a fault, the de-energizing of the output relays and the respective fault message are suppressed for the adjusted tripping delay T_v .
	OFF	OFF-delayed	In case of a fault, the output relays de-energize instantaneously and a fault message is displayed and stored for the duration of the adjusted tripping delay T_v . Thereby, also momentary undervoltage conditions are recognized.
2 Phase sequence monitoring	ON	deactivated	Phase sequence errors will not cause tripping of the relays.
	OFF	activated	The output relays de-energize as soon as a phase sequence error occurs. The output relays re-energize automatically as soon as the phase sequence is correct again.

Technical data

Data at $T_a = 25\text{ °C}$ and rated values, unless otherwise indicated

Input circuit

Type	CM-MPS.11	CM-MPS.31
Supply circuit = measuring circuit	L1, L2, L3, N	L1, L2, L3
Rated control supply voltage U_s = measuring voltage	3 x 90-170 V AC	3 x 160-300 V AC
Rated control supply voltage U_s tolerance	-15...+10 %	
Rated frequency	50/60 Hz	
Frequency range	45-65 Hz	
Typical current / power consumption	25 mA / 10 VA (115 V AC)	25 mA / 10 VA (230 V AC)

Measuring circuit	L1, L2, L3, N	L1, L2, L3	
Monitoring functions	Phase failure	■	
	Phase sequence	can be switched off	
	Automatic phase sequence correction	-	
	Over-/undervoltage	■	
	Phase unbalance	■	
	Interrupted neutral	■	-
Measuring range	Overvoltage	3 x 120-170 V AC	3 x 220-300 V AC
	Undervoltage	3 x 90-130 V AC	3 x 160-230 V AC
	Phase unbalance	2-25 % of average of phase voltages	
Thresholds	Overvoltage	adjustable within measuring range	
	Undervoltage	adjustable within measuring range	
	Phase unbalance (switch-off value)	adjustable within measuring range	
Tolerance of the adjusted threshold value	6 % of full-scale value		
Hysteresis related to the threshold value	Over-/undervoltage	fixed 5 %	
	Phase unbalance	fixed 20 %	
Rated frequency of the measuring signal	50/60 Hz		
Frequency range of the measuring signal	45-65 Hz		
Maximum measuring cycle time	100 ms		
Accuracy within the rated control supply voltage tolerance	$\Delta U \leq 0.5\%$		
Accuracy within the temperature range	$\Delta U \leq 0.06\% / \text{°C}$		
Measuring method	True RMS		

Timing circuit	
Start-up delay T_s	fixed 200 ms
Tripping delay T_v	ON- or OFF-delay 0 s; 0.1-30 s adjustable
Repeat accuracy (constant parameters)	$< \pm 0.2\%$
Accuracy within the rated control supply voltage tolerance	$\Delta t \leq 0.5\%$
Accuracy within the temperature range	$\Delta t \leq 0.06\% / \text{°C}$

User interface

Indication of operational states		
Relay status / timing	R/T	yellow LED
Fault message	F1	red LED
Fault message	F2	red LED

Details see table 'LEDs, status information and fault messages' on page 4 and 'Function descriptions / diagrams' on page 5.

Output circuits

Kind of output	15-16/18 25-26/28	relay, 1st c/o (SPDT) contact relay, 2nd c/o (SPDT) contact 1 x 2 (SPDT) contacts
Operating principle		closed-circuit principle 1)
Contact material		AgNi alloy, Cd free
Rated operational voltage U _e		250 V
Minimum switching voltage / Minimum switching current		24 V / 10 mA
Maximum switching voltage / Maximum switching current		see load limit curves
Rated operational current I _e	AC-12 (resistive) at 230 V	4 A
	AC-15 (inductive) at 230 V	3 A
	DC-12 (resistive) at 24 V	4 A
	DC-13 (inductive) at 24 V	2 A
AC rating (UL 508)	Utilization category (Control Circuit Rating Code)	B 300
	max. rated operational voltage	300 V AC
	max. continuous thermal current at B 300	5 A
	max. making/breaking apparent power at B 300	3600/360 VA
Mechanical lifetime		30 x 10 ⁶ switching cycles
Electrical lifetime	AC-12, 230 V, 4 A	0.1 x 10 ⁶ switching cycles
Maximum fuse rating to achieve short-circuit protection	n/c contact	6 A fast-acting
	n/o contact	10 A fast-acting

General data

MTBF		on request		
Duty time		100 %		
Dimensions		see 'Dimensional drawings'		
Weight		Screw connection technology	Easy Connect Technology (push-in)	
	net weight	CM-MPS.11	0.148 kg (0.326 lb)	0.137 kg (0.302 lb)
		CM-MPS.31	0.142 kg (0.313 lb)	0.133 kg (0.293 lb)
	gross weight	CM-MPS.11	0.173 kg (0.381 lb)	0.162 kg (0.357 lb)
CM-MPS.31		0.167 kg (0.368 lb)	0.158 kg (0.348 lb)	
Mounting		DIN rail (IEC/EN 60715), snap-on mounting without any tool		
Mounting position		any		
Minimum distance to other units		CM-MPS.11	CM-MPS.31	
	horizontal	10 mm (0.39 in) in case of continuous voltage of ...		
		> 120 V	> 220 V	
Material of housing		UL 94 V-0		
Degree of protection	housing	IP50		
	terminals	IP20		

¹⁾ Closed-circuit principle: Output relay(s) de-energize(s) if measured value exceeds or falls below the adjusted threshold value.

Electrical connection

		Screw connection technology	Easy Connect Technology (push-in)
Connecting capacity	fine-strand with(out) wire end ferrule	1 x 0.5-2.5 mm ² (1 x 18-14 AWG) 2 x 0.5-1.5 mm ² (2 x 18-16 AWG)	2 x 0.5-1.5 mm ² (2 x 18-16 AWG)
	rigid	1 x 0.5-4 mm ² (1 x 20-12 AWG) 2 x 0.5-2.5 mm ² (2 x 20-14 AWG)	2 x 0.5-1.5 mm ² (2 x 20-16 AWG)
Stripping length		8 mm (0.32 in)	
Tightening torque		0.6 - 0.8 Nm (7.08 lb.in)	-

Environmental data

Ambient temperature ranges	operation	-25...+60 °C
	storage	-40...+85 °C
Damp heat, cyclic (IEC/EN 60068-2-30)		6 x 24 cycle, 55 °C, 95 % RH
Climatic class		3K3
Vibration, sinusoidal		Class 2
Shock		Class 2

Isolation data

Type		
Rated insulation voltage U_i	input circuit / output circuit	600 V
	output circuit 1 / output circuit 2	300 V
Rated impulse withstand voltage U_{imp}	input circuit / output circuit	6 kV, 1.2/50 μ s
	output circuit 1 / output circuit 2	4 kV, 1.2/50 μ s
Basic insulation	input circuit / output circuit	600 V
Protective separation (IEC/EN 61140, EN 50178)	input circuit / output circuit	yes -
Pollution degree		3
Overvoltage category		III

Standards / Directives

Standards	IEC/EN 60947-5-1, IEC/EN 60255-27, EN 50178
Low Voltage Directive	2014/35/EU
EMC directive	2014/30/EU
RoHS directive	2011/65/EU

Electromagnetic compatibility

Type		CM-MPS.11	CM-MPS.31
Interference immunity to		IEC/EN 61000-6-2	
electrostatic discharge	IEC/EN 61000-4-2	Level 3 (6 kV / 8 kV)	
radiated, radio-frequency, electromagnetic field	IEC/EN 61000-4-3	Level 3 (10 V/m)	
electrical fast transient / burst	IEC/EN 61000-4-4	Level 3 (2 kV / 2 kHz)	
surge	IEC/EN 61000-4-5	Level 4 (2 kV L-N)	Level 4 (2 kV L-L)
conducted disturbances, induced by radio-frequency fields	IEC/EN 61000-4-6	Level 3 (10 V)	
harmonics and interharmonics	IEC/EN 61000-4-13	Class 3	
Interference emission		IEC/EN 61000-6-3	
high-frequency radiated	IEC/CISPR 22, EN 55022	Class B	
high-frequency conducted	IEC/CISPR 22, EN 55022	Class B	

Technical diagrams

Load limit curves

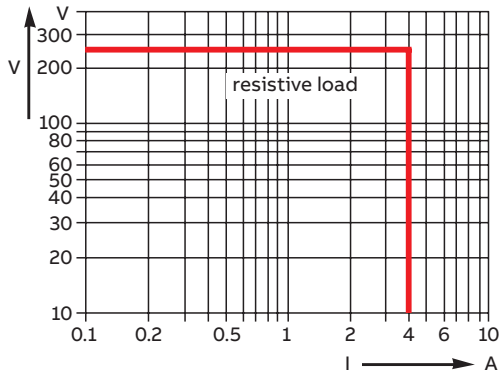

2CDC 252 194 F0205

AC load (resistive)

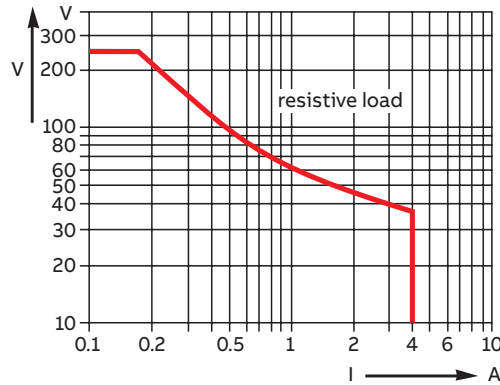

2CDC 252 193 F0205

DC load (resistive)

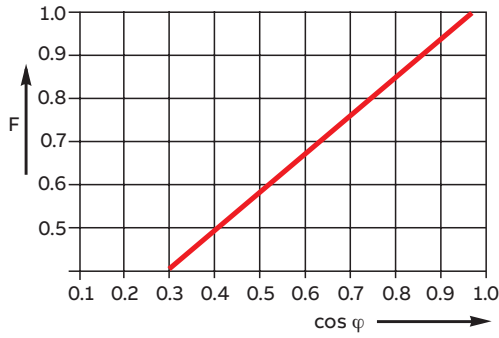

2CDC 252 192 F0205

Derating factor F for inductive AC load

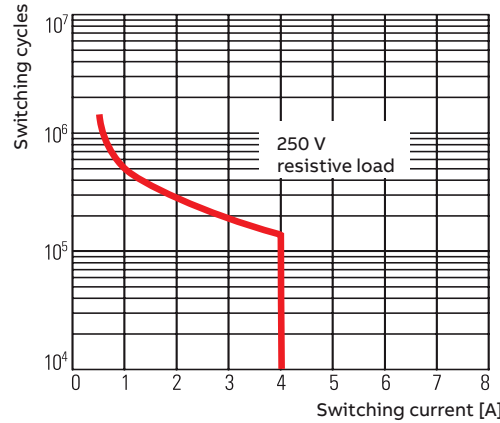

2CDC 252 148 F0206

Contact lifetime

Dimensional drawings

in mm and inches

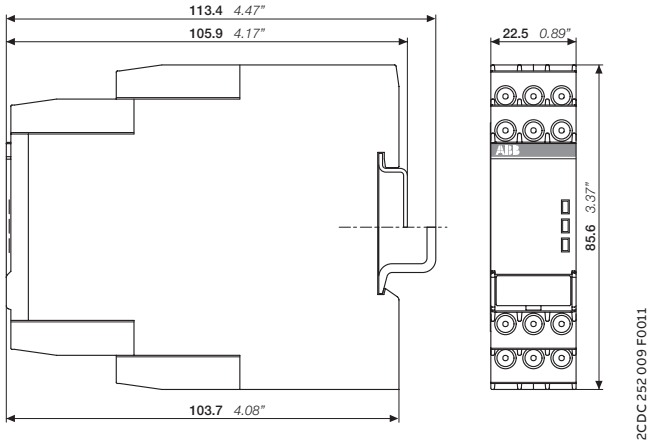

Accessories

in mm and inches

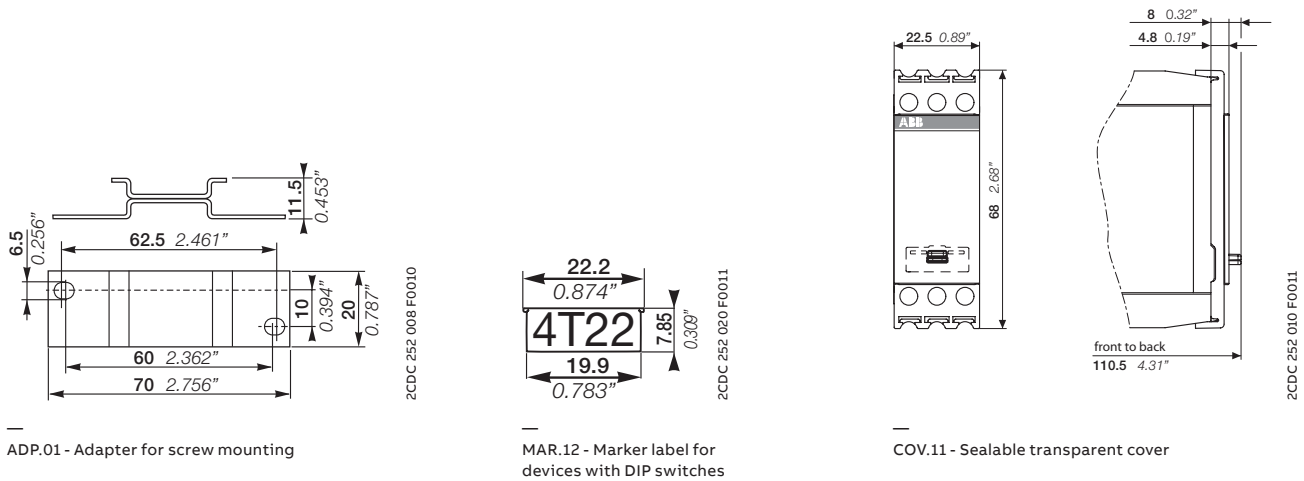

ADP.01 - Adapter for screw mounting

MAR.12 - Marker label for devices with DIP switches

COV.11 - Sealable transparent cover

Further documentation

Document title	Document type	Document number
Electronic relays and controls	Catalog	2CDC 110 004 C02xx
CM-MPS.11, CM-MPS.21, CM-MPS.31, CM-MPS.41	Instruction manual	1SVC 730 530 M0000

You can find the documentation on the internet at www.abb.com/lowvoltage
 -> Automation, control and protection -> Electronic relays and controls -> Measuring and monitoring relays.

CAD system files

You can find the CAD files for CAD systems at <http://abb-control-products.partcommunity.com>
 -> Low Voltage Products & Systems -> Control Products -> Electronic Relays and Controls.



ABB STOTZ-KONTAKT GmbH
Eppelheimer Strasse 82
69123 Heidelberg, Germany

abb.com/lowvoltage

We reserve the right to make technical changes or modify the contents of this document without prior notice. With regard to purchase orders, the agreed particulars shall prevail. ABB Ltd. does not accept any responsibility whatsoever for potential errors or possible lack of information in this document.

We reserve all rights in this document and in the subject matter and illustrations contained therein. Any reproduction, disclosure to third parties or utilization of its contents – in whole or in parts – is forbidden without prior written consent of ABB Ltd. Copyright© 2020 ABB Ltd. All rights reserved