

MT5000 Series Guided wave radar level transmitter

High accuracy
level and interface detection for
liquids, slurries and solids
K-TEK Products



Features

- SIL 2/3 Certified IEC 61508*
- Graphic Display with Waveform Screen
- Widest Selection of Wetted Materials
- Radar Signal Travels Along the Waveguide –
- Eliminates False Echoes and Minimizes Signal Loss
- No Moving Parts
- Rigid, Flexible Cable & Coaxial Probes
- All Digital Electronics
- Loop Powered to 217ft Probe Length
- Total and/or Interface Level Measurement
- Field Replaceable / Upgradable Electronics Module

* transmitters equipped with 4-20mA/HART module option only

Options

- FOUNDATION fieldbus output
- Glass viewing window
- 316 Stainless Steel enclosure
- Remote sensor

Accessories

- External chambers
- Stilling wells
- JDF200 loop indicator
- RI100 Repeat Indicator for 2 4-20mA Output Signals

Specifications for MT5000, MT5100 and MT5200 Transmitters

Electronic transmitter:

| | |
|---|--|
| Resolution | +/- 0.063in. /1.6mm |
| Repeatability | 0.1 in. / 3 mm |
| Ambient Temperature | -40 to 151°F (-40 to 66°C) |
| Measuring accuracy, level | Coax Probe or in stilling well/chamber +/- 3mm |
| | Single cable or rod +/- 5mm to 15.24m (50.0ft)/ +/-25mm to 66m (217ft) |
| Measuring accuracy, interface level and ULD mode | All probes +/- 1.0in / 25mm |
| Supply voltage | 13.5 to 36 Vdc - 4-20mA HART loop powered |
| | 9 to 32 Vdc - FOUNDATION fieldbus |
| Output/Communications | 4-20 mA HART - SIL 2/3 Certified IEC 61508 |
| | FOUNDATION fieldbus - ITK 5.1.0 Compliant - 5 AI and 1 PID blocks - 15.8 mA quiescent current draw - LAS Capable |
| Power consumption | 4-20mA at 36.0 Vdc - 3.6mA 0.13 watts; 21mA 0.76 watts at 13.5 Vdc - 3.6mA 0.046 watts; 21mA 0.28 watts |
| | HART mode (4.0mA) at 36.0 Vdc 0.144 watts at 13.5 Vdc 0.054 watts |
| | FOUNDATION fieldbus 0.5 watts maximum |
| Maximum line resistance | 4-20mA at 36.0 Vdc and 21mA, 1740 ohms* *maximum with HART communication is 700 ohms at 13.5 Vdc and 21mA, 645 ohms |
| | HART mode (4.0mA) < 650 to 700 ohms |
| | FOUNDATION fieldbus 43.6 ohms/km @ 20 C |
| Reverse polarity protection | Diode in series with loop |
| Update rate | 2 outputs per second |
| Damping | Field adjustable, range: 0.1 to 36 seconds |
| Alarm output | NE43, Jumper selectable upscale (21 mA) or downscale (3.6 mA) |
| Humidity | 0 to 100% RH, non-condensing |
| Linearization | 20 point linearization table available |
| Graphic Display | Field Selectable Units in Feet, Inches, Millimeters, Centimeters, Meters or Percentage and Waveform Screens |
| Enclosure | Dual compartment |
| Enclosure material | Cast low copper aluminum with polyester powder coat or 316 stainless steel |
| Electrical connection | 1/2" FNPT, M20 adapter and bus connectors available |
| Ingress protection | IP66, NEMA 4X |

¹ see approval agency restrictions

Specifications

Sensor

| | Standard | Options |
|----------------------------|---|---|
| Material | 316/L stainless steel | 304/L, Hastelloy C-276, Hastelloy B3, Monel 400, Titanium, Inconel625, other materials on request |
| Process temperature | -60 to 400°F (-50 to 204°C), see oring selection | up to to 800°F (427°C) with options |
| Process pressure | -14.5 to 1500psig @ 300°F (103 bar @ 38°C) | -14.5 to 5000 psig (0 to 344barg) |
| Range | 2 to 217 ft. / 0.6 to 66.14 m | |
| Process Connection | 3/4" NPT Standard, other threaded and flanged options available | |
| Dielectric Constant | Minimum 1.4, 1.3 in ULD mode | |
| Process Viscosity | coax 500 cp, single probe 10,000 cp | |

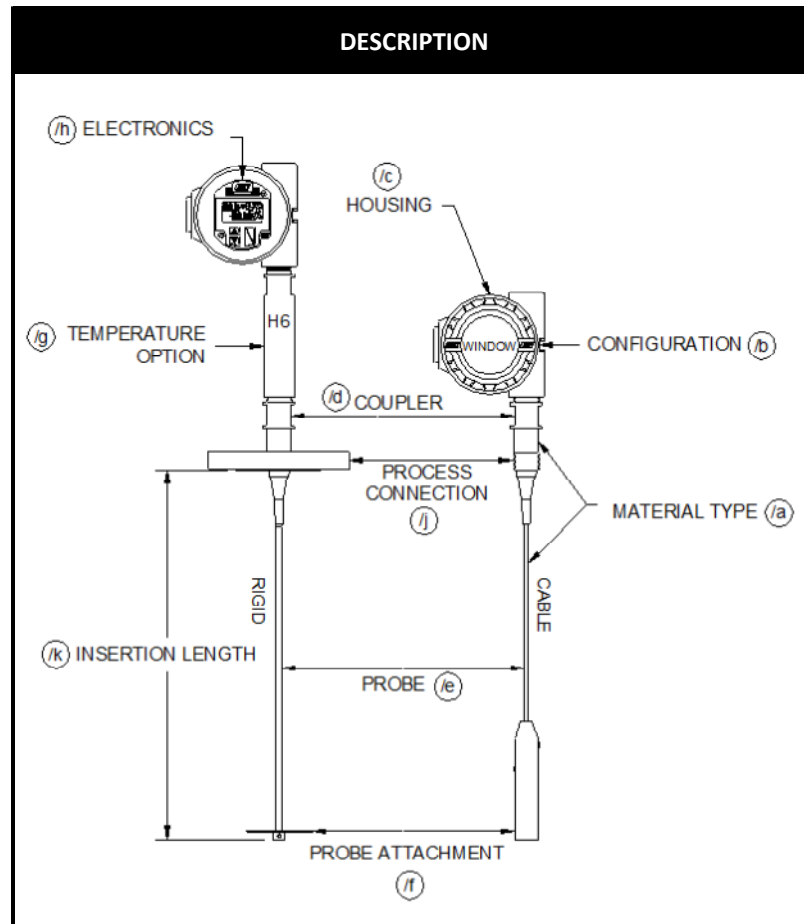

MT5100 INTERFACE GUIDELINES

In order to properly detect the level of interface between two liquids using the MT5100, the following rules must be adhered to:

1. One of the following probe and mounting configurations must be used:
 - a. Single rigid rod or flexible cable mounted in a stilling well, external chamber, or existing displacer.*
 - b. Coaxial probe mounted into tank, external chamber, or displacer
 - c. Single rigid rod or flexible cable in open vessel with recommended installation conditions.

* *This is the preferred mounting configuration to reduce the chance of fouling.*
2. Emulsion layers will affect the detection of an interface level. An emulsion layer may negate an interface level indication completely. The MT5100 will read an interface level in the presence of a 3 inch emulsion. Greater emulsion layers may be possible. Please consult factory.
3. The minimum upper fluid thickness must be 4 inches when emulsion is present, and 3 inches with a clean interface. Closer measurement may be possible with calibration adjustment.
4. The upper fluid dielectric constant must be greater than 1.4 and less than 5.
5. The interface level indication is a calculated value based partially upon the dielectric of the upper fluid. The upper fluid dielectric must remain constant for consistency / accuracy in the interface level indication.
6. The lower fluid dielectric constant must not be less than 15.
7. If the application is a flooded condition (sensor completely submerged in process), it must remain completely flooded.
8. In a non-flooded condition, the upper fluid must not be allowed to enter the upper unmeasurable zone. The upper unmeasurable zone is typically located within the mounting nozzle of the vessel.
9. If measuring interface in an external chamber, insure the fluid is allowed to equalize between the vessel and the chamber. Consult the factory or your local representative for assistance.
10. R and RW remote coupler configurations are not recommended for interface applications unless the remote coax is 5ft or less and the probe is a coaxial configuration or in a chamber or stilling well.

If the required interface application does not fall within the above mentioned parameters, please consult the factory for an alternate technology, such as an LMT Series magnetostrictive transmitter or a KM26 magnetic level gauge.

GUIDELINES FOR MEASURING with ULD MODE

When measuring low dielectric fluids and bulk solids, it is possible to use the end of probe shift as the target. Requirements for using the end of probe in Ultra Low Dielectric (ULD) mode.

1. The dielectric of the material must be between 1.3 and 3.0.
2. You must have a clear end of probe signal. This may require an additional disk on the end of probe in order to increase the reflection
3. The probe type can be cable, rod, or coaxial.
4. Accuracy may be affected if dielectric value changes.
5. If the end of probe is lost in sludge, interface or emulsion, and the end of probe signal is lost, then ULD reading will not be possible.
6. ULD mode cannot be used where interface or emulsion layer are present.

PROCESS CONNECTION / WAVEGUIDE COUPLER

| Base Code | Insulator | Process Connection | Seal Options | Maximum Pressure | Min Temp ⁵ | Max Temp ⁵ | Compatible Probes | | |
|--|--------------------------|--------------------|--|---|-----------------------|-----------------------|-------------------|---------------------|--------------------------|
| | | | | | | | Rod | Cable | Coaxial |
| C1¹ | Teflon | 3/4" NPT | Viton FKM A, Kalrez 4079 EPDM, Markez Z1319 | 1500 psi @ 100°F / 103 bar @ 38°C | -60°F -50°C | 400°F 204°C | P01, P03, | P11 | P51, P91 ⁷ |
| C2¹ | | 1.5" NPT | | 600 psi @ 400°F / 41 bar @ 204°C | | | P02, P43 | P12, P33 | |
| C3¹ | | 2.5" NPT | | 50 psi / 13.4 bar | | | | P12, P33, P61 | |
| C1H¹ | Teflon | 3/4" NPT | Viton FKM A, Kalrez 4079 EPDM, Markez Z1319 | 3000 psi @ 100 F / 207 bar @ 38 C | -60°F -50°C | 400°F 204°C | P01, P03 | P11, | P51, P91 ³ |
| C2H¹ | | 1.5" NPT | | 1200 psi @ 400 F / 83 bar @ 204 C | | | P02, P43 | P12, P33, | |
| C8 (316/L SS and Hastelloy C only) | Borosilicate Glass | 1.5" NPT | Fused silicate Boro-Glass | 5000 psi @ 100°F / 344 bar @ 38°C 1500 psi @ 800°F / 103 bar @ 427°C Not for Hot Water or Steam Service | -60°F -50°C | 800°F 427°C | | P11 ⁴ | P71 |
| C9² | Alumina Ceramic | 1" NPT | Viton FKM A, Kalrez 4079 EPDM, Markez Z1319 | 2000 psi @ 635°F / 138 bar @ 335°C | -60°F -50°C | 635°F 335°C | | P11 ⁴ | P81 |
| CZ | Custom (Consult Factory) | | | | | | | | |

Notes: 1. Add the suffix "S" to the Base Code to include a hermetic seal (example: /C4SV). Hermetic seals are required on all IECEx approved equipment,

2. Hermetic seal is required. O-ring selection Markez 1319 is recommended for steam service

3. The P91 probe has a 1" MNPT adjustable compression fitting equipped with Teflon ferrules as the standard process connection. The maximum process pressure utilizing the Teflon ferrules is 50 psi (3.4 bars).

4. Requires installation in a stilling well or external chamber

5. Consult O-ring Table for o-ring temperature specifications.

O-Ring Seals*

| Order Code | Description | Min. Temp | Max. Temp |
|------------|---------------|-------------|-------------|
| V | Viton A (FKM) | -15°F -26°C | 400°F 204°C |
| K | Kalrez 4079 | -40°F -40°C | 400°F 204°C |
| E | EPDM | -60°F -50°C | 250°F 125°C |
| A | Markez Z1319 | -14°F -10°C | 572°F 300°C |

*The information in this chart has been supplied by the o-ring manufacturers. Before permanent installation, test the equipment with the chemicals and under the specific conditions of your application.

If the required o-ring material is not listed above, please consult the factory.

Pressure / Temperature Curves¹

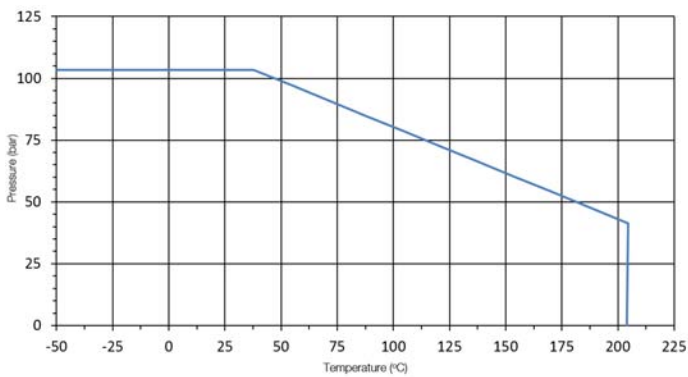

Pressure versus Temperature for C1 and C2 Couplers

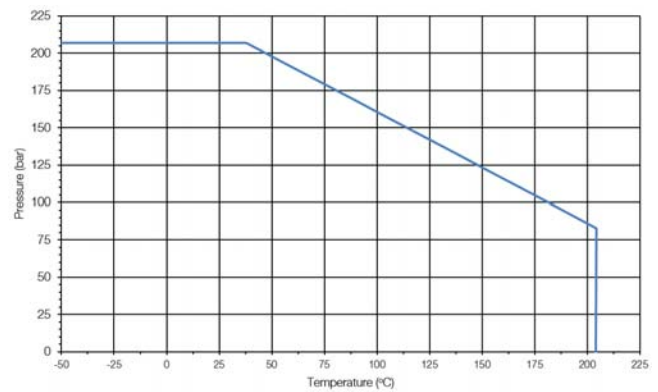

Pressure versus Temperature for C1H and C2H Couplers

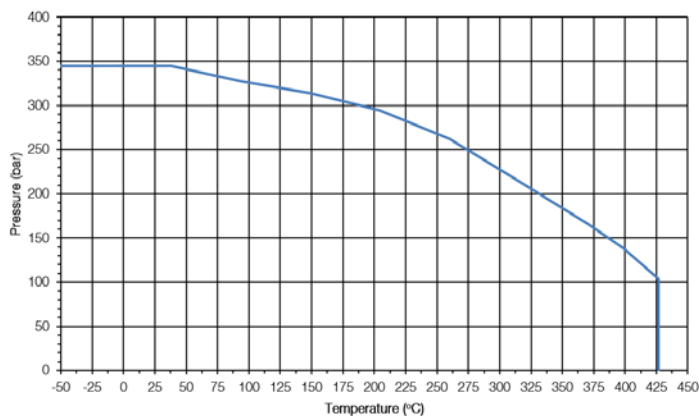

Pressure versus Temperature for C8 Couplers

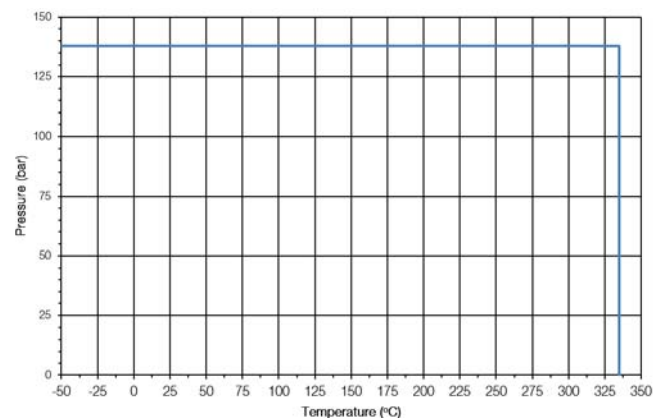

Pressure versus Temperature for C9 Couplers²

1. Coupler temperatures are based on o-ring temperature ratings. Please refer to the o-ring chart above for further information.

2. C9 coupler temperature rating is based on Markez Z1319 o-ring selection. The temperature is based on o-ring placement in side the coupler, thus allowing higher temperatures at the process connection.

Probe Types

| Code | O.D | Notes | Max Length | Attachment Options |
|-------------------------------------|-------------------------------|---------------------------------------|---------------------------------|--------------------|
| Rigid Rod | | | | |
| P01 | 0.25in (6mm) | | 20ft (3.05m) ^{1, 3} | D |
| P02 | 0.50in (13mm) | | 20ft (6.10m) ^{2, 3, 4} | |
| P03 | 0.375in (9mm) | | 10ft (3.05m) ^{1, 3} | |
| P43 | 0.125in (3mm) | 316 SS and HSC-270 | 50ft (15.24m) | W (included) |
| Flexible Cable | | | | |
| P11 | 0.1875in (5mm) | 2000lb (907kg) maximum pull force | 100ft (30.5m) ³ | W, E, WD |
| P12 | 0.25in (6mm) | 2000lb (907kg) maximum pull force | | |
| P61 | 0.31in (8mm) | 10,000lb (4536kg) maximum pull force | | |
| Triangle Cable | | | | |
| P33 | 0.25in (6mm) | Minimum 4" flange connection required | 100ft (30.5m) | WS6 (included) |
| Coaxial (clean liquids only) | | | | |
| P51 | 0.875in (22mm) | | 22ft (6.71m) | none |
| P71 | 1.315in (34mm) | 316SS only | | |
| P81 | 0.875in (22mm) | 316SS only | | |
| P91 | 1.00in (25mm) | | | |
| CUSTOM | | | | |
| PZZ | Custom Probe, Consult Factory | | | |

- Notes:
1. 5ft (1.52m) maximum probe length when installed in a stilling well or EC chamber (minimum 2" diameter) without centering spacer(s).
 2. 20ft (3.05m) maximum probe length when installed in a stilling well or EC chamber (minimum 3" diameter) without centering spacer(s).
 3. Lengths greater than 7ft (2.13m) require cable spacers at 5ft (1.52m) maximum intervals when installed in a 2" or smaller stilling well or EC chamber. Lengths greater than 10ft (3.05m) require cable spacers at 10ft (3.05m) maximum intervals when installed in 2.5" - 3" stilling well or EC chamber.
 4. Segmented probes available

Cable weights for cable probes

| Order Code | O.D. | Weight Height (WH) | Weight | Minimum Stilling Well Size | Compatible Probes |
|------------|---------------------|-------------------------|-----------------|----------------------------|-------------------|
| W09 | 0.875 in. (22.2 mm) | 4.0 in. (101.6 mm) | 0.7 lbs (301 g) | 1.0 in. Sch. 80 | P11 |
| W10 | 1.0 in. (25.4 mm) | 6.0 in. (152.4 mm) | 1.3 lbs (590 g) | 1.5 in. Sch. 160 | P11, P12 |
| W13 | 1.25 in. (31.75 mm) | 3.5 in. (88.90 mm) | 0.8 lbs (317 g) | 1.5 in. Sch. 80 | P11, P12 |
| W16 | 1.625 in. (41.3 mm) | 2.0 in. (50.8 mm) | 1.1 lbs (499 g) | 2.0 in. Sch. 80 | P11 |
| W19 | 1.875 in. (47.6 mm) | 2.0 in. (50.8 mm) | 1.5 lbs (680 g) | 2.0 in. Sch. 80 | P12 |
| W29 | 2.875 in. (73.3 mm) | 1.0 in. (25.4 mm) | 1.8 lbs (816 g) | 3.0 in. Sch. 40 | P11, P12 |
| W61 | 1.5 in. (38.1 mm) | 5.25 in. (133.35 mm) | 2.2 lbs (998 g) | n/a | P61 |
| WS6 | 2.0 in. (50.8 mm) | 6.0 in. (152.4 mm) long | 0.9 lbs / 408 g | n/a | P33 |

Centering disks for rod probes

| Order Code | O.D. | Minimum Stilling Well Size |
|------------|--------------------|----------------------------|
| D15 | 1.5 in (38.1 mm) | 1.5 in sch. 40 |
| D20 | 2.0 in. (50.8 mm) | 2 in sch. 40 |
| D23 | 2.3 in. (58.7 mm) | 2.5 in sch. 40 |
| D28 | 2.8 in. (71.1 mm) | 3 in sch. 80 |
| D38 | 3.75 in. (95.3 mm) | 4 in sch. 80 |

MT5000 Recommended Installation

NOTE: The following guidelines are very conservative. If you have an application that exceeds these limits consult factory for application recommendations.

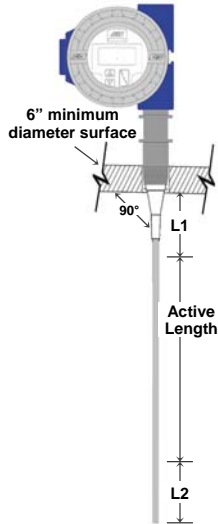

1. SINGLE PROBE - FLAT PLATE

| MINIMUM DIELECTRIC CONSTANT | L MAXIMUM PROBE LENGTH ² | L1 Unmeasurable ¹ | L2 Unmeasurable ¹ (WH = Weight Height) |
|-----------------------------|-------------------------------------|------------------------------|---|
| ≤ 4 | 20 ft. / 6.1 m | 6 in. / 15.2 cm | 3 in. / 7.6 cm (Rod) WH + 3 in. / 7.6 cm (cable) |
| 10 | 40 ft. / 12.2 m | 3 in. / 7.6 cm | 2 ¹ (Rod) WH + 3" / 7.6 cm (cable) |
| 35 | 50 ft. / 15.2 m | 3 ¹ in. / 7.6 cm | |

- Depending on installation, L1 & L2 unmeasurable lengths of 0 may be possible with use of linearization table and latching feature. For easiest startup use $L1_{min} \geq 3"$ or as listed if greater and $L2_{min} \geq 3"$ (rod) or $WH + 3"$ (cable).
- Maximum probe lengths are limited as indicated in Probe Type table.

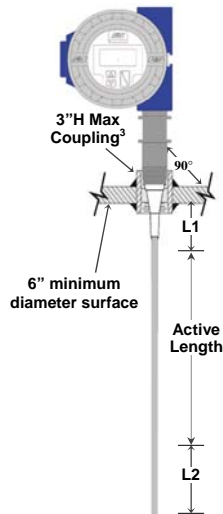

2. SINGLE PROBE - FLAT PLATE WITH COUPLING³

| MINIMUM DIELECTRIC CONSTANT | L MAXIMUM PROBE LENGTH ² | L1 Unmeasurable ¹ | L2 Unmeasurable ¹ (WH = Weight Height) |
|-----------------------------|-------------------------------------|------------------------------|---|
| ≤ 4 | 20 ft. / 6.1 m | 8 in. / 20.3 cm | 3 in. / 7.6 cm (Rod) WH + 3 in. / 7.5 cm (Cable) |
| 10 | 40 ft. / 12.2 m | 4 in. / 10.2 cm | 2 ¹ (Rod) WH + 3 in. / 7.5 cm (Cable) |
| 35 | 50 ft. / 15.2 m | 3 in. / 7.6 cm | |

- Depending on installation, L1 & L2 unmeasurable lengths of 0 may be possible with use of linearization table and latching feature. For easiest startup use $L1_{min} \geq 3"$ or as listed if greater and $L2_{min} \geq 3"$ (rod) or $WH + 3"$ (cable).
- Maximum probe lengths are limited as indicated in Probe Type table.
- The coupling should not extend into the vessel more than 1 in. / 2.5 cm.

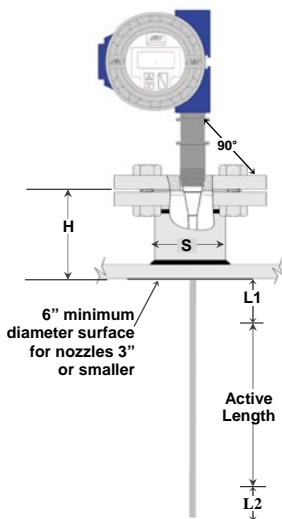

3A. SINGLE PROBE - NOZZLE & FLANGE³

| MINIMUM DIELECTRIC CONSTANT | L MAXIMUM PROBE LENGTH ² | L1 Unmeasurable ¹ | L2 Unmeasurable ¹ (WH = Weight Height) |
|-----------------------------|-------------------------------------|--|---|
| ≤ 4 | 20 ft. / 6.1 m | H + 8 in. / 20.3 cm | 3 in. / 7.6 cm (Rod) WH + 3 in. / 7.5 cm (Cable) |
| 10 | 40 ft. / 12.2 m | H + 4 in. / 10.2 cm | 2 ¹ (Rod) WH + 3 in. / 7.5 cm (Cable) |
| 35 | 50 ft. / 15.2 m | H + 2 ¹ in. / 5.1 ¹ cm | |

- Depending on installation, L1 & L2 unmeasurable lengths of 0 may be possible with use of linearization table and latching feature. For easiest startup use $L1_{min} \geq 3"$ or as listed if greater and $L2_{min} \geq 3"$ (rod) or $WH + 3"$ (cable).
- Maximum probe lengths are limited as indicated in Probe Type table.
- A one time startup adjustment is required to eliminate the effect of the nozzle. For details refer to the Blanking Parameter in the Commissioning section of the Installation & Operation Manual.

MT5000 Recommended Installation

NOTE: The following guidelines are very conservative. If you have an application that exceeds these limits consult factory for application recommendations.

3B. SINGLE PROBE - NOZZLE & FLANGE³

[height of nozzle (H) less than width of nozzle (S)]

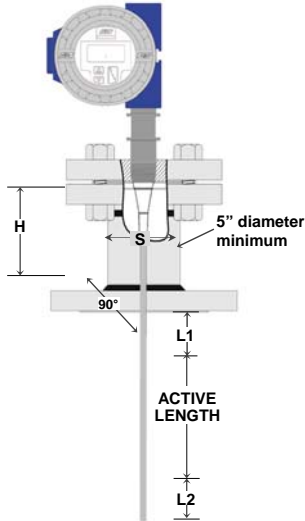

| MINIMUM DIELECTRIC CONSTANT | L MAXIMUM PROBE LENGTH ² | L1 Unmeasurable ¹ | L2 Unmeasurable ¹ (WH = Weight Height) |
|-----------------------------|-------------------------------------|--|---|
| ≤ 4 | 20 ft. / 6.1 m | H + 6 in. / 15.24 cm | 3 in. / 7.6 cm (Rod) WH + 3 in. / 7.6 cm (Cable) |
| 10 | 40 ft. / 12.2 m | H + 3 in. / 7.6 cm | 2 ¹ (Rod) WH + 3 in. / 7.6 cm (Cable) |
| 35 | 50 ft. / 15.2 m | H + 3 ¹ in. / 7.6 ¹ cm | |

1. Depending on installation, L1 & L2 unmeasurable lengths of 0 may be possible with use of linearization table and latching feature. For easiest startup use $L1_{min} \geq 3"$ or as listed if greater and $L2_{min} \geq 3"$ (rod) or WH + 3" (cable).
2. Maximum probe lengths are limited as indicated in Probe Type table.
3. A one time startup adjustment is required to eliminate the effect of the nozzle. For details refer to the Blanking Parameter in the Commissioning section of the Installation & Operation Manual.

4. SINGLE PROBE - PERMANENT STILLING WELL

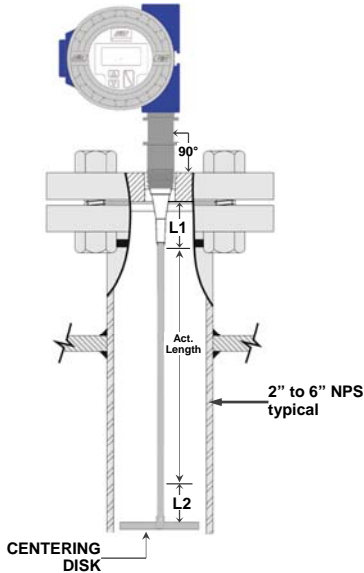

| MINIMUM DIELECTRIC CONSTANT | L MAXIMUM PROBE LENGTH ² | L1 Unmeasurable ¹ | L2 Unmeasurable ¹ (WH = Weight Height) |
|-----------------------------|-------------------------------------|------------------------------|---|
| ≤ 1.7 ³ | 20 ft. / 6.1 m | 8 in. / 20.3 cm | 3 in. / 7.6 cm (Rod) WH + 3 in. / 7.6 cm (Cable) |
| 3 | 30 ft. / 9.1 m | 6 in. / 15.2 cm | |
| 10 | 50 ft. / 15.2 m | 3 in. / 7.6 cm | 2 ¹ (Rod) WH + 3 in. / 7.6 cm (Cable) |
| 35 | 217 ft. / 66.1 m | | |

1. Depending on installation, L1 & L2 unmeasurable lengths of 0 may be possible with use of linearization table and latching feature. For easiest startup use $L1_{min} \geq 3"$ or as listed if greater and $L2_{min} \geq 3"$ (rod) or WH + 3" (cable).
2. Maximum probe lengths are limited as indicated in Probe Type table.
3. Stilling well size will determine minimum dielectric constant. ULD mode can be used for longer lengths up to 50ft(15.2m).

5. SINGLE PROBE - REMOVABLE STILLING WELL

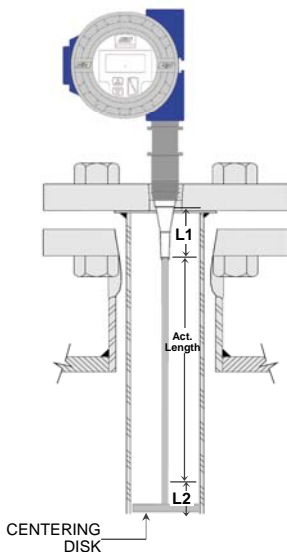

| MINIMUM DIELECTRIC CONSTANT | L MAXIMUM PROBE LENGTH ² | L1 Unmeasurable ¹ | L2 Unmeasurable ¹ (WH = Weight Height) |
|-----------------------------|-------------------------------------|------------------------------|---|
| ≤ 1.7 ³ | 20 ft. / 6.1 m | 8 in. / 20.3 cm | 3 in. / 7.6 cm (Rod) WH + 3 in. / 7.6 cm (Cable) |
| 3 | 30 ft. / 9.1 m | 6 in. / 15.2 cm | |
| 10 | 50 ft. / 15.2 m | 3 in. / 7.6 cm | 2 ¹ (Rod) WH + 3 in. / 7.6 cm (Cable) |
| 35 | 217 ft. / 66.1 m | | |

1. Depending on installation, L1 & L2 unmeasurable lengths of 0 may be possible with use of linearization table and latching feature. For easiest startup use $L1_{min} \geq 3"$ or as listed if greater and $L2_{min} \geq 3"$ (rod) or WH + 3" (cable).
2. Maximum probe lengths are limited as indicated in Probe Type table.
3. Stilling well size will determine minimum dielectric constant.

MT5000 Recommended Installation

NOTE: The following guidelines are very conservative. If you have an application that exceeds these limits consult factory for application recommendations.

6. SINGLE PROBE - EXTERNAL CHAMBER

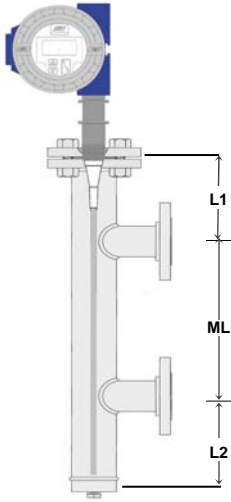

| MINIMUM DIELECTRIC CONSTANT | L MAXIMUM PROBE LENGTH ² | L1 Unmeasurable ¹ | L2 Unmeasurable ¹ (WH = Weight Height) |
|-----------------------------|--|---------------------------------|---|
| ≤ 1.7 ³ | 20 ft. / 6.1 m | 9 in. / 22.86 cm | 3 in. / 7.6 cm (Rod) WH + 3 in. / 7.6 cm (Cable) |
| 3 | 30 ft. / 9.1 m | 6 in. / 15.2 cm | |
| 10 | 50 ft. / 15.2 m | 3 in. / 7.5 cm | |
| 35 | 217 ft. / 66.1 m | | |

1. Depending on installation, L1 & L2 unmeasurable lengths of 0 may be possible with use of linearization table and latching feature. For easiest startup use $L1_{min} \geq 3''$ or as listed if greater and $L2_{min} \geq 3''$ (rod) or $WH + 3''$ (cable).
2. Maximum probe lengths are limited as indicated in Probe Type table.
3. Stilling well size will determine minimum dielectric constant. ULD mode can be used for longer lengths up to 50ft(15.2m).

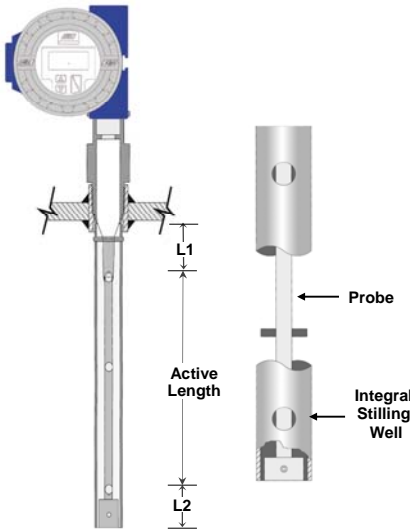

7. COAXIAL PROBE (rod inside of outer tube) clean liquids only]

| MINIMUM DIELECTRIC CONSTANT | L MAXIMUM PROBE LENGTH ² | L1 Unmeasurable ¹ | L2 Unmeasurable ¹ |
|-----------------------------|--|---------------------------------|---------------------------------|
| 1.4 | 22 ft. / 6.7 m | 4 in. / 10.2 cm | 2 in. / 5 cm |
| 2.0 | | 2 in. / 5.1 cm | |
| 4.0 | | | |

1. Depending on installation, L1 & L2 unmeasurable lengths of 0 may be possible with use of linearization table and latching feature. For easiest startup use $L1_{min} \geq 3''$ or as listed if greater and $L2_{min} \geq 3''$ (rod) or $WH + 3''$ (cable).
2. Maximum probe lengths are limited as indicated in Probe Type table.
3. Typically used in low dielectric, clean liquids.

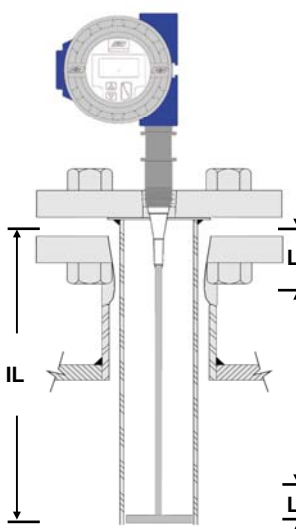
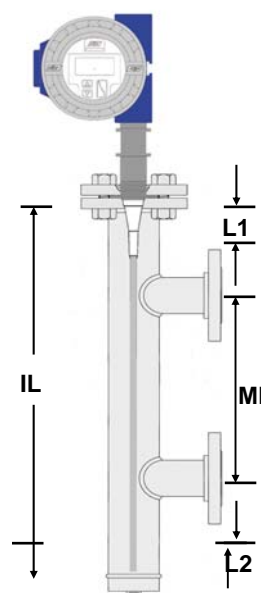
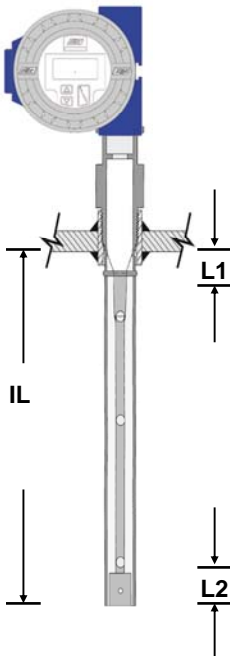
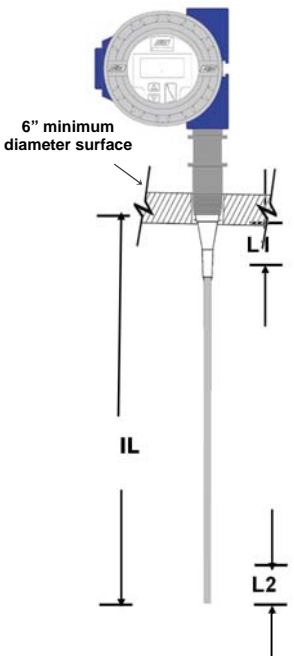
| Cable or Rod - Stilling Well | | Cable or Rod - External Chamber | | | | | | | | | | | | | | | | | | | | | |
|--|--|--|--|----|--------|----|---|-------------|--|------------------------------|--|--|--|--------------------|--|----|-------|----|--|-------------|--|-------------------------|--|
| <table border="1"> <tr> <th colspan="2">UNMEASURABLE ZONES</th> </tr> <tr> <td>L1</td> <td>4 IN.</td> </tr> <tr> <td>L2</td> <td>3 IN. (+ weight height for P11, P12)</td> </tr> <tr> <th colspan="2">PROBE TYPES</th> </tr> <tr> <td colspan="2">P01, P02, P03, P11, P12, P43</td> </tr> </table> | | UNMEASURABLE ZONES | | L1 | 4 IN. | L2 | 3 IN. (+ weight height for P11, P12) | PROBE TYPES | | P01, P02, P03, P11, P12, P43 | | <table border="1"> <tr> <th colspan="2">UNMEASURABLE ZONES</th> </tr> <tr> <td>L1</td> <td>4 IN.</td> </tr> <tr> <td>L2</td> <td>3 IN. (+ weight height for P11 and P12)</td> </tr> <tr> <th colspan="2">PROBE TYPES</th> </tr> <tr> <td colspan="2">P01, P02, P03, P11, P12</td> </tr> </table> | | UNMEASURABLE ZONES | | L1 | 4 IN. | L2 | 3 IN. (+ weight height for P11 and P12) | PROBE TYPES | | P01, P02, P03, P11, P12 | |
| UNMEASURABLE ZONES | | | | | | | | | | | | | | | | | | | | | | | |
| L1 | 4 IN. | | | | | | | | | | | | | | | | | | | | | | |
| L2 | 3 IN. (+ weight height for P11, P12) | | | | | | | | | | | | | | | | | | | | | | |
| PROBE TYPES | | | | | | | | | | | | | | | | | | | | | | | |
| P01, P02, P03, P11, P12, P43 | | | | | | | | | | | | | | | | | | | | | | | |
| UNMEASURABLE ZONES | | | | | | | | | | | | | | | | | | | | | | | |
| L1 | 4 IN. | | | | | | | | | | | | | | | | | | | | | | |
| L2 | 3 IN. (+ weight height for P11 and P12) | | | | | | | | | | | | | | | | | | | | | | |
| PROBE TYPES | | | | | | | | | | | | | | | | | | | | | | | |
| P01, P02, P03, P11, P12 | | | | | | | | | | | | | | | | | | | | | | | |
| <p>• Preferred Configuration</p>  | | <p>• Preferred Configuration • Flooded or Non-Flooded</p>  | | | | | | | | | | | | | | | | | | | | | |
| <p>Note: Stilling Well Size 2" - 4" Pipe; Customer or K-TEK Supplied.</p> | | <p>Note: Chamber Size 2" - 4" Pipe; Customer or K-TEK Supplied. Reference EC Data Sheet (EC100-0202-1) to specify /order external chamber available online at www.ABB.com on the Displacer Replacer and External Chamber page. End of probe or top of weight should extend a minimum of 2" (50mm) below lower process connection of chamber.</p> | | | | | | | | | | | | | | | | | | | | | |
| Coaxial | | Cable or Rod - Open Vessel | | | | | | | | | | | | | | | | | | | | | |
| <table border="1"> <tr> <th colspan="2">UNMEASURABLE ZONES</th> </tr> <tr> <td>L1</td> <td>4 IN.*</td> </tr> <tr> <td>L2</td> <td>3 IN.</td> </tr> <tr> <th colspan="2">PROBE TYPES</th> </tr> <tr> <td colspan="2">P51, P71, P91</td> </tr> </table> | | UNMEASURABLE ZONES | | L1 | 4 IN.* | L2 | 3 IN. | PROBE TYPES | | P51, P71, P91 | | <table border="1"> <tr> <th colspan="2">UNMEASURABLE ZONES</th> </tr> <tr> <td>L1</td> <td>4 IN.</td> </tr> <tr> <td>L2</td> <td>3 IN. (+ weight height for P11 and P12)</td> </tr> <tr> <th colspan="2">PROBE TYPES</th> </tr> <tr> <td colspan="2">P01, P02, P03, P11, P12</td> </tr> </table> | | UNMEASURABLE ZONES | | L1 | 4 IN. | L2 | 3 IN. (+ weight height for P11 and P12) | PROBE TYPES | | P01, P02, P03, P11, P12 | |
| UNMEASURABLE ZONES | | | | | | | | | | | | | | | | | | | | | | | |
| L1 | 4 IN.* | | | | | | | | | | | | | | | | | | | | | | |
| L2 | 3 IN. | | | | | | | | | | | | | | | | | | | | | | |
| PROBE TYPES | | | | | | | | | | | | | | | | | | | | | | | |
| P51, P71, P91 | | | | | | | | | | | | | | | | | | | | | | | |
| UNMEASURABLE ZONES | | | | | | | | | | | | | | | | | | | | | | | |
| L1 | 4 IN. | | | | | | | | | | | | | | | | | | | | | | |
| L2 | 3 IN. (+ weight height for P11 and P12) | | | | | | | | | | | | | | | | | | | | | | |
| PROBE TYPES | | | | | | | | | | | | | | | | | | | | | | | |
| P01, P02, P03, P11, P12 | | | | | | | | | | | | | | | | | | | | | | | |
| <p>* 0" Available with extended process coupler or purge options</p>  | | <p>6" minimum diameter surface</p>  | | | | | | | | | | | | | | | | | | | | | |

Base Model for MT5000, MT5100 and MT5200 Transmitters

| MT5000 Series Guide Wave Radar | MT5. | xxx | xxxx | xx | x | xx(x) |
|---|------|-----|------|----|----|-------|
| Device Type | | | | | | |
| MT5000, Liquid Total Level Transmitter | | 000 | | | | |
| MT5100, Total Level and Interface Level Transmitter | | 100 | | | | |
| MT5200, Solids and Low Dielectric Liquid Total Level Transmitter | | 200 | | | | |
| Coupler Material | | | | | | |
| None | | | Y | | | |
| 316/L Stainless Steel (Standard) | | S6* | | | | |
| 304/L Stainless Steel (Rigid Probe only) | | S4 | | | | |
| Hastelloy C-276 | | H1 | | | | |
| Hastelloy B3 (Rigid Probes only) | | H3 | | | | |
| Monel | | M4 | | | | |
| Titanium (Rigid Probes only) | | T2 | | | | |
| Inconel 625 | | IN2 | | | | |
| Special | | Z9 | | | | |
| Transmitter Configuration | | | | | | |
| None | | | Y | | | |
| Local Transmitter (Standard) | | | L* | | | |
| Local Transmitter with Window Cover (Standard) | | | LW* | | | |
| Remote Mounted Electronics with Standard 5 ft Cable (Dielectric > 15) | | | R | | | |
| Remote Mounted Electronics with Window Cover and Standard 5 ft Cable (Dielectric > 15) | | | RW | | | |
| Special | | | Z9 | | | |
| Transmitter Housing | | | | | | |
| None | | | | | Y | |
| Dual Compartment Aluminum Housing (Standard) | | | | | A* | |
| Dual Compartment 316 Stainless Steel Housing | | | | | S | |
| Special | | | | | Z | |
| Process Connection / Waveguide Coupler | | | | | | |
| None | | | | | | Y |
| 0.75 in. NPT Process Connection Coupler Single / Coaxial Probe Teflon Insulator | | | | | | C1* |
| 0.75 in. NPT Process Connection Coupler Single / Coaxial Probe Teflon Insulator High Pressure | | | | | | C1H |
| 1.50 in. NPT Process Connection Coupler Single / Coaxial Probe Teflon Insulator | | | | | | C2* |
| 1.50 in. NPT Process Connection Coupler Single / Coaxial Probe Teflon Insulator High Pressure | | | | | | C2H |
| 2.50 in. NPT Process Connection Coupler Single / Coaxial Probe Teflon Insulator | | | | | | C3 |
| 1.50 in. NPT Process Connection HP/HT Coupler Single Probe/Coaxial Probe Borosilicate Glass Insulator | | | | | | C8 |
| 1.0 in. NPT Process Connection HP/HT Coupler Single Probe/Coaxial Probe Alumina Ceramic Insulator | | | | | | C9 |
| Custom Coupler, consult factory | | | | | | CZ |

* - Standard

Base Model

MT5000 Series Guide Wave Radar ordering information continued

| MT5.xxx.xxxx.xx.x.xxx. | x(xxx)xxx(xxxxxx) |
|---|-------------------|
| Process Seal Type | |
| None | Y |
| Viton FKM A O-Ring Process Seal -15 °F (-26 °C) Min Temp to 400 °F (204 °C) Max Temp Standard | V* |
| Additional Hermetic Glass Feed-Through with Viton FKM A O-Ring Process Seal | SV ^{1*} |
| Kalrez 4079 O-Ring Process Seal -40 °F (-40 °C) Min Temp to 400 °F (204 °C) Max Temp | K* |
| Additional Hermetic Glass Feed-Through with Kalrez 4079 O-Ring Process Seal | SK ^{1*} |
| EPDM O-Ring Process Seal -60 °F (-50 °C) Min Temp to 250 °F (125 °C) Max Temp | E |
| Additional Hermetic Glass Feed-Through with EPDM O-Ring Process Seal | SE ^{1*} |
| Markez Z1319 O-Ring Process Seal -14 °F (-10 °C) Min Temp to 572 °F (300 °C) Max Temp | A* |
| Additional Hermetic Glass Feed-Through with Markez Z1319 O-Ring Process Seal | SA ^{1*} |
| Borosilicate process seal, C8 coupler only | B* |
| Additional Hermetic Glass Feed-Through with Borosilicate Process Seal, C8 coupler only | SB ^{1*} |
| Special Process Seal | Z9 |
| Probe Type | |
| None | Y |
| Rod probes | |
| Single Rigid Rod Probe, 0.25 in. (6 mm) Outer Diameter, 20 ft (6.1 m) Max Standard Length | P01* |
| Single Rigid Rod Probe, 0.50 in. (13 mm) Outer Diameter, 20 ft (6.10 m) Max Standard Length | P02* |
| Single Rigid Rod Probe 0.375 in. (9 mm) Outer Diameter, 20 ft (6.1 m) Max Standard Length | P03* |
| Simi-Rigid Rod Probe 0.125 in. (3 mm) Outer Diameter 50 ft (15.24 m) Max Standard Length Includes Weight | P43 |
| Cable probes | |
| Single Flexible Cable Probe 0.1875 in. (5 mm) Outer Diameter, 200 ft (61 m) Max Standard Length | P11* |
| Single Flexible Cable Probe 0.25 in. (6 mm) Outer Diameter, 200 ft (61 m) Max Standard Length | P12* |
| Triangle Cable Probe 0.25 in. (6 mm) Outer Diameter, 100 ft (30.5 m) Max Standard Length | P33 |
| Single Flexible Cable Probe 0.31 in (8 mm) Outer Diameter, 200 ft (61 m) Max Standard Length | P61 |
| Coaxial probes | |
| Coaxial Probe 0.875 in. (22 mm) Outer Diameter 22 ft (6.7.5 m) Max Standard Length | P51 |
| Coaxial Probe 1.315 in. (34 mm) Outer Diameter 316SS only 22 ft (6.7.5 m) Max Standard Length | P71 |
| Coaxial Probe 0.1875 in. (5 mm) Outer Diameter 316SS only 22 ft (6.7.5 m) Max Standard Length | P81 |
| Coaxial Probe 1.00 in. (25 mm) Outer Diameter 22 ft (6.7.5m) Max Standard Length with compression fitting | P91 ² |
| Custom Probe, consult factory | PZZ |

1. Hermetic seal required for E1 and E2 approvals
 2. Maximum process pressure of 3.45 barg (50 psig)
 * - Standard

Base Model

MT5000 Series Guide Wave Radar ordering information continued

| MT5.xxx.xxxx.xx.x.xx(x).x(xxx). | xxxx | xxxx | xx |
|--|------|------|----|
| Probe end attachment | | | |
| None | Y | | |
| Centering weights (cable probes only) | | | |
| 0.875 in. (22.2 mm) O.D., 4.0 in. (101.6 mm) Weight Height, approx. 0.7 lbs (301 g) | W09* | | |
| 1.0 in. (25.4mm) O.D., 6.0 in. (152.4 mm) Weight Height, approx. 1.3 lbs (590 g) | W10* | | |
| 1.25 in. (31.75 mm) O.D., 3.5 in. (88.9 mm) Weight Height, approx. 0.8 lbs (317 g) | W13* | | |
| 1.625 in. (41.3mm) O.D., 2.0 in. (50.8 mm) Weight Height, approx. 1.1 lbs (499 g) | W16 | | |
| 1.875 in. (47.6 mm) O.D., 2.0 in. (50.8 mm) Weight Height, approx. 1.5 lbs (680 g) | W19 | | |
| 2.875 in. (73.3 mm) O.D., 1.0 in. (25.4 mm) Weight Height, approx. 1.8 lbs (816 g) | W29 | | |
| 2.00 in. (50.8 mm) O.D., 6.0 in. (152.4 mm) Weight Height, approx. 2.2 lbs (998 g) | WS6 | | |
| 1.5 in. (38.1 mm) O.D., 5.25 in. (133.35 mm) Weight Height, approx. 2.2 lbs (998 g) | W61 | | |
| Custom Centering Weight (consult factory) | W99 | | |
| Centering disks (rod probes only) | | | |
| 1.50 in. (38.1 mm) O.D. approx 0.4375 in. (11 mm) Height 1.50 in. (38.1 mm) Min Stilling Well Size | D15 | | |
| 2.0 in. (50.8 mm) O.D. approx 0.4375 in. (11 mm) Height 2.0 in. (50.8 mm) Min Stilling Well Size | D20 | | |
| 2.3 in. (58.7 mm) O.D. approx 0.4375 in. (11 mm) Height 2.5 in. (63.5 mm) Min Stilling Well Size | D23 | | |
| 2.8 in. (71.1 mm) O.D. approx 0.4375 in. (11 mm) Height 3.0 in. (76.2 mm) Min Stilling Well Size | D28 | | |
| 3.75 in. (95.3 mm) O.D. approx 0.4375 in. (11 mm) Height 4.0 in. (101.6 mm) Min Stilling Well Size | D38 | | |
| 3.75 in. (95.3 mm) O.D. approx 0.4375 in. (11 mm) Height 4.0 in. (101.6 mm) Min Stilling Well Size | D60 | | |
| Custom Centering Disk (consult factory) | D99 | | |
| Eyelets (cable probes only) | | | |
| Eyelet SS6 for 0.1875 in. (5 mm) O.D. Cable | E1 | | |
| Eyelet SS6 for 0.25 in. (6 mm) O.D. Cable | E2 | | |
| Special | Z9 | | |
| Probe Attachment Material | | | |
| None | | Y | |
| 316/L Stainless Steel, Standard | | S6* | |
| 304/L Stainless Steel | | S4 | |
| Hastelloy C-276 | | H1 | |
| Monel | | M4 | |
| Inconel 600 | | N2 | |
| Special | | Z9 | |
| Process Temperature Extension | | | |
| Process Temperature 32 °F (0 °C) to 250 °F (121 °C) Standard | | | H0 |
| Temperature Extension, extends electronics additional 6 in. above process connection | | | H6 |
| Special | | | Z9 |

Base Model

MT5000 Series Guide Wave Radar ordering information continued

| MT5.xxx.xxxx.xx.x.xx(x).x(xxx).xxxx.xxxx.xx.xxxx. | x(xxxx) | xxx | xxxx | xxx |
|--|---------|-----|------|-----|
| Electronics Module | | | | |
| None | Y | | | |
| Total Level, Graphic Display, 4 ... 20 mA Output, HART | M7A | | | |
| Total Level, Graphic Display, FOUNDATION fieldbus | M7AF | | | |
| Total and/or Interface Level, Graphic Display, 4 ... 20 mA Output, HART | M7B | | | |
| Total and/or Interface Level, Graphic Display, FOUNDATION fieldbus | M7BF | | | |
| Special | Z9 | | | |
| Agency Approvals | | | | |
| General purpose | | Y0 | | |
| IECEX Intrinsically safe | | E1 | | |
| IECEX Flameproof | | E2 | | |
| FM / CSA Intrinsically safe | | N1 | | |
| FM / CSA Explosion proof Housing | | N2 | | |
| Special | | Z9 | | |
| Process Connection Type | | | | |
| None | | | Y0 | |
| Integral Thread, Standard Process Connection | | | P4* | |
| Welded Process Connection | | | P2 | |
| Loose flange for use with NPT threads. Specify flange type, material, and rating | | | P3 | |
| Special | | | Z9 | |
| Process Connection Material | | | | |
| None | | | | Y |
| 304/L Stainless Steel | | | | S4 |
| 316/L Stainless Steel | | | | S6* |
| Carbon Steel | | | | C1 |
| Hastelloy C-276 | | | | H1 |
| Alloy 20 | | | | A2 |
| Monel 400 | | | | M4 |
| Super Duplex Stainless Steel | | | | D2 |
| Special | | | | Z9 |

Base Model

MT5000 Series Guide Wave Radar ordering information continued

| MT5.xxx.xxxx.xx.x.xx(x).x(xxx).xxxx.xxxx.xx.xxxx. | xxxx |
|--|-------|
| Flange or Plug Size // Rating / Type | |
| None | Y |
| 3/4" MNPT Threaded (C1, C1H process couplers) | NTBN* |
| 1.0" MNPT Threaded (C9 process coupler) | NTCN* |
| 1.5" MNPT Threaded (C2, C2H and C8 process couplers) | NTEN* |
| 2.5" MNPT Threaded (C3 process coupler) | NTGN |
| 3/4" G thread, British Pipe Thread (BSPP), (C1, C1H process couplers) | GTBN |
| 1.0" G thread, British Pipe Thread (BSPP), (C9 process coupler) | GTCN |
| 1.5" G thread, British Pipe Thread (BSPP), (C2, C2H and C8 process couplers) | GTEN |
| 2.5" G thread, British Pipe Thread (BSPP), (C3 process coupler) | GTGN |
| 1 in. // ANSI / ASME Class 150 // Raised Face Flange | R11 |
| 1 in. // ANSI / ASME Class 300 // Raised Face Flange | R13 |
| 1 in. // ANSI / ASME Class 600 // Raised Face Flange | R16 |
| 1.5 in. // ANSI / ASME Class 150 // Raised Face Flange | R151 |
| 1.5 in. // ANSI / ASME Class 300 // Raised Face Flange | R153 |
| 1.5 in. // ANSI / ASME Class 600 // Raised Face Flange | R156 |
| 2 in. // ANSI / ASME Class 150 // Raised Face Flange | R21 |
| 2 in. // ANSI / ASME Class 300 // Raised Face Flange | R23 |
| 2 in. // ANSI / ASME Class 600 // Raised Face Flange | R26 |
| 2.5 in. // ANSI / ASME Class 150 // Raised Face Flange | R251 |
| 2.5 in. // ANSI / ASME Class 300 // Raised Face Flange | R253 |
| 2.5 in. // ANSI / ASME Class 600 // Raised Face Flange | R256 |
| 3 in. // ANSI / ASME Class 150 // Raised Face Flange | R31 |
| 3 in. // ANSI / ASME Class 300 // Raised Face Flange | R33 |
| 3 in. // ANSI / ASME Class 600 // Raised Face Flange | R36 |
| 4 in. // ANSI / ASME Class 150 // Raised Face Flange | R41 |
| 4 in. // ANSI / ASME Class 300 // Raised Face Flange | R43 |
| 4 in. // ANSI / ASME Class 600 // Raised Face Flange | R46 |
| 6 in. // ANSI / ASME Class 150 // Raised Face Flange | R61 |
| 6 in. // ANSI / ASME Class 300 // Raised Face Flange | R63 |
| 6 in. // ANSI / ASME Class 600 // Raised Face Flange | R66 |
| DN 25 // PN 25 // Raised Face Flange | D2525 |
| DN 25 // PN 40 // Raised Face Flange | D2540 |
| DN 32 // PN 25 // Raised Face Flange | D3225 |

Note: DIN flanges are per EN1092-1

Base Model

MT5000 Series Guide Wave Radar ordering information continued

| MT5.xxx.xxxx.xx.x.xx(x).x(xxx).xxxx.xxxx.xx.xxxx. | xxxx |
|--|--------|
| Flange or Plug Size // Rating / Type - Continued from previous page | |
| DN 32 // PN 40 // Raised Face Flange | D3240 |
| DN 40 // PN 25 // Raised Face Flange | D4025 |
| DN 40 // PN 40 // Raised Face Flange | D4040 |
| DN 50 // PN 25 // Raised Face Flange | D5025 |
| DN 50 // PN 40 // Raised Face Flange | D5040 |
| DN 65 // PN 25 // Raised Face Flange | D6525 |
| DN 65 // PN 40 // Raised Face Flange | D6540 |
| DN 80 // PN 25 // Raised Face Flange | D8025 |
| DN 80 // PN 40 // Raised Face Flange | D8040 |
| DN 100 // PN 25 // Raised Face Flange | D10025 |
| DN 100 // PN 40 // Raised Face Flange | D10040 |
| DN 125 // PN 25 // Raised Face Flange | D12525 |
| DN 125 // PN 40 // Raised Face Flange | D12540 |
| DN 150 // PN 25 // Raised Face Flange | D15025 |
| DN 150 // PN 40 // Raised Face Flange | D15040 |
| 1.0 in. // ANSI / ASME Class 3000 // NPT-m Hex Plug | P1 |
| 1.5 in. // ANSI / ASME Class 3000 // NPT-m Hex Plug | P15 |
| 2.0 in. // ANSI / ASME Class 3000 // NPT-m Hex Plug | P2 |
| 2.5 in. // ANSI / ASME Class 3000 // NPT-m Hex Plug | P25 |
| 3.0 in. // ANSI / ASME Class 3000 // NPT-m Hex Plug | P3 |
| Any flange not listed above, consult factory | Z9 |

Note: DIN flanges are per EN1092-1

Option codes are on the following page.

Option codes follow the model code with a dash (-)

MT5000 Series guided wave radar transmitter additional option codes

| Additional options | MT5.xxx.xx(x).x(xx)x.xx.xxx(xx).x(x).xx(x)- | xxx | xxx | xxx | xxxx | xx |
|---|--|------------|------------|------------|-------------|-----------|
| Additional Approvals or Certifications | | | | | | |
| Furnished with CRN data package (includes tagging, MTR and hydro tests) | | CRN | | | | |
| Nuclear use, device to be used in a nuclear facility (application must be reviewed by ABB) | | P4 | | | | |
| Special | | CLZ | | | | |
| Sensor options | | | | | | |
| Electro-polish finish on wetted metal surfaces (not possible with cable or coax probe designs) | | | | | SEL | |
| 240 grit polish on wetted metal surfaces (not possible with cable or coax probe designs) | | | | | SEP | |
| Add Teflon sleeve on probe for slip resistance only, not for corrosion resistance | | | | | SEN | |
| Add 1/4" purge or flush port (requires extended process coupler) | | | | | SEB | |
| Extended process coupler, specify distance | | | | | SE1 | |
| Segment probe into 10ft sections, specific rod and coax probe selections | | | | | SE3 | |
| Degreased (oil and grease free) for oxygen or chlorine service | | | | | P1 | |
| Sensor special | | | | | SEZ | |
| Target float options | | | | | | |
| Add 316L target float, minimum fluid specific gravity 0.6 | | | | | | FT1 |
| Special target float per application requirements | | | | | | FZ9 |
| Remote electronics signal cable length (For remote coupler only) | | | | | | |
| 1.5 m (approx. 5 ft) | | | | | | SRW |
| 3 m (approx. 9.8 ft) | | | | | | SRT |
| 5 m (approx. 16.4 ft) | | | | | | SR1 |
| Custom coaxial remote length | | | | | | SRZ |
| Repeat Indicator (for two analog level outputs) | | | | | | |
| RI100 remote indicator (HART only), requires additional 4-20 loop, same material as transmitter | | | | | | AR |

Option codes continue on the following page.

Option codes follow the model code with a dash (-)

| MT5000 Series guided wave radar transmitter additional option codes | | | | | | | | |
|---|--|------------|-----------|-------------|-----------|------------|-----------|------------|
| Additional options | MT5.xxx.xx(x).x(xx)x.xx.xxx(xx).x(x).xx(x)-xxx.xxx.xxx.xxxx.xx. | xxx | xx | xxxx | xx | xxx | xx | xxx |
| Add rod extension rod to probe (material and diameter determined by coupler selec- | | | | | | | | |
| 152.4mm (6.0 in) | | AR1 | | | | | | |
| 304.8mm (12.0in.) | | AR2 | | | | | | |
| 457.2mm (18in.) | | AR3 | | | | | | |
| Special | | AR9 | | | | | | |
| Mounted Accessories | | | | | | | | |
| Centering spacers as specified separately on order | | | AS | | | | | |
| Centering disk for cable weight (cable probes only, disk material same as weight) | | | | | | | | |
| 1.50 in. (38.1 mm) O.D.; 1.50 in. (38.1 mm) Min Stilling Well Size | | | | | | WD1 | | |
| 2.0 in. (50.8 mm) O.D.; 2.0 in. (50.8 mm) Min Stilling Well Size | | | | | | WD2 | | |
| 2.3 in. (58.7 mm) O.D.; 2.5 in. (63.5 mm) Min Stilling Well Size | | | | | | WD3 | | |
| 2.8 in. (71.1 mm) O.D.; 3.0 in. (76.2 mm) Min Stilling Well Size | | | | | | WD4 | | |
| 3.75 in. (95.3 mm) O.D.; 4.0 in. (101.6 mm) Min Stilling Well Size | | | | | | WD5 | | |
| 4.0 in. (101.6 mm) O.D.; 5.0 in. (125 mm) Min Stilling Well Size | | | | | | WD6 | | |
| Custom disk for cable weight (consult factory) | | | | | | WDZ | | |
| Device Identification Plate | | | | | | | | |
| Add stainless steel hang tag with custom tag no. | | | | | | | T1 | |
| Add stainless steel hang tag, custom markings 4 lines, 22 characters per line | | | | | | | TS | |
| Other tagging special | | | | | | | TZ | |
| Electrical Connector Type | | | | | | | | |
| Fieldbus 7/8 in. (without mating plug, recommended for FOUNDATION fieldbus) | | | | | | | U1 | |
| Fieldbus M12 x 1 (without mating plug, recommended for PROFIBUS PA) | | | | | | | U2 | |
| M20 stainless steel adapter | | | | | | | U8 | |
| M20 brass adaptor | | | | | | | U9 | |
| Electrical Connector Special | | | | | | | UZ | |
| Surge Protector | | | | | | | | |
| Surge / Transient protector | | | | | | | | S1 |
| Special Other | | | | | | | | |
| Transmitter Special Option | | | | | | | | STT |
| Tower length extension special length - meter insulation capability | | | | | | | | TEZ |
| special paint or treatment on housing | | | | | | | | STH |
| Special paint or treatment on flange | | | | | | | | STF |

Additional requirements and order comments are continued on the following page.

All codes located behind the // are for additional requirements and order comments.

These codes will not be included on the device tag.

All codes located behind the // are for additional requirements and order comments.

These codes will not be included on the device tag.

MT5000 Series guided wave radar additional option codes

| Additional requirements and order comments | MT5.....x- ...// | xx | xxx |
|---|------------------|----|-----|
| Certificates | | | |
| Test report 2.2 acc. EN 10204 | | C1 | |
| MTR 3.1, Material monitoring with inspection certificate 3.1 acc. EN 10204 | | C2 | |
| MTR 3.2, Material monitoring with inspection certificate 3.2 acc. EN 10204 | | C3 | |
| Declaration of compliance with the order 2.1 acc. EN 10204 | | C4 | |
| Material monitoring NACE MR 0175, MR 0103 with inspection certificate 3.1 acc. EN 10204 | | CN | |
| Printed record of configured settings in transmitter | | CG | |
| With hydrostatic test report | | CH | |
| With PMI report on wetted metal materials | | CJ | |
| Other certificates | | CZ | |
| Drawings | | | |
| Drawings for approval required prior to construction | | | GD1 |
| Drawings for record required | | | GD2 |
| Certified as built drawings required | | | GD3 |
| Other drawings | | | GDZ |

Additional requirements and order comments are continued on the following page.

All codes located behind the // are for additional requirements and order comments.

These codes will not be included on the device tag.

MT5000 Series guided wave radar additional option codes

| Additional Requirements and coder comments | MT5.....x- ...//xx.xx.xx.xxx. | xx | xx | xx | xx |
|--|-------------------------------|----|----|----|----|
| Documentation Language (installation, operation and maintenance manual) | | | | | |
| German | | M1 | | | |
| Italian | | M2 | | | |
| Spanish | | M3 | | | |
| French | | M4 | | | |
| English | | M5 | | | |
| Russian | | MB | | | |
| Others | | MZ | | | |
| Calibration Type | | | | | |
| 3-point calibration verification certificate, factory default 90, 50 and 10% of measurable zone, or customer specified points within measurable zone | | | R3 | | |
| 5-point calibration verification certificate, factory default 90, 75, 50, 25 and 10% of measurable zone, or customer specified points within measurable zone | | | R5 | | |
| Custom Linearization or Strapping table entered (up to 20 pts). | | | RL | | |
| Witnessed calibration with certificate | | | RW | | |
| Special calibration | | | RZ | | |
| Programming and Parameter Settings | | | | | |
| Custom parameter settings | | | | | N6 |
| Software Special | | | | | |
| Specified software version | | | | | V1 |
| Custom software version | | | | | VZ |

Probe Length

| | |
|------------------|-----|
| Minimum 24 in. | in. |
| Minimum 609.6 mm | mm |

Contact us

ABB Inc.

Measurement & Analytics

3400. Rue Pierre-Ardouin

Québec, Québec G1P 0B2 CANADA

Office Phone: +1 418.877.2944 ext. 2109

Direct Line : +1 581.628.2109

E-mail: Radars@ca.abb.com

www.abb.com/level

ABB

Measurement & Analytics

No. 5, Lane 369, Chuangye Road,

Kangqiao Town, Pudong District

Shanghai, 201319, P.R.

China

Tel: +86 10 64231407

Fax: +86 10 64371913

www.abb.com/level

Note

We reserve the right to make technical changes or modify the contents of this document without prior notice. With regard to purchase orders, the agreed particulars shall prevail. ABB does not accept any responsibility whatsoever for potential errors or possible lack of information in this document.

We reserve all rights in this document and in the subject matter and illustrations contained therein. Any reproduction, disclosure to third parties or utilization of its contents - in whole or in parts - is forbidden without prior written consent of ABB.

Copyright© 2017 ABB

All rights reserved