

---

WHITE PAPER

# Keeping the operator in focus

## The four pillars of operator effectiveness



# Introduction

This paper shows how the four pillars of operator effectiveness lead operators to greater awareness, faster response and better decisions.

Operator effectiveness is fundamental to power plant performance. With the daily decisions of control room personnel directly impacting safety, production, process availability and quality, it is important to keep the operator in focus. However, with fewer operators, a generational shift in the operator workforce and increasing complexity in plant operations, it is becoming ever more challenging for operators to remain “in focus”.

To allow operators to reach their full potential, a set of best practices and technologies is presented. These solutions are designed to filter out plant control complexity and situational chaos. They allow operators to quickly and effectively gather inputs and assess abnormal situations, collaborate with others as needed, and then act on the problem as smoothly and intuitively as possible.

The benefits of the four pillar approach is a better equipped operator, one who is well-trained and has greater visibility of plant issues, quick access to relevant information and streamlined workflows, all of which lead to improved, informed and timely decision-making. Ultimately, these improvements will increase plant productivity, efficiency, asset utilization, safety and environmental compliance – in other words, they will deliver greater profitability and company success, as the case studies in this paper show.

## Industry trends

The power generation industry, like most manufacturing industries, is undergoing long-term systemic change.

## Doing more with less

To remain competitive, businesses are trying to do more with less, which has led to the consolidation, centralization and collaboration of operations. Striving to use their resources more efficiently and to compensate for the continuing loss of experienced operators and process-knowledgeable personnel, companies now have fewer

people managing larger plant areas.

## Flexible production and virtual power plants

The increasing use of renewable energy requires power generators to remotely manage their mix of generation assets as a virtual power plants. In this kind of arrangement, prompt and informed decisions are critical to grid stability and company performance, as operators must ramp up and ramp down thermal plants to accommodate the fluctuating supply of renewable power.

## Making the most of plant data

Today, power plants produce more data in a single day than they did in a month just 10 years ago. Terabytes of data are generated daily by equipment, smart devices, sensors, DCS and PLC systems, and business systems. The adoption of standard communication protocols has led to an explosion in plant data and the corresponding analytics, including required compliance and business reporting. The abundance of data provides many opportunities for preventive and predictive maintenance, improved plant performance, process efficiency and company profitability. However, if not provided in context, data can result in information overload and lead to further process complexity, production loss and negative impact on the bottom line.

These trends will impact personnel in all areas of the power plant. However, there is no role more affected or critical to success than the plant operator.

---

The question is: How do we put the operator in the best position to successfully adapt to these changes?

### Why focus on the operator?

The people who sit in the control room and operate the production process are among the plant's most important assets. Their ability to make the correct decision at the right time has a huge impact on plant profitability, safety and reliability. Phrased another way, by taking the wrong decision at the wrong time the operator could harm fellow workers, the surrounding community and environment, as well as seriously reduce plant profitability.

Most traditional control rooms are oriented to "normal" steady-state plant operations, but when abnormal situations arise, the operators are ill-equipped to address them effectively. Yet, atypical situations are not as unusual as they may seem. ARC Advisory Group estimates that 80 percent of unscheduled downtime (abnormal situations) is preventable and that half of it is the result of operator error. In the process industries, these controllable production losses are estimated to cost \$20 billion annually. According to the U.S. Chemical Safety Board, safety incidents are also often caused by operators making poor decisions due to inadequate information and training.

Clearly, there are compelling financial and safety reasons for focusing on plant operators. So, the next question that needs to be asked is: Where is the operator's focus in today's control room?

### Where is the operator's focus?

A typical control room is a complex environment, incorporating different automation systems and multiple operator interfaces, indicators and control panels. Often there is no overview screen to help the operator understand the bigger picture. CCTV and telecom equipment are usually poorly integrated, there are too many keyboards and input devices, and the desks and displays are not designed ergonomically or with operator effectiveness in mind. Hundreds or even thousands of needless alarms bombard the operators each day, each alarm requiring a decision and action. An additional complication is that large numbers of experienced operators are retiring and companies are having difficulty attracting and retaining younger, qualified individuals.

As a result, operators often have a poor grasp of what is happening in the plant, are unfamiliar with the process and older technologies in place and therefore prone to stress and fatigue, which impairs good decision-making. The outcome is often suboptimal performance, not because of any fault of the operator, but because they are not given the tools to do their job properly and professionally.

### The four pillars of operator effectiveness

There are many ways to improve operator effectiveness. Some are directly related to the automation system while others are not. At ABB, we've been working on the issue of operator effectiveness for many years, looking at how to empower the operators so that they can do their job more efficiently and make correct, informed and timely decisions. To remove the clutter and make it easier to develop a strategy, ABB has grouped its technology and best-practice solutions into four core disciplines known as the Four pillars of operator effectiveness (see Figure 1).

Specifically, these are:

- 1) Plant system integration:** Integrating plant operations into a single automation system that transforms raw data into actionable information in context;
- 2) High-performance HMI:** Delivering a high-performance human machine interface that is designed to provide clear, intuitive process graphics, user-context navigation and simplified alarm management;
- 3) Operator competency:** Improving operator knowledge and decision-making through training and process simulation; and
- 4) Human factors and ergonomics:** Designing ergonomic control rooms to enhance operator performance and reduce stress and fatigue.

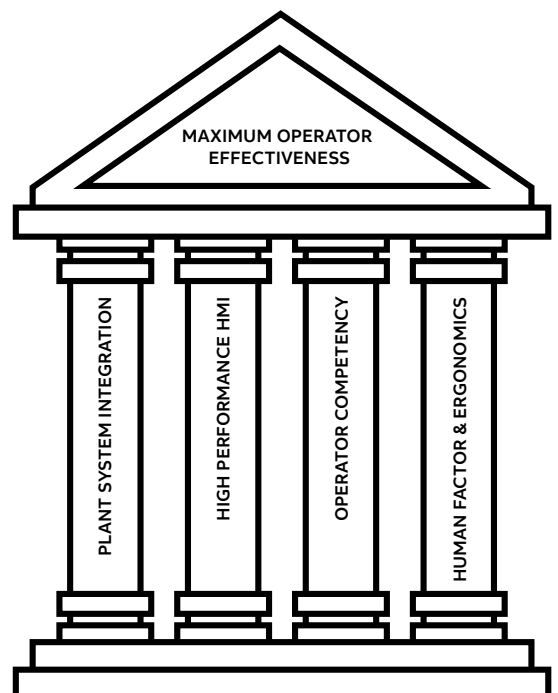

## Keeping the operator in focus

### The four pillars of operator effectiveness

#### 1. Plant system integration

Operators need to access the information they need when they need it. They also need to be able to see the complete picture of the plant process or a potential problem so that they can take the correct action. Those two simple statements require comprehensive integration of all the plant information systems and collaboration and communication tools. Often, these systems and tools are like islands, operating on a standalone basis and disconnected from one another.

But it doesn't have to be like that. Thanks to standard communication protocols (like OPC, Modbus TCP, IEC 61850, DNP 3.0 and IEC 870-5-101/103/104) and device communication standards (like PROFIBUS and HART), it is now possible to seamlessly integrate disparate information systems, tools and devices into a single platform (see Table 1), more reliably and less costly than custom interfaces and hardwired connections. Through this seamless access, the operator benefits from a holistic view of the plant with consistent presentation of data, alarms and events..

#### Vertical and/or horizontal integrated islands for total plant automation

Automation Systems (DCS, PLC)
Safety Instrumented Systems (SIS, ESD, PSD)
Electrical Control Systems (ECS, Electrical SCADA)
Power Management Systems (PMS)
Video Monitoring Systems
Public Address (PAS, PA Systems)
Maintenance Management Systems (CMMS)
Document Management (DMS)
Analyzers
Alarm Annunciation Panels/Alarm and Event Historians
Telecommunication Systems (Telecoms)
Enterprise Resource Planning (ERP, MOM, MES)

Removing the barriers that isolate different automation systems and devices makes it possible to manage and optimize the plant's assets: field instruments; process, electrical and environmental equipment; control loops; power supplies; communication and network components; mechanical equipment; and so on. With integration and seamless collaboration between operations and maintenance via today's high-performance HMIs, manual data entry errors, duplication of work, and delayed actions can be eliminated. Operators can, for instance, identify and monitor degrading asset performance before failure occurs. When the time comes to repair or replace the failing asset, the operator can review active work orders and if needed create and submit new work orders to the computerized maintenance management system (CMMS) electronically from the HMI (see Figure 2).

This streamlines work processes and improves the ability to address performance degradation before it affects production. It allows companies to move away from reactive or corrective repairs to best-in-class predictive procedures, significantly reducing their maintenance costs. A U.S. Department of Energy study in 2012 found that a predictive maintenance program can reduce plant maintenance costs by 8-12%. Such a program, the study says, would typically eliminate 70-75% of breakdowns and 35-45% of downtime, resulting in a production increase of 20-25%.

With nearly 1 million new malware threats released every day and greater use of open communication standards, it is imperative to protect physical, intellectual and human assets against cyber threats. Of course, no single solution can keep increasingly interconnected systems secure, so companies like ABB work with customers to create a defense-in-depth approach where multiple security layers detect and deter threats – if, where and when they arise. To support this, the integrated plant HMI must provide a secure and reliable operations environment with built-in security features including user authentication, role-based access control, back-up / restore, hardened hosts, host firewall configuration, anti-virus protection, network zones, and security patch validation.

Table 01 Seamless integration of disparate automation systems and devices

02 Removing barriers to streamline rotating equipment remediation work process

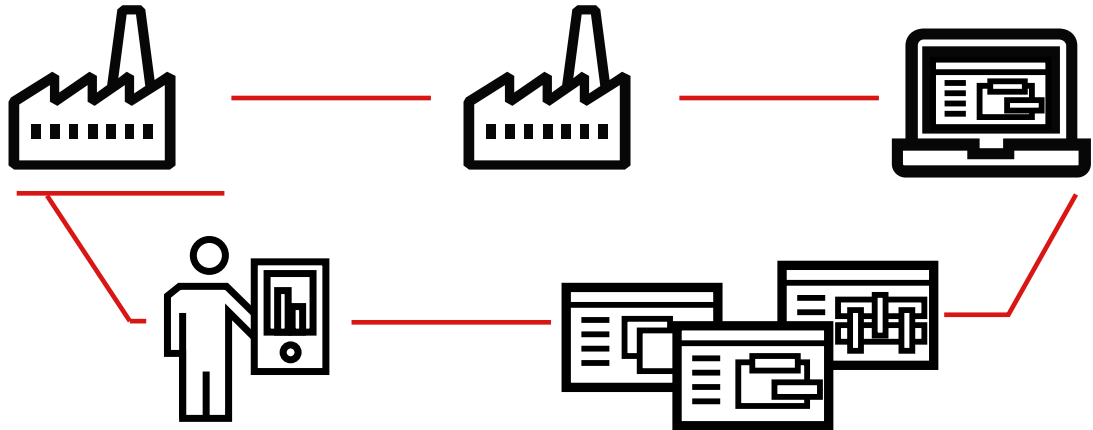

## 2. High-Performance HMI

Integrated operations and digitalization generate a wealth of raw data and with it the risk of burying operators under a mountain of information. The challenge for HMI designers is to find a way to provide operators with the information they need to make a correct and timely decision, while excluding all the information they do not need.

The new generation of high-performance HMIs is designed to do this. They combine fast, intuitive navigation with simplified gray-scale graphics and integrated alarm management to eliminate information overload and heighten operator awareness. Users can personalize their overview of the plant process so that they can display, or immediately gain access to, the information they need. Accessing information, and taking action on that information, should never require more than two clicks of the mouse (display yoking).

Closely related to personalization is contextual navigation, by which different user groups like operations, engineering, maintenance and management can access graphic displays and information that are optimized for each group. This enables them to collaborate more easily in their own user-specific environment and share relevant information with colleagues.

In fact, it is no exaggeration to say that the human machine interface is the key to operator awareness. Compare the two graphic interfaces in Figure 3. Conventional graphics like the one on the left use different colors to highlight different states or parts of the process. It may be colorful and attractive on the eye, but it provides the operator with far too much information. Each color has to be looked at and its meaning interpreted, a process which can take several seconds. Far more efficient are gray-scale graphics like the one on the right, which reserve color for alarms and abnormal situations. The operator sees the color instantaneously and can respond immediately.

However, there is a lot more to high-performance graphics design than gray-scale layouts. High-performance graphics provide operators with easy recognition of plant and product performance health. Although, each plant has a few operators that can “sense” the state of the plant process by watching the numbers on the screens, less experienced operators cannot. By providing easy recognition of trending abnormal situations (see Figure 4), each operator can maintain the process at higher performance levels, leading to real economic gains for the enterprise. Research underscores this point, showing that operators are five times more likely to detect abnormal situations before an alarm occurs with the new generation of high-performance HMIs than with conventional graphics. Once an alarm is triggered, operators solve the problem in about half the time than with traditional interfaces.

03 Conventional graphics (above) and grey-scale graphics (lower)

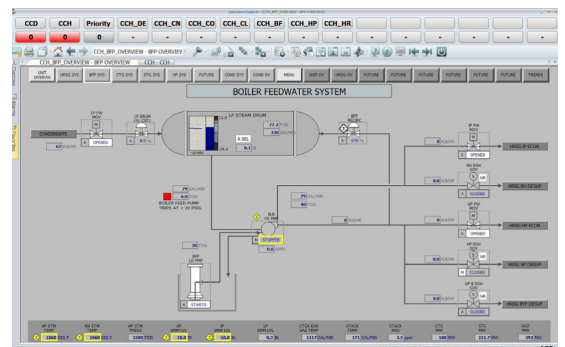
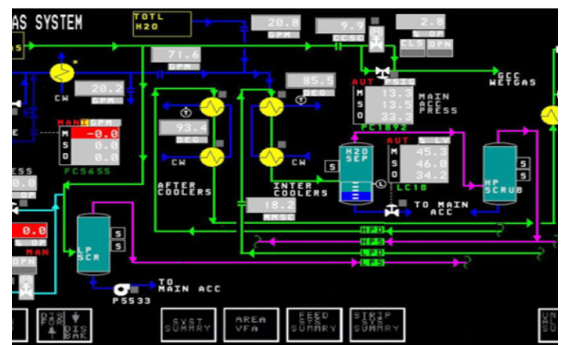

## Keeping the operator in focus

The four pillars of operator effectiveness

04 Abnormal situational awareness display heirarchy provides all operators with a range of graphics from top level surveillance to drilled down system, sub-system and root cause diagnostic detailed graphics

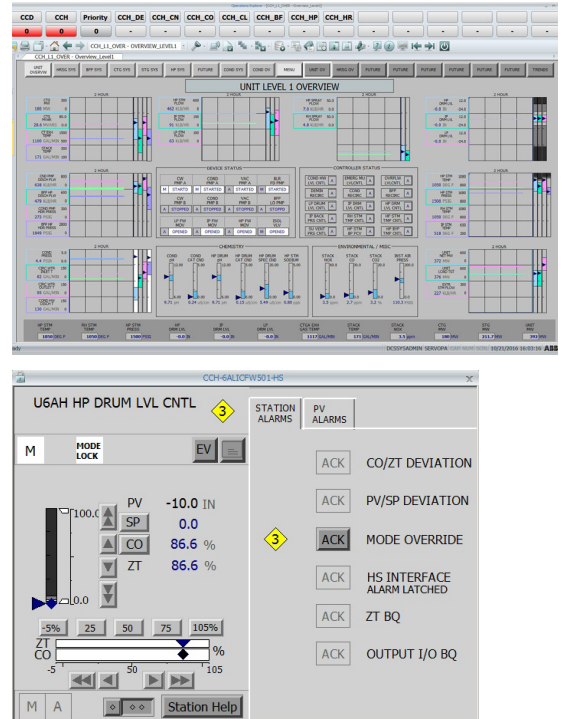
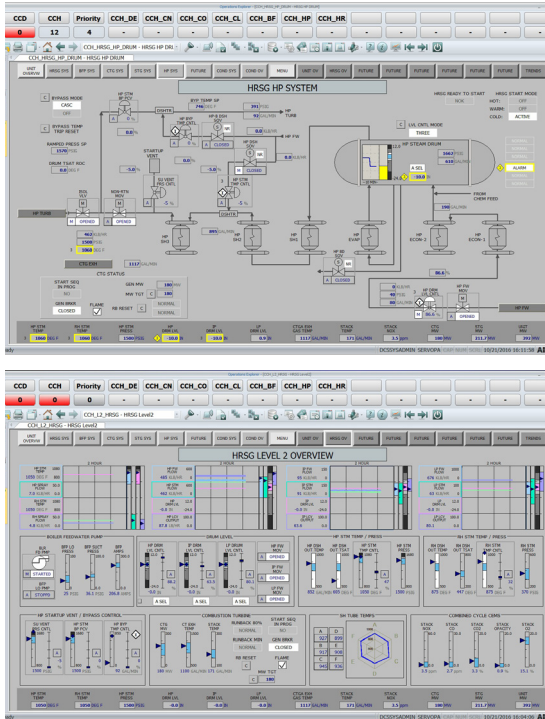

High-performance HMIs not only make abnormal situations immediately visible on the screen, they also significantly reduce the number of alarms that compete for the operator’s attention. The maximum number of alarms that the human mind can deal with is just seven, give or take two in any 10-minute period. Unfortunately, as seen in Table 2, operators are bombarded with a constant stream of alarms. In the power industry alone, operators typically deal with 2,000 alarms per day

and 350 in a 10-minute peak alarm period. It is therefore not surprising that operators become ambivalent to the constant drone of alarms, tending to ignore “nuisance” alarms and run the plant on instinct. Some even cut the wires to the horn because “it goes off too often”. Clearly, operators cannot do their job effectively when critical alarms are intermixed with hundreds or even thousands of non-critical or nuisance alarms.

Table 02 Average number of alarms in selected industries (Source: MatrikonOPC)

	EEMUA	O&G	PetroChem	Power	Other
Average alarms per day	144	1200	1500	2000	900
Average standing alarms	9	50	100	65	35
Peak alarms per 10 minutes	10	220	180	350	180
Average alarms/10 minute interval	5	6	9	8	5
Distribution % (Low/Med/High)	80/15/5	25/40/35	25/40/35	25/40/35	25/40/35

Standards like EEMUA 191 and ISA SP 18.2 have long recognized the need to reduce the number of alarms to match the operator's cognitive capacity. In this way, the operator is focused and able to act on critical alarms when they occur. High-performance HMIs like S+ Operations have advanced alarm handling and analysis tools that support implementation of alarm management strategies based on EEMUA 191 and ISA 18.2 requirements, thereby ensuring that each alarm generated will alert, inform and guide the operator to take the proper action (see Figure 5).

—  
05 Next generation HMI 18.2/EEMUA 191-compliant alarm analysis tools help users categorize occurring alarms, while the integrated alarm management system keeps operators focused.

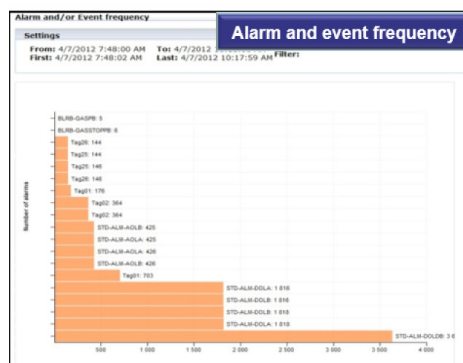
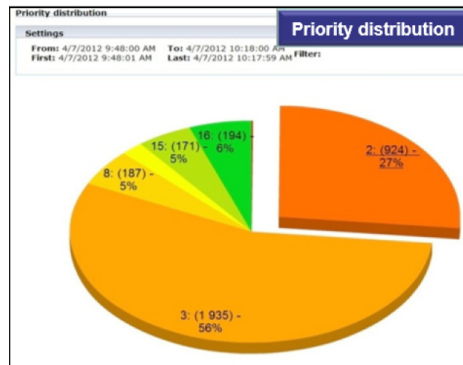
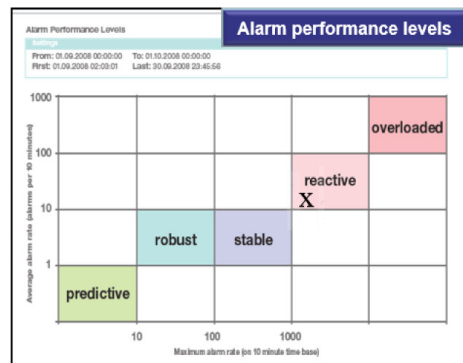
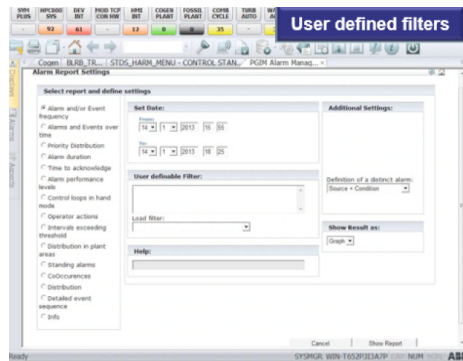

- An advanced alarm management strategy should fulfill the following objectives:
  - The purpose of an alarm system is to direct the operator's attention to plant conditions requiring timely assessment or action;
  - Alarms should be presented at a rate that operators can deal with;
  - Each alarm presented to the operator should be useful and relevant to the operator; and
  - Each alarm should have a defined response.

Advanced alarm analysis tools

- Instantaneous reports
- Alarm/Event frequency
- Alarms over time
- Priority distribution
- Alarm duration
- Time to acknowledge
- Alarm performance
- Loops in manual
- Operator actions
- Exceeding threshold
- Standing alarms
- Co-occurrences

Alarm presentation features

- Alarm grouping
- Alarm filtering
- Alarm inhibiting
- Priority shelving
- Alarm suppressing

## Keeping the operator in focus

### The four pillars of operator effectiveness

06 Training simulators familiarize operators with their actual work environment

#### 3. Operator competency

Operator training in the process and power generation industries tends to take place in the classroom or in the “live” control room itself. Both types of training still have their uses, but neither can match the use of high-fidelity process simulators to ensure operator competence and instill confidence in dealing with routine procedures and abnormal situations.

Tight integration of a simulator with the plant control system provides the most faithful representation of process performance. ABB Ability™ Symphony® Plus simulators, for example, use the same engineering data, visualization and control logic as the Symphony Plus environment, but connected to a dynamic process model. This means that the simulation environment precisely reflects the control system’s real-world performance. In addition to simulating the various functions of the control system, it can capture snapshots and freeze / resume process dynamics to focus training on specific situations.

For a new plant, use of an operator training simulator can shorten initial start-up, improve operator performance and prevent trips and incidents. Operational procedures can be tested and display and control strategies tweaked, all in advance of initial start-up instead of after the plant is up and running. Software changes and new engineering code can also be tested in the simulator before they are implemented in the plant process.

The savings in time and expenditure from using high-fidelity simulators can be substantial. One ABB customer started up a new and very large plant three weeks ahead of schedule, thanks to conducting operator training and process testing in simulators and in parallel with construction. And, a recent survey by the Electric Power Research Institute (EPRI) estimated that average annual savings of about \$4,500 per megawatt of generating capacity could be achieved by using training simulators.

07 Human factors and ergonomics focus on the “fit” between user, equipment and work environment.

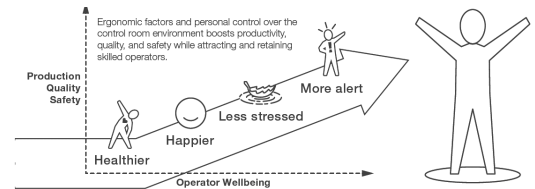

#### 4. Human factors and ergonomics

The control room is the nerve center of the plant process, where the daily decision-making of the operators has a direct impact on the plant’s output and profitability. Operators are human beings; they are subject to stress, fatigue, discomfort and distractions. For operators to be effective, we have to recognize the importance of human factors and the need to make the work environment conducive to efficiency and wellbeing.

The best way to do this is to aim for a perfect fit between the operator, desktop equipment and control room environment. Each operator should have their own display to arrange graphics as they want them and to get an optimal view of that part of the process under their control. The desks and seats should be adjustable and the keyboards equipped with hotkeys for easy navigation in monitor clients. The room should have features like dimmable lighting, adjustable micro-ventilation for each operator station, and a directional sound system, all accessible from each station. The room should also include space for visitors and other non-essential personnel, an area for collaboration and another for relaxation. These areas are not only functional, they create a focused and distraction-free control area (see Figure 8).

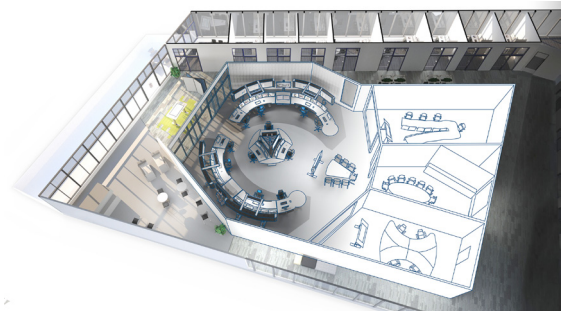



What may come as a surprise is that all this can be achieved in about a third less floor space than typical older plant control rooms. Because operators have personalized, interactive displays, the need for huge, full-wall screens is reduced or eliminated. Directional sound, which targets just the operator station, means that operators can sit closer to one another, without being a distraction.

**Case studies**

There are scores of examples and customer testimonies of how measures to improve operator effectiveness have increased productivity and reduced operating costs. Here are two examples from ABB’s portfolio of case studies.

In example 1, a gas plant improved control room operations and corrected its record of poor alarm management. Missed alarms, among other opera-

**Conclusion**

The evidence shows that small improvements in operator effectiveness can have a big impact on plant profitability. By following the four pillars of operator effectiveness and providing operators with the tools and environment they need to run the plant efficiently, significant improvements in availability, performance and product quality will follow. Spurious trips, process upsets and unplanned outages that affect availability will be avoided, the time between an asset malfunction occurring and a decision made to correct it will be reduced, and reputational and quality issues like breaches in environmental compliance, safety incidents and the imposition of regulatory fines will be minimized.

Table 03 Comparison of operator effectiveness in a conventional DCS environment against one using high-performance HMIs

Task	With traditional HMI	With high performance HMI	Result
Detecting abnormal situations before alarms occur	10% of the time	48% of the time	5x increase
Success rate in handling abnormal situations	70%	96%	26% over base case
Time to complete abnormal situation tasks	18.1 min.	10.6 min.	41% reduction

tional and ergonomic issues, were singled out as a major contributor to compressor trips that resulted in downtime and lost production. Installing an effective alarm management system reduced the number of alarms from more than 300 per 10-minute period to just three, well below the EM-MUA standard of 7 +/- 2. This helped reduce the compressor trips from 27 to 7 over a one-year period, saving an estimated \$2 million.

Example 2 is a study of plant operators that measured and compared their situational awareness in a conventional distributed control system environment against one in a high-performance HMI environment using simplified gray-scale abnormal situation graphics and integrated alarm management. The figures in table 3 speak for themselves. They translate into estimated cost savings of \$800,000 per year:

**About the author**

Mark Bitto is the Global Products Marketing Manager for ABB’s power generation business.

Mark is a career ABB / Bailey Controls employee, with more than 32 years of experience in the automation industry with specialist knowledge of ABB’s Symphony Plus, INFI 90 and System 800xA systems. Mark has held positions in product marketing, business development, product management, industry marketing (specializing in industrial steam and utilities) and systems engineering. In addition, Mark is ABB’s lead representative to the U.S. based Council of Industrial Boiler Owners (CIBO) and is actively engaged in its various committees.

Mark holds a Bachelor of Science degree in Chemical Engineering from The Ohio State University in Columbus, Ohio, USA and a Master in Business Administration from Cleveland State University in Cleveland, Ohio.

—  
[abb.com/symphonyplus](http://abb.com/symphonyplus)  
[abb.com/powergeneration](http://abb.com/powergeneration)  
[abb.com/water](http://abb.com/water)

**Note:**

We reserve the right to make technical changes to the products or modify the contents of this document without prior notice. With regard to purchase orders, the agreed particulars shall prevail. ABB does not assume any responsibility for any errors or incomplete information in this document. We reserve all rights to this document and the items and images it contains. The reproduction, disclosure to third parties or the use of the content of this document – including parts thereof – are prohibited without ABB's prior written permission.

Copyright© 2017 ABB All rights reserved. ABB Ability is a trademark of ABB. Symphony and Symphony Plus are registered or pending trademarks of ABB. All rights to other trademarks reside with their respective owners.

