

Electrical installation solutions for buildings – Technical details

Protection and safety

Protection and safety technical details

Overvoltage protection overview –	
IEC/EN standards	5/2
IEC/ EN 61643 SPD standard series focus	5/3
OVR Surge Protective Devices	5/4
E 90 fuseholders	5/32
E9F fuses	5/36
EPD 24-TB-101	5/81
SQZ3 phase and sequence relays	5/85
E 236 undervoltage monitoring relays	5/86
Insulation monitoring devices	5/87
TI insulating transformers	
for medical locations	5/91
QSO switchboard for medical locations	5/92
Insulation monitoring devices	5/95

Protection and safety technical details

Overvoltage protection overview – IEC/EN standards

International safety standards establish a requirement for assessing protection against transient overvoltages (surges) as an integral part of satisfactory electrical system design. A summary is provided within IEC 60364 standard for electrical installations of buildings regarding the requirements of surge protective devices (SPDs)

IEC 60364 assesses the need to protect AC power circuits, although cross-references transient overvoltage or surge protection on other metallic services including data, signal and telecommunications lines, as defined by IEC/EN 62305 Standard for Lightning Protection.

It covers transient overvoltages of atmospheric origin (lightning) or as a result of electrical switching, through two sections:

- **Section 443** which defines the criteria for risk assessment to use SPDs, considering factors such as levels of consequential loss due to overvoltages and the equipment rated impulse voltage
- **Section 534** which outlines the parameters for selection and installation of SPDs as appropriate, to ensure satisfactory protection of the structure itself and its contents, its personnel and electronic systems and electrical equipment

Risk assessment

Section 443 establishes that SPD are required where the consequences caused by overvoltage leads to:

- (a) results in serious injury to, or loss of, human life, (e.g. hospitals, care homes, home dialysis equipment)
- (b) results in interruption of public services and/or damage to cultural heritage, (e.g. power stations, data centres, heritage status buildings like museums, castles)
- (c) results in interruption of commercial or industrial activity (e.g. banks, hotels, supermarkets, industrial plants, farms)
- (d) affects a large number of collocated individuals (e.g. offices, universities, schools, residential tower blocks)

For all other cases than above a simplified risk assessment to determine the Calculated Risk Level CRL shall be conducted.

Note that a comprehensive risk assessment method to (IEC/EN 62305-2) must be used for high risk installations such as nuclear or chemical sites where the consequences of transient overvoltages could lead to explosions, harmful chemical or radioactive emissions thus affecting the environment.

In all cases, IEC/EN 62305 which would require installation of equipotential bonding SPDs where a structural lightning protection system (LPS) is installed, or there is a risk of a direct lightning stroke to a service line.

Selection & installation of SPDs

Section 534 provides guidance on the selection and installation of SPDs to limit transient overvoltages.

The selection of an SPD is dependent on its location within the installation, the equipment rated impulse voltage at this location, and the expected transient overvoltage energy that the SPD is required to limit. The largest transient overvoltages are expected at the service entrance, i.e. at the origin of the installation.

Additionally transient overvoltages can be anticipated at sensitive and critical equipment as a result of electrical switching within the installation. SPDs should therefore be installed as appropriate at main distribution board level, subdistribution board level to protect sensitive equipment, and locally to protect critical equipment.

Where multiple SPDs are installed on the same conductor, these should coordinate with each other to ensure protection levels are not compromised within the system.

Where SPDs are required they must be tested in line with SPD product standards IEC/EN 61643 series. Power SPDs are classified to IEC/EN 61643-11 by Class /Type respectfully. High energy Class I/Type 1 tested SPDs (Type 1) must be installed at the service entrance where a structural LPS is installed or there is an overhead metallic service line at risk from a direct lightning stroke.

Class I tested/Type I SPDs however do not provide protection to electronic systems. Transient overvoltage SPDs (Class II tested/Type 2 and Class III tested/Type 3) are required downstream to protect sensitive and critical equipment. These SPDs protect against the transient overvoltages caused by indirect lightning (inductive or resistive coupling) and the electrical switching of large inductive loads.

Combined Class/Type SPDs are classified with more than one Class test/Type, e.g. Class I+II tested SPD to IEC or Type 2+3 to EN. Such SPDs can provide both lightning current with overvoltage protection in addition to protection between all conductor combinations (or modes of protection) within a single unit. Combined Type SPDs provide high surge current handling combined with better overvoltage protection levels (U_p) a performance parameter of an SPD.

The most important characteristic for an SPD is its voltage protection level (U_p) and not its energy withstand (e.g. I_{imp}). SPDs with lower voltage protection levels (or let-through voltage) offer much better protection to sensitive and critical electronic systems, including:

- Minimal equipment stress (i.e. keeping circuit degradation to a minimum)
- Reduced risk from additive inductive voltages on the SPDs connecting leads
- Reduced risk from downstream voltage oscillations

Protection and safety technical details

IEC/ EN 61643 SPD standard series focus

ABB SPDs meet the performance parameters defined in International & European SPD product standards:

- IEC/EN 61643-11 Surge protective devices connected to low-voltage power systems - requirements and tests.
- IEC/EN 61643-21 Surge protective devices connected to telecommunications and signalling networks - performance requirements and testing methods.

These parts of the IEC/EN 61643 standard apply for all SPDs providing protection against lightning (direct and indirect) and transient overvoltages.

IEC/EN 61643-11 covers AC mains protection, for 50/60 Hz AC power circuits and equipment rated up to 1000 VRMS AC and 1500 V DC.

IEC/EN 61643-21 covers telecommunications and signalling networks with nominal system voltages up to 1000 VRMS AC and 1500 V DC.

Within these parts to the standard is defined:

- The electrical requirements for SPDs, including voltage protection and current limiting levels, status indication and minimum test performance.
- The mechanical requirements for SPDs, to ensure an appropriate quality of connection, and mechanical stability when mounted.
- The safety performance of the SPD, including its mechanical strength and its ability to withstand heat, overstress and insulation resistance.

The standard establishes the importance of testing SPDs to determine their electrical, mechanical and safety performance.

Electrical tests include impulse durability, current limiting, and transmission tests. Mechanical and safety tests establish levels of protection against direct contact, water, impact, the SPD installed environment etc.

For voltage and current limiting performance, an SPD is tested according to its Type (or Class to IEC), which defines the level of lightning current or transient overvoltage it is expected to limit/divert away from sensitive equipment.

Tests include Class I impulse current (10/350 waveform), Class I & II nominal discharge current (8/20 waveform), Class I & II voltage impulse and Class III combination wave tests for SPDs installed on power lines, and Class D (high energy), C (fast rate of rise), and B (slow rate of rise) for those on data, signal and telecoms lines.

SPDs are tested with the connections or terminations following manufacturer's instructions, as per the expected SPD installation.

Measurements are taken at the connectors/terminals. Three samples of an SPD are tested and all must pass before approval is granted.

SPDs which have been tested to IEC/EN 61643 should be suitably labelled and marked, to include the relevant performance data for their application.

SPD application and installation standards Within IEC/EN 61643 there are two further standards which provide recommendations on the selection and installation of SPDs.

These are:

- IEC/EN 61643-12 Surge protective devices connected to low-voltage power systems - selection and application principles.
- IEC/EN 61643-22 Surge protective devices connected to telecommunications and signalling networks - selection and application principles.

These application standards should be used with IEC/EN 61643-11 and IEC/EN 61643-21 respectively. Each application standard provides information and guidance on:

- Risk assessment and evaluating the need for SPDs in low-voltage systems, with reference to IEC/EN 62305. Lightning Protection standard and IEC 60364 Electrical installations for buildings.
- Important characteristics of an SPD (e.g. voltage protection level) in conjunction with the protection needs of equipment (i.e. its rated impulse voltage or impulse immunity – voltage).
- Selection of SPDs considering the entire installation environment, including their classification, function and performance.
- Coordination of SPDs throughout the installation (for power and data lines) and between SPDs and RCDs or over-current protective devices.

Through following the guidance in these documents, appropriate specification of SPDs to meet the installation requirement can be achieved.

ABB also provide SPDs tested to UL standards - a summary of the differences in between IEC SPD test standards and UL SPD test standards terminology can be found on the following pages.

Protection and safety technical details

OVR Surge Protective Devices

Selection of surge protective devices

The IEC standard introduced the concept of lightning protection zones (LPZ) to help in selecting the correct surge protection. This concept ensure the gradual reduction by stages of the energies and overvoltage caused by lightning or switching operations. This logic of coordination in the protection is what we call the “stepping protection”.

External Zones:

- LPZ 0A Unprotected zone outside the building subject to direct lightning strikes and therefore may have to handle to the full lightning current and lightning electromagnetic field.
- LPZ 0B Zone protected against direct lightning strikes by external air terminal and where the threat is the full lightning electromagnetic field.

Internal Zones:

Zones inside the building which are protected against direct lightning flashes.

- LPZ 1 Zone subject to partial lightning or surge currents. Type I SPDs shall be installed at the boundary between LPZ 0A and LPZ 1 to reduce the entrance of lightning currents through power lines.
- LPZ 2...n Zone where the surge current is limited by current sharing and where the surge energy is reduced by additional surge protection like SPDs. Type 2 SPDs are installed at the boundaries of each zone, i.e. LPZ 1 and LPZ 2, LPZ 2 and LPZ 3, etc.

Lightning protection zones description (IEC 62305-4):

It consists in dividing a building in several volumes: the protection zone. The objective is to ensure that the LPZ gives enough protection to the equipment inside this zone. To do so, SPDs are installed at the protection zone boundaries. Each time an SPD is installed, a new protection zone is created.

Current impulse:

The 10/350 and 8/20 impulse waves are used in the Class I and Class II SPDs tests. The first number gives the rising time of the current impulse to reach 90% of the peak level and the second number gives the time to half value in microseconds (μs).

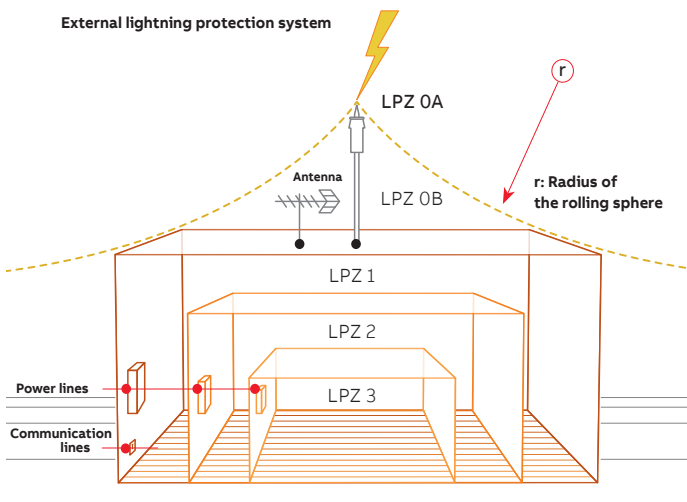
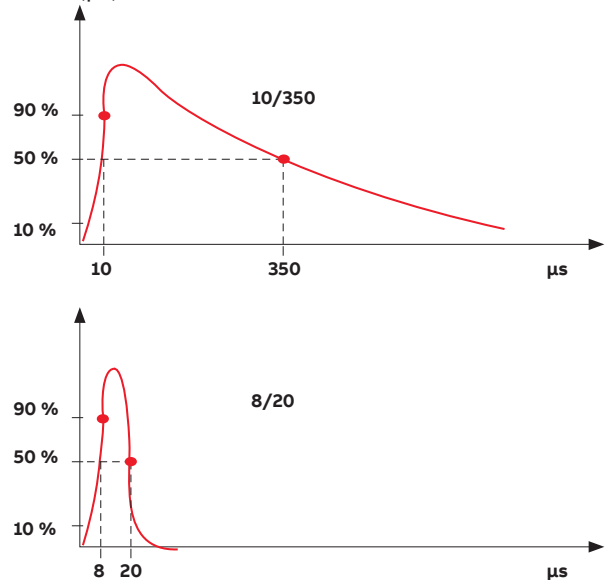

Protection and safety technical details

OVR Surge Protective Devices

Protection in common and/or differential mode

Common mode

Overvoltages in common mode concern all neutral point connections. They occur between the live conductors and earth (e.g. phase/earth or neutral/earth). The neutral conductor is a live cable, as well as the phase conductors. This overvoltage mode destroys not only earthed equipment (Class I), but also non-earthed equipment (Class II) with insufficient electrical insulation (a few kilovolts) located close to an earthed mass. Class II equipment that is not situated close to an earthed mass is theoretically protected from this type of attack.

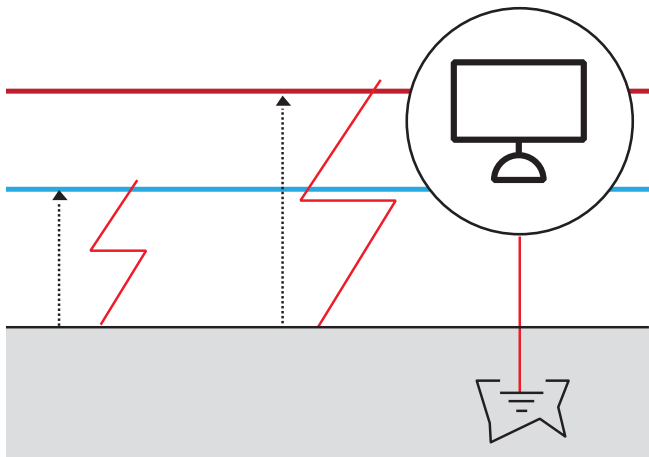

Overvoltages in common mode

Differential mode

Overvoltages in differential mode circulate between the live phase/phase or phase/neutral conductors. They can cause considerable damage to any equipment connected to the electrical network, particularly “sensitive” equipment.

These overvoltages concern TT earthing systems. They also affect TN-S systems if there is a significant difference in length between the neutral cable and the protective cable (PE).

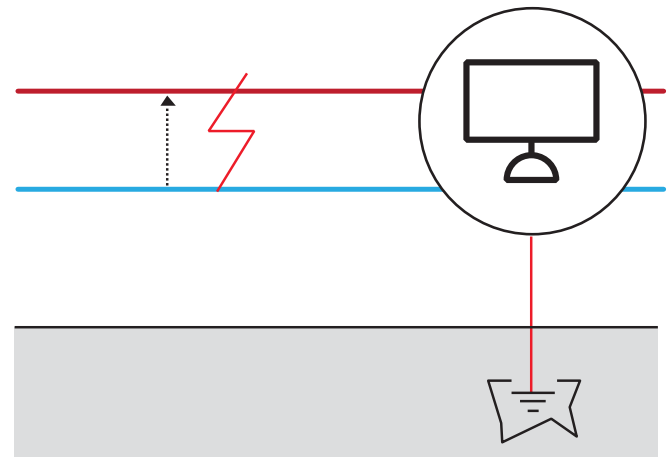

Overvoltages in differential mode

Different types of OVR configuration

Either Common mode or differential mode of protection are required depending on the system configuration (IT, TNC, TNS, TT). For that purpose, you can find different OVR configuration (single pole, 3L, 4L, 1N, 3N).

Common mode configurations (TNC networks)

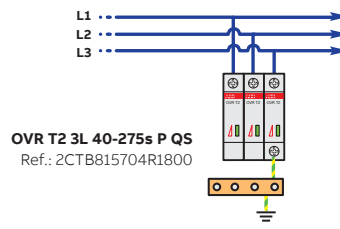
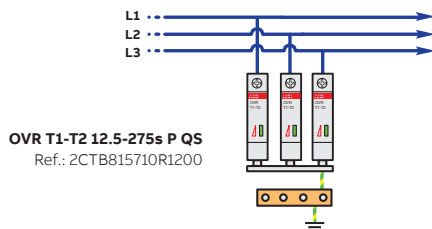

Common and differential mode configurations (TNS, TT networks)

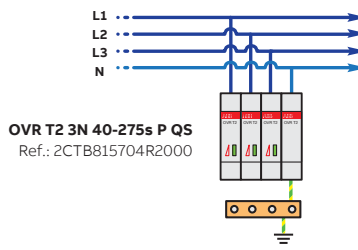
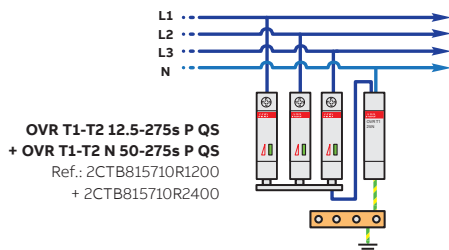

Protection and safety technical details

Coordination and wiring principles

The SPD installed at the line entrance of an installation may not ensure an effective protection to the whole system. As a matter of fact, the selection of the voltage protection level (U_p) of SPDs depends on many parameters: Type of equipment to be protected, the length of the connections to the SPDs, the length in between the SPDs and the equipment to be protected.

Coordination required if :

The protection level (U_p) of the SPDs is not low enough to protect the equipment.
If the distance in between the SPDs and the equipment is >10 m.

NOTE:
The first SPD is diverting most of the surge current to the ground, and the second SPD will ensure a good protection level to the equipment.

It is what we call the stepping protection.

Coordination between Type 1+2, Type 2 (with and without Safety System) and Type 2+3 surge protective device

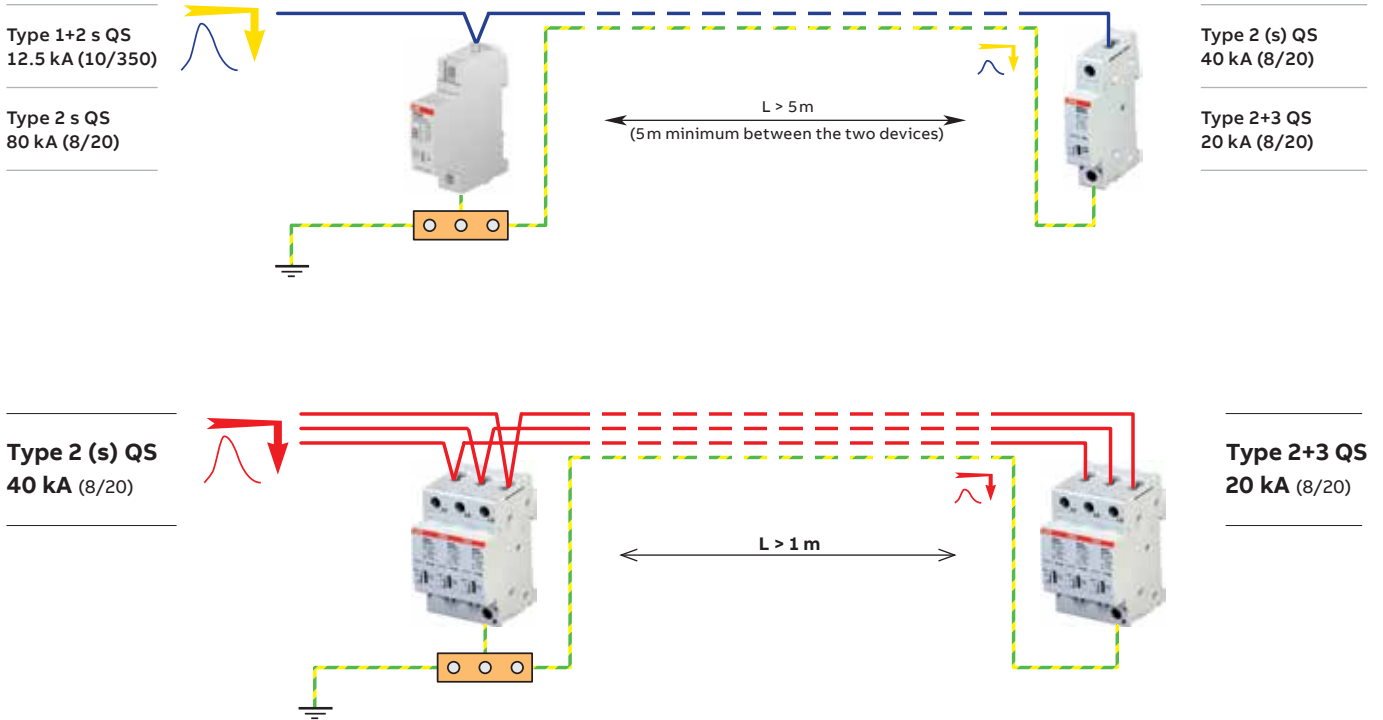

Protection and safety technical details

Coordination and wiring principles

Type of Surge Protective Devices	Miniature circuit breaker maximum ratings* curve B or C				Fuses maximum ratings* (gG)			Moulded Case Circuit Breaker
	Prospective short circuit current at SPD location (Ip)							
	IP ≤ 6 kA	IP ≤ 10 kA	IP ≤ 15 kA	IP ≤ 50 kA	IP ≤ 7 kA	IP ≤ 50 kA	IP ≤ 100 kA	IP ≤ 50kA
Type 1+2								
OVR T1-T2 pluggable Safety Reserve QuickSafe® Iimp 12.5 kA; Uc 275, 440 V	-	-	-	-	160 A	160 A	160 A	-
Type 2								
OVR T2 pluggable Safety Reserve QuickSafe® Imax 40 and 80 kA; Uc 275, 440 V	S 200 M - 63	S 200 M - 63	S 200 P - 63	S 800 S - 125	160 A fuse	160 A fuse	160 A fuse	
Type 2 pluggable QuickSafe® Imax 40 kA; Uc 275, 350, 440,	S 200 M - 63	S 200 M - 63	S 200 P - 63	S 800 S - 125	125 A fuse	125 A fuse	125 A fuse	@ Uc=275V, Tmax XT4S 250, Ekip LSI, I<3 In
Type 2+3								
OVR T2-T3 pluggable QuickSafe® Imax 20 kA; Uc 275, 350, 440	S 200 M - 63	S 200 M - 63	S 200 P - 63	S 800 S - 125	125 A fuse	125 A fuse	125 A fuse	@ Uc=275V, Tmax XT4S 250, Ekip LSI, I<3 In

* Maximum ratings, must be in accordance with the installation to follow coordination rules with main or upstream short circuit protection(s).

Service entrance SPDs	PE connection cable size
Type 1+2	16 mm ²
Type 2	4 mm ²
Type 2+3	4 mm ²

Backup disconnection

Type 2 QuickSafe® Characteristics	Prospective short circuit current at SPD location (Ip)	Circuit breaker* (curve B or C)	Fuses* (gG)
Maximum rating			
In: 5, 20, 20 kA Uc: 275, 350, 440	0.625 kA < Ip < 100 kA	S800S B or C - 125 A**	E90/125 125 A fuse (without Safety Reserve System) 160 A fuse (with Safety Reserve System)

*: The backup disconnection of the SPD shall always be coordinated with the circuit breakers used in the installation

** : up to Ip ≤ 50kA

Digital SPD—eOVR

Back up protection

	Maximum rating								
		MCB S200 style				MCB POD style	Fuse		
		IP ≤ 6 kA	IP ≤ 10 kA	IP ≤ 15 kA	IP ≤ 50 kA	IP ≤ 6 kA	IP ≤ 7 kA	IP ≤ 50 kA	IP ≤ 100 kA
eOVR	1P+N	-	-	-	-	-	160 A fuse + ILTS-E/H11		
	3P	-	-	-	-	-			
	3P+N	-	-	-	-	-			
eOVR	1P+N	S202 M - 63 + S2C - H6R			S802 S - 125 + S800 - AUX	2 x POD 1P1M	125 A fuse + ILTS-E/H11		
	3P	S202 M - 63 + S2C - H6R			S803 S - 125 + S800 - AUX	3 x POD 1P1M			
	3P+N	S202 M - 63 + S2C - H6R			S804 S - 125 + S800 - AUX	4 x POD 1P1M			
Comment	S2C-H6R can be connected to eOVR to track MCB toggle position This check is not possible by using POD MCB								

Protection and safety technical details

OVR Surge Protective Devices

Selection tool: TNC-S network 230/400 V

Industry, commercial building

$I_p \leq 100 \text{ kA}$

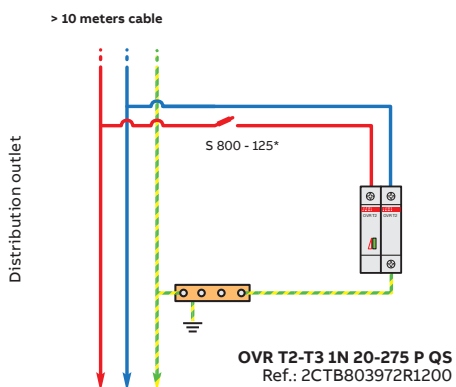
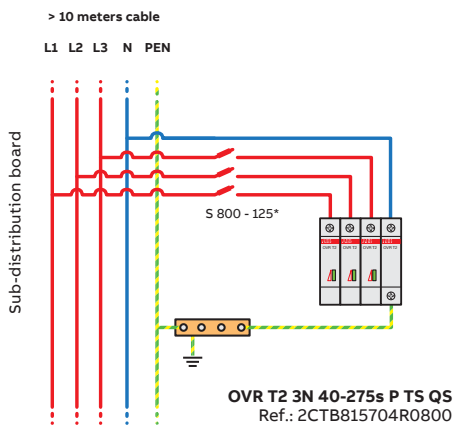
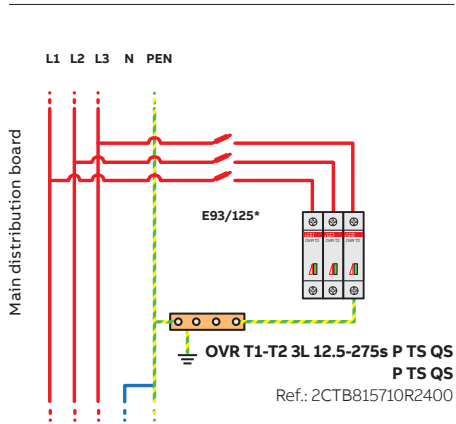

I_p : prospective short circuit current of the power supply.

* Must be according to the coordination rules with main or upstream short circuit protection(s).

Protection and safety technical details

OVR Surge Protective Devices

Selection tool: TT network 230/400 V

Industry, commercial building

≤ 100 kA

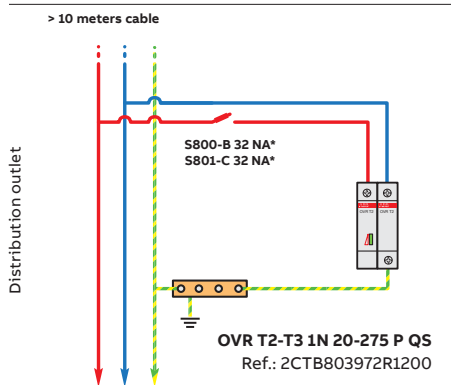
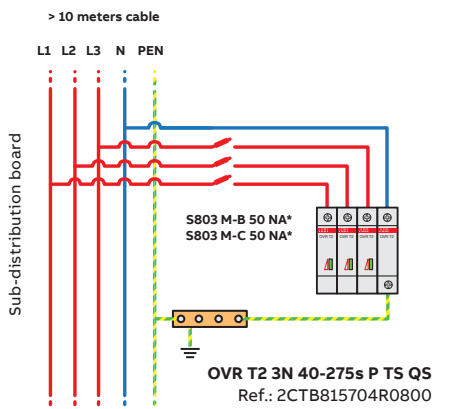
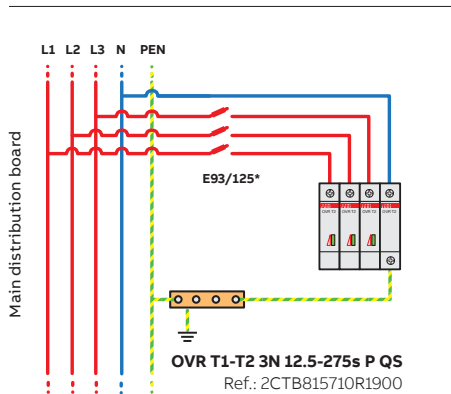

I_p : prospective short circuit current of the power supply

* Must be according to the coordination rules with main or upstream short circuit protection(s).

Protection and safety technical details

OVR Surge Protective Devices

Selection tool: IT network 230 V without neutral Commercial, residential

The IT system has all live parts at the source isolated from earth or one part connected to earth with a high impedance.

Configuration 1

$I_p \leq 100 \text{ kA}$

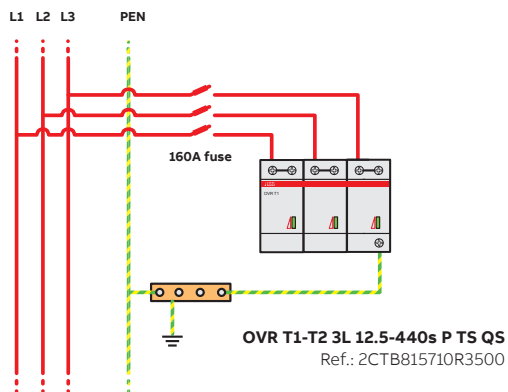

> 10 meters cable

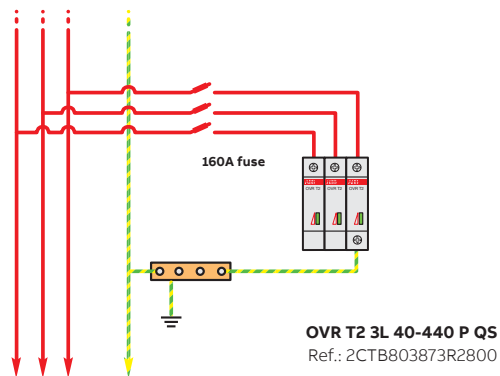

I_p : prospective short circuit current of the power supply

* Must be according to the coordination rules with main or upstream short circuit protection(s).

Protection and safety technical details

OVR Surge Protective Devices

Selection tool: TNC, TNS/TT networks 230/400 V Residential

With external conductive parts (external lightning protection air terminal, antenna...) or powered by aerial lines

YES

NO



Neighbour with external lightning protection system (or generally with earthed extraneous conductive parts), or proximity of high points

YES

NO

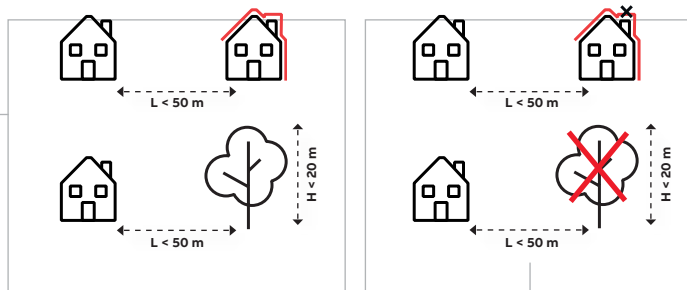

Configuration 1

With risk of direct lightning current (external protection, aerial lines...)

Configuration 2

With risk of indirect lightning current, transient surges

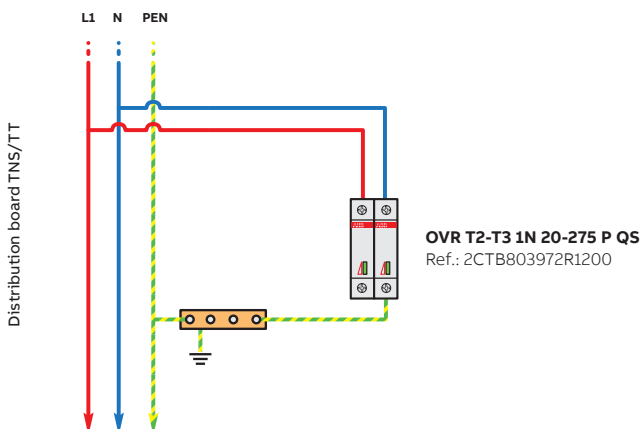
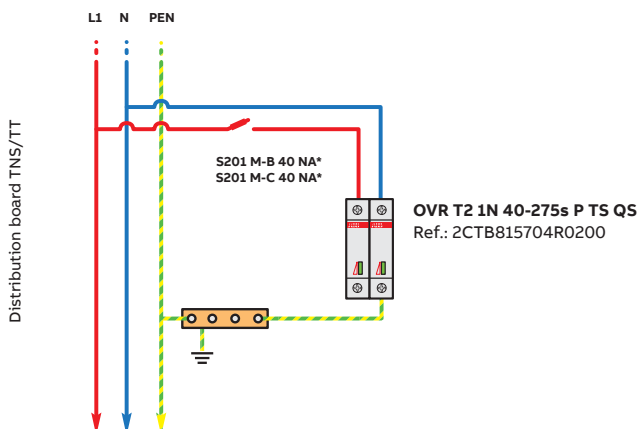
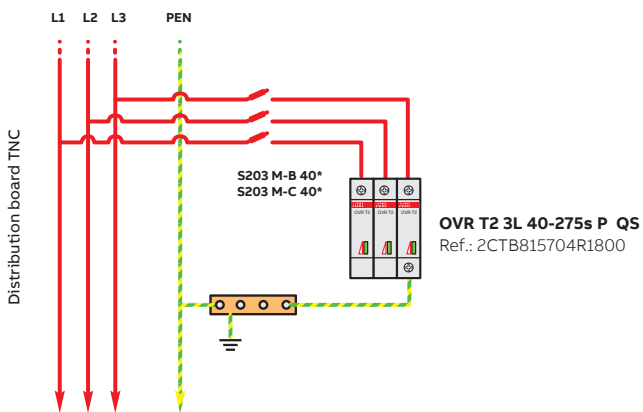
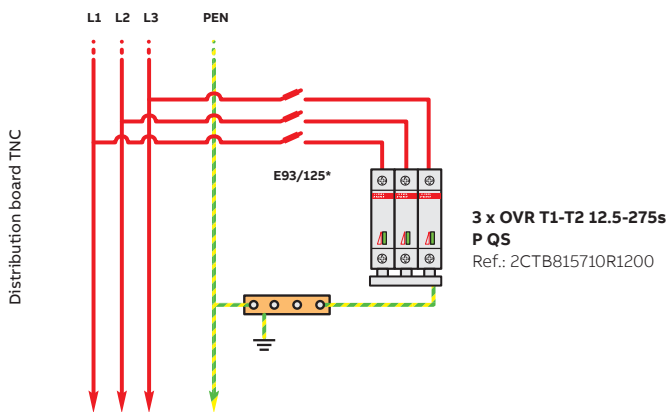

* Should be according to the coordination rules with installed main breakers

Digital SPD—eOVR

Wiring

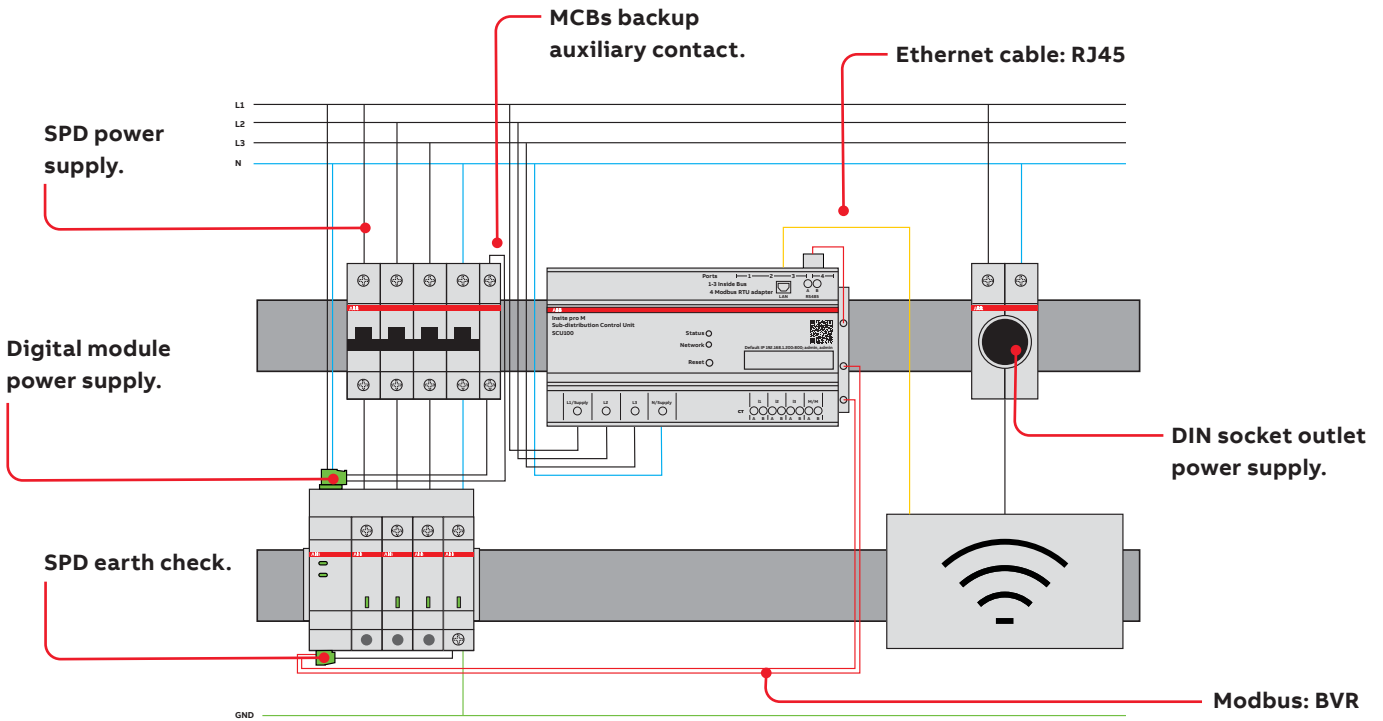

Wires	Type	Min section	Max section	Stripping length	Torque
		mm ²	mm ²		
SPD power supply	Rigid/stranded	2.5	16/10	12.5	2.8
Digital module power supply	Rigid/stranded	0.5	2.5	7.7	0.4
Earth check	Rigid/stranded	0.5	1.5		0.2
SPD earth	Rigid/stranded	2.5	25/16	12.5	2.8
Modbus	BVR	0.5	1.5	7	0.2
MCBs backup auxiliary contact	Rigid/stranded	0.5	1.5	7	0.2
Ethernet	RJ45	-	-	-	-
DIN socket outlet power supply	Rigid/stranded	2.5	25	12.5	2.8

Ferrules:

F	L	Dimension(mm)			A.W.G	Cable size (mm ²)
		W	Dφ	Cφ		
8.0	14.0	2.6	1.3	1.0	#22	0.5
8.0	14.06	2.8	1.6	1.3	#20	0.8
8.0	14.4	3.0	1.7	1.4	#18	1.0
8.0	14.4	3.5	2.0	1.7	#16	1.5
8.0	15.2	4.0	2.6	2.3	#14	2.5

Materials: **Copper**

Insulation sheath material: **Nylon**

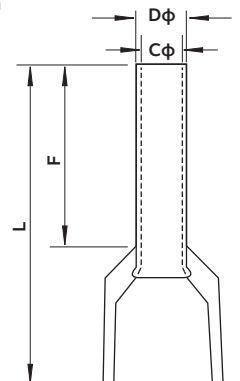
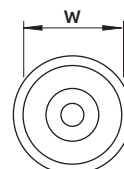

Protection and safety technical details

UL 1449 Ed4

The Underwriters Laboratories (UL) standard for surge protective devices (SPDs) has been the primary safety standard for surge protection since the first edition was published in 1985, the fourth edition became mandatory for AC SPDs in March 2016.

The objective of UL 1449 has always been to increase safety in terms of surge protection.

Change in the standard's name: From TVSS to SPDs

Prior to UL 1449 3rd Edition taking effect, the devices this standard covers were known as Transient Voltage Surge Suppressors (TVSS), operating on power circuits not exceeding 600 V. With the inception of the 3rd and 4th Edition, these devices are now known as Surge Protective Devices (SPDs), and may operate on power circuits not exceeding 1500 V DC.

This new designation moves the UL standard closer to the international designation and to IEC standards.

The different type designations of surge protective devices

The UL 1449 placed SPDs into five different Type categories based on installation location within an electrical system. While Type 1, Type 2 and Type 3 categories refer to different types of SPDs that can be installed at specific locations, Type 4 and Type 5 categories refer to components used in an SPDs configuration.

Type 1 – “Permanently connected SPDs intended for installation between the secondary of the service transformer and the line side of the service equipment overcurrent device.”

Type 2 – “Permanently connected SPDs intended for installation on the load side of the service equipment overcurrent device.”

Type 3 – “Point of utilization SPDs, installed at a minimum conductor length of 10 meters (30 feet) from the electrical service panel.”

Type 4 - Component assemblies – “Component assembly consisting of one or more Type 5 components together with a disconnect (integral or external) or a means of complying with the limited current tests.”

Type 1, 2, 3 - Component assemblies – “Consists of a Type 4 component assembly with internal or external short circuit protection.”

Type 5 – “Discrete component surge suppressors, such as MOVs that may be mounted on a PWB, connected by its leads or provided within an enclosure with mounting means and wiring terminations.”

The closer an SPD is installed to the equipment, the better the protection is. This is a push in the direction of providing stepped protection including external and internal surge protection.



The measured voltage protection level

The Measured Limiting Voltage (MLV) is the maximum magnitude of voltage measured at the application of a specific impulse wave shape.

When applying a certain surge current on the SPD the measured voltage at the device terminals is the so called “let-through voltage.”

In UL 1449 2nd Edition, the let-through voltage was referred to as Suppressed Voltage Rating (SVR) and was calculated with a 0.5 kA surge wave form at 6 kV. The new designation is Voltage Protection Rating (VPR) and is calculated with a 3 kA surge wave form at 6 kV.

All products have been certified according to the UL 1449 4th Edition.

The MLV will allow comparison of different types of SPDs with regards to the let-through voltage. However, it is important to note that the surge current used to measure the let-through voltage is six times higher in the 3rd and 4th Edition than in the 2nd Edition. This means that, comparing the obsolete SVR designation with the new VPR ratings will not be valid, as VPR ratings will of course be higher than SVR ratings.

Protection and safety technical details

UL 1449 Ed4

List of OVR T2 UL products according to their certification

Type acc. To UL 1449 Ed4

Range	Type	Order code	Type 4 CA	Type 1 CA
T2 U	OVR T2 15-150 P U	2CTB802341R0000	■	
	OVR T2 15-320 P U	2CTB802341R0400	■	
	OVR T2 40-150 P U	2CTB802341R2000	■	
	OVR T2 40-150 P TS U	2CTB802341R2100	■	
	OVR T2 40-320 P U	2CTB802341R2400	■	
	OVR T2 40-320 P TS U	2CTB802341R2500	■	
	OVR T2 40-440 P TS U	2CTB802341R2900	■	
	OVR T2 40-550 P TS U	2CTB802341R3300	■	
	OVR T2 40-660 P TS U	2CTB802341R3700	■	
	OVR T2 70 N P U	2CTB802341R8000	■	
	OVR T2 1N 15-150 P U	2CTB802342R0000	■	
	OVR T2 1N 15-320 P U	2CTB802342R0400	■	
	OVR T2 1N 40-150 P U	2CTB802342R2000	■	
	OVR T2 1N 40-150 P TS U	2CTB802342R2100	■	
	OVR T2 1N 40-320 P TS U	2CTB802342R2500	■	
	OVR T2 1N 40-440 P TS U	2CTB802342R2900	■	
	OVR T2 1N 40-550 P TS U	2CTB802342R3300	■	
	OVR T2 1N 40-660 P TS U	2CTB802342R3700	■	
	OVR T2 2L 15-150 P U	2CTB802343R0000		■
	OVR T2 2L 15-320 P U	2CTB802343R0400		■
	OVR T2 2L 40-150 P TS U	2CTB802343R2100		■
	OVR T2 2L 40-320 P TS U	2CTB802343R2500		■
	OVR T2 2N 15-150 P U	2CTB802344R0000		■
	OVR T2 2N 15-320 P U	2CTB802344R0400	■	
	OVR T2 2N 40-150 P TS U	2CTB802344R2100	■	
	OVR T2 2N 40-320 P TS U	2CTB802344R2500	■	
	OVR T2 2N 40-440 P TS U	2CTB802344R2900	■	
	OVR T2 2N 40-550 P TS U	2CTB802344R3300	■	
	OVR T2 2N 40-660 P TS U	2CTB802344R3700	■	
	OVR T2 3L 15-150 P U	2CTB802345R0000		■
	OVR T2 3L 15-320 P U	2CTB802345R0400		■
	OVR T2 3L 40-150 P TS U	2CTB802345R2100		■
	OVR T2 3L 40-320 P TS U	2CTB802345R2500		■
	OVR T2 3L 40-440 P TS U	2CTB802345R2900		■
	OVR T2 3L 40-550 P TS U	2CTB802345R3300		■
	OVR T2 3N 15-150 P U	2CTB802346R0000	■	
	OVR T2 3N 15-320 P U	2CTB802346R0400	■	
	OVR T2 3N 40-150 P TS U	2CTB802346R2100	■	
	OVR T2 3N 40-320 P TS U	2CTB802346R2500	■	
	OVR T2 3N 40-440 P TS U	2CTB802346R2900	■	
	OVR T2 3N 40-550 P TS U	2CTB802346R3300	■	
	OVR T2 3N 40-660 P TS U	2CTB802346R3700	■	
	OVR T2 15-150 C U	2CTB802348R2500		■
	OVR T2 15-320 C U	2CTB802348R2700		■
	OVR T2 40-150 C U	2CTB802348R3500		■
	OVR T2 40-320 C U	2CTB802348R3700		■
	OVR T2 40-440 C U	2CTB802348R3900		■
	OVR T2 40-550 C U	2CTB802348R4100		■
	OVR T2 40-660 C U	2CTB802348R4300	■	
	OVR T2 70 N C U	2CTB802348R6500	■	

Protection and safety technical details

Products Standards, UL 1449 Ed4

Terminology of SPD electrical characteristics

SPD terminology

8/20 wave:

Current waveform which passes through equipment when subjected to an overvoltage (low energy).

Type 2 surge protective device (SPD)

Permanently connected SPDs intended for installation on the load side of the service equipment overcurrent device, including SPDs located at a branch panel. It has successfully passed testing to the standard with the 8/20 wave (class II test).

Metal oxide varistor (MOV)

A varistor is an electronic component with a "diode like" nonlinear current-voltage characteristic, used to protect circuits against excessive transient voltages. Most commonly composed of metal oxides.

Maximum continuous operating voltage (MCOV, U_c)

The maximum designated root mean square (rms) value of power frequency voltage that may be applied continuously between the terminals of the SPD.

Nominal discharge current (I_n)

Peak current value of an 8/20 waveform which the SPD is rated for based on the test program.

Maximum discharge current (I_{max})

Peak current value of an 8/20 waveform which can be safely discharged by the SPD, with an amplitude complying with the class II operating test sequence. $I_{max} > I_n$.

Short circuit current rating (SCCR)

Maximum symmetrical fault current, at rated voltage, that the SPD can withstand without sustaining damage that exceeds acceptable criteria or creates a hazardous operating condition.

Voltage protection rating (VPR)

The value of the VPR is determined as the nearest highest value, taken from Table 63.1 of ANSI/UL 1449 4th Edition, to the measured limiting voltage determined during the transient voltage surge suppression test using the combination wave generator at a setting of 6 kV, 3 kA.

Voltage protection level (U_p or U_{res})

The voltage let through by the SPD while diverting surge current to ground must not exceed the voltage withstand value of the equipment connected downstream.

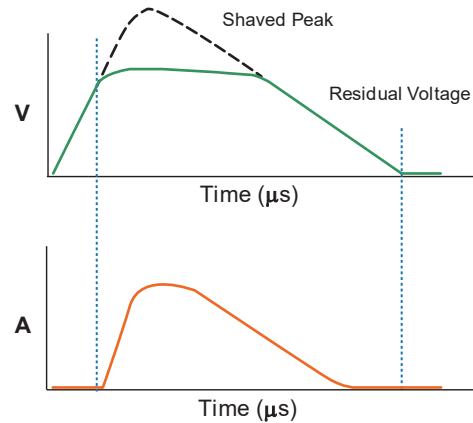

Notes:

Test wave 8/20 μs according to IEEE # C62.62-200/UL 1449

The first number corresponds to the time from 10% to 90% of its peak value (8 μs).

The second number corresponds to the time taken for the wave to descend to 50% of its peak value (20 μs).

Protection and safety technical details

OVR surge protective devices – UL Version

General wiring diagrams

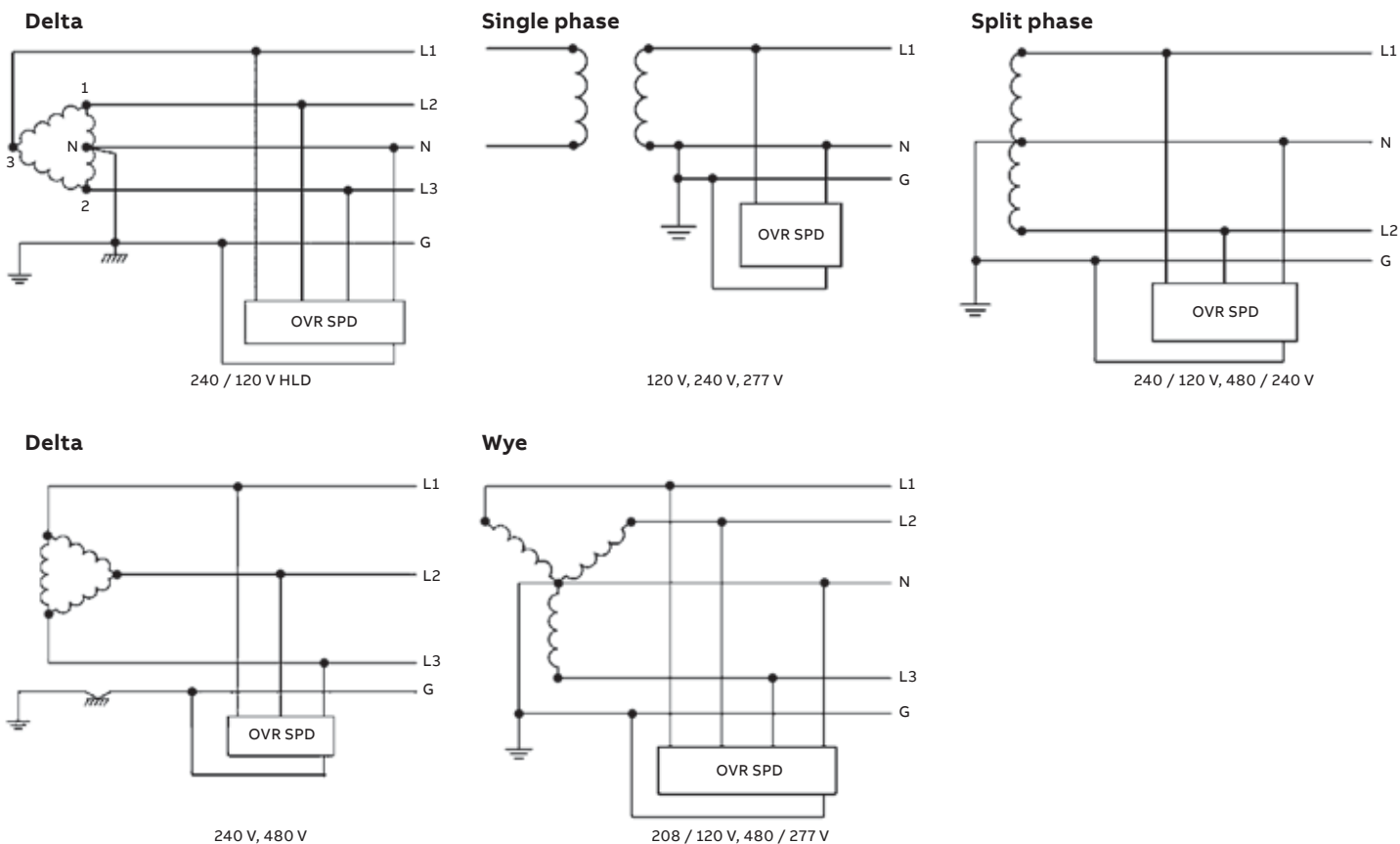

NOTE: Multiple pole SPDs shown. Wiring diagrams for reference only.

IEC SPD test standards–terminology

IEC 61643-11 Terminology	Description	UL 1449 Terminology
I_{imp}	The maximum surge current rating for an SPD when subjected to a 10 x 350 μ s wave shape	No equivalent
I_{max}	The maximum surge current rating for an SPD when subjected to an 8 x 20 μ s wave shape	Single surge current rating
I_n	Nominal surge discharge current 8 x 20 μ s wave shape	I_N
I_{SCCR}	Short Circuit Current Rating (withstand)	SCCR
U_p	Voltage Protection Level, let thru voltage level of the SPD when subjected to a test surge	VPR
U_c	Maximum Continuous Operational Voltage SPD can be exposed to without failure.	MCOV
U_N	Nominal Operational Voltage, or application voltage	Operational voltage

8 x 20 μ s wave shape

- Used for IEC Class II test (EN Type 2)
- I_{max} is the surge current value designation for IEC
- I_n is also tested using this wave shape
- U_L single surge current rating

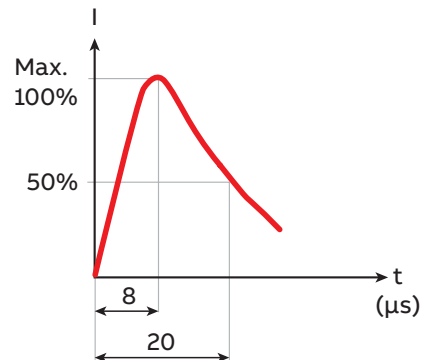

10 x 350 μ s wave shape (IEC only)

- Used for IEC 61643-11/ Class I tested SPD or EN 61643-11 Type 1
- SPD must survive 5 impulses increasing in magnitude to max I_{imp}
- I_{imp} is then the surge current value designation if SPD passes
- There is no equivalent test in the U_L standard

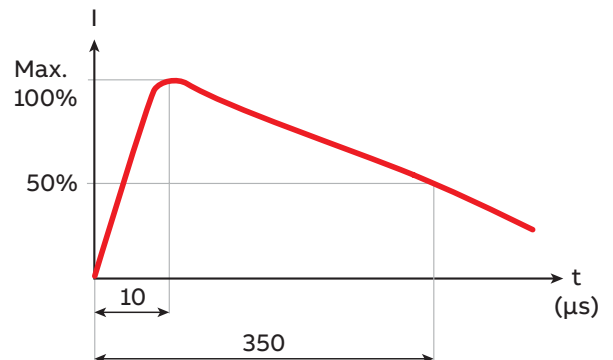



UL Types vs IEC Class tested SPDs and Locations

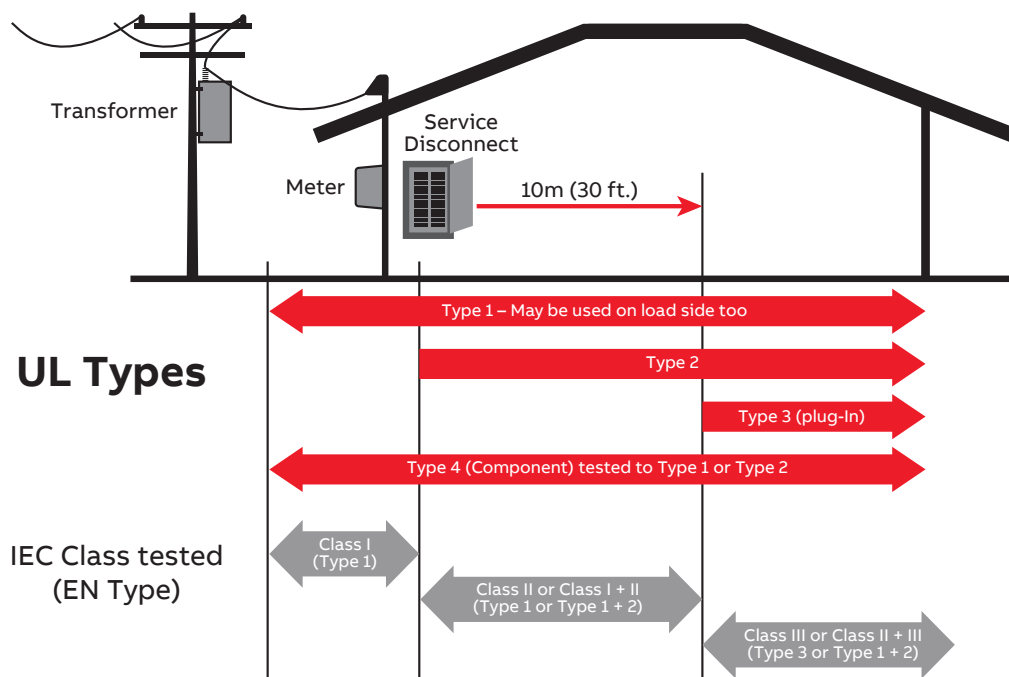

Protection and safety technical details

OVR Surge Protective Devices

Dimensional drawings of OVR surge protective devices

OVR T1-T2 12.5kA QS

Type	Width mm
OVR T1-T2 12.5-275s P TS QS	17.8
OVR T1-T2 12.5-275s P QS	17.8
OVR T1-T2 12.5-440s P TS QS	35.6
OVR T1-T2 12.5-440s P QS	35.6
OVR T1-T2 N 50-275s P QS	17.8
OVR T1-T2 N 50-440 P QS	17.8
OVR T1-T2 3L 12.5-275s P TS QS	53.4
OVR T1-T2 3L 12.5-275s P QS	53.4
OVR T1-T2 3L 12.5-440s P TS QS	106.8
OVR T1-T2 3L 12.5-440s P QS	106.8
OVR T1-T2 1N 12.5-275s P QS	35.6
OVR T1-T2 1N 12.5-275s P TS QS	35.6
OVR T1-T2 1N 12.5-440s P QS	53.4
OVR T1-T2 1N 12.5-440s P TS QS	53.4
OVR T1-T2 3N 12.5-275s P QS	71.2
OVR T1-T2 3N 12.5-275s P TS QS	71.2
OVR T1-T2 3N 12.5-440s P QS	124.6
OVR T1-T2 3N 12.5-440s P TS QS	124.6
OVR T1-T2 4L 12.5-275s P QS	71.2
OVR T1-T2 4L 12.5-275s P TS QS	71.2
OVR T1-T2 4L 12.5-440s P QS	142.4
OVR T1-T2 4L 12.5-440s P TS QS	142.4

Main dimensions mm

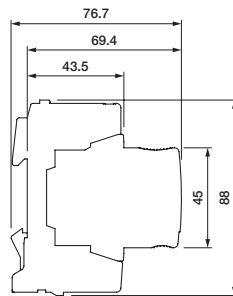

OVR T1-T2 12.5-275s P QS
OVR T1-T2 12.5-440s P QS
OVR T1-T2 N 50-275s P QS
OVR T1-T2 N 50-440s P QS

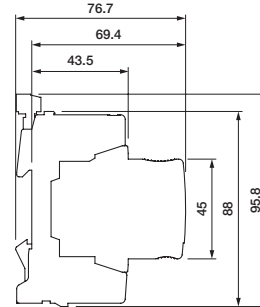

OVR T1-T2 12.5-275s P TS QS
OVR T1-T2 12.5-440s P TS QS

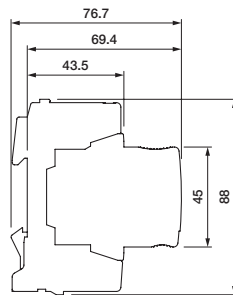

OVR T1-T2 3L 12.5-275s P QS
OVR T1-T2 3L 12.5-440s P QS

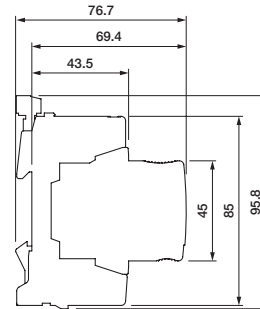

OVR T1-T2 3L 12.5-275s P TS QS

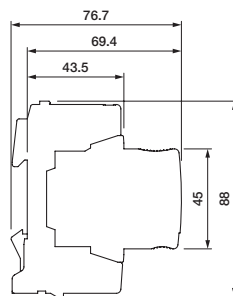

OVR T1-T2 1N 12.5-275s P QS
OVR T1-T2 1N 12.5-440s P QS
OVR T1-T2 3N 12.5-275s P QS
OVR T1-T2 3N 12.5-440s P QS
OVR T1-T2 4L 12.5-275s P QS
OVR T1-T2 4L 12.5-440s P QS

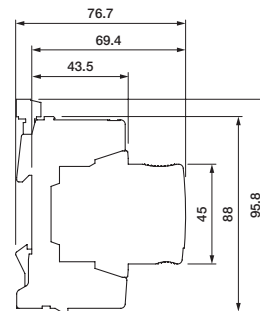

OVR T1-T2 1N 12.5-275s P TS QS
OVR T1-T2 1N 12.5-440s P TS QS
OVR T1-T2 3N 12.5-275s P TS QS
OVR T1-T2 3N 12.5-440s P TS QS
OVR T1-T2 4L 12.5-275s P TS QS
OVR T1-T2 4L 12.5-440s P TS QS

OVR T2 Single pole -Unpluggable

Type	Width mm
OVR T2 20-150	17.8
OVR T2 40-150	17.8
OVR T2 20-275	17.8
OVR T2 40-275	17.8

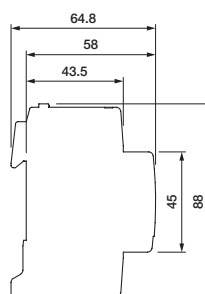

OVR T2 20-150
OVR T2 40-150
OVR T2 20-275
OVR T2 40-275

Protection and safety technical details

OVR Surge Protective Devices

Dimensional drawings of OVR surge protective devices

OVR T2 Pluggable

Type	Width mm
OVR T2 40-275 P QS	17.8
OVR T2 40-275 P TS QS	17.8
OVR T2 40-275s P QS	17.8
OVR T2 40-275s P TS QS	17.8
OVR T2 40-350 P QS	17.8
OVR T2 40-350 P TS QS	17.8
OVR T2 80-275s P QS	17.8
OVR T2 80-275s P TS QS	17.8
OVR T2 N 80-275 P QS	17.8
OVR T2 N 80-350 P QS	17.8
OVR T2 N 80-275s P QS	17.8
OVR T2 40-440 P QS	17.8
OVR T2 40-440 P TS QS	17.8
OVR T2 40-440s P QS	17.8
OVR T2 40-440s P TS QS	17.8
OVR T2 80-440s P QS	17.8
OVR T2 80-440s P TS QS	17.8
OVR T2 N 80-440 P QS	17.8
OVR T2 N 80-440s P QS	17.8

Main dimensions mm

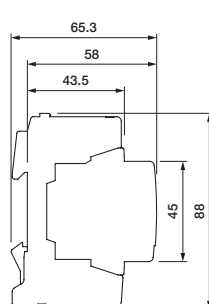

OVR T2 40-275 P QS
OVR T2 40-350 P QS
OVR T2 N 80-275 P QS
OVR T2 N 80-350 P QS
OVR T2 N 80-275S P QS

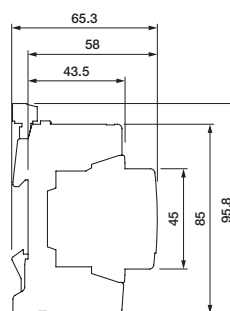

OVR T2 40-275 P TS QS
OVR T2 40-350 P TS QS

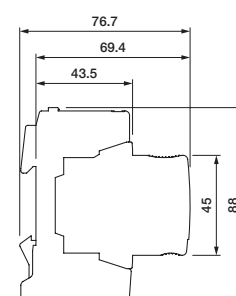

OVR T2 40-275S P QS
OVR T2 80-275S P QS

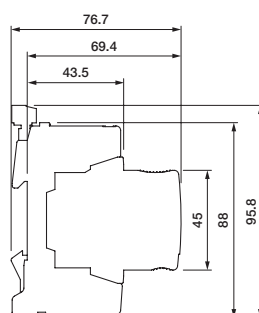

OVR T2 40-275s P TS QS
OVR T2 80-275s P TS QS

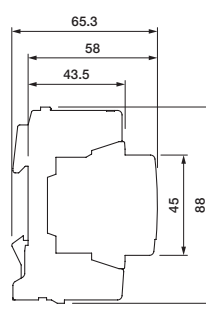

OVR T2 40-440 P QS
OVR T2 N 80-440 P QS

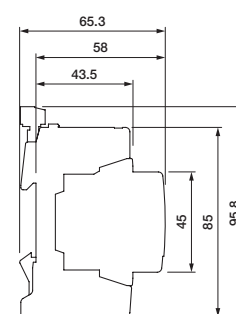

OVR T2 40-440 P TS QS

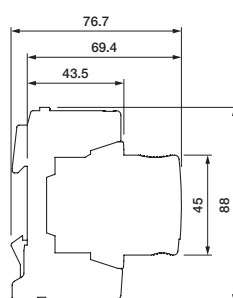

OVR T2 40-440s P QS
OVR T2 80-440s P QS
OVR T2 N 80-440s P QS

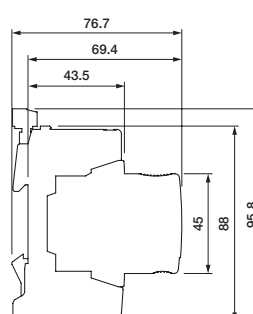

OVR T2 40-440s P TS QS
OVR T2 80-440s P TS QS

Protection and safety technical details

OVR Surge Protective Devices

Dimensional drawings of OVR surge protective devices

OVR T2 Pluggable

Type	Width mm
OVR T2 3L 40-275 P QS	53.4
OVR T2 3L 40-275 P TS QS	53.4
OVR T2 3L 40-275s P QS	53.4
OVR T2 3L 40-275s P TS QS	53.4
OVR T2 3L 80-275s P QS	53.4
OVR T2 3L 80-275s P TS QS	53.4
OVR T2 3L 40-350 P QS	53.4
OVR T2 3L 40-350 P TS QS	53.4
OVR T2 3L 40-440 P QS	53.4
OVR T2 3L 40-440 P TS QS	53.4
OVR T2 3L 80-440s P QS	53.4
OVR T2 3L 80-440s P TS QS	53.4

Main dimensions mm

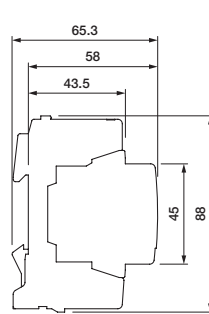

OVR T2 3L 40-275 P QS
OVR T2 3L 40-350 P QS

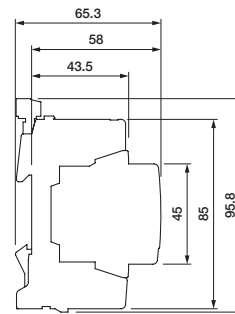

OVR T2 3L 40-275 P TS QS
OVR T2 3L 40-350 P TS QS

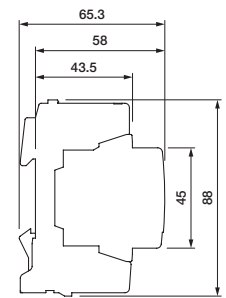

OVR T2 3L 40-440 P QS

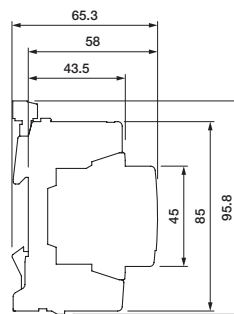

OVR T2 3L 40-440 P TS QS

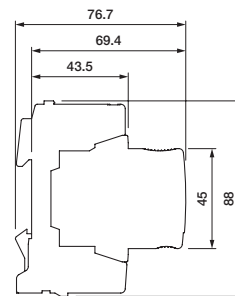

OVR T2 3L 80-440s P QS

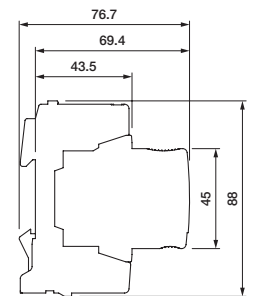

OVR T2 3L 40-275s P QS
OVR T2 3L 80-275s P QS

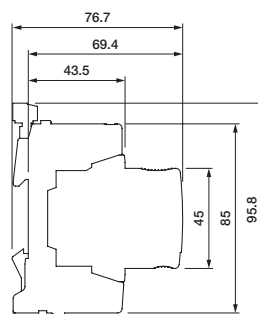

OVR T2 3L 40-275s P TS QS
OVR T2 3L 80-275s P TS QS

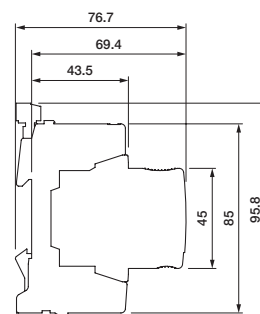

OVR T2 3L 80-440s P TS QS

Protection and safety technical details

OVR Surge Protective Devices

Dimensional drawings of OVR surge protective devices

OVR T2 Pluggable

Type	Width mm
OVR T2 4L 40-275 P QS	71.2
OVR T2 4L 40-275 P TS QS	71.2
OVR T2 4L 40-275s P QS	71.2
OVR T2 4L 40-275s P TS QS	71.2
OVR T2 4L 80-275s P QS	71.2
OVR T2 4L 80-275s P TS QS	71.2
OVR T2 4L 40-440 P QS	71.2
OVR T2 4L 40-440 P TS QS	71.2
OVR T2 4L 80-440s P QS	71.2
OVR T2 4L 80-440s P TS QS	71.2

Main dimensions mm

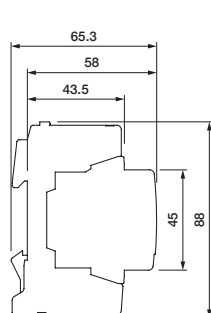

OVR T2 4L 40-275 P QS

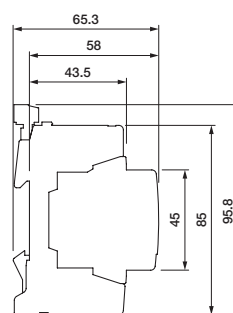

OVR T2 4L 40-275 P TS QS

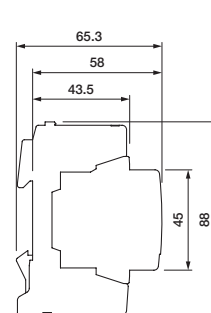

OVR T2 4L 40-440 P QS

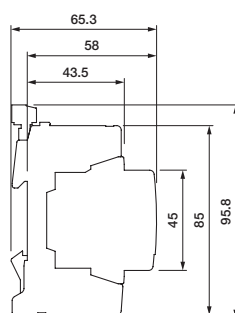

OVR T2 4L 40-440 P TS QS

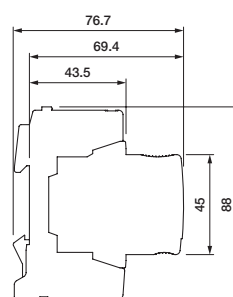

OVR T2 4L 40-275s P QS
OVR T2 4L 80-275s P QS

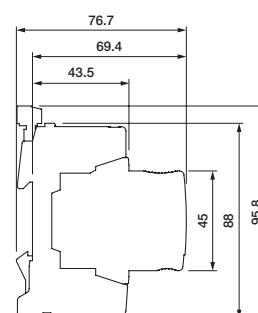

OVR T2 4L 40-275s P TS QS
OVR T2 4L 80-275s P TS QS

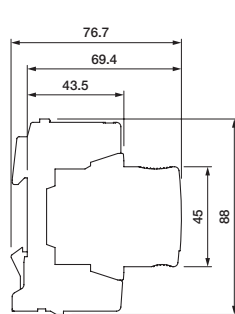

OVR T2 4L 80-440s P QS

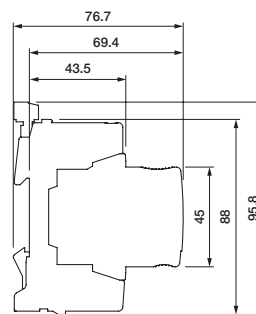

OVR T2 4L 80-440s P TS QS

Protection and safety technical details

OVR Surge Protective Devices

Dimensional drawings of OVR surge protective devices

OVR T2 Pluggable

Type	Width mm
OVR T2 3N 40-275 P QS	71.2
OVR T2 3N 40-275 P TS QS	71.2
OVR T2 3N 40-275s P QS	71.2
OVR T2 3N 40-275s P TS QS	71.2
OVR T2 3N 80-275s P QS	71.2
OVR T2 3N 80-275s P TS QS	71.2
OVR T2 3N 40-350 P QS	71.2
OVR T2 3N 40-350 P TS QS	71.2
OVR T2 3N 40-440 P QS	71.2
OVR T2 3N 40-440 P TS QS	71.2
OVR T2 3N 40-440s P TS QS	71.2
OVR T2 3N 80-440s P QS	71.2
OVR T2 3N 80-440s P TS QS	71.2

Main dimensions mm

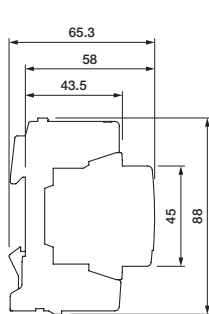

OVR T2 3N 40-275 P QS
OVR T2 3N 40-350 P QS
OVR T2 3N 40-440 P QS

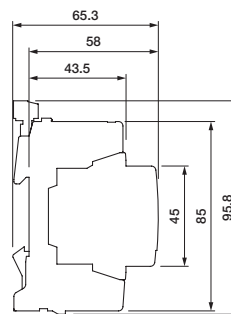

OVR T2 3N 40-275 P TS QS
OVR T2 3N 40-350 P TS QS
OVR T2 3N 40-440 P TS QS

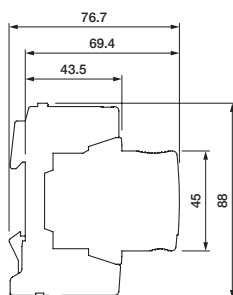

OVR T2 3N 40-275s P QS
OVR T2 3N 80-275s P QS
OVR T2 3N 80-440s P QS

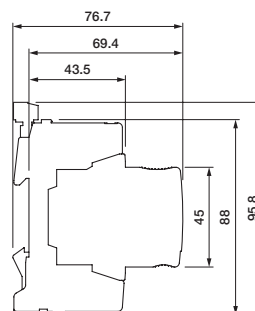

OVR T2 3N 40-275s P TS QS
OVR T2 3N 80-275s P TS QS
OVR T2 3N 40-440s P TS QS
OVR T2 3N 80-440s P TS QS

Protection and safety technical details

OVR Surge Protective Devices

Dimensional drawings of OVR surge protective devices

OVR T2-T3 Pluggable

Type	Width mm
OVR T2-T3 20-275 P QS	17.8
OVR T2-T3 20-275 P TS QS	17.8
OVR T2-T3 20-440 P QS	17.8
OVR T2-T3 20-440 P TS QS	17.8
OVR T2-T3 3L 20-275 P QS	53.4
OVR T2-T3 3L 20-275 P TS QS	53.4
OVR T2-T3 1N 20-275 P QS	35.6
OVR T2-T3 1N 20-275 P TS QS	35.6
OVR T2-T3 3N 20-275 P QS	71.2
OVR T2-T3 3N 20-275 P TS QS	71.2
OVR T2-T3 3N 20-440 P QS	71.2

Main dimensions mm

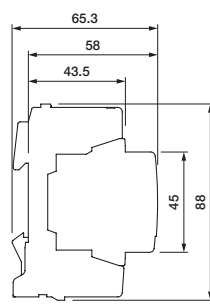

OVR T2-T3 20-275 P QS
OVR T2-T3 20-440 P QS

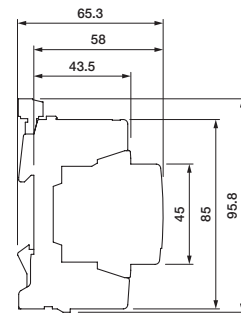

OVR T2-T3 20-275 P TS QS
OVR T2-T3 20-440 P TS QS

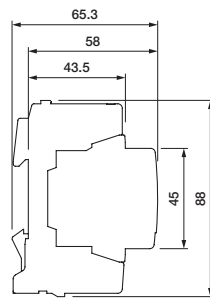

OVR T2-T3 3L 20-275 P QS

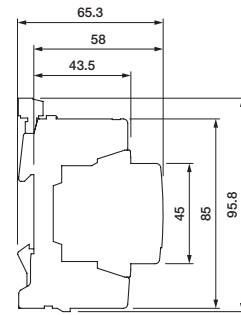

OVR T2-T3 3L 20-275 P TS QS

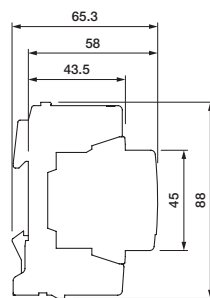

OVR T2-T3 1N 20-275 P QS

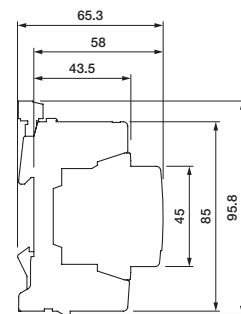

OVR T2-T3 1N 20-275 P TS QS

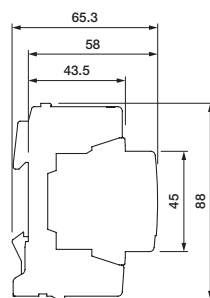

OVR T2-T3 3N 20-275 P QS
OVR T2-T3 3N 20-440 P QS

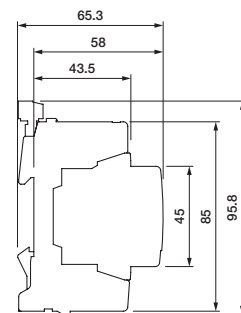

OVR T2-T3 3N 20-275 P TS QS

Protection and safety technical details

OVR Surge Protective Devices

Single pole

Type	Width mm
OVR T2 15-150 P U	17.8
OVR T2 15-320 P U	17.8
OVR T2 40-150 P U	17.8
OVR T2 40-150 P TS U	17.8
OVR T2 40-320 P U	17.8
OVR T2 40-320 P TS U	17.8
OVR T2 40-440 P TS U	17.8
OVR T2 40-550 P TS U	17.8
OVR T2 40-660 P TS U	17.8
OVR T2 70 N P U	17.8

Main dimensions mm

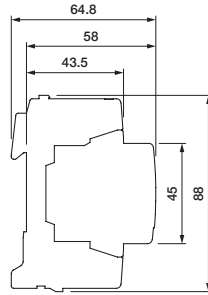

OVR T2 15-150 P U
 OVR T2 15-320 P U
 OVR T2 40-150 P U
 OVR T2 40-320 P U
 OVR T2 70 N P U

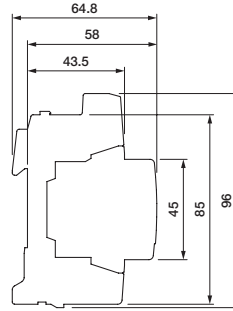

OVR T2 40-150 P TS U
 OVR T2 40-320 P TS U
 OVR T2 40-440 P TS U
 OVR T2 40-550 P TS U
 OVR T2 40-660 P TS U

Single phase networks

Type	Width mm
OVR T2 1N 15-150 P U	35.6
OVR T2 1N 15-320 P U	35.6
OVR T2 1N 40-150 P U	35.6
OVR T2 1N 40-150 P TS U	35.6
OVR T2 1N 40-320 P TS U	35.6
OVR T2 1N 40-440 P TS U	35.6
OVR T2 1N 40-660 P TS U	35.6
OVR T2 1N 40-550 P TS U	35.6

Main dimensions mm

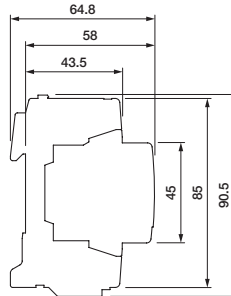

OVR T2 1N 15-150 P U
 OVR T2 1N 15-320 P U
 OVR T2 1N 40-150 P U

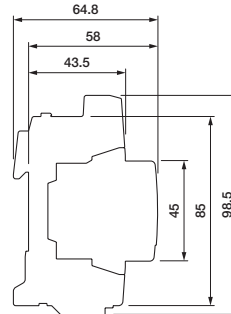

OVR T2 1N 40-150 P TS U
 OVR T2 1N 40-320 P TS U
 OVR T2 1N 40-440 P TS U
 OVR T2 1N 40-550 P TS U
 OVR T2 1N 40-660 P TS U

Delta networks

Type	Width mm
OVR T2 3L 15-320 P U	53.4
OVR T2 3L 40-320 P TS U	53.4
OVR T2 3L 40-550 P TS U	53.4

Main dimensions mm

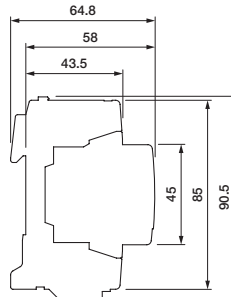

OVR T2 3L 15-320 P U

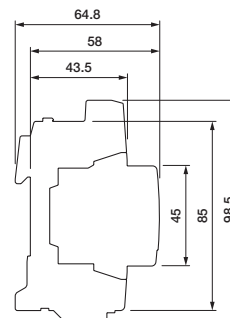

OVR T2 3L 40-320 P TS U
 OVR T2 3L 40-550 P TS U

Protection and safety technical details

OVR Surge Protective Devices

Split phase networks

Type	Width mm
OVR T2 2L 15-150 P U	35.6
OVR T2 2L 15-320 P U	35.6
OVR T2 2L 40-150 P TS U	35.6
OVR T2 2L 40-320 P TS U	35.6
OVR T2 2N 15-150 P U	53.4
OVR T2 2N 15-320 P U	53.4
OVR T2 2N 40-150 P TS U	53.4
OVR T2 2N 40-320 P TS U	53.4
OVR T2 2N 40-440 P TS U	53.4
OVR T2 2N 40-550 P TS U	53.4
OVR T2 2N 40-660 P TS U	53.4

Main dimensions mm

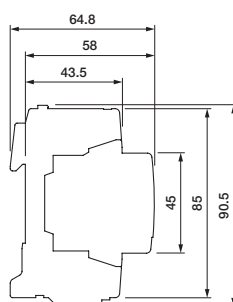

OVR T2 2L 15-150 P U
OVR T2 2L 15-320 P U
OVR T2 2N 15-150 P U
OVR T2 2N 15-320 P U

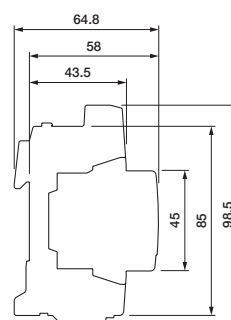

OVR T2 2L 40-150 P TS U
OVR T2 2L 40-320 P TS U
OVR T2 2N 40-150 P TS U
OVR T2 2N 40-320 P TS U
OVR T2 2N 40-440 P TS U
OVR T2 2N 40-550 P TS U
OVR T2 2N 40-660 P TS U

Grounded Wye networks

Type	Width mm
OVR T2 3L 15-150 P U	53.4
OVR T2 3L 40-150 P TS U	53.4
OVR T2 3L 40-440 P TS U	53.4
OVR T2 3N 15-150 P U	71.2
OVR T2 3N 15-320 P U	71.2
OVR T2 3N 40-150 P TS U	71.2
OVR T2 3N 40-320 P TS U	71.2
OVR T2 3N 40-440 P TS U	71.2
OVR T2 3N 40-550 P TS U	71.2
OVR T2 3N 40-660 P TS U	71.2

Main dimensions mm

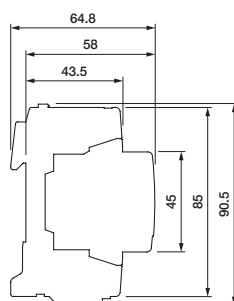

OVR T2 3L 15-150 P U
OVR T2 3N 15-150 P U
OVR T2 3N 15-320 P U

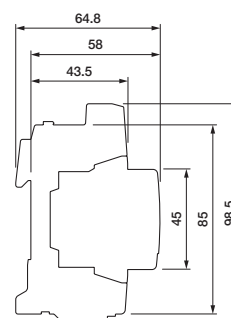

OVR T2 3L 40-150 P TS U
OVR T2 3L 40-440 P TS U
OVR T2 3N 40-150 P TS U
OVR T2 3N 40-320 P TS U
OVR T2 3N 40-440 P TS U
OVR T2 3N 40-550 P TS U
OVR T2 3N 40-660 P TS U

Digital SPD—eOVR

Overall dimensions

Type	Width mm	Heigh mm	Depth mm
eOVR T2-T3 1N 20-275	62.9	130	65.3
eOVR T2-T3 3N 20-275	98.5	130	65.3
eOVR T2 1N 40-350	62.9	130	65.3
eOVR T2 3N 40-350	98.5	130	65.3
eOVR T2 3N 80-440s	83.6	130	76.3
eOVR T1-T2 3N 12.5-275S	83.6	130	76.3
eOVR T1-T2 3N 12.5-440s	151.9	130	76.7
eOVR T2 3L 40-275s	83.6	130	76.3
eOVR T1-T2 3L 12.5-440s	151.9	130	76.7
eOVR T1-T2 4L 12.5-440s	151.9	130	76.7

eOVR T2-T3 1N 20-275
 eOVR T2 1N 40-350
 eOVR T2-T3 3N 20-275
 eOVR T2 3N 40-350

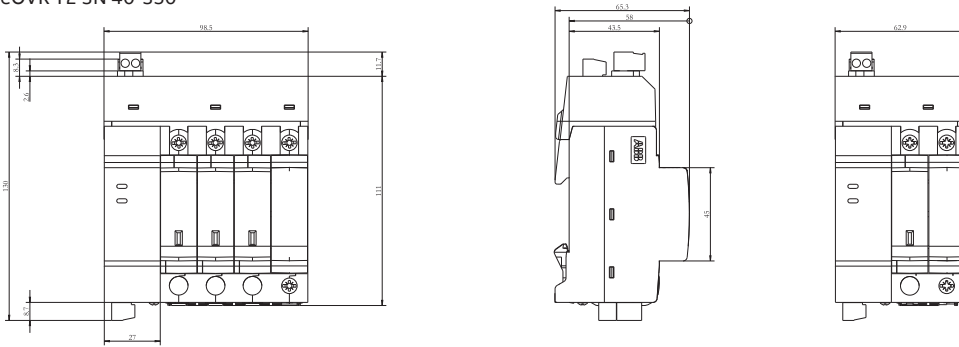

eOVR T2 3L 40-275S
 eOVR T2 3N 80-440S
 eOVR T1-T2 3N 12.5-275S

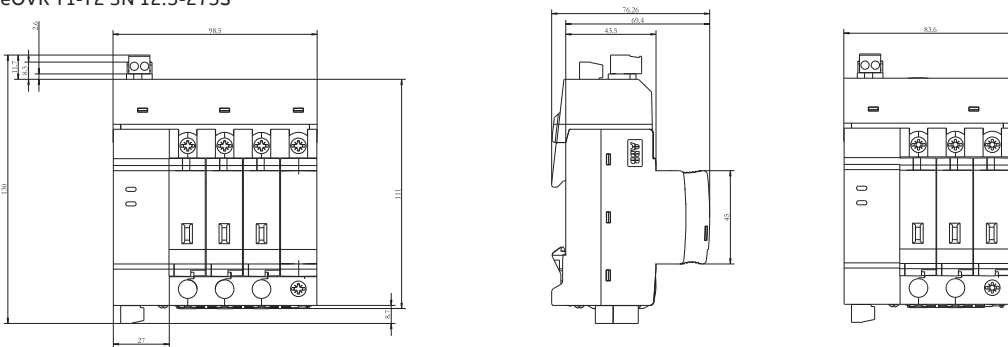

eOVR T2 3L 40-275S
 eOVR T2 3N 80-440S
 eOVR T1-T2 3N 12.5-275S

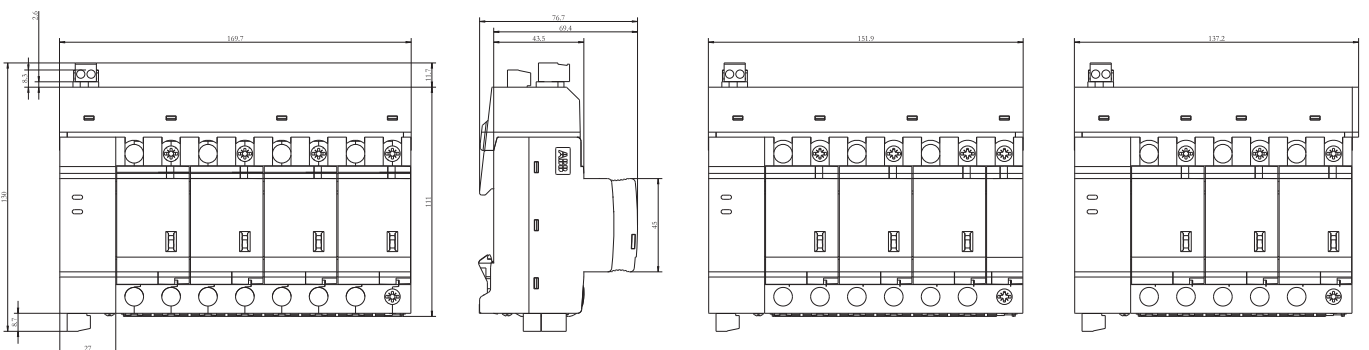

Protection and safety technical details

E 90 fuseholders

E 90 fuse-holders

IEC 60947-3: Switches, disconnectors, switch-disconnectors and fuse combination units

This standard sets out the requirements of devices for connect/disconnect and switching operations.

Disconnecter:

The disconnector is a mechanical device that, in the open position, meets the requirements specified for the disconnect function by the international IEC 60947-3 standard. The opening of a disconnector guarantees that the downstream circuit is electrically isolated from the upstream circuit. This is a required condition before personnel can access the equipment on the network, for example to perform maintenance. The IEC 60364 standard prohibits carrying out maintenance on the installation if the circuits have not been disconnected.

Fuse disconnector:

This is the definition of a fuse carrier that performs a disconnect function. Not all fuse carriers are disconnectors: in order to be classified as such they must meet the requirements and pass the tests prescribed by the

IEC 60947-3 standard.

Fuse switch-disconnector:

This is the designation given by the IEC 60947-3 standard to a fuse disconnector that permits switching under load. Not all fuse disconnectors allow this type of operation: in order to be classified as a fuse switch-disconnector, a device must have utilization category AC-21B or higher.

Utilization categories:

Not all connect/disconnect devices have the same performance specifications: the permitted operations depend on a parameter which defines the specific conditions of use, called the utilization category.

It specifies:

- The type of network (a.c./d.c.)
- The permitted type of operation (under no load, for resistive loads, for highly inductive loads, ecc...)
- The frequency of use

The E90 fuse switch-disconnectors have utilization category AC-22B. The E 90 PV fuse disconnectors have utilization category DC-20B.

Type of current	Utilization category		Typical applications
	A	B	
Alternating current	AC-20A	AC-20B	Connecting and disconnecting under no load.
	AC-21A	AC-21B	Switching of resistive loads, including moderate overloads
	AC-22A	AC-22B	Switching of mixed, resistive and inductive loads, including moderate overloads
	AC-23A	AC-23B	Switching of motors or other highly inductive loads
Direct current	DC-20A	DC-20B	Connecting and disconnecting under no load.
	DC-21A	DC-21B	Switching of resistive loads including moderate overloads
	DC-22A	DC-22B	Switching of mixed, resistive and inductive loads, including moderate overloads (e.g. shunt motors)
	DC-23A	DC-23B	Switching of highly inductive loads (e.g. series connected motors)

What loads can be connected/disconnected by a product with utilization category AC-22B?

Utilization category AC-22B permits occasional switching of mixed, resistive and inductive loads, including moderate overloads, in alternating current circuits. Examples of mixed loads are: transformers, power-factor corrected motors, capacitor banks, discharge lamps, heating, etc..

What loads can be connected/disconnected by a product with utilization category AC-20B?

Utilization category AC-20B does not permit connecting or disconnecting under load. An additional load break device is required.

IEC 60269-1: Fuses with voltage rating not exceeding 1000 V for alternating current and 1500 V for direct current

This standard sets out the requirements for low voltage fuses, and consequently the requirements for the fuse carrier devices that hold them.

The standard has two separate sections with different requirements, depending on the type of person using the equipment.

IEC 60269-2: supplementary requirements for fuses for use by authorized persons, mainly for industrial applications.

IEC 60269-3: supplementary requirements for fuses for use by unskilled persons, mainly for household and similar applications.

Protection and safety technical details

E 90 fuseholders

Meaning	Suffix A	Frequent use
	Suffix B	Infrequent use

What is the difference between a fuse carrier conforming to the IEC 60947-3 standard and one conforming to the IEC 60269-2 standard?

These are two complementary standards: IEC 60269-2 sets out the characteristics of the fuses, which in turn also determine the general requirements for the fuse carriers. It is therefore the reference standard for overcurrent protection, but not for connecting/disconnecting and switching.

Is a fuse carrier conforming to IEC 60269-1 a disconnecter?

A device conforming only to IEC 60269 has a “disconnect function” but is not classified as a disconnecter under the more stringent IEC 60947-3 standard.

Why does the E 90 series have a lower direct current voltage rating under the IEC 60269-3 standard than under the IEC 60269-2 standard?

IEC 60269-2 sets out the requirements for industrial applications, and therefore the reference voltages are higher

than those for the residential and commercial applications covered by IEC 60269-3. In other words, the rated voltage of the fuse carrier depends on the type of installation in which it is used, and the regulations applicable to it.

Is it possible to create multi-pole configurations using an assembly kit?

Multi-pole units made up using an assembly kit to combine single pole units will no longer conform to the reference standards.

In case of installations with many poles side by side, or installations in particular climate conditions, what derating of the nominal values should be taken into account?

The following tables give the parameters for derating the nominal current as a function of the number of poles installed side by side or the temperature and relative humidity.

Installation of multiple poles side by side:

E 91/32		E 91hN/32		E90 50/125	
Poles	Maximum current	Poles	Maximum current	Poles	Maximum current
1 ...4	I_n	1 ...3	I_n	1...3	I_n
5...7	$0.8 \times I_n$	4...9	$0.7 \times I_n$	4...6	$0.95 \times I_n$
more than 7	$0.7 \times I_n$	more than 10	$0.6 \times I_n$	more than 7	$0.9 \times I_n$

Climate conditions:

E90/32		E90 50/125	
Maximum temperature	Maximum current	Maximum temperature	Maximum current
20° C	I_n	20° C	I_n
30° C	$I_n \times 0.95$	30° C	$I_n \times 0.95$
40° C	$I_n \times 0.9$	40° C	$I_n \times 0.9$

Protection and safety technical details

E 90 fuseholders

Protection and disconnection of 1000 V DC lines

String protection

To avoid equipments damage on DC lines and to ensure isolation of the PV system in case of maintenance, E90 PV disconnectors fuses can be installed downstream the inverter to protect each single string. The fuses must be selected according to the rated current of the line and to the maximum dissipated power.

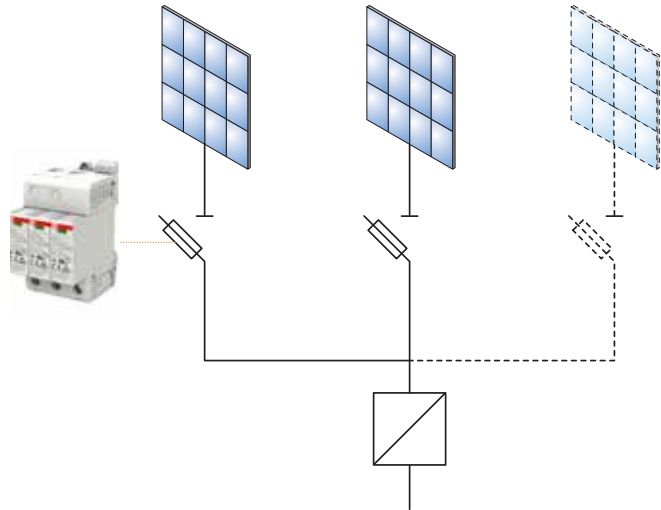

Back-Up Download

When the lcc short circuit current, at the point of installation, is greater than 10 kA (for 1000V & 1500V) DC, the OVR PVs Surge Protective Devices require a back-up protection with a specific type gR fuse.

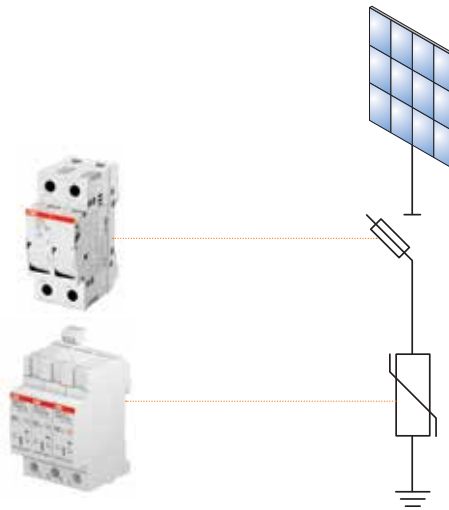

DC side of the inverter

For small size photovoltaic systems, E 90 PV fuse disconnectors can be used to protect the DC side of the inverter. The fuse should be chosen according to the rated current of the inverter.

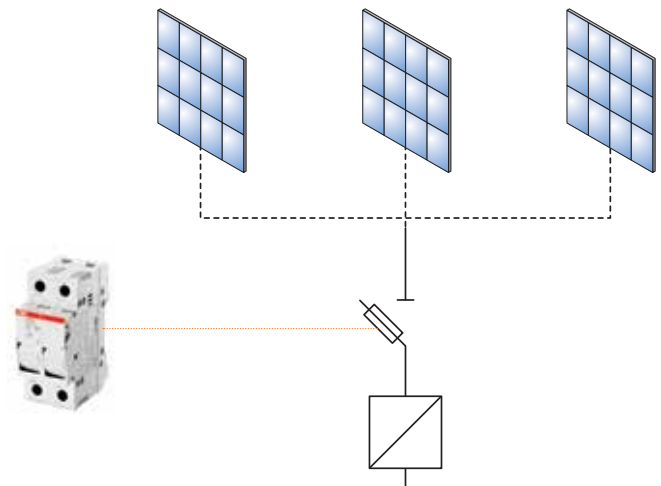

Protection and safety technical details

E 90 fuseholders

Protection system selection

Maximum fuse rated current

Rated voltage		Fuseholder			
		E 90/20 8.5 x 31.5 mm	E 90/32 10.3 x 38 mm	E 90/50 14 x 51 mm	E 90/125 22 x 58 mm
400 V a.c.	gG	20 A	32 A	-	-
	aM	10 A	32 A	-	-
500 V a.c.	gG	-	25 A	50 A	100 A
	aM	-	20 A	50 A	125 A*
690 V a.c.	gG	-	10 A	25 A	80 A
	aM	-	-	25 A	80 A

* = to be used in combination with a device which guarantees protection against overload.

In the table above you will find indication about the highest rated current fuse that you can host inside a fuseholder, depending on the rated voltage of the circuit, the fuse size and the tripping curve characteristic.

ABB fuses and fuseholders comply with all regulatory requirements and sometimes they allow to install a fuse with rated current higher than the one set by the Standard IEC EN 60269-2-1.

Protection and safety technical details

E9F fuses

E9F fuses

Can fuses with rated current values higher than the one indicated in the table be used? For example, can a 10.3 x 38 mm 32 A gG fuse be used in a 10.3 x 38 mm E 90/32 fuse holder?

Yes, by following the manufacturer's instructions: you have to check that the power dissipated at the rated voltage value declared by the manufacturer for the size considered does not exceed the maximum dissipated power limit of the fuse holder. In this specific case, an E9F10 GG32 fuse dissipates 3 W at 400 V rated voltage.

Since an E 90/32 series fuse holder for 10.3 x 38 mm fuses achieves 3 W thermal dissipation, the fuse in question can be used at 400 V rated voltage or less.

Can a 10.3 x 38 mm 32 A gG fuse be used in a 10.3 x 38 mm E 90/32 fuse holder with a rated voltage exceeding 400 V?

In the specific case of E9F10 GG32, use of rated voltage exceeding 400 V fails to allow the equipment to comply with the maximum dissipated power limit.

Must the rated voltage always be derated if a fuse with a rated current exceeding the value in the table is used?

No, it depends on the technical specifications of the fuse. Derating is not required for E9F 8 gG 20 fuses since they ensure (at 400 V AC) 2.30 W dissipated power, which is lower than the 2.5 W limit imposed by the standard.

Maximum dissipated power value for cylindrical fuses according to IEC EN 60269-2-1 (Art. 5-5)

Characteristic curve	Fuse			
	E9F 8 8.5 x 31.5 mm	E9F 10 10.3 x 38 mm	E9F 14 14 x 51 mm	E9F 22 22 x 58 mm
gG	2.5 W	3 W	5 W	9.5 W
aM	0.9 W	1.2 W	3 W	7 W

The table lists the maximum dissipated power values of the fuses, considering the size and the characteristic curve. The highlighted values correspond to the maximum dissipated power limit for fuse holders.

E9F gG

Power dissipation [W]

In [A]	E9F 8	E9F 10	E9F 14	E9F 22
	Size 8.5x31.5 mm	Size 10.3x38 mm	Size 14x51 mm	Size 22x58 mm
0.5		0.07 W		
1	0.35 W	0.45 W		
2	0.45 W	0.5 W	0.75 W	
4	0.65 W	0.85 W	1.1 W	1.25 W
6	0.83 W	0.95 W	1.25 W	1.4 W
8	1 W	1.15 W	1.45 W	1.6 W
10	1.2 W	1.3 W	1.65 W	1.9 W
12	1.3 W	1.4 W	1.8 W	2 W
16	1.7 W	1.9 W	2.35 W	2.5 W
20	2 W	2.4 W	2.75 W	3.4 W
25	2.4 W	2.7 W	3.1 W	3.5 W
32		2.8 W	3.6 W	3.7 W
40			4 W	4.3 W
50			4.8 W	5.3 W
63				6.3 W
80				7.4 W
100				8.3 W
125				11.3 W

It is important verify that the power dissipation by the fuse does not exceed the limit allowed by the fuse it is hosted. In **bold** are shown the maximum values of power dissipation according to IEC EN 60269-2-1.

Protection and safety technical details

E9F fuses

Time current characteristic curves

E9F 8 gG

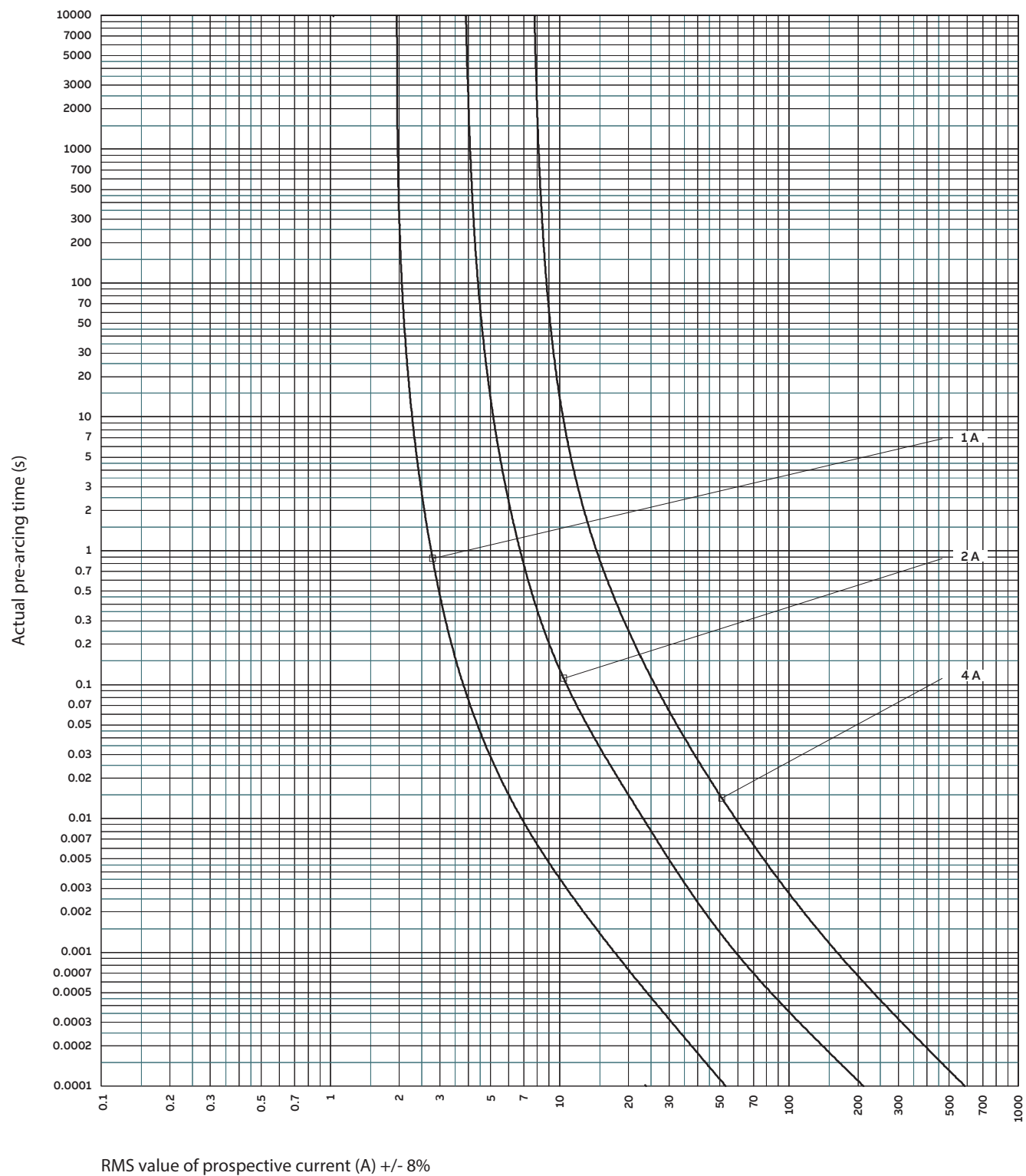

Protection and safety technical details

E9F fuses

Time current characteristic curves

E9F 10 gG

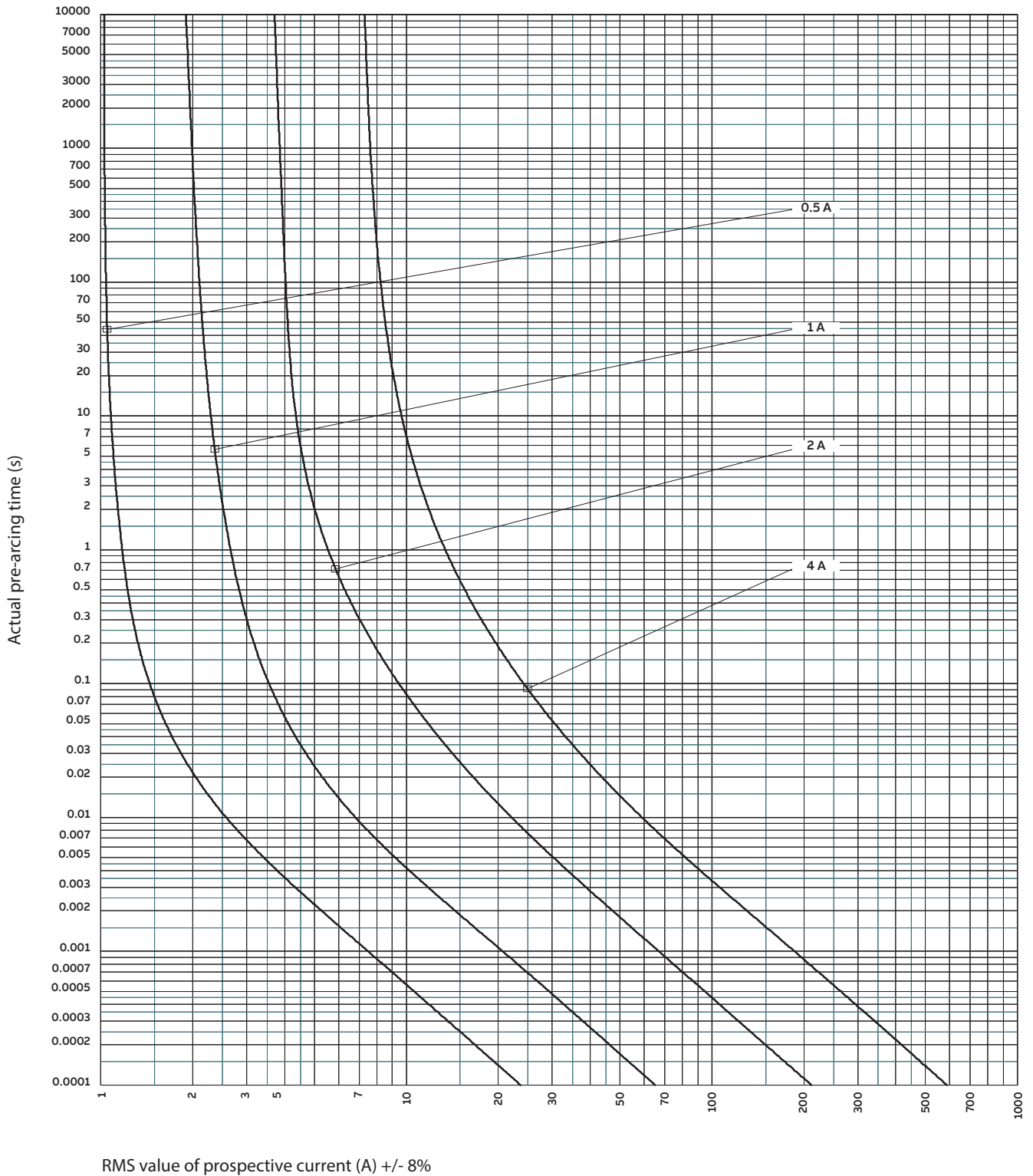

Protection and safety technical details

E9F fuses

Time current characteristic curves

E9F 10 gG

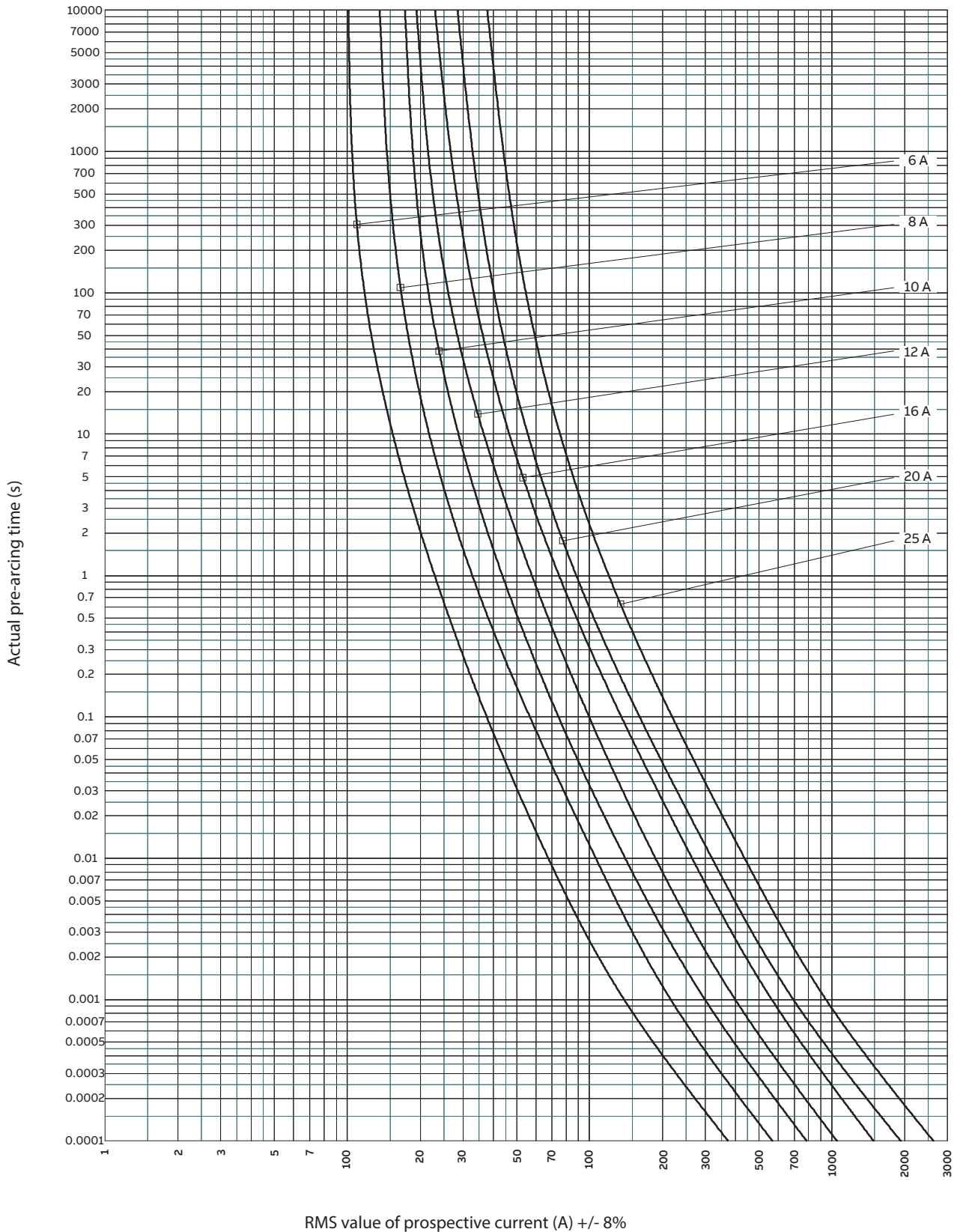

Protection and safety technical details

E9F fuses

Time current characteristic curves

E9F 10 gG

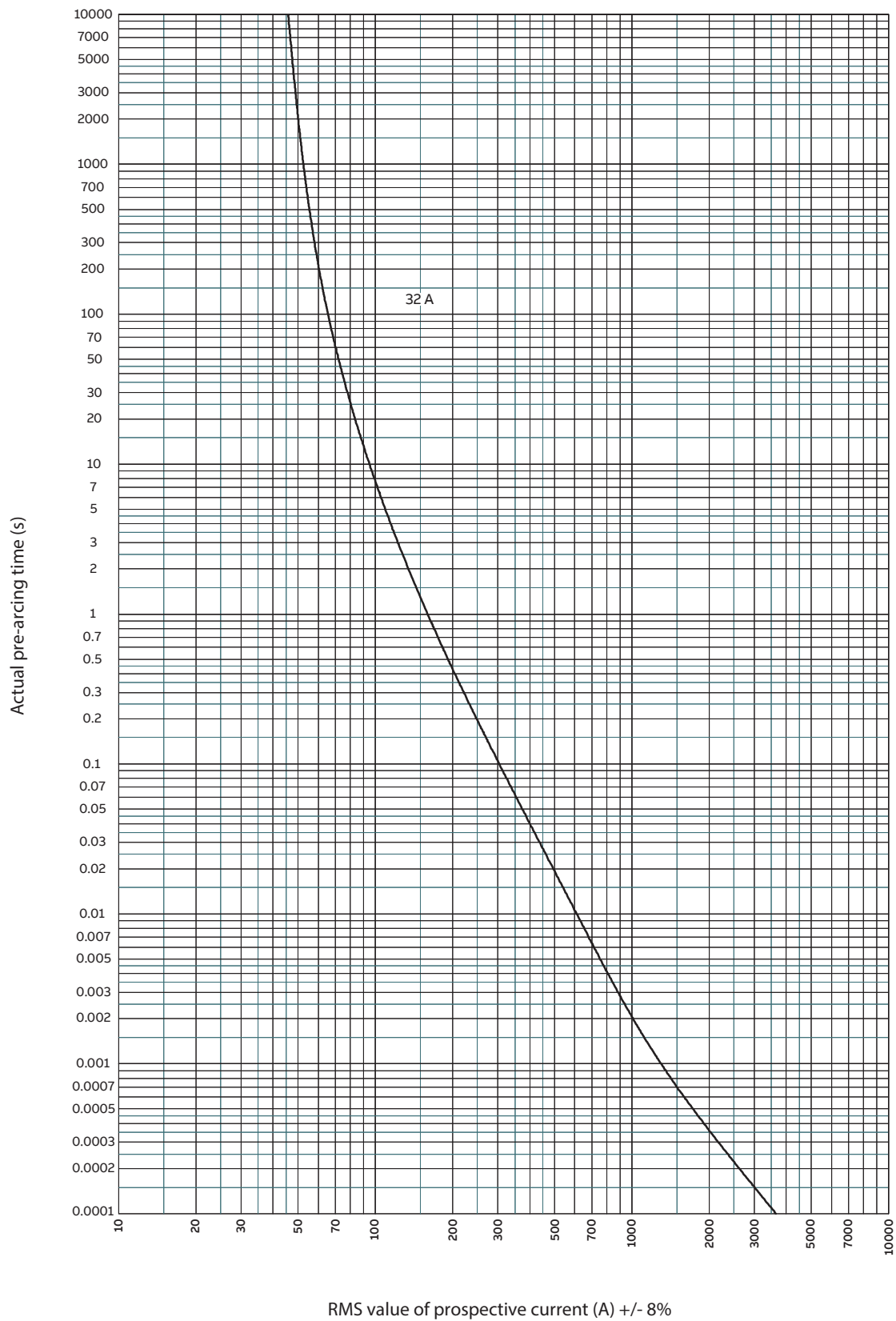

Protection and safety technical details

E9F fuses

Time current characteristic curves

E9F 14 gG

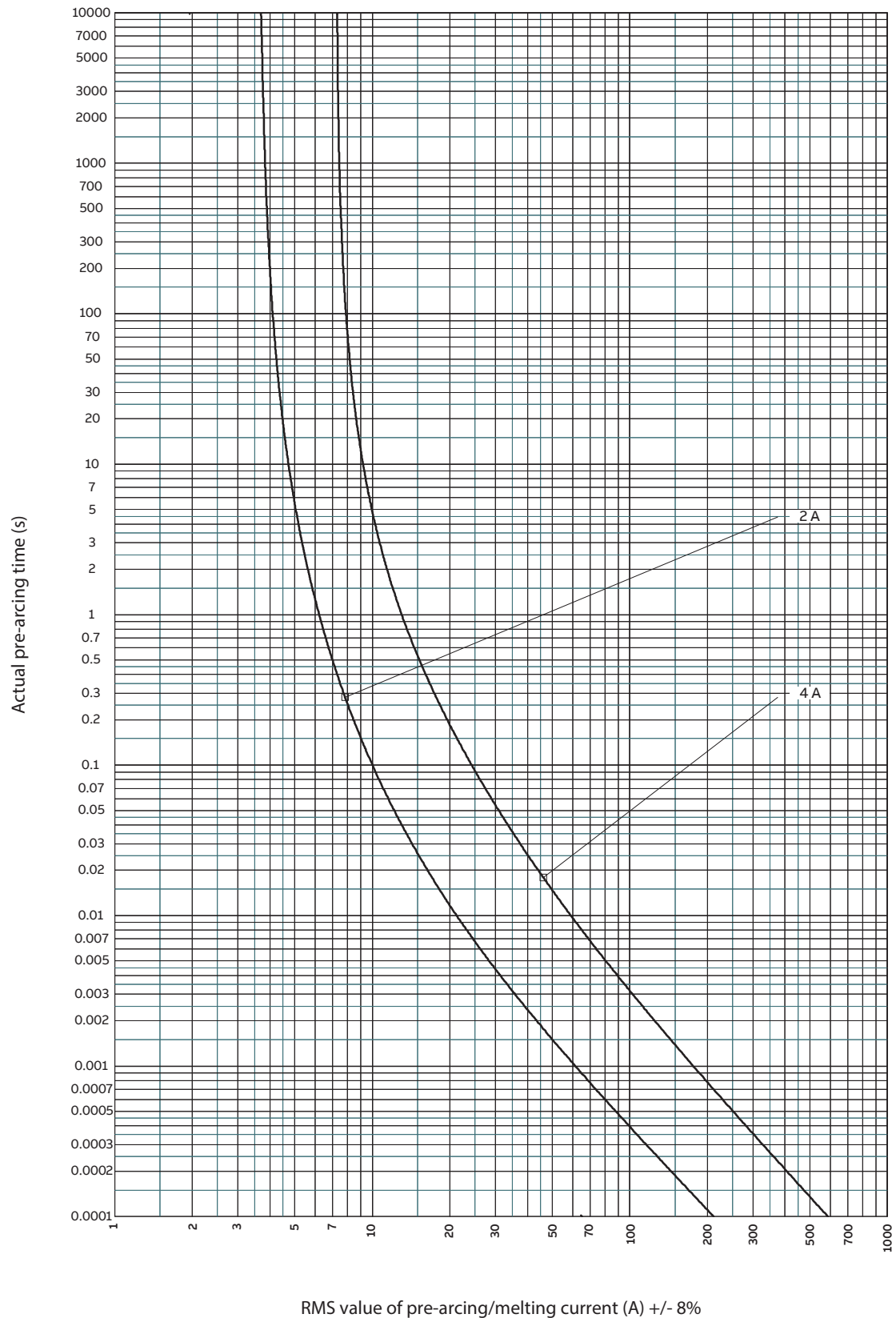

Protection and safety technical details

E9F fuses

Time current characteristic curves

E9F 22 gG

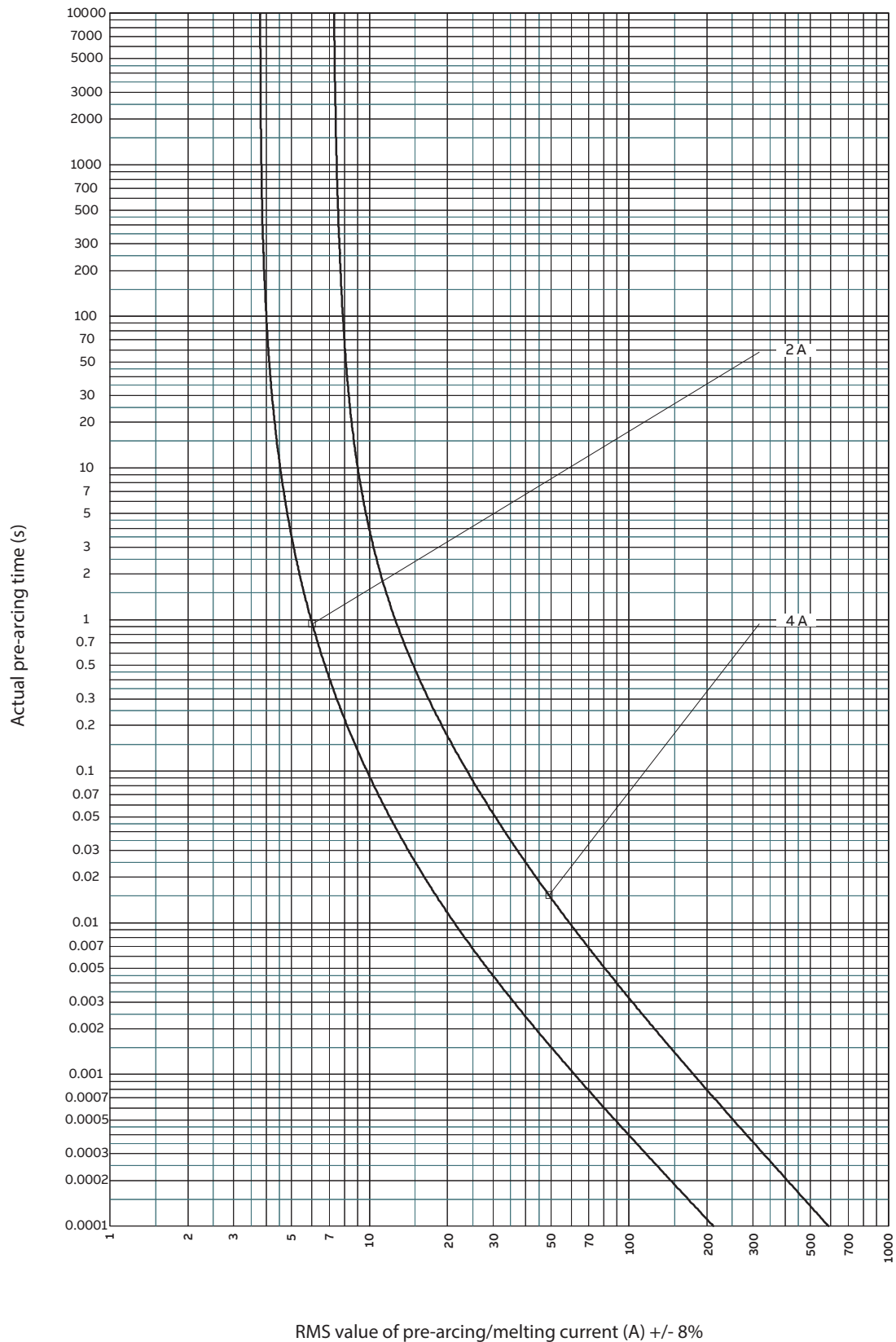

Protection and safety technical details

E9F fuses

Time current characteristic curves

E9F 22 gG

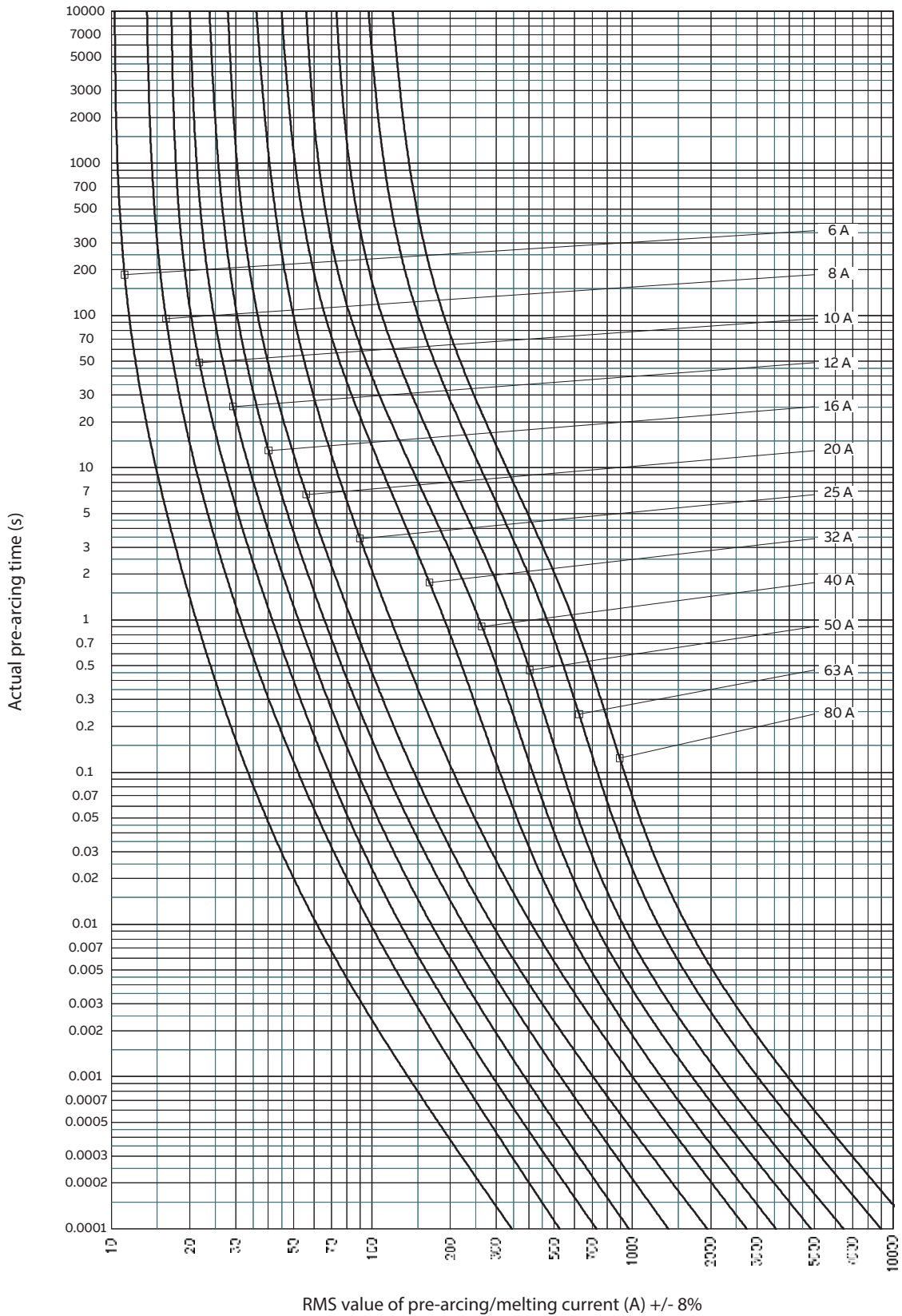

Protection and safety technical details

E9F fuses

Time current characteristic curves

E9F 22 gG

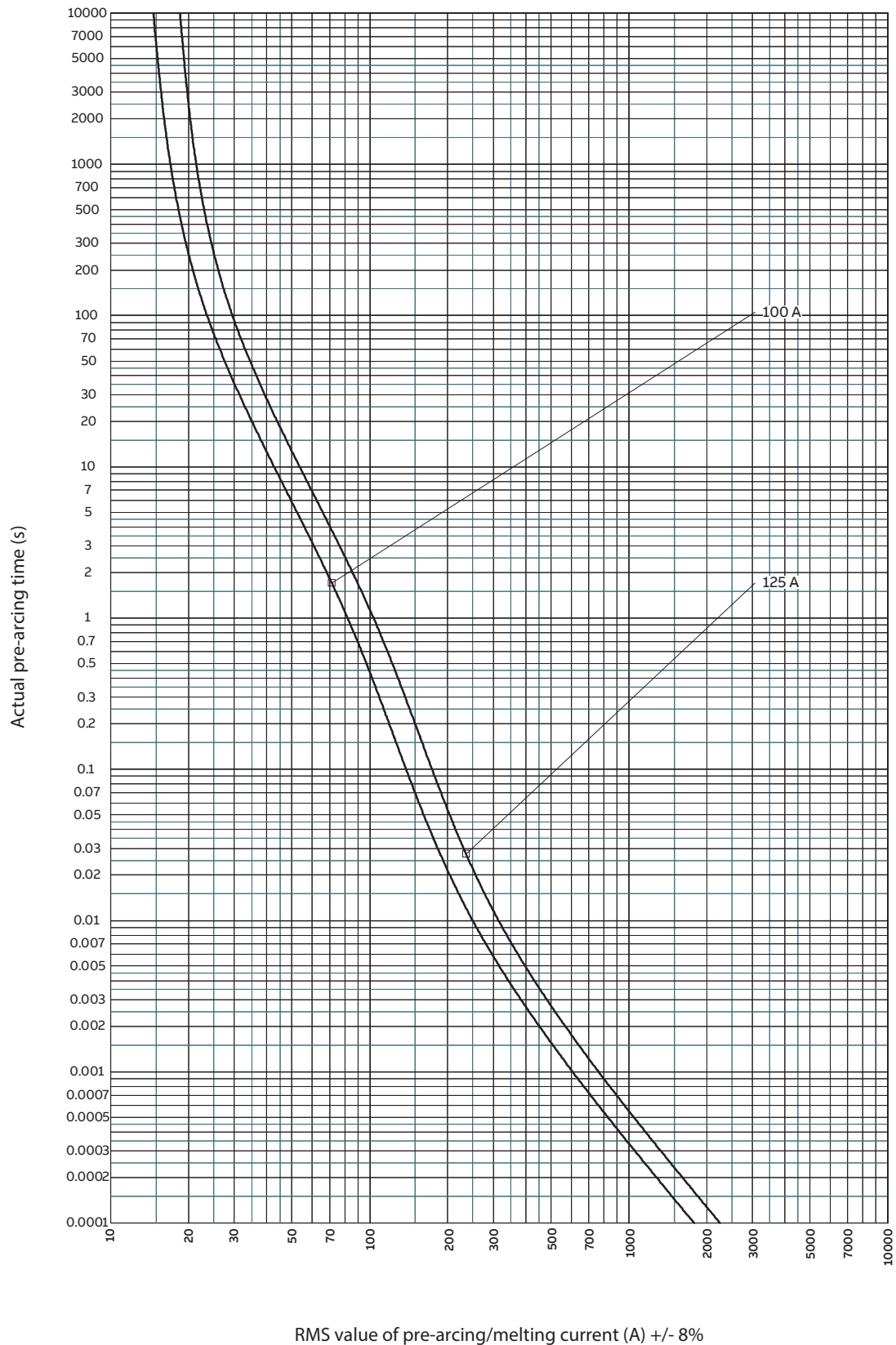

Protection and safety technical details

E9F fuses

Operating I²T characteristics

E9F 8 gG

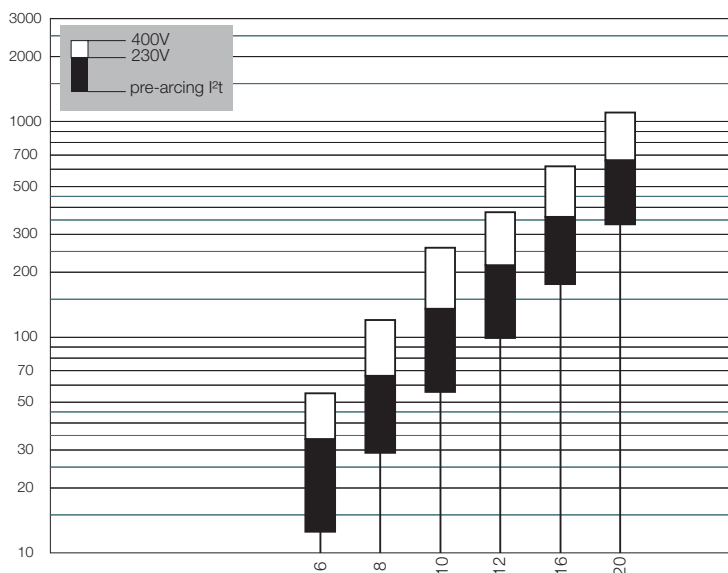
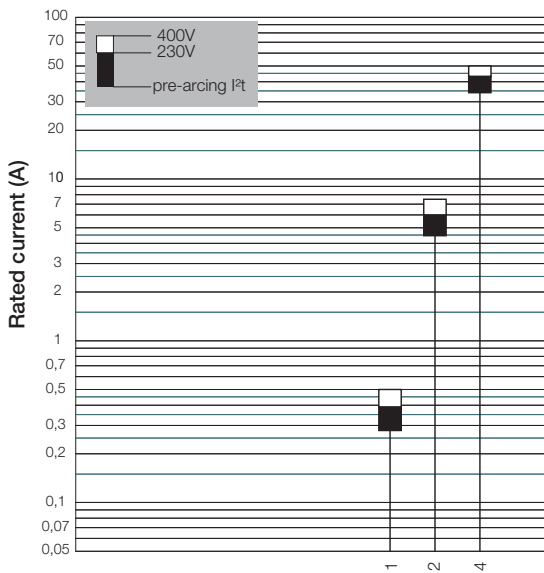

E9F 10 gG

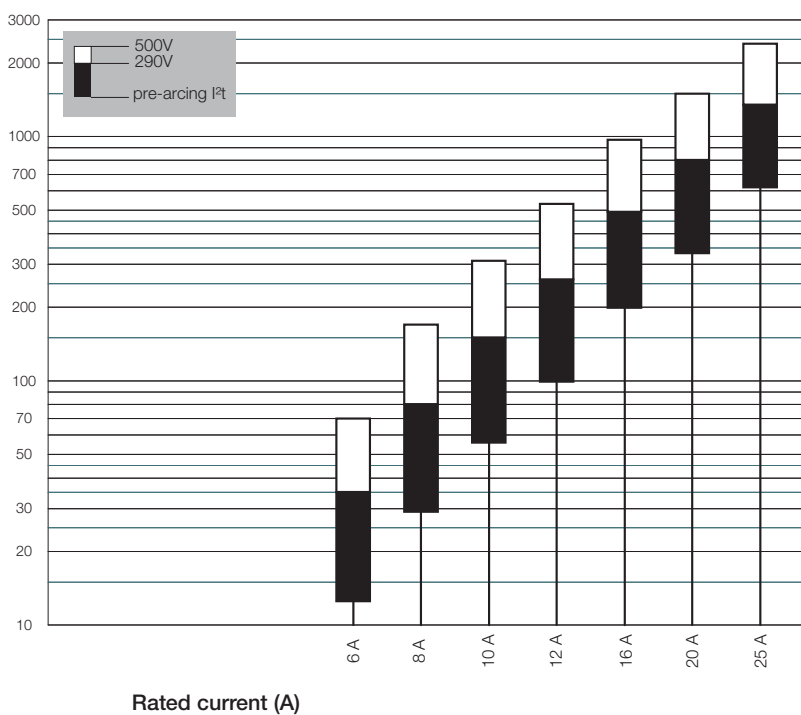
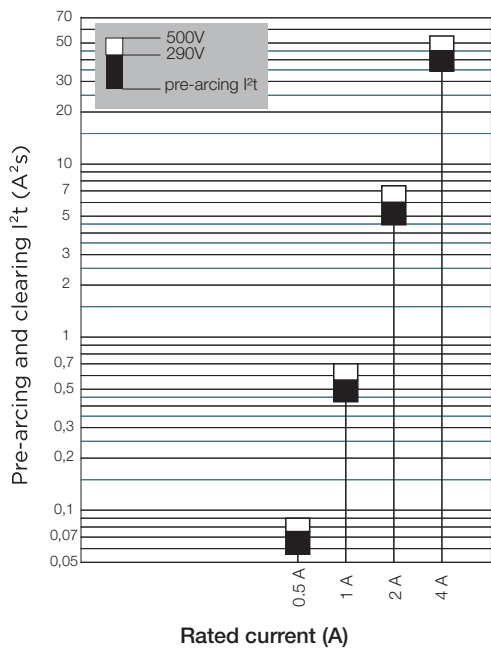

Protection and safety technical details

E9F fuses

Operating I²T characteristics

E9F 10 gG

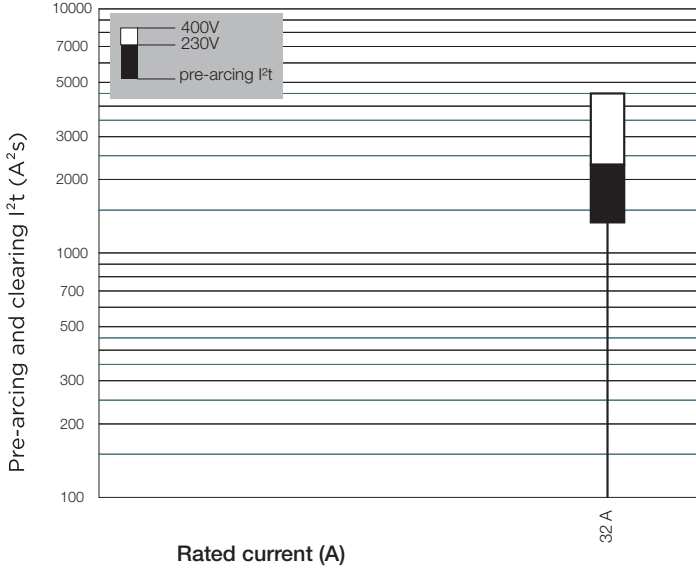

E9F 14 gG

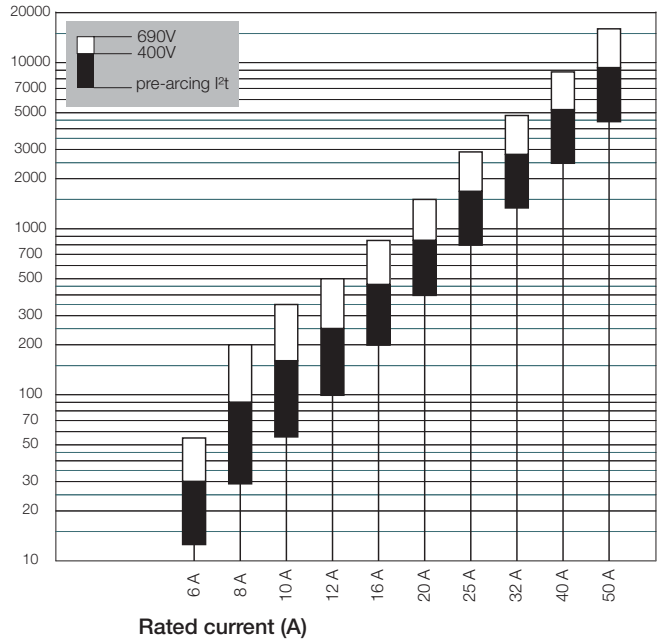
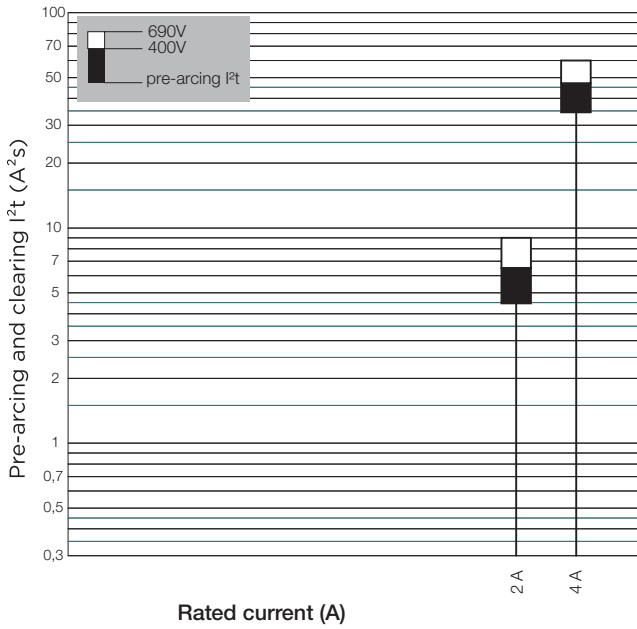

Protection and safety technical details

E9F fuses

Operating I²T characteristics

E9F 22 gG

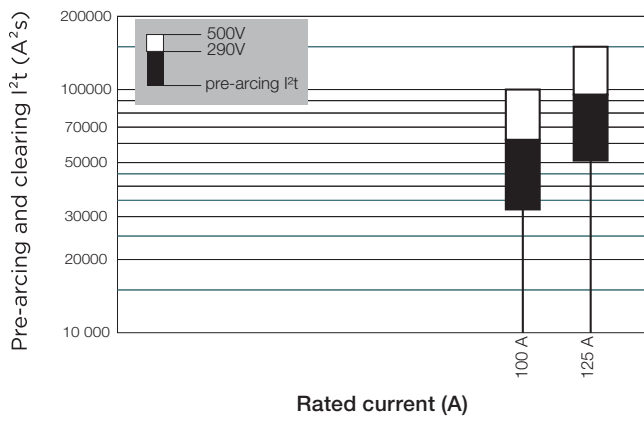
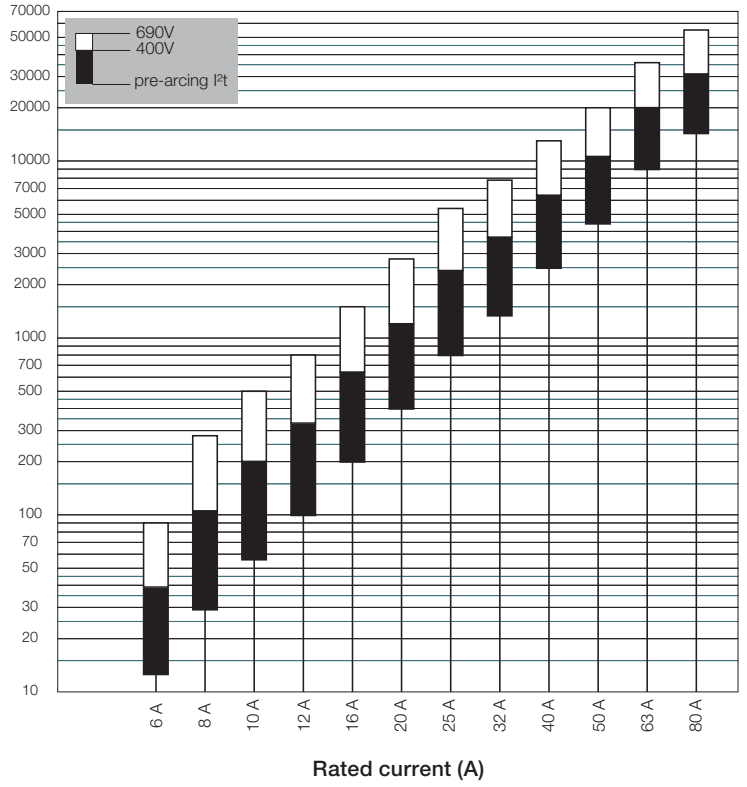
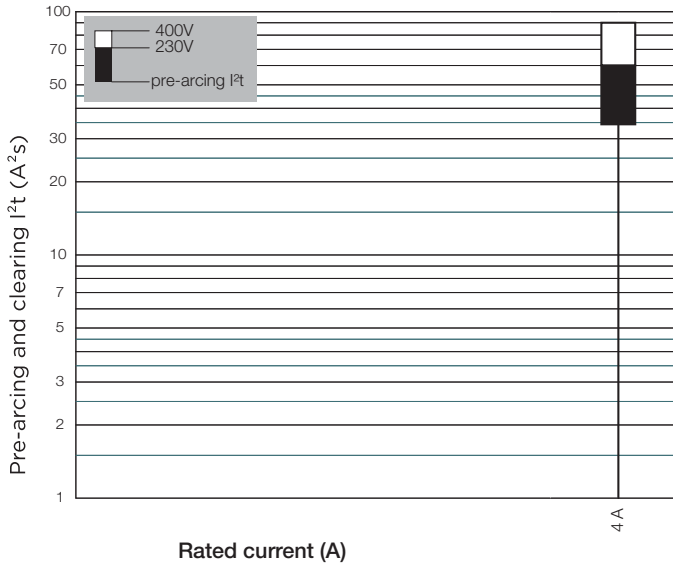

Protection and safety technical details

E9F fuses

Cut-off current characteristic

E9F 8 gG

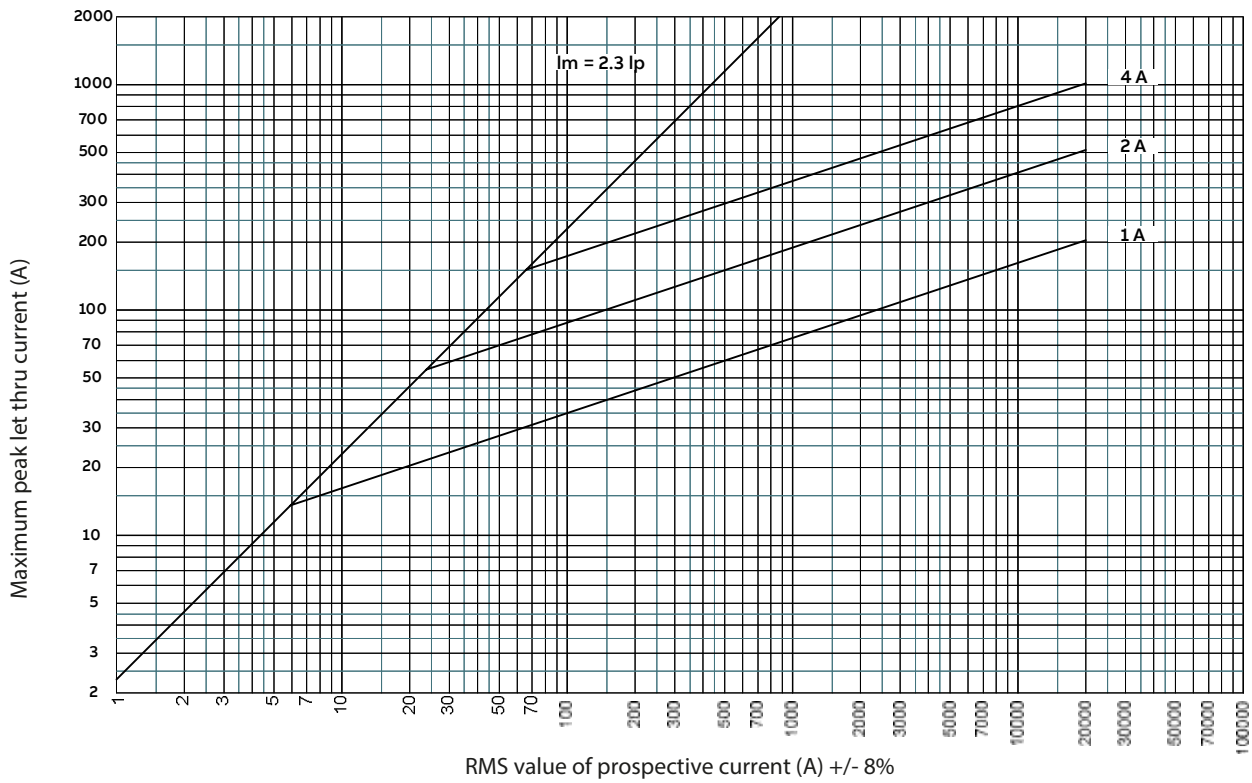

E9F 8 gG

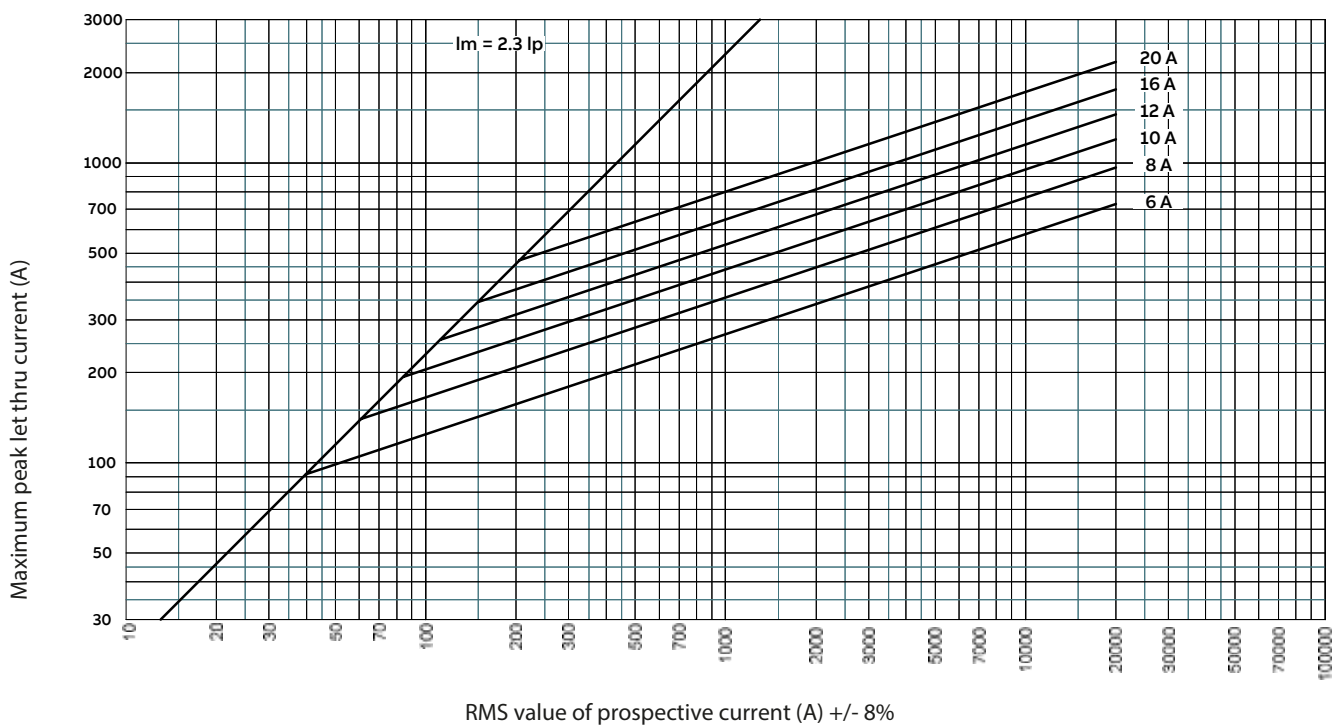

Protection and safety technical details

E9F fuses

Cut-off current characteristic

E9F 10 gG

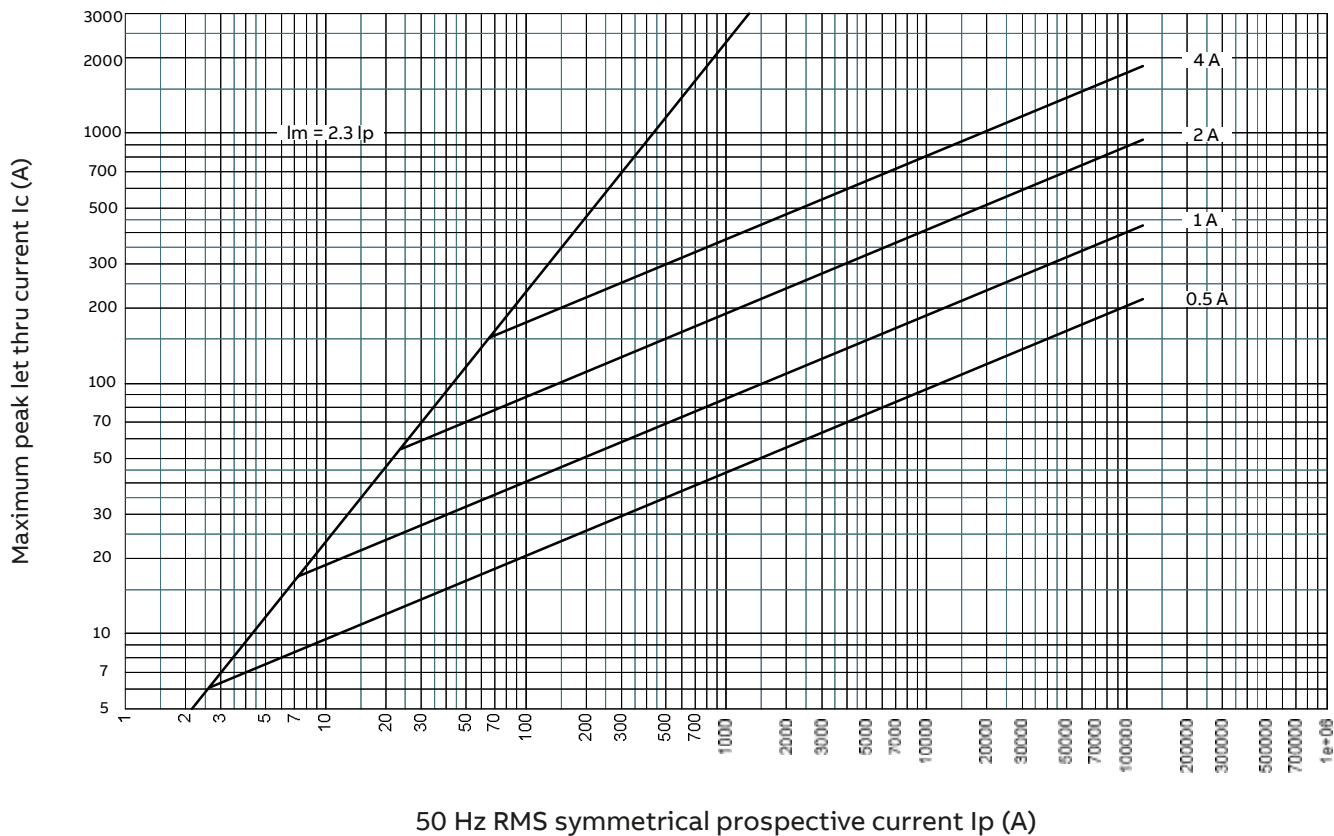

Protection and safety technical details

E9F fuses

Cut-off current characteristic

E9F 10 gG

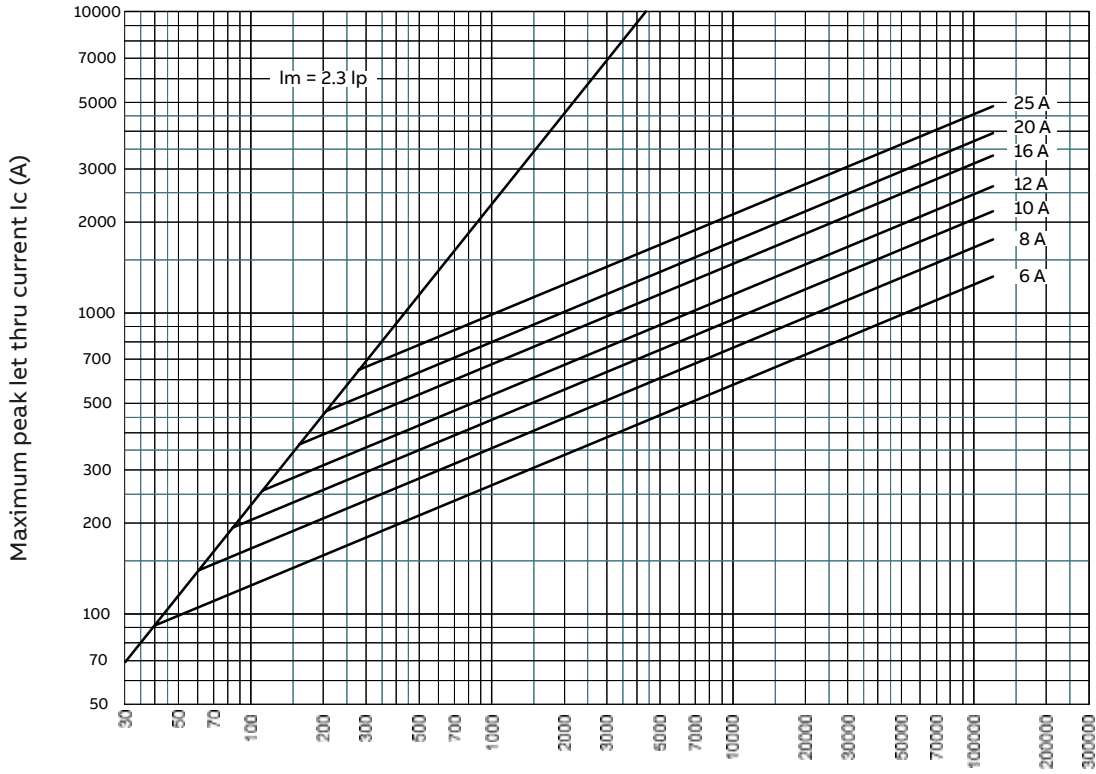

50 Hz RMS symmetrical prospective current I_p (A)

E9F 10 gG

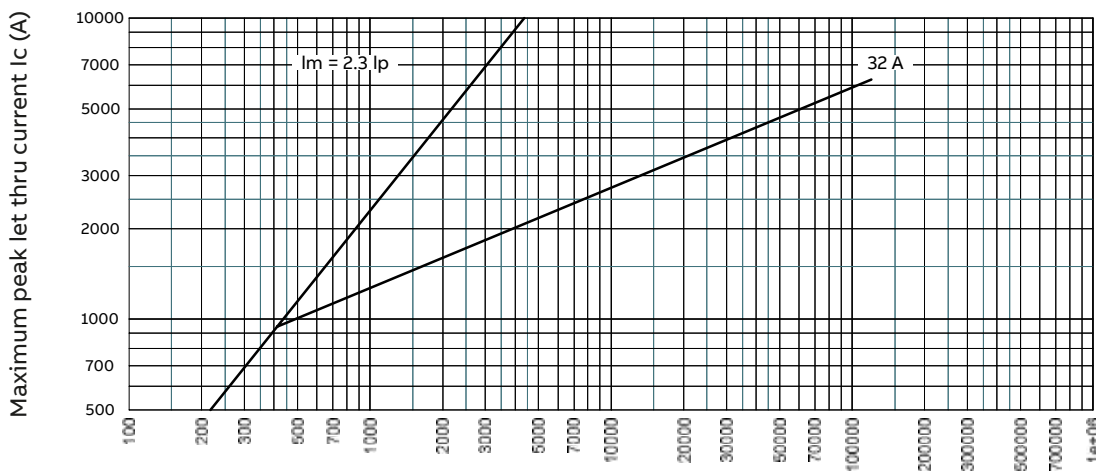

50 Hz RMS symmetrical prospective current I_p (A)

Protection and safety technical details

E9F fuses

Cut-off current characteristic

E9F 22 gG

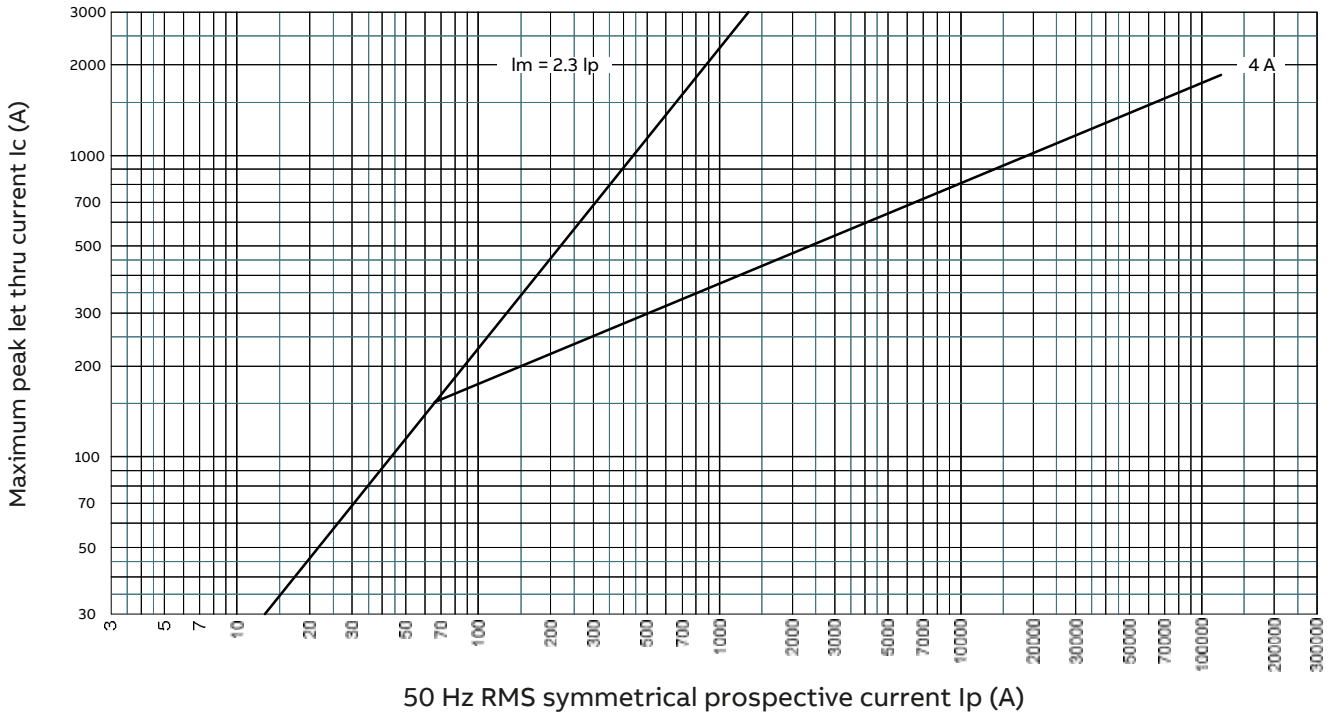

E9F 22 gG

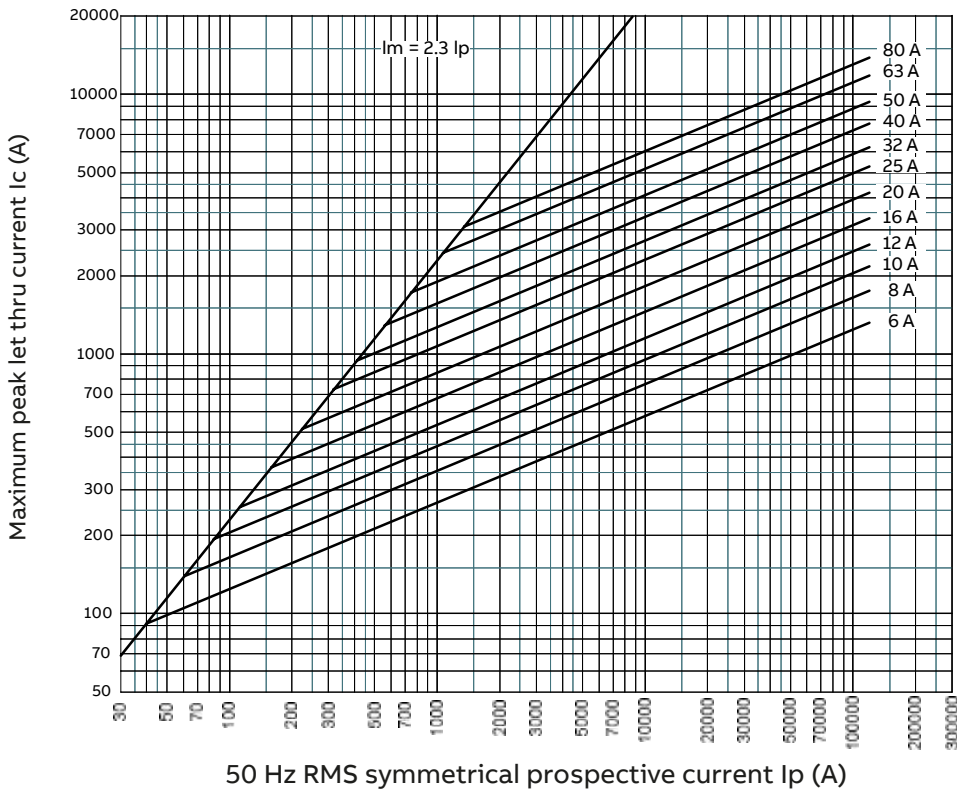

Protection and safety technical details

E9F fuses

Cut-off current characteristic

E9F 22 gG

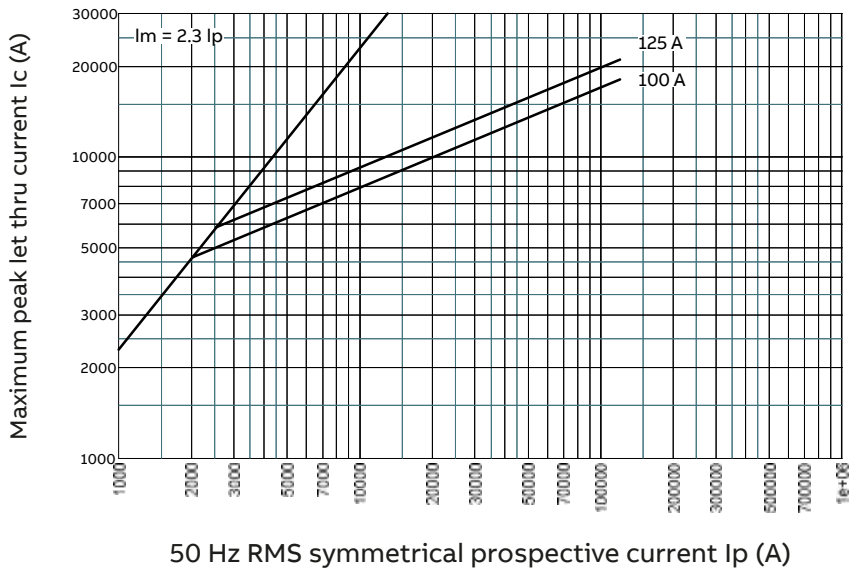

E9F gG Temperature increase

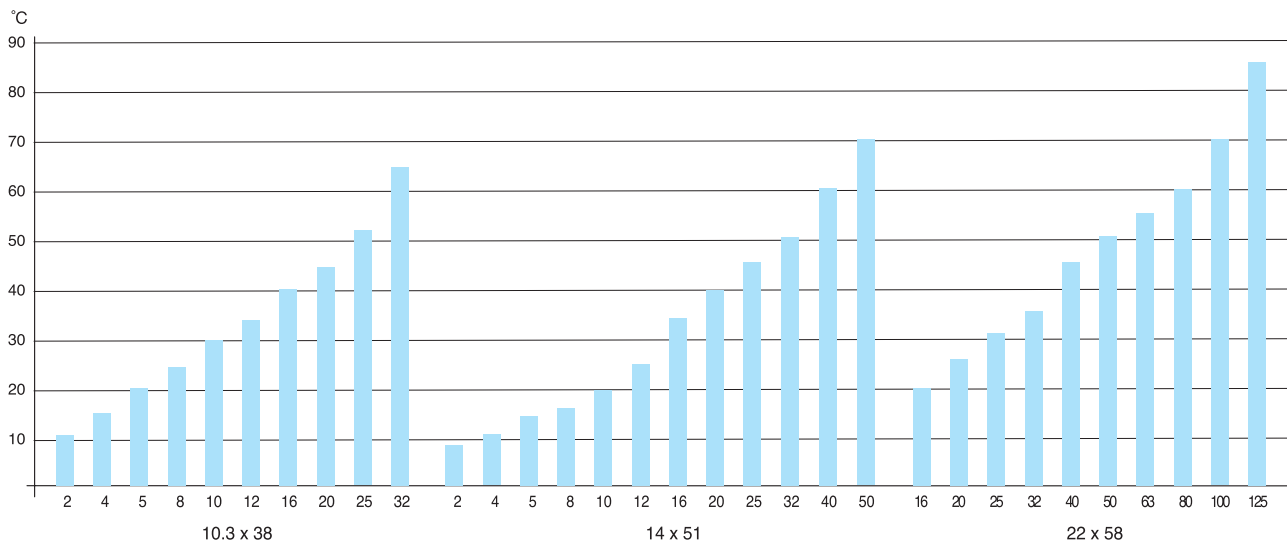

Protection and safety technical details

E9F fuses

E9F aM

Power dissipation [W]

In [A]	E9F 8	E9F 10	E9F 14	E9F 22
	Size 8.5x31.5	Size 10.3x38	Size 14x51	Size 22x58
0.5	-	0.07 W	-	-
1	0.09 W	0.1 W	0.13 W	-
2	0.15 W	0.14 W	0.18 W	-
4	0.26 W	0.28 W	0.28 W	-
6	0.35 W	0.38 W	0.42 W	0.45 W
8	0.47 W	0.55 W	0.55 W	0.6 W
10	0.55 W	0.62 W	0.65 W	0.75 W
12	-	0.82 W	0.75 W	0.85 W
16	-	0.87 W	1.05 W	1.15 W
20	-	1.05 W	1.3 W	1.35 W
25	-	1.2 W	1.55 W	1.7 W
32	-	1.8 W	2.05 W	2.2 W
40	-	-	2.65 W	2.7 W
45	-	-	2.85 W	-
50	-	-	2.95 W	3.6 W
63	-	-	-	4.8 W
80	-	-	-	6.2 W
100	-	-	-	6.65 W
125	-	-	-	9.9 W

It is important verify that the power dissipation by the fuse does not exceed the limit allowed by the fuse it is hosted. In **bold** are shown the maximum values of power dissipation according to IEC EN 60269-2-1.

E9F aM Temperature increase (testing in superior contact)

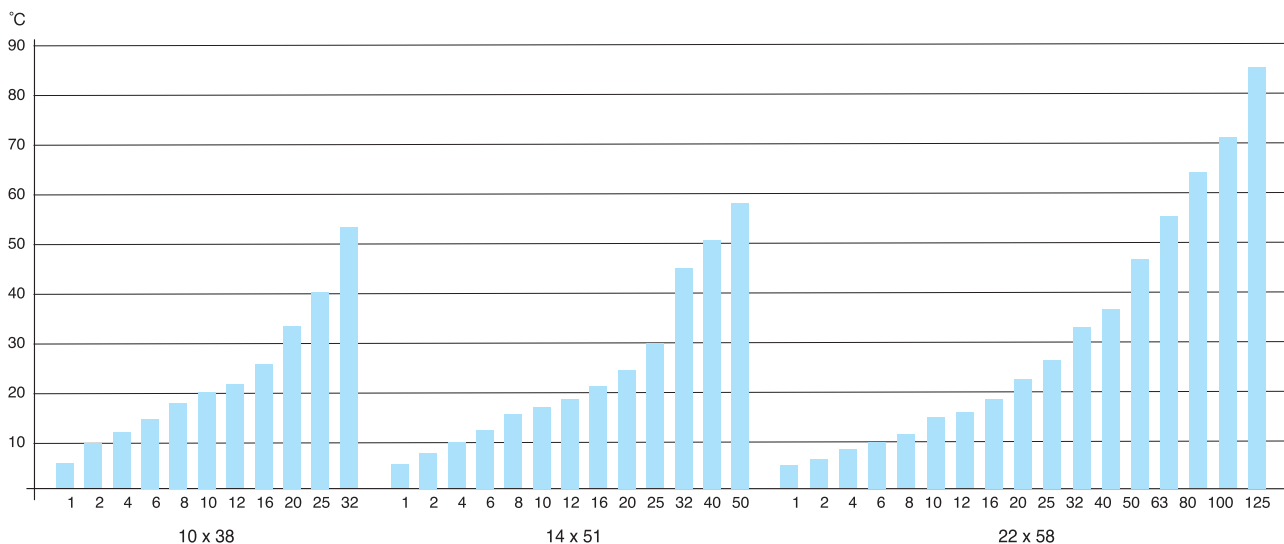

Protection and safety technical details

E9F fuses

Time current characteristic curves

E9F 8 aM

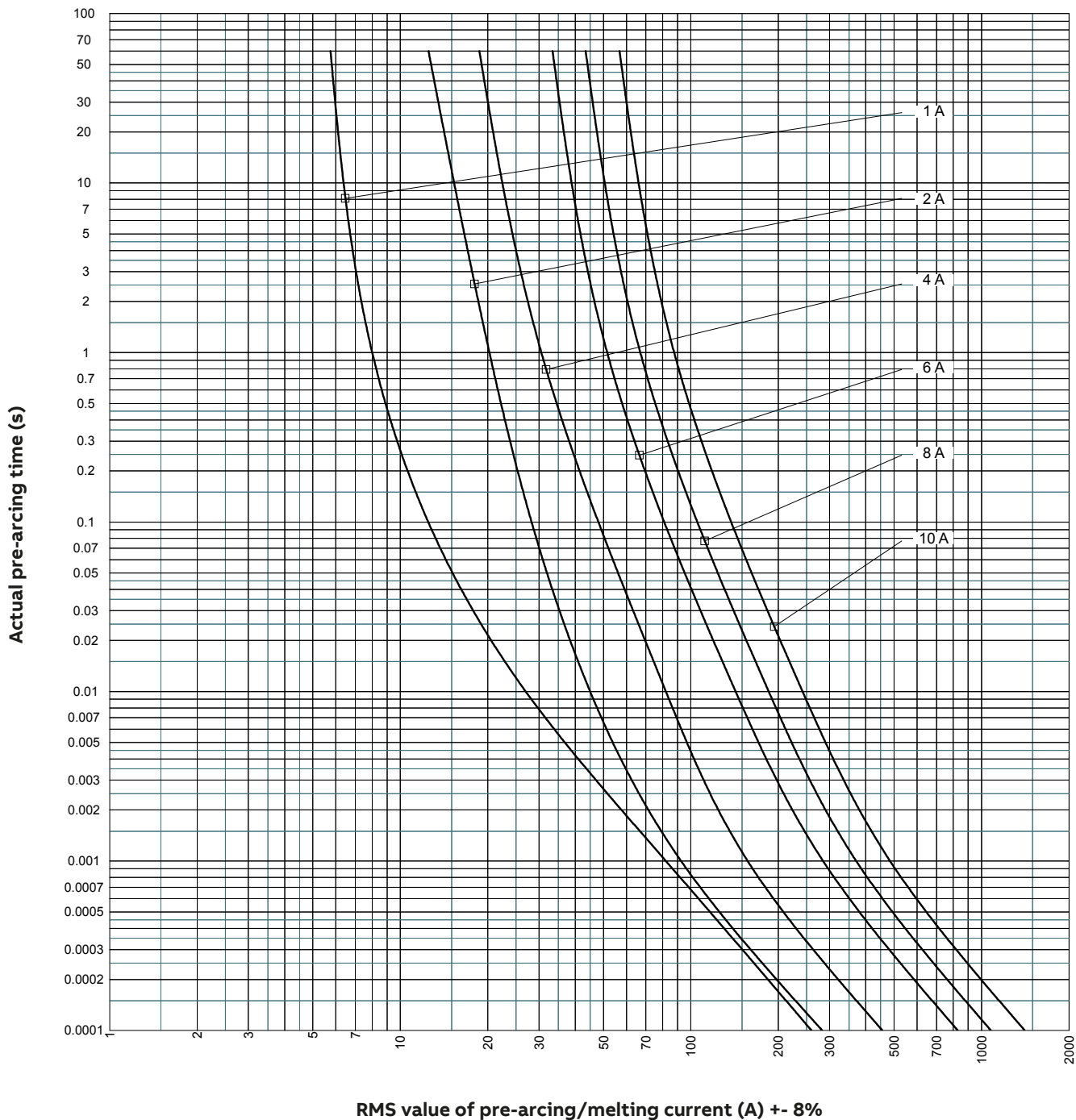

Protection and safety technical details

E9F fuses

Time current characteristic curves

E9F 10 aM

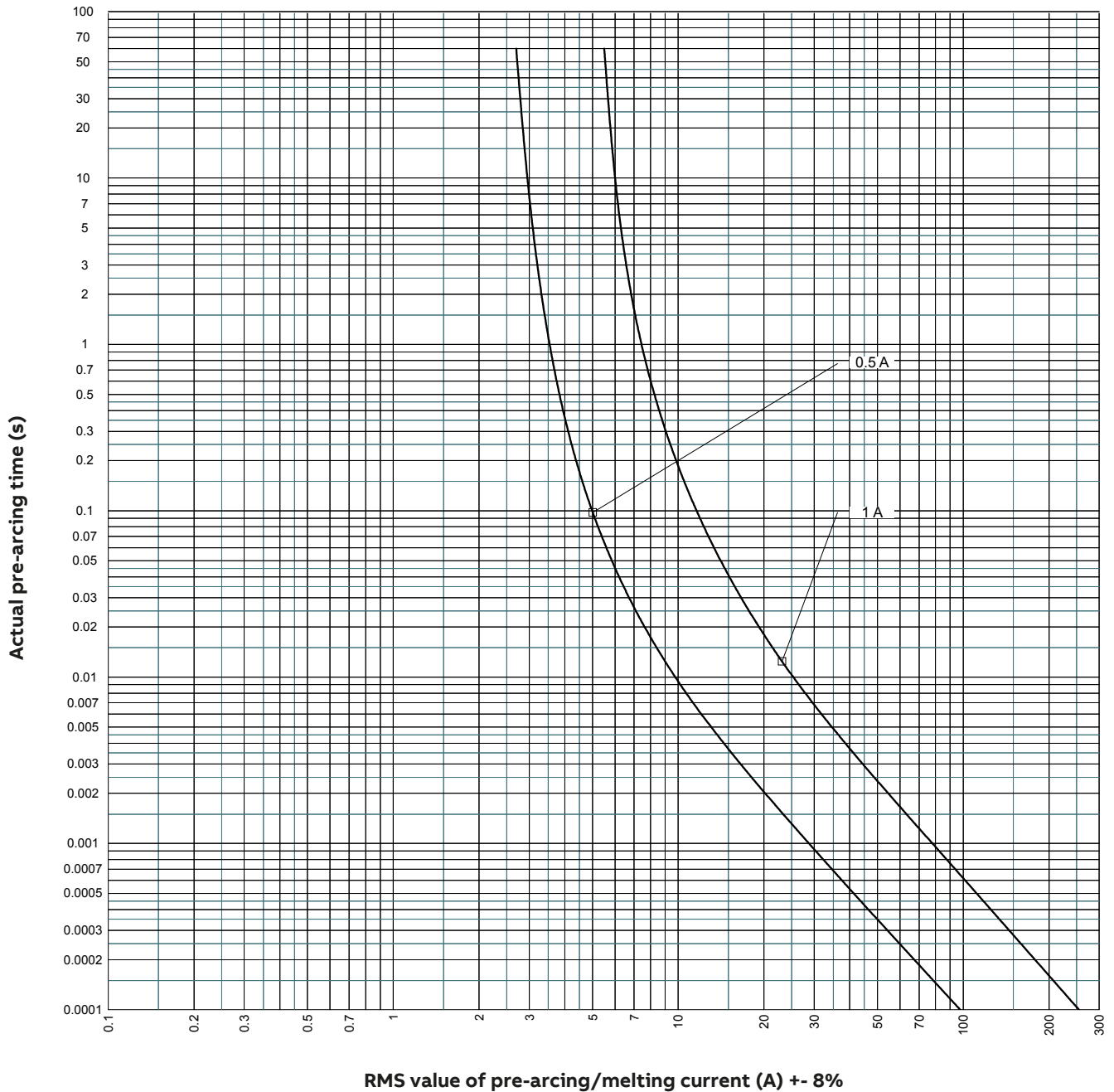

Protection and safety technical details

E9F fuses

Time current characteristic curves

E9F 10 aM

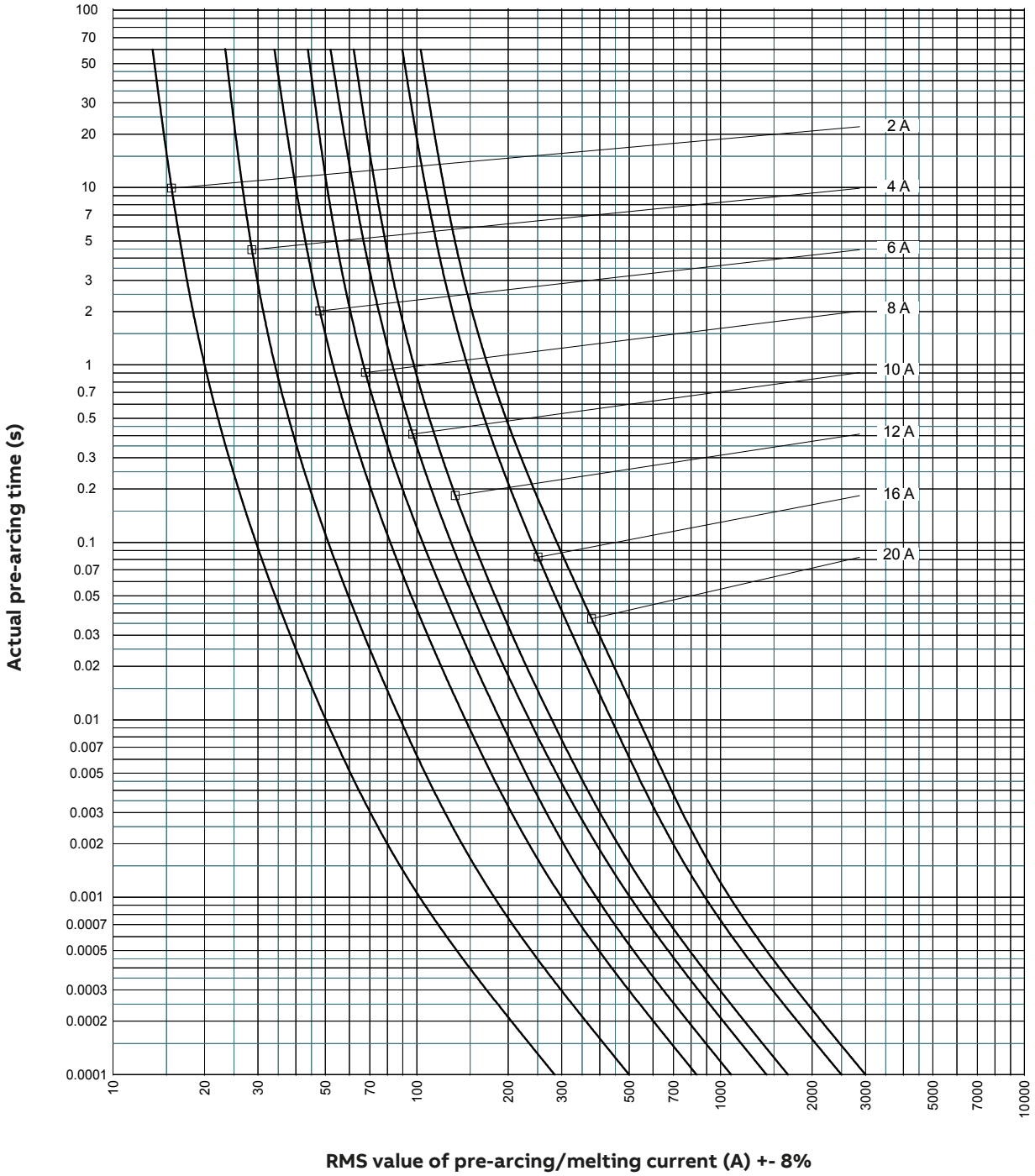

Protection and safety technical details

E9F fuses

Time current characteristic curves

E9F 10 aM

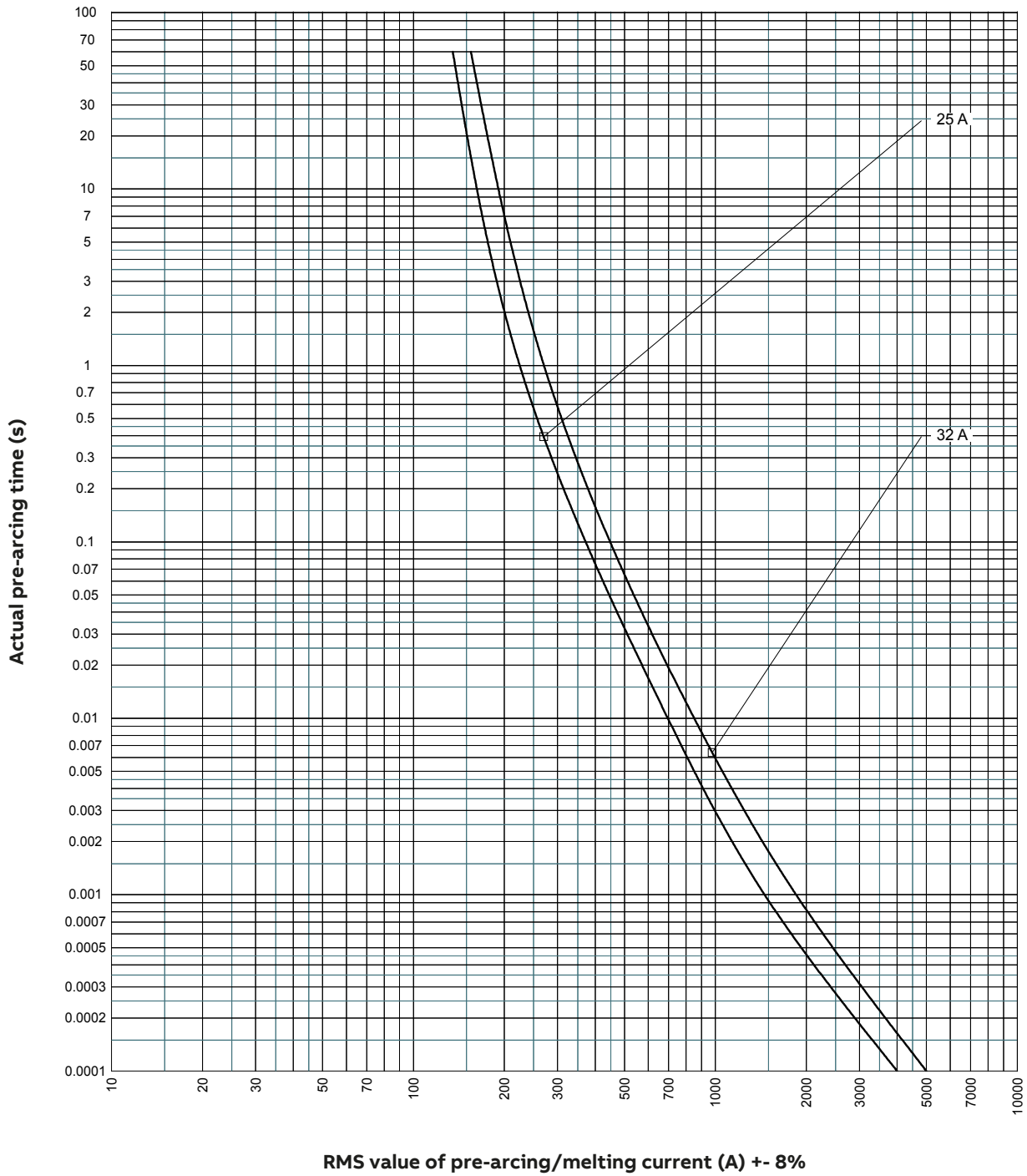

Protection and safety technical details

E9F fuses

Time current characteristic curves

E9F 14 aM

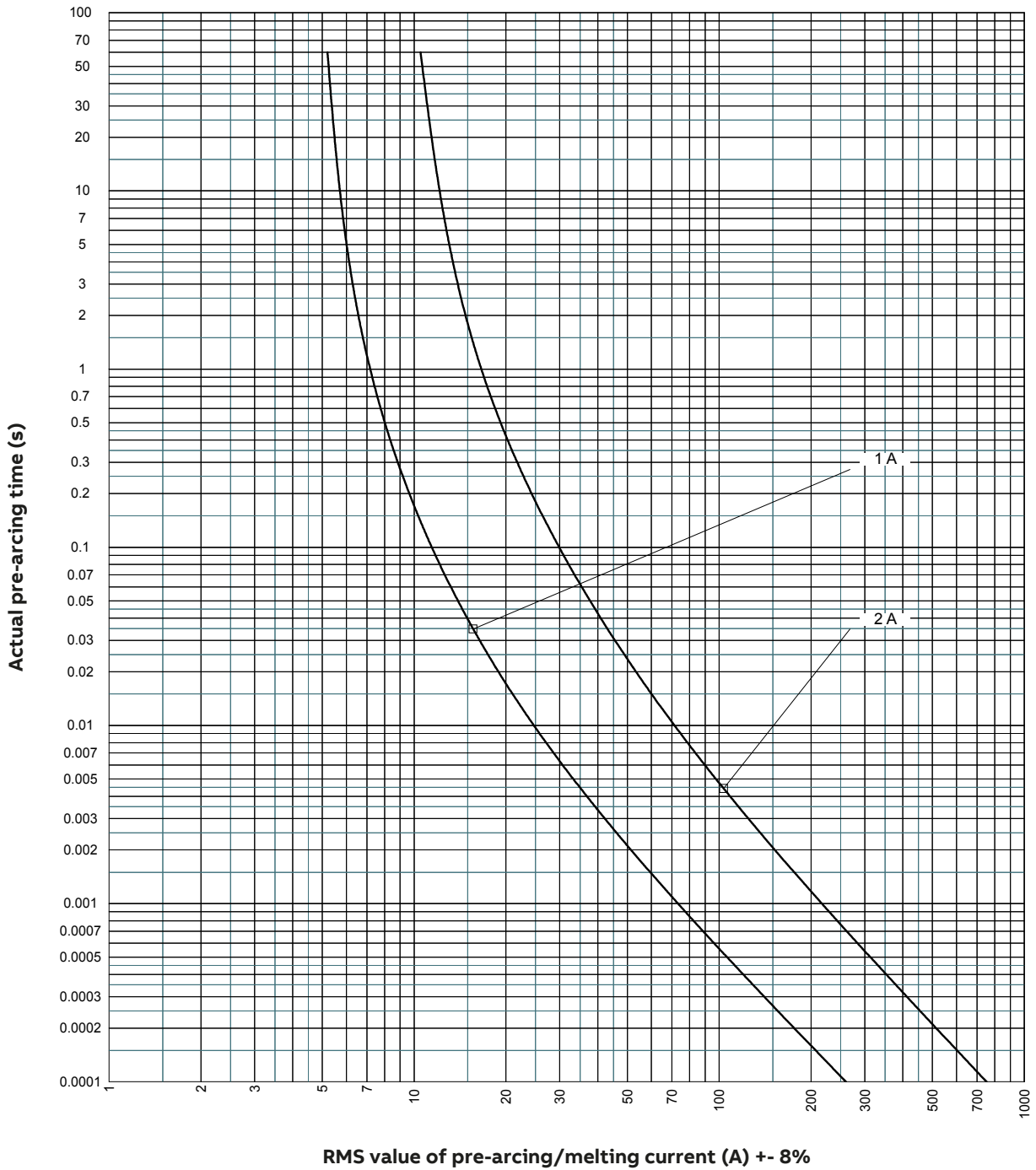

Protection and safety technical details

E9F fuses

Time current characteristic curves

E9F 14 aM

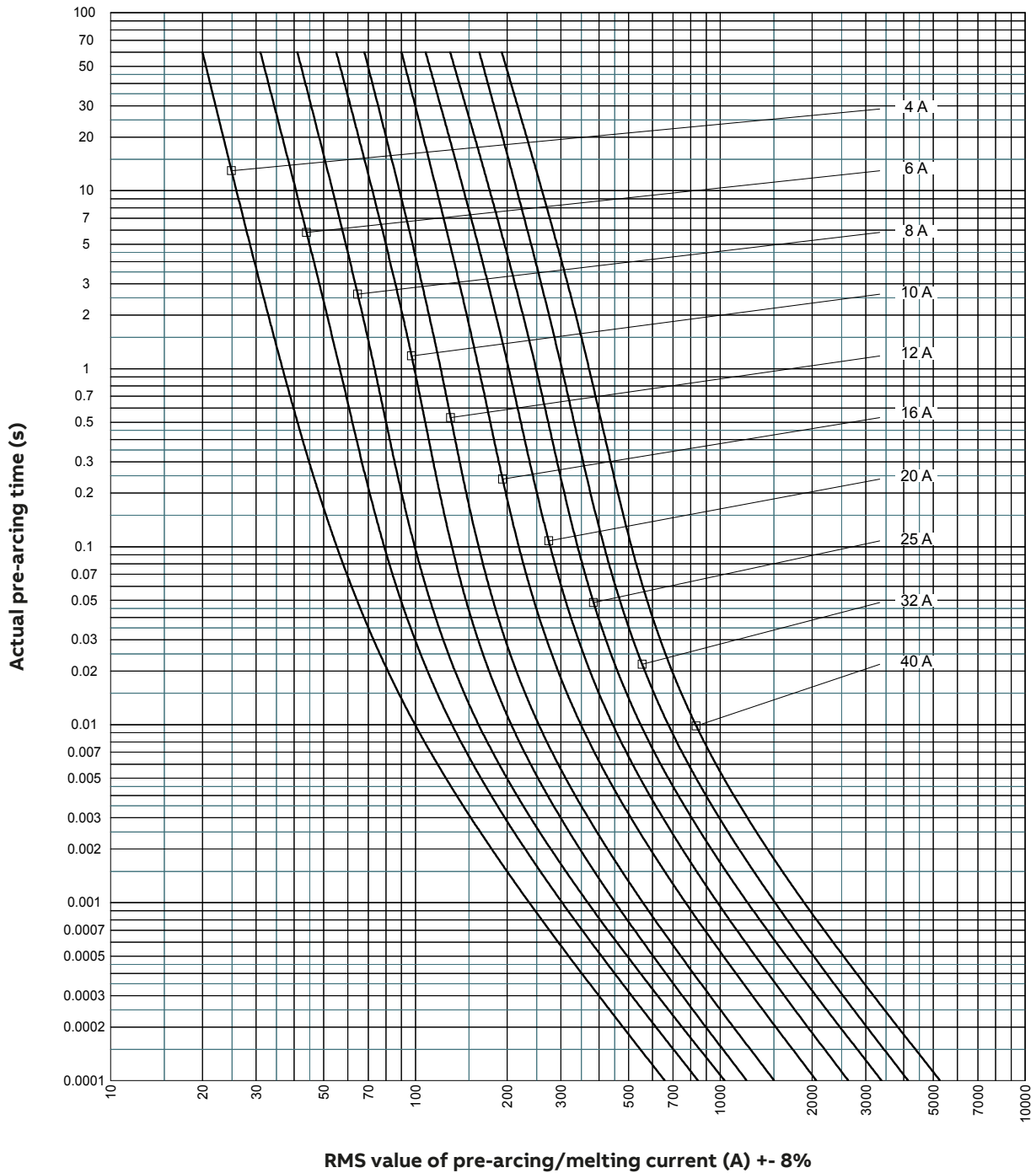

Protection and safety technical details

E9F fuses

Time current characteristic curves

E9F 14 aM

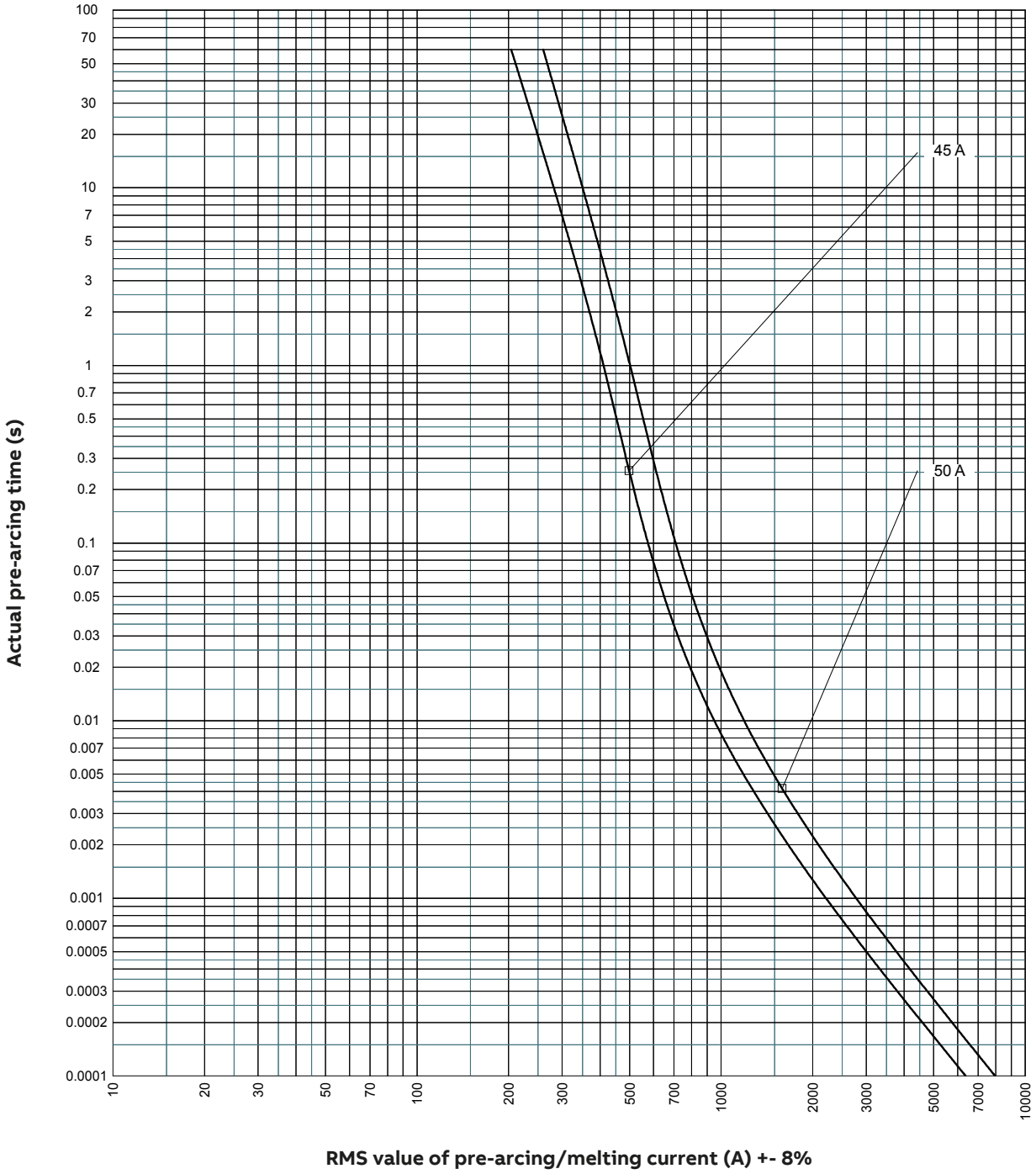

Protection and safety technical details

E9F fuses

Time current characteristic curves

E9F 14 aM

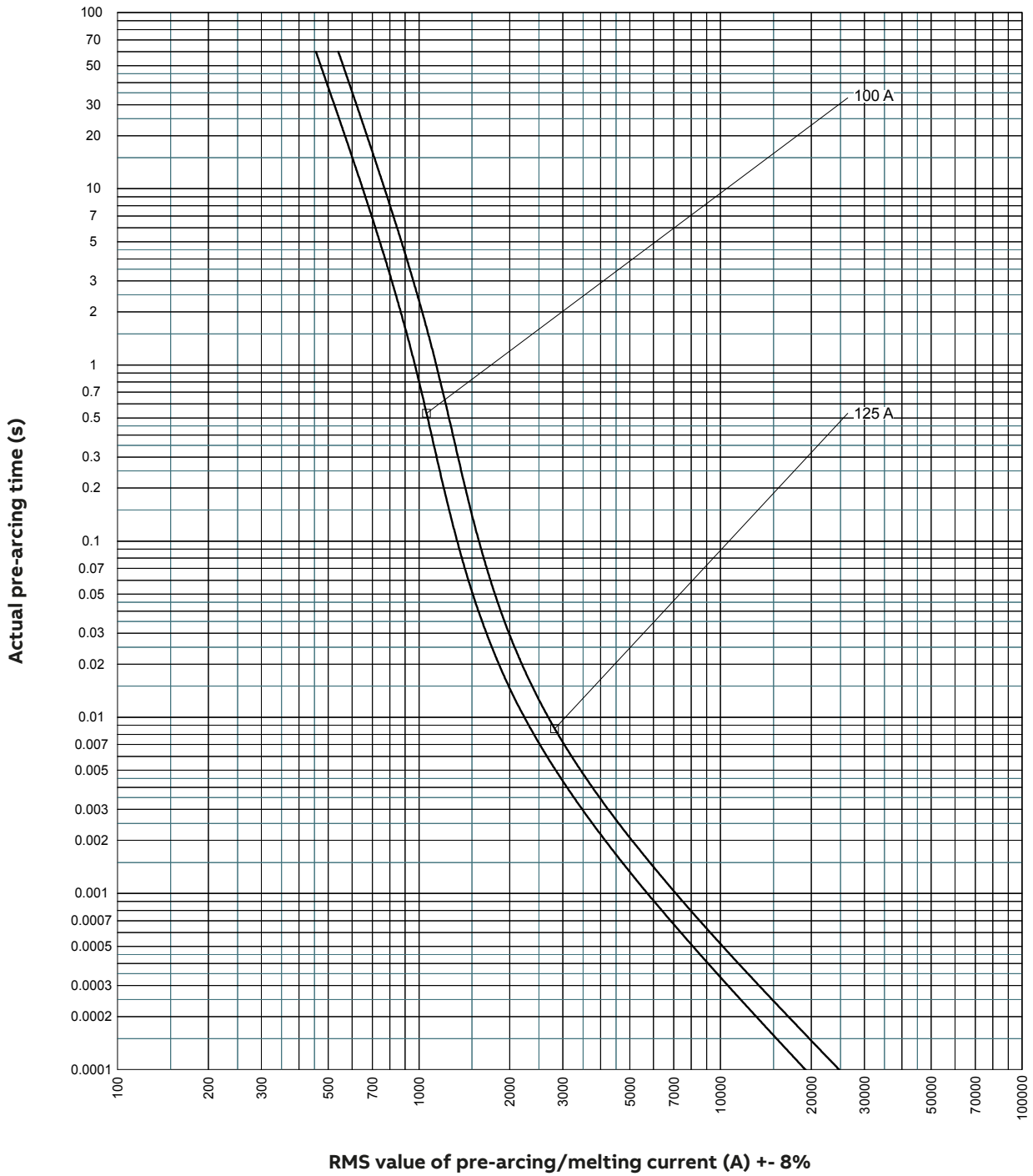

Protection and safety technical details

E9F fuses

Operating I^2t characteristics

E9F 8 aM

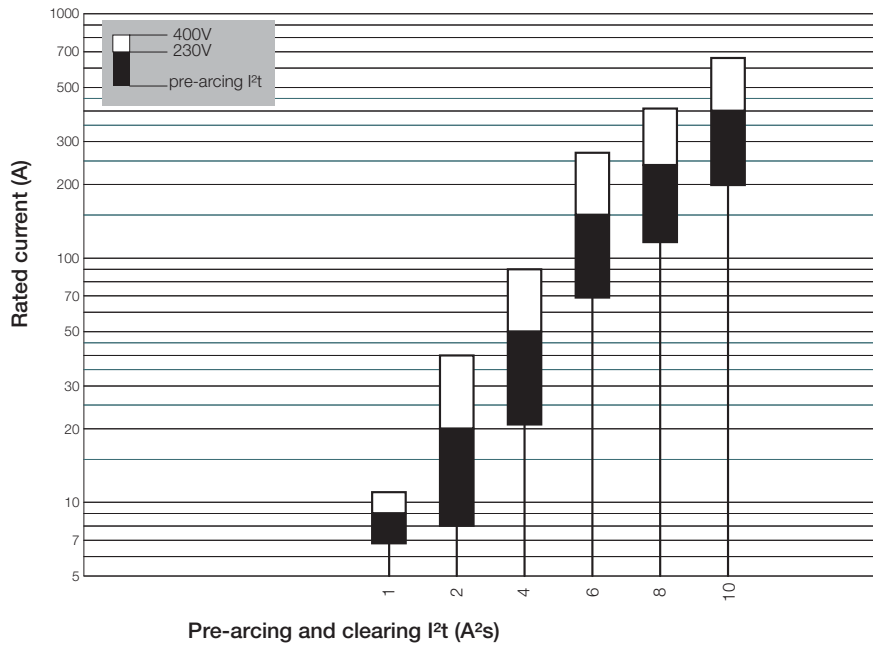

Protection and safety technical details

E9F fuses

Operating I²T characteristics

E9F 10 aM

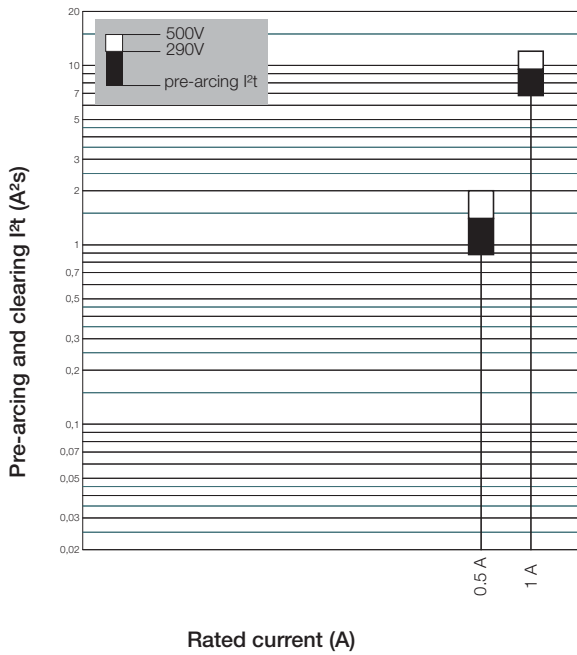

Operating I²T characteristics

E9F 10 aM

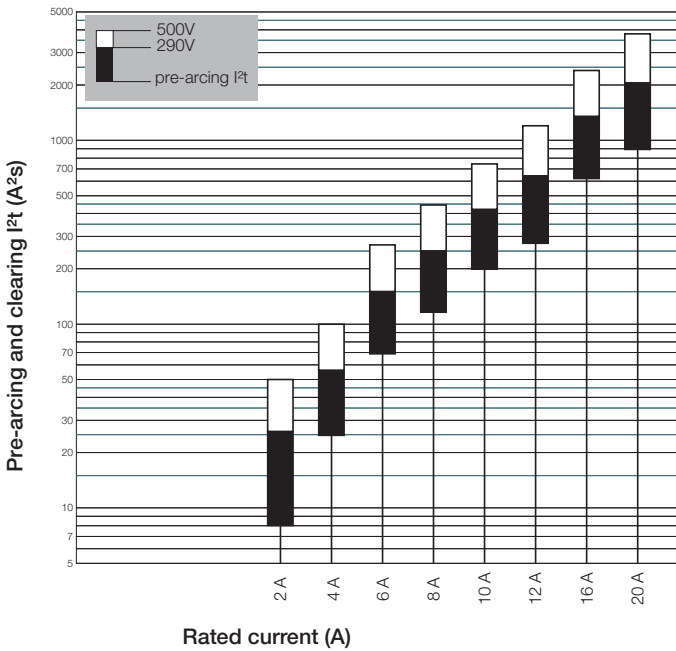

E9F 10 aM

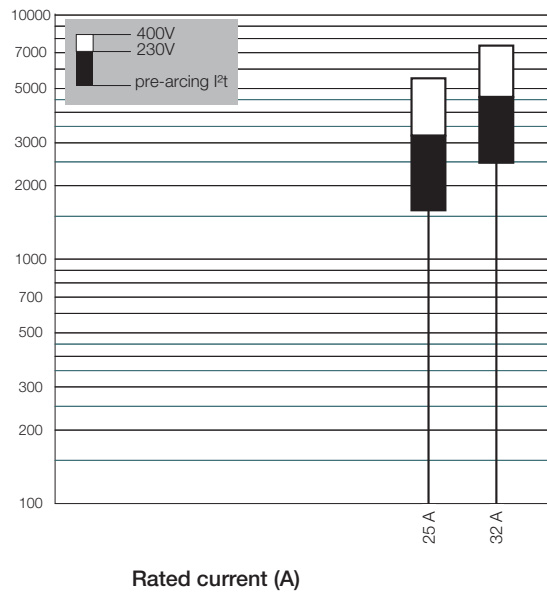

Protection and safety technical details

E9F fuses

Operating I²T characteristics

E9F 14 aM

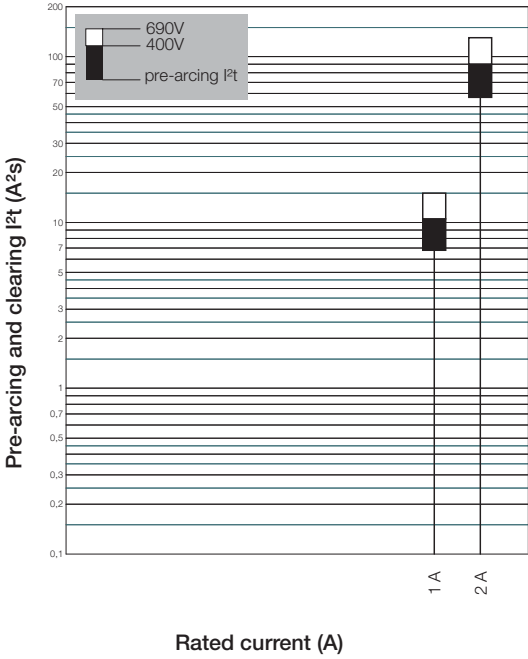

E9F 14 aM

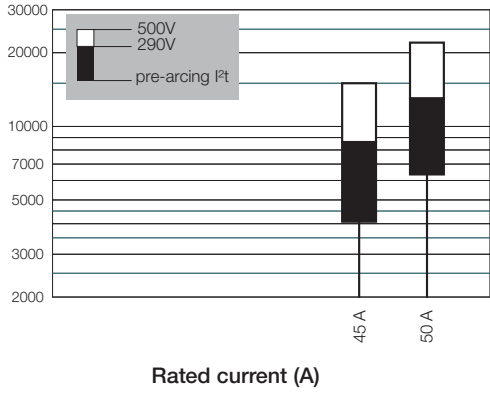

Operating I²T characteristics

E9F 14 aM

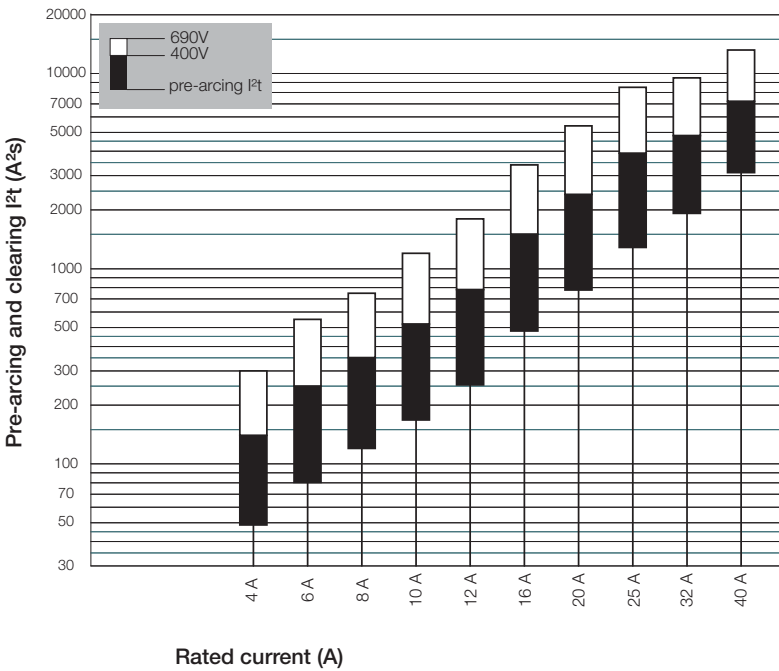

Protection and safety technical details

E9F fuses

Operating I²T characteristics

E9F 22 aM

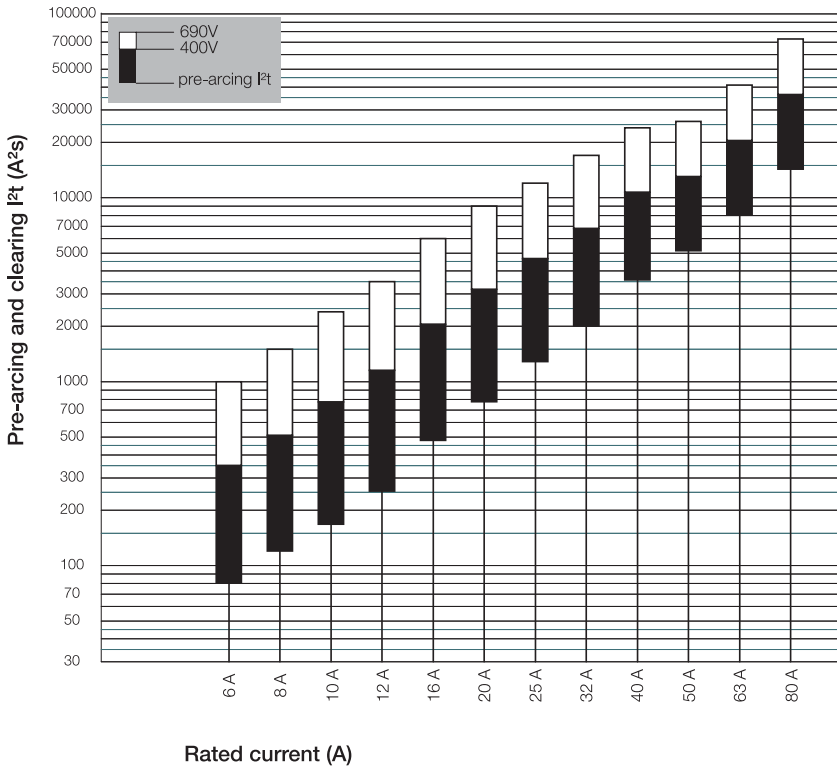

Operating I²T characteristics

E9F 22 aM

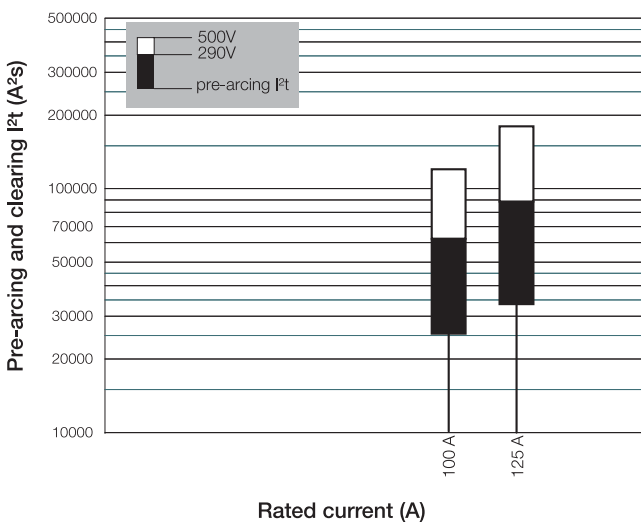

Protection and safety technical details

E9F fuses

Cut-off current characteristic

E9F 8 aM

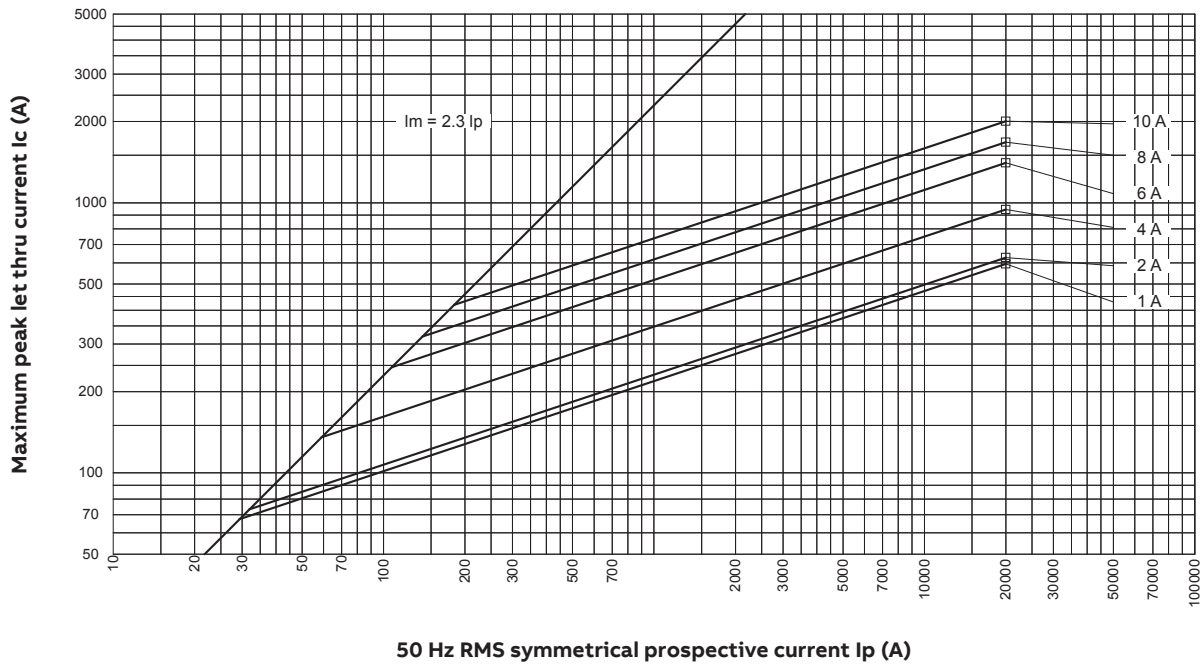

Protection and safety technical details

E9F fuses

Cut-off current characteristic

E9F 10 aM

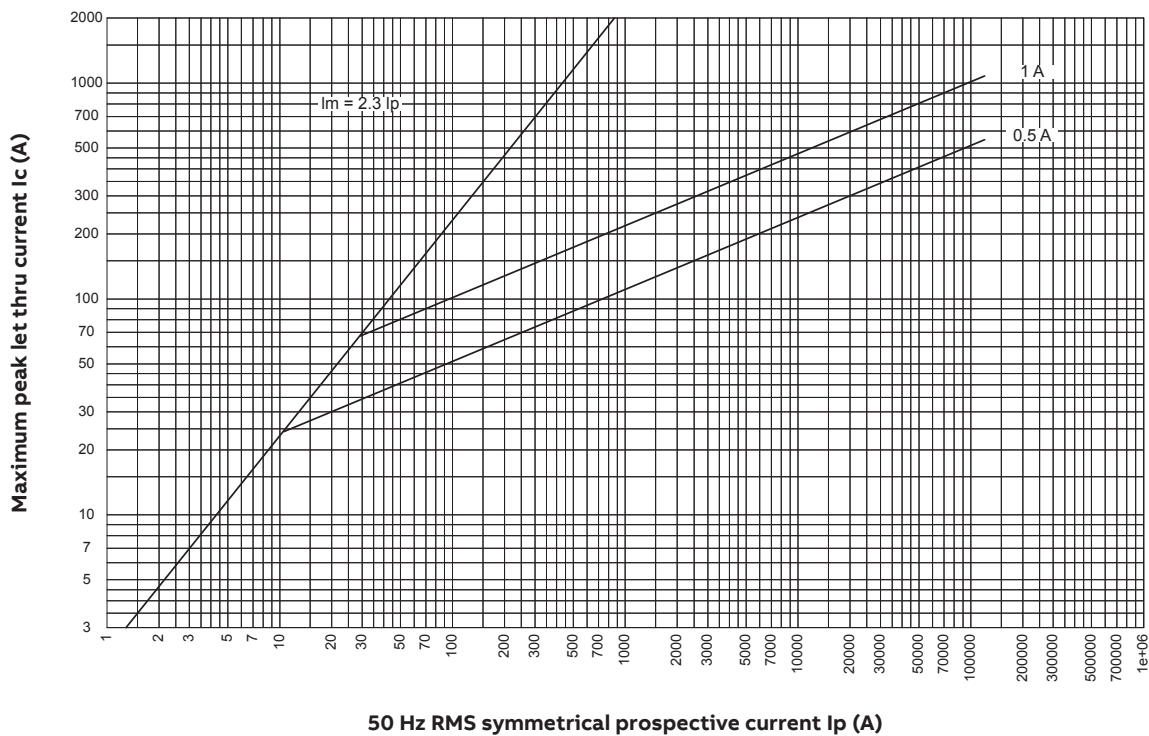

Cut-off current characteristic

E9F 10 aM

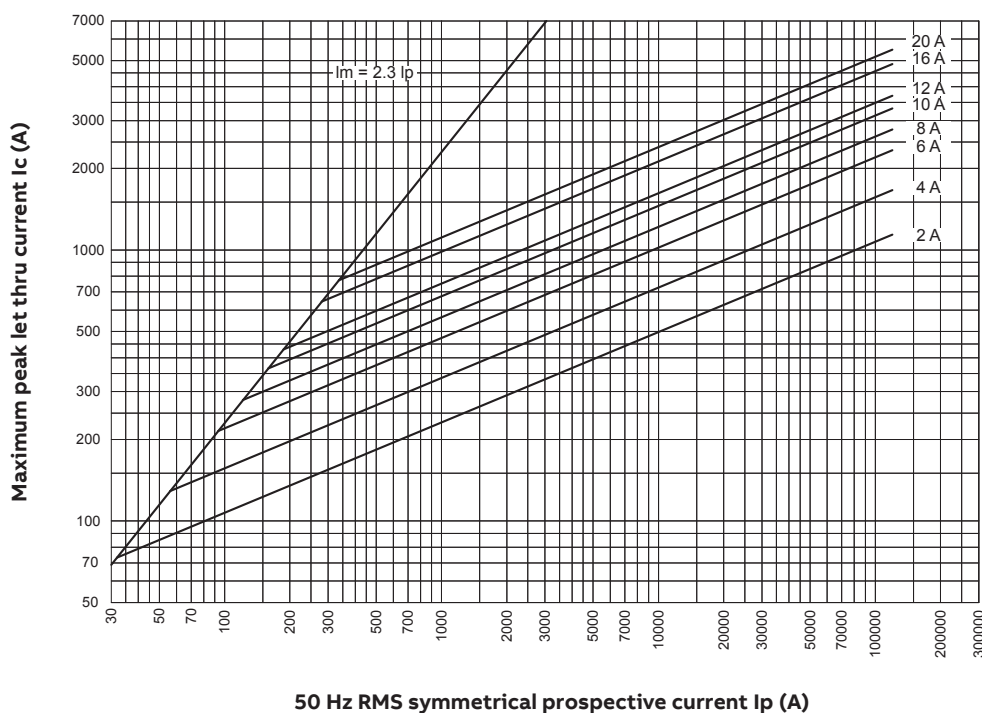

Protection and safety technical details

E9F fuses

Cut-off current characteristic

E9F 10 aM

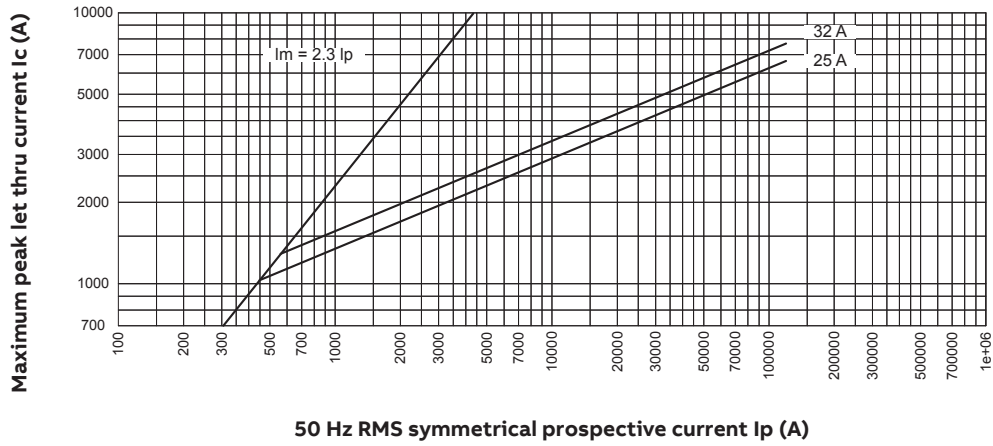

Protection and safety technical details

E9F fuses

Cut-off current characteristic

E9F 14 aM

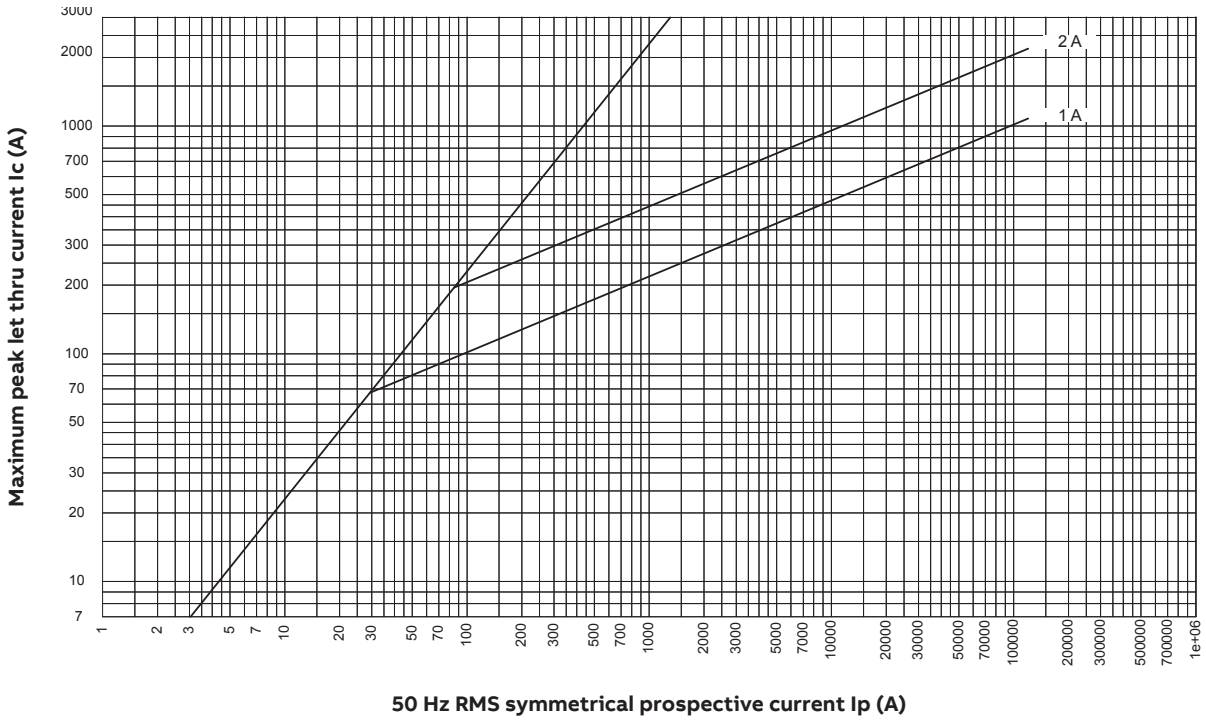

Cut-off current characteristic

E9F 14 aM

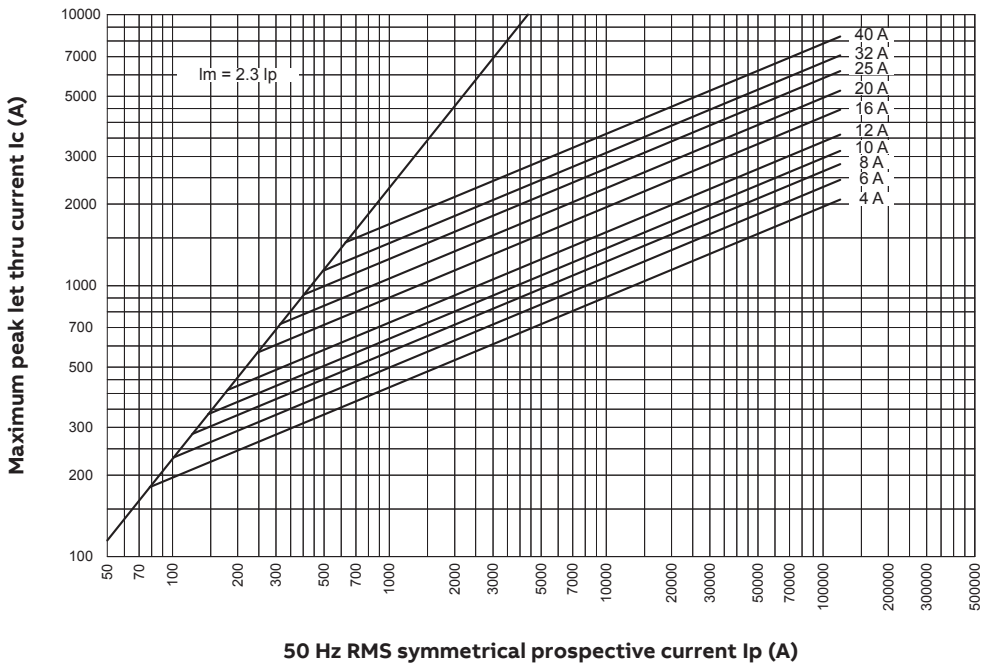

Protection and safety technical details

E9F fuses

Cut-off current characteristic

E9F 14 aM

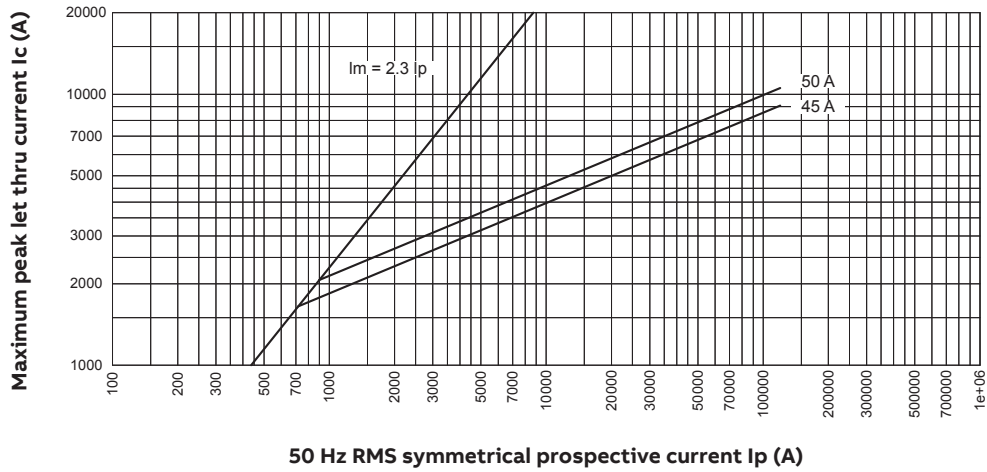

Protection and safety technical details

E9F fuses

Cut-off current characteristic

E9F 22 aM

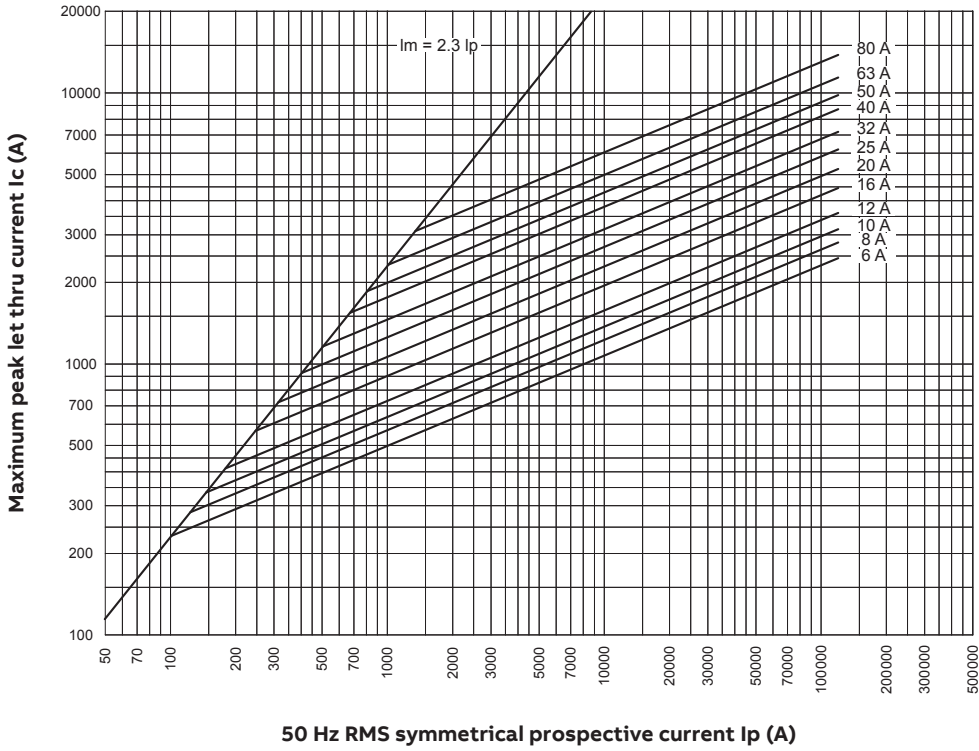

Cut-off current characteristic

E9F 22 aM

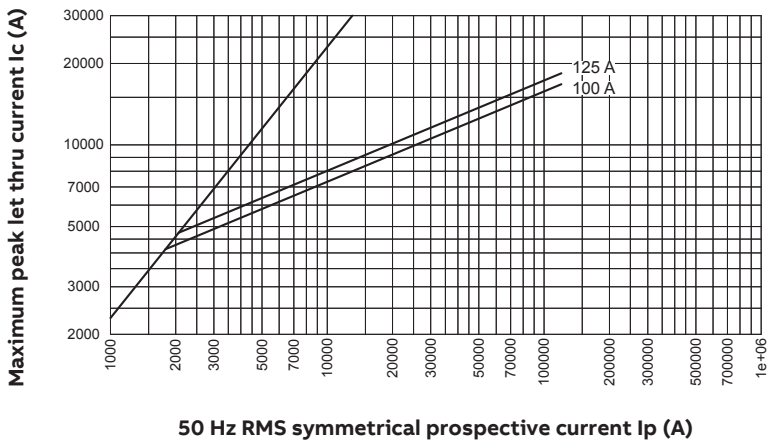

Protection and safety technical details

E9F fuses

E9F gPV 1000 V DC 10.3 x 38 mm cylindrical fuses

Type	Rated current [A]	Dissipated power 0.7 I _n [W]	Dissipated power 0.8 I _n [W]	Dissipated power I _n [W]
E9F1 PV	1	0.125	0.175	0.250
E9F2 PV	2	0.160	0.250	0.320
E9F3 PV	3	0.66	0.87	1.36
E9F4 PV	4	0.69	0.8	1.25
E9F5 PV	5	0.59	0.73	1.12
E9F6 PV	6	0.42	0.67	1.05
E9F7 PV	7	0.40	0.64	1.0
E9F8 PV	8	0.77	0.88	1.48
E9F10 PV	10	0.67	0.90	1.5
E9F12 PV	12	0.72	1.0	1.8
E9F15 PV	15	0.9	1.3	2.2
E9F20 PV	20	1.1	1.5	2.8
E9F25 PV	25	1.3	1.8	3.0
E9F30 PV	30	1.5	1.9	3.7

The power dissipation of the fuse cannot exceed the maximum power dissipation accepted by the fuseholder

Derating in combination with ambient temperature

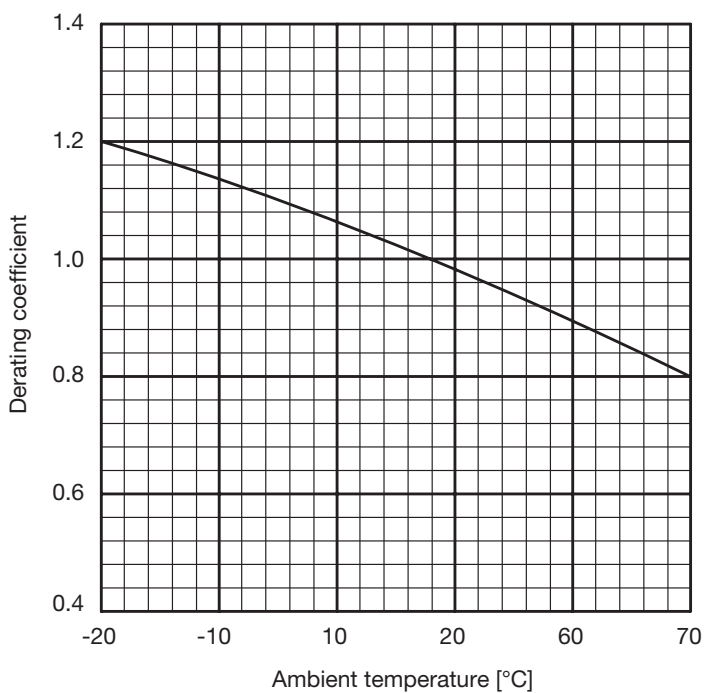

Protection and safety technical details

E9F fuses

Time current characteristic curves

E9F gPV 1000 V DC

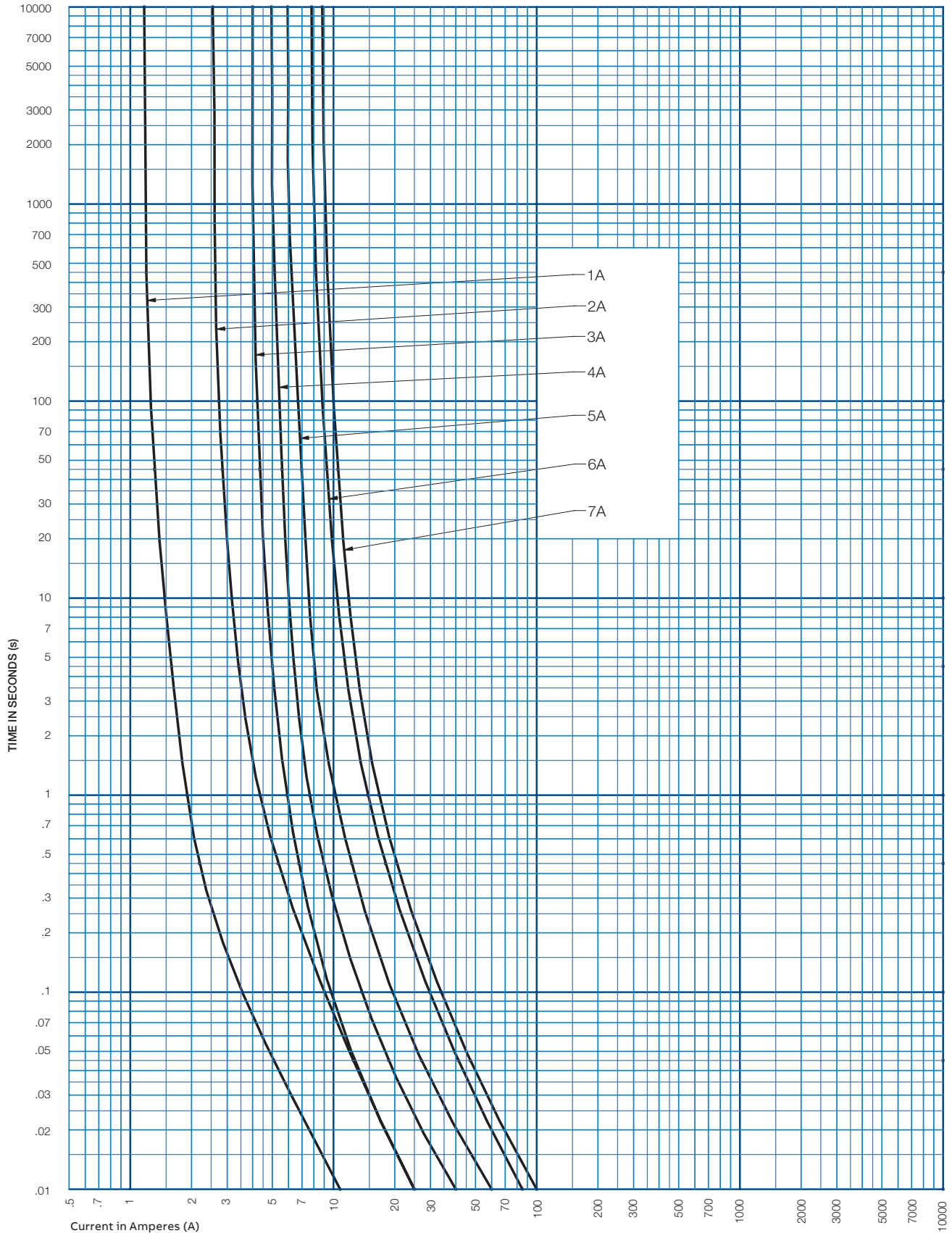

Protection and safety technical details

E9F fuses

E9F gPV 1500 V DC 10 x 85 mm cylindrical fuses

Type	Rated current I_n [A]	Power dissipation at $0.7 \times I_n$ [W]	Power dissipation at $0.8 \times I_n$ [W]	Power dissipation at $1.0 \times I_n$ [W]
E9F4 PV1500	4	0.84	1.16	1.97
E9F5 PV1500	5	0.84	1.16	1.97
E9F6 PV1500	6	0.97	1.37	2.42
E9F7 PV1500	7	0.97	1.37	2.43
E9F8 PV1500	8	1.04	1.50	2.60
E9F10 PV1500	10	1.23	1.77	3.09
E9F12 PV1500	12	1.15	1.70	2.89
E9F15 PV1500	15	1.39	1.91	3.48
E9F20 PV1500	20	1.71	2.47	4.28
E9F25 PV1500	25	2.13	3.08	5.35
E9F30 PV1500	30	2.56	3.61	6.40
E9F32 PV1500	32	2.56	3.61	6.40

Ampere rating vs. Ambient temperature

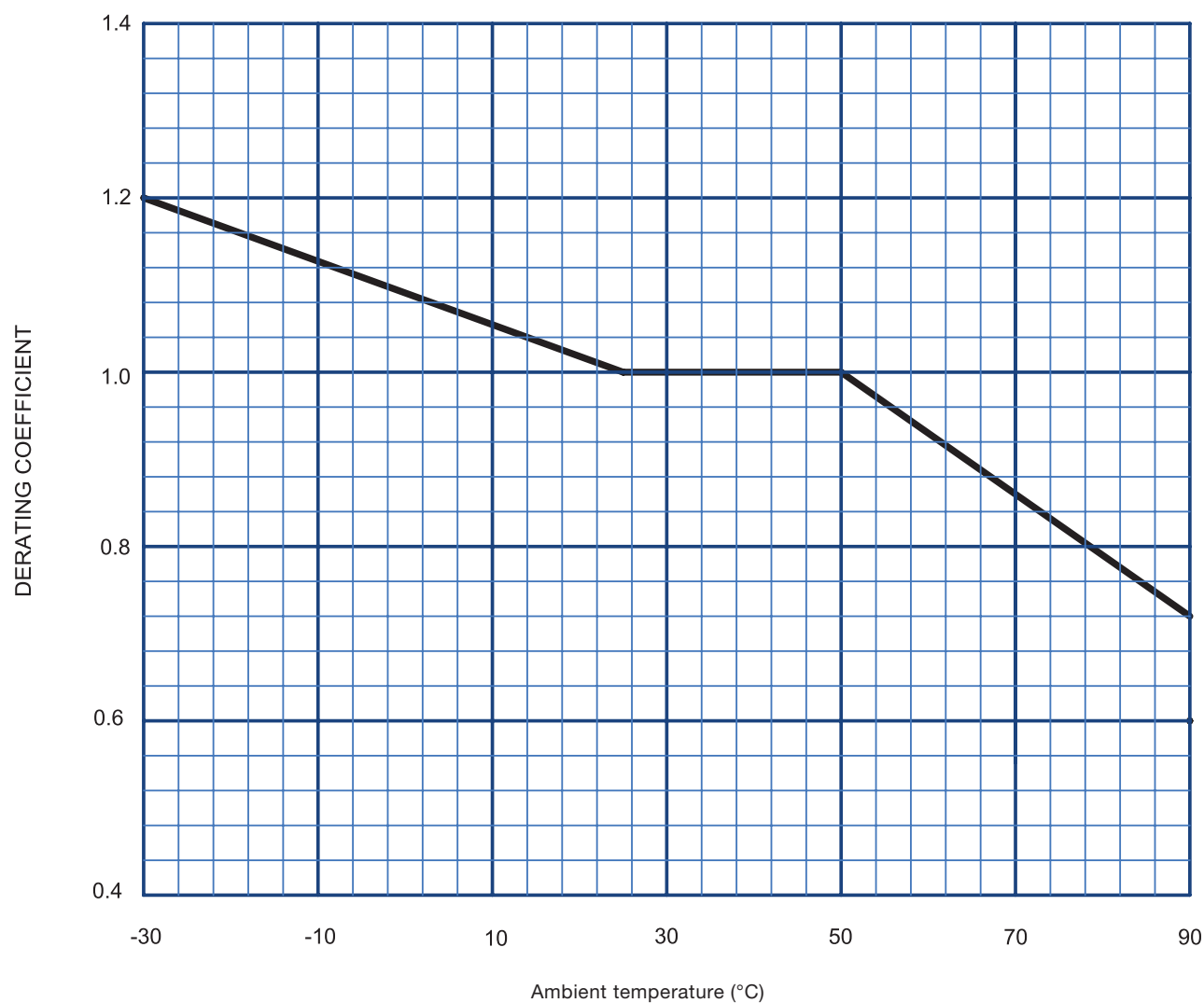

Protection and safety technical details

EPD 24-TB-101

EPD 24

Time/Current characteristic curve (TU = 25 °C)

The trip time is typically 3 s in the range between 1.1 and 1.8 x IN1).

Electronic current limitation occurs at typically 1.8 x IN1) which means that under all overload conditions (independent of the power supply and the resistance of the load circuit) the max. overload before disconnection will not exceed 1.8 x IN1) times the current rating. Trip time is between 100 ms and 3 sec (depending on overload or at short circuit).

Without this current limitation a considerably higher overload current would flow in the event of an overload or short circuit.

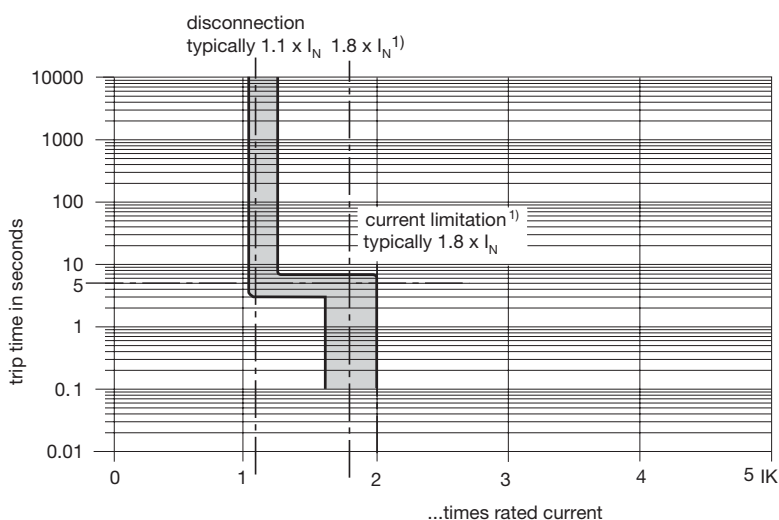

¹⁾ Current limitation typically 1.8 x I_N at I_N = 0.5 A...6 A
 Current limitation typically 1.5 x I_N at I_N = 8 A or 10 A
 Current limitation typically 1.3 x I_N at I_N = 12 A

Maximum cable lengths

EPD24 reliably trips from 0 Ω up to max. circuit resistance R_{max}.

Calculation of R _{max}		
Selected rating I _N (A)	3	6
Operating voltage U _S (V DC) (= 80 % of 24 V) ²⁾	19.2	19.2
Trip current I _{lab} = 1.25 x I _N (A) (EPD24 trips after 3 s)	3.75	7.50
R _{max} (Ω) = (U _B /I _{lab}) - 0.050	5.07	2.51

²⁾ Voltage drop of EPD24 and tolerance of trip point (typically 1.1 x I_N = 1.05 ... 1.35 x I_N) have been taken into account

Protection and safety technical details

EPD 24-TB-101

Selection table for the incoming cable lengths with different cable cross-sections

Cable cross section A (mm ²)	0.14	0.25	0.34	0.5	0.75	1.00	1.50
Cable length L (m) (= single length)	cable resistance (Ω) = (ρ ₀ × 2 × L) / A ³)						
5	1.27	0.71	0.52	0.36	0.24	0.18	0.12
10	2.54	1.42	1.05	0.71	0.47	0.36	0.24
15	3.81	2.14	1.57	1.07	0.71	0.53	0.36
20	5.09	2.85	2.09	1.42	0.95	0.71	0.47
25	6.36	3.56	2.62	1.78	1.19	0.89	0.59
30	7.63	4.27	3.14	2.14	1.42	1.07	0.71
35	8.90	4.98	3.66	2.49	1.66	1.25	0.83
40	10.17	5.70	4.19	2.85	1.90	1.42	0.95
45	11.44	6.41	4.71	3.20	2.14	1.60	1.07
50	12.71	7.12	5.24	3.56	2.37	1.78	1.19
75	19.07	10.68	7.85	5.34	3.56	2.67	1.78
100	25.34	14.24	10.47	7.12	4.75	3.56	2.37
125	31.79	17.80	13.09	8.90	5.93	4.45	2.97
150	38.14	21.36	15.71	10.68	7.12	5.34	3.56
175	44.50	24.92	18.32	12.46	8.31	6.23	4.15
200	50.86	28.48	20.94	14.24	9.49	7.12	4.75
225	57.21	32.04	23.56	16.02	10.68	8.01	5.34
250	63.57	35.60	26.18	17.80	11.87	8.90	5.93

3) Resistivity of copper r₀ = 0.0178 (Ω x mm²)/m

Example 1: max. length for 1.5 mm² and 3 A: 214 m

Example 2: max. length for 1.5 mm² and 6 A: 106 m

Example 3: mixed wiring: (Control cabinet --- sensor/actuator level)

R1 = 40 m for 1.5 mm² and R2 = 5 m for 0.25 mm²:

R1 = 0.95 Ω, R2 = 0.71 Ω, total (R1 + R2) = 1.66 Ω

Please note

The user should ensure that the cable cross sections of the relevant load circuit are suitable for the current rating of the EPD24 used.

Automatic start-up of machinery after shut down must be prevented (Machinery Directive 98/37/EG and EN 60204-1).

In the event of a short circuit or overload the load circuit will be disconnected electronically by the EPD24.

Protection and safety technical details

EPD 24-TB-101

Information on UL approvals/CSA approvals



Operating Temperature Code T5

- This equipment is suitable for use in Class I, Division 2, Groups A, B, C and D or non-hazardous locations only

WARNING:

- Exposure to some chemicals may degrade the sealing properties of materials used in the following device: relay

Sealant Material:

Generic Name: Modified diglycidyl ether of bisphenol A

Supplier: Fine Polymers Corporation

Type: Epi Fine 4616L-160PK

Casing Material:

Generic Name: Liquid Crystal Polymer

Supplier: Sumitomo Chemical

Type: E4008, E4009, or E6008

RECOMMENDATION:

- Periodically inspect the device named above for any degradation of properties and replace if degradation is found

WARNING – EXPLOSION HAZARD:

- Do not disconnect equipment unless power has been removed or the area is known to be non-hazardous
- Substitution of any components may impair suitability for Class I, Division 2

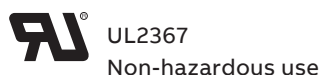

UL2367
Non-hazardous use

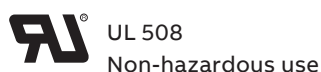

UL 508
Non-hazardous use



CSA C22.2 No. 213 (Class I, Division 2)
CSA C22.2 No. 142

Class 2

Meets requirement for Class 2 current limitation
(EPD24 ... -0,5 A/1 A/2 A/3 A)

Protection and safety technical details

EPD 24-TB-101

The EPD24 features an integral power distribution system.

The following wiring modes are possible with various pluggable current and signal busbars:

- LINE+ (24 V DC)
- 0 V

Caution: The electronic devices EPD24 require a 0 V connection

- Auxiliary contacts

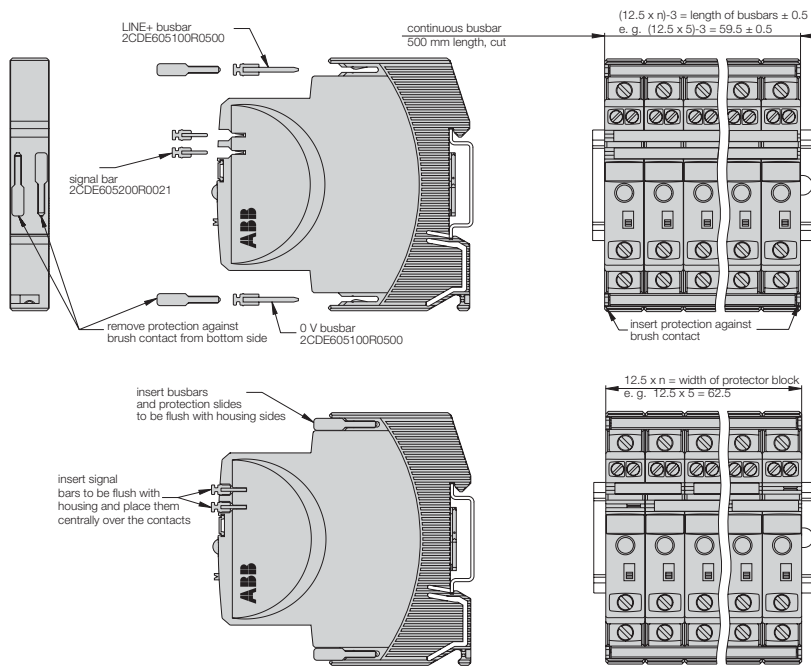

Mounting procedure

Before wiring insert busbars into protector block. A maximum of 10 connection cycles are permissible using connecting busbars.

Recommendation

After 10 units the busbars should be interrupted and receive a new entry live.

Table of length for busbars

(Order code 2CDE605100R0500)

No. of units	2	3	4	5	6	7	8	9	10
Length of busbar (mm) ± 0.5 mm	22	34.5	47	59.5	72	84.5	97	109.5	122

Protection and safety technical details

SQZ3 phase and sequence relays

Operating principle

Through an output relay with contact in safety switching, the SQZ3 phase and sequence presence devices for 400 V a.c. three-phase networks enable the phase and sequence presence management monitoring also the minimum voltage (adjustable up to 70% of V_n). In case of any defect, the device operates within a range from 2 to 20 seconds, with the opportunity to control the appropriate acoustic signals, motor controlling contactors or circuit breakers.

Application environments

The installation of the SQZ3 phase and sequence presence relays are particularly suitable for any environment and situation where it is necessary to control the three-phase network operation promptly signalling any defect.

Example of installation

As shown in the diagrams, one of the possible applications is the installation of the SQZ3 phase and sequence presence relays in a department store, where the escalator supply circuit has a phase variation determining the SQZ3 relay intervention on the ESB contactor and causing the motor block and the alarm lighting indication.

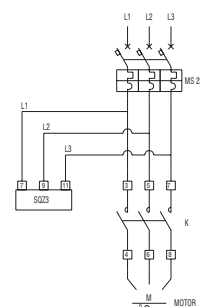
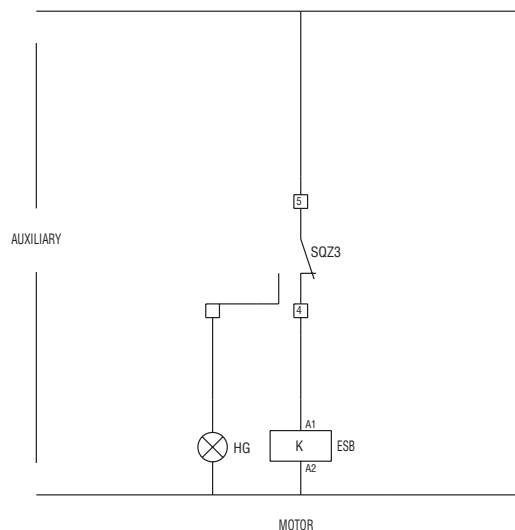
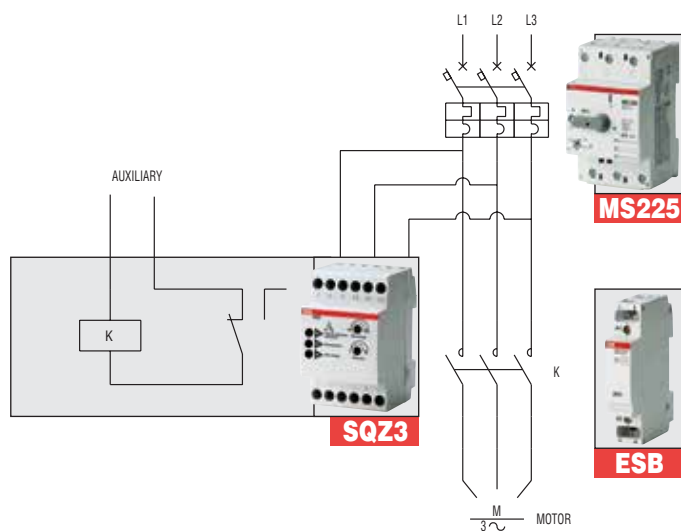
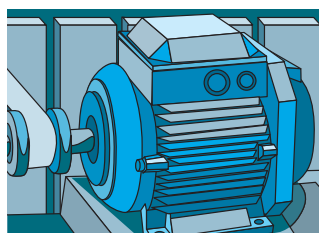
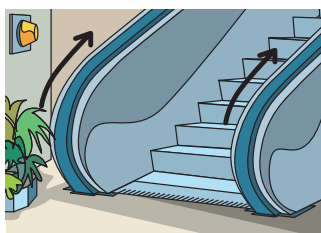

Protection and safety technical details

E 236 undervoltage monitoring relays

Function

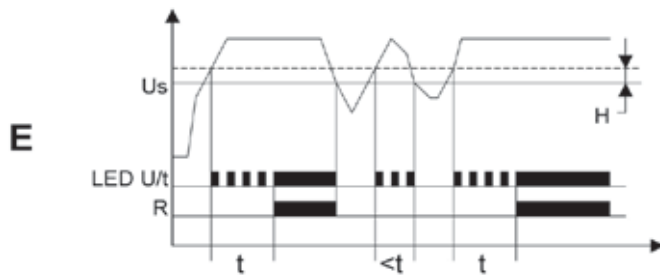

Function E236-US 1.1D

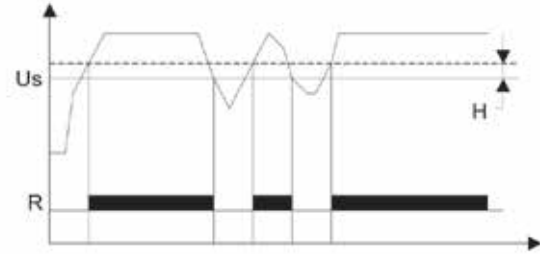

Function E236-US 1.1, E 236-US 2.1, E 236-US 1
and E 236-US 2

Protection and safety technical details

Insulation monitoring devices

ISOLTESTER-DIG

ISOLTESTER-DIG is the insulation monitoring device specifically designed by ABB for group 2 medical locations. ISOLTESTER-DIG measures the insulation to earth in IT-M network and the thermal and electrical overload of the insulation transformer, in accordance with the international standards: EN 61557-1, EN 61557-8 and IEC 60364-7-710.

Functioning principle

Insulation resistance is measured by applying a direct current signal between insulated line and earth and determining the dispersion current generated. Effective measurement is granted thanks to a digital filter integrated in the device even if interferences and harmonic components occur.

Programming

Through its LCD display and four selection keys, the device offers easy programming possibilities by setting intervention thresholds without making any for the complete monitoring of all electrical parameters. ISOLTESTER-DIG tests the thermal and electrical overload of the medical insulation transformer, managing two temperature thresholds coming from both PT100 and PTC probes. By controlling temperature, the overload of the transformer can be monitored and the automatic circuit-breaker downstream of the secondary can be avoided. All faulty conditions are remotely controlled thanks to QSD-DIG 230/24 remote signalling panels, granting a proper prompt technical supervision.

Self-testing system

Error-Link Fail system checks device proper functioning and controls wiring presence and properness at the end of the terminal blocks: it prevents the possibility to operate in group 2 medical locations when the insulation monitoring device is disconnected.

For better integration and improved monitoring

Thanks to the RS485 serial port, the ISOLTESTER-DIG-RS is able to communicate with the supervision system via ModbusRTU in order to collect all the required information of the monitored IT-M system in a centralized place. It also improves the monitoring activity with the possibility of logging measurements (max. and min. values). Logs can then be sent to the centralized control system via the communication protocol.

For higher safety

Thanks to a codified signal, the new ISOLTESTER-DIG-PLUS IT networks insulation monitoring device grants absolute reliability of measurement in any operational condition, even if high network interferences occur. Furthermore it is fitted with a RS485 serial port through which it can be perfectly integrated with communication systems such as PLC/PC by using ModbusRTU protocol. The measurement of network maximum and minimum values enables a wider monitoring and an easier plant checking in case of any fault. Finally, the programmable output relay allows to manage any warning condition signalled in a dedicated way.

- **Quality:** the recognized standard in hospital insulation control
- **Flexibility:** adjustable intervention thresholds according to all the parameters monitored
- **Completeness:** all electrical and thermal parameters controlled by a single device
- **Integration:** alarms sent up to 4 medical locations attended by medical and healthy staff, thanks to remote signalling panels. Only for RS and PLUS versions, ability to interact with supervising systems through ModbusRTU protocol via RS485 serial port

Protection and safety technical details

Insulation monitoring devices

ISOLTESTER-DIG

Frontal operators functioning

Green LED, SET:

Tool programming status

Yellow LED, Alarm:

Parameter out of threshold

3 digit display

Red LED, Output Relay:

Auxiliary relay status

Red LED, R:

Insulation resistance (kΩ)

Red LED, Error/Link Fail:

Internal fault alarm, faulty wiring to the line to be controlled, PT100 temperature probe open or under short-circuit

Red LED, Z:

Insulation impedance and line capacity (only for ISOLTESTER-DIG-PLUS)

TEST | ENTER:

Device and remote signalling panels testing and SETUP settings confirmation

Red LED, T1:

Primary winding temperature control

RESET | SET:

Device programming access, alarm disconnection and memorized values cancellation

Red LED, T2:

Secondary winding temperature control

Red LED, I:

Line current

+/-:

Selection of the parameter to be displayed, settings adjustment and memorized maximum and minimum values display (only for ISOLTESTER-DIG-PLUS/RS)

Easy programming by four pushbuttons

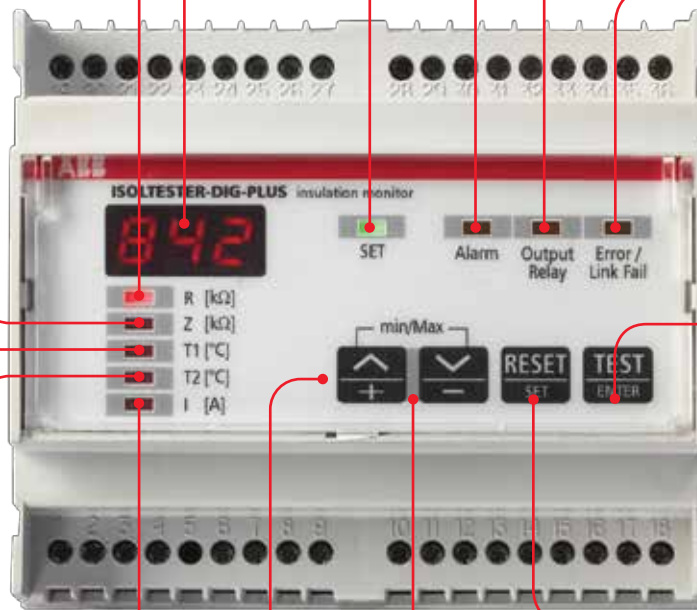

Protection and safety technical details

Insulation monitoring devices
ISOLTESTER-DIG-PLUS

Wherever it is necessary to guarantee safety and operational continuity and prevent power supply interruptions, such as in hospitals and in other medical locations, insulation transformers and devices detecting and signalling any first fault to earth have to be used.



Operating theaters equipment can generate interference within the network



A traditional monitoring device can generate an unwanted alarm in operating theaters

Risks arising from the use of a traditional insulation monitor:

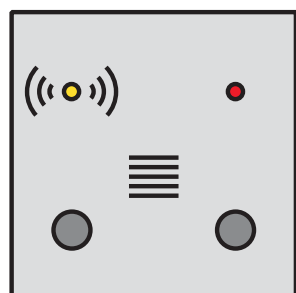

Impossibility to distinguish between interference and real fault

Carelessness of the medical staff

Unjustified intervention of specialized technical staff

ISOLTESTER-DIG-PLUS is the device for insulation monitoring in IT-M networks. It ensures absolute reliability of measurement by means of a codified signal able to detect interferences generated by common equipment in operating theatres and avoid unwanted alarms signalling.



Despite network interferences...



ISOLTESTER-DIG-PLUS avoids unwanted alarms.

Advantages of ISOLTESTER-DIG-PLUS:



Monitoring reliability

Integration with supervision systems

Proper fault analysis

Complete control of network parameters

Protection and safety technical details

Insulation monitoring devices

QSD-DIG 230/24

TEST
Pushbutton

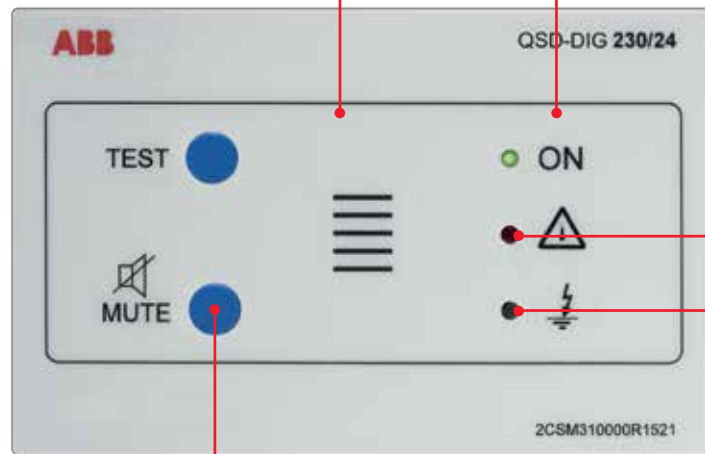

Green LED
device is working properly

Red LED
overload alarm

MUTE
Pushbutton

Yellow LED
fault alarm

Protection and safety technical details

TI insulating transformers for medical locations

Wirings and serial number location

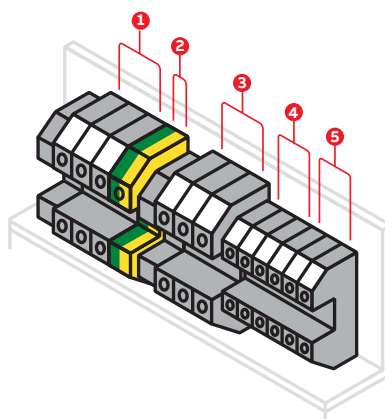

- 1 Primary winding**
0-230: Primary
SCH: Metallic shield
- 2 PE**
- 3 Secondary winding**
0-230: Secondary
SCH: Central socket
- 4 Probe 1**
1: to ISOLTESTER-DIG 28 terminal block
2: to ISOLTESTER-DIG 28 terminal block
3: to ISOLTESTER-DIG 30 terminal block
- 5 Probe 2**
4: to ISOLTESTER-DIG 25 terminal block
5: to ISOLTESTER-DIG 25 terminal block
6: to ISOLTESTER-DIG 27 terminal block



Serial number
printed on the label attached at the metallic base, to be provided when requesting testing certificate

Protection and safety technical details

QSO switchboard for medical locations

Operating diagrams

QSO S

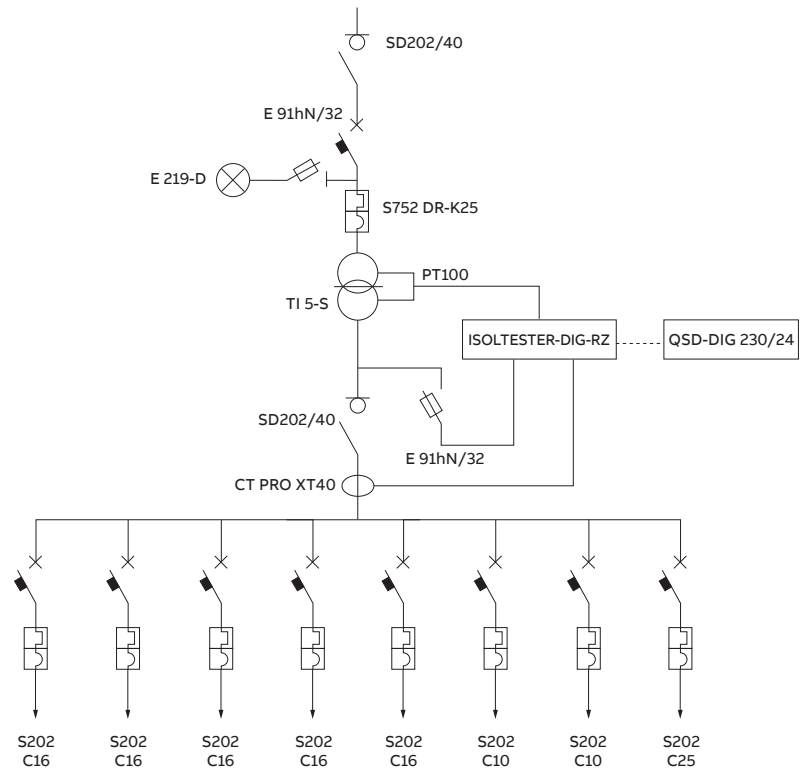
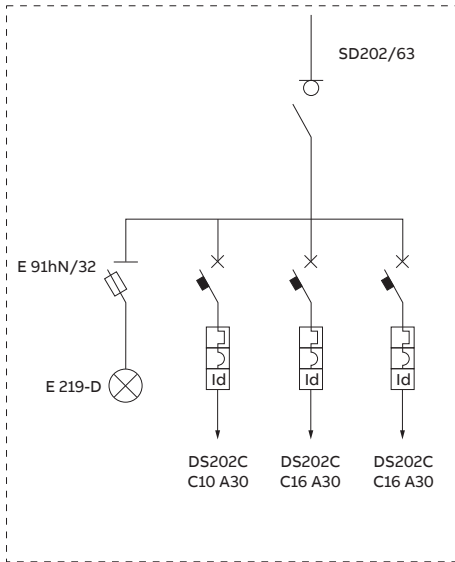

Devices within dashed areas are provided only with "Premium" version.

Description	QSO 3S Classic	QSO 5S Classic	QSO 3S Premium	QSO 5S Premium
2P 40 A SD202/40 disconnector	2	2	2	2
2P 63 A SD202/63 disconnector			1	1
E 91hN/32 fuse-holder	2	2	3	3
E219-D green light indicator power supply presence	1	1	2	2
ISOLTESTER-DIG-RZ insulation monitoring device	1	1	1	1
6 kA 2P C10 S202 miniature circuit-breaker	2	2	2	2
6 kA 2P C16 S202 miniature circuit-breaker	5	5	5	5
6 kA 2P C25 S202 miniature circuit-breaker	1	1	1	1
25 kA 2P S752 DR-K25 miniature circuit-breaker	1	1	1	1
1N 10 A 0,03 A DS202 C C10 A30 residual current breaker with overcurrent protection			1	1
1N 16 A 0,03 A DS202 C C16 A30 residual current breaker with overcurrent protection			2	2
AMM damper set	4	4	4	4
CT PRO XT40 current transformer	1	1	1	1
Medical insulation transformer with 3000 VA 230/230 V TI 3-S probes	1		1	
Medical insulation transformer with 5000 VA 230/230 V TI 5-S probes				1
10 x 38 gG 2A E9F10 GG2 fuse	4	4	6	6

Protection and safety technical details

QSO switchboard for medical locations

QSO M

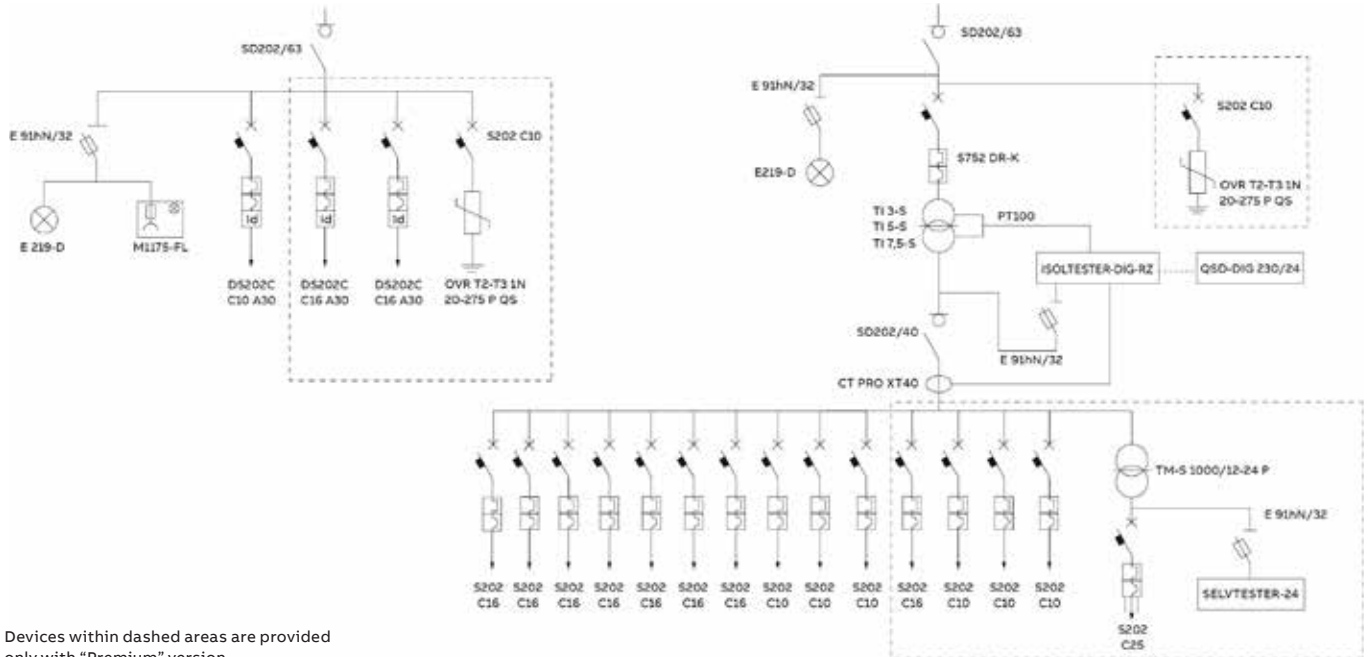

Devices within dashed areas are provided only with "Premium" version.

Description	QSO 3M	QSO 5M	QSO 7,5M	QSO 3M	QSO 5M	QSO 7,5M
	Classic	Classic	Classic	Premium	Premium	Premium
2P 63 A SD202/63 disconnector	3	3	3	3	3	3
E 91hN/32 fuse-holder	3	3	3	4	4	4
E219-D green light indicator power supply presence	2	2	2	2	2	2
ISOLTESTER-DIG-RZ insulation monitoring device	1	1	1	1	1	1
24 V SELVTESTER-24 insulation monitoring device				1	1	1
OVR T2-T3 1N 20-275 P QS surge protective device				2	2	2
6 kA 2P C10 S202 miniature circuit-breaker	3	3	3	8	8	8
6 kA 2P C16 S202 miniature circuit-breaker	7	7	7	8	8	8
6 kA 2P C25 S202 miniature circuit-breaker				1	1	1
M1175-FL 2P+T 16 A schuko socket with indicator lamp and fuse	1	1	1	1	1	1
25 kA 2P S752 DR-K25 miniature circuit-breaker	1	1		1	1	
25 kA 2P S752 DR-K40 miniature circuit-breaker			1			1
1N 10 A 0,03 A DS202 C C10 A30 residual current breaker with overcurrent protection	1	1	1	1	1	1
1N 16 A 0,03 A DS202 C C16 A30 residual current breaker with overcurrent protection				2	2	2
AMM damper set	4	4	4	8	8	8
CT PRO XT40 current transformer	1	1	1	1	1	1
TM-S 1000/12-24 P. 230-400V S. 24V control and safety transformer				1	1	1
Medical insulating transformer with 3000 VA 230/230 V TI 3-S probes	1			1		
Medical insulating transformer with 5000 VA 230/230 V TI 5-S probes		1			1	
Medical insulating transformer with 7500 VA 230/230 V TI 7,5-S probes			1			1
10 x 38 gG 2A E9F10 GG2 fuse	6	6	6	8	8	8

Protection and safety technical details

QSO switchboard for medical locations

QSO L

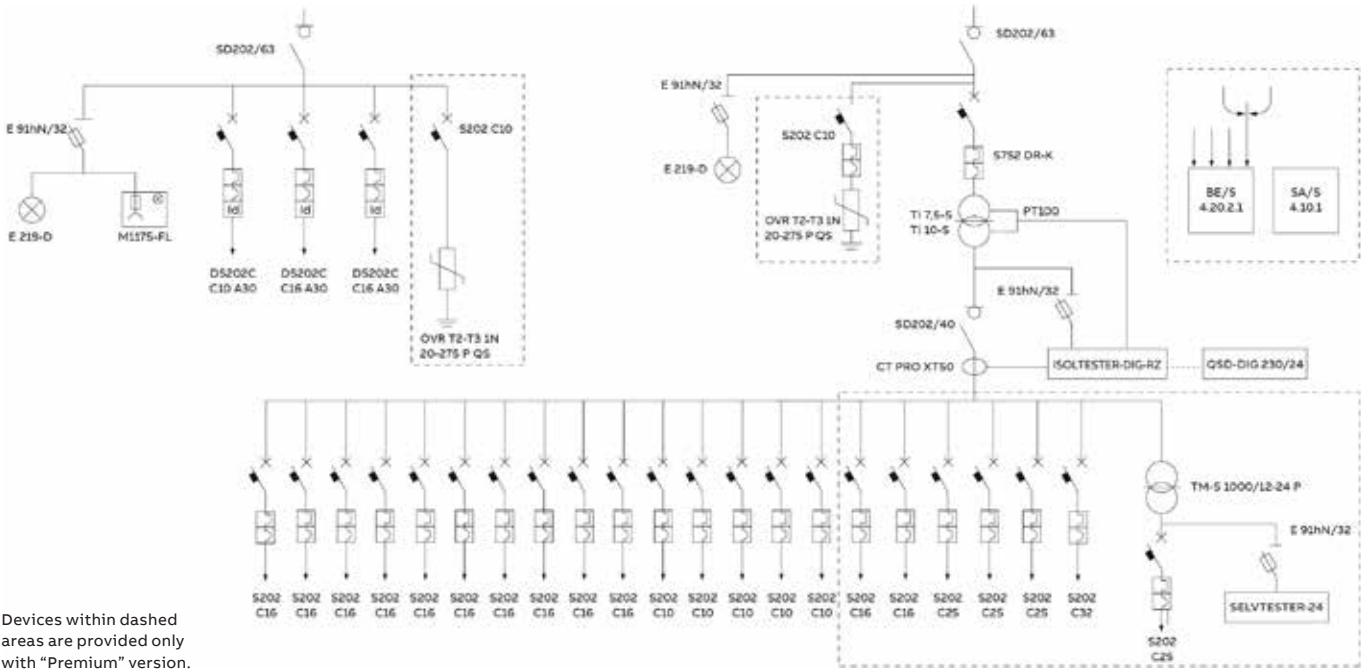

Devices within dashed areas are provided only with "Premium" version.

Description	QSO 10L Classic	QSO 7.5 L Premium	QSO 10 L Premium
2P 63 A SD202/63 disconnector	3	3	3
E 91hN/32 fuse-holder	3	4	4
E219-D green light indicator power supply presence	2	2	2
BE/S 4.20.2.1 4 channel binary input terminal			1
ISOLTESTER-DIG-RZ insulation monitoring device	1	1	1
24 V SELVTESTER-24 insulation monitoring device		1	1
10 A SA/S 4.10.1 4 channel output terminal			1
OVR T2-T3 1N 20-275 P QS surge protective device		2	2
S2-CS/H6R auxiliary contact 1 exchange			1
6 kA 2P C10 S202 miniature circuit-breaker	6	8	8
6 kA 2P C16 S202 miniature circuit-breaker	9	11	11
6 kA 2P C25 S202 miniature circuit-breaker		3	3
6 kA 2P C32 S202 miniature circuit-breaker		1	1
M1175-FL 2P+T 16 A schucko socket with indicator lamp and fuse	1	1	1
25 kA S752 DR-K40 miniature circuit-breaker		1	
25 kA S 752 DR-K50+S750DR-AUX miniature circuit-breaker	1		
1N 10A 0,03A DS202 C C10 A30 residual current breaker with overcurrent protection	1	1	1
1N 16A 0,03A DS202 C C16 A30 residual current breaker with overcurrent protection	2	2	2
AMM damper set	4	8	8
CT PRO XT50 current transformer	1	1	1
TM-S 1000/12-24 P. 230-400 V S.24 V control and safety transformer		1	1
Medical insulating transformer with 7500 VA 230/230 V TI 7,5-S probes		1	
Medical insulating transformer with 10000 VA 230/230 V TI 10-S probes	1		1
10 x 38 gG 2A E9F10 GG2 fuse	6	8	6

Protection and safety technical details

Insulation monitoring devices

Insulation monitoring devices ISL for industrial applications

ISL-A 24-48

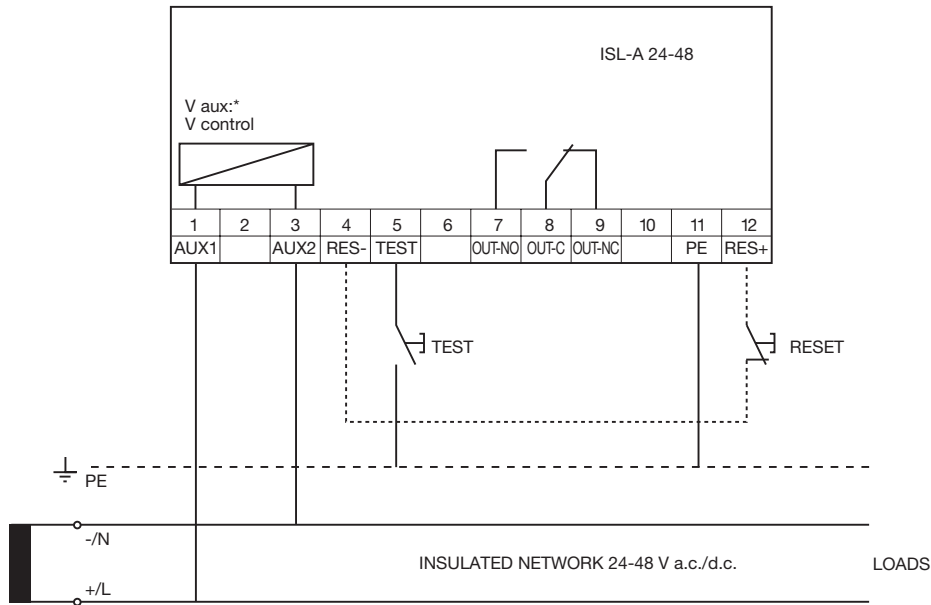

MICROSWITCH SETTINGS

The front microswitches allow the insulation threshold level to be adjusted between 10 and 60 kΩ, as shown below:

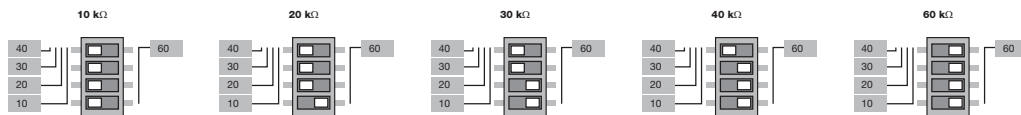

Protection and safety technical details

Insulation monitoring devices

ISL-A 115 and ISL-A 230

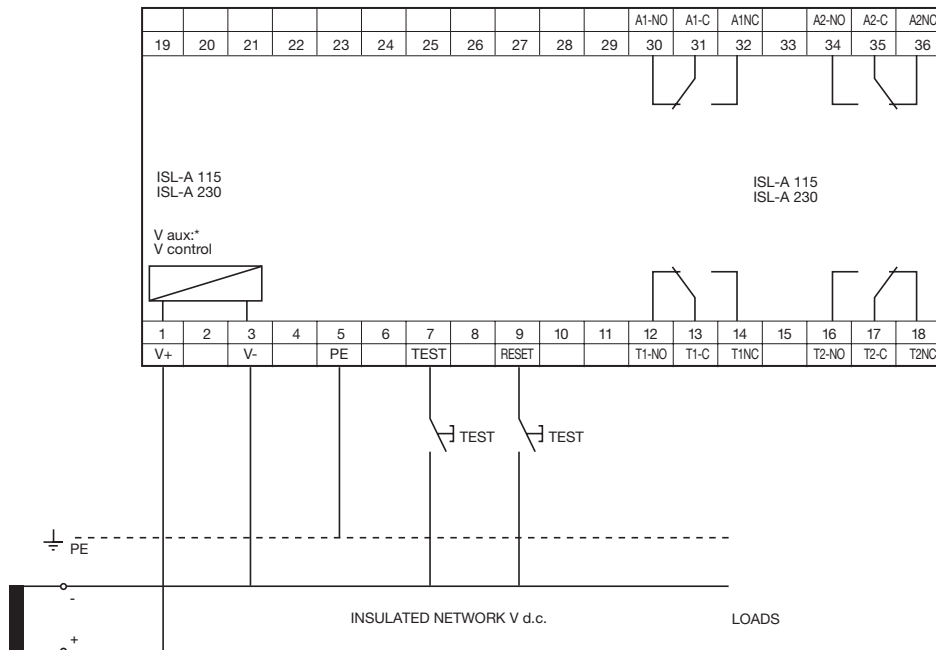

MICROSWITCH SETTINGS

The front microswitches are used for adjusting the insulation threshold level, enabling the fail-safe function and configuring the reset mode for both the alarm and trip thresholds.

Microswitches A, B, C, D for programming the trip and alarm thresholds:

ALARM		TRIP	
300 k Ω :	A=0, B=0, C=0, D=0	100 k Ω :	A=0, B=0, C=0, D=0
150 k Ω :	A=1, B=0, C=0, D=0	60 k Ω :	A=1, B=0, C=0, D=0
80 k Ω :	A=1, B=1, C=0, D=0	40 k Ω :	A=1, B=1, C=0, D=0
50 k Ω :	A=1, B=1, C=1, D=0	20 k Ω :	A=1, B=1, C=1, D=0
30 k Ω :	A=1, B=1, C=1, D=1	10 k Ω :	A=1, B=1, C=1, D=1

Microswitch E for configuring the FAIL SAFE mode

E=0 fail safe mode disabled

E=1 fail safe mode enabled

Microswitch F for configuring the RESET mode

F=0 manual reset

F=1 automatic reset

Protection and safety technical details

Insulation monitoring devices

ISL-A 600

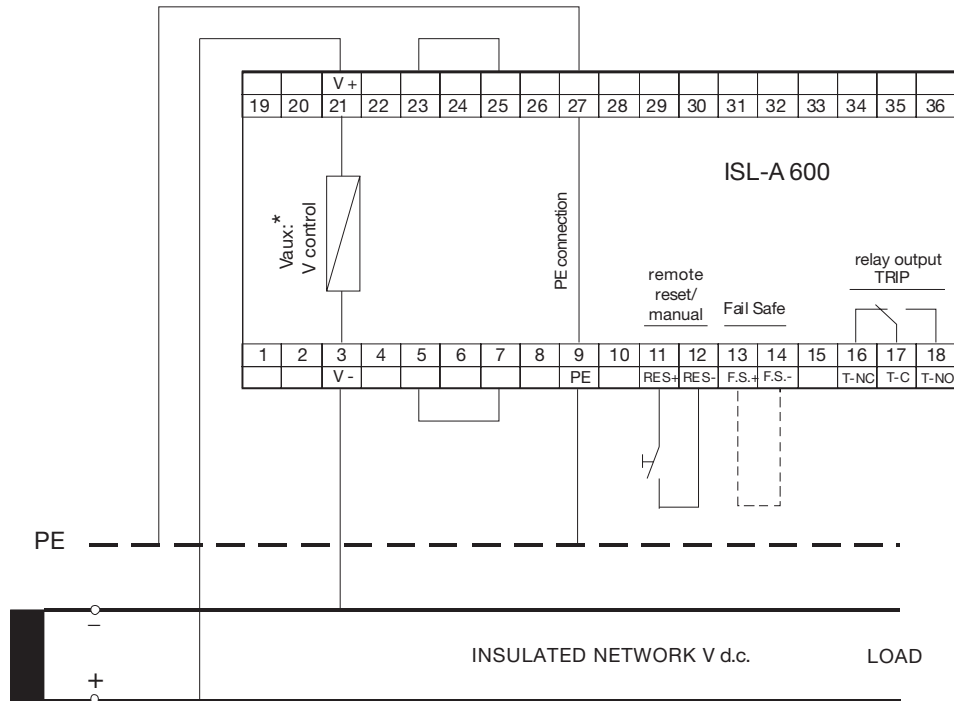

Protection and safety technical details

Insulation monitoring devices

ISL-C 230

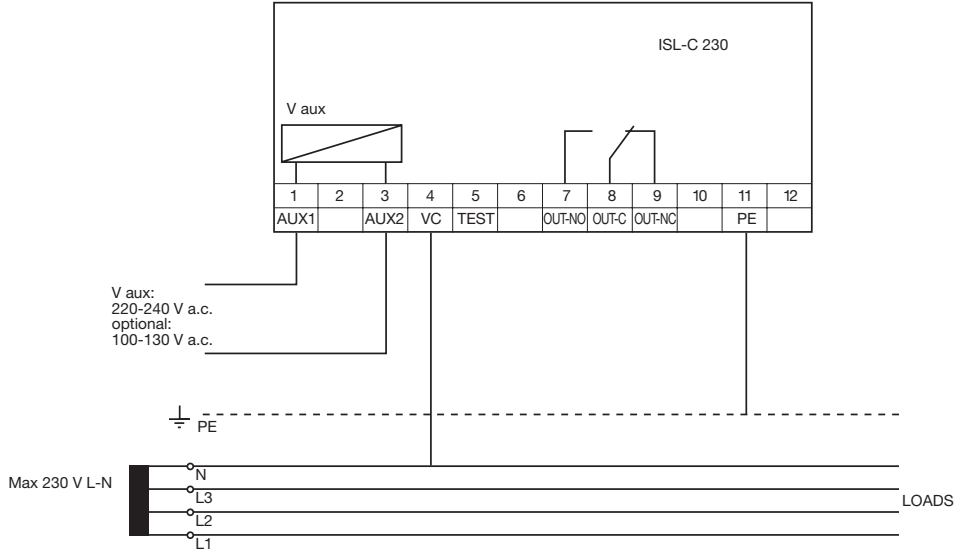

ISL-C 440

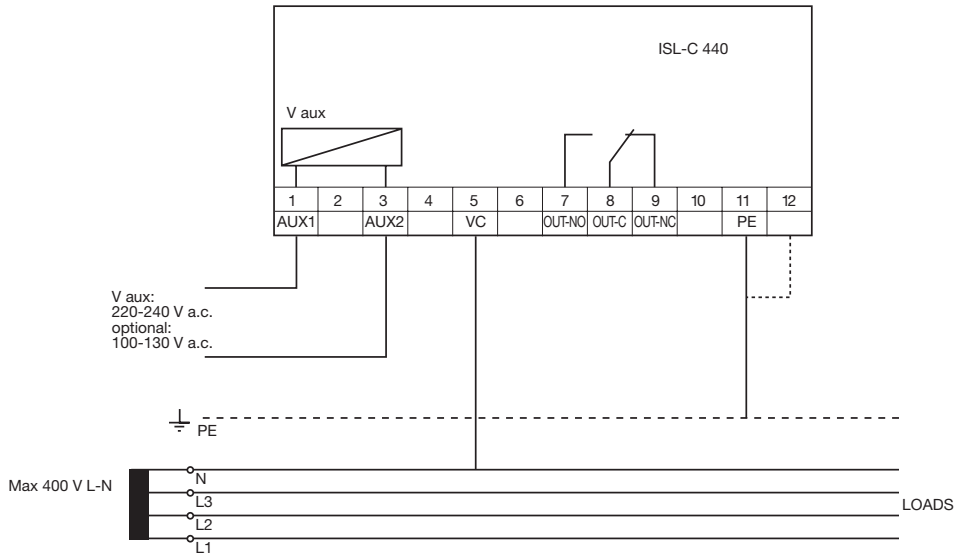

MICROSWITCH SETTINGS

The front microswitches are used for adjusting the insulation threshold level between 10 and 150 kΩ, as shown below:

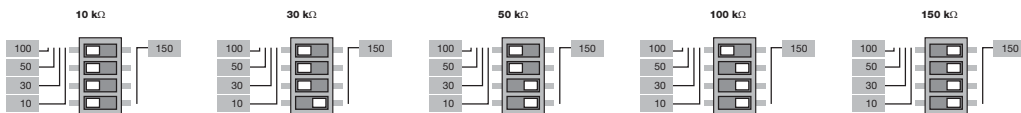

Protection and safety technical details

Insulation monitoring devices

ISL-C 600

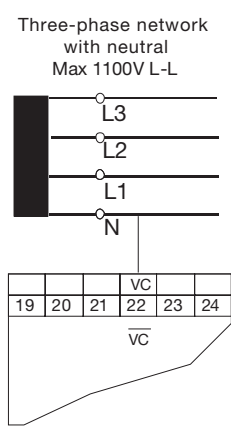
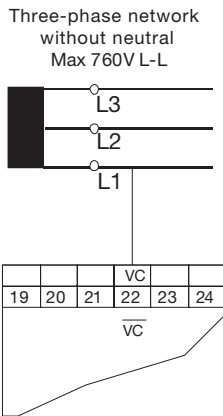
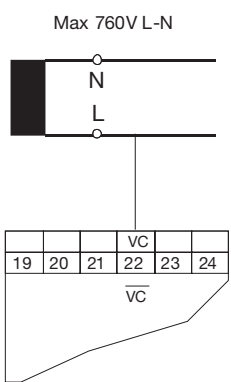
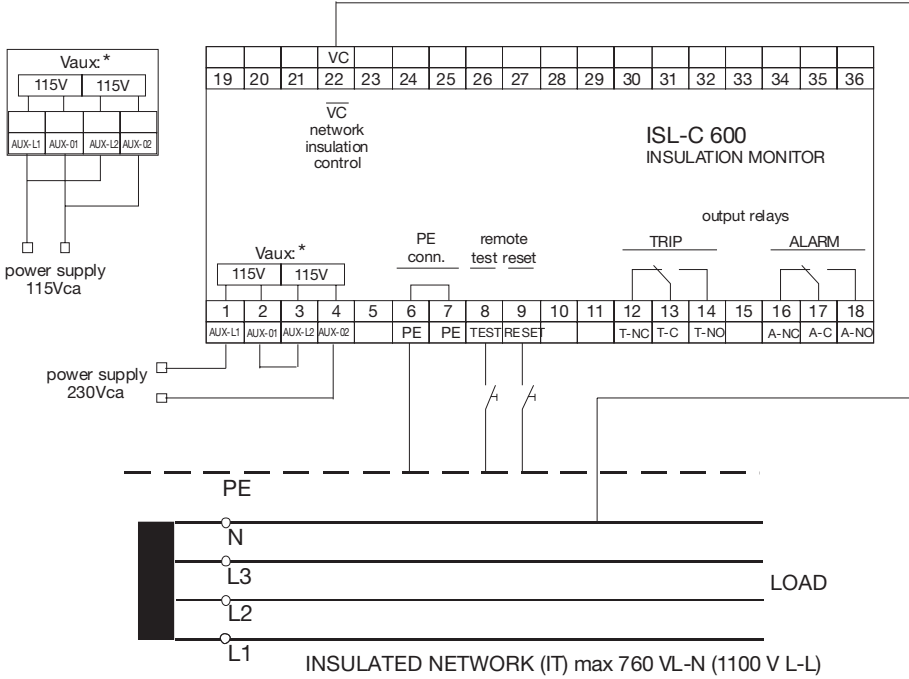

Protection and safety technical details

Insulation monitoring devices

ISL-MOT 1000

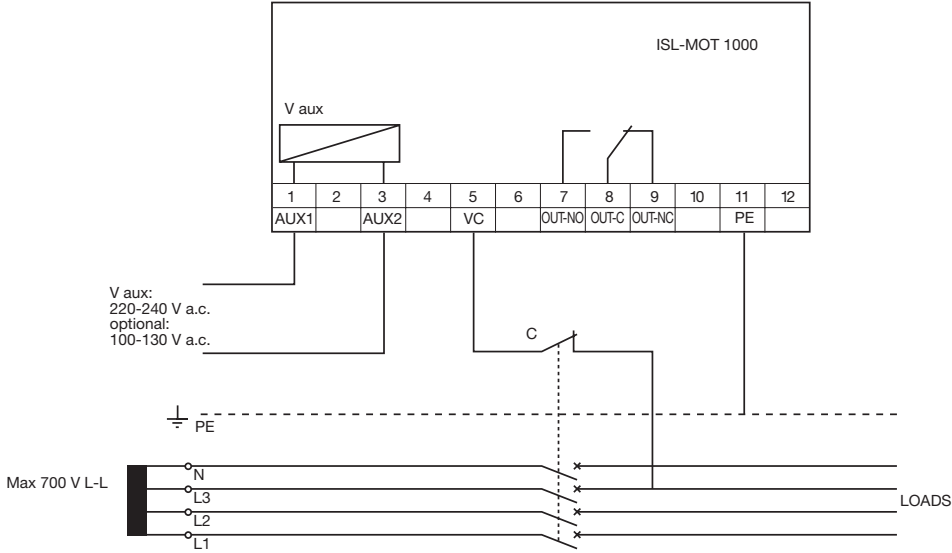

MICROSWITCH SETTINGS

The front microswitches are used for adjusting the insulation threshold level between 0.1 and 10 MΩ. A total of 7 microswitches are used, divided into two groups as shown below:

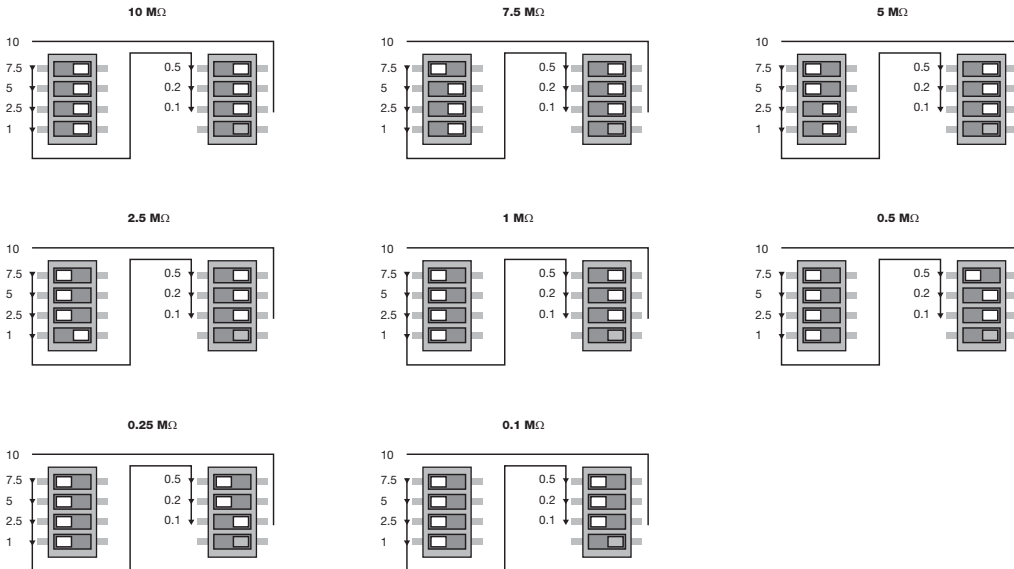

Protection and safety technical details

Insulation monitoring devices

Operating principle

In IT electrical distribution systems that supply critical applications, where operational continuity is essential, ISL insulation monitoring devices assure continuous surveillance to promptly detect any insulation loss.

Application environments

All IT distribution systems in which operational continuity is a critical factor, and in particular:

- 24-28 V, 100-144 V and 220 V d.c. networks
- 24-48 V, 100-144 V and 380-415 V a.c. networks
- 20-700 V a.c./d.c. voltageless networks

Example of installation

ISL-MOT 1000 is suitable for preventive protection of voltageless circuits such as alarm and fire-fighting systems, pumps, etc.

ISL-MOT 1000 continually monitors the insulation level between the line and earth, to guarantee that the system will function correctly when needed.

The trip threshold is programmable, and insulation loss can be signalled via a change-over contact, which can also be used for switching loads.

