

OPTIONS FOR ABB DRIVES

# CPTC-02 ATEX-certified thermistor protection module, Ex II (2) GD (option +L537+Q971)

User's manual





# CPTC-02 ATEX-certified thermistor protection module, Ex II (2) GD (option +L537+Q971)

## User's manual

Table of contents



1. Safety instructions



5. Mechanical installation



6. Electrical installation



7. Start-up and validation test





# Table of contents

---

## 1 Safety instructions

Contents of this chapter .....	9
Use of warnings and notes .....	9
ATEX/UKEX-certified motor thermal protection functions .....	9
Instructions for functional safety circuits .....	10

## 2 Introduction to the manual

Contents of this chapter .....	11
Applicability .....	11
Compatibility .....	11
Target audience .....	11
Exclusion of liability .....	12
Related manuals .....	12
Terms and abbreviations .....	13

## 3 Hardware description

Contents of this chapter .....	15
Product overview .....	15
External power supply interface .....	15
Layout .....	16
Markings .....	16
Module .....	16
Type designation label .....	16
ATEX/UKEX markings .....	17
Drive .....	17
SMT function .....	17

## 4 Option description

Contents of this chapter .....	19
Overview .....	19
Wall-mounted drives and drive modules .....	19
Cabinet-installed drives .....	20
Safe disconnection function .....	20
Commissioning the drive for a motor in a hazardous area .....	20
Resetting the safety function .....	20
Indications of the safety function .....	21
Switching frequency limitation .....	21
Fault reaction function .....	21
CPTC-02 module .....	21
STO function in the drive .....	21

## 5 Mechanical installation

Contents of this chapter .....	23
Necessary tools and instructions .....	23

---



Unpacking and examining the delivery ..... 23  
 Installing the module ..... 23

**6 Electrical installation**

Contents of this chapter ..... 25  
 Warnings ..... 25  
 Necessary tools and instructions ..... 25  
 Selecting the location for the drive ..... 26  
 General wiring instructions ..... 26  
 Terminal designations ..... 26  
     Motor thermistor connection ..... 26  
     Relay output connection ..... 26  
     External power supply ..... 26  
 PTC sensor input ..... 27  
 Wiring examples ..... 27  
     Motor thermistor connection example ..... 27  
     Relay output connection ..... 28  
     Power supply connection ..... 29

**7 Start-up and validation test**

Contents of this chapter ..... 31  
 Validation of the safety functions ..... 31  
     Competence ..... 31  
     Validation procedure ..... 31  
     Validation test reports ..... 32  
 Start-up ..... 32  
 Validation test ..... 33

**8 Fault tracing**

Contents of this chapter ..... 37  
 Reporting problems and failures related to safety functions ..... 37  
 CPTC-02 module replacement ..... 37  
 Fault and warning messages ..... 37  
 LED ..... 38

**9 Maintenance**

Contents of this chapter ..... 39  
 Safety circuit maintenance ..... 39  
 Proof test ..... 39  
 Proof test interval ..... 39  
 Functional safety components ..... 40  
 Competence ..... 40  
 Residual risk ..... 40  
 Intentional misuse ..... 41  
 Decommissioning ..... 41

**10 Technical data**

Contents of this chapter ..... 43  
 Dimension drawing ..... 44  
 Isolation areas ..... 45



Connections .....	45
Motor thermistor connection (60...61) .....	45
Relay output (STO) connection (62...63) .....	45
External power supply (40...41) .....	46
Ambient conditions .....	46
Safety data .....	46
Safety block diagram .....	46
Response times .....	47
Relevant failure modes .....	47
Related standards and directives .....	47
Compliance with the Machinery Directive (EU) .....	48
Compliance with the Supply of Machinery (Safety) Regulations (UK) .....	48
Compliance with the ATEX Directive (EU) .....	48
Compliance with the UKEX Directive (UK) .....	48
Declaration of Conformity (EU) .....	49
Declaration of Conformity (UK) .....	51
ATEX certificate .....	53
UKEX certificate .....	55
TÜV Nord certificate .....	57

### **Further information**







# 1

## Safety instructions

---

### Contents of this chapter

This chapter contains the safety instructions which you must obey when you install, operate and do maintenance on the safety functions of a drive.

### Use of warnings and notes

Warnings tell you about conditions which can cause injury or death, or damage to the equipment. They also tell you how to prevent the danger. Notes draw attention to a particular condition or fact, or give information on a subject.

The manual uses these warning symbols:

**WARNING!**

Electricity warning tells about hazards from electricity which can cause injury or death, or damage to the equipment.

**WARNING!**

General warning tells about conditions other than those caused by electricity, which can cause injury or death, or damage to the equipment.

**WARNING!**

Electrostatic sensitive devices warning tells you about the risk of electrostatic discharge which can cause damage to the equipment.

### ATEX/UKEX-certified motor thermal protection functions

Only qualified specialists are permitted to install, control and maintain the ATEX/UKEX-certified motor thermal protection functions (see IEC/EN 60079-14).

---



Obey all safety regulations required with application of Ex motors in Zone 1/21 (equipment category 2) or Zone 2/22 (equipment category 2 or 3).

## Instructions for functional safety circuits

---



**WARNING!**

Obey the safety instructions of the drive. If you ignore them, injury or death, or damage to the equipment can occur. If you are not a qualified electrical professional, do not do installation, commissioning or maintenance work.

---

This manual does not contain the complete safety instructions of the drive. It only includes the instructions related to the scope of this manual. The general instructions are given in this section and the option-specific instructions in the applicable chapter.

---



**WARNING!**

The safety function described in this manual does not isolate the main circuit or auxiliary circuit from the power supply. Do not do work on the drive, motor cable or motor before you have isolated the drive system from all power supplies and measured that there are no dangerous voltages. Before you start the work, do the electrical safety precautions in the drive safety instructions.

---



# 2

## Introduction to the manual

---

### Contents of this chapter

This chapter gives basic information on the manual.

### Applicability

This manual is applicable to the CPTC-02 module and to the Safe motor temperature safety (SMT) function which uses the CPTC-02 module (option +L537+Q971).

### Compatibility

The CPTC-02 module is compatible with:

- ACS580-01/-04, ACH580-01/-04/-31/-34, and ACQ580-01/-04/-31/-34 wall-mounted drives and drive modules to be installed in user-defined cabinet
- ACS580-07, ACH580-07, and ACQ580-07 cabinet-installed drives
- ACS580 standard control program version 1.70 or later
- ACH580 HVAC control program version 2.05 or later
- ACQ580 pump control program version 2.05 or later

### Target audience

This manual is intended for people who install, commission, use and service the ATEX-certified thermistor protection module of the drive. Read the manual before working on the drive. You are expected to know the fundamentals of electricity, wiring, electrical components, electrical schematic symbols, functional safety, and Ex regulations.

---

## Exclusion of liability

ABB is not responsible for the implementation, verification and validation of the overall safety system. It is the responsibility of the system integrator (or other party) who is responsible for the overall system, Ex regulations and system safety.

The system integrator (or other responsible party) must make sure that the entire implementation complies with the instructions in this manual, all relevant standards, directives and local electrical code, and that the system is tested, verified and validated correctly.

## Related manuals

Name	Code
<b>Drive hardware</b>	
ACS580-01 (0.75 to 250 kW) hardware manual R1-R9	3AXD50000044794
ACS580-04 drive modules (200 to 500 kW) hardware manual	3AXD50000015497
ACS580-07 drives hardware manual	3AXD50000045815
ACH580-01 (0.75 to 250 kW) hardware manual R1-R9	3AXD50000044839
ACH580-04 drive modules (250 to 500 kW) hardware manual	3AXD50000048685
ACH580-07 hardware manual	3AXD50000045816
ACH580-31 hardware manual	3AXD50000037066
ACH580-34 hardware manual	3AXD500000419708
ACQ580-01 (0.75 to 250 kW) hardware manual R1-R9	3AXD50000044862
ACQ580-04 hardware manual	3AXD50000048677
ACQ580-07 hardware manual	3AXD50000045817
ACQ580-31 hardware manual	3AXD50000045935
ACQ580-34 hardware manual	3AXD500000420025
<b>Drive firmware</b>	
ACS580 standard control program firmware manual	3AXD50000016097
ACH580 HVAC control program firmware manual	3AXD50000027537
ACQ580 pump control program firmware manual	3AXD50000035867
<b>PC tools</b>	
Drive composer start-up and maintenance PC tool user's manual	3AUA0000094606
<b>Safety</b>	
ABB Safety information and solutions	<a href="http://www.abb.com/safety">www.abb.com/safety</a>
FPTC-02 pairing instruction	3AXD50001096700
Motors and drives in potentially explosive atmospheres - What you need to know	3AUA0000037223
Using motors with drives in potentially explosive atmospheres	<a href="https://new.abb.com/drives/segments/motors-and-drives-in-potentially-explosive-atmospheres">https://new.abb.com/drives/segments/motors-and-drives-in-potentially-explosive-atmospheres</a>
<b>Option manuals</b>	
ACS-AP-I, -S, -W and ACH-AP-H, -W Assistant control panels user's manual	3AUA0000085685

Name	Code
CPTC-02 ATEX-certified thermistor protection module, Ex II (2) GD (+L537+Q971) user's manual	3AXD50000030058
CPTC-02 ATEX-certified thermistor protection module, Instructions for pairing the module with an ATEX-certified drive	3AXD10001243391
Manuals and quick guides for I/O extension modules, fieldbus adapters, etc.	

See [www.abb.com/drives/documents](http://www.abb.com/drives/documents) for all manuals on the Internet.

## Terms and abbreviations

Term	Description
ACx580	ACS580, ACH580 or ACQ580
ATEX	Directives 2014/34/EU and 1999/92/EC are commonly referred to as the ATEX directives (from "Atmosphères Explosibles")
Cat.	Classification of the safety-related parts of a control system in respect of their resistance to faults and their subsequent behavior in the fault condition, and which is achieved by the structural arrangement of the parts, fault detection and/or by their reliability. The categories are: B, 1, 2, 3 and 4. (EN ISO 13849-1)
CCF	Common cause failure (%) (EN ISO 13849-1)
CPTC-02	Multifunction extension module (external 24 V and ATEX/UKEX-certified PTC interface)
DC	Diagnostic coverage (EN ISO 13849-1)
DI	Digital input
EMC	Electromagnetic compatibility
Ex	An IEC term used in the context of explosive atmospheres (IEC 60079)
Ex d	Type of protection, flameproof enclosures (IEC/EN 60079-1)
Ex eb, Ex ec	Types of protection, increased safety (IEC/EN 60079-7)
Ex motors	Motors used in explosive atmospheres
HFT	Hardware fault tolerance (IEC 61508)
MTTF <sub>D</sub>	Mean time to dangerous failure: (Total number of life units) / (Number of dangerous, undetected failures) during a particular measurement interval under stated conditions (EN ISO 13849-1)
PFD <sub>avg</sub>	Average probability of dangerous failure on demand (IEC 61508)
PFH	Average frequency of dangerous failures per hour (IEC 61508)
PL	Performance level. Levels a...e correspond to SIL (EN ISO 13849-1)
SC	Systematic capability (IEC 61508)
SFF	Safe failure fraction (%) (IEC 61508)
SIL	Safety integrity level (1...3) (IEC 61508, IEC 62061, IEC 61800-5-2)
SMT	Safe motor temperature (IEC/EN 61800-5-2)
STO	Safe torque off (IEC/EN 61800-5-2)
T <sub>1</sub>	Proof test interval. Defines the probabilistic failure rate (PFH or PFD <sub>avg</sub> ) for the safety function or subsystem. Performing a proof test at a maximum interval of T <sub>1</sub> is required to keep the SIL capability valid. The same interval must be followed to keep the PL capability (EN ISO 13849) valid. Note that any T <sub>1</sub> values given cannot be regarded as a guarantee or warranty.
T <sub>M</sub>	Mission time: the period of time covering the intended use of the safety function/device. After the mission time elapses, the safety device must be replaced. Note that any T <sub>M</sub> values given cannot be regarded as a guarantee or warranty. (EN ISO 13849-1, IEC 61800-5-2)
UKEX	The Equipment and Protective Systems Intended for Use in Potentially Explosive Atmospheres Regulations 2016 (+ amendment SI 2019 No. 696)

## 14 Introduction to the manual

<b>Term</b>	<b>Description</b>
Validation	Confirmation by, for example, analysis that the safety system meets the functional safety requirements of the specific application.
Verification	Confirmation by, for example, testing that the safety system meets the requirements set by the specification.
Zone	Potentially explosive atmosphere. Hazardous areas are divided into zones, based on the frequency and duration of the occurrence of an explosive atmosphere. (IEC/EN 60079-10)

---

3

## Hardware description

---

### Contents of this chapter

This chapter gives a short description of the module.

### Product overview

The CPTC-02 module has a motor thermistor connection for supervising the motor temperature and one relay output, which indicates motor overtemperature. To trip the drive at motor overtemperature, the relay output must be connected to the Safe torque off (STO) input of the drive.

The CPTC-02 module together with the drive STO implements the Safe motor temperature (SMT) safety function as defined in IEC/EN 61800-5-2.

The CPTC-02 module is Type Examined as a protective device within the scope of the European ATEX (and UKEX) Product Directive. This allows the use of the module in temperature protection of motors in explosive atmospheres (Ex motors).

Inside the module, there is reinforced insulation between the motor thermistor connection and the other terminals of the module. The insulation forms a reliable protective separation between the motor main circuit and the drive control circuits. Thus, the drive control unit is Protective Extra Low Voltage (PELV) compatible also when the CPTC-02 module and a thermistor protection circuit are installed.

#### ■ External power supply interface

The module has an external power supply interface, which can be used to power up the drive control unit if the drive power supply fails. If you do not need the back-up power supply, you do not have to connect it because the module is powered from the drive control unit by default.

---

■ **Layout**

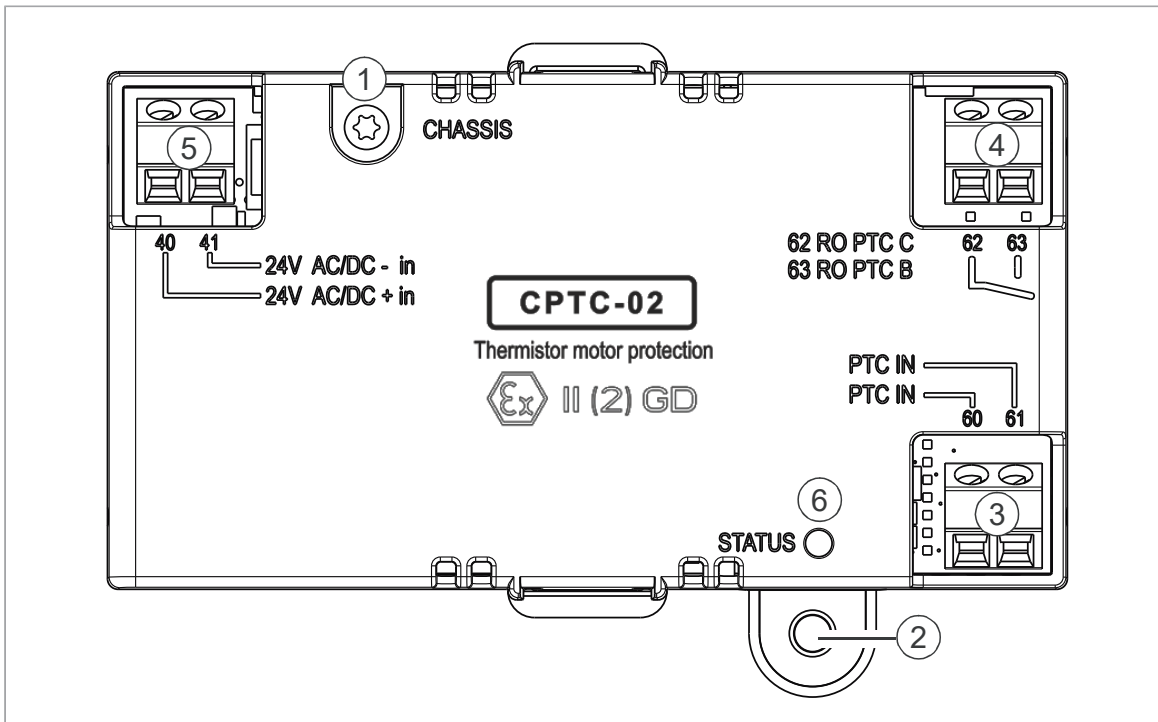

1	Grounding screw
2	Hole for mounting screw
3	2-pin terminal block for motor thermistor connection
4	2-pin detachable terminal block for relay output
5	2-pin terminal block for external power supply
6	Diagnostics LED

**Markings**

■ **Module**

**Type designation label**

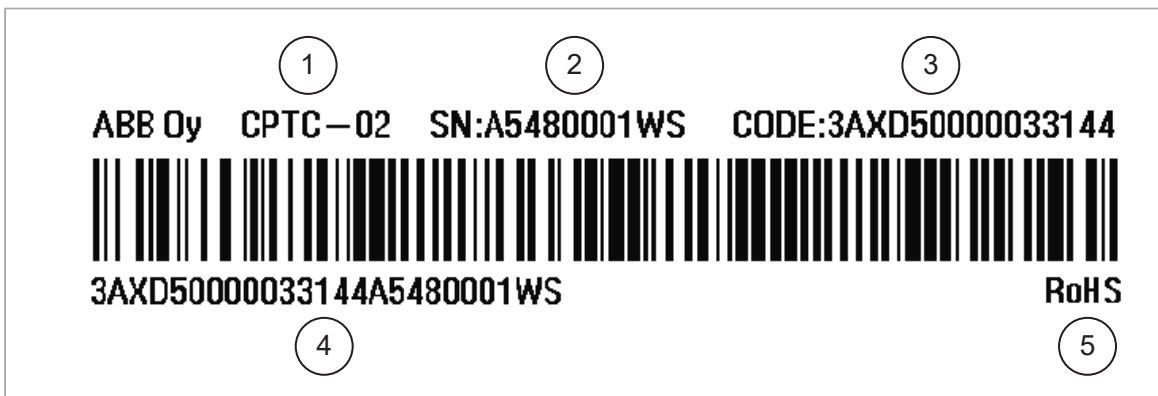

1	Type
---	------



2	Serial number in format RYWSSSSWS, where: R: Component revision Y: Last digit of the manufacturing year (for example, 5 = 2015) WW: Manufacturing week (for example, 01 = week 1) SSSS: Number that starts every week from 0001 WS: Manufacturing location
3	ABB MRP code of the module
4	Combined ABB MRP code, serial number and manufacturing location
5	RoHS mark

### ATEX/UKEX markings

The markings on the module show the ATEX/UKEX classification of the CPTC-02 module.

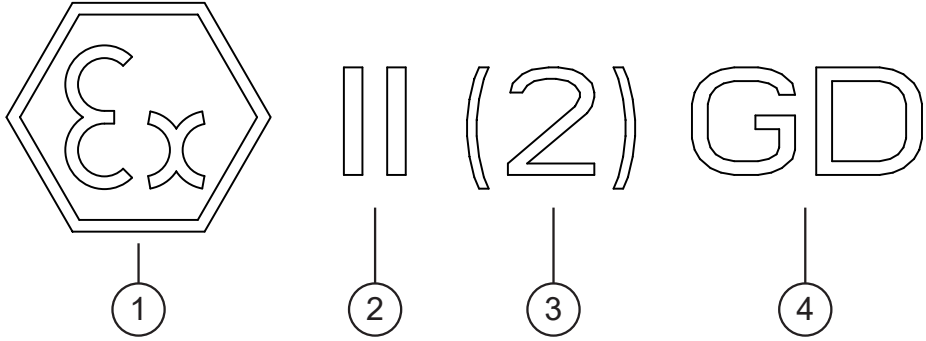
	
1	Specific marking of explosion protection
2	Equipment group II: Product for surface industry (other than mining applications)
3	Equipment category 2. Parentheses show that the module must be installed outside the potentially explosive atmosphere.
4	Certified for use in explosive atmospheres caused by: G = gases, vapors or mists, D = dust.

### ■ Drive

#### SMT function

When the CPTC-02 module is delivered as an add-on kit, the package contains a sticker to show the ATEX/UKEX classification of the Safe motor temperature (SMT) function. The user must attach this sticker near the type designation label of the drive to ensure the ATEX/UKEX compliance of the safety circuit.

In the cabinet-built drives, this sticker is attached to the cabinet door at the factory.

18 Hardware description

1	CE marking with Notified Body identification: The manufacturer declares that the product conforms with ATEX Product Directive 2014/34/EU. Notified Body: Eurofins Expert Services
2	UKCA marking with Approved Body identification: The manufacturer declares that the product conforms with The Equipment and Protective Systems Intended for Use in Potentially Explosive Atmospheres Regulations 2016 (+ amendment SI 2019 No. 696). Approved Body: Eurofins E&E CML Limited
3	Specific marking of explosion protection
4	Equipment group II: Product for surface industry (other than mining applications)
5	Equipment category 2. Parentheses show that the drive must be installed outside the potentially explosive atmosphere.
6	Certified for use in explosive atmospheres caused by: G = gases, vapors or mists, D = dust.
7	Certificate references
3AXD50000003122 E	

A large, bold, black number '4' is centered within a light gray square with rounded corners.

## Option description

---

### Contents of this chapter

This chapter describes the Safe motor temperature (SMT) function implemented with the CPTC-02 module and gives instructions for the user.

### Overview

To implement the Safe motor temperature (SMT) function, the relay output of the CPTC-02 module must be connected to the Safe torque off (STO) input of the drive.

When the motor temperature rises above the PTC sensor limit temperature, the sensor resistance increases sharply. This indicates overtemperature to the CPTC-02 module. The module switches the drive Safe torque off (STO) circuit off which activates the drive STO function.

The STO function disables the control voltage of the power semiconductors of the drive output stage. This prevents the drive from generating the torque required to rotate the motor. If the motor is running when STO function is activated, it coasts to a stop.

For more information on the drive STO function, see the appropriate drive hardware manual.

#### ■ Wall-mounted drives and drive modules

The module is available as an add-on kit (option +L537+Q971). If you intend to retrofit the CPTC-02 module to an installed drive, you need to make sure that the ATEX/UKEX certification enables the retrofit. Contact your local ABB representative for more information.

The user:

---

## 20 Option description

- makes sure that the serial number of the drive starts with 1, 4, 7, 8, M or Y,
- pairs the CPTC-02 module with an ATEX/UKEX-certified ACS580, ACH580 or ACQ580 drive in the ABB Drives Installed Base (DIB) register. Refer to *Instructions for pairing the module with an ATEX-certified drive* (3AXD10001243391 [English]).
- attaches the included ATEX/UKEX label for the SMT function near the type designation label (CE/UKCA marking) of the drive,
- installs the option module to Option slot 2 of the drive control unit and sets the applicable drive parameters,
- connects the PTC temperature sensors of the motor to the PTC input of the option module, and
- connects the drive STO terminals to the relay output of the option module.

### ■ Cabinet-installed drives

For cabinet-installed drives, the module is available as a factory-installed option +L537+Q971.

The user connects the PTC temperature sensors of the motor to the PTC inputs of the module.

## Safe disconnection function

The ATEX/UKEX-certified Safe motor temperature function described in this manual requires that the drive Safe torque off function (STO) is certified for use as a Safe disconnection function to protect equipment in potentially explosive atmospheres according to European ATEX (and UKEX) Product Directive. For more information on the drive STO function, see the applicable hardware manual.

You can use the CPTC-02 module only when serial number of the drive starts with 1, 4, 7, 8, M or Y.

**Note:** You do not need a separate ATEX/UKEX certification (and label) for the Safe disconnection function (option +Q971), because the ATEX/UKEX certificate of the SMT function includes also the ATEX/UKEX-certified Safe torque off function (STO).

## Commissioning the drive for a motor in a hazardous area

Commission the drive according to the requirements and limitations set by the application, the motor manufacturer's instructions, drive hardware and firmware manuals, local laws and regulations, and this manual.

The certificate of the Ex motor typically requires that you set a minimum limit for the output switching frequency of the drive. Make sure that the Ex motor is operated above the minimum output switching frequency specified by the motor manufacturer.

## Resetting the safety function

A manual reset is mandatory in an ATEX/UKEX-certified safety function. The CPTC-02 module generates a fault indication to the drive when motor overtemperature is reached. The user must reset the drive before it is possible to restart the drive.

**Note:** The reset function of the safety function is not SIL classified.

---

## Indications of the safety function

An indication of the safety function can come from two sources:

1. Overtemperature fault in the drive (fault 4991).
2. STO indication in the drive:
  - The drive STO indication is active when the SMT safety function has activated the drive STO function. The type of the indication is set with parameter 31.22.

To avoid parallel fault indications, set the STO indication parameter (31.22) to value *Warning/Warning*. See chapter [Start-up and validation test](#) for instructions.

**Note:** The indications of the safety function are not SIL classified.

## Switching frequency limitation

The certificate of the Ex motor typically requires that you set a minimum limit for the switching frequency of the drive.

For ABB Ex motors, use parameter 95.15 to set the required minimum switching frequency. For more information, refer to the drive firmware manual.

For Ex motors supplied by other motor manufacturers, contact the motor manufacturer for the correct value and use parameters 97.01 and 97.02 to make the parameter setting in the drive.

## Fault reaction function

### ■ CPTC-02 module

The CPTC-02 module has a fault reaction function. When the module detects an internal fault or a fault in the temperature sensor circuit, it sends a request to the drive control unit to stop modulation, and activates the drive STO function.

### ■ STO function in the drive

The STO function in the drive has internal fault diagnostics and a fault reaction function. The fault reaction function causes a fault trip if it detects a redundancy fault of STO control signals or an internal failure. For more information, see the hardware and firmware manuals of the drive.

---



# 5

## Mechanical installation

---

### Contents of this chapter

This chapter contains a delivery checklist and instructions on installing the module.

### Necessary tools and instructions

- Screwdriver and a set of suitable bits

For a complete list of tools, see the applicable drive hardware manual.

### Unpacking and examining the delivery

1. Open the option package.
2. Make sure that the package contains:
  - CPTC-02 module
  - mounting screw
  - STO cable
  - ATEX/UKEX label (with the ATEX/UKEX classification markings)
  - this manual.
3. Make sure that there are no signs of damage to the items.

### Installing the module

---

**WARNING!**

Obey the safety instructions of the drive. If you ignore them, injury or death, or damage to the equipment can occur. If you are not a qualified electrical professional, do not do installation, commissioning or maintenance work.

---

## 24 Mechanical installation

1. Stop the drive and do the electrical safety precautions in the drive safety instructions.
2. Install the module to Option slot 2 of the drive control unit. See the drive hardware manual.





# 6

## Electrical installation

---

### Contents of this chapter

This chapter contains instructions on wiring the module.

### Warnings

---

**WARNING!**

Obey the safety instructions of the drive. If you ignore them, injury or death, or damage to the equipment can occur. If you are not a qualified electrical professional, do not do installation, commissioning or maintenance work.

---

**WARNING!**

Cabinet-built drives: Do not connect, test or measure a drive based on the diagrams in this manual. Each delivery is unique. Before starting the work on the electric circuits of a drive, always refer to the delivery-specific circuit diagrams.

---

**WARNING!**

Make sure that the drive is disconnected from the input power during installation. Before you start the work, stop the drive and do the electrical safety precautions in the drive safety instructions.

---

### Necessary tools and instructions

- Screwdriver with a set of suitable bits
  - Cabling tools
- 



## Selecting the location for the drive

Install the drive, the CPTC-02 module, and the STO circuit outside any potentially explosive atmosphere. Consider the ambient conditions specification in the drive hardware manual.

## General wiring instructions

1. For the STO circuit wiring, use the type of cable specified in the applicable drive hardware manual.
2. Install only the sensor circuit into the potentially explosive atmosphere. The sensor circuit in the Ex Zone must comply with the requirements for the applicable type of protection, such as:
  - Ex d (IEC/EN 60079-1)
  - Ex eb (IEC/EN 60079-7, Ex e in EN 60079-7:2007 and IEC 60079-7:2006)
  - Ex ec (IEC/EN 60079-7, Ex nA in IEC/EN 60079-15:2010).
3. Install the drive, including the components of the ATEX-certified motor thermal protection function, outside the potentially explosive atmosphere.
4. For the sensor connection, ABB recommends to use shielded twisted-pair cable. This type of cable decreases electromagnetic interference in the sensor circuit.
5. Route the sensor cables away from the motor cable. Power cables can cause electromagnetic interference in the sensor circuit.
6. Ground all sensor cable shields to a single grounding point outside the potentially explosive atmosphere. 360-degree grounding of the cable shields at the cable entry of the drive is recommended. Do not connect the cable shields to ground at the sensor end of the cable.



## Terminal designations

### ■ Motor thermistor connection

Marking		Description
60	PTC IN	PTC connection
61	PTC IN	Ground (earth) potential

### ■ Relay output connection

Marking		Description
62	RO PTC C	Common, C
63	RO PTC C	Normally open, NO

### ■ External power supply

The external power supply is needed only if you want to connect an external back-up power supply for the drive control unit.

**Note:** Only frames R0...R5 need CPTC-02 to be supplied by an external power supply, frames R6...R9 have corresponding terminals 40 and 41 on the control unit.

Marking		Description
40	24V AC/DC + in	External 24 V (AC/DC) input
41	24V AC/DC - in	External 24 V (AC/DC) input

## PTC sensor input

For the recommended cable type and correct tightening torque, see the technical data.

To enable the SMT function, connect the PTC sensor to the PTC IN input.

To disable the SMT function, connect a resistor (100 ohm ... 1 kohm ¼ W wire-wound) to the PTC IN input.

**Note:** If you do not connect a PTC sensor or resistor to the PTC IN input, the STO function stays active. You cannot start the motor while the STO function is active.

## Wiring examples

Connect the external control cables to the applicable module terminals. Ground the outer shield of the cables 360 degrees under a grounding clamp on the grounding shelf of the control cables.

### ■ Motor thermistor connection example

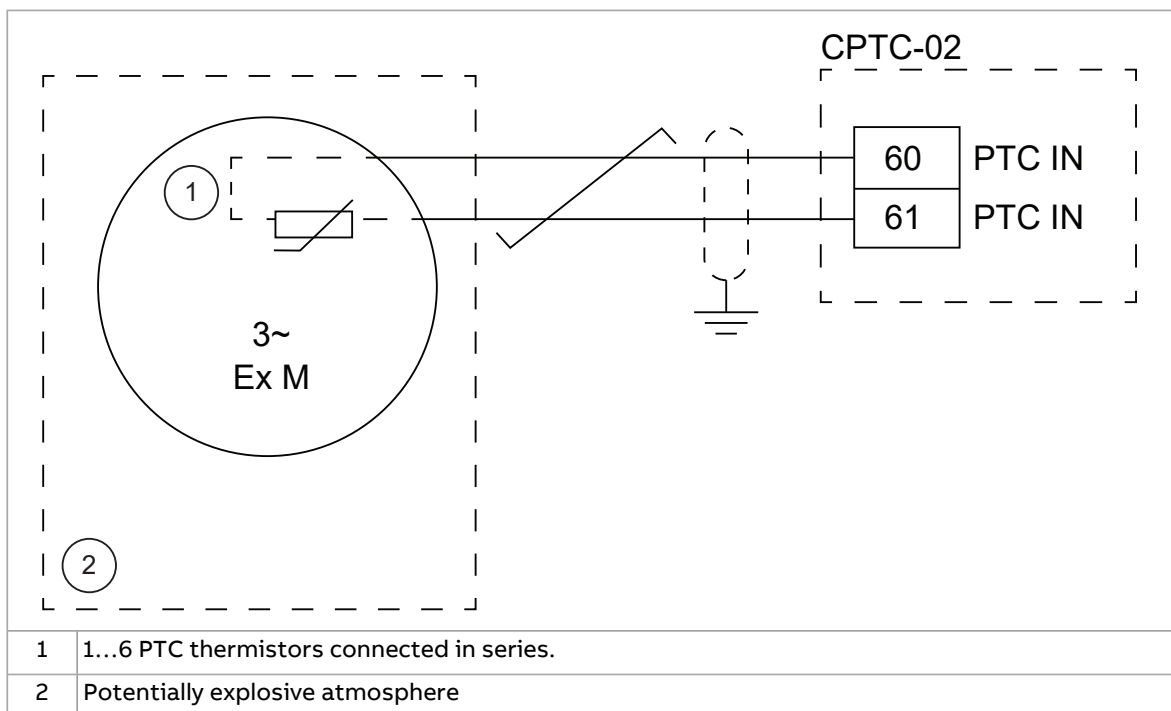

The PTC input is reinforced/double insulated. If the motor part of the PTC thermistor and wiring are reinforced/double insulated, voltages on the PTC wiring are within SELV limits.

If the motor PTC circuit is not reinforced/double insulated (that is, it is basic insulated), it is mandatory to use reinforced/double insulated wiring between the motor PTC and CPTC-02 PTC terminal.

■ **Relay output connection**

Connect the drive STO circuit to the relay output of the module as shown in this figure. In the cabinet-installed drives, the wiring is done at the factory.

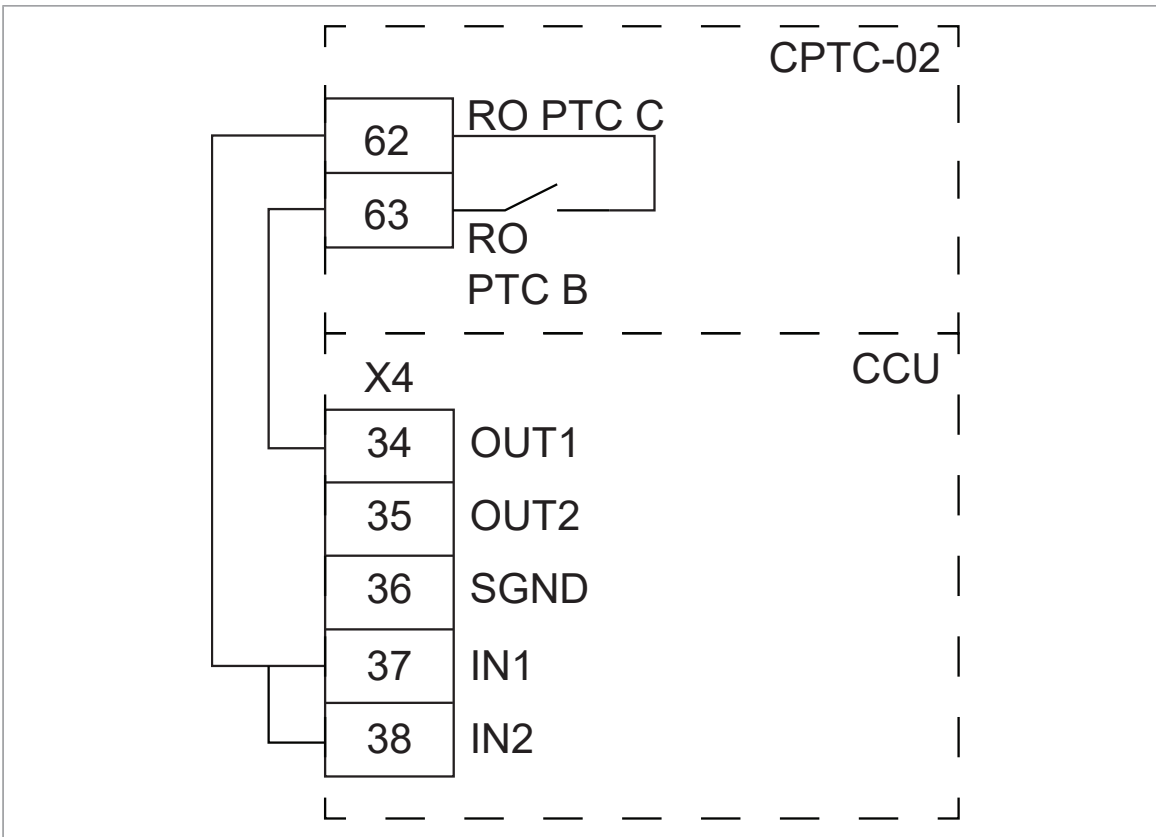

An alternative connection with an external activation switch, for example a manually operated switch, an emergency stop push button, or the contacts of a safety relay.

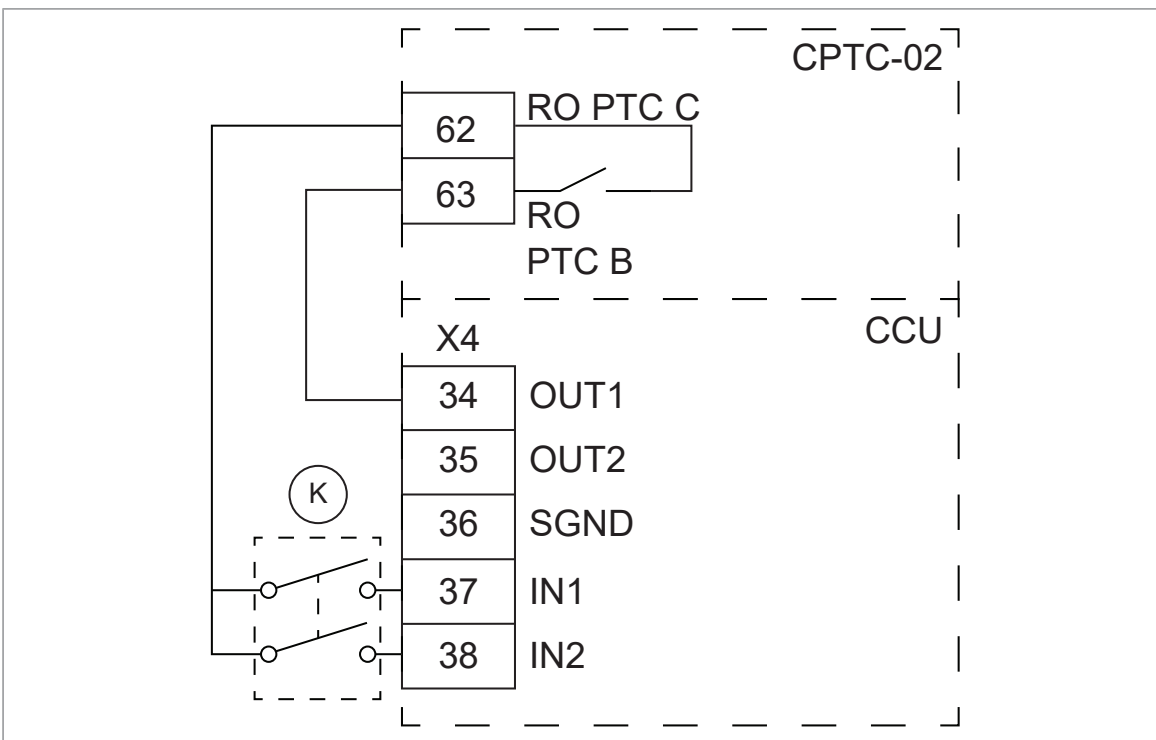

K	Activation switch
---	-------------------

### ■ Power supply connection

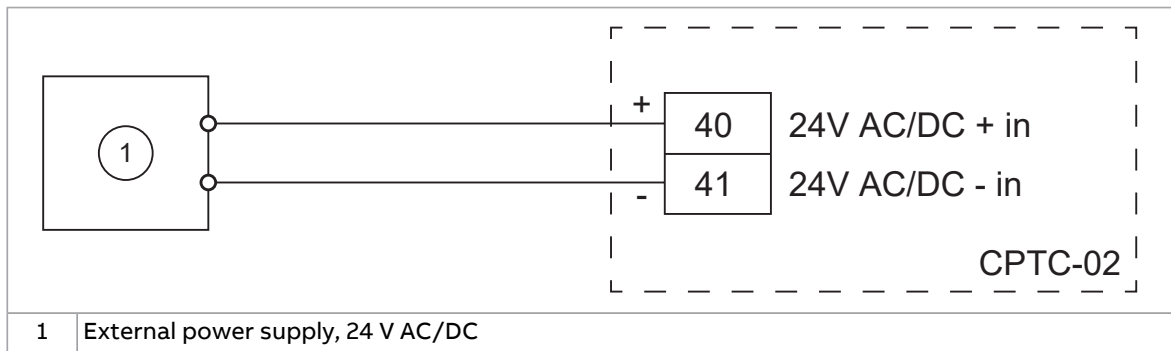

#### **WARNING!**

Do not connect the +24 V AC cable to the control unit ground when the control unit is powered using an external 24 V AC supply.





# 7

## Start-up and validation test

---

### Contents of this chapter

This chapter describes the start-up, validation test procedure, and validation of the safety function.

### Validation of the safety functions

You must do a validation test to make sure that the safety function operates correctly and according to the safety requirements.

#### ■ **Competence**

The person who does the validation test of the safety function must be a competent person with expertise and knowledge of the safety function and functional safety, as required by IEC 61508-1 clause 6 and Ex regulations. This person must document and sign the test procedures and report.

#### ■ **Validation procedure**

You must do the validation test using the checklist given in this manual and the validation test plan of the complete safety system:

- at the initial start-up of the safety function
- after changes related to the safety function (wiring, components, safety function-related parameter settings, etc.)
- after changes related to the power unit or its circuit boards
- after maintenance work related to the safety function
- at the proof test of the safety function.



The validation test must include at least the following steps:

- you must have a validation test plan
- you must test all commissioned functions for correct operation, from each operation location
- you must document all validation tests
- you must sign and store the validation test report for further reference.

### ■ Validation test reports

You must store the signed validation test reports in the logbook of the machine and in the explosion protection document under the scope of the ATEX User Directive 1999/92/EC or The Dangerous Substances and Explosive Atmospheres Regulations 2002 (UK). The report must include, as required by the referred standards:

- a description of the safety application (including a figure)
- a description and revisions of safety components that are used in the safety application
- a list of all safety functions that are used in the safety application
- a list of all safety-related parameters and their values
- documentation of start-up activities, references to failure reports and resolution of failures
- the test results for each safety function, checksums, date of the tests, and confirmation by the test personnel.

You must store any new validation test reports done due to changes or maintenance in the logbook of the machine and in the explosion protection document under the scope of the ATEX User Directive 1999/92/EC or The Dangerous Substances and Explosive Atmospheres Regulations 2002 (UK).

## Start-up



The module is started up through drive parameters. Use the Drive composer PC tool or the control panel to set the parameter values.

1. Power up the drive.
2. If no warning is shown:
  - Make sure that the value of both parameter *15.02 Detected extension module* and parameter *15.01 Extension module type* is *CPTC-02*.If warning *A7AB Extension I/O configuration failure* is shown:
  - Make sure that the value of parameter *15.02 Detected extension module* is *CPTC-02*
  - Set parameter *15.01 Extension module type* to *CPTC-02*.

You can now see the parameters of the extension module in parameter group *15 I/O extension module*. See the firmware manual.

In addition, set the parameters in this table.

---



Index	Name / Value	Description					
31.22	STO indication run/stop	Selects which indications are given when one or both Safe torque off (STO) signals are switched off or lost. The indications also depend on whether the drive is running or stopped when this occurs.					
	Warning/Warning	The drive generates a warning. This parameter value does not affect the SMT function, but this is the recommended setting.					
35.31	Safe motor temperature enable	Activates (On) or deactivates (Off) the Safe motor temperature (SMT) fault indication (4991). 0 = Off 1 = On  This parameter is automatically set to <i>On</i> , when CPTC-02 module is connected to the drive. If the module is removed from the drive, the parameter remains <i>On</i> , and the drive will trip to a fault. User must set parameter to <i>Off</i> manually and reset the fault to continue operation without the module. When the module is connected again, the parameter is automatically set to <i>On</i> .					
95.15	Special HW settings	Defines hardware-related settings that can be enabled and disabled by toggling the specific bits.					
	<table border="1"> <thead> <tr> <th>Bit</th> <th>Name</th> <th>Description</th> </tr> </thead> <tbody> <tr> <td>0</td> <td>EX motor</td> <td>1 = The driven motor is an Ex motor provided by ABB for potentially explosive atmospheres. This sets the required minimum switching frequency for ABB Ex motors (4 kHz).  <b>Note:</b> For non-ABB Ex motors, use parameters 97.01 and 97.02 to define the correct minimum switching frequency.  <b>Note:</b> Multimotor systems are not permitted.</td> </tr> </tbody> </table>	Bit	Name	Description	0	EX motor	1 = The driven motor is an Ex motor provided by ABB for potentially explosive atmospheres. This sets the required minimum switching frequency for ABB Ex motors (4 kHz).  <b>Note:</b> For non-ABB Ex motors, use parameters 97.01 and 97.02 to define the correct minimum switching frequency.  <b>Note:</b> Multimotor systems are not permitted.
Bit	Name	Description					
0	EX motor	1 = The driven motor is an Ex motor provided by ABB for potentially explosive atmospheres. This sets the required minimum switching frequency for ABB Ex motors (4 kHz).  <b>Note:</b> For non-ABB Ex motors, use parameters 97.01 and 97.02 to define the correct minimum switching frequency.  <b>Note:</b> Multimotor systems are not permitted.					
97.01	Switching frequency reference	Defines the switching frequency of the drive.  <b>Note:</b> Multimotor systems are not permitted.					
97.02	Minimum switching frequency	Defines the minimum limit for the switching frequency. If parameter 95.15 is set to 1, drive sets the value to 4 kHz automatically. For non-ABB Ex motors, consult the motor manufacturer.					
97.09	Switching frequency mode	Defines the switching frequency mode. Normal = Used switching frequency is selected with parameters 97.01 and 97.02.					
97.18	Hexagonal field weakening	Activates (On) or deactivates (Off) the Hexagonal field weakening. 0 = Off  For ABB Ex motors (parameter 95.15 is set to 1), this parameter is automatically set to <i>Off</i> . For non-ABB Ex motors (when parameter 95.15 bit 0 is not set), set this parameter to <i>Off</i> .					

## Validation test

Use the Drive composer PC tool or a control panel to do the validation test.

## 34 Start-up and validation test

<b>Action</b>	<input checked="" type="checkbox"/>
 <b>WARNING!</b> Obey the safety instructions of the drive. If you ignore them, injury or death, or damage to the equipment can occur.	<input type="checkbox"/>
<b>Initial status</b>	
Make sure that the drive is ready for use, that is, you have done the tasks of the drive start-up procedure. See the drive hardware manual.	<input type="checkbox"/>
Make sure that the CPTC-02 module is installed and started up as instructed in this manual.	<input type="checkbox"/>
Make sure that the drive STO function is configured and validated. See the hardware manual.	<input type="checkbox"/>
<b>Checks and settings with no voltage connected</b>	
Stop the drive and do the electrical safety precautions in the drive safety instructions.	<input type="checkbox"/>
Make sure that the necessary ATEX/UKEX markings are attached.	<input type="checkbox"/>
Make sure that the classification of the motor thermal protection function corresponds to the Ex classification of the environment and the Ex motor.	<input type="checkbox"/>
The motor manufacturer selects the PTC sensors for the motor temperature measurement according to the specified temperature class. Make sure that the temperature on-off resistances match those of the module.	<input type="checkbox"/>
If you have done any changes to the wiring, do a check of the connections against the applicable circuit diagrams.	<input type="checkbox"/>
Make sure that the installation of the motor temperature sensor complies with the requirements for the applicable type of protection.	<input type="checkbox"/>
Make sure that the SIL/PL of the safety function meets the target SIL/PL.	<input type="checkbox"/>
Make sure that the wires are connected to the correct terminals and that the terminal connections are tightened to the correct torque.	<input type="checkbox"/>
<b>Settings with voltage connected</b>	
Make sure that you have set all the necessary parameters for the safety function.	<input type="checkbox"/>
<b>Validation test procedure</b>	
Make sure that you can run and stop the motor freely during the test.	<input type="checkbox"/>
Start the drive and make sure that the motor is running.	<input type="checkbox"/>
Do an overtemperature monitoring test: increase the resistance in the PTC input to more than 4 kohm (for example, open the circuit by disconnecting the wires).	<input type="checkbox"/>
Make sure that the correct indications are activated: the SMT fault and other indications depending on the parameter settings.	<input type="checkbox"/>
Make sure that the STO is activated and that the motor coasts to a stop.	<input type="checkbox"/>
Make sure that you cannot start the drive before you reset the drive.	<input type="checkbox"/>
Reset the drive. Make sure that you cannot reset and restart the drive before the resistance in the PTC input decreases to less than 1.6 kohm (that is, the thermistor wires are reconnected).	<input type="checkbox"/>
Restart the drive and the motor. Make sure that they operate normally.	<input type="checkbox"/>
Do a short-circuit detection test: decrease the resistance in the PTC input to less than 50 ohm (for example, connect a jumper wire between the terminals of the PTC input).	<input type="checkbox"/>



<b>Action</b>	<input checked="" type="checkbox"/>
Make sure that the correct indications are activated: the SMT fault and other indications depending on the parameter settings.	<input type="checkbox"/>
Make sure that the STO is activated and that the motor coasts to a stop.	<input type="checkbox"/>
Make sure that you cannot start the drive before you reset the drive.	<input type="checkbox"/>
Reset the drive. Make sure that you cannot reset and restart the drive before the resistance in the PTC input increases to more than 50 ohm (that is, the jumper wire connected earlier is removed).	<input type="checkbox"/>
Restart the drive and the motor. Make sure that they operate normally.	<input type="checkbox"/>
Fill in and sign the validation test report. Store the report in the logbook of the machine.	<input type="checkbox"/>







## Fault tracing

---

### Contents of this chapter

This chapter shows how to trace faults with fault and warning messages of the drive and LED on the module.

### Reporting problems and failures related to safety functions

Contact ABB.

### CPTC-02 module replacement

If there is a failure in the CPTC-02 module, you must replace it with a new one. Do not try to repair the module.

### Fault and warning messages

Code (hex)	Name	Cause	Action
<b>Faults</b>			
4990	CPTC-02 not found	Safe motor temperature is enabled (35.31) but the CPTC-02 module is not detected (parameter 15.02 <i>Detected extension module</i> )	Power down the control unit and make sure that the module is correctly inserted in the option slot.

---

## 38 Fault tracing

Code (hex)	Name	Cause	Action
4991	Safe motor temperature	The CPTC-02 module indicates overtemperature. <ol style="list-style-type: none"> <li>Motor temperature is too high, or</li> <li>the thermistor is short-circuited or disconnected.</li> </ol>	<ol style="list-style-type: none"> <li>Make sure that the motor has sufficient cooling.</li> <li>Make sure that the drive and the motor are compatible with each other.</li> <li>Make sure that the motor is not overloaded.</li> <li>Make sure that the drive parameter settings are correct.</li> <li>Examine the wiring of the temperature sensor. If necessary, repair the wiring.</li> <li>Measure the resistance of the sensor. If necessary, replace the sensor.</li> </ol>
5089	SMT circuit malfunction	Safe motor temperature fault (4991) is generated but drive STO is not activated.  <b>Note:</b> If only one STO channel is opened, <i>Safe torque off fault</i> (FA81 or FA82) is generated.	<ol style="list-style-type: none"> <li>Examine the connection between the relay output of the CPTC-02 module and the STO terminal.</li> <li>Examine the CPTC-02 module. If the module is defective, replace it.</li> </ol>
<b>Warnings</b>			
A7AB	Extension I/O configuration failure	Installed option module is not the same as configured by drive parameter.	Make sure that the installed module is of the same type that the drive has detected (parameter <i>15.02 Detected extension module</i> ) and that parameter <i>15.01 Extension module type</i> is set to the correct value.

## LED

The CPTC-02 module has one diagnostic LED.

Color	Description
Green	The module is powered up.

A large, bold, black number '9' is centered within a light grey square with rounded corners.

# Maintenance

---

## Contents of this chapter

This chapter contains information for the maintenance and decommissioning of the safety function.

## Safety circuit maintenance

After the safety function is validated, it must be maintained by periodic proof testing.

If you change the wiring or a component after the start-up, replace a power unit or its circuit boards, replace the CPTC-02 module, modify parameters, or restore parameters to their factory default values:

- Use only ABB-approved spare parts.
- Register the change to the change log for the safety circuit.
- If parameters were restored to the factory default values: Set the parameters related to the safety function.
- Do the validation test of the safety function.
- Document the tests and store the report into the logbook of the machine.

## Proof test

To do a proof test, activate the safety function to make sure that it operates correctly. For guidelines, refer to the validation test procedure.

## Proof test interval

After the operation of the safety function is validated at start-up, the safety function must be maintained by periodic proof testing. In high demand mode of operation, the maximum proof test interval is 20 years. In low demand mode of operation, the

---

maximum proof test interval is 5 or 2 years (high or low demand as defined in IEC 61508 and EN ISO 13849-1). Regardless of the mode of operation, it is a good practice to check the operation of the safety function at least once a year.

The person responsible for the design of the complete safety function should also note the Recommendation of Use CNB/M/11.050 published by the European co-ordination of Notified Bodies concerning dual-channel safety-related systems with electromechanical outputs:

- When the safety integrity requirement for the safety function is SIL 3 or PL e (cat. 3 or 4), the proof test for the function must be done at least every month.
- When the safety integrity requirement for the safety function is SIL 2 (HFT = 1) or PL d (cat. 3), the proof test for the function must be done at least every 12 months.

This is a recommendation and depends on the required (not achieved) SIL/PL. For example, contactors, breakers, safety relays, contactor relays, emergency stop buttons, switches, etc. are typically safety devices which have electromechanical outputs. The CPTC-02 module and the STO circuit of the drive do not have electromechanical outputs.

## Functional safety components

The mission time of functional safety components is 20 years which equals the time during which failure rates of electronic components remain constant. This applies to the components of the standard Safe torque off circuit as well as any modules, relays and, typically, any other components that are part of functional safety circuits.

The expiry of mission time terminates the certification and SIL/PL classification of the safety function. The following options exist:

- Renewal of the whole drive and all optional functional safety module(s) and components.
- Renewal of the components in the safety function circuit. In practice, this is economical only with larger drives that have replaceable circuit boards and other components such as relays.

Note that some of the components may already have been renewed earlier, restarting their mission time. The remaining mission time of the whole circuit is however determined by its oldest component.

Contact your local ABB service representative for more information.

## Competence

The person who does the maintenance and proof test activities of the safety function must be a competent person with expertise and knowledge of the safety function and functional safety, as required by IEC 61508-1 clause 6 and Ex regulations.

## Residual risk

The safety functions are used to reduce the recognized hazardous conditions. In spite of this, it is not always possible to eliminate all potential hazards. Thus, the warnings for the residual risks must be given to the operators.

---



## **Intentional misuse**

The safety circuit is not designed to protect a machine against intentional misuse.

## **Decommissioning**

When you decommission the module, make sure that the safety of the machine is maintained until the decommissioning is complete. Mark clearly on the module that it is decommissioned.

---



# 10

## Technical data

---

### Contents of this chapter

This chapter contains the technical data of the module, gives general rules, notes and definitions related to safety functions and lists the related standards and directives. The safety data, relevant certificates and Declarations of Conformity are also included.

---

## Dimension drawing

The dimensions are shown in millimeters and inches.

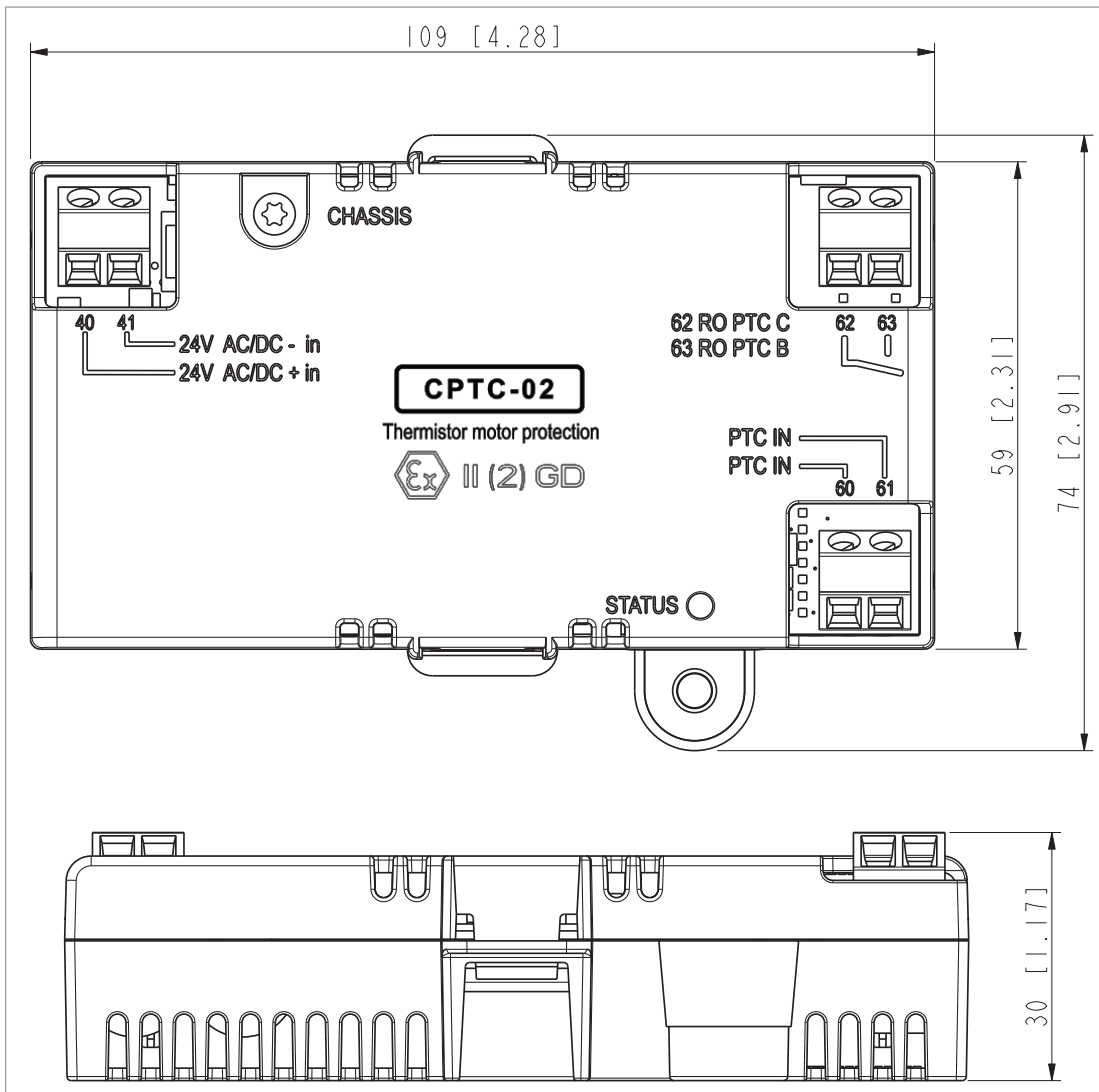

**Installation:** Into Option slot 2 on the drive control unit

**Degree of protection:** IP20

**Package:** Cardboard

## Isolation areas

The following figure shows the different isolation areas of the module.

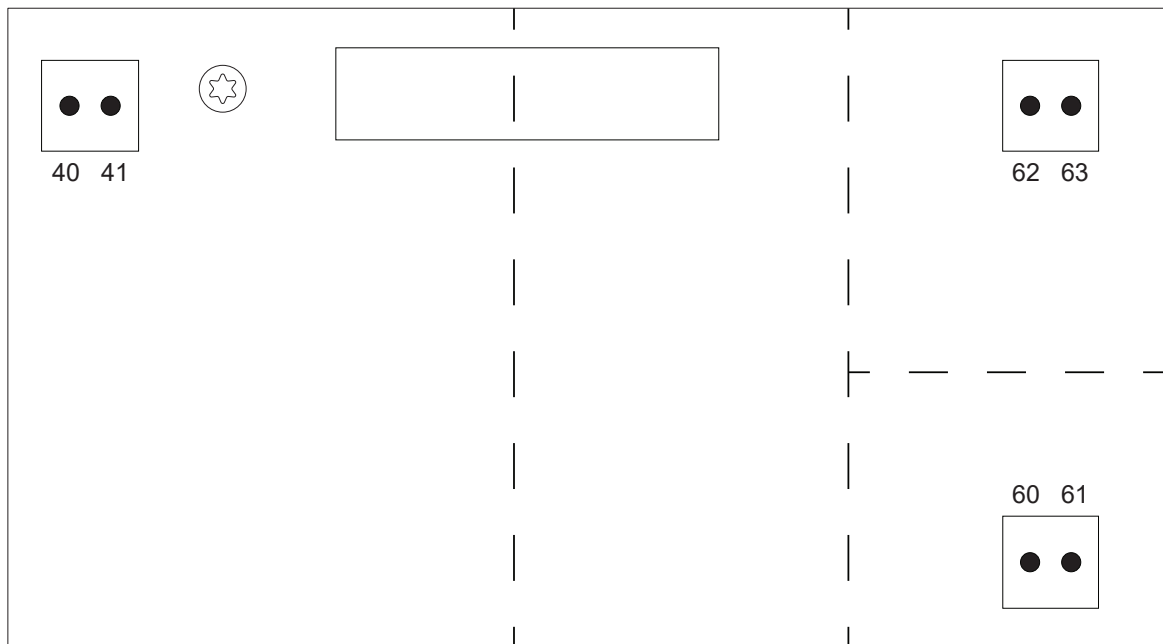

Dashed line: reinforced insulation (IEC 61800-5-1).

## Connections

### ■ Motor thermistor connection (60...61)

- Maximum wire size: 1.5 mm<sup>2</sup> (16 AWG)
- Maximum wire length: 700 m (2300 ft) (1400 m [4600 ft] for the whole loop)  
With the specified cable type, detection of a short-circuited PTC sensor or cable is not guaranteed after 100 m (328 ft).
- Type: Shielded, twisted-pair cable (Draka JAMAK 1×(2+1)×0.5 mm<sup>2</sup> or equivalent)
- Tightening torque: 0.5 N·m (4.4 lbf·in)
- Supported standards: DIN 44081 and DIN 44082
- Number of PTC thermistors: 1...6 in series (in both inputs)
- Triggering threshold: 3.6 kohm ±10%
- Recovery threshold: 1.6 kohm ±10%
- PTC terminal voltage: < 5.0 V
- PTC terminal current: < 1 mA
- Short-circuit detection (start-up and in normal operation): 0 ... 50 ohm, min. 0 ... 10 ohm). For the effect of the cable length, see above.

### ■ Relay output (STO) connection (62...63)

- Maximum wire size: 1.5 mm<sup>2</sup> (16 AWG)
- Maximum wire length: 30 m (98 ft) for the whole loop
- Tightening torque: 0.5 N·m (4.4 lbf·in)

- Maximum contact rating: 250 V AC / 30 V DC / 5 A
- Maximum breaking capacity: 1000 VA
- **External power supply (40...41)**
  - Wire size max. 1.5 mm<sup>2</sup>
  - 24 V AC / DC ±10% (GND, user potential)
  - Maximum current consumption: 25 W, 1.04 A at 24 V DC

## Ambient conditions

For the environmental limits for the safety functions and the drive, refer to the drive hardware manual.

## Safety data

The CPTC-02 module is a type A safety component as defined in IEC 61508-2.

The table gives the safety data for the SMT function. The calculations are based on the worst case data of the drive Safe torque off (STO) function. The given safety data applies with proof test interval T1 = 20 years (high demand and continuous mode of operation) and T1 = 2 years or T1 = 5 years (low demand mode of operation).

SIL	PL	SFF [%]	PFH [1/h] (T1 = 20 a)	PFD <sub>avg</sub> (T1 = 5 a)	PFD <sub>avg</sub> (T1 = 2 a)
2	c	>60	1.43E-08	2.20E-04	1.25E-04
DC [%]	SC	Cat.	HFT	CCF	Mission time [a]
0	2	1	0	N/A	20

3AXD10000473876 J

The MTTFD value (EN ISO 13849-1) of the CPTC-02 module:

- 11386 years (one-channel connection)

## Safety block diagram

The components that are included in the safety data calculations are shown in this safety block diagram. The failure rate of the PTC sensor is not included in the calculations.

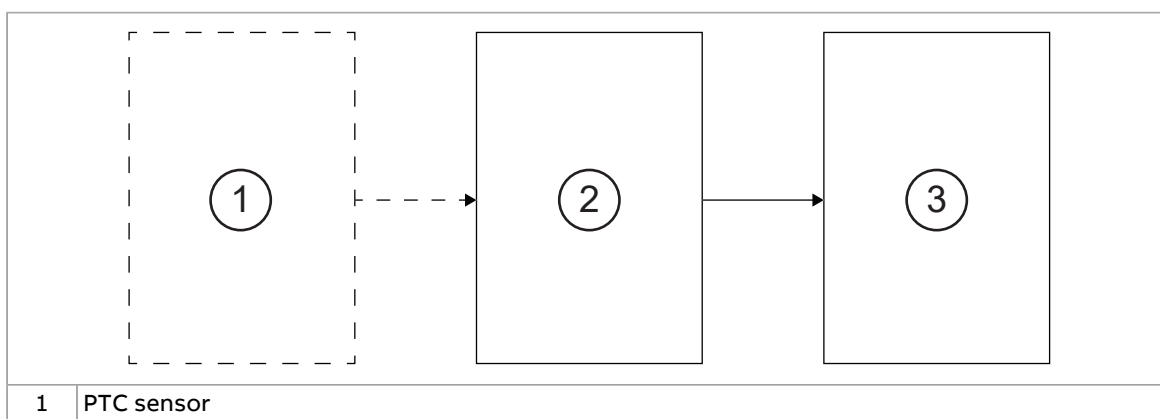

2	CPTC-02 module
3	Drive STO

## Response times

- CPTC-02 module: less than 10 ms
- SMT function: the response time of the PTC sensor + CPTC-02 module (< 10 ms) + drive STO (< 50 ms)

## Relevant failure modes

- The SMT function activates when not necessary (safe failure)
- The SMT function does not activate when requested

A fault exclusion on the failure mode “short-circuit on printed circuit board” has been made (EN 13849-2, table D.5). The analysis is based on the assumption that one failure occurs at one time. No accumulated failures have been analyzed.

The failures of the PTC sensor (thermistor) are not included in the failure analysis. The customer is responsible for the applicability of the PTC element.

## Related standards and directives

<b>EN 50495:2010</b>	Safety devices required for the safe functioning of equipment with respect to explosion risks
<b>IEC 61508:2010</b>	Functional safety of electrical/electronic/programmable electronic safety-related systems. Part 1 – General Requirements Part 2 – Requirements for electrical/electronic/programmable electronic safety-related systems
<b>EN 61800-5-2:2007</b> <b>IEC 61800-5-2:2016</b>	Adjustable speed electrical power drive systems – Part 5-2: Safety requirements – Functional
<b>EN ISO 13849-1:2015</b>	Safety of machinery – Safety-related parts of control systems – Part 1: General principles for design
<b>EN ISO 13849-2:2012</b>	Safety of machinery – Safety-related parts of control systems – Part 2: Validation
<b>EN 60204-1:2018</b> <b>IEC 60204-1:2021</b>	Safety of machinery – Electrical equipment of machines – Part 1: General requirements
<b>IEC 61326-3-1:2017</b>	Electrical equipment for measurement, control and laboratory use – EMC requirements – Part 3-1: Immunity requirements for safety-related systems and for equipment intended to perform safety-related functions (functional safety) – General industrial applications
<b>IEC 61511-1:2017 Ed.2.1</b>	Functional safety – Safety instrumented systems for the process industry sector – Part 1: Framework, definitions, system, hardware and application programming requirements
<b>2006/42/EC</b>	Machinery Directive (EU)
<b>2014/34/EU</b>	ATEX Product Directive (EU)
	Supply of Machinery (Safety) Regulations 2008 (UK)
	The Equipment and Protective Systems Intended for Use in Potentially Explosive Atmospheres Regulations 2016 (+ amendment SI 2019 No. 696) (UK)

## **Compliance with the Machinery Directive (EU)**

The drive is an electronic product which is covered by the Low Voltage Directive. However, the drive internal safety function of this manual (option +L537+Q971) is in the scope of the Machinery Directive as a safety component. This function complies with harmonized standards such as EN 61800-5-2. The declaration of conformity is shown below.

## **Compliance with the Supply of Machinery (Safety) Regulations (UK)**

The drive is an electronic product which is covered by the Electrical Equipment (Safety) Regulations. However, the drive internal safety function of this manual (option +L537+Q971) is in the scope of the Supply of Machinery (Safety) Regulations as a safety component. This function complies with designated standards such as EN 61800-5-2. The declaration of conformity is shown below.

## **Compliance with the ATEX Directive (EU)**

The safety function of this manual (option +L537+Q971) is within the scope of the ATEX product directive 2014/34/EU as a protective system. The function complies with European harmonized standard EN 50495. The declaration of conformity is shown below.

## **Compliance with the UKEX Directive (UK)**

The safety function of this manual (option +L537+Q971) is within the scope of the The Equipment and Protective Systems Intended for Use in Potentially Explosive Atmospheres Regulations 2016 (+ amendment SI 2019 No. 696) as a protective system. The function complies with the designated standard EN 50495. The declaration of conformity is shown below.

---



# Declaration of Conformity (EU)



## EU Declaration of Conformity

ATEX Directive 2014/34/EU and Machinery Directive 2006/42/EC

We

Manufacturer:	ABB Oy
Address:	Hiomotie 13, 00380 Helsinki, Finland.
Phone:	+358 10 22 11

declare under our sole responsibility that the following products:

### Frequency converters/Frequency converter components

With CPTC-02 module:  
 ACS580-01/-04/-07  
 ACH580-01/-31/-34/-04/-07  
 ACQ580-01/-31/-34/-04/-07

identified with serial numbers beginning with 1, 4, 8, M or Y

with regard to the safety function

**ATEX certified thermistor protection (Safe Motor Temperature) (option code +L537 +Q971)**

are in conformity with all the relevant requirements for

(1) protective system of EU Directive for Equipment for Explosive atmospheres 2014/34/EU, and  
 (2) safety component of the EU Machinery Directive 2006/42/EC,  
 when the listed safety function is used for safety component functionality.

### Directive 2014/34/EU

Specific marking of explosion protection



The following harmonized standard has been applied:  
 EN 50495:2010

Safety devices required for the safe functioning of equipment with respect to explosion risks

Notified Body: Eurofins Expert Services Oy, Notified Body number: 0537, Address: Kivimiehentie 4, 02150 Espoo, Finland

has assessed the conformity of the "ATEX certified thermal motor protection" function and has issued the certificate EESF 20 ATEX 051.



**Directive 2006/42/EC**

The following harmonized standards have been applied:

EN 61800-5-2:2007

EN ISO 13849-1:2015

EN ISO 13849-2:2012

EN 60204-1:2018

The following other standards have been applied:

EN 61800-5-2:2017

EN 61508:2010, parts 1-2

Adjustable speed electrical power drive systems – Part 5-2: Safety requirements - Functional  
Safety of machinery – Safety-related parts of control systems. Part 1: General requirements  
Safety of machinery – Safety-related parts of the control systems. Part 2: Validation  
Safety of machinery – Electrical equipment of machines – Part 1: General requirements

Adjustable speed electrical power drive systems – Part 5-2: Safety requirements - Functional  
Functional safety of electrical / electronic / programmable electronic safety-related systems

The product(s) referred in this Declaration of conformity fulfil(s) the relevant provisions of other European Union Directives which are notified in Single EU Declaration of conformity 3AXD10000497690 for ACS580, 3AXD10000497691 for ACH580 and 3AXD10000497692 for ACQ580.

Authorized to compile the technical file: ABB Oy, Hiomotie 13, 00380 Helsinki, Finland.

Helsinki, May 7, 2021

Signed for and on behalf of:

Tuomo Tarula  
Local Division Manager, ABB Oy

Harri Mustonen  
Product Unit Manager, ABB Oy

Document number 3AXD10000495381

If you need the Declaration of Conformity in an official language of the European Union other than English, contact ABB.

# Declaration of Conformity (UK)



## Declaration of Conformity

The Equipment and Protective Systems Intended for Use in Potentially Explosive Atmospheres Regulations 2016 (+ amendment SI 2019 No. 696)

We  
 Manufacturer: ABB Oy  
 Address: Hiomotie 13, 00380 Helsinki, Finland.  
 Phone: +358 10 22 11

declare under our sole responsibility that the following products:

### Frequency converters/Frequency converter components

With CPTC-02 module:  
 ACS580-01/-04/-07  
 ACH580-01/-31/-34/-04/-07  
 ACQ580-01/-31/-34/-04/-07

identified with serial numbers beginning with 1, 4, 8, M or Y

with regard to the safety function

**ATEX certified thermistor protection (Safe Motor Temperature) (option code +L537 +Q971)**

are in conformity with all the relevant requirements for  
 (1) protective system of The Equipment and Protective Systems Intended for Use in Potentially Explosive Atmospheres Regulations 2016 (+ amendment SI 2019 No. 696), and  
 (2) safety component of the the Supply of Machinery (Safety) Regulations 2008, when the listed safety function is used for safety component functionality.

### The Equipment and Protective Systems Intended for Use in Potentially Explosive Atmospheres Regulations 2016 (+ amendment SI 2019 No. 696)

Specific marking of explosion protection

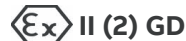

The following designated standard has been applied:  
 EN 50495:2010

Safety devices required for the safe functioning of equipment with respect to explosion risks

Approved Body: Eurofins E&E CML Limited, Approved Body number: 2503, Address: Newport Business Park, New Port Road, CH65 4LZ, Ellesmere Port, United Kingdom

has assessed the conformity of the "ATEX certified thermal motor protection" function and has issued the certificate CML 21 UKEX 9301.



**The Supply of Machinery (Safety) Regulations 2008**

The following designated standards have been applied:  
EN 61800-5-2:2007

EN ISO 13849-1:2015

EN ISO 13849-2:2012

EN 60204-1:2018

The following other standards have been applied:  
EN 61800-5-2:2017

EN 61508:2010, parts 1-2

Adjustable speed electrical power drive systems – Part 5-2: Safety requirements - Functional  
Safety of machinery – Safety-related parts of control systems. Part 1: General requirements  
Safety of machinery – Safety-related parts of the control systems. Part 2: Validation  
Safety of machinery – Electrical equipment of machines – Part 1: General requirements

Adjustable speed electrical power drive systems – Part 5-2: Safety requirements - Functional  
Functional safety of electrical / electronic / programmable electronic safety-related systems

The product(s) referred in this declaration of conformity fulfil(s) the relevant provisions of other UK statutory requirements, which are notified in a single declaration of conformity 3AXD10001325742 for ACS580, 3AXD10001325928 for ACH580 and 3AXD10001326271 for ACQ580.

Authorized to compile the technical file: ABB Limited, Daresbury Park, Cheshire, United Kingdom, WA4 4BT.

Helsinki, May 7, 2021  
Signed for and on behalf of:

Tuomo Tarula  
Local Division Manager, ABB Oy

Harri Mustonen  
Product Unit Manager, ABB Oy

Document number 3AXD10001329542

# ATEX certificate

ATEX certificate for the Safe motor temperature function with the CPTC-02 module and ACx580 drive series (EESF 20 ATEX 051).



**EESF 20 ATEX 051 Issue 1**  
Page 1 of 2

---

**1. EU-TYPE EXAMINATION CERTIFICATE**

**2. Equipment or Protective System Intended for use in Potentially explosive atmospheres  
Directive 2014/34/EU**

3. EU-Type Examination Certificate Number: **EESF 20 ATEX 051 Issue 1**

4. Product: **Thermal motor protection system for converter drive ACS580, ACH580 and ACQ580 series**

Certified types: **ACS580 +L537 +Q971 (CPTC-02)**  
**ACH580 +L537 +Q971 (CPTC-02)**  
**ACQ580 +L537 +Q971 (CPTC-02)**

5. Manufacturer: **ABB Oy Drives**

6. Address: **Hiomotie 13, 00380 Helsinki, Finland**

Additional manufacturing locations:  
**ABB AS, Drives, Aruküla tee 59, Rae vald, 75301 Harjumaa, Estonia**

7. This product and any acceptable variation thereto is specified in the schedule to this certificate and the documents therein referred to.

8. Eurofins Electric & Electronics Finland Oy, Notified Body number 0537, in accordance with Article 17 of Directive 2014/34/EU of the European Parliament and of the Council, dated 26 February 2014, certifies that this product has been found to comply with the Essential Health and Safety Requirements relating to the design and construction of products intended for use in potentially explosive atmospheres given in Annex II to the Directive.

The examination and test results are recorded in confidential report No. EUFI29-23003104-T1.

9. Compliance with the Essential Health and Safety Requirements has been assured by compliance with:  
**EN 50495:2010**

10. If the sign "X" is placed after the certificate number, it indicates that the product is subject to the Specific Conditions of Use specified in the schedule to this certificate.

11. This EU-Type Examination Certificate relates only to the design and construction of the specified product. Further requirements of the Directive apply to the manufacturing process and supply of this product. These are not covered by this certificate.

12. The marking of the product shall include the following:



Espoo, 20.12.2023  
**Eurofins Electric & Electronics Finland Oy**

  
 Kari Koskela  
Senior Expert

  
 Jenni Hirvelä  
Senior Expert

This document is digitally signed.

---



This certificate, including the schedule, may only be reproduced in its entirety and without any change.



Eurofins Electric & Electronics Finland Oy, Kivimiehentie 4, FI-02150 Espoo, Finland  
www.eurofins.fi/electrical-and-electronics

**13. Schedule**
**14. EU-Type Examination Certificate EESF 20 ATEX 051 Issue 1**
**15. Description of Product**

Thermal protection is based on temperature monitoring CPTC-02 module. Safe disconnection is achieved by using "Safe Torque Off "(STO)-function which is integrated in the standard drive as an internal hardware-solution. Power that can cause rotation is not applied to the motor. The safety related part of the adjustable speed electrical power drive system PDS (SR) will not provide energy to the motor which can generate torque. CPTC-02 together with the STO-function comprises the "Safe Motor Temperature" (SMT)-function.

**16. Report Number**

EUF129-23003104-T1

**17. Specific Conditions of Use**

None

**18. Essential Health and Safety Requirements**

Assessment using standard referred in point 9 have confirmed compliance with the Directive 2014/34/EU, Annex II and particular point 1.5.

**19. Drawings and Documents**

FPTC-01/-02, CPTC-02 SMT HW description, 3AXD10000387390, rev D  
 FPTC-01/-02, CPTC-02 Integrated PTC temperature protection module CONCEPT, 3AXD10000381242, rev D  
 ACx580 ATEX schedule drawings with CPTC temperature monitoring, 3AXD10000510416 rev B (4 pages)  
 CPTC-02 Safety data calculation for ACS580/ACH580/ACQ580, 3AXD10000473876, rev J  
 Certificate No. SEBS-A.082710/15 V.2.0 by TÜV Nord  
 Certificate No. SEBS-A.1012331/16 V2.0 by TÜV Nord (ACS580 STO)  
 Certificate No. SEBS-A.1012332/16 V2.0 by TÜV Nord (ACH580 STO)  
 Certificate No. SEBS-A.1012333/16 V2.0 by TÜV Nord (ACQ580 STO)

**20. Certificate History**

Issue	Date	Change
VTT 15 ATEX 051	8.6.2016	Prime certificate
VTT 15 ATEX 051 Issue 1	8.7.2016	The introduction of new converter series type ACQ580
VTT 15 ATEX 051 Issue 2	30.6.2017	Updating of schedule drawings and other documents
EESF 20 ATEX 051	02.06.2021	Updates to documents, improvements to CPTC-module thermistor input and small design changes. Update of the CPTC module TÜV Nord certificate.
EESF 20 ATEX 051 Issue 1	20.12.2023	Update to the safety data calculation. STO certificates by TÜV Nord has been renewed.

# UKEX certificate



**UK Type Examination Certificate CML 21UKEX9301 Issue 1**

**United Kingdom Conformity Assessment**

- 1 Product or Protective System Intended for use in Potentially Explosive Atmospheres UKSI 2016:1107 (as amended) – Schedule 3A, Part 1
- 2 Equipment **Thermal motor protection system for converter drive ACS580, ACH580 and ACQ580 series**  
 Certified types **ACS580 +L537 +Q971 (CPTC-02)  
 ACH580 +L537 +Q971 (CPTC-02)  
 ACQ580 +L537 +Q971 (CPTC-02)**  
 Applicant **ABB Oy Drives**  
 Address **Hiomotie 13,  
 00380 Helsinki,  
 Finland**
- 3 Manufacturer **ABB Oy Drives**      **ABB AS, Drives**
- 4 Address **Hiomotie 13,  
 00380 Helsinki,  
 Finland**      **Aruküla tee 59,  
 Rae vald, 75301 Harjumaa,  
 Estonia**
- 5 The equipment is specified in the description of this certificate and the documents to which it refers.
- 6 Eurofins E&E CML Limited, Newport Business Park, New Port Road, Ellesmere Port, CH65 4LZ, United Kingdom, Approved Body Number 2503, in accordance with Regulation 42 of the Equipment and Protective Systems Intended for Use in Potentially Explosive Atmospheres Regulations 2016, UKSI 2016:1107 (as amended), certifies that this equipment has been found to comply with the Essential Health and Safety Requirements relating to the design and construction of equipment intended for use in potentially explosive atmospheres given in Schedule 1 of the Regulations.  
 The examination and test results are recorded in the confidential reports listed in Section 12.
- 7 If an 'X' suffix appears after the certificate number, it indicates that the equipment is subject to specific conditions of use (affecting correct installation or safe use). These are specified in Section 14.
- 8 This UK Type Examination certificate relates only to the design and construction of the specified equipment. Further requirements of the Regulations apply to the manufacturing process and supply of the product. These are not covered by this certificate.
- 9 Compliance with the Essential Health and Safety Requirements, with the exception of those listed in the confidential report, has been demonstrated through compliance with the following documents:  
 EN 50495:2010
- 10 The equipment shall be marked with the following:  
 Refer to attached certificate EESF 20 ATEX 051, Issue 1 for specific marking of explosion protection symbols.  
 Refer to attached certificate EESF 20 ATEX 051, Issue 1 for marked code and ambient temperature range.



This certificate shall only be copied in its entirety and without change  
[www.CMLEx.com](http://www.CMLEx.com)

  
 S. Roumbedakis  
 Technical Manager



CML 21UKEX9301  
Issue 1

#### 11 Description

For product description refer to attached certificate EESF 20 ATEX 051, Issue 1.

#### Variation 1

This variation introduced the following modification:

- i. Update to the safety data calculation. STO certificates by TÜV Nord has been renewed.

#### 12 Certificate history and evaluation reports

Issue	Date	Associated report	Notes
0	21 Jun 2021	R14004D/00	Issue of the prime certificate. EESF 20 ATEX 051, Issue 0 is attached and shall be referred to in conjunction with this certificate.
1	16 Jan 2024	R17302D/00	Issue of the variation certificate. EESF 20 ATEX 051, Issue 1 is attached and shall be referred to in conjunction with this certificate.

Note: Drawings that describe the equipment are listed or referred to in the Annex.

#### 13 Conditions of Manufacture

For conditions of manufacture, refer to attached certificate EESF 20 ATEX 051, Issue 1.

Any routine tests/verifications required by the ATEX certification shall be conducted.

#### 14 Specific Conditions of Use

For specific conditions of use, refer to attached certificate EESF 20 ATEX 051, Issue 1.



# TÜV Nord certificate

The TÜV Nord certificate for the CPTC-02 module and ACx580 drive series is shown below.



## Certificate

No. SEBS-A.082710/15, V2.0

TÜV NORD Systems GmbH & Co. KG here by certifies to

**ABB Oy**  
Hiomotie 13  
00381 Helsinki  
Finland

that the

**CPTC-02**

**as a plug-in module for the ABB industrial drive ACx580 series**

**with the safety function Safe Motor Temperature (SMT) meets the requirements listed in the following standards**

---

- IEC 61508-1 / -2: 2010, capable up to SIL 2
- IEC 61800-5-2: 2016, capable up to SIL 2
- ISO 13849-1 / -2: 2015 / 2012, capable up to PL c

---

Certificationprogram Leittechnik (SEB-ZE-SEECERT-VA-320-20, Rev. 5.1/4.19)

Base of certification is the report SEBS-A.082710/15TB in the valid version.

This certificate entitles the holder to use the pictured safety approved mark.

Valid until: 01-06-2026  
File reference: 8118123960

Hamburg, 01-06-2021



Bianca Pfuff



Certification Body SEECERT  
TÜV NORD Systems GmbH & Co. KG  
Große Bahnstraße 31, 22525 Hamburg, Germany



---

# Further information

## Product and service inquiries

Address any inquiries about the product to your local ABB representative, quoting the type designation and serial number of the unit in question. A listing of ABB sales, support and service contacts can be found by navigating to [www.abb.com/contact-centers](http://www.abb.com/contact-centers).

## Product training

For information on ABB product training, navigate to [new.abb.com/service/training](http://new.abb.com/service/training).

## Providing feedback on ABB manuals

Your comments on our manuals are welcome. Navigate to [new.abb.com/drives/manuals-feedback-form](http://new.abb.com/drives/manuals-feedback-form).

## Document library on the Internet

You can find manuals and other product documents in PDF format on the Internet at [www.abb.com/drives/documents](http://www.abb.com/drives/documents).



[www.abb.com/drives](http://www.abb.com/drives)



3AXD50000030058F