

**General Notes:**

PCM600 ACT (Application Configuration Tool) logic is shown in default state.

**Notes:**

1. Latched pushbutton switch emulates drop down menu for "IG/IO Signal Sel" parameter in PCM600. Switch position shown for default setting (Meas Io). Switch is typical for all connected functions. Position can be set individually for each function.
2. Rotary switch emulates drop down menu for "Pol Signal Sel" parameter setting in PCM600. Switch position shown for default setting (Neg Seq Volt). "Pol Signal Sel" parameter setting "Calc Vo" not applicable for open delta connected VTs.

REM615\_HAMFFAFAFFE1BNN1XE

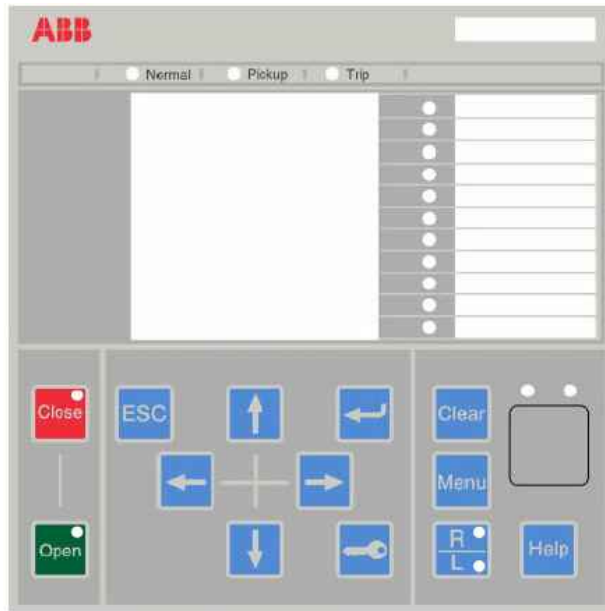

FT-1/TS1  
Style No: 837A407G01  
Code No: 083

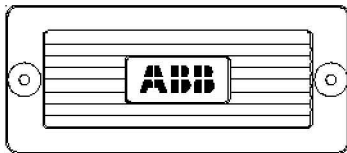

FT-1/TS2  
Style No: 129A501G01  
Code No: 001

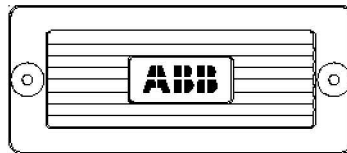

FT-1/TS3  
Style No: 129A501G01  
Code No: 001

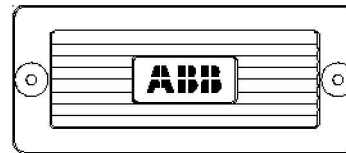

PHASE CURRENT ■ (IA)  
PHASE CURRENT ■ (IB)  
PHASE CURRENT ■ (IC)  
GROUND CURRENT ■ (IG)  
RELAY POS.VDC  
RELAY NEG. VDC

PHASE VOLTAGE ■ (VA)  
PHASE VOLTAGE ■ (VB)  
PHASE VOLTAGE ■ (VC)

52-1\_EXE\_CL (PO1)  
50BF\_TRBU (PO2)  
86\_94-1\_TRIP/52-1\_EXE\_OP (PO3)  
86\_94-2\_TRIP (PO4)  
TRIP\_MOTOR\_STATOR (SO1)  
TRIP\_MOTOR/LOAD\_BEARING (SO2)  
EMERGENCY\_START\_ENABLE (IN6)  
CB\_POSITION\_CLOSE (IN7)  
CB\_POSITION\_OPEN (IN8)

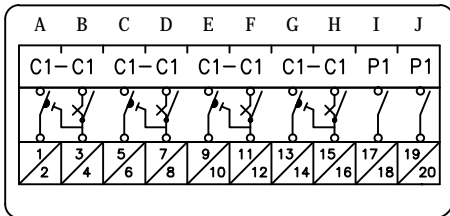

(CURRENTS AND POWER SUPPLY)

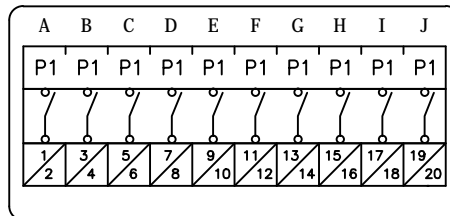

(POTENTIALS)

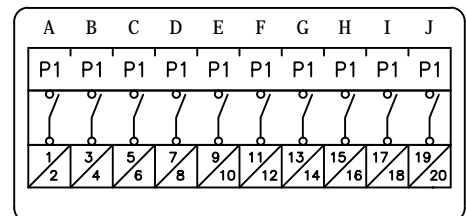

(BINARY I/O)

**General Notes:**

1. Style and code numbers for FT-1 switches provide black covers and handles, screw terminals and standard depth. Poles selection follows arrangement shown in this drawing set. For custom designs, different selection options can be made by using FT-1 configurator at [ft1switch.com](http://ft1switch.com).
2. Refer to 615 series ANSI Installation Manual for relay and cutout dimensions ( Document ID: MACCO51065-MB, Revision: D, Product version 4.0)

REM615\_HAMFFAFAFFE1BNN1XE

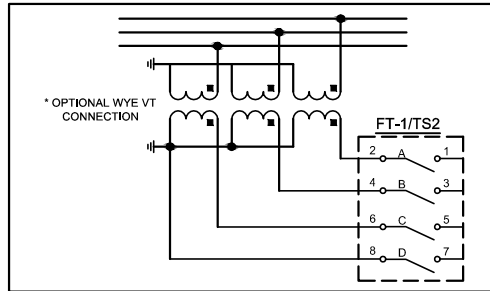
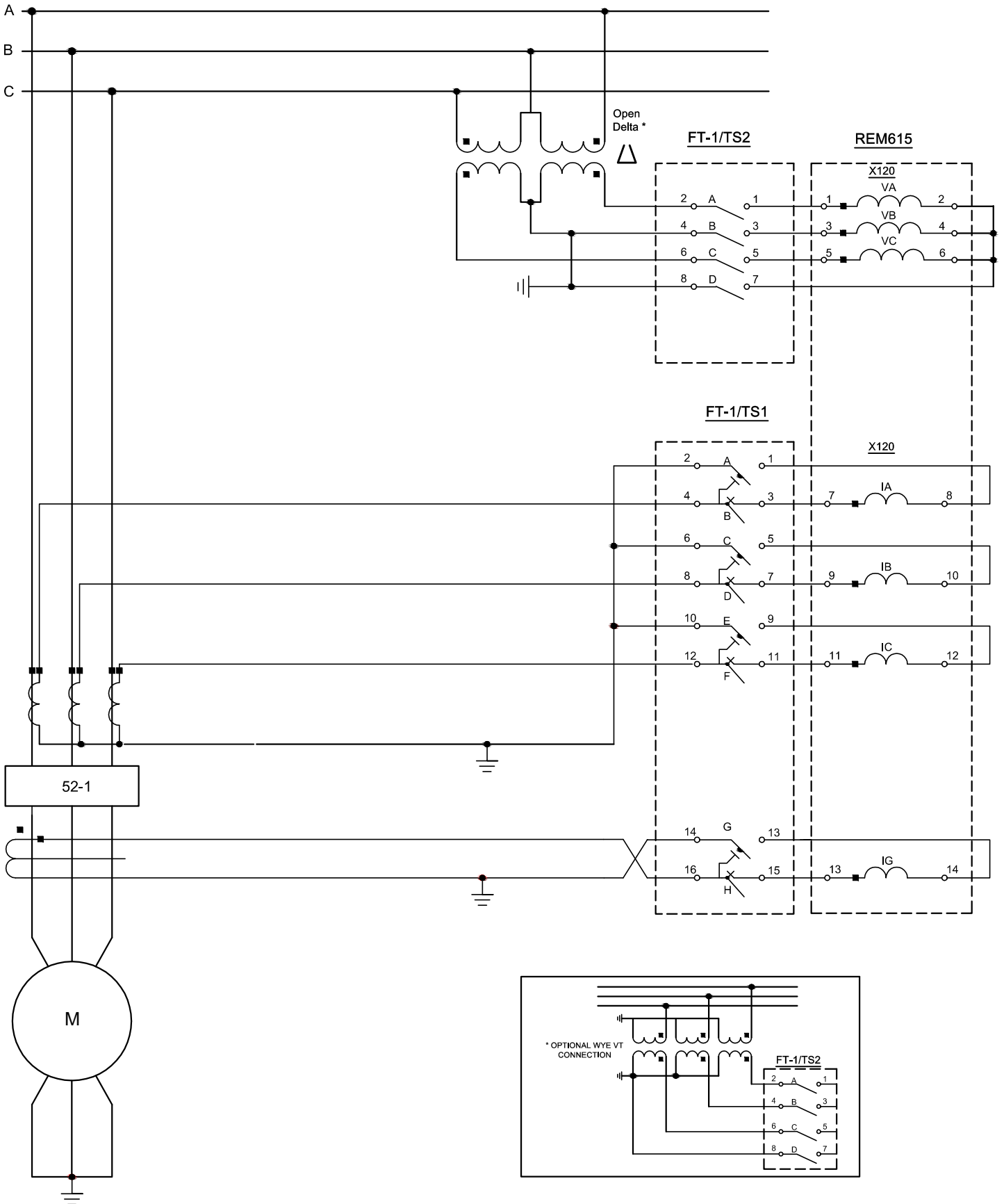

REM615\_HAMFFAFAFFE1BNN1XE

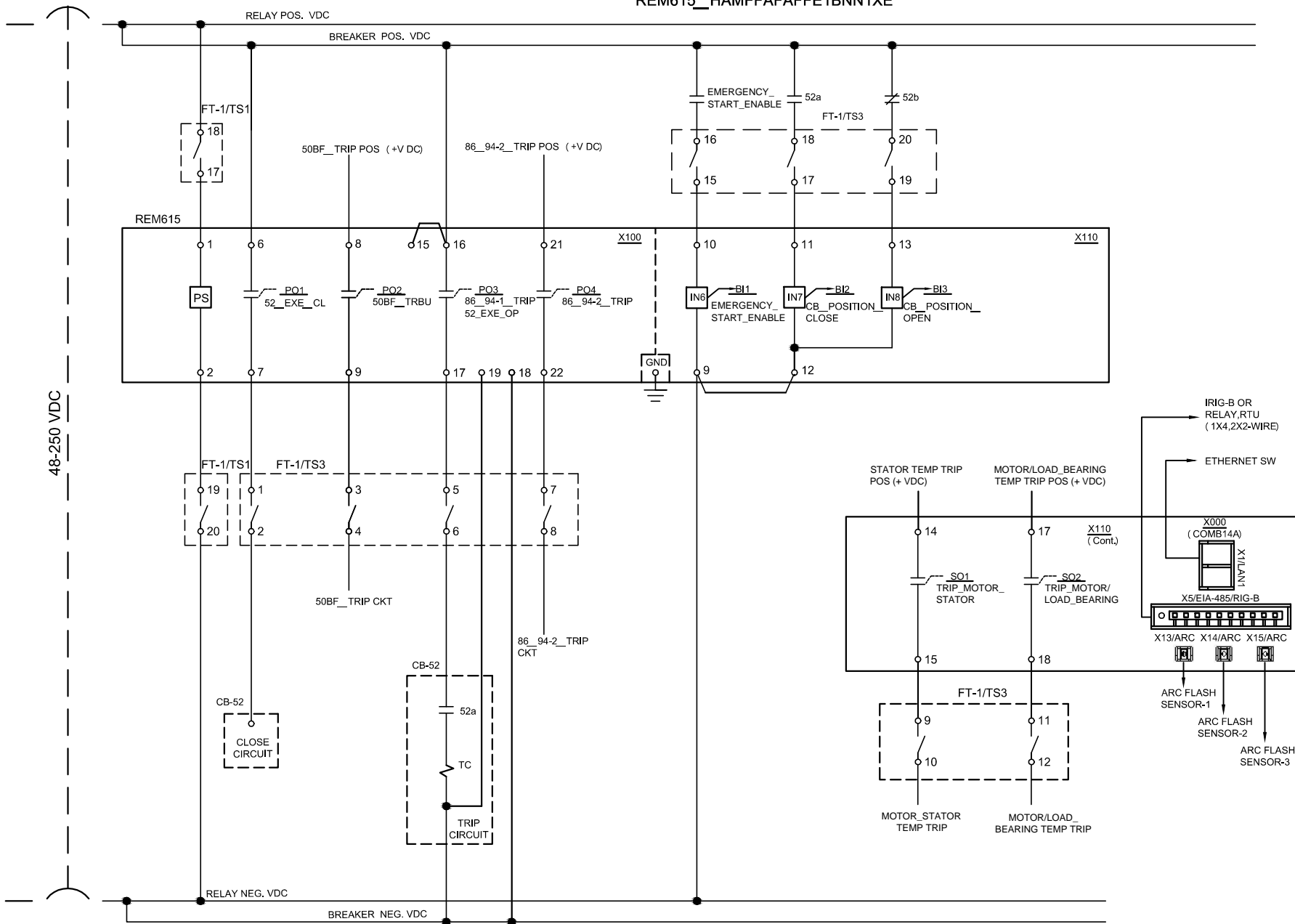

**General Notes:**

1. Binary I/O shown is from default PCM600 Application Configuration Tool (ACT) .
2. Connections shown are typical though more connections may be needed for specific application.

REM615\_HAMFFAFAFFE1BNN1XE

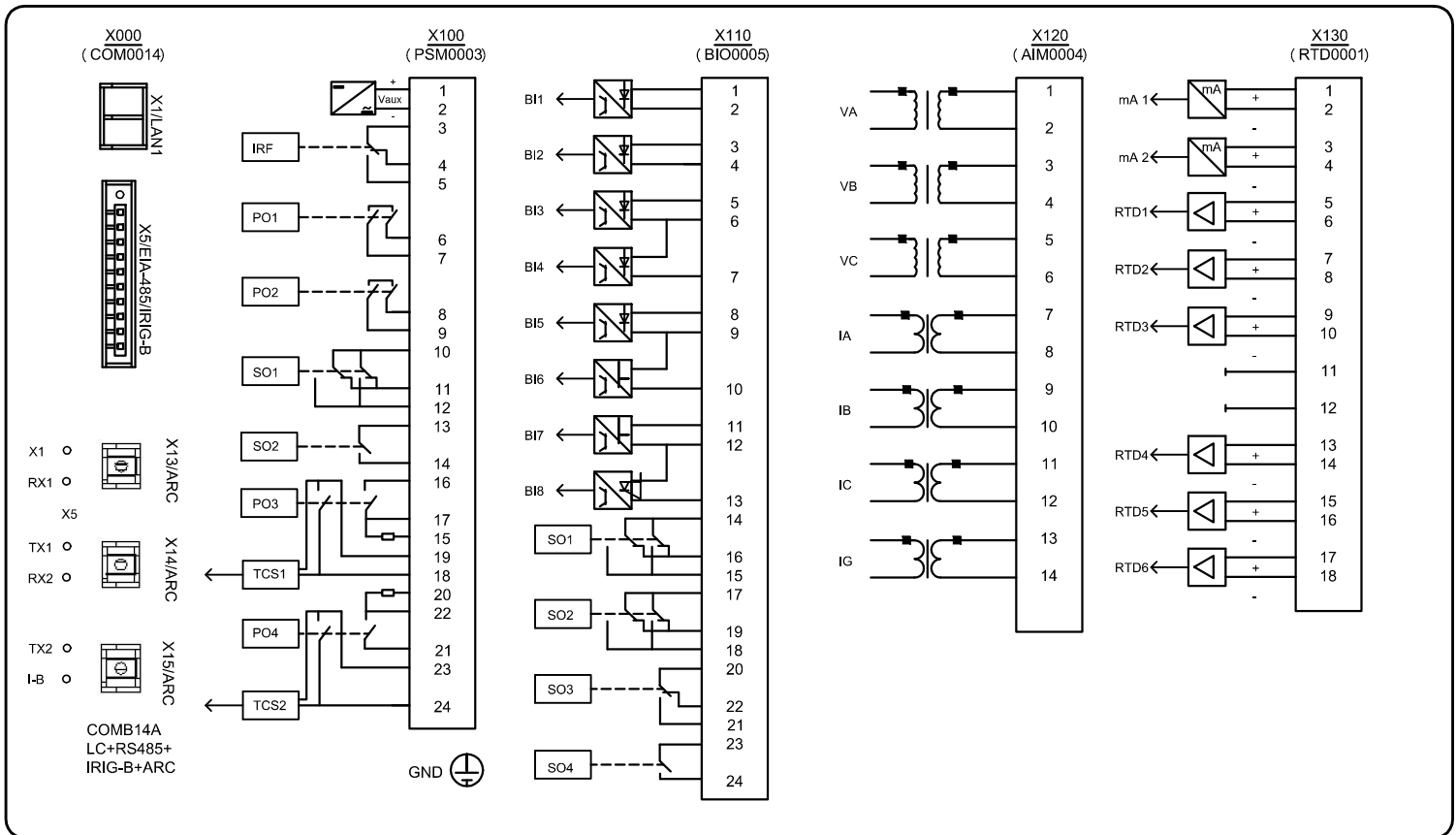

RR  
REM615

X000-X1:  
X000-X5:  
X000-X13:  
X000-X14:  
X000-X15:

X100-1: UU17  
X100-2: UU19  
X100-3:  
X100-4:  
X100-5:  
X100-6:  
X100-7: SS1  
X100-8:  
X100-9: SS3  
X100-10:  
X100-11:  
X100-12:  
X100-13:  
X100-14:  
X100-15: X100-16  
X100-16: X100-15  
X100-17: SS5  
X100-18:  
X100-19:  
X100-20:  
X100-21:  
X100-22: SS7  
X100-23:  
X100-24:

X110-1:  
X110-2:  
X110-3:  
X110-4:  
X110-5:  
X110-6:  
X110-7:  
X110-8:  
X110-9: X110-12  
X110-10: SS15  
X110-11: SS17  
X110-12: X110-9  
X110-13: SS19  
X110-14:  
X110-15: SS9  
X110-16:  
X110-17:  
X110-18: SS11  
X110-19:  
X110-20:  
X110-21:  
X110-22:  
X110-23:  
X110-24:

X120-1: TT1  
X120-2: X120-4  
X120-3: TT3  
X120-4: X120-2, X120-6  
X120-5: TT5  
X120-6: X120-4, TT7  
X120-7: UU3  
X120-8: UU1  
X120-9: UU7  
X120-10: UU5  
X120-11: UU11  
X120-12: UU9  
X120-13: UU15  
X120-14: UU13

X130-1:  
X130-2:  
X130-3:  
X130-4:  
X130-5:  
X130-6:  
X130-7:  
X130-8:  
X130-9:  
X130-10:  
X130-11:  
X130-12:  
X130-13:  
X130-14:  
X130-15:  
X130-16:  
X130-17:  
X130-18:

GND:

RR\_X110-13  
RR\_X110-11  
RR\_X110-10  
RR\_X110-18  
RR\_X110-15  
RR\_X100-22  
RR\_X100-17  
RR\_X100-9  
RR\_X100-7

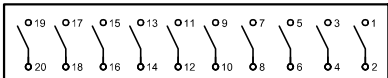

RR\_X120-6  
RR\_X120-5  
RR\_X120-3  
RR\_X120-1

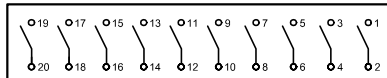

RR\_X100-2  
RR\_X100-1  
RR\_X120-13  
RR\_X120-14  
RR\_X120-11  
RR\_X120-12  
RR\_X120-9  
RR\_X120-10  
RR\_X120-7  
RR\_X120-8

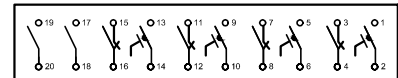

UU6  
UU2, UU10  
UU6