

Digital Indicator DS 96/48 P

Digital Indicator DS 96/48 PK

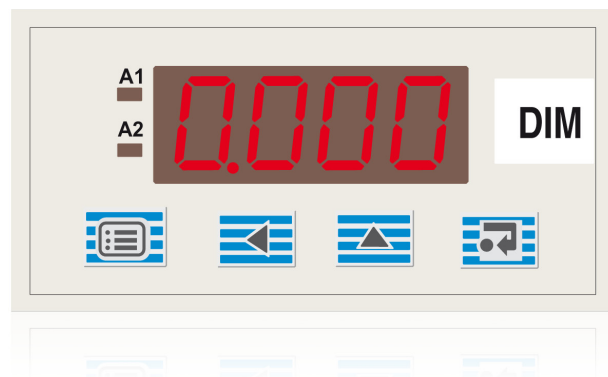

Inputs

- Direct current, direct voltage
- Thermocouple
- Resistance thermometer

Programmable via front keys or PC software

RS 232 interface

Limit contacts

LED technology, changeable brightness

Minimum/maximum storage

Technical data

Indication

Display
 LED; color red; 13 mm character size

Maximum reading
 ± 1999 Digit at DS 96/48 P
 -1999...9999 Digit at DS 96/48 PK

Readout overflow
 „OFL“

Measuring range overflow
 „Err“

Decimalpoint position
 programmable (not for temperature inputs)

Measuring cycle
 0.2...9.9 s

Deviation
 DS 96/48 P: 0.1 % of measuring value ± 1 digit at 23 °C
 DS 96/48 PK: 0.05 % of measuring value ± 1 digit at 23 °C

Display alarms
 2 x LED; A1, A2, alternatively min. or max.
 Hysteresis, response time programmable

Display control

Last digit of display
 2-steps, 5-steps, fixed 0, last digit off

Complete indication
 optional hold or display blanking, segment test

Min./max. storage standard

Input

at DS 96/48 P

Current, voltage
 ± 2 mA...200 mA DC, ± 0.2 V...50 V DC

Input resistance
 100 Ω at 20 mA, > 150 kΩ at 2 V

at DS 96/48 PK

Current: -40 mA...+200 mA DC, min. span 2 mA

Voltage
 -10 V...+50 V DC, min. span 0,2 V

Input resistance
 100 Ω at 20 mA, > 150 kΩ at 2 V

Resistance thermometer
 2-, 3-, 4-wire circuit adjustable via menu
 Pt 100 DIN -199.9...+850.0 °C
 Ni 100 DIN -60.0...+180 °C

Thermocouple

J, K, R, S, B, E, L, T, U, N (programmable via PC;
 in preparation)

Reference junction internal or external
 0...50 °C (programmable via PC; in preparation)

Power supply

DC voltage
 18...32 V DC, approx. 1.8 W

AC voltage
 24/115/230 V AC, 50...60 Hz, approx. 3 VA

Environmental capabilities

Working temperature: 0...50 °C
 Storage temperature: -25...+65 °C
 Relative humidity: 75 % annual average, no condensation

Housing

Dimension (W x H x D)
 96 mm x 48 mm x 130 mm

Panel cutout
 92 mm^{+0.8 mm} x 45 mm^{-0.5 mm}

Material: plastic ABS

Type of protection: case IP 52, terminals IP 20

Weight: approx. 0.4 kg

Connection
 Plug-in screw terminals for 1.5 mm²

Standards

EMV, safety data
 EN 55011-B, EN 61010-1, EN 50082-1

Options

Transmitter supply
 24 V DC, max. 25 mA unregulated

2 alarm relays A1, A2
 Relay output 4 A, 250 V
 NO or NC operation
 assigned to LED A1, A2

Interface (in preparation)
 RS 232 for configuration and viewing of values and parameters
 (at DS 96/48 P = optional; at DS 96/48 PK = standard)

Connection diagram at DS 96/48 P

1 Tx (serial interface)	11 Transmitter supply (+)
2 Rx (serial interface)	12 Transmitter supply (-)
3 Segment test	13 A1 common
4 Hold/Blanking	14 open
5 Programming disable	15 closed
6 Digital Gnd (terminals 1...5)	16 A2 common
7 Input: U (+)	17 open
8 Input: (-)	18 closed
9 Input: I (+)	19 N, DC (-)
10 free	20 L1, DC (+)

Connection diagram at DS 96/48 PK

1 Tx (serial interface)	11 Transmitter supply (+)
2 Rx (serial interface)	12 Transmitter supply (-)
3 Segment test	13 A1 common
4 Hold/Blanking	14 open
5 Programming disable	15 closed
6 Digital Gnd (terminals 1...5)	16 A2 common
7 Input: U(+), TC(+), Pt100 (I-)	17 open
8 Input: U(-), I(-), TC(-), Pt100 (U-)	18 closed
9 Input: I(+), Pt100 (U+)	19 N, DC (-)
10 Input: Pt100 (I+)	20 L1, DC (+)

Technical data

Dimensional drawing
(dimensions in mm)

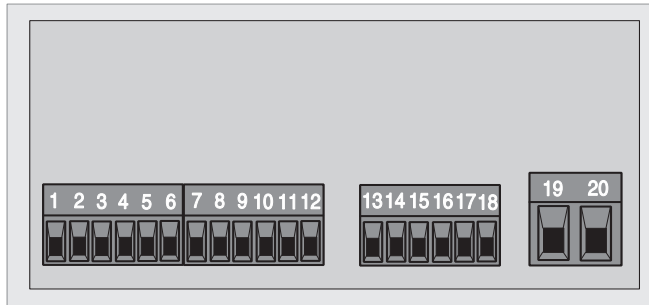
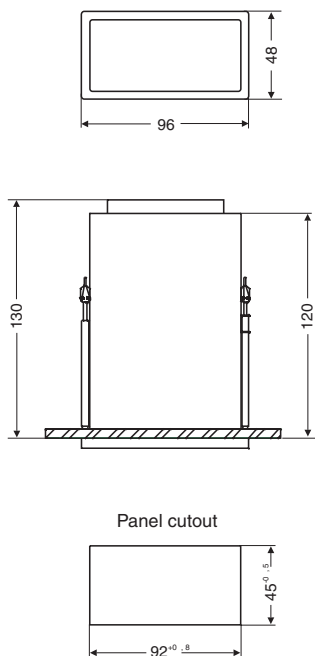

Back view of instrument

Connection diagram

Power supply

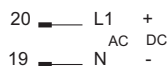

Measuring input
Voltage

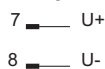

Limit value 1
(option)

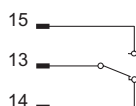

Thermocouple

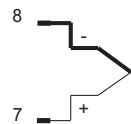

Segment test



Current



Limit value 2
(option)



Resistance thermometer Pt 100 / Ni 100

2-wire

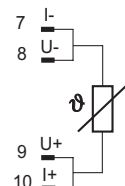

Display storage
(Hold)



Transmitter
supply (option)

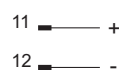

3-wire

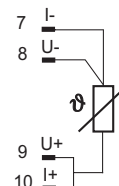

Display blanking



Analogue output
(option)

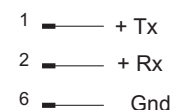

4-wire

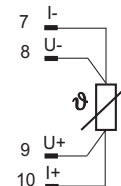

Relay contact positions are shown for de-energized state.

Ordering information												
										Catalog No		Code
Digital Indicator DS 96/48 P or DS 96/48 PK										V33264A-		
Instrument type												
DS 96/48 P (3 ¹ / ₂ digits: ±1999)										1		
DS 96/48 PK (4 digits: -1999 bis +9999)										2		
Measuring range (DS 96/48 P)												
0...2 V DC										1	1	0
0...20 V DC										1	2	0
0...2 mA DC										1	3	0
0...20 mA DC										1	4	0
4...20 mA DC										1	5	0
other range (specify code no. 300)										1	6	0
Measuring range (DS 96/48 PK)												
0...2 V DC										2	1	0
0...20 V DC										2	2	0
0...2 mA DC										2	3	0
0...20 mA DC										2	4	0
4...20 mA DC										2	5	0
other range (specify code no. 300)										2	6	0
Pt 100 -199,9 ... +850,0 °C										2	7	
Ni 100 -60,0 ... +180,0 °C										2	8	
Type J -210 ... +1200 °C										2	J	
Type K -250 ... +1372 °C										2	K	
Type R -50 ... +1769 °C										2	R	
Type S -50 ... +1769 °C										2	S	
Type B +200 ... +1820 °C										2	B	
Type E -100,0 ... +999,9 °C										2	E	
Type L -100,0 ... +900,0 °C										2	L	
Type T -140,0 ... +400,0 °C										2	T	
Type U -199,9 ... +600,0 °C										2	U	
Type N -250 ... +1300 °C										2	N	
Reference junction (only thermocouples)												
not applicable										0		
internal										1		
external 0 °C (32 °F)										2		
external 20 °C (68 °F)										3		
external 50 °C (122 °F)										4		
Decimal point (fixed with DS 96/48 PK with temperature input)												
without										0		
000,0										1		
00,00										2		
0,000										3		
Transmitter power supply												
without										0		
with										1		
Alarm relays												
without										0		
2 alarm relays										1		
Display control												
hold										1		
blanking										2		
Power supply												
230 V AC										1		
115 V AC										2		
24 V AC										3		
24 V DC										4		
RS 232 interface (with DS 96/48 PK standard)												
without										0		
with (in preparation)										1		

Continue see next page

Continue ordering information												
										Catalog No		Code
Digital Indicator DS 96/48 P or DS 96/48 PK										V33264A-		
Front frame												
RAL 9002 ABB-Design (lightgrey)										1		
RAL 9005 (black)										2		
Dimensions												
without										0		
according table (specify code no. 400)										4		
on demand (specify code no. 500)										5		
Manual (supplied copy)												
German										D		
English										E		
Further ordering information												
Measuring range in clear, max. ± 200 mA, max. ± 50 V										300		
Dimensions according table, distinguishing tags s. b.										400		
Dimensions on demand, in clear, max. 5 digits										500		
Additional Operating Manuals												
German										Z2D		
English										Z2E		

¹⁾ 1 copy in German included in the basic supply; no specification required; extra Operating Manuals must be paid (please specify number)

Dimensional labelling													
Code	Code	Code	Code	Code	Code	Code	Code	Code	Code	Code	Code		
	kW	06	A	12	MN	18	m ³	24	N	30	ppm	36	
V	01	MW	07	mA	13	%	19	g	25	bar	31	K	37
mV	02	Ω	08	μA	14	‰	20	kg	26	m/min	32	l/h	38
kV	03	mΩ	09	°C	15	cm	21	t	27	U/min	33	t/h	39
mW	04	kΩ	10	°∠	16	mm	22	m ³ /h	28	δ	34	Hz	40
W	05	MΩ	11	kN	17	m	23	pH	29	mbar	35		

Contact us

ABB Ltd.

Process Automation

Howard Road, St. Neots
Cambridgeshire, PE19 8EU
UK

Phone: +44 (0)1480 475321

Fax: +44 (0)1480 217948

ABB Inc.

Process Automation

125 E. County Line Road
Warminster PA 18974
USA

Phone: +1 215 674 6000

Fax: +1 215 674 7183

ABB Automation Products GmbH

Process Automation

Borsigstr. 2
63755 Alzenau
Germany

Phone: +49 551 905-534

Fax: +49 551 905-555

www.abb.com

Note

We reserve the right to make technical changes or modify the contents of this document without prior notice. With regard to purchase orders, the agreed particulars shall prevail. ABB does not accept any responsibility whatsoever for potential errors or possible lack of information in this document.

We reserve all rights in this document and in the subject matter and illustrations contained therein. Any reproduction, disclosure to third parties or utilization of its contents – in whole or in parts – is forbidden without prior written consent of ABB.

Copyright© 2011 ABB

All rights reserved

3KXJ300003R1001

10/33-2.16-EN.01.2011