

—
USER MANUAL

Terra DC wallbox

User and Operation Manual



Notice

This document contains information about one or more ABB products and may include a description of or a reference to one or more standards that may be generally relevant to the ABB products. The presence of any such description of a standard or reference to a standard is not a representation that all of the ABB products referenced in this document support all of the features of the described or referenced standard. In order to determine the specific features supported by a particular ABB product, the reader should consult the product specifications for the particular ABB product.

ABB may have one or more patents or pending patent applications protecting the intellectual property in the ABB products described in this document.

The information in this document is subject to change without notice and should not be construed as a commitment by ABB. ABB assumes no responsibility for any errors that may appear in this document.

In no event shall ABB be liable for direct, indirect, special, incidental or consequential damages of any nature or kind arising from the use of this document, nor shall ABB be liable for incidental or consequential damages arising from use of any software or hardware described in this document.

This document and parts thereof must not be reproduced or copied without written permission from ABB, and the contents thereof must not be imparted to a third party nor used for any unauthorized purpose.

Copyrights

All rights to copyrights, registered trademarks, and trademarks reside with their respective owners.

Copyright © 2019 ABB.

Contents

Glossary	4
1. Introduction	5
Signs	6
Safety regulations	6
2.1. Overview of the system	8
2.2. MID certified Charger identification.....	9
2.3. Energy Meter Readout:.....	9
2.4. Charger configurations.....	9
2.5. Standard usage.....	10
2.6. Authorization to charge.....	11
2.7. Output Power vs. Output Voltage curve.....	11
3. Quick instruction charging	12
4. Operator Instructions	17
4.1. Cleaning of the Terra DC Wallbox.....	17
4.2. Service inspection of the cabinets	18
4.2.1. Special inspections	18
4.3. Problem resolving.....	18
4.3.1. Overview of the WallBox	19
4.4. Troubleshooting	20
4.5. Recommended Preventive maintenance	20
5. Contact information	20

Glossary

AC

Alternating Current.

CCS

Combined Charging System. A universal AC and DC charging system

CHAdeMO

DC fast charging method for electric vehicles.

DC

Direct Current.

EV

Electric Vehicle.

HMI

Human Machine Interface; the screen on the charger.

Owner

The legal owner of the charger.

OCPP

Open Charge Point Protocol. Open standard for communication with charge stations.

PE

Ground.

RCBO

Residual-current Circuit Breaker with Overload protection. Breaks the connection if a residual current or overload is detected.

RCD

Residual Current Device. Breaks the connection if a residual current is detected.

RFID

Radio-Frequency Identification. is a communication technology that utilizes the radio frequency electromagnetic waves to transfer data over a very short distance between the reader and an electronic tag or card.

Site operator

Person or company that controls the charge station. The site operator could be the owner, but not necessarily.

User

The driver of an EV who uses the charge station.

1. Introduction

1.1. Preface

The Terra DC Wallbox Charge Stations are easy to install DC fast chargers for electric vehicles. Fast chargers are electrical installations with high electric currents.

This manual describes the general usage and daily operation instructions of the Terra DC Wallbox charging station.

1.2. Intended use of this document

This document serves:

- As a reference for site operators who are responsible for the charger's operation on site, performing daily inspection and maintenance activities and who are able to perform simple trouble shooting activities, after instruction of a certified ABB technician.
- As a reference to the operator's customers, the EV drivers who will mainly use the pictograms and texts on the display of the charger. The user interface design was thoroughly evaluated with user groups to optimize understandability and to get the best user experience. Besides the screens needed for the charging process, the interface has help screens available to provide additional information.

1.3. Intended use of the charger

The Terra DC Wallbox charger consists of the at least one power cabinet. The outlets of the cabinet are solely used to charge electric vehicles that are compatible with the supported charging standards.

1.4. Owner responsibilities

The owner and site operator are required:

- To prepare the site where the charging station will be installed, according to the requirements described in this guide.
- To make sure that there is enough space around the charger to carry out maintenance work.
- To make sure all protective devices are correctly installed after carrying out installation or maintenance.
- To operate the charging station with the protective devices installed.
- To write an emergency plan that instructs people what to do in case of emergency.
- To appoint a person responsible for the safe operation of the charging station and for the coordination of all work. This person should be properly instructed by ABB or an ABB trained service partner.

The owner is cautioned that changes or modifications not expressly approved by ABB could void the owner's authority to operate the equipment or ABB's warranty. Neither ABB nor its affiliates shall be liable to the purchaser of this product or third parties for damages, losses, costs or expenses incurred by purchaser or third parties as a result of: an accident, misuse or abuse of this product, or unauthorized modifications, repairs or alterations to this product, or failure to strictly comply ABB operating and maintenance instructions.

Signs

The following signs are used on the equipment and in this manual:



DANGER

Hazardous voltage

Identifies a hazard that could result in severe injury or death through electrocution.



WARNING

Various

Identifies a hazard that could result in severe injury or death as also damage to the machine, other equipment, and/or environmental pollution.



WARNING

Pinch Hazard

Identifies a hazard that could result in injuries, in which some body parts are pinched or crushed.



NOTICE

Contains remarks, suggestions or advice.

Safety regulations



WARNING

If a charging outlet is damaged, take the following steps:

1. Do not use the damaged charging outlet.
2. Contact the owner / site operator.



WARNING

Operation after damage or accidents

- If there is a fire in or nearby the charger;
- If the charger was immersed in water, or any other fluid;
- If the charger is damaged in any way.

Do not use the charger. Contact the owner / site operator.



CAUTION
Connector locked

Do not apply a force on the locked cable during the charging process. This might damage the inlet and locking mechanism in the car or damage the charger.



NOTICE
When connecting or disconnecting a connector

1. Handle cables and connectors with care. Do not drop the cables or connectors. Place them back in their respective holders.

Only insert a connector into a suitable car inlet. Never use excessive force.



CAUTION
No User serviceable parts inside

Do not allow any user to repair or manage the electronics inside.

2. Description of the product

2.1. Overview of the system

The user operated components are indicated on Figure 1.

- A. Display / HMI.
- B. RFID card reader.
- C. Charging outlets DC.
- D. Air outlet
- E. Emergency button
- F. AC input cable
- G. Air inlet

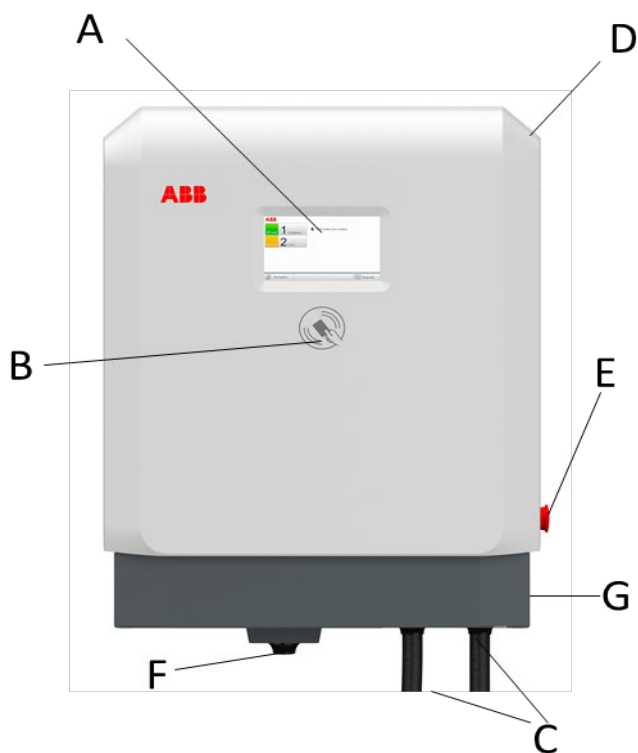

Figure 1: Terra DC Wallbox Charger view

The charger can be equipped with two DC charging cables with CCS or CHAdeMO connector or only with the CCS one.

2.2. MID certified Charger identification

The nameplate contains all information relating to the Deutsche Messe EV regulation for the measuring device calibration law. This is a field-installable upgrade. To recognize if a charger is compliance to MID Directive, Check the charger label. The product compliance is indicated by the info showed in the Highlighted box

The Label reports all the necessary info to be compliance to 2014/32/EU MID directive.

2.3. Energy Meter Readout:

A. Time (hh:mm:ss)

B. Date (YY-MM-DD)

C. Delivered DC power (kWh)

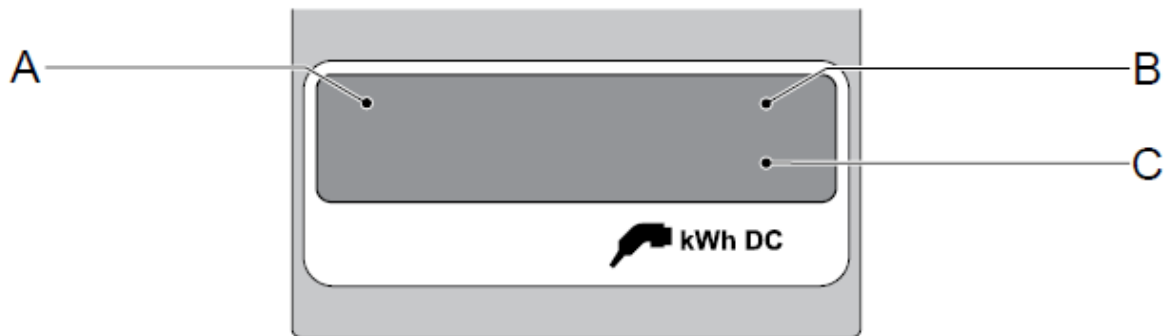

- Charger registration to the Federal authority:
 - https://www.bundesnetzagentur.de/DE/Sachgebiete/ElektrizitaetundGas/Unternehm_en_Institutionen/HandelundVertrieb/Ladesaeulen/Anzeige_Ladepunkte_node.html
- Section 31-33 MessEG :
 - MessEG is published on: <https://www.gesetze-im-internet.de/messeg/index.html> (directly to standard link)

2.4. Charger configurations

Terra DC Wallbox Charger supports the following DC charging standards:

Indicator	Description
CJ	One CCS and one CHAdeMO outlets up to 60 A / 22.5 kW; No simultaneous charging possible
C	One CCS outlet with output current/power; 60 A / 22,5 kW
J	One CHAdeMO outlet with output current/power; 60 A / 22,5 kW

2.5. Standard usage

Usually, the Terra DC Wallbox Charger gets the power from the grid.



Figure 2: Terra DC Wallbox charger

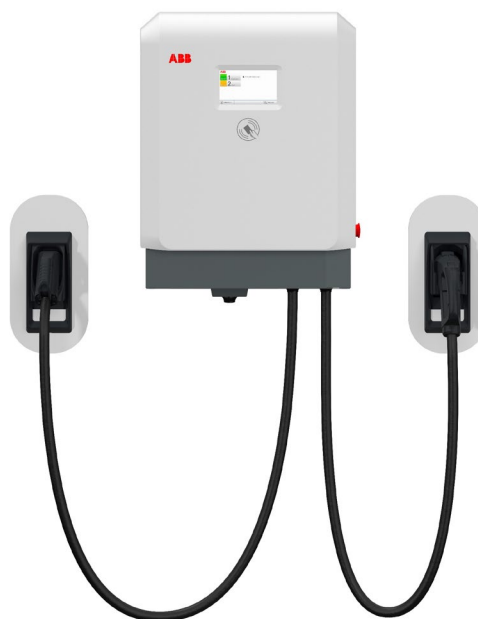

Figure 3: Terra DC Wallbox charger with two outlets.

2.6. Authorization to charge

Operation of the charger is possible with or without authorization. The authorization to charge can be based on RFID or credit card payment methods. Operating a charger with authorization requires a subscription to a back office. Authorization can either be an ABB supplied standard solution, or from an external company offering authorization solutions via OCPP.

2.7. Output Power vs. Output Voltage curve

The curve below shows the output power vs. the voltage output of the charger, reflecting that the charger can operate at the 22.5kW power range for both 400VDC and 800VDC architecture battery packs.

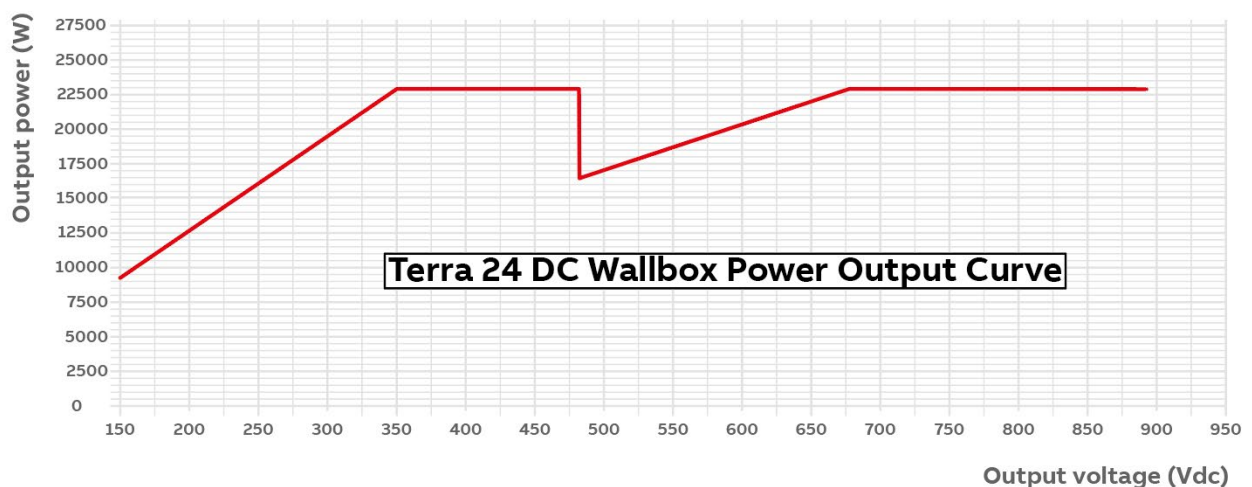

The DC Wallbox can output 22.5kW continuous power, with 24kW peak output capability. Note that the continuous output power is limited when ambient temperature is higher than the operating temperature range of -35 °C to +45 °C: ABB's overheating protection algorithm will derate the unit linearly up to +55 °C (this refers to location when charger is not exposed to direct solar radiation).

In the Vout ranges 480 / 675 Vdc and 150 / 350 Vdc there is an automatic current limitation.

The above curve refers to the 240V L-L AC supplied 1-ph version and 3-ph versions of DCWB. For the 1-ph 208V L-N AC supplied one has to be considered the input max current limitation to 100A that limits the max output power to 19,2kW@208 Vac [ref. to exact value mentioned in datasheet].

3. Quick instruction charging

To charge an electric vehicle (EV):

1. Park the EV with the charging inlet within reach of the connector, and turn it off.

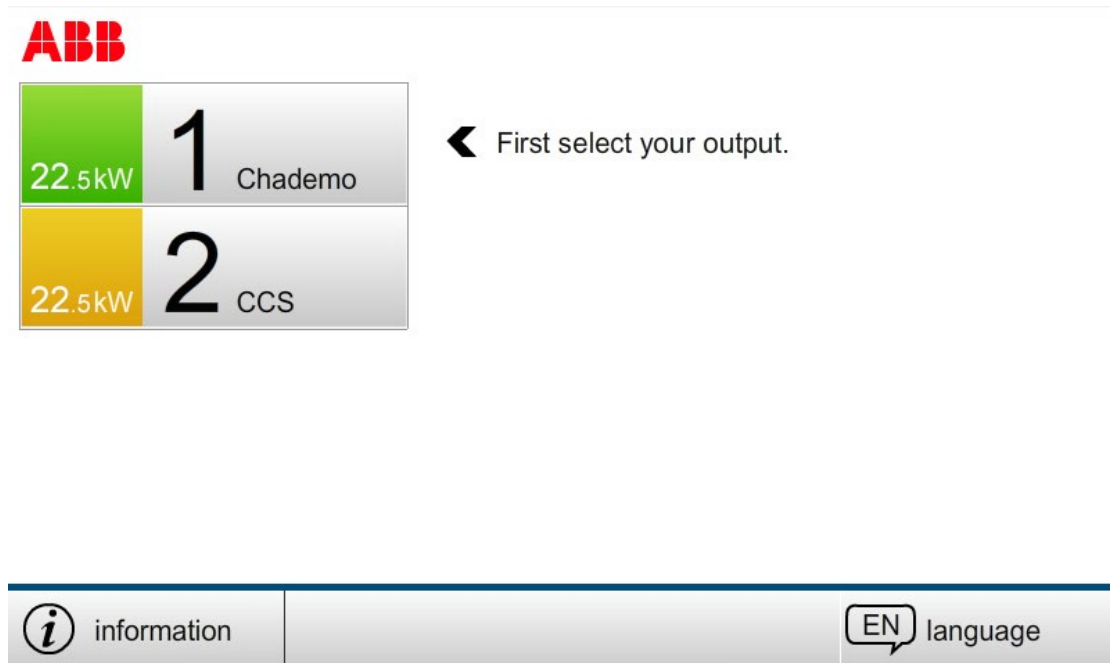

2. Connect the charger's connector to the vehicle's charging inlet.

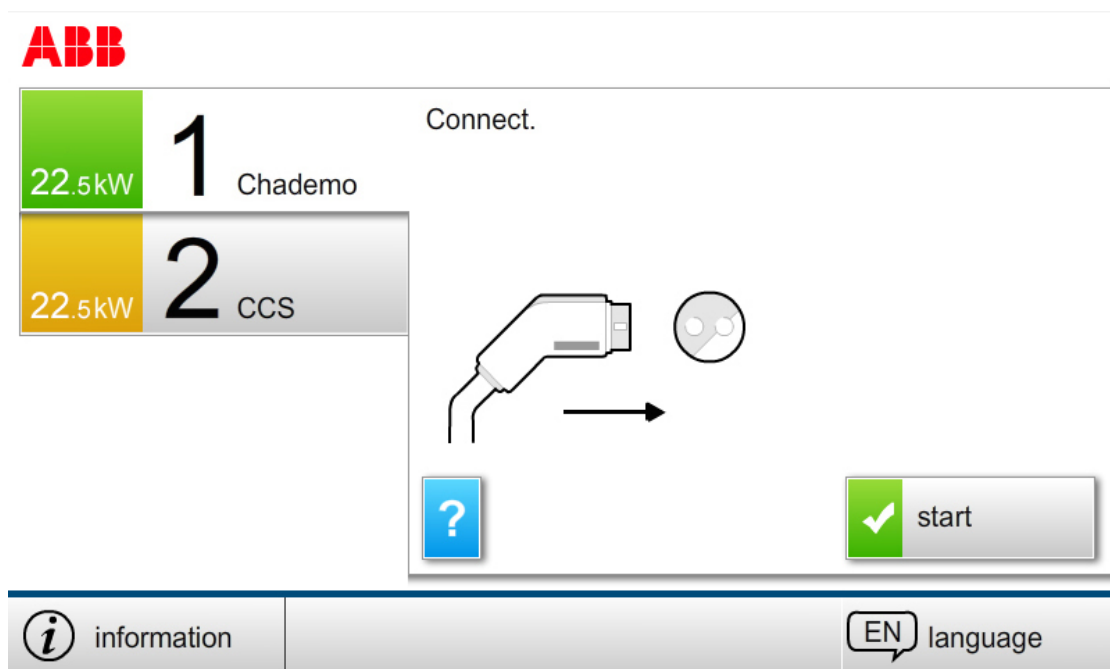

- Wait until the display shows you that the connection is OK.

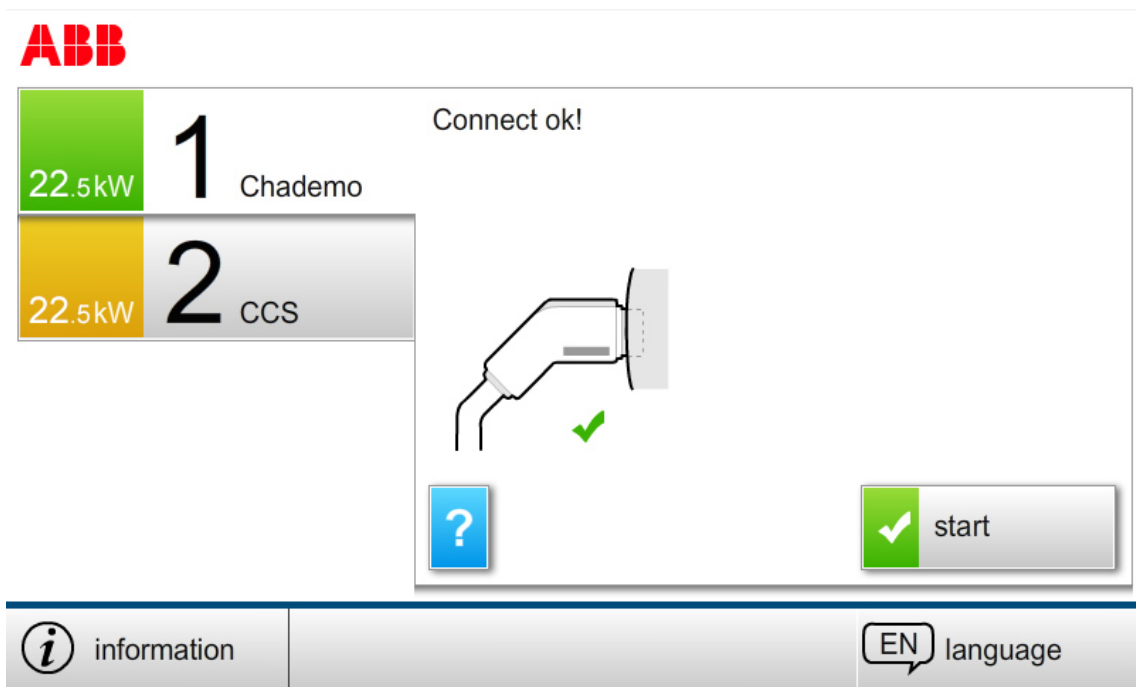

- Authorize the charging session by PIN code or RFID card.

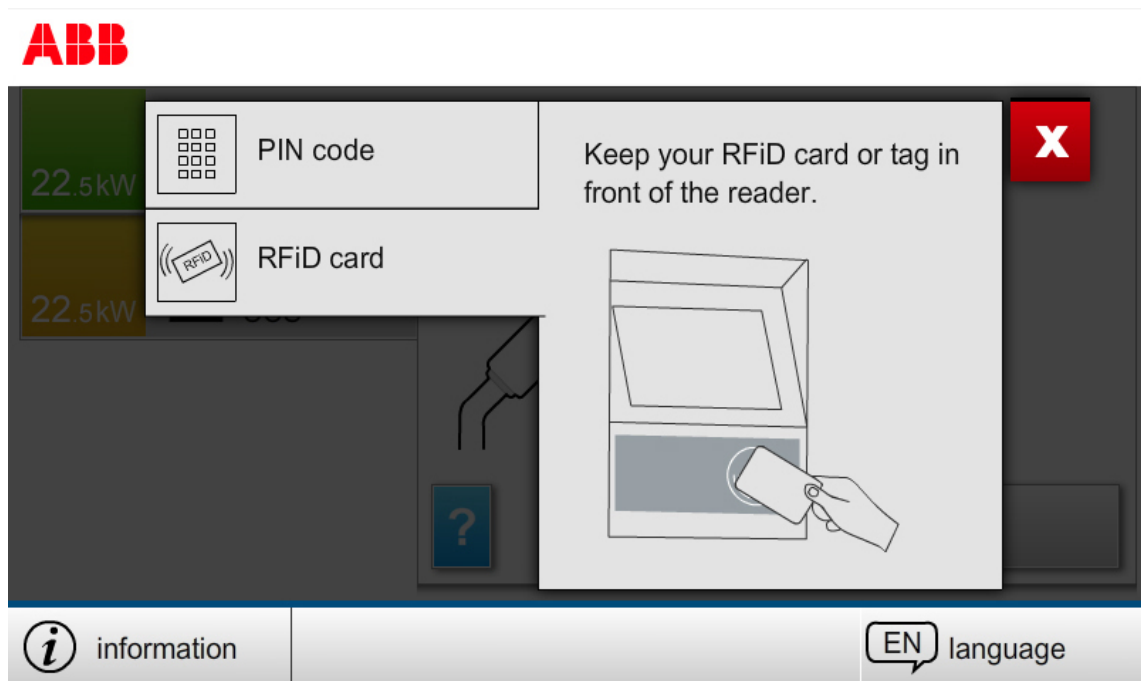

5. Wait until the preparation for charging has been completed.

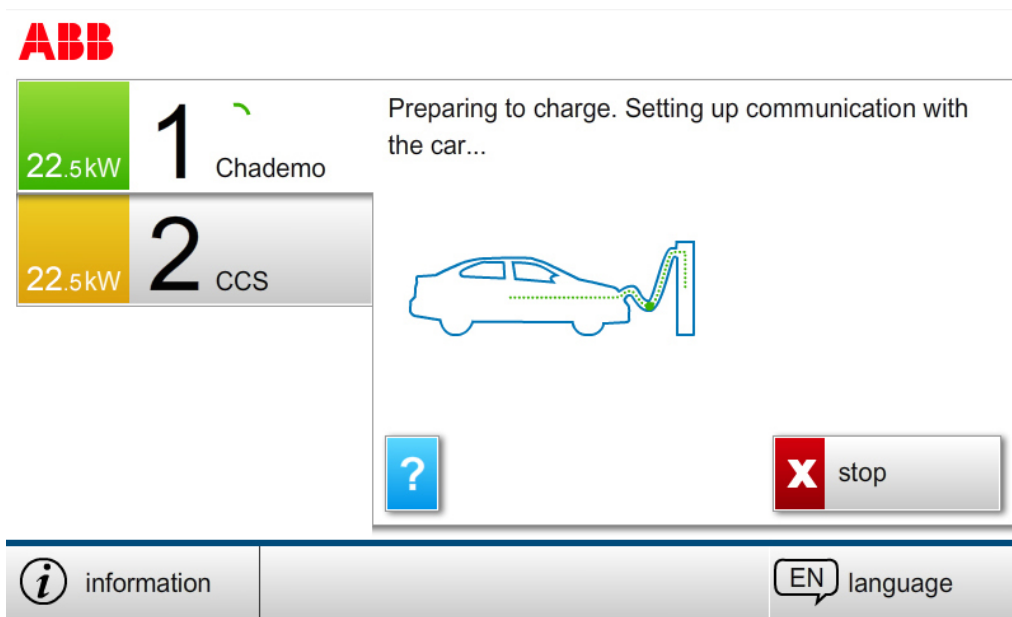

6. Wait until the charging process is done or press the stop button in order to stop the charging session.

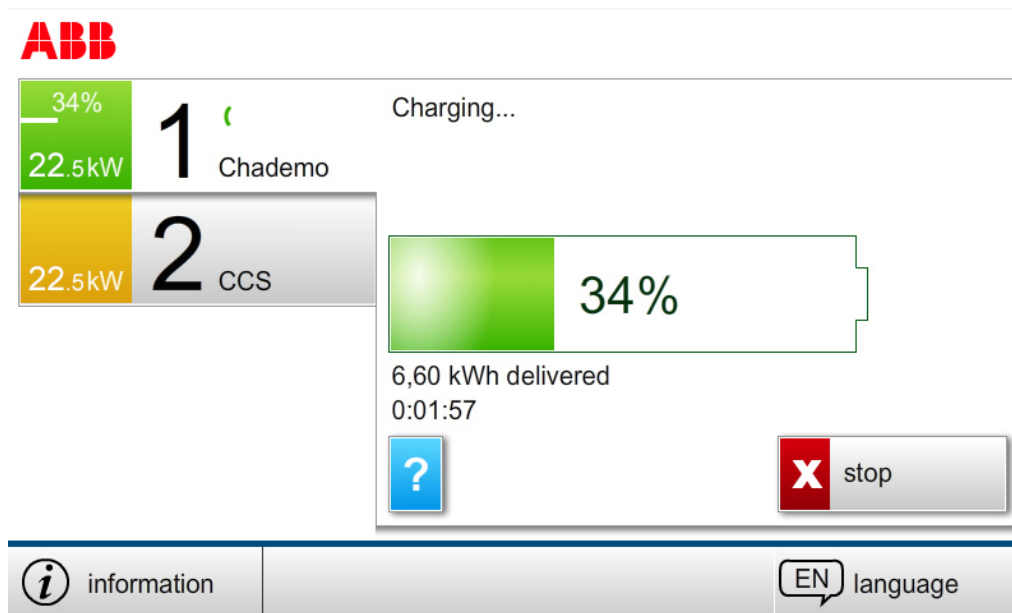

7. When the charge session finished, press OK on the display

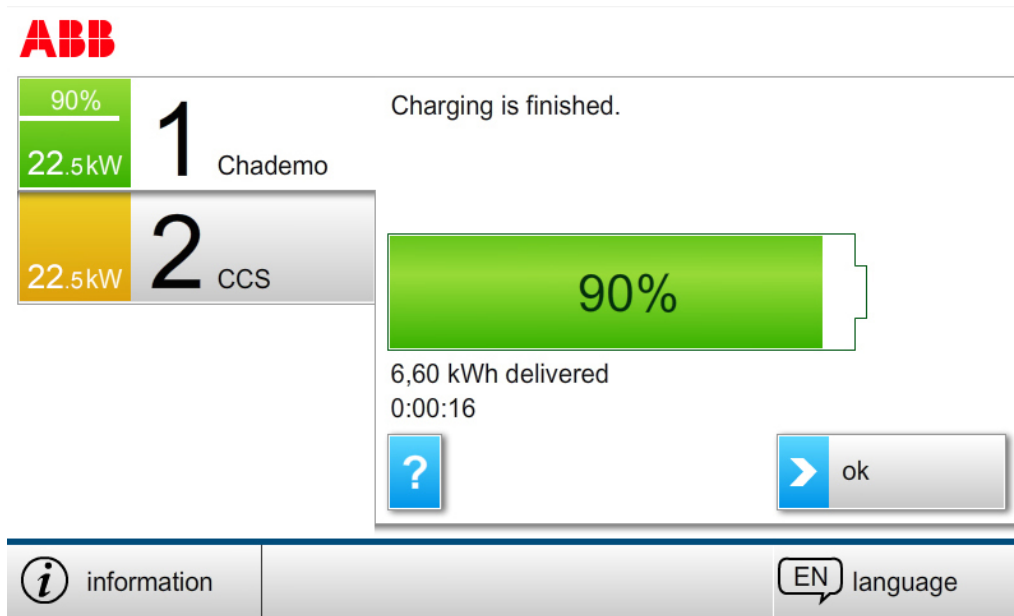

8. Disconnect the plug from the vehicle and place it on the plug holder.

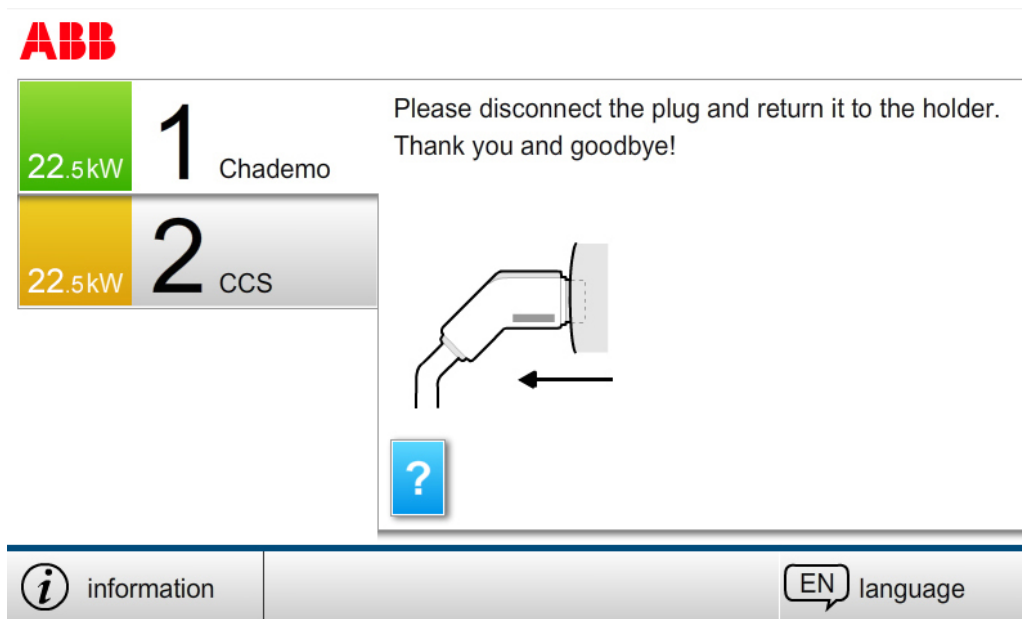

Stop charging:

1. Select stop on the touch-screen.
2. Potentially you have to authorize again to stop, using the same authentication method as was used to start. Note that for:
 - The CCS standard, the car will unlock the outlet,
 - The CHAdeMO, the charger will release the lock that is integrated in the CHAdeMO outlet.
3. Take the connector out of the car and put it back in the connector holder on the charger.

**NOTICE****Locked connector**

For CCS charging the EV locks the connector. If the user wants to take the connector out of the car, it may be necessary to unlock all doors of the EV, or use the 'unlock charge connector button' on the car key, if present.

**NOTICE****Session end**

Charging will stop without user interaction:

- When the EV indicates to the charger that charging is completed.
- When the maximum charge time set by the operator/owner has been reached.

If the battery is not full, a new charge session can be started. In general, topping up the battery is slow-charging.

4. Operator Instructions

4.1. Cleaning of the Terra DC Wallbox

Clean the DC Wallbox Cabinet once a year (during yearly maintenance) in the following way:

- Remove rough dirt by spraying with low-pressure tap water.
- Remove dirt by hand with a cloth rag.
- Rinse thoroughly with tap water.
- Optionally, apply wax on the front for extra protection and gloss.
- Do a check on the overall enclosure and on the frontal cover for cracks or other damages.



NOTICE

Ordinary cleaning

Keep the air inlets clean and free from snow and leaves or from any other materials.



NOTICE

Rust forming

When the charger is placed in a corrosion sensitive environment, the forming of superficial rust is possible on the welding points. This rust is merely visual, there is no risk for the cabinet's integrity. The rust can be removed with the cleaning procedure described above. To prevent the rust from reappearing; prime the areas with a transparent or color-like priming finish (separate Service Instructions are available).



NOTICE

When the Terra DC Wallbox Charger is exposed to rain, it is sufficient to clean it twice a year.



CAUTION

Do not apply high-pressure water jets. Water may leak into the cabinet. If a high-pressure water jet has been used, make sure that the inside of the cabinet is dry.

- Only use cleaning agents with a pH value between 6 and 8.
- Do not use cleaning agents with abrasive components.
- Do not use abrasive tools.

4.2. Service inspection of the cabinets

The following points must be checked regularly (advised yearly):

- Internal RCM need to be tested on correct functioning on a regular basis by pressing the “TEST button” on the device itself. During the yearly maintenance visit, a check is advised, to be executed by a certified ABB technician.
- Cable and connector
 - Check for cracks or ruptures on the connector or cable, check whether no internal wires of the cable are visible.
- Display screen
 - Check for damage and cracks.
- Powder coating
 - Look for damage, cracks or ruptures.
- Emergency stop button
 - Look for functionality and damage.

4.2.1. Special inspections

In the following cases the Charger must be checked by ABB service personnel before further use:

- If it was struck by lightning.
- If it is damaged due to an accident or fire.
- If its location has been flooded.

Do not power on until the charger has been inspected and approved.

4.3. Problem resolving

The site operator or helpdesk is the first response to a customer call. The helpdesk can remotely solve simple problems for the customer.

In special cases the site operator with knowledge of the charger can be asked by ABB Service to report about the status of some internal components of the charger. Therefore, a brief description of the position and function of these components is described on the next pages.

4.3.1. Overview of the WallBox

- A. Front cover
- B. Tipper bottom cover. The bottom cover can be opened by removing the two screws (N).
- C. AC screw terminal blocks
- D. PE connection bar
- E. Emergency button
- F. Front air filter
- G. Cellular antenna
- H. RFID reader
- I. HMI touch-screen display
- L. Top air filter
- M. Top cover

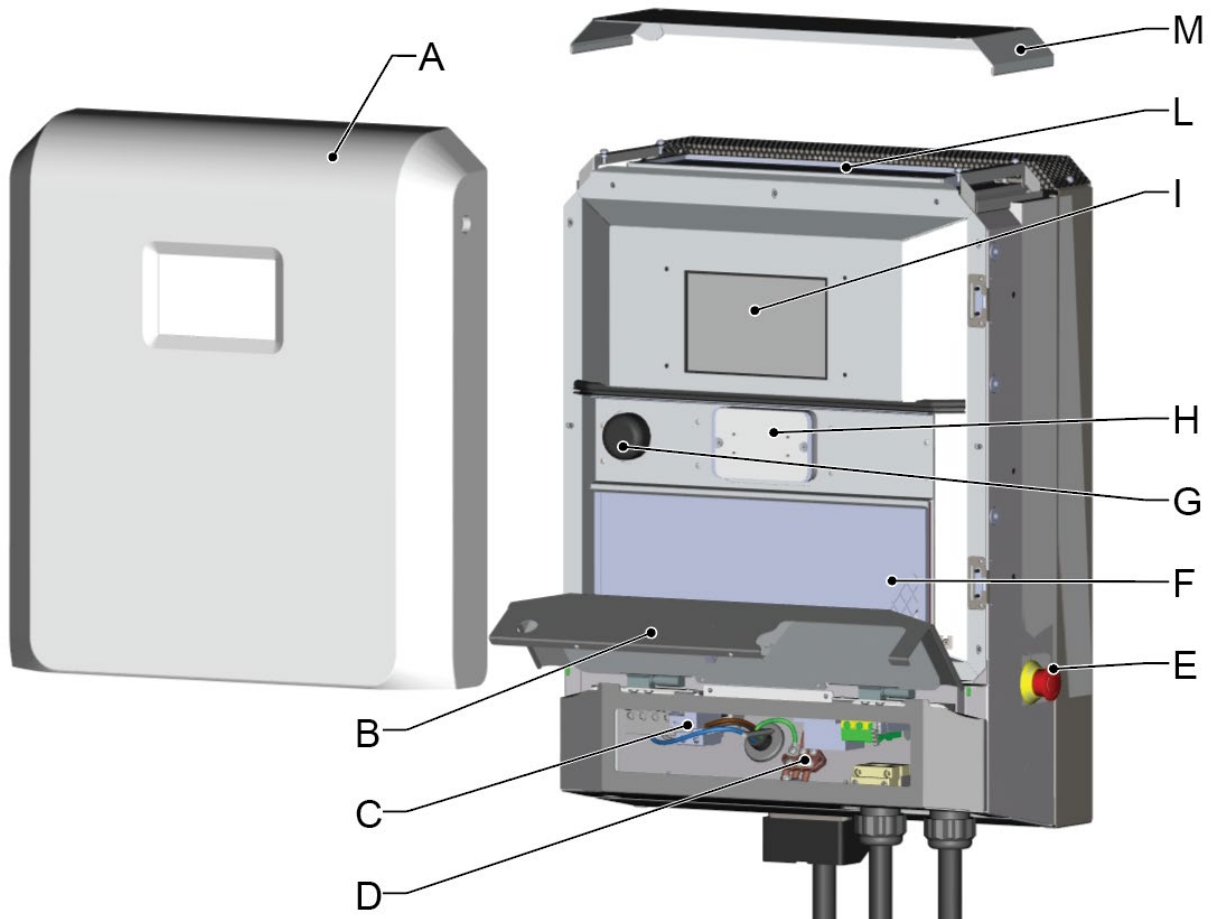
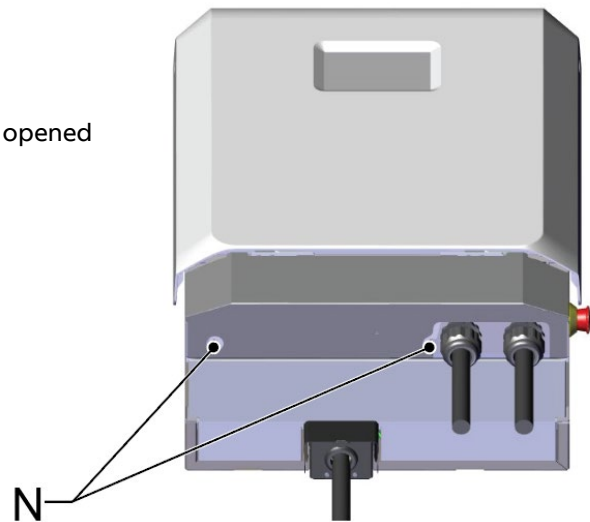

WARNING

Do not open the cabinet if you are not certified to work with electrical installations.

LOTO Steps (Lock Out Tag Out) commonly used by service consisting on cutting energy feed on upstream breaker, RCD and disconnect, need to be followed by any operator acting on the charger.

4.4. Troubleshooting

What to do in case of:

- Vehicle crash
- Fire
- Fluid spill

NOTE: this section will be defined at a next review of this document.

4.5. Recommended Preventive maintenance

The charger must be inspected and serviced yearly by an ABB trained/certified technician.

NOTES

Air Filter: The air filters must be inspected every 12 months and replaced if required.

Environment characteristic and number of charging sessions may increase or decrease the number of replacements during the lifetime of the charger.

- A. De-energize unit, make sure that unit is de-energized with appropriated instruments (multimeter), open cover, inspect air filter, clean or replace as needed.
To order replacement air filter, use the following global ID:
 - front filter → 6AGC074817
 - top side filter → 6AGC074819.
- B. Check input connections and terminations for proper torque values
- C. Check Grounding resistance
- D. Exercise input breaker and output DC breakers
- E. Open HMI cover, inspect capacitors and fuse connections.
- F. Clean interior with compressed air.
- G. Blow out rear cooling fins and remove any debris
- H. Reassemble unit, energize verify input voltage, perform a charging session.
- I. Using the connected network verify charging session details.

5. Contact information

Please contact your local ABB Service organization or Service partner for first line problem analysis and solving. In case they cannot solve the problem, they will contact the second line Service organization.