

SVC Light for rail traction

The way to effective grid integration

The way to effective grid integration

The increase in traffic on existing tracks combined with new high-speed rail projects mean rail traction is fast becoming an important load on electrical supply grids. This in turn is focusing a lot of attention on power quality. Trains taking power from the catenary need to be sure the supply voltages are stable and do not sag. Voltage and current imbalances between phases of AC supply systems, due to the fact that the railway load is connected between two phases, must also be confined in magnitude and prevented from spreading through the grid to other parts of the system. Voltage fluctuations and harmonics need to be controlled if they are to stay within the limits specified by the grid owner/operator.

With **SVC Light**[®], important benefits can be brought about in a cost and time effective way:

- Dynamic load balancing
- Dynamic voltage support
- Mitigation of harmonics emanating from traction devices
- Power factor correction

Valid grid codes are fulfilled as a result, and active power losses are minimized.

In all these cases, substantial money can be saved by the user by not having to invest in costly reinforcement of the feeding infrastructure such as building new transmission or sub-transmission lines, new power generation, and/or building new substations and feeding points. Also, SVC Light offers quicker improvement of railway feeding than the above mentioned, alternative means. And last but not least, all problems with permits for building new generation, new lines or new substations are eliminated altogether.

It is also worth mentioning that with SVC Light in the system, adequate power quality in the grid can be attained with feed-in at lower voltages than would otherwise be possible. This means, for example, that it may be sufficient to feed a railway system at 132 kV rather than at 220 kV or even 400 kV, which will of course save both time and money.



Connecting the railway to the grid

Load balancing

Nowadays, traction loads, P_{load} , tend to be relatively large. These loads create imbalances in the supply system voltage as they are connected between two mains phases. As a rule of thumb, if the fault level of the grid is represented by S_{SSC} , the imbalance, $U_{imbalance}$, is equal to

$$U_{imbalance} = \frac{P_{load}}{S_{SSC}}$$

A common requirement is that the negative phase sequence voltage resulting from an unbalanced load should not exceed one percent. In many cases the traction system is relatively far from strong high-voltage transmission lines, while weaker sub-transmission lines may run somewhere in the vicinity of the rail. These lines can be used to supply the rail in case the imbalance caused by the traction load can be eliminated. The means for this is SVC Light.

Dynamic voltage support

With growing train loads, keeping a high and stable catenary voltage becomes an issue for maintaining traction efficiency. Rather than having to reinforce the feeding infrastructure,

SVC Light offers a cost and time effective means for voltage support. And vice versa, in green-field projects, it can minimize the required number of feeding substations.

Power quality improvement

Voltage fluctuations and imbalance between phases are not the only power quality issues in railway feeding. Also, current and voltage harmonics, emanating from thyristor and diode locomotives must be trapped and confined, lest they spread out into the power system feeding the railway and become a nuisance to others. The ability of SVC Light to act as an Active Filter opens up for efficient harmonic filtering. All in all, Grid Codes issued by network operators are fulfilled by means of SVC Light.

Power factor improvement

High power thyristor locomotives are operated at relatively low power factors, typically 0.7 – 0.8. The result is reactive power consumption, leading to transmission losses as well as higher than necessary power tariffs. With SVC Light, the power factor can be kept high and stable, regardless of load fluctuations, and the tariff more favourable than otherwise possible.

Fig. 1: SVC Light for railway load balancing



Load balancing

Principle of load balancing

The load balancer transfers active power between the phases in order to create a balanced load seen from the feeding grid (Fig. 2). A graphic illustration is shown to bring some clarity to the concept.

The load current can be expressed by phase vectors. In case the load is connected between two phases (b & c) only, two phase vectors can express the traction current, one representing the positive-phase sequence and the second one representing the negative-phase sequence (Fig. 3). The summation of the two vectors is the resulting current (the current of phase a is zero and the currents in phase b and c are of equal magnitude but phase opposed). Note that the vector amplitudes are not truly representative.

To compensate the negative-phase sequence and thus balance the current to be generated by the power systems, the SVC Light load balancer generates a negative-phase sequence current as shown in Fig. 4.

The load balancer (I_{LB}) is a pure negative-phase sequence current. Please note that the current generated by the load balancer (I_{LB} in Fig. 4) exactly balances the negative-phase sequence current from the load (I_{-LOAD} in Fig. 3).

Fig. 2: Load balancing between the phases of the 3-phase feeding grid

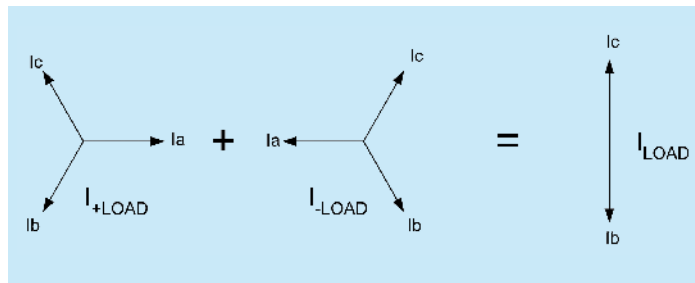
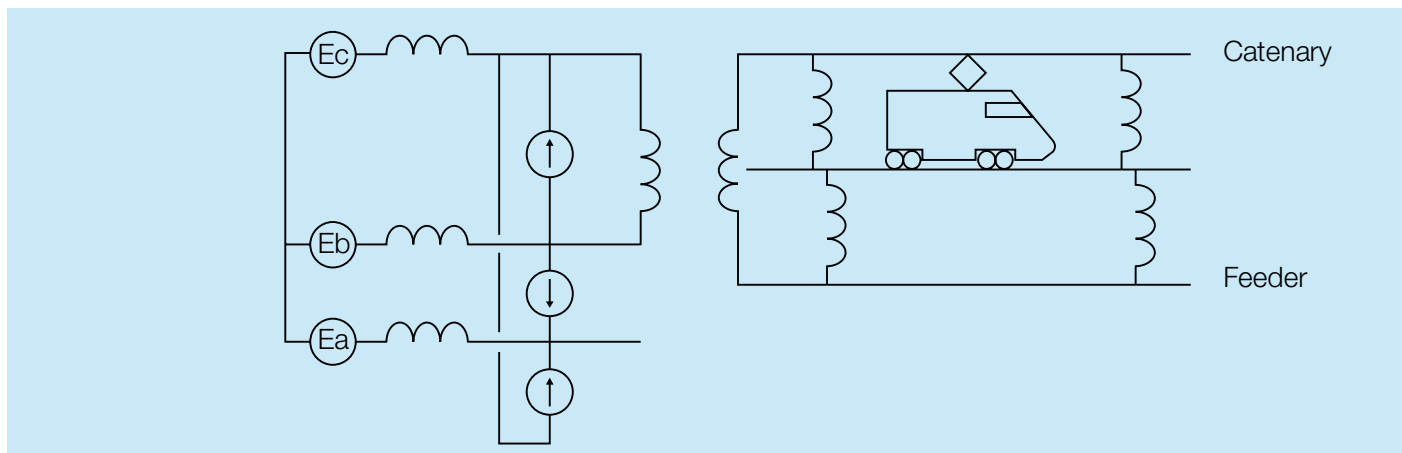

Fig. 3: Phase sequence components of the load current

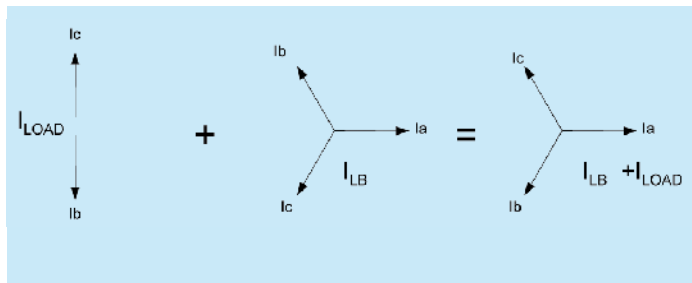

Fig. 4: Balancing the load current

SVC Light: the cost effective solution

With the advent of controllable semiconductor devices capable of high power handling, voltage source converters (VSCs) with ratings beyond 100 MVA are feasible. Now, VSC and insulated gate bipolar transistor (IGBT) technologies have been brought together to create a highly dynamic and robust system with a high bandwidth known as SVC Light, for a variety of power conditioning tasks in grids and beyond. Using pulse width modulation (PWM), an AC voltage almost sinusoidal in shape can be produced, with very little need for harmonic filtering.

Compact and cost effective

With its ability to generate voltages of any amplitude and phase angle, SVC Light has what it takes to fulfil the role of a load balancer as well as a yielder of dynamic voltage support and power factor correction.

The major part of SVC Light can be made container based, assembled and tested in the factory, which facilitates and speeds up work on site, thereby contributing to the installation coming on line faster.

Moreover, in cases where the substation is un-sectionalized, i.e. where the load is always connected to the same phase pair of the feeding transformer, thus generating negative phase sequence in one direction (quadrant) only, the SVC Light rating can be cut in half. This highly cost saving solution is realized by offsetting the dynamic range by means of inductive and capacitive branches in the remaining phase pairs. (Fig. 5).

Active filtering

Active filtering by means of active harmonic current suppression is based on generating harmonic currents in the SVC Light in phase opposition to the currents from the load. This is done by modulating the converter terminal fundamental voltages by higher frequencies. Filtering performance and the order of harmonics possible to handle are strongly related to the converter switching frequency. Typically, the active filtering is effective up to and including the 9th harmonic.

In Fig. 6, the effectiveness of load balancing in conjunction with active filtering is demonstrated. In the upper graph, the total load current in all three phases at the point of common coupling is displayed, ridden with low order harmonics. The current in one phase is zero. The lower graph shows the balanced and filtered currents in the three phases. Please note the three symmetric, 120 degrees displaced phase currents. What remains of distortion in the waveforms is some ripple emanating from the load and from the SVC Light.

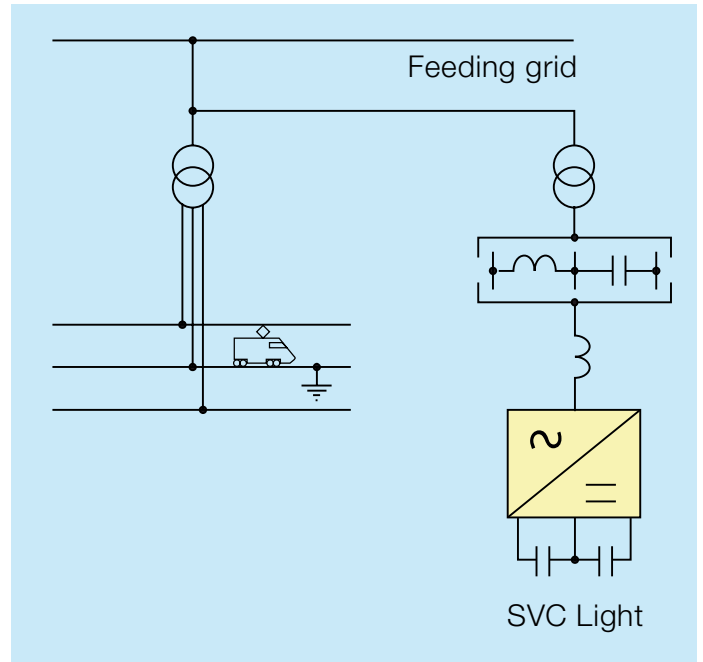

Fig. 5: With SVC Light, load balancing can be performed with less required Mvar than by classical means. A simple offset filter minimizes the required rating of the load balancer further, thereby slashing the cost of the installation additionally.

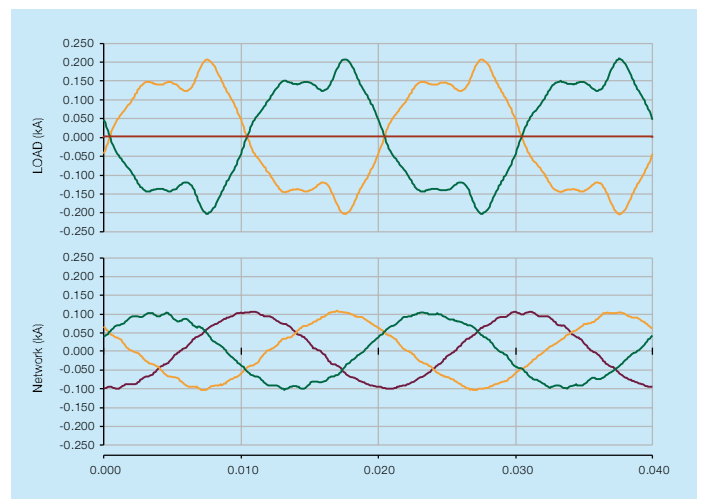

Fig. 6: Load balancing and active filtering

An example

As an example, two SVC Light are operated in the French railway system fed from the national power grid, one at 90 kV and one at 63 kV sub-transmission levels. At both sites, SVC Light is utilized for dynamic balancing of asymmetry between phases caused by single-phase take-off of power from the three-phase grid. The SVC Light also performs the task of active filtering of harmonics generated by thyristor locomotives, enabled by the high dynamic response inherent in SVC Light. With the SVC Light, the grid code at the 90 kV and 63 kV points of common connection is fulfilled.

A single-line diagram of one SVC Light is shown in Fig. 7.

In Fig. 7, the load balancer is rated at 63kV, 15MVA and can accommodate a single-phase active load of up to 16 MW. Its task is to confine grid unbalance at 63 kV at no more than 1 per cent under normal network conditions and no greater than 1.8 per cent for abnormal (N-1) network conditions. One double-tuned filter, tuned to the 40th and 51.5th harmonics, has been installed on the AC side. No passive harmonic filters are used on the 63 kV side. This gives a robust solution which can be applied to varying network configurations.

The second SVC Light installation is rated at 90 kV, 16 MVA to accommodate a single-phase active load of up to 17 MW. Its task is to confine the grid unbalance at 90 kV to no more than 1 per cent for a grid fault level $S_{SSC} \geq 600$ MVA under normal network conditions and no greater than 1.5 percent for $300 \text{ MVA} \leq S_{SSC} \leq 600 \text{ MVA}$ for abnormal (N-1) network conditions. Measurements taken since the SVC light was installed show a distinct improvement in voltage unbalance. To be more specific, the voltage unbalance does not exceed 1 per cent (Fig. 9).

SVC Light cost benefits

SVC Light offers not only a technical but also an economically advantageous solution. To illustrate this point, suppose SVC Light were not available. Therefore, to meet the imbalance requirements, the supply network feed-in would have to be transferred from 63 kV to 225 kV or 400 kV. This in turn would require the erection of new overhead lines as well as the upgrading of a number of substations currently supplied with 63 kV or 90 kV.

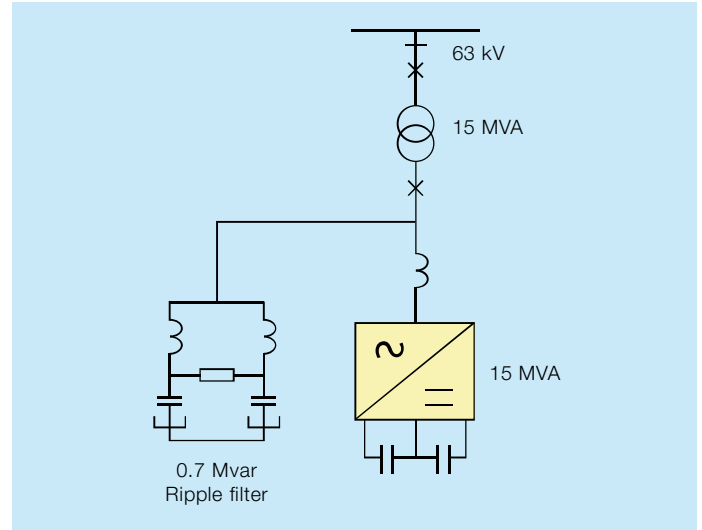

Fig. 7: Single-line diagram, SVC Light



Fig. 8: SVC Light

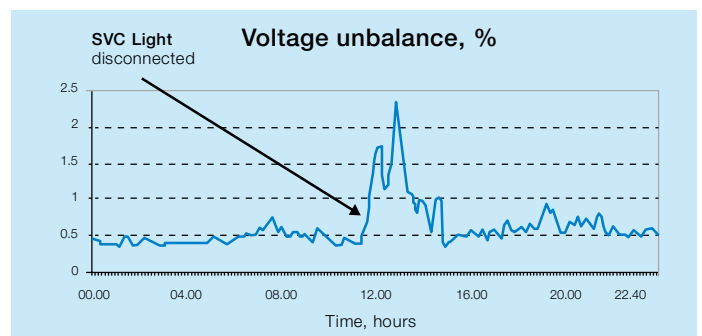

Fig. 9: Measurement of voltage imbalance (10 min values)

Contact us

ABB AB

FACTS

SE-721 64 Västerås,

SWEDEN

Phone: +46 (0)21 32 50 00

Fax: +46 (0)21 32 48 10

www.abb.com/FACTS