

B23/B24 User Manual



B23/B24

User Manual

Document ID: 2CMC485003M0201

Revision: B

2020-12-16

Disclaimer

The information in this document is subject to change without notice and should not be construed as a commitment by ABB Spa. ABB Spa assumes no responsibility for any errors that may appear in this document.

In no event shall ABB Spa be liable for direct, indirect, special, incidental or consequential damages of any nature or kind arising from the use of this document, nor shall ABB Spa be liable for incidental or consequential damages arising from use of any software or hardware described in this document.

Copyrights

This document and parts thereof must not be reproduced or copied without written permission from ABB Spa, and the contents thereof must not be imparted to a third party nor used for any unauthorized purpose.

The software or hardware described in this document is furnished under a license and may be used, copied, or disclosed only in accordance with the terms of such license.

© Copyright 2020 ABB Spa. All rights reserved.

Trademarks

ABB Spa is a registered trademark of the ABB Group. All other brand or product names mentioned in this document may be trademarks or registered trademarks of their respective holders.

Contact

ABB Spa
via dell'Industria, 19
20010 - Vittuone - Milano
Italy
Tel: +39 02 2415 0000

Table of Content

1 Product Overview	8
1.1 Meter Parts	9
1.2 Meter Types	11
2 Installation	14
2.1 Mounting the Meter	15
2.2 Environmental Considerations	17
2.3 Installing the Meter	18
2.3.1 Configuring the meter	19
2.4 Wiring Diagrams	20
2.4.1 Direct connected meters	20
2.4.2 Transformer connected meters	21
2.4.3 Inputs/outputs	22
2.4.4 Communication	23
3 User Interface	24
3.1 Display	25
4 Meter Settings	29
4.1 Settings and Configurations	31
4.1.1 Setting Ratios	31
4.1.2 Setting Wires	32
4.1.3 Setting Pulse Output	32
4.1.4 Setting I/O	33
4.1.5 Setting Alarm	33
4.1.6 Setting M-Bus	35
4.1.7 Setting RS485	36
4.1.8 Setting IR Side	36
4.1.9 Setting Upgrade Consent	39
4.1.10 Setting Pulse LED	39
4.1.11 Setting Tariff	39
4.1.12 Resetting Resettable Registers	39
5 Technical Description	42
5.1 Energy Values	43
5.2 Instrumentation	45
5.3 Alarm	47
5.4 Inputs and Outputs	48
5.4.1 Tariff Inputs	48
5.4.2 Pulse Outputs	49
5.4.2.1 Pulse Frequency and Pulse length	49
5.5 Logs	51
5.5.1 System Log	51
5.5.2 Event Log	52
5.5.3 Net Quality Log	53
5.5.4 Audit Log	53
5.5.5 Settings Log	54
5.5.6 Event codes	54
6 Technical data	56
6.1 Technical Specifications	57
6.2 Physical dimensions	61
7 Measurement Methods	64

7.1 Measuring Energy	65
7.1.1 Single Phase, 1-Element Metering	67
7.1.2 3-Phase, 2-Element Metering	69
7.1.3 3-Phase, 3-Element Metering	71
8 Service & Maintenance	76
8.1 Service and Maintenance	77
9 Communication with Modbus	78
9.1 About the Modbus Protocol	79
9.1.1 Function Code 3 (Read holding registers)	79
9.1.2 Function Code 16 (Write multiple registers)	81
9.1.3 Function Code 6 (Write single register)	82
9.1.3.1 Exception Responses	83
9.2 Reading and Writing to Registers	84
9.3 Mapping Tables	85
9.4 Event logs	94
9.4.1 Reading Event logs	97
9.5 Configuration	98
9.5.1 Alarms	99
9.5.2 Inputs and outputs	101
9.5.3 Tariffs	103
10 Communication with M-Bus	106
10.1 Protocol Description	107
10.1.1 Telegram Format	111
10.1.1.1 Field description	111
10.1.2 Value Information Field codes	117
10.1.2.1 Standard VIF codes	117
10.1.2.2 Standard codes for VIFE used with extension indicator FDh	117
10.1.2.3 Standard codes for VIFE	118
10.1.2.4 First manufacturer specific VIFE-codes	118
10.1.2.5 VIFE-Codes for reports of record errors (meter to master)	119
10.1.2.6 VIFE-Codes for object actions (master to meter)	119
10.1.2.7 2:nd manufacturer specific VIFE followed after VIFE 1111 1000 (F8 hex):	119
10.1.2.8 2:nd manufacturer specific VIFE followed after VIFE 1111 1001 (F9 hex):	119
10.1.3 Communication process	120
10.1.3.1 Selection and secondary addressing	121
10.2 Standard Readout of Meter Data	123
10.2.1 Example of the 1st telegram (all values are hexadecimal)	123
10.2.2 Example of 2nd telegram (all values are hexadecimal)	126
10.2.3 Example of 3rd telegram (all values are hexadecimal)	131
10.2.4 Example of the 4th telegram (all values are hexadecimal)	135
10.2.5 Example of the 5th telegram (all values are hexadecimal)	139
10.2.6 Example of the 6th telegram (all values are hexadecimal)	142
10.2.7 Example of the 7th telegram (all values are hexadecimal)	146
10.3 Special Readout of Meter Data	150
10.3.1 Readout of Event Log Data	150
10.3.1.1 Example of readout of log data	152
10.4 Sending Data to the Meter	154
10.4.1 Set tariff	154
10.4.2 Set primary address	155
10.4.3 Change baud rate	155
10.4.4 Reset power fail counter	156

10.4.5	Set Current transformer (CT) ratio - numerator	156
10.4.6	Set current transformer (CT) ratio - denominator	157
10.4.7	Select status information	157
10.4.8	Reset of stored state for input 3	158
10.4.9	Reset of stored state for input 4	158
10.4.10	Reset of input counter 3	159
10.4.11	Reset of input counter 4	159
10.4.12	Set output 1	160
10.4.13	Set output 2	160
10.4.14	Send password	161
10.4.15	Set password	161
10.4.16	Reset logs	162
10.4.17	Reset resettable active energy import	162
10.4.18	Reset resettable active energy export	163
10.4.19	Reset resettable reactive energy import	163
10.4.20	Reset resettable reactive energy export	164
10.4.21	Set write access level	164
10.4.22	Set tariff source	165
10.4.23	Set CO2 conversion factor	165
10.4.24	Set currency conversion factor	166

Chapter 1: Product Overview

Overview

This chapter describes the parts of the meter and the different meter types.

In this chapter

The following topics are covered in this chapter:

1.1 Meter Parts	9
1.2 Meter Types	11

1.1 Meter Parts

Illustration

The parts of the meter are shown in the illustration below:

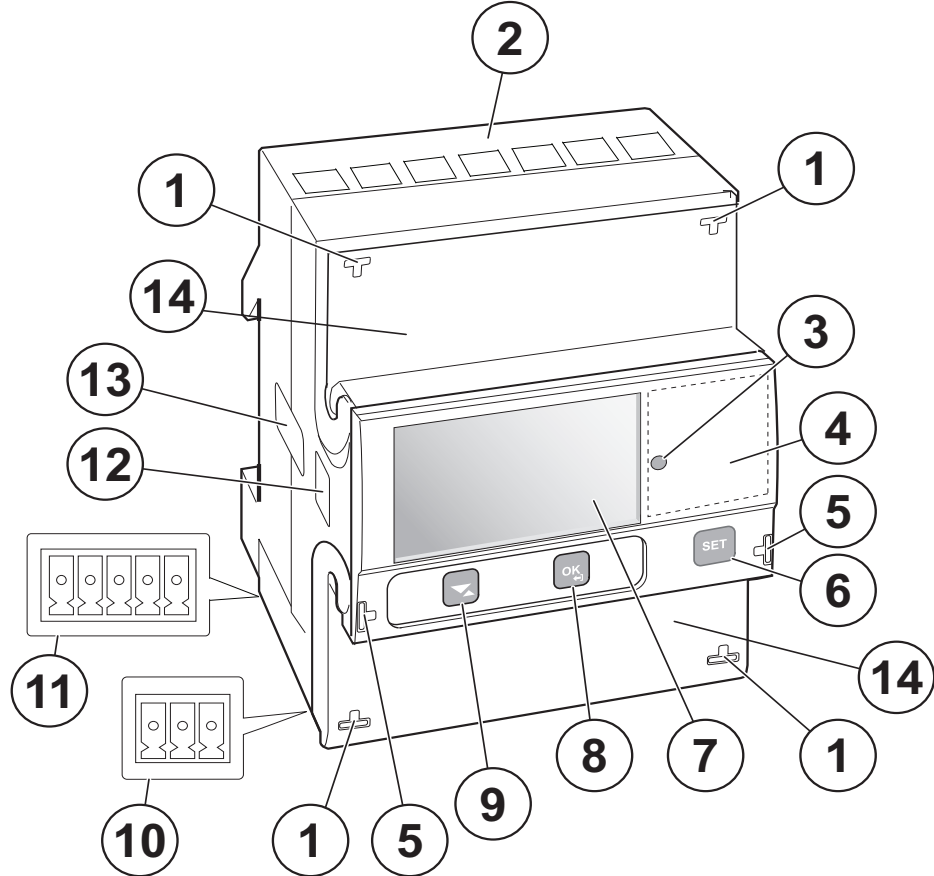

Parts description

The following table describes the parts of the meter:



Item	Description	Comments
1	Sealing points	Seal thread is used to seal the meter.
2	Terminal block	Terminal for all voltages and currents
3	LED	Flashes in proportion to the energy measured
4	Product data	Contains data about the meter type
5	Sealing points for sealable cover	Seal thread is used to seal the cover.
6	Set button	Enter configuration mode
7	Display	LCD for meter reading

Item	Description	Comments
8	OK / Exit button	Press to perform an action or to select a menu. Press and hold to exit to the previous menu or to toggle between default and main menu.
9	Down / Up button	Toggle down / up (toggle right / left in the main menu): press for down, press and hold for up.
10	Terminal for communication connection	
11	Terminal for input/output connection	
12	Optical communication interface	For IR communication
13	Sealing label	On both sides of the meter
14	Sealable terminal cover	Protective cover with printed wiring diagram on the inside.

1.2 Meter Types

Main groups

The B23/B24 meters are divided into two main groups:

- Direct connected meters for currents $\leq 65\text{A}$.
- Transformer connected meters for currents $> 65\text{A}$ using external current transformers with secondary current $\leq 6\text{A}$ and optional voltage transformers.

Subgroups

The main meter groups are further divided into subgroups depending on the functionality of the respective meter:

Subgroup	Functionality
Silver	Class 0,5 S or Class 1, Tariffs, Fixed I/O, Resettable registers, Import/export of energy, Active energy, Reactive energy, Pulse output/alarm
Bronze	Import/export of energy, Active energy, Reactive energy, Class 1, Pulse output/alarm
Steel	Active energy import, Class 1, Pulse output/alarm

Product label

The meter type information that is reflected on the labels on the meter is shown in the example picture below:

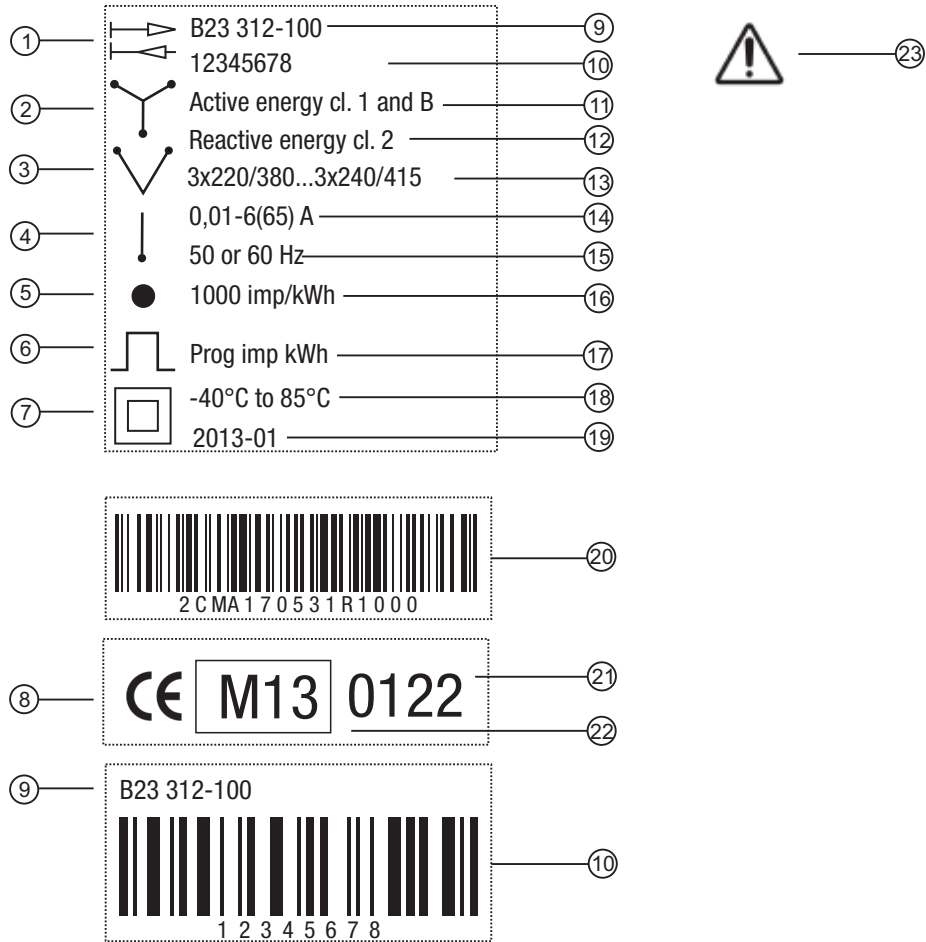

Product label information

The information on the product label is explained in the table below:

Item	Description
1	Import/export of energy
2	3–element metering
3	2–element metering
4	1–element metering
5	LED
6	Pulse output
7	Protection class II
8	Declaration of product safety
9	Type designation
10	Serial number
11	Accuracy active energy

Product Overview

Item	Description
12	Accuracy reactive energy
13	Voltage
14	Current
15	Frequency
16	LED pulse frequency
17	Pulse frequency
18	Temperature range
19	Date of manufacture (year and week)
20	ABB ID
21	Notified body
22	MID and year of verification
23	Caution, refer to accompanying documents

Chapter 2: Installation

Overview

This chapter describes how to mount the B23/B24 meters and how to connect them to an electricity network. The chapter also contains information about how to perform a basic configuration of the meter.

Information about how to connect I/O and communication options is also included in this chapter.

In this chapter

The following topics are covered in this chapter:

2.1 Mounting the Meter	15
2.2 Environmental Considerations	17
2.3 Installing the Meter	18
2.3.1 Configuring the meter	19
2.4 Wiring Diagrams	20
2.4.1 Direct connected meters	20
2.4.2 Transformer connected meters	21
2.4.3 Inputs/outputs	22
2.4.4 Communication	23

2.1 Mounting the Meter

General

This section describes different ways to mount the B23/B24 meters. For some methods of mounting additional accessories are needed. For further information about accessories, refer to the Main Catalog (2CMC480001C0201).

DIN-rail mounted

The B23/B24 meters are intended to be mounted on a DIN-rail (DIN 50022). If this method of mounting is used, then no extra accessories are needed and the meter is fastened by snapping the DIN-rail lock onto the rail.

DIN-rail

The following picture shows a DIN-rail.

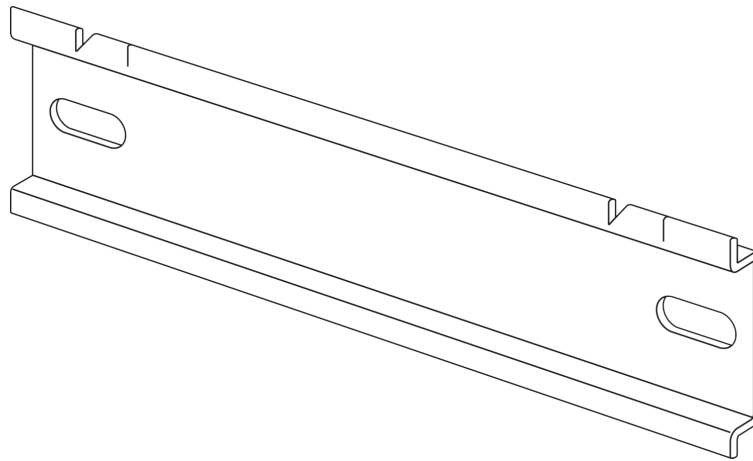

Wall mounted

The recommended way to mount the meter on a wall is to mount a separate DIN-rail on the wall and then mount the meter on the rail.

Flush mounted

To flush-mount the meter a flush-mount kit should be used.

Flush-mount kit

The following picture shows a flush-mount kit.

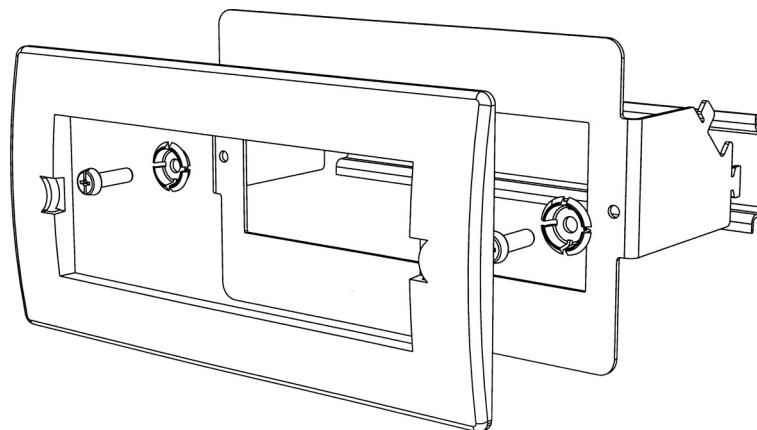

2.2 Environmental Considerations

Ingress protection

To comply with the protection requirements the product must be mounted in protection class IP 51 enclosures, or better, according to IEC 60259.

Mechanical environment

In accordance with the Measuring Directive (2014/32/UE), the product complies with M1, which means that it can be operated in "...locations with vibration and shocks of low significance, e.g. for instruments fastened to light supporting structures subject to negligible vibrations and shocks transmitted from local blasting or pile-driving activities, slamming doors, etc."

Electromagnetic environment

In accordance with the Measuring Directive (2014/32/UE), the product complies with E2, which means that it can be operated "...in locations with electro magnetic disturbances corresponding to those likely to be found in other industrial buildings."

Climatic environment

In order to work properly the product should not be operated outside the specified temperature range of -40°C – $+70^{\circ}\text{C}$.

In order to work properly the product should not be exposed to humidity exceeding the specified 75% yearly average, 95% on 30 days/year.

2.3 Installing the Meter



Warning – Electrical equipment should only be installed, accessed, serviced and maintained by qualified electrical personnel.

Working with high voltage is potentially lethal. Persons subjected to high voltage may suffer cardiac arrest, burn injuries, or other severe injuries. To avoid such injuries, make sure to disconnect the power supply before you start the installation.



Warning – For safety reasons it is recommended that the equipment is installed in a way that makes it impossible to reach or touch the terminal blocks by accident.

The best way to make a safe installation is to install the unit in an enclosure. Further, access to the equipment should be limited through use of lock and key, controlled by qualified electrical personnel.



Warning – The meters must always be protected by fuses on the incoming side.

In order to allow for maintenance of transformer rated meters, it is recommended that there should be a short circuiting device installed near the meter.

Utilization category IEC 62052-31 B23: Utilization Category UC2
B24: Utilization Category UC1



Install the meter

Follow the steps in the table below to install and verify the installation of the meter:

Step	Action
1	Turn off the mains power.
2	Place the meter on the DIN-rail and make sure it snaps onto it.
3	Strip the cable insulation to the length that is indicated on the meter.
4	Connect the cables according to the wiring diagram that is printed on the meter and tighten the screws (3.0 Nm for direct connected meters and 1.5 Nm for transformer connected meters).
5	Install the circuit protection. See <i>table 2:1</i> below for the correct fuse.
6	If inputs/outputs are used, then connect the cables according to the wiring diagram that is printed on the meter and tighten the screws (0.25 Nm). Then connect to an external power supply (max 240V).
7	If communication is used, then connect the cables according to the wiring diagram that is printed on the meter and tighten the screws (0.25 Nm).
Verify the installation	
8	Check that the meter is connected to the specified voltage and that voltage phase connections and the neutral (if used) are connected to the correct terminals.
9	For a transformer connected meter, check that the current direction of the primary and secondary current of the external transformers is correct. Also check that the transformers are connected to the correct meter terminals.

Step	Action
10	Turn on the power. If a warning symbol is displayed, then refer to the error codes in <i>Troubleshooting</i> .
11	Under the menu item "Instantaneous Values" on the meter, check that the voltages, currents, power and power factors are reasonable and that the power direction is what to be expected (the total power should be positive for a load that consumes energy). When doing the check the meter should be connected to the intended load, preferably a load with a current above zero on all phases to make the check as complete as possible.

Circuit protection Use the information in this table to select the correct fuse for the circuit protection.

Table: 2:1

Meter type	Max circuit protection
Direct connected	65 A MCB, C characteristic or 65 A fuse type gL–gG
Transformer connected	10 A MCB, B characteristic or Diazes, fast.

2.3.1 Configuring the meter

Default settings For information about how to change the default settings of the meter, refer to the chapter called *Meter Settings*.

Default settings The following table lists the default settings of the meter that normally need to be changed. Check the settings of the meter to see if they need to be reconfigured.

Parameter	Direct connected meters	Transformer connected meters
Ratios CT	—	1
Number of wires	4	4
Pulse frequency	10	10
Pulse length	100 ms	100 ms

2.4 Wiring Diagrams

General



This section describes how to connect the different types of meters to an electricity network. The terminal numbers in the wiring diagrams listed below correspond to the marking on the terminal block of the meter.

2.4.1 Direct connected meters

4-wire connection

The following diagram shows a 4-wire connection of a direct connected 3-phase meter:

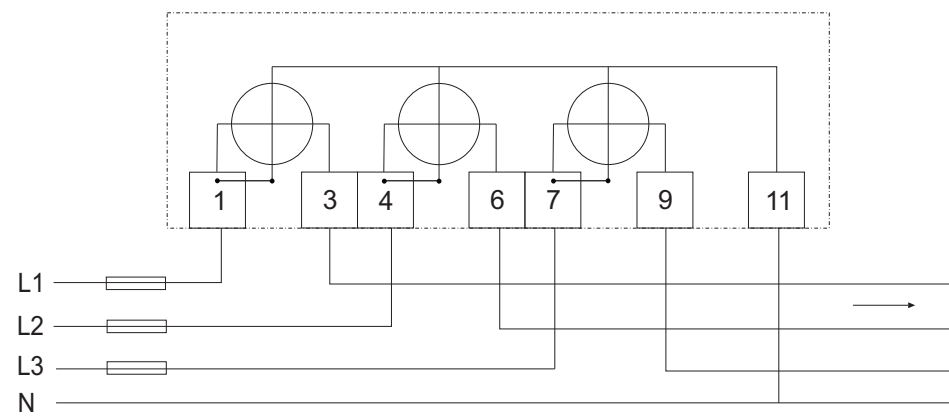

3-wire connection

The following diagram shows a 3-wire connection of a direct connected 3-phase meter:

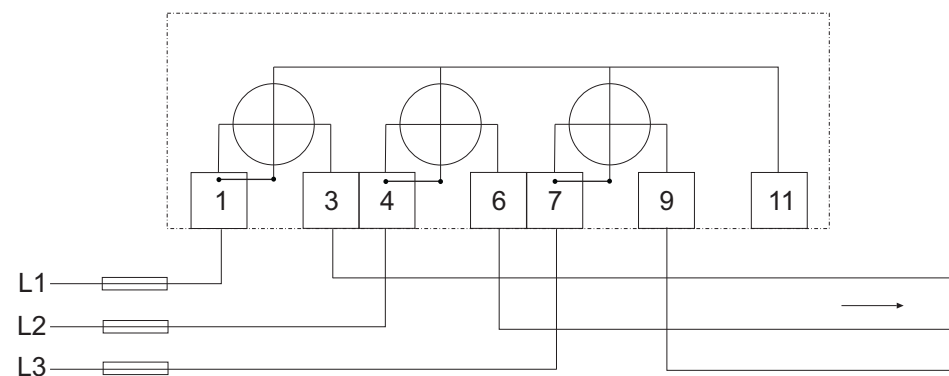

2-wire connection

The following diagram shows a 2-wire connection of a direct connected 3-phase meter:

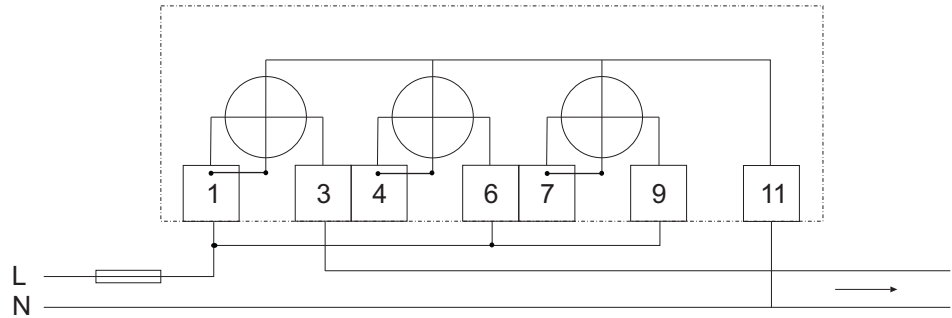

2.4.2 Transformer connected meters

4-wire connection

The following diagram shows a 4-wire connection of a transformer connected 3-phase meter:

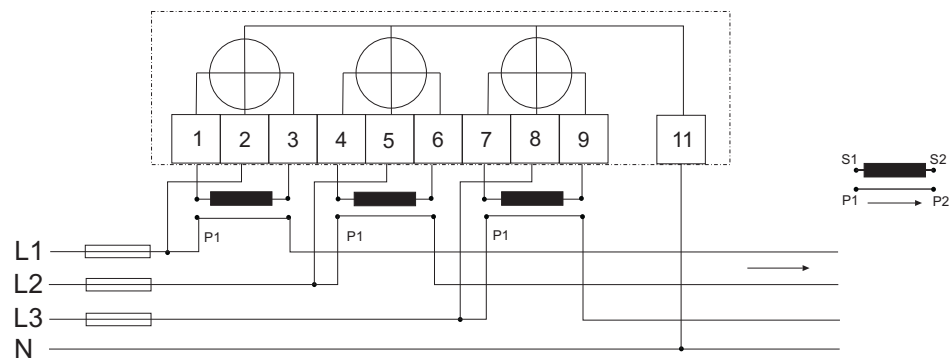

3-wire connection

The following diagram shows a 3-wire connection of a transformer connected 3-phase meter:

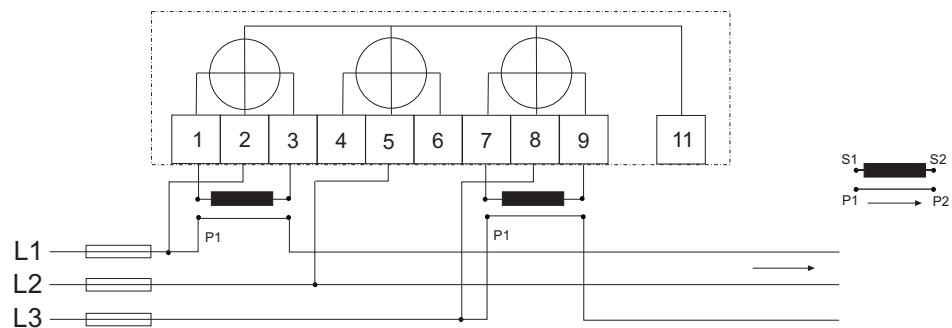

2-wire connection

The following diagram shows a 2-wire connection of a transformer connected 3-phase meter:

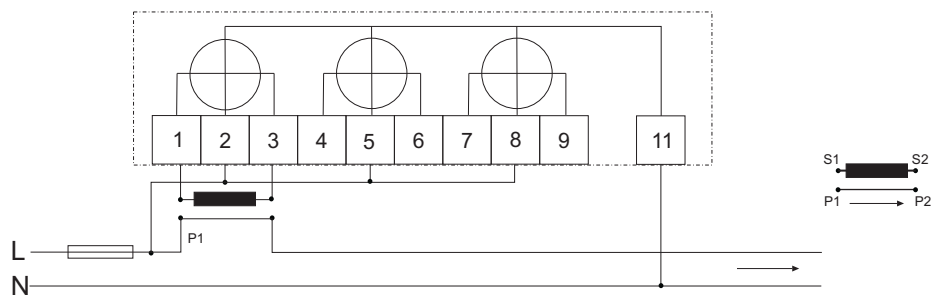

2.4.3 Inputs/outputs

2 outputs, 2 inputs

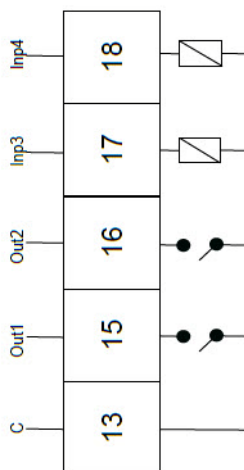

1 output

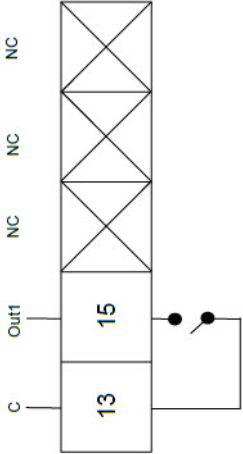

2.4.4 Communication

RS485

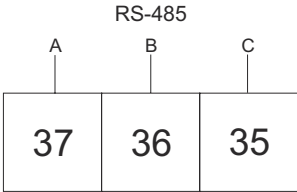

M-Bus

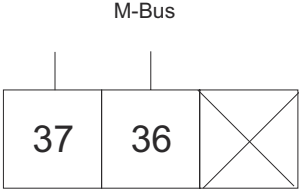

Chapter 3: User Interface

Overview This chapter describes the different display views and the menu structure.

In this chapter The following topics are covered in this chapter:

3.1 Display 25

3.1 Display

General

The display contains two main views: the Default menu and the Main menu. Use the button  to toggle between the views. In both views a number status icons are displayed in the upper part of the display. These icons are explained in *table 3:1* below. In the same manner the bottom part of the display has an explanatory text to describe what is shown or highlighted at the moment.

Default menu

The following image shows an example of the layout of the Default menu:

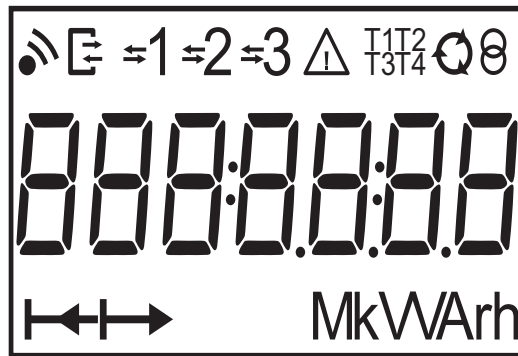

Energy values

The following table explains the content of the 20 available pages in the Default menu:

Page	Unit	Symbol on display	Explaining text
1/20	kWh	ACT.NRG.IMP.TOTT arrow right	Measures the total imported active energy.
2/20	kWh	ACT.NRG.EXP.TOT arrow left	Measures the total exported active energy.
3/20	kvarh	REACT.NRG.IMP.TOT arrow right	Measures the total imported reactive energy.
4/20	kvarh	REACT.NRG.EXP.TOT arrow left	Measures the total exported reactive energy.
5/20	kWh	ACT.NRG.IMP.TAR1 T1 blinks, arrow right	Measures the imported active energy for tariff 1
6/20	kWh	ACT.NRG.IMP.TAR2 T2 blinks, arrow right	Measures the imported active energy for tariff 2
7/20	kWh	ACT.NRG.IMP.TAR3 T3 blinks, arrow right	Measures the imported active energy for tariff 3





Page	Unit	Symbol on display	Explaining text
8/20	kWh	ACT.NRG.IMP.TAR4 T4 blinks, arrow right	Measures the imported active energy for tariff 4
9/20	kWh	ACT.NRG.EXP.TAR1 T1 blinks, arrow left	Measures the exported active energy for tariff 1
10/20	kWh	ACT.NRG.EXP.TAR2 T2 blinks, arrow left	Measures the exported active energy for tariff 2
11/20	kWh	ACT.NRG.EXP.TAR3 T3 blinks, arrow left	Measures the exported active energy for tariff 3
12/20	kWh	ACT.NRG.EXP.TAR4 T4 blinks, arrow left	Measures the exported active energy for tariff 4
13/20	kvarh	REACT.NRG.IMP.TAR1 T1 blinks, arrow right	Measures the imported reactive energy for tariff 1
14/20	kvarh	REACT.NRG.IMP.TAR2 T2 blinks, arrow right	Measures the imported reactive energy for tariff 2
15/20	kvarh	REACT.NRG.IMP.TAR3 T3 blinks, arrow right	Measures the imported reactive energy for tariff 3
16/20	kvarh	REACT.NRG.IMP.TAR4 T4 blinks, arrow right	Measures the imported reactive energy for tariff 4
17/20	kvarh	REACT.NRG.EXP.TAR1 T1 blinks, arrow left	Measures the exported reactive energy for tariff 1
18/20	kvarh	REACT.NRG.EXP.TAR2 T2 blinks, arrow left	Measures the exported reactive energy for tariff 2
19/20	kvarh	REACT.NRG.EXP.TAR3 T3 blinks, arrow left	Measures the exported reactive energy for tariff 3
20/20	kvarh	REACT.NRG.EXP.TAR4 T4 blinks, arrow left	Measures the exported reactive energy for tariff 4

Status Icons

The status icons that can be seen on the display are explained in the following table.

Table: 3:1

Icon	Indication
	Communication is in progress. The meter is either sending or receiving information.

Icon	Indication
	Metering in progress. Clockwise rotation indicates import. Counter clockwise rotation indicates export.
1-1 ←1 2-2→2 3-3-3	Arrows indicate direction of current per phase. Arrow left = export, arrow right = import. A digit without arrow indicates that only voltage is connected to the phase.
T1 T2 T3 T4	Active tariff.
 ! 	Error, warning, note
	Transformer ratio (only on transformer rated meters)

Main menu

Main menu text

Depending on the meter type all or a subset of the following text strings may be available in the display:

Text	Explanation
<i>rEG</i>	Energy registers
<i>Inst</i>	Instantaneous values
<i>I_O</i>	I/O
<i>STATUS</i>	Status
<i>SEt</i>	Settings
<i>Esc</i>	Previous menu

Main menu structure

The following table describes the main menu structure and its content:

<i>rEG</i>	<i>Inst</i>	<i>I_O</i>	<i>STATUS</i>	<i>SEt</i>
Active Energy Import L1-L3	Active Power	I/O 1	System Log	Clock
Active Energy Export L1-L3	Reactive Power	I/O 2	Event Log	Ratios
Active Energy Net L1-L3	Apparent Power	I/O 3	Net Quality Log	Wires
Reactive Energy Import L1-L3	Phase Voltage	I/O 4	System Status	Pulse Output
Reactive Energy Export L1-L3	Main Voltage		Audit Log	I/O
Reactive Energy Net L1-L3	Current		Settings Log	Alarm
Apparent Energy Export L1-L3	Power Factor			RS 485

<i>rEG</i>	<i>Inst</i>	<i>I₀</i>	<i>SEAEUS</i>	<i>SEt</i>
Apparent Energy Net L1-L3	Phase Angle Power			IR Side
Active Energy Import Tariff	Phase Angle Voltage			Upgrade Consent
Active Energy Export Tariff	Phase Angle Current			Pulse LED
Reactive Energy Import Tariff	Current Quadrant			Tariff
Reactive Energy Export Tariff				Resettable registers
Resettable Reactive Energy Export Total				

Chapter 4: Meter Settings

Overview

This chapter gives an overview of the meter settings and configuration options.

In this chapter

The following topics are covered in this chapter:

4.1 Settings and Configurations	31
4.1.1 Setting Ratios	31
4.1.2 Setting Wires	32
4.1.3 Setting Pulse Output	32
4.1.4 Setting I/O	33
4.1.5 Setting Alarm	33
4.1.6 Setting M-Bus	35
4.1.7 Setting RS485	36
4.1.8 Setting IR Side	36
4.1.9 Setting Upgrade Consent	39
4.1.10 Setting Pulse LED	39
4.1.11 Setting Tariff	39
4.1.12 Resetting Resettable Registers	39





4.1 Settings and Configurations

Configurable functions

Depending on the meter type, all or a subset of the following functions can be configured:







- Ratios
- Wires
- Pulse output (Pul.Out.) on display
- I/O
- Alarm
- M-Bus
- RS485
- IR Side
- Wireless (W-less on display)
- Upgrade Consent (Upgr.Cons) on display
- Pulse LED (Puls.LED) on display
- Tariff
- Resettable registers (Rst.Rg on display)

Setting a value

When setting a value, the  button is pressed and held to activate the set-option. The  button is used to change the options that can be set, such as on or off. The  button is used to toggle between digits. The option/digit that is active for setting is blinking, and stops blink when the option is selected by pressing the  button.

4.1.1 Setting Ratios



To set the ratios, perform the following steps:

1. Hold the  button for two seconds. Select 5E4, press .
2. Select 1E4, press .
3. To change the ratio, press and hold .
4. Press  for two seconds. Press  once. The display will show the quantity Voltage (Vt on the display) and the ratio. To change the ratio, press and hold .

4 static I/Os	1 static I/O
Transformer Current (Ct on the display)	1-9999/1-9
Transformer Voltage (Vt on the display)	1-999999/1-999



4.1.2 Setting Wires

The meter can either use three wires TPE or four wires TPE+N. To set the number of wires, perform the following steps:

1. Select **SET** in the main menu, press .
2. Select **WRES**, press .
3. The display will now show the wire configuration used by the meter.
4. Set the number of wires.

4.1.3 Setting Pulse Output

To set the pulse output, perform the following steps:

1. Select **SET** in the main menu, press .
2. Select “Pulse out” (**PULSE** on the display), press .
3. Select one of the pulse outputs, press .





The display will show **QUANT**.

4. Press  to set the energy type for the selected pulse output.

The display will show what type of energy is measured on the selected pulse output. Depending on meter type, the available choices are:

DISPLAY	Energy type	Unit
Act Ii	Active energy imported	kWh
Act EH	Active energy exported	kWh
rEA Ii	Reactive energy imported	kvarh
rEA EH	Reactive energy exported	kvarh
InAct	Inactive	—

Use **SET** to set the energy type. Press and hold **OK** to step back.

5. Press  once and **OK** to get to the next menu (**FREQ**). Display will show the frequency. The interval that can be set is 0–999999 imp/kWh or 0–999999 imp/MWh. The frequency is set one digit at the time. The digit active for setting is blinking. Use  to decrease/increase the digit. To change digit, use the arrow key. Press and hold **OK** to step back.
6. Press  once and **OK** to get to the next menu (**LENSE**). The display will show the pulse length in milliseconds. The interval for the pulse length is from 10 to 990 ms. The pulse is set in the same way as the frequency. Press and hold **OK** to step back.
7. Press  once and **OK** to get to the next menu (**OUTPUT**). The display will show the setting for the selected pulse output. Depending on the meter type, the available choices are:

4 static I/Os	1 static I/O
Off	Off
Out 1	Out 1
Out 2	–

Make the output setting. Press and hold OK twice to step back to the pulse selection menu.



Note – The option is set to “no output” when pressing the button.

- The first pulse output is now fully configured. Depending on the meter type, up to four pulse outputs can be set. If your meter supports multiple pulse outputs, then use to toggle down to the remaining pulse outputs and set them the same way as the first selected pulse output.

4.1.4 Setting I/O

To set the I/O, perform the following steps:

- Select **SEt** in the main menu, press .
- Select **I/O**, press .
- The display will now show **I/O**. To change I/O, use . To set an I/O, press the button. Different choices can be made for the I/O:
 - Alarm out (**ALARM**)
 - Communication out (**COMM**)
 - Pulse out (**PULSE**)
 - Tariff out (**TARIFF**)
 - Always on (**ON**)
 - Always off (**OFF**)

4.1.5 Setting Alarm

To set the alarm, perform the following steps:

- Select **SEt** in the main menu, press .
- Select **AL**, press .
- The display will show what quantity will be measured (**QUANT**). Depending on the meter type, different quantities are available. See *table 4:1* and

table 4:2 for available quantities and interval/units for the different quantities. Set the desired quantity.

4. Press once to get to the next menu. The display will show what level the alarm will trigger on (ON L_{EV}). Set the alarm level.
5. Press once to get to the next menu. The display will show the time that the measured value has to be higher than the limit set in the previous step in order for the alarm to trigger (ON dEL). Set the time limit.
6. Press once to get to the next menu. The display will show what level the alarm will cease on (OFF L_U). Set the alarm level.
7. Press once to get to the next menu. The display will show the time that the measured value has to be lower than the limit set in the previous step in order for the alarm to cease (OFF dE). Set the time limit.
8. Press once to get to the next menu. The display will show if the alarm will be logged or not (LOG). The available values are “on” and “off”. Set logging to on or off.
9. Press once to get to the next menu. The display will show what output the alarm is set on (or if no output is set; OUTPUT). The available choices are dependent on meter type, see table 4:3.
10. The first alarm is now fully configured. Depending on the meter type, up to four alarms can be set. If your meter supports multiple alarms, then use to set the remaining alarms the same way as the first alarm was configured.

Table: 4:1

1-phase meter	Interval/Unit
Inactive	–
Current L1	0.01–99.99 A/kA
Voltage L1	0.1–999.9 V/kV
Active power total	0–9999 W/kW/MW
Reactive power total	0–9999 W/kW/MW
Apparent power total	0–9999 W/kW/MW
Power factor total	0.000–0.999

Table: 4:2

3-phase meter	Interval/Unit
Inactive	–
Active power total	0–9999 W/kW/MW
Reactive Power Total	0–9999 W/kW/MW
Apparent Power Total	0–9999 W/kW/MW
Power factor total	0.000–0.999
Current L1	0.01–99.99 A/kA
Current L2	0.01–99.99 A/kA
Current L3	0.01–99.99 A/kA
Current N	0.01–99.99 A/kA
Voltage L1	0.1–999.9 V/kV







3-phase meter	Interval/Unit
Voltage L2	0.1–999.9 V/kV
Voltage L3	0.1–999.9 V/kV
Voltage L1–L2	0.1–999.9 V/kV
Voltage L2–L3	0.1–999.9 V/kV
Voltage L1–L3	0.1–999.9 V/kV
Active power L1	0–9999 W/kW/MW
Active power L2	0–9999 W/kW/MW
Active power L3	0–9999 W/kW/MW
Reactive power L1	0–9999 W/kW/MW
Reactive power L2	0–9999 W/kW/MW
Reactive power L3	0–9999 W/kW/MW
Apparent power L1	0–9999 W/kW/MW
Apparent power L2	0–9999 W/kW/MW
Apparent power L3	0–9999 W/kW/MW
Power factor L1	0.000–0.999
Power factor L2	0.000–0.999
Power factor L3	0.000–0.999

Table: 4:3

4 static I/Os	1 static I/O
No output	No output
Out 1	Out 1
Out 2	















4.1.6 Setting M–Bus

To set the wired M–Bus interface, perform the following steps:

1. Select **5E5** in the main menu, press .
2. Select **M-BUS**, press .
3. Press  once to get to the next menu (**baud**). The display will show the baudrate. See *Table 4:4* for baudrate options. Set baudrate.
4. Press  once to get to the next menu (**Addr-E5**). The display will show the address. See *Table 4:4* for address range. Set address.
5. Press  once to get to the next menu (**Acc-E55**). The display will show the access level. See *Table 4:4* for options. Set the access level.
6. Press  once to get to the next menu (**Send 5E**). The display will show the Send status info. See *Table 4:4* for options. Set the send info status.
7. Press  once to get to the next menu (**PASSW'd**). The display will show if the password is to be reset. See *Table 4:4* for options. Set the option.







4.1.7 Setting RS485











The RS485 uses the EQ-Bus and the Modbus protocol to communicate. To set the RS485 communication depending on protocol, perform the following steps:

Step	EQ-Bus	Modbus
1	Select <i>SEt</i> in the main menu, press  .	Select <i>SEt</i> in the main menu, press  .
2	Select <i>r5-485</i> , press  .	Select <i>r5-485</i> , press  .
3	Select <i>Protoc</i> , press  to see the selected protocol.	Select <i>Protoc</i> , press  to see the selected protocol. Press and hold OK to step back to the previous menu.
4	If required, then use S and F to set the protocol to EQ-Bus (<i>Eqbus</i>). The display will go back to the default menu. Go to <i>SEt >> r5-485</i> . If not required, then press and hold OK to step back to the previous menu.	If required, then use S and F to set the protocol to Modbus (<i>Modbus</i>). The display will go back to the default menu. Go to <i>SEt >> r5-485</i> . If not required, then press and hold OK to step back to the previous menu.
5	Press  once to get to the next menu. The display will show the baudrate (<i>baud</i>). See table <i>Table 4:4</i> for baudrate options. Set baudrate.	Press  once to get to the next menu. The display will show the baudrate (<i>baud</i>). See <i>Table 4:4</i> for baudrate options. Set baudrate.
6	Press  once to get to the next menu. The display will show the address (<i>AddrE5</i>). See <i>Table 4:4</i> for address range. Set address.	Press  once to get to the next menu. The display will show the address (<i>AddrE5</i>). See <i>Table 4:4</i> for address range. Set address.
7	Press  once to get to the next menu. The display will show the Oct.TO (<i>OctE</i>). See <i>Table 4:4</i> for options. Set oct.TO.	Press  once to get to the next menu. The display will show the Parity (<i>Parity</i>). See <i>Table 4:4</i> for options. Set Parity.
8	Press  once to get to the next menu. The display will show the Inac. TO (<i>InacE</i>). See <i>Table 4:4</i> for options. Set Inac. TO.	
9	Press  once to get to the next menu. The display will show if the password is to be reset (<i>Passwd</i>). See <i>Table 4:4</i> for options. Set the option	

4.1.8 Setting IR Side

The IR Side uses the M-Bus and the EQ-Bus¹ protocol to communicate. To set the IR Side communication depending on protocol, perform the following steps:

Step	M-Bus	EQ-Bus
1	Select <i>SEt</i> in the main menu, press  .	Select <i>SEt</i> in the main menu, press  .
2	Select <i>DPt</i> , press  . Select <i>Protoc</i> , press  .	Select <i>DPt</i> , press  . Select <i>Protoc</i> , press  .

Step	M-Bus	EQ-Bus
3	If required, then press  and set the protocol to M-Bus (M-BUS). The display will go back to the default menu. Go to SET >> OPT. If not required, then press and hold F to step back to the previous menu.	If required, then press  and set the protocol to EQ-Bus (EQ-BUS). The display will go back to the default menu. Go to SET >> OPT. If not required, then press and hold F to step back to the previous menu.
4	Press  once to get to the next menu (BAUD). The display will show the baudrate. See Table 4:4 for baudrate options. Set baudrate.	Press G once to get to the next menu (BAUD). The display will show the baudrate. See Table 4:4 for baudrate options. Set baudrate.
5	Press G once to get to the next menu (ADDR-E5). The display will show the address. See Table 4:4 for address range. Set address.	Press  once to get to the next menu (ADDR-E5). The display will show the address. See Table 4:4 for address range. Set address.
6	Press  once to get to the next menu (ACCESS). The display will show the access level. See Table 4:4 for options. Set the access level.	Press G once to get to the next menu (OCT. TO). The display will show the Oct. TO. See Table 4:4 for options. Set Oct. TO.
7	Press  once to get to the next menu (SEND ST). The display will show the Send status info. See Table 4:4 for options. Set the send info status.	Press  once to get to the next menu (INAC. TO). The display will show the Inac. TO. See Table 4:4 for options. Set Inac. TO.
	Press  once to get to the next menu (PASSWD). The display will show if the password is to be reset. See Table 4:4 for options. Set the option.	Press  once to get to the next menu (PASSWD). The display will show password reset option. Set if the password shall be reset or not.
	Press  once to get to the next menu (UPGRAD). The display will show the upgrade mode. See Table 4:4 for options. Set the upgrade mode.	

- i. EQ-Bus is a communication protocol designed for internal communication with ABB meters. The protocol is based on the following IEC standards; 62056-42, 62056-46, 62056-53, 62056-61, 62056-62.

Protocol details

The following table shows the intervals and options for the different protocols:



Table: 4:4

Protocol	Access level	Upgrade mode	Send Status Info	Reset password	Parity	Baudrate	Address	Inter octet timeout (ms)	Inactivity timeout (ms)
EQ-Bus (when used through RS485)	–	–	–	Yes, No	–	1200, 2400, 4800, 9600, 19200, 38400, 57600, 115200, 125000, 230400, 250000, 460800	16–16381	20–6000	0–2000
Modbus (when used through RS485)	–	–	–	–	None, Odd, Even	1200, 2400, 4800, 9600, 19200, 38400, 57600, 115200	1–247	–	–
M-Bus (when used through IR-Side)	Open, Pass- word, Closed	Active, Not Ac- tive	Al- ways, Never, When not OK	Yes, No	–	2400, 4800, 9600, 19200, 38400	1–250	–	–
EQ-Bus (when used through IR-Side)	–	–	–	Yes, No	–	1200, 2400, 4800, 9600, 19200, 38400, 57600, 115200, 125000, 230400			

4.1.9 Setting Upgrade Consent



Upgrade Consent can be set to *Allowed* or *Not Allowed*. Setting it to *Allowed* means you agree to updates of the meter. Setting it to *Not Allowed* means no upgrades will take place.

To set Upgrade Consent, perform the following steps:

1. Select *SET* in the main menu, press .
2. Select “Upgrade Consent” (*UPGR* on the display), press .
3. Press  to set Upgrade Consent.







4.1.10 Setting Pulse LED

To set pulse LED, perform the following steps:

1. Select *SET* in the main menu, press .
2. Select “Pulse LED” (*PU LED* on the display), press .
3. Press  to set the type of energy that the LED shall indicate on.



4.1.11 Setting Tariff

The tariff source can be set to input, or communication. To set the tariffs, perform the following steps:

Step	Input	Communication
1	Select <i>SET</i> in the main menu, press  .	Select <i>SET</i> in the main menu, press  .
2	Select <i>TAR OFF</i> , press  .	Select <i>TAR OFF</i> , press  .
3	Press  and select Input (<i>INPUT</i>).	Press  and select Comm (<i>COMM</i>).
4	Use  to toggle to the first configuration. Four configurations are available. Set the tariff that shall be active for each configuration.	The tariff source is now set for communication.
5	–	–

4.1.12 Resetting Resettable Registers

To reset registers, perform the following steps:

1. Select *SET* in the main menu, press .
2. Select “Resettable registers” (*RESET R* on the display), press .
3. The display will show the different registers to reset. Depending on the meter type, the available choices are:

Register	On the display
Active Energy Imported Total	<i>A_{ct} I_∑</i>
Active Energy Exported Total	<i>A_{ct} E_H</i>
Reactive Energy Imported Total	<i>rEA I_∑</i>
Reactive Energy Exported Total	<i>rEA E_H</i>
Reset all	<i>A_{LL}</i>

4. Toggle through the pages and reset the desired registers.

Chapter 5: Technical Description

Overview

This chapter contains technical descriptions of the meter functions. Depending of the meter type, the meter may contain all or a subset of the functions described in this chapter.

In this chapter

The following topics are covered in this chapter:

5.1	Energy Values	43
5.2	Instrumentation	45
5.3	Alarm	47
5.4	Inputs and Outputs	48
	5.4.1 Tariff Inputs	48
	5.4.2 Pulse Outputs	49
5.5	Logs	51
	5.5.1 System Log	51
	5.5.2 Event Log	52
	5.5.3 Net Quality Log	53
	5.5.4 Audit Log	53
	5.5.5 Settings Log	54
	5.5.6 Event codes	54

5.1 Energy Values

General

The energy values are stored in energy registers. The different energy registers can be divided into:

- Registers containing active, reactive or apparent energy
- Registers containing imported or exported energy.
- Registers containing net energy
- Registers containing different tariffs
- Registers containing total energy and energy per phase
- Resettable registers (possible to set to zero via buttons or communication)

The energy values can be read via communication or directly in the display with the help of the buttons.

Energy calculation method

Import energy registers increments when the power is positive and export energy registers increments when power is negative. All import and export registers are positive (or zero) and will either increment or stand still.

Net energy registers contains the import minus the export register for corresponding registers and can be positive or negative. Note that meters of steel type (type designation B23/B24 1xx-xxx) only contain import registers.

The ABB EQ meters use the vector registration method for computation of energy. In the vector registration method the instantaneous energy consumption of the measuring elements (the three phases in 3-phase 4-wire metering) is summed up to the total register. If the sum is positive the import register is incremented and if the sum is negative the export register is incremented. Say for example that the power in the three phases are L1: +1 kW, L2: -1 kW and L3: +1 kW. The total power will then be $1 - 1 + 1 = 1$ kW and the total import register will increase at a rate of 1 kWh each hour and the total export register will stand still. If the power in the three phases instead are L1: +1 kW, L2: -1 kW and L3: -1 kW the total power will be $1 - 1 - 1 = -1$ kW and the total export register will increase with the rate of 1 kWh each hour and the total import register will stand still.

Note that if a 3-phase load with neutral have connections between the phases that have a power factor smaller than 0.5, that is constitute a mainly reactive load, the power in single phases can be negative even if the 3-phase load is consuming energy. The total power and energy will however always be positive for a 3-phase load that is consuming energy.

Note also that the sum of the per phase registers will be bigger than the total register if the power in the phases contains a mix of both positive and negative power. In applications where the load is a 3-phase load the total register should always be used for billing.

The per phase energy registers works as separate single phase meters for its respective phase and the import registers will increment when the power is positive, and the export registers will increment when the power is negative. The per phase registers should only be used for billing in applications where the loads are pure single phase loads.

Primary value

In transformer connected meters with external current transformers, and some-times also external voltage transformers, the register value is multiplied by the total transformer ratio before it is presented on the display or sent out via communication. This value is called primary value.

Presentation of register values

In direct connected meters the energy is usually displayed with a fixed unit and number of decimals (normally kWh, with no decimals). In transformer connected meters where primary values are displayed, the energy values can be rather big when the total transformer ratio is big. Normally the meter automatically adapts the unit and number of decimals displayed to the value. In case the energy is displayed with fixed units and number of decimals the energy will “roll over” to zeros when the energy is incremented if all nines are displayed. The meter can however contain more digits internally, which can be read out via communication if the meter is equipped with a communication interface. See the example below where the value 2483756.6 is displayed, while the internal register contains 192483756.6.

Image

The following picture shows a display with fixed unit and numbers of decimals:

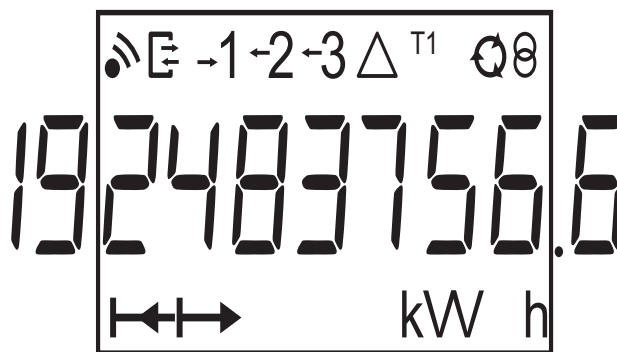

5.2 Instrumentation

Instrumentation functions

The following table shows the complete instrumentation functions of the B23/B24 meters. Depending on the meter type all or a subset of the following functions are available.

Instrumentation	3-phase, 4-wire	3-phase, 3-wire
Active power, total	X	X
Active power, L1	X	X
Active power, L2	X	
Active power, L3	X	X
Reactive power, Total	X	X
Reactive power, L1	X	X
Reactive power, L2	X	
Reactive power, L3	X	X
Apparent power, Total	X	X
Apparent power, L1	X	X
Apparent power, L2	X	
Apparent power, L3	X	X
Voltage L1 – N	X	
Voltage L2 – N	X	
Voltage L3 – N	X	
Voltage L1 – L2	X	X
Voltage L3 – L2	X	X
Voltage L1 – L3	X	
Current L1	X	X
Current L2	X	
Current L3	X	X
Current N	X	
Frequency	X	X
Power factor, Total	X	X
Power factor, L1	X	X
Power factor, L2	X	
Power factor, L3	X	X
Phase angle power, Total	X	X
Phase angle power, L1	X	X
Phase angle power, L2	X	
Phase angle power, L3	X	X
Phase angle voltage, L1	X	X
Phase angle voltage, L2	X	
Phase angle voltage, L3	X	X
Phase angle current, L1	X	X
Phase angle current, L2	X	

Instrumentation	3-phase, 4-wire	3-phase, 3-wire
Phase angle current, L3	X	X
Current quadrant, Total	X	X
Current quadrant, L1	X	X
Current quadrant, L2	X	
Current quadrant, L3	X	X

Accuracy

All instrumentation data accuracy is defined within the voltage range 20% of the stated nominal voltage and within the current range 5% of the base current to the maximum current.

The accuracy of all instrumentation data except the voltage and current phase-angles is the same as the stated energy metering accuracy. The accuracy for the voltage and current phase-angles is 2 degrees.

5.3 Alarm

General

The purpose of the alarm function is to enable monitoring of quantities in the meter. Monitoring can be set to high or low level detection. High level detection gives an alarm when the level of a quantity goes above the set level. Low level detection gives an alarm when the value goes below the set level.

It is possible to configure 25 alarms. Configuration can be done via communication or with the buttons directly on the meter.

Quantities

Depending on the meter type all or a subset of the following quantities can be monitored:

Voltage L1	Active power L3
Voltage L2	Reactive power total
Voltage L3	Reactive power L1
Voltage L1–L2	Reactive power L2
Voltage L2–L3	Reactive power L3
Voltage L1–L3	Apparent power total
Current L1	Apparent power L1
Current L2	Apparent power L2
Current L3	Apparent power L3
Current N	Power factor total
Active power total	Power factor L1
Active power L1	Power factor L2
Active power L2	Power factor L3

Functional description

When the value of the monitored quantity passes the activation level, and remains there for a period of time equal or longer than the specified time delay, the alarm is activated. In the same way, the alarm is deactivated when the value passes the deactivation level and remains there for a time equal or longer than the specified time delay.

If the activation level is higher than the deactivation level, then the alarm is activated when the value of the monitored quantity is higher than the activation level.

If the activation level is lower than the deactivation level, then the alarm is activated when the value of the monitored quantity is lower than the activation level.

5.4 Inputs and Outputs

General

Inputs/outputs are built with optocouplers and are galvanically isolated from other meter electronics. They are polarity independent and handle both DC and AC voltage.

An input that is not connected equals having its voltage off.

The equivalent circuitry of the outputs is an ideal relay in series with a resistor.

Functionality of inputs

The inputs count pulses, register activity and current status and the data can be read directly on the meter display or via communication

Register activity can be reset via communication or via the buttons directly on the meter.

Functionality of outputs

The outputs can be controlled by communication or alarm.

5.4.1 Tariff Inputs

Tariff control

On meters with tariff functionality, the tariffs are controlled either via communication or by 1 or 2 tariff inputs.

Tariff control via inputs is done by applying a proper combination of "voltage" or "no voltage" to the input(s). Each combination of "voltage"/"no voltage" will result in that the meter will register the energy in a particular tariff register.

In combined meters with both active and reactive metering, both quantities are controlled by the same inputs and the active tariff for active and reactive energy will always be the same.

Indication of active tariff

The active tariff is displayed on the LCD by the text "Tx" in the status field, where x is the tariff number. The active tariff can also be read via communication.

Input coding, meters with 4 tariffs

The coding of the inputs is binary. The following table describes the default coding.

Input 4	Input 3	Tariff
OFF	OFF	= T1
OFF	ON	= T2
ON	OFF	= T3
ON	ON	= T4

Input coding, meters with 2 tariffs

The coding of the inputs is binary. The following table describes the default coding.

Input 3	Tariff
OFF	= T1
ON	= T2

5.4.2 Pulse Outputs

About pulse outputs

On the pulse outputs the meter sends out a specified number of pulses (pulse frequency) per kilowatt hour (kilovar for reactive pulse outputs).

The pulse outputs are primary, which means that the pulses are sent out in proportion to the true primary energy, taking current transformer ratios (CT ratio) programmed on the meter into account.

For direct connected meters no external transformers are used and the amount of pulses sent out are in proportion to the energy flowed through the meter.

5.4.2.1 Pulse Frequency and Pulse length

General

Pulse frequency and pulse length can be set via the buttons on the meter or via communication. If the meter have more than 1 pulse output, then all outputs will have the same pulse frequency and pulse length.

Pulse frequency

The pulse frequency is configurable and can be set to a value between 1–9999 impulses. The value must be an integer. The unit is selectable and may be set to imp/kWh, imp/Wh or imp/MWh.

Pulse length

The pulse length can be set to a value between 10–990 ms.

Deciding pulse frequency/length

If the power is too high for a certain pulse length and pulse frequency, then there is a risk that the pulses may go into one another. If this happens then the meter will emit a new pulse (relay closed) before the previous one has terminated (relay open) and the pulse will be missed. In worst case the relay may be closed at all times.

To avoid this problem a calculation should be made to work out the maximum pulse frequency allowed at a particular site based upon an estimated maximum power and the meter's pulse output data.

Formula

The formula to use for this calculation is:

$$\text{Max pulse frequency} = 1000 * 3600 / U / I / n / (P_{\text{pause}} + P_{\text{length}})$$

where U and I is the estimated maximum element voltage (in volts) and current (in amperes), n the number of elements (1 – 3). Plength and Ppause are the pulse length and the required pulse pause (in seconds). A reasonable minimum pulse length and pulse pause is 30 ms which conforms to the S0 and IEC standard.



Note – U and I have to be the primary values in a transformer connected meter if the CT and VT for the external transformers are programmed into the meter.

Example 1

In a direct connected 3–element meter with estimated maximum voltage and current of 250 V and 65 A and pulse length 100 ms and required pulse pause 30 ms, the maximum allowed pulse frequency will be:

$$1000 * 3600 / 250 / 65 / 3 / (0.030 + 0.100) = 568 \text{ impulses / kWh (kvarh)}$$

Example 2

In a transformer connected 3–element meter with estimated maximum voltage and current of 63 V and $6 * 50 \text{ A} = 300 \text{ A}$ (CT ratio 50) and pulse width 100 ms and required pulse pause 30 ms the maximum allowed pulse frequency will be:

$$1000 * 3600 / 63 / 300 / 3 / (0.030 + 0.100) = 488.4 \text{ impulses / kWh (kvarh)}$$

5.5 Logs

General

The meter contains a total of five different logs:

- System Log
- Event Log
- Net Quality Log
- Audit log
- Settings Log

Log events can be read via communication or directly in the display of the meter.

A maximum of 500 log events can be stored in the System Log, the Event Log and the Net Quality Log. When the maximum number of events for a log is reached, the oldest events will be overwritten.

A maximum of 40 log events can be stored in the Audit Log. When the maximum number of events for this log is reached, no more events can be stored. A new firmware upgrade attempt will be unsuccessful because no more log events can be stored.

A maximum of 80 log events can be stored in the Settings Log. When the maximum number of events for this log is reached, no more events can be stored. A new setting for either CT or number of elements will not be accepted because no more log events can be stored.

It is possible to delete all entries in the System Log, The Event Log and the Net Quality Log via communication.

5.5.1 System Log

This log stores events that relate to errors in the meter.

Contents

The following information is stored in an event:

- Date and time
- Event Code
- Duration

The following events are stored in this log:

- Program CRC Error – Error when checking firmware consistency.
 - Persistent Storage Error – Data stored in long-term memory is corrupt.
-

5.5.2 Event Log

This log stores events that relate to alarms and configuration warnings.

Contents

The following information is stored in an event:

- Date and Time
- Event Code
- Duration

The following events are stored in this log:

- Date Not Set Warning – Date has not been configured for RTC.
 - Time Not Set Warning – Time has not been configured for RTC.
 - Negative Power Element 1 Warning – Element 1 measures negative power.
 - Negative Power Element 2 Warning – Element 2 measures negative power.
 - Negative Power Element 3 Warning – Element 3 measures negative power.
 - Negative Total Power Warning – Total power is measured as negative.
 - Alarm Current L1
 - Alarm current L2
 - Alarm Current L3
 - Alarm Current Neutral
 - Alarm Active Power Total
 - Alarm Active Power L1
 - Alarm Active Power L2
 - Alarm Active Power L3
 - Alarm Reactive Power total
 - Alarm Reactive Power L1
 - Alarm Reactive Power L2
 - Alarm Reactive Power L3
 - Alarm Apparent power Total
 - Alarm Apparent power L1
 - Alarm Apparent power L2
 - Alarm Apparent power L3
 - Alarm Power Factor Total
 - Alarm Power Factor L1
 - Alarm Power Factor L2
 - Alarm Power Factor L3
-

5.5.3 Net Quality Log

This log stores alarms and information that relates to net quality.

Contents

The following events are stored in this log

- U1 Missing Warning – U1 is missing
 - U2 Missing Warning – U2 is missing
 - U3 Missing Warning – U3 is missing
 - Frequency Warning – Net frequency is not stable
 - Alarm Voltage L1
 - Alarm Voltage L2
 - Alarm Voltage L3
 - Alarm Voltage L1–L2
 - Alarm Voltage L2–L3
 - Alarm Voltage L1–L3
-

5.5.4 Audit Log

The Audit Log stores an event after an attempt has been made to upgrade the firmware.

Firmware upgrade on the meter can only be performed by the administrator–user via the EQ Bus protocol. Any firmware upgrade attempt stored in the audit log has been initiated by the administrator–user.

Contents

The following information is stored in an event:

- Firmware version
 - Active Energy import
 - Active Energy import L1
 - Active Energy import L2
 - Active Energy import L3
 - Active Energy import Tariff 1
 - Active Energy import Tariff 2
 - Active Energy import Tariff 3
 - Active Energy import Tariff 4
 - Active Energy Export
 - Firmware Upgrade status
-

5.5.5 Settings Log

This log stores an event when the transformer ratio is reconfigured.

Contents

The following information is stored in an event:

- Firmware version
- Active Energy import
- Active Energy import L1
- Active Energy import L2
- Active Energy import L3
- Active Energy import Tariff 1
- Active Energy import Tariff 2
- Active Energy import Tariff 3
- Active Energy import Tariff 4
- Active Energy Export
- CT-Value
- Elements

5.5.6 Event codes

Description

The following table describes the event codes that may occur in the System log, the Event log and the Net Quality log:

Event code	Event
41	Program CRC Error
42	Persistent Storage Error
1000	U1 Missing Warning
1001	U2 Missing Warning
1002	U3 Missing Warning
1004	Negative Power Element 1 Warning
1005	Negative Power Element 2 Warning
1006	Negative Power Element 3 Warning
1007	Negative Total Power Warning
1008	Frequency Warning
2013	Alarm 1 active
2014	Alarm 2 active
2015	Alarm 3 active
2016	Alarm 4 active
2017	Alarm 5 active
2018	Alarm 6 active
2019	Alarm 7 active

Technical Description

Event code	Event
2020	Alarm 8 active
2021	Alarm 9 active
2022	Alarm 10 active
2023	Alarm 11 active
2024	Alarm 12 active
2025	Alarm 13 active
2026	Alarm 14 active
2027	Alarm 15 active
2028	Alarm 16 active
2029	Alarm 17 active
2030	Alarm 18 active
2031	Alarm 19 active
2032	Alarm 20 active
2033	Alarm 21 active
2034	Alarm 22 active
2035	Alarm 23 active
2036	Alarm 24 active
2037	Alarm 25 active

Chapter 6: Technical data

Overview

This chapter contains technical data and product drawings.

In this chapter

The following topics are covered in this chapter:

6.1 Technical Specifications	57
6.2 Physical dimensions	61

6.1 Technical Specifications

Specifications for B23 direct connected meters

Voltage/current inputs	
Nominal voltage	3x230/400 VAC
Voltage range	3x220–240 VAC (-20% – +15%)
Power dissipation voltage circuits	1.6 VA (0.7 W) total
Power dissipation current circuits	0.007 VA (0.007 W) per phase at 230 VAC and I_b
Base current I_b	5 A
Reference current I_{ref}	5 A
Transitional current I_{tr}	0.5 A
Maximum current I_{max}	65 A
Minimum current I_{min}	0.25 A
Starting current I_{st}	< 20 mA
Terminal wire area	1–25 mm ²
Recommended tightening torque	3 Nm
General data	
Frequency	50 or 60 Hz ± 5%
Accuracy Class	B (Cl. 1) and Reactive Cl. 2
Active energy	1%
Display of energy	7-digit LCD
Mechanical	
Material	Polycarbonate in transparent front glass. Glass reinforced polycarbonate in bottom case and upper case. Polycarbonate in terminal cover.
Weight	
Environmental	
Operating temperature	-40°C to +70°C
Storage temperature	-40°C to +85°C
Humidity	75% yearly average, 95% on 30 days/year
Resistance to fire and heat	Terminal 960°C, cover 650°C (IEC 60695-2-1)
Resistance to water and dust	IP 20 on terminal block without protective enclosure and IP 51 in protective enclosure, according to IEC 60529.
Mechanical environment	Class M1 in accordance with the Measuring Instrument Directive (MID), (2014/32/UE).
Electromagnetic environment	Class E2 in accordance with the Measuring Instrument Directive (MID), (2014/32/UE).
Outputs	
Current	2–100 mA
Voltage	24 VAC–240 VAC, 24 VDC–240 VDC. For meters with only 1 output 5–40 VDC.
Pulse output frequency	Prog. 1–999999 imp/MWh, 1–999999 imp/kWh, 1–999999 imp/Wh

Pulse length	10–990 ms
Terminal wire area	0.5–1 mm ²
Recommended tightening torque	0.25 Nm
Inputs	
Voltage	0–240 V AC/DC
Off	0–12 V AC/DC
ON	57–240 V AC/24–240 V DC
Min. pulse length	30 ms
Terminal wire area	0.5–1 mm ²
Recommended tightening torque	0.25 Nm
Communication	
Terminal wire area	0.5–1 mm ²
Recommended tightening torque	0.25 Nm
M-Bus	EN 13757-2, EN 13757-3
Modbus	Modbus Application Protocol Specification V1.1b
EQ-Bus	IEC 62056-42, 62056-46, 62056-53, 62056-61, 62056-62
Pulse indicator(LED)	
Pulse Frequency	1000 imp/kWh
Pulse length	40 ms
EMC compatibility	
Impulse voltage test	6 kV 1.2/50µs (IEC 60060-1)
Surge voltage test	4 kV 1.2/50µs (IEC 61000-4-5)
Fast transient burst test	4 kV (IEC 61000-4-4)
Immunity to electromagnetic HF-fields	80 MHz–2 GHz at 10 V/m (IEC 61000-4-3)
Immunity to conducted disturbance	150kHz–80MHz, (IEC 61000-4-6)
Immunity to electromagnetic disturbances	2–150 kHz for kWh-meters
Radio frequency emission	EN 55022, class B (CISPR22)
Electrostatic discharge	15 kV (IEC 61000-4-2)
Standards	IEC 62052-11, IEC 62053-21 class 1 & 2, IEC 62053-23 class 2, GB/T 17215.211-2006, GB/T 17215.321-2008 class 1 & 2, GB 4208-2008, EN 50470-1, EN 50470-3 category B.

Specifications for B24 transformer connected meter

Voltage inputs	
Nominal voltage	3x230/400 VAC
Voltage range	3x220–240 VAC (-20% – +15%)
Power dissipation voltage circuits	1.6 VA (0.7 W) total
Power dissipation current circuits	0.007 VA (0.007 W) per phase at 230 VAC and I _b
Terminal wire area	0.5–10 mm ²
Recommended tightening torque	1.5 Nm

Technical data

Current inputs	
Rated current I_n	1 A
Maximum current I_{max}	6 A
Transitional current I_{tr}	0.05 A
Minimum current I_{min}	0.02 A
Starting current I_{st}	< 1 mA
Terminal wire area	0.5–10mm ²
Recommended tightening torque	1.5 Nm
General data	
Frequency	50 or 60 Hz ± 5%
Accuracy Class	B (Cl. 1) or C (Cl. 0,5 S) and Reactive Cl. 2
Active energy	0.5%, 1%
Display	7-digit LCD
Mechanical	
Material	Polycarbonate in transparent front glass. Glass reinforced polycarbonate in bottom case and upper case. Polycarbonate in terminal cover.
Weight	
Environmental	
Operating temperature	-40°C to +70°C
Storage temperature	-40°C to +85°C
Humidity	75% yearly average, 95% on 30 days/year
Resistance to fire and heat	Terminal 960°C, cover 650°C (IEC 60695-2-1)
Resistance to water and dust	IP 20 on terminal block without protective enclosure and IP 51 in protective enclosure, according to IEC 60529.
Mechanical environment	Class M1 in accordance with the Measuring Instrument Directive (MID), (2014/32/UE).
Electromagnetic environment	Class E2 in accordance with the Measuring Instrument Directive (MID), (2014/32/UE).
Outputs	
Current	2–100 mA
Voltage	24 VAC–240 VAC, 24 VDC–240 VDC. For meters with only 1 output 5–400 VDC.
Pulse output frequency	Prog. 1–999999 imp/MWh, 1–999999 imp/kWh, 1–999999 imp/Wh
Pulse length	10–990 ms
Terminal wire area	0.5–1 mm ²
Recommended tightening torque	0.25 Nm
Inputs	
Voltage	0–240 V AC/DC
Off	0–12 V AC/DC
ON	57–240 V AC/24–240 V DC
Min. pulse length	30 ms
Terminal wire area	0.5–1 mm ²

Recommended tightening torque	0.25 Nm
Communication	
Terminal wire area	0.5–1 mm
Recommended tightening torque	0.25 Nm
M-Bus	EN 13757-2, EN 13757-3
Modbus	Modbus Application Protocol Specification V1.1b
EQ-Bus	IEC 62056-42, 62056-46, 62056-53, 62056-61, 62056-62
Transformer ratios	
Configurable current ratio (CT)	1/9–9999/1
Pulse indicator (LED)	
Pulse Frequency	5000 imp/kWh
Pulse length	40 ms
EMC compatibility	
Impulse voltage test	6 kV 1.2/50µs (IEC 60060-1)
Surge voltage test	4 kV 1.2/50µs (IEC 61000-4-5)
Fast transient burst test	4 kV (IEC 61000-4-4)
Immunity to electromagnetic HF-fields	80 MHz–2 GHz at 10 V/m (IEC61000-4-3)
Immunity to conducted disturbance	150kHz–80MHz, (IEC 61000-4-6)
Immunity to electromagnetic disturbances	2–150 kHz for kWh-meters
Radio frequency emission	EN 55022, class B (CISPR22)
Electrostatic discharge	15 kV (IEC 61000-4-2)
Standards	IEC 62052-11, IEC 62053-21 class 1 & 2, IEC 62053-22 class 0,5 S, IEC 62053-23 class 2, GB/T 17215.211-2006, GB/T 17215.321-2008 class 1 & 2, GB/T 17215.322-2008 class 0,5 S, GB 4208-2008, EN 50470-1, EN 50470-3 category B & C.

6.2 Physical dimensions

B23 The following drawing shows the physical dimensions of the B23 meters.

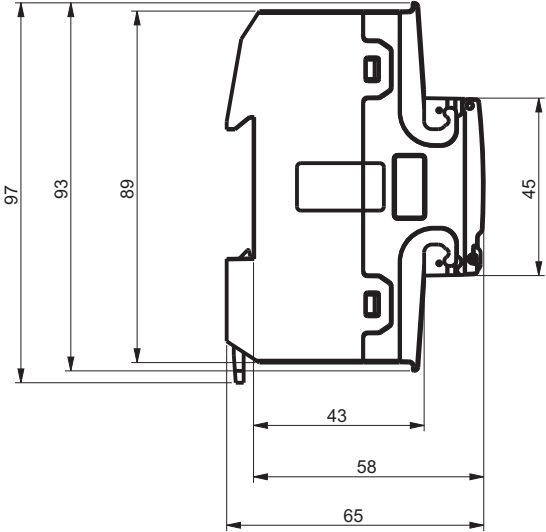
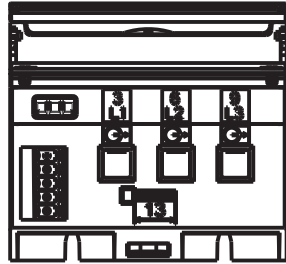
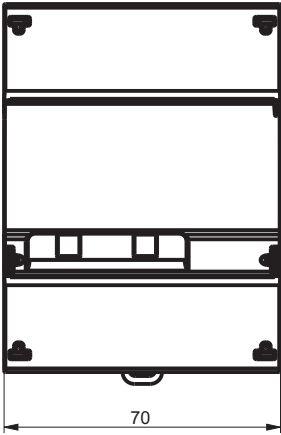
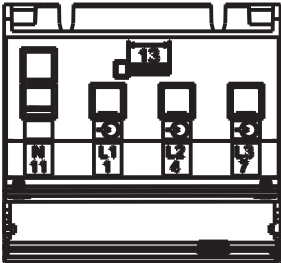

B24

The following drawing shows the physical dimensions of the B24 meters.

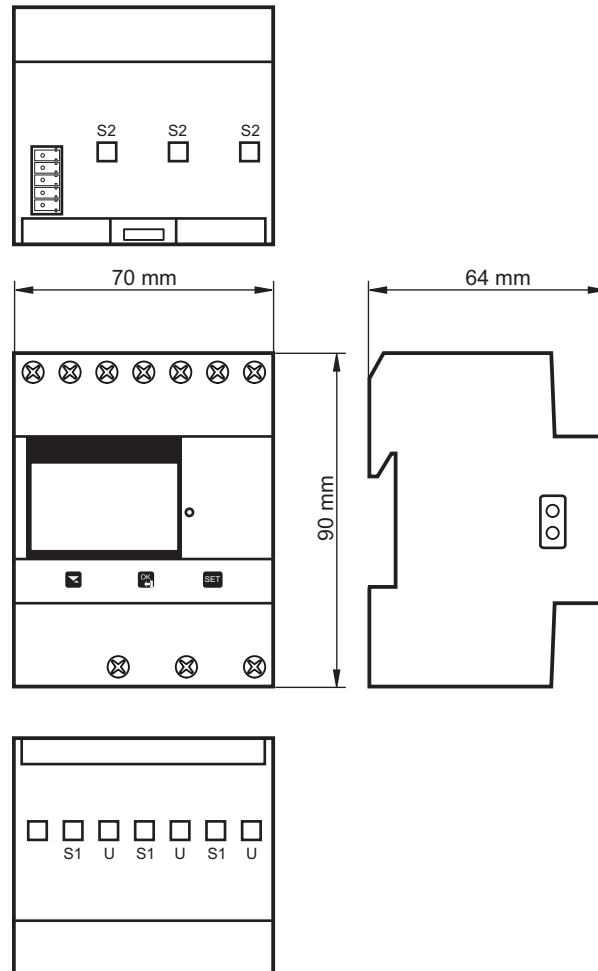

Chapter 7: Measurement Methods

Overview

This chapter contains information about measurement theory and the most commonly used measurement methods. The information can be used to better understand the meter behavior and/or to pick the correct measurement method.

In this chapter

The following topics are covered in this chapter:

7.1 Measuring Energy	65
7.1.1 Single Phase, 1-Element Metering	67
7.1.2 3-Phase, 2-Element Metering	69
7.1.3 3-Phase, 3-Element Metering	71

7.1 Measuring Energy

Active energy

It is easy to understand the need for a utility to measure active energy, since the information is necessary to bill the customer correctly. Usually the more energy the customer consumes the higher the accuracy of the meter needs to be. Normally 4 accuracy classes are used: 2%- (small consumers, e.g. households), 1%-, 0.5%- and 0.2%-meters with defined power levels for each class.

Also from a customer point of view it is easy to understand the need to measure the active energy as it can give him information about where and when energy is consumed. This information can then be used to take measures to decrease the consumption.

In many cases it is desired to simplify the measurement. In such cases simplified methods can be used of which the most common are described in this chapter. These methods most often require a balanced load, which means that the impedance is the same in all phases giving the same current amplitude and power factor in all phases.



Note – It should be mentioned that even if the load is perfectly balanced the accuracy will be decreased if the incoming voltages are not the same on all phases.

Reactive energy

Sometimes there is also a need to measure the reactive energy. Consumer equipment often introduces a phase shift between current and voltage due to the fact that the load has a more or less reactive component, e.g. motors that have an inductive component, etc. A reactive load will increase the current which means that the power source generator and the size of the power lines have to increase which in turn means higher cost for the utility. A higher current also means that the line losses increase.

Because of that, the maximum permissible phase shift is sometimes governed in the terms of the contract that the consumer have with the power supplier. If the consumer exceeds a specified maximum reactive load, then he will be liable for an extra charge. This type of contract will require a utility meter that measures reactive energy and/or power.

Also, from the customer's point of view, it may be of some interest to measure reactive energy/power since it gives him knowledge about the nature of the load. That is, how big the different loads are and how they vary over time. This knowledge can be used in the planning how to decrease the reactive power/energy to decrease the electricity bill.

Resistive, inductive and capacitive loads

Resistive loads don't give rise to any phase shifts. Inductive loads have phase shift in one direction with the current lagging the voltage, while capacitive loads produces a phase shift in the opposite direction with the current leading the voltage. As a result, inductive and capacitive loads can be used to compensate each other

Illustration

The following illustration shows a vector diagram for resistive, inductive and capacitive loads:

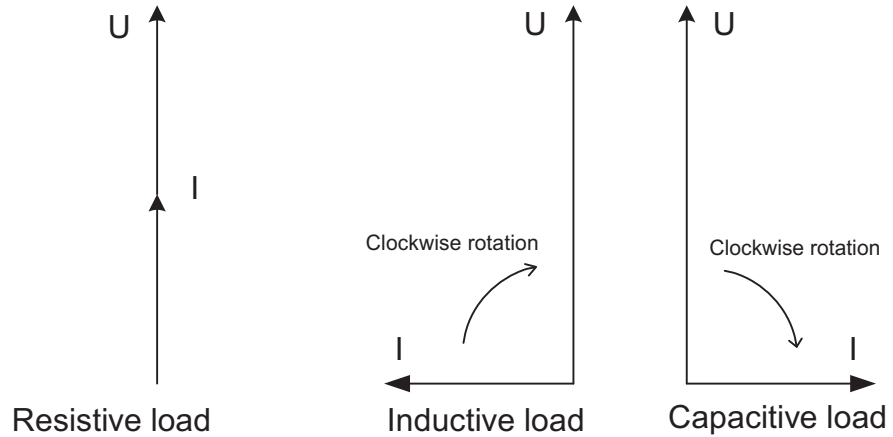

Phase displacement

A load that consumes both reactive and active energy can be divided into active and reactive components. The angle between the apparent power ($U \cdot I$) vector and the active power component is described as phase displacement angle or power factor angle, often referred to as ϕ . $\cos \phi$ is referred to as the power factor.

Illustration

The following illustration shows a vector diagram for a load with an active and a reactive component:

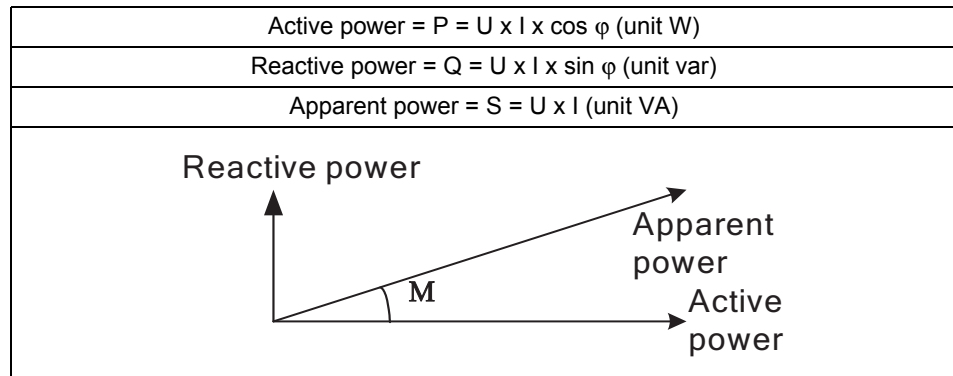

The 4 power quadrants

The type of load can be represented geometrically by four quadrants. In the first quadrant the load is inductive and active and energy is imported (energy is delivered from the utility to the customer). In the second quadrant the load is capacitive and active energy is exported and reactive energy is imported. In the third quadrant the load is inductive and active and reactive energy is exported. In the last quadrant the load is capacitive and active energy is imported and reactive energy exported.

Illustration

The following illustration shows the loads

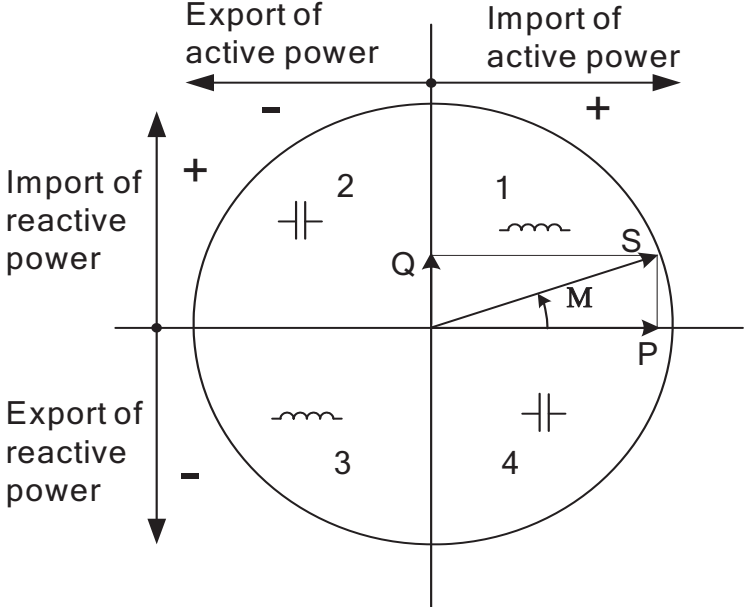

7.1.1 Single Phase, 1-Element Metering

1- element metering in a 2-wire system

In a 2-wire installation a single phase meter is used. Normally the 2 wires are a phase voltage and the neutral.

The active energy consumed by the load is the product of momentary voltage and current integrated over the desired measuring time period.

Calculating active power

In the case where no harmonics is present and the rms value of the voltage and current is constant, the active power can be expressed as:

$$P = U_{rms} * I_{rms} * \cos \varphi$$

where φ is the phase angle between the voltage and the current.

Illustration

The following illustration shows a direct connected single phase meter measuring the active energy (E) consumed by a load.

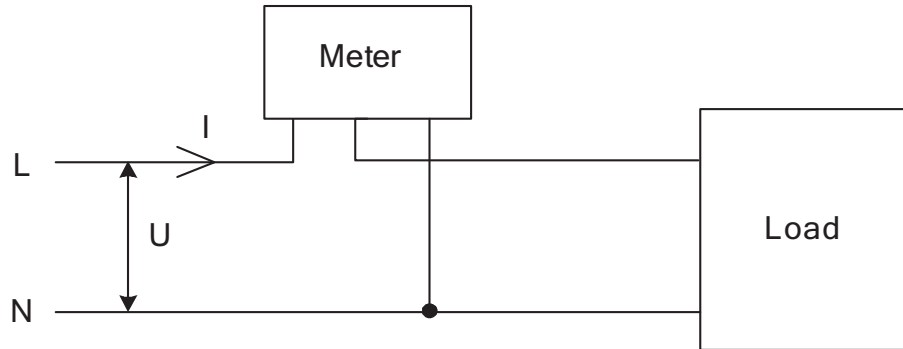

1-element metering in a 4-wire system

In 4-wire system the single element metering method only gives correct results in a balanced system (same voltage, current and power factor in all phases). This method should not be used for accurate measurement, but can be used when high accuracy is not needed.

Illustration

The following illustration shows single phase metering in a 3-phase system.

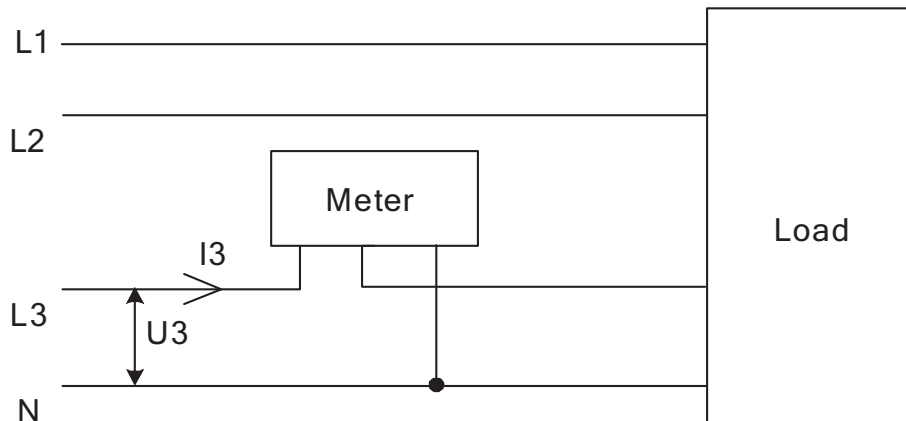

7.1.2 3-Phase, 2-Element Metering

2-element metering in a 3-wire system

The 2-element metering method is used in systems with 3 wires, normally a 3-phase system that does not have a neutral conductor. A 2-element meter can be used irrespectively of the load being balanced or not.

In a 2-element meter the L2 voltage is used as the voltage reference and the voltage difference between that voltage and the L1 and L3 voltage are measured and multiplied by its respective current. The active energy consumed by the load is the product of momentary voltages $U1-U2$ and $U3-U2$ and the currents $I1$ and $I2$ integrated over the desired measuring time period.

Illustration

The following diagram shows a 2-element meter measuring the active energy (E) consumed by a load.

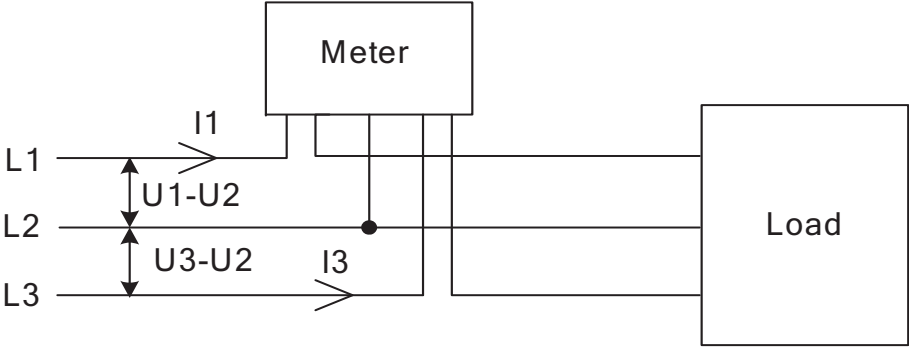

Calculating total active power

If the rms values of the voltages and currents are constant, then the total active power can be expressed as:

$$P_{tot} = P1 + P3 = (U1-U2) \times I1 \times \cos \phi_{12} + (U3-U2) \times I3 \times \cos \phi_{32}$$

Illustration

The following vector diagram shows the vectors for the phase voltages ($U1, U2, U3$), the phase currents ($I1, I2, I3$) and the element voltages ($U1-U2, U3-U2$) for

a pure resistive load where the phase currents are in phase with its respective phase voltages.

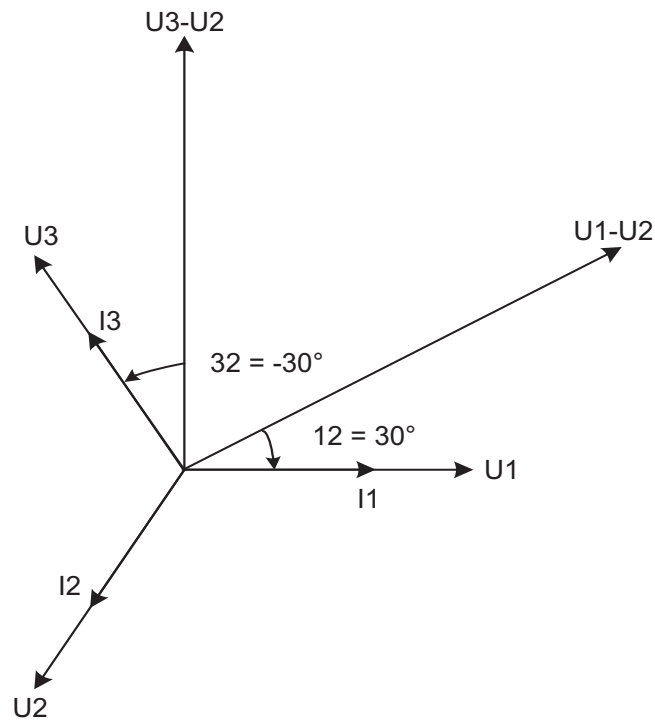

2-element metering in a 4-wire system

2-element metering can also be used in a 4-wire system if the current in the neutral connection is zero. Applying this method in a system having a non-zero neutral current will decrease the accuracy, but can sometimes be justified if the current is small compared to the line currents or if high accuracy is not required.

It is also possible to use this method for measuring one current only. This method will only give correct result in a balanced system. Note that the current flows backwards through phase 1 and 3 and that the phase voltages not are connected to the normal inputs when the current transformer is connected to phase 1 and 3.

Illustration

The following diagrams shows 2-element measurements with only 1 current transformer:

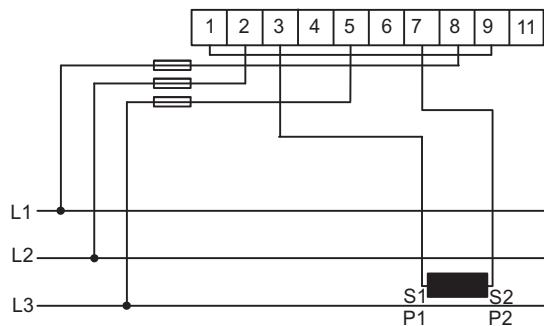
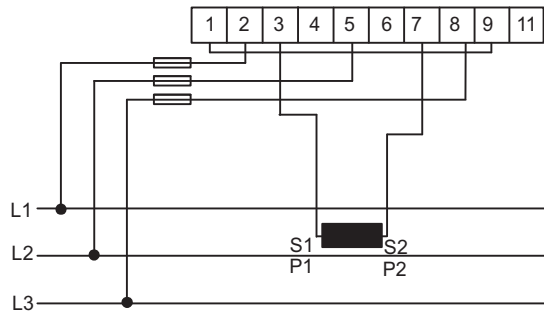
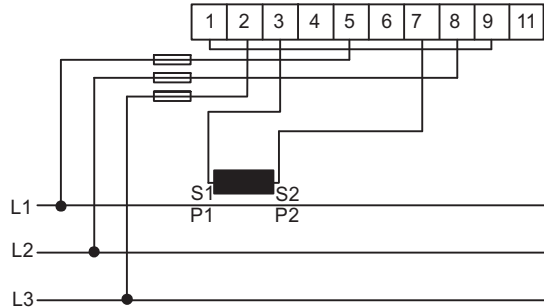

7.1.3 3-Phase, 3-Element Metering

3-element metering in a 4-wire system

This method is normally used in three phase systems that have a neutral conductor.

In a 3-element meter the neutral voltage is used as the voltage reference and the voltage difference between the neutral voltage and the L1, L2 and L3 voltages are measured and multiplied by its respective current. The active energy consumed

by the load is the product of momentary voltages U_1 , U_2 and U_3 and the currents I_1 , I_2 and I_3 integrated over the desired measuring time period.

Illustration

The following diagram shows a direct connected 3-element meter measuring the active energy(E) consumed by a load.

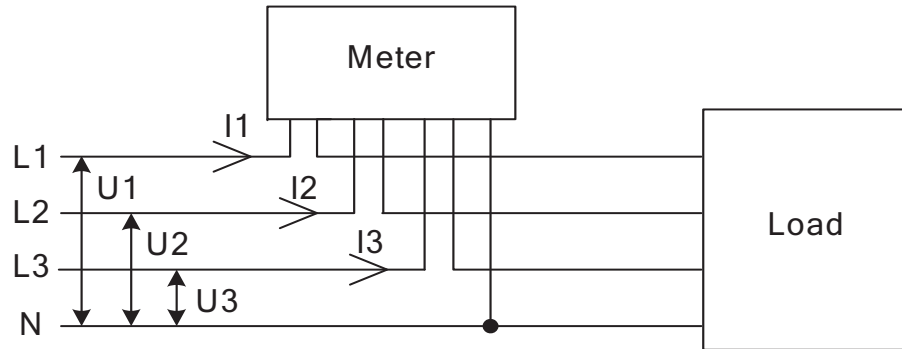

Calculating total active power

If the rms values of the voltages and currents are constant, then the total active power can be expressed as:

$$P_{tot} = P_1 + P_2 + P_3 = U_1 \times I_1 \times \cos \phi_1 + (U_2 \times I_2 \times \cos \phi_2 + U_3 \times I_3 \times \cos \phi_3)$$

3-element metering with the neutral disconnected

Sometimes it is desired to use a 3-element meter without having the neutral connected. It can be done with both transformer connected and direct connected meters.

This can for example be desired in cases where a voltage transformer without a neutral is being used for the moment but where a change to a voltage transformer with neutral will be made sometime in the future. To save the trouble of changing the meter at that time a 3-element meter is used from the beginning.

Using a 3-element meter without having the neutral connected will decrease the accuracy due to the fact that the floating neutral connection on the meter (terminal 11) will lie at a different level than the true neutral (N) because of impedance imbalance inside the meter, resulting in the phase voltages not being correct. The imbalance error is usually however rather small (typically 0–2%) and if the currents are balanced then the total error in the energy measurement will be very small, as a too small energy measurement on one element will be compensated by approximately opposite errors for the other phases.

Illustration

The following diagram shows a 3-element transformer connected meter with the neutral disconnected:

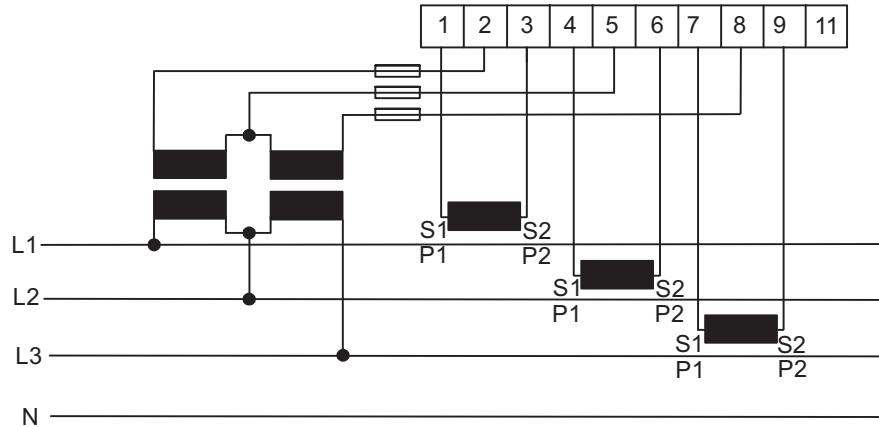

3-element metering with 2 transformers

It is also possible to use a 3-element meter with only 2 current transformers. This type connection is possible both with and without the neutral available or the neutral left floating.

Note that if the current transformers are connected to protective earth then it must be connected in only one point. Both methods require a balanced system (voltages and currents the same in all 3 phases). It shall also be mentioned that having a floating neutral also can give additional errors in the measured voltages due to impedance nonlinearity and imbalance inside the meter.

Illustration

The following diagram shows a 3-element transformer connected meter with 2 current transformers:

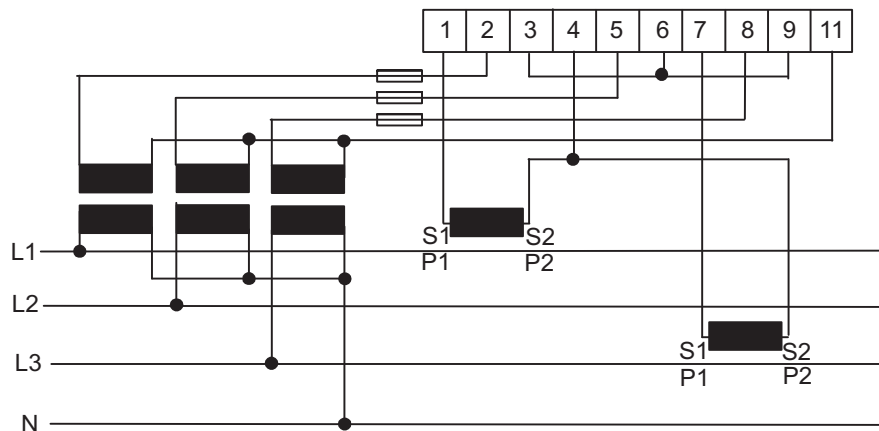

Illustration

The following diagram shows a 3-element transformer connected meter with 2 current transformers and a floating neutral:

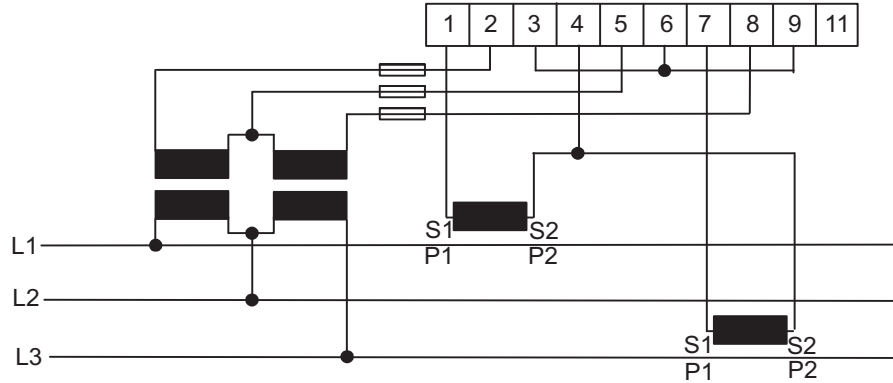

Summation metering

The currents from several different transformers can be summed into one single meter.



Note – The summation metering method could also be used with a single phase meter or a 2-element meter

Illustration

The following illustration shows summation metering with a 3-element transformer connected meter:

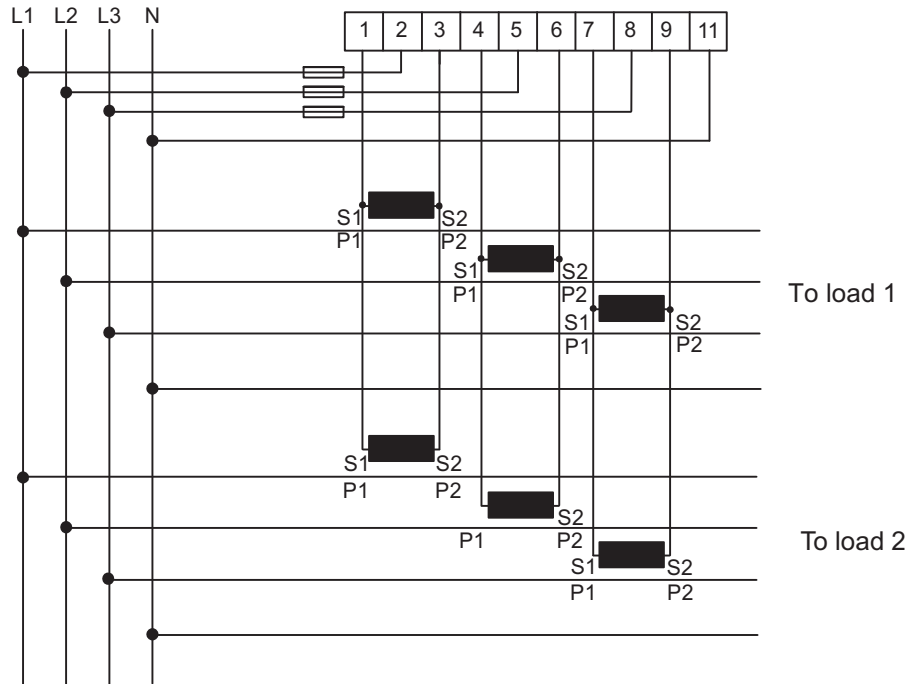

Chapter 8: Service & Maintenance

Overview

This chapter contains information about service and maintenance of the product.

In this chapter

The following topics are covered in this chapter:

8.1 Service and Maintenance 77

8.1 Service and Maintenance

Service This product contains no parts that can be repaired or exchanged. A broken meter must be replaced.

Cleaning If the meter needs to be cleaned, then use a lightly moistened cloth with a mild detergent to wipe it.

! **Caution – Be careful that no liquid gets into the meter since it can ruin the equipment.**

Chapter 9: Communication with Modbus

Overview

This chapter describes the mapping from meter data to Modbus and how to read and write to registers.

In this chapter

The following topics are covered in this chapter:

9.1	About the Modbus Protocol	79
9.1.1	Function Code 3 (Read holding registers)	79
9.1.2	Function Code 16 (Write multiple registers)	81
9.1.3	Function Code 6 (Write single register)	82
9.2	Reading and Writing to Registers	84
9.3	Mapping Tables	85
9.4	Event logs	94
9.4.1	Reading Event logs	97
9.5	Configuration	98
9.5.1	Alarms	98
9.5.2	Inputs and outputs	101
9.5.3	Tariffs	103

9.1 About the Modbus Protocol

General

Modbus is a master-slave communication protocol that can support up to 247 slaves organized as a multidrop bus. The communication is half duplex. Services on Modbus are specified by function codes.

The function codes are used to read or write 16 bit registers. All metering data, such as active energy, voltage or firmware version, is represented by one or more such registers. For further information about the relation between register number and metering data, refer to “Mapping Tables” on page - 86.

The Modbus protocol is specified in its entirety in Modbus Application Protocol Specification V1.1b. The document is available at <http://www.modbus.org>

Supported function codes

The following function codes are supported:

- Function code 3 (Read holding registers)
 - Function code 6 (Write single register)
 - Function code 16 (Write multiple registers)
-

Modbus request frame

A Modbus request frame generally has the following structure:

Slave Address	Function Code	Data	Error Check
---------------	---------------	------	-------------

Slave address	Modbus slave address, 1 byte.
Function code	Decides the service to be performed.
Data	Dependent on the function code. The length varies.
Error check	CRC, 2 bytes

Message types

The network messages can be query-response or broadcast type. The query-response command sends a query from the master to an individual slave and is generally followed by a response.

The broadcast command sends a message to all slaves and is never followed by a response. Broadcast is supported by function code 6 and 16.

9.1.1 Function Code 3 (Read holding registers)

General

Function code 3 is used to read measurement values or other information from the electricity meter. It is possible to read up to 125 consecutive registers at a time. This means that multiple values can be read in one request.

Request frame

A request frame has the following structure:

Slave Address	Function Code	Address	No. of Registers	Error Check
---------------	---------------	---------	------------------	-------------

Example of a request

The following is an example of a request. (read total energy import, etc...)

Slave address	0x01
Function code	0x03
Start address, high byte	0x50
Start address, low byte	0x00
No. of registers, high byte	0x00
No. of registers, low byte	0x18
Error check (CRC), high byte	0x54
Error check (CRC), low byte	0xC0

Response frame

A response frame has the following structure:

Slave Address	Function Code	Byte Count	Register Values	Error Check
---------------	---------------	------------	-----------------	-------------

Example of a response

The following is an example of a response:

Slave address	0x01
Function code	0x03
Byte count	0x30
Value of register 0x5000, high byte	0x00
Value of register 0x5000, low byte	0x15
...	
Value of register 0x5017, high byte	0xFF
Value of register 0x5017, low byte	0xFF
Error check (CRC), high byte	0xFF
Error check (CRC), low byte	0xFF

In this example, the slave with the Modbus address 1 responds to a read request. The number of data bytes is 0x30. The first register (0x5000) has the value 0x0015 and the last (0x5017) has the value 0xFFFF

9.1.2 Function Code 16 (Write multiple registers)

General

Function code 16 is used to modify settings in the meter, such as date/time, to control output and to reset values, such as power fail counter. It is possible to write up to 123 consecutive registers in a single request. This means that several settings can be modified and/or several reset operations can be performed in a single request.

Request frame

A request frame has the following structure:

Slave Address	Function Code	Start Address	No. of Registers	Byte Count	Register Values	Error Check
---------------	---------------	---------------	------------------	------------	-----------------	-------------

Example of a request

The following is an example of a request (set Date/Time to November 11, 2010, 12:13:14):

Slave address	0x01
Function code	0x10
Start address, high byte	0x8A
Start address, low byte	0x00
No. of registers, high byte	0x00
No. of registers, low byte	0x03
Byte count	0x06
Value of register 0x8A00, high byte	0x0A
Value of register 0x8A00, low byte	0x0B
Value of register 0x8A01, high byte	0x0B
Value of register 0x8A01, low byte	0x0C
Value of register 0x8A02, high byte	0x0D
Value of register 0x8A02, low byte	0x0E
Error check (CRC), high byte	0x8C
Error check (CRC), low byte	0x82

In this example the master sends a write request to the slave that has the Modbus address 1. The first register to write is 0x8A00 and the number of registers to write is 0x03. This means that the registers 0x8A00 to 0x8A02 are written. Register 0x8A00 is set to the value 0x0A0B, and so on.

Response frame

A response frame has the following structure:

Slave Address	Function Code	Start Address	No. of Registers	Error Check
---------------	---------------	---------------	------------------	-------------

Example of a response

The following is an example of a response:

Slave address	0x01
Function code	0x10
Register address, high byte	0x8A
Register address, low byte	0x00
No. of registers, high byte	0x00
No. of registers, low byte	0x03
Error check (CRC), high byte	0xAA
Error check (CRC), low byte	0x10

In the example above the slave with the Modbus address 1 responds to a write request. The first register is 0x8A00 and 0x03 registers have been successfully written to.

9.1.3 Function Code 6 (Write single register)

General

Function code 6 can be used as an alternative to function code 16 if there is only one register to be written. It can, for example be used to reset the power fail counter.

Request frame

A request frame has the following structure:

Slave Address	Function Code	Register Address	Register Value	Error Check
---------------	---------------	------------------	----------------	-------------

Example of a request

The following is an example of a request (reset power fail counter):

Slave address	0x01
Function code	0x06
Register address, high byte	0x8F
Register address, low byte	0x00
No. of registers, high byte	0x00
No. of registers, low byte	0x01

Error check (CRC), high byte	0x62
Error check (CRC), low byte	0xDE

Response frame Using function code 6, the response frame is an echo of the request frame.

9.1.3.1 Exception Responses

General If an error should occur while processing a request, then the meter gives an exception response that contains an exception code.

Exception frame An exception frame has the following structure:

Slave Address	Function Code	Exception Code	Error Check
---------------	---------------	----------------	-------------

In the exception response the function code is set to the function code of the request plus 0x80.

Exception codes The exception codes that are used are listed in the following table:

Exception code	Exception	Definition
01	Illegal function	A function code that is not supported has been used.
02	Illegal data address	The requested register is outside the allowed range.
03	Illegal data value	The structure of a received message is incorrect.
04	Slave device failure	Processing the request fail due to an internal error in the meter.

9.2 Reading and Writing to Registers

Readable registers The readable range in the modbus mapping are registers 1000–8EFF (hexadecimal). Reading any registers within this range will result in a normal Modbus response. It is possible to read any number of registers between 1 and 125, i.e., it is not necessary to read all registers of a quantity listed on one line in the s. Any attempt to read outside this range will result in an illegal data address exception (Modbus exception code 2).

Multi-register values For quantities that are represented as more than 1 register, the most significant byte is found in the high byte of the first (lowest) register. The least significant byte is found in the low byte of the last (highest) register.

Unused registers Unused registers within the mapping range, for example missing quantities in the connected meter, will result in a normal Modbus response but the value of the register will be set to “invalid”.

For quantities with data type “unsigned”, the value will be FFFF in all registers. For quantities with data type “signed”, the value is the highest value possible to express. That means that a quantity that is represented by only one register will have the value 7FFF. A quantity that is represented by 2 registers will have the value 7FFFFFFF, and so on.

Writing to registers Writing to registers is only permitted to the registers listed as writable in the mapping tables. Attempting to write to a register that is listed as writable but that is not supported by the meter will not result in an error indication.



Note – It is not possible to modify parts of a setting.

Confirm set values After you set a value in the meter, it is recommended that you read the value to confirm the result, since it is not possible to confirm if a write was successful from the Modbus response.

9.3 Mapping Tables

Introduction

The purpose of this section is to explain the relation between register number and metering data.

Contents of the mapping tables

The following table explains the content of the mapping tables:

Quantity	Name of the meter quantity or other information available in the meter.
Details	Refinement of the Quantity column.
Start Reg (Hex)	Hexadecimal number for the first (lowest) Modbus Register for this quantity. *
Size	Number of Modbus registers for the meter Quantity. A Modbus Register is 16 bits long.
Res.	Resolution of the value for this Quantity (if applicable).
Unit	Unit for the Quantity (if applicable).
Data type	Data type for this Quantity, i.e. how the value in the Modbus registers should be interpreted.

*It is expressed exactly as it is sent on the bus. That is, it should not be subtracted by 40 000 or decremented by 1, as is common for Modbus products.

Total energy accumulators

All registers in the following table are read only:

Quantity	Details	Start reg (Hex)	Size	Res.	Unit	Data type
Active import	kWh	5000	4	0,01	kWh	Unsigned
Active export	kWh	5004	4	0,01	kWh	Unsigned
Active net	kWh	5008	4	0,01	kWh	Signed
Reactive import	kvarh	500C	4	0,01	kvarh	Unsigned
Reactive export	kvarh	5010	4	0,01	kvarh	Unsigned
Reactive net	kvarh	5014	4	0,01	kvarh	Signed
Apparent import	kVAh	5018	4	0,01	kVAh	Unsigned
Apparent export	kVAh	501C	4	0,01	kVAh	Unsigned
Apparent net	kVAh	5020	4	0,01	kVAh	Signed
Active import CO2	kVAh	5024	4	0,001	kg	Unsigned
Active import Currency	kVAh	5034	4	0,001	currency	Unsigned

Energy accumulators divided into tariffs

All registers in the following table are read only:

Quantity	Details	Start reg (Hex)	Size	Res.	Unit	Data type
Active import	Tariff 1	5170	4	0,01	kWh	Unsigned
Active import	Tariff 2	5174	4	0,01	kWh	Unsigned
Active import	Tariff 3	5178	4	0,01	kWh	Unsigned
Active import	Tariff 4	517C	4	0,01	kWh	Unsigned
Active export	Tariff 1	5190	4	0,01	kWh	Unsigned
Active export	Tariff 2	5194	4	0,01	kWh	Unsigned
Active export	Tariff 3	5198	4	0,01	kWh	Unsigned
Active export	Tariff 4	519C	4	0,01	kWh	Unsigned
Reactive import	Tariff 1	51B0	4	0,01	kvarh	Unsigned
Reactive import	Tariff 2	51B4	4	0,01	kvarh	Unsigned
Reactive import	Tariff 3	51B8	4	0,01	kvarh	Unsigned
Reactive import	Tariff 4	51BC	4	0,01	kvarh	Unsigned
Reactive export	Tariff 1	51D0	4	0,01	kvarh	Unsigned
Reactive export	Tariff 2	51D4	4	0,01	kvarh	Unsigned
Reactive export	Tariff 3	51D8	4	0,01	kvarh	Unsigned
Reactive export	Tariff 4	51DC	4	0,01	kvarh	Unsigned

Energy accumulators per phase

All registers in the following table are read only:

Quantity	Details	Start reg (Hex)	Size	Res.	Unit	Data type
Active import	L1	5460	4	0,01	kWh	Unsigned
Active import	L2	5464	4	0,01	kWh	Unsigned
Active import	L3	5468	4	0,01	kWh	Unsigned
Active export	L1	546C	4	0,01	kWh	Unsigned
Active export	L2	5470	4	0,01	kWh	Unsigned
Active export	L3	5474	4	0,01	kWh	Unsigned
Active net	L1	5478	4	0,01	kWh	Signed
Active net	L2	547C	4	0,01	kWh	Signed
Active net	L3	5480	4	0,01	kWh	Signed

Quantity	Details	Start reg (Hex)	Size	Res.	Unit	Data type
Reactive import	L1	5484	4	0,01	kvarh	Unsigned
Reactive import	L2	5488	4	0,01	kvarh	Unsigned
Reactive import	L3	548C	4	0,01	kvarh	Unsigned
Reactive export	L1	5490	4	0,01	kvarh	Unsigned
Reactive export	L2	5494	4	0,01	kvarh	Unsigned
Reactive export	L3	5498	4	0,01	kvarh	Unsigned
Reactive net	L1	549C	4	0,01	kvarh	Signed
Reactive net	L2	54A0	4	0,01	kvarh	Signed
Reactive net	L3	54A4	4	0,01	kvarh	Signed
Apparent import	L1	54A8	4	0,01	kVAh	Unsigned
Apparent import	L2	54AC	4	0,01	kVAh	Unsigned
Apparent import	L3	54B0	4	0,01	kVAh	Unsigned
Apparent export	L1	54B4	4	0,01	kVAh	Unsigned
Apparent export	L2	54B8	4	0,01	kVAh	Unsigned
Apparent export	L3	54BC	4	0,01	kVAh	Unsigned
Apparent net	L1	54C0	4	0,01	kVAh	Signed
Apparent net	L2	54C4	4	0,01	kVAh	Signed
Apparent net	L3	54C8	4	0,01	kVAh	Signed

Resettable energy accumulators

All registers in the following table are read only:

Quantity	Start reg (Hex)	Size	Res.	Unit	Data type
Resettable active import	552C	4	0,01	kWh	Unsigned
Resettable active export	5530	4	0,01	kWh	Unsigned
Resettable reactive import	5534	4	0,01	kWh	Unsigned
Resettable reactive export	5538	4	0,01	kWh	Unsigned

Instantaneous values

All registers in the following table are read only:

Quantity	Details	Start reg (Hex)	Size	Res.	Unit	Value range	Data type
Voltage	L1-N	5B00	2	0,1	V		Unsigned
Voltage	L2-N	5B02	2	0,1	V		Unsigned
Voltage	L3-N	5B04	2	0,1	V		Unsigned
Voltage	L1-L2	5B06	2	0,1	V		Unsigned
Voltage	L3-L2	5B08	2	0,1	V		Unsigned
Voltage	L1-L3	5B0A	2	0,1	V		Unsigned
Current	L1	5B0C	2	0,01	A		Unsigned
Current	L2	5B0E	2	0,01	A		Unsigned
Current	L3	5B10	2	0,01	A		Unsigned
Current	N	5B12	2	0,01	A		Unsigned
Active power	Total	5B14	2	0,01	W		Signed
Active power	L1	5B16	2	0,01	W		Signed
Active power	L2	5B18	2	0,01	W		Signed
Active power	L3	5B1A	2	0,01	W		Signed
Reactive power	Total	5B1C	2	0,01	var		Signed
Reactive power	L1	5B1E	2	0,01	var		Signed
Reactive power	L2	5B20	2	0,01	var		Signed
Reactive power	L3	5B22	2	0,01	var		Signed
Apparent power	Total	5B24	2	0,01	VA		Signed
Apparent power	L1	5B26	2	0,01	VA		Signed
Apparent power	L2	5B28	2	0,01	VA		Signed
Apparent power	L3	5B2A	2	0,01	VA		Signed
Frequency		5B2C	1	0,01	Hz		Unsigned
Phase angle power	Total	5B2D	1	0,1	°	-180° – +180°	Signed
Phase angle power	L1	5B2E	1	0,1	°	-180° – +180°	Signed
Phase angle power	L2	5B2F	1	0,1	°	-180° – +180°	Signed
Phase angle power	L3	5B30	1	0,1	°	-180° – +180°	Signed
Phase angle voltage	L1	5B31	1	0,1	°	-180° – +180°	Signed
Phase angle voltage	L2	5B32	1	0,1	°	-180° – +180°	Signed
Phase angle voltage	L3	5B33	1	0,1	°	-180° – +180°	Signed
Phase angle current	L1	5B37	1	0,1	°	-180° – +180°	Signed
Phase angle current	L2	5B38	1	0,1	°	-180° – +180°	Signed
Phase angle current	L3	5B39	1	0,1	°	-180° – +180°	Signed
Power factor	Total	5B3A	1	0,001	-	-1,000 – +1,000	Signed

Quantity	Details	Start reg (Hex)	Size	Res.	Unit	Value range	Data type
Power factor	L1	5B3B	1	0,001	-	-1,000 – +1,000	Signed
Power factor	L2	5B3C	1	0,001	-	-1,000 – +1,000	Signed
Power factor	L3	5B3D	1	0,001	-	-1,000 – +1,000	Signed
Current quadrant	Total	5B3E	1		-	1–4	Unsigned
Current quadrant	L1	5B3F	1		-	1–4	Unsigned
Current quadrant	L2	5B40	1		-	1–4	Unsigned
Current quadrant	L3	5B41	1		-	1–4	Unsigned



Note – Powers are sent out as 32 bit signed integers, expressed in W (or var/VA) with 2 decimals. This means that the maximum power possible to express is approximately ± 21 MW. If the power is higher than that, then the user is advised to read power from the DMTME mapping instead, where the scaling is in W without decimals.

Inputs and outputs

The following table contains both writable and read only registers:

Quantity	Details	Start Reg (Hex)	Size	Possible values	Data type	Read/Write
Output 1		6300	1	ON=1, OFF=0	Unsigned	R/W
Output 2		6301	1	ON=1, OFF=0	Unsigned	R/W
Input 3	Current state	6308	1	ON=1, OFF=0	Unsigned	R
Input 4	Current state	6309	1	ON=1, OFF=0	Unsigned	R
Input 3	Stored state	6310	1	ON=1, OFF=0	Unsigned	R
Input 4	Stored state	6311	1	ON=1, OFF=0	Unsigned	R
Input 3	Counter	6318	4		Unsigned	R
Input 4	Counter	631C	4		Unsigned	R

Production data and identification

All registers in the following table are read only:

Quantity	Start Reg (Hex)	Size	Data type
Serial number	8900	2	Unsigned
Meter firmware version	8908	8	ASCII string (up to 16 characters)

Quantity	Start Reg (Hex)	Size	Data type
Modbus mapping version	8910	1	2 bytes
Type designation	8960	6	ASCII string (12 characters, including null termination)

Meter firmware version is expressed as a string of 3 digits separated by periods, e.g. 1.0.0. Unused bytes at the end are set to binary 0.

In the **Modbus mapping version** register the high byte corresponds to the Major version (1–255), and the low byte corresponds to the Minor version (0–255).

Miscellaneous

In the following table Date/time and current tariff are writable. All other registers are read only:

Quantity	Start Reg (Hex)	Description	Size	Data type	Read/Write
Current tariff	8A07	Tariff 1–4	1	Unsigned	R/W
Error flags	8A13	64 flags	4	Bit string	R
Information flags	8A19	64 flags	4	Bit string	R
Warning flags	8A1F	64 flags	4	Bit string	R
Alarm flags	8A25	64 flags	4	Bit string	R
Power fail counter	8A2F		1	Unsigned	R

* Byte 0 is the highest byte of the lowest register

The **Reset counter** registers show the number of times the resettable energy accumulators have been reset.

Settings

All registers in the following table have read and write access:

Quantity	Start Reg (hex)	Size	Res.	Unit	Data type
Current transformer ratio numerator	8C04	2		-	Unsigned
Current transformer ratio denominator	8C08	2		-	Unsigned
Currency conversion factor	8CE2	2	0.01	Currency/kWh	Unsigned
LED source (0 = active energy, 1 = reactive energy)	8CE4	1		-	Unsigned
Number of elements (values 1–3)	8CE5	1		-	Unsigned

Operations

All registers in the following table are write only:

Quantity	Details	Start Reg (hex)	Size	Action	Data type
Reset power fail counter		8F00	1	Write the value 1 to perform a reset	Unsigned
Reset power outage time		8F05	1	Write the value 1 to perform a reset	Unsigned
Reset input counter	Input 3	8F0B	1	Write the value 1 to perform a reset	Unsigned
Reset input counter	Input 4	8F0C	1	Write the value 1 to perform a reset	Unsigned
Reset stored state	input 3	8F13	1	Write the value 1 to perform a reset	Unsigned
Reset stored state	Input 4	8F14	1	Write the value 1 to perform a reset	Unsigned
Reset resettable active energy import		8F1B	1	Write the value 1 to perform a reset	Unsigned
Reset resettable active energy export		8F1C	1	Write the value 1 to perform a reset	Unsigned
Reset resettable reactive energy import		8F1D	1	Write the value 1 to perform a reset	Unsigned
Reset resettable reactive energy export		8F1E	1	Write the value 1 to perform a reset	Unsigned
Reset Load profile channel 1		8F21	1	Write the value 1 to perform a reset	Unsigned
Reset Load profile channel 2		8F22	1	Write the value 1 to perform a reset	Unsigned
Reset Load profile channel 3		8F23	1	Write the value 1 to perform a reset	Unsigned
Reset Load profile channel 4		8F24	1	Write the value 1 to perform a reset	Unsigned
Reset Load profile channel 5		8F25	1	Write the value 1 to perform a reset	Unsigned
Reset Load profile channel 6		8F26	1	Write the value 1 to perform a reset	Unsigned
Reset Load profile channel 7		8F27	1	Write the value 1 to perform a reset	Unsigned
Reset Load profile channel 8		8F28	1	Write the value 1 to perform a reset	Unsigned

Quantity	Details	Start Reg (hex)	Size	Action	Data type
Reset System log		8F31	1	Write the value 1 to perform a reset	Unsigned
Reset Event log		8F32	1	Write the value 1 to perform a reset	Unsigned
Reset Net quality log		8F33	1	Write the value 1 to perform a reset	Unsigned
Reset Communication log		8F34	1	Write the value 1 to perform a reset	Unsigned

DMTME multimeters

Parts of the Modbus mapping is compatible with the ABB DMTME multimeters. All registers in the following table are read only:

Quantity	Start Reg (Hex)	Size	Unit	Data type
3-phase system voltage	1000	2	Volt	Unsigned
Phase Voltage L1-N	1002	2	Volt	Unsigned
Phase Voltage L2-N	1004	2	Volt	Unsigned
Phase Voltage L3-N	1006	2	Volt	Unsigned
Line Voltage L1-L2	1008	2	Volt	Unsigned
Line Voltage L2-L3	100A	2	Volt	Unsigned
Line Voltage L1-L3	100C	2	Volt	Unsigned
Line Current L1	1010	2	mA	Unsigned
Line Current L2	1012	2	mA	Unsigned
Line Current L3	1014	2	mA	Unsigned
3-Phase Sys. Power Factor	1016	2	*1000	Signed
Power Factor L1	1018	2	*1000	Signed
Power Factor L2	101A	2	*1000	Signed
power Factor L3	101C	2	*1000	Signed
3-Phase Sys. Apparent Power	1026	2	VA	Unsigned
Apparent Power L1	1028	2	VA	Unsigned
Apparent Power L2	102A	2	VA	Unsigned
Apparent Power L3	102C	2	VA	Unsigned
3-Phase Sys. Active Power	102E	2	Watt	Unsigned
Active Power L1	1030	2	Watt	Unsigned
Active Power L2	1032	2	Watt	Unsigned

Communication with Modbus

Quantity	Start Reg (Hex)	Size	Unit	Data type
Active Power L3	1034	2	Watt	Unsigned
3-Phase Reactive power	1036	2	VAr	Unsigned
Reactive Power L1	1038	2	VAr	Unsigned
Reactive power L2	103A	2	VAr	Unsigned
Reactive Power L3	103C	2	VAr	Unsigned
3-Phase Sys. Active energy	103E	2	Wh*100	Unsigned
3-Phase Sys. Reactive energy	1040	2	VArh*100	Unsigned
Frequency	1046	2	mHz	Unsigned
Current transformer ratio	11A0	2	1-999999	Unsigned

9.4 Event logs

General

In the Modbus mapping Event log is organized as entries.

Entry number 1 is the most recent entry, entry number 2 is the second most recent, and so on. Entry number 0 is not used.

Readout of event log is made by writing to a group of registers called Header and reading from one or more groups of registers called Data blocks.

The Header is used for controlling readout with respect to entry numbers, and for loading new entries into the Data blocks. The data blocks contain the actual data, i.e. event log entries.

When there are no more entries to read all registers in the Data blocks are set to 0xFFFF.

Header registers

There are a number of standard commands that are used in the same way when reading out any type of historical data. These are represented by registers in the Header, separately mapped for each functionality, but with the same names.

The following table describes the common header registers:

Function	Size	Description	Data type	Read/write
Get next entry	1	Write the value 1 to this register to load new values in the Data block(s)	Unsigned	R/W
Entry number	1	Write to this register to select an entry number to start reading from	Unsigned	R/W
Direction	1	Write to this register to select the direction of reading	Unsigned	R/W

Get next entry register

The Get next entry register is used to continue an ongoing readout, which was started by writing to any of the Entry number or Direction registers.

If the direction in Direction register is set to backward, then the Data block is loaded with older data. And correspondingly, if the direction is set to forward then the Data block is loaded with more recent data.

Entry number register

The Entry number register is used to specify an entry number to start reading from. When a value is written to the Entry number register the Data block is loaded with values for that entry number.

Subsequent writes to Get next entry register will update the Entry number register (increment or decrement depending on direction in the Direction register), as well as loading new values to the Data block.

The default value of Entry number register after a restart is 0.

Direction register The Direction register is used to control the direction in time in which the entries are read. Possible values are shown in the table below:

Value	Description
0	Backwards, i.e. from recent entries towards older entries
1	Forward, i.e. from old entries towards recent entries

The default value of Entry number register after a restart is 0, i.e. backwards.

Mapping table The following table shows an overview of the mapping table:

Log type	Details	Start Reg (Hex)	Size
System log	Header	6500	16
System log	Data block	6510	105
Event log	Header	65B0	16
Event log	Data block	65C0	105
Audit log	Header	6660	16
Audit log	Data block	6670	105
Net quality log	Header	6710	16
Net quality log	Data block	6720	105
Communication log	Header	67C0	16
Communication log	Data block	67D0	105

Header and data block There is one pair of header and data block for each log type, located in the registers listed in the mapping table above. In the tables showing the structure of the header and data block below the register numbers are valid for the System log. However the headers and data blocks for all log types share the same structure, so the tables are applicable for all log types if the register numbers are exchanged to correct values.

Structure of the header The following table describes the header:

Function	Start Reg (Hex)	Size	Description	Read/write
Get next block	6500	1	Write value 1 to this register to load the next block of log entries	R/W
Entry number	6501	1	Write to this register to select an entry number to start reading from	R/W

Function	Start Reg (Hex)	Size	Description	Read/write
Direction	6507	1	Write to this register to select the direction of reading	R/W

Data block

The data block contains the log entries, consisting of event counter, event category and event id. There is space for up to 15 log entries in the data block. The log is read by repeatedly loading new values into the data block in backward or forward direction in time.

The event appearing in the first position in the data block has the entry number indicated by Entry number register. In case of backwards reading the events in the other positions follow in ascending entry number order, i.e. going towards older events. In case of forward reading the events in the other positions follow in descending entry number order, i.e. going towards more recent events.

Structure of the data block

The following table describes the structure of the data block:

Entry position	Contents	Start Reg (Hex)	Size	Description
1	Category	6513	1	The category of this log entry (exception, warning, error or information).
1	Event id	6514	1	The id for this log entry, identifying what has happened.
...				
...				
15	Category	6575	1	The category of this log entry (exception, warning, error or information).
15	Event id	6576	1	The id for this log entry, identifying what has happened.

Category

Possible values for the category register are shown in the table below:

Category	Description
1	Exception
2	Error
4	Warning
8	Information

9.4.1 Reading Event logs

General

Readout of logs is controlled by the Entry number register. After writing to the Entry number register, the log entries are available in the registers of the data block. To get the next set of entries the Get next entry register is used.

Read the 15 most recent logs

Follow the steps in the table below to read the 15 most recent log entries:

Step	Action
1	Write the value 1 to the entry number register.
2	Read the data block.

Read the entire history

Follow the steps in the table below to read the entire history of logs, backwards in time:

Step	Action
1	Write the value 0 to the Entry number register to make sure the reading starts from the most recent entry.
2	Write the value 1 to the Get next entry register.
3	Read the data block. First time this step is performed the logs in the data block are the most recent up to the 15th most recent. Second time this step is performed the logs in the data block are the 16th to the 30th.
4	Repeat steps 2 and 3 until there are no more entries stored. When all entries have been read, all registers in the data block are set to 0xFFFF.



Note – The entry number register is reset to 0 after a restart.

9.5 Configuration

Introduction

This section describes how to configure the following functions:

- Alarms
- Tariffs

9.5.1 Alarms

General

Alarm configuration defines the set of quantities to monitor. It is also defines the threshold values, delays and actions to perform for each alarm. Each alarm is configured individually.

Alarm configuration registers

The following table describes the group of registers for configuring the alarm parameters:

Function	Start Reg (Hex)	Size	Description	Read/write
Alarm number	8C60	1	The number (identifier) for the alarm to configure	R/W
Quantity	8C61	3	The quantity to monitor	R/W
Thresholds	8C64	8	ON and OFF thresholds to used to decide when the alarm is active	R/W
Delays	8C6C	4	ON and OFF delays, defining the time that the measured value must be above/ below the configured thresholds before the alarm triggers	R/W
Actions	8C70	2	Actions to perform when alarm is triggered	R/W

Quantity identifiers

The following table lists the OBIS codes for the quantities that can be monitored by an alarm:

Quantity	OBIS code
Voltage L1	1.0.32.7.0.255
Voltage L2	1.0.52.7.0.255
Voltage L3	1.0.72.7.0.255
Voltage L1-L2	1.0.134.7.0.255

Quantity	OBIS code
Voltage L2-L3	1.0.135.7.0.255
Voltage L1-L3	1.0.136.7.0.255
Current L1	1.0.31.7.0.255
Current L2	1.0.51.7.0.255
Current L3	1.0.71.7.0.255
Current N	1.0.91.7.0.255
Active power total	1.0.16. 7.0.255
Active power L1	1.0.36. 7.0.255
Active power L2	1.0.56. 7.0.255
Active power L3	1.0.76. 7.0.255
Reactive power total	1.0.128. 7.0.255
Reactive power L1	1.0.129. 7.0.255
Reactive power L2	1.0.130. 7.0.255
Reactive power L3	1.0.131. 7.0.255
Apparent power total	1.0.137. 7.0.255
Apparent power L1	1.0.138. 7.0.255
Apparent power L2	1.0.139. 7.0.255
Apparent power L3	1.0.140. 7.0.255
Power factor total	1.0.13.7.0.255
Power factor L1	1.0.33.7.0.255
Power factor L2	1.0.53.7.0.255
Power factor L3	1.0.73.7.0.255
Inactive (deactivates the alarm)	1.128.128.128.128.128

Thresholds registers

The Thresholds registers are used to read and write the ON and OFF threshold values for an alarm. The scaling is the same as where the quantity appears in the normal mapping tables. The first (lowest) 4 registers are the ON threshold and the last 4 registers are the OFF threshold. Data type is signed 64 bit integer.

Delays registers

The Delays registers are used to read or write the ON and OFF delays for an alarm. The delay is expressed in milliseconds. The first (lowest) 2 registers are the ON delay and the last 2 registers are the OFF delay. Data type is unsigned 32 bit integer.

Actions registers

The Actions registers are used to read or write the actions to be performed when an alarm triggers. The first (lowest) register holds the actions to perform. The second register holds the number of the output to set, in case Set output action is used.

Register nr (Hex)	Bit number	Description	Possible values
8C72	0 (least significant bit)	Write entry to log	1 = use this action 0 = don't use
	1	Set output	1 = use this action 0 = don't use
	2	Set bit in alarm register	1 = use this action 0 = don't use
	3–15	Not used	
8C73	(Entire register)	Number of the output to turn on. Ignored if Set output bit above is set to 0.	1–4



Note – Both registers in the table above must be written in one operation, otherwise the value will not take effect.

Write alarm configuration

Follow the steps in the table below to configure the parameters for monitoring the value of a number of quantities in the meter:

Step	Action
1	Write the number of the alarm to configure to the Alarm number register. This is a value between 1 and 25.
2	Write the OBIS code for the quantity to monitor to the Quantity registers.
3	Write the ON and OFF thresholds to the Thresholds registers.
4	Write the ON and OFF delays to the Delays registers.
5	Write the actions to perform to perform to the Action registers.
6	Repeat step 1 to 4 for all alarms that shall be used.

Read alarm configuration

Follow the steps in the table below to read the current configuration of monitoring parameters for alarms.

Step	Action
1	Write the number of the alarm to read configuration for to the Alarm number register. This is a value between 1 and 25.
2	Read the Quantity registers to get the quantity monitored in the selected alarm.

Step	Action
3	Read the Thresholds registers to get the ON and OFF thresholds.
4	Read the Delays registers to get the ON and OFF delays.
5	Read the Action registers to get the actions performed when an alarm is triggered.
6	Repeat step 1 to 4 for all alarms.

9.5.2 Inputs and outputs

General

Inputs and outputs configuration defines the function for each physical I/O port. It also defines the parameters for the logical pulse outputs.

Mapping table

The following table shows an overview of the mapping table:

Quantity	Details	Start Reg (Hex)	Size
Inputs and outputs	I/O port configuration	8C0C	2
Inputs and outputs	Pulse output configuration	8C10	12

I/O port configuration registers

The following table describes the group of registers for configuring the function for physical I/O ports:

Register	Start Reg (Hex)	Size	Description	Read/write
I/O port 1	8C0C	1	Function of first I/O port	R/W
I/O port 2	8C0D	1	Function of second I/O port	R/W

The following table lists the possible values for I/O port function:

Value	Function
1	Communication output
2	Alarm output
3	Pulse output
4	Tariff output
5	Output always ON
6	Output always OFF

Pulse output configuration registers

The following table describes the group of registers for configuring the pulse outputs:

Function	Start Reg (Hex)	Size	Description	Read/write
Pulse output instance	8C10	1	The instance number of the pulse output	R/W
Port number	8C11	1	The physical I/O port on which the pulses are sent out	R/W
Energy quantity	8C12	3	The OBIS code for the quantity	R/W
Pulse frequency active energy	8C15	2	The pulse frequency, measured in pulses/kWh with 3 decimals. This is relevant only if Energy quantity is set to active energy.	R/W
Pulse frequency reactive energy	8C17	2	The pulse frequency, measured in pulses/kvarh with 3 decimals. This is relevant only if Energy quantity is set to reactive energy.	R/W
Pulse length	8C19	2	The duration of a pulse, measured in milliseconds	R/W
Turn off pulse output	8C1B	1	Write the value 1 to this register to turn off the selected pulse output instance	R/W

Selectable energy quantities

The table below lists the possible energy quantities to associate with a pulse output:

Quantity	OBIS code
Active energy import total	1.0.1.8.0.255
Active energy export total	1.0.2.8.0.255
Reactive energy import total	1.0.3.8.0.255
Reactive energy export total	1.0.4.8.0.255

Write pulse output configuration

Follow the steps in the table below to configure the pulse outputs:

Step	Action
1	Select the pulse output instance to configure by writing a number to the Pulse output instance register. Allowed values are 1–4.
2	Write to the Port number register to decide to which physical port the pulses are sent out for the selected pulse output. Allowed values are 0–4, where 0 means No Output.
3	Write the OBIS code of the quantity that shall be used for the selected pulse output to the Energy quantity registers. Possible OBIS codes are listed above.

Step	Action
4	Write the desired pulse frequency to the Pulse frequency active or reactive energy registers, depending on the selected energy type.
5	Write the desired pulse length to the Pulse length registers.
6	Repeat steps 1 to 5 for all pulse outputs.

Turn off a pulse output

Follow the steps in the table below to turn off a pulse output instance:

Step	Action
1	Select the pulse output instance to configure by writing a number to the Pulse output instance register. Allowed values are 1–4.
2	Write the value 1 to the Turn off pulse output register.

Read pulse output configuration

Follow the steps in the table below to read the current pulse output configuration:

Step	Action
1	Select the pulse output instance to read configuration for by writing a number to the Pulse output instance register. Allowed values are 1–4.
2	Read the Port number register to get the I/O port number used by the selected pulse output instance.
3	Read the Energy quantity registers to get the OBIS code of the quantity used for the selected pulse output instance.
4	Read the Pulse frequency active or reactive energy registers, depending on the selected energy type, to get the pulse frequency used by the selected pulse output instance.
5	Read the Pulse length registers to get the pulse length used by the selected pulse output instance.
6	Repeat steps 1 to 5 for all pulse outputs.

9.5.3 Tariffs

General

Tariff configuration defines the currently used tariff source, i.e. communication or inputs. It also defines the settings that are specific for each of these sources.

Mapping table

The following table shows an overview of the mapping table:

Quantity	Details	Start Reg (Hex)	Size
Tariffs	Tariff source	8C90	1
Tariffs	Input configuration	8C91	1

Tariff source register

The Tariff source register is used to read or write the source used for controlling the tariffs. Possible values are listed in the table below:

Value	Description
1	Communication
2	Inputs

Input configuration register

The Input configuration register is used for reading and writing tariff input configuration. It decides how many tariffs are used, and which tariff is activated for every combination of values on the inputs. The following table describes the contents of the Input configuration register:

Byte	Bits	Description	Possible values
0 (high byte)	Entire byte	The number of tariffs to use	1–4
1 (low byte)	0–1*	Tariff to activate when both inputs are OFF	0–3 (0 = tariff 1, etc)
	2–3*	Tariff to activate when input 3 is ON and input 4 is OFF	0–3
	4–5*	Tariff to activate when input 3 is OFF and input 4 is ON	0–3
	6–7*	Tariff to activate when both inputs are ON	0–3

* Bit 0 is the least significant bit.

Chapter 10: Communication with M-Bus

Overview This chapter describes how to read meter data and to send commands to the meter over M-Bus.

In this chapter The following topics are covered in this chapter:

- 10.1 Protocol Description 107
- 10.2 Standard Readout of Meter Data 123
- 10.3 Special Readout of Meter Data 150
- 10.4 Sending Data to the Meter 154

10.1 Protocol Description

General

The communication protocol described in this chapter meets the requirements of EN 13757-2 and EN 13757-3.

The communication can be divided in two parts. One part is reading data from the meter and the other part is sending data to it.

The data readout procedure starts when the master sends a REQ_UD2 telegram to the meter. The meter responds with a RSP_UD telegram. A typical readout is a multi-telegram readout.

Some data in the meter can only be read by first sending a SND_UD followed by REQ_UD2. This is true for load profiles, demand and log files.

Using SND_UD telegrams data can be sent to the meter.

Communication objects

The following quantities can be read by sending a REQ_UD2 to the meter

Register	Communication objects
Active import energy, total	Total cumulative active imported energy
Active import energy, tariff 1	Cumulative active imported energy tariff 1
Active import energy, tariff 2	Cumulative active imported energy tariff 2
Active import energy, tariff 3	Cumulative active imported energy tariff 3
Active import energy, tariff 4	Cumulative active imported energy tariff 4
Reactive import energy, total	Total cumulative reactive imported energy
Reactive import energy, tariff 1	Cumulative reactive imported energy tariff 1
Reactive import energy, tariff 2	Cumulative reactive imported energy tariff 2
Reactive import energy, tariff 3	Cumulative reactive imported energy tariff 3
Reactive import energy, tariff 4	Cumulative reactive imported energy tariff 4
Active export energy, total	Total cumulative active exported energy
Active export energy, tariff 1	Cumulative active exported energy tariff 1
Active export energy, tariff 2	Cumulative active exported energy tariff 2
Active export energy, tariff 3	Cumulative active exported energy tariff 3
Active export energy, tariff 4	Cumulative active exported energy tariff 4
Reactive export energy, total	Total cumulative reactive exported energy
Reactive export energy, tariff 1	Cumulative reactive exported energy tariff 1
Reactive export energy, tariff 2	Cumulative reactive exported energy tariff 2
Reactive export energy, tariff 3	Cumulative reactive exported energy tariff 3
Reactive export energy, tariff 4	Cumulative reactive exported energy tariff 4
CT Ratio	Current transformer ratio (numerator)
CT Ratio	Current transformer ratio (denominator)
VT Ratio	Voltage transformer ratio (numerator)
VT Ratio	Voltage transformer ratio (denominator)
Outputs	Read and set status of outputs
Inputs, current state	Read current state of inputs

Register	Communication objects
Inputs, stored state	Read and reset stored state of inputs
Inputs, counter	Read and clear input pulse counters
Current N	
Current, L1	Instantaneous current in the L1 phase
Current, L2	Instantaneous current in the L2 phase
Current, L3	Instantaneous current in the L3 phase
Voltage, L1-N	Instantaneous voltage between L1 and neutral
Voltage, L2-N	Instantaneous voltage between L2 and neutral
Voltage, L3-N	Instantaneous voltage between L3 and neutral
Voltage, L1-L2	Instantaneous voltage between L1 and L2
Voltage, L2-L3	Instantaneous voltage between L2 and L3
Voltage, L1-L3	Instantaneous voltage between L1 and L3
Active Power, Total	Instantaneous total active power
Active Power, L1	Instantaneous active power in L1
Active Power, L2	Instantaneous active power in L2
Active Power, L3	Instantaneous active power in L3
Active energy net Tot.	
Active energy net L1	
Active energy net L2	
Active energy net L3	
Power factor tot.	
Power factor L1	
Power factor L2	
Power factor L3	
Active energy currency conversion	
Active energy CO2 conversion	
Reactive Power, Total	Instantaneous total reactive power
Reactive Power, L1	Instantaneous reactive power in L1
Reactive Power, L2	Instantaneous reactive power in L2
Reactive Power, L3	Instantaneous reactive power in L3
Reactive energy net Tot.	
Reactive energy net L1	
Reactive energy net L2	
Reactive energy net L3	
Apparent Power, Total	Instantaneous total apparent power
Apparent Power, L1	Instantaneous apparent power in L1
Apparent Power, L2	Instantaneous apparent power in L2
Apparent Power, L3	Instantaneous apparent power in L3
Voltage phase angle, L1	Instantaneous voltage phase angle for L1 (L1 voltage is reference)
Voltage phase angle, L2	Instantaneous voltage phase angle for L2 (L1 voltage is reference)

Register	Communication objects
Voltage phase angle, L3	Instantaneous voltage phase angle for L3 (L1 voltage is reference)
Current phase angle, L1	Instantaneous current phase angle for L1 (L1 voltage is reference)
Current phase angle, L2	Instantaneous current phase angle for L2 (L1 voltage is reference)
Current phase angle, L3	Instantaneous current phase angle for L3 (L1 voltage is reference)
Phase angle power, Total	Instantaneous phase angle for total power
Phase angle power L1	Instantaneous phase angle power for L1
Phase angle power L2	Instantaneous phase angle power for L2
Phase angle power L3	Instantaneous phase angle power for L3
Installation check	Read result of and clear installation check
Current quadrant, Total	Quadrant in which the meter is measuring
Current quadrant, L1	Quadrant in which the meter is measuring, L1
Current quadrant, L2	Quadrant in which the meter is measuring, L2
Current quadrant, L3	Quadrant in which the meter is measuring, L3
Power fail counter	Read and reset power fail counter
Total power outage time	Read and reset total power outage time
Current tariff	Read and set current tariff
Manufacturer	Manufacturer information
FW-version	Firmware version
Frequency	
Warning flags	Read warning flags
Info flags	Read info flags
Alarm flags	Read alarm flags
Error flags	Read error flags
Event log	Read event log data
System log	Read system log data
Audit log	Read audit log data
Net quality log	Read net quality log data
Apparent import energy, total	Total cumulative apparent imported energy
Apparent export energy, total	Total cumulative apparent exported energy
Active import energy, L1	Cumulative active imported energy in the L1 phase
Active import energy, L2	Cumulative active imported energy in the L2 phase
Active import energy, L3	Cumulative active imported energy in the L3 phase
Active export energy, L1	Cumulative active exported energy in the L1 phase
Active export energy, L2	Cumulative active exported energy in the L2 phase
Active export energy, L3	Cumulative active exported energy in the L3 phase
Reactive import energy, L1	Cumulative reactive imported energy in the L1 phase
Reactive import energy, L2	Cumulative reactive imported energy in the L2 phase

Register	Communication objects
Reactive import energy, L3	Cumulative reactive imported energy in the L3 phase
Reactive export energy, L1	Cumulative reactive exported energy in the L1 phase
Reactive export energy, L2	Cumulative reactive exported energy in the L2 phase
Reactive export energy, L3	Cumulative reactive exported energy in the L3 phase
Apparent import energy, L1	Cumulative apparent imported energy in the L1 phase
Apparent import energy, L2	Cumulative apparent imported energy in the L2 phase
Apparent import energy, L3	Cumulative apparent imported energy in the L3 phase
Apparent export energy, L1	Cumulative apparent exported energy in the L1 phase
Apparent export energy, L2	Cumulative apparent exported energy in the L2 phase
Apparent export energy, L3	Cumulative apparent exported energy in the L3 phase
Resettable active energy imp. Tot.	
Resettable active energy exp. Tot.	

Read/write commands

The following tasks are possible to perform with SND_UD telegrams:

Command
Set tariff
Set primary address
Change baud rate
Reset power fail counter
Reset power outage time
Set CT Ratio numerator
Set CT Ratio denominator
Set VT Ratio numerator
Set VT Ratio denominator
Select Status information
Reset stored state input
Reset input counters
Set output
Send Password
Set communication access level
Read request Log (System, Event, quality, audit and Transformer Logs)
Read/Write Alarm settings
Read/Write Tariff settings

10.1.1 Telegram Format

General

M-Bus uses 3 different telegram formats. The formats are identified by the start character.

Single Character	Short Frame	Long Frame
E5H	Start (10h)	Start (68h)
	C-Field	L-Field
	A-Field	L-Field
	Check Sum	Start (68h)
	Stop (16h)	C-Field
		A-Field
		CI-Field
		User Data (0–252 Bytes)
		Check Sum
		Stop (16h)

The **Single Character** format consists of a single character and is used to acknowledge received telegrams.

The **Short Frame** format is identified by its start character (10h) and consists of five characters. Besides the C- and A-fields it includes the check sum and the stop character 16h.

The **Long Frame** format is identified by its start character (68h) and consists of a variable number of characters. After the start character the L-field is transmitted twice, then the start character once again followed by the C-, A- and CI-fields. The user data (0–252 bytes) is transmitted after the CI-field followed by the check sum and the stop character (16h).

10.1.1.1 Field description

General

All fields in the telegram have a length of 1 byte (8 bits).

The L-Field

The L-Field (length field) gives the size of the user data (in bytes) plus 3 (for the C-, A- and CI-Fields). It is transmitted twice in the telegrams using the long frame format.

The C-Field

The C-Field (control field) contains information about the direction of the data flow and error handling. Besides labeling the functions and the actions caused by

them, the control field specifies the direction of data flow and is responsible for various parts of the communication to and from the meter.

The following table shows the coding of the C-Field:

Bit No.	7	6	5	4	3	2	1	0
To meter	0	PRM	FCB	FCV	F3	F2	F1	F0
From meter	0	PRM	0	0	F3	F2	F1	F0

The primary message bit (**PRM**) is used to specify the direction of the data flow. It is set to 1 when a telegram is sent from a master to the meter and to 0 in the other direction.

The frame count bit valid (**FCV**) is set to 1 by the master to indicate that the frame count bit (**FCB**) is used. When the FCV is set to 0, the meter ignores the FCB.

The FCB is used to indicate successful transmission procedures. A master shall toggle the bit after a successful reception of a reply from the meter. If the expected reply is missing, or the reception of it is faulty, then the master resends the same telegram with the same FCB. The meter answers, to a REQ_UD2-request with toggled FCB and a set FCV, with a RSP_UD containing the next telegram of a multi-telegram answer. If the FCB is not toggled then it will repeat the last telegram. The actual values will be updated in a repeated telegram.

On receipt of a SND_NKE the meter clears the FCB. The meter uses the same FCB for primary addressing, secondary addressing and point-to-point communication.

The bits 0 to 3 (F0, F1, F2 and F3) of the control field are the function code of the message. The following table shows the function codes:

Comand	C-Field (binary)	C-Field (hex)	Telegram	Description
SND_NKE	0100 0000	40	Short frame	Initialization of meter
SND_UD	01F1 0011	53/73	Long frame	Send user data to meter
REQ_UD2	01F1 1011	5b	Short frame	Request for class 2 data
RSP_UD	0000 1000	08	Long frame	Data transfer form meter to master after request.

A-Field

The A-Field (address field) is used to address the recipient in the calling direction, and to identify the sender of information in the receiving direction. The size of this field is one byte, and can therefore take values from 0 to 255.

The following table shows the allocation of addresses:

Address	Description
0	Factory default

Address	Description
1–250	Can be given to meters as individual primary addresses, either via the bus (secondary addressing) or via the buttons directly on the meter.
251–252	Reserved for future use.
253	Used by the secondary addressing procedure (FDh).
254	Used for point-to-point communication (FEh). The meter replies with its primary address.
255	Used for broadcast transmissions to all meters (FFh). None of the meters replies to a broadcast message.

CI-Field

The CI-field (control information) codes the type and sequence of application data to be transmitted in the frame. Bit two (counting begins with bit 0, value 4), called M-bit or Mode bit, in the CI-field gives information about the used byte sequence in multi-byte data structures. For communication with the meter, the Mode bit shall not be set (Mode 1) meaning the least significant byte of a multi-byte record is transmitted first.

The following table shows the codes to be used by the master:

CI_Field codes	Application
51h	Data send
52h	Selection of slaves
B8h	Set baud rate to 300
B9h	Set baud rate to 600
Bah	Set baud rate to 1200
BBh	Set baud rate to 2400
BCh	Set baud rate to 4800
BDh	Set baud rate to 9600
BEh	Set baud rate to 19200
BFh	Set baud rate to 38400

The meter uses code 72 in the CI-Field to respond to requests for user data.

User data

The User Data contains the data to be sent to the recipient.

The following table shows the structure of the data sent from the meter to the master:

Fixed data header	Data records	MDH
12 bytes	Variable number of bytes	1 byte

The following table shows the structure of the data sent from the master to the meter:

Data records
Variable number of bytes

Fixed data header

The following table shows the structure of the fixed data header:

ID No.	Manufacturer	Version	Medium	Access No.	Status	Signature
4 bytes	2 bytes	1 byte	1 byte	1 byte	1 byte	2 byte

The following list explains the content of the fixed data header:

- **Identification No.** is the 8-digit serial number of the meter (BCD coded).
- **Manufacturer** is set to 0442h meaning ABB
- **Version** specifies the version of the protocol implementation. The meters currently use the protocol version equal to 0x20.
- **Medium** byte is set to 02h to indicate electricity.
- **Access number** is a counter that counts successful accesses.
- **Status byte** is used to indicate the meter status.

Bit	Meaning
0	Meter busy
1	Internal error
2	Power low
3	Permanent error
4	Temporary error
5	Installation error
6	Not used
7	Not used

- **Signature** is set to 00 00h

Data records

The data, together with information regarding coding, length and the type of data is transmitted in data records. The maximum total length of the data records is 240 bytes.

The following table shows the structure of the data record (transmitted left to right):

Data Record Header				Data
Data Information Block (DIB)		Value Information Block (VIB)		
DIF	DIFE	VIF	VIFE	
1 byte	0–10 bytes	1 byte	0–10 bytes	
				0–n bytes

Each Data record consists of a data record header (DRH) and the actual data. The DRH in turn consists of the data information block (DIB) to describe the length, type and coding of the data, and the value information block (VIB) to give the value of the unit and the multiplier.

Data information block (DIB)

The DIB contains at least one byte (Data Information Field, DIF), and is in some cases expanded with, a maximum of 10, DIFE's (Data Information Field Extension).

The following table shows the structure of the Data Information Field (DIF):

Bit 7	Bit 6	Bit 5	Bit 4	Bit 3	Bit 2	Bit 1	Bit 0
Extension bit	LSB ¹ of storage No.	Function Field		Data Field			

1. Least significant bit.

The following list explains the content of the DIF:

- The **Extension Bit** is set when the next byte is a DIFE.
- The **LSB of storage No.** is normally set to 0 to indicate actual value. (1=stored value).
- The **Function Field** is set to 00 for instantaneous values, 01 for maximum values and 10 for minimum values.
- The **Data Field** shows the format of the data. The following table shows the coding of the data field:

Code	Meaning	Length
0000	No Data	0
0001	8 Bit Integer	1
0010	16 Bit Integer	2
0100	32 Bit Integer	4
0111	64 Bit Integer	8
1010	4 digit BCD	2
1111	6 digit BCD	3
1100	8 digit BCD	4

Code	Meaning	Length
1101	Variable Length (ASCII)	Variable
1110	12 digit BCD	6

The following table shows the structure of the Data Information Field Extension (DIFE)

Bit 7	Bit 6	Bit 5	Bit 4	Bit 3	Bit 2	Bit 1	Bit 0
Extension bit	Unit	Tariff		Storage No.			

The following list explains the content of the DIFE:

- **Unit** is used for power and energy values show the type of power/energy. It is also used to define the number of inputs/outputs and to specify sign of offset when accessing event log data.
- **Tariff** is used for energy values to give tariff information.
- **Storage number** is set to 0 in values read to indicate momentary values. Storage number bigger than 0 is used to indicate previously stored values, i.e, values stored at a specific point of time in the past.

Value Information block (VIB)

VIB follows a DIF or DIFE without extension bit. It contains one value information field (VIF) and is in some cases expanded with up to 10 value information field extensions (VIFE).

The following table shows the structure of the value informatioun field (VIF):

Bit 7	6	5	4	3	2	1	0
Extension Bit	Value Information						

Value information contains information about the value (unit, status, etc.) The extension bit is set when the next byte is a VIFE.

If VIF or VIFE = FFh then the next VIFE is manufacturer specific. The manufacturer specific VIFE has the same construction as a VIF. If the extension bit of the manufacturer specific VIFE is set, and the VIFE is less than 1111 1000, then the next byte is a standard VIFE, otherwise it is the first data byte. If the extension bit of the manufacturer specific VIFE is set and the VIFE is bigger than or equal to 1111 1000, then the next byte is an extension of manufacturer specific VIFE's.

Data

The Data follows a VIF or a VIFE without the extension bit set.

Manufacturer data header (MDH)

The manufacturer data header (MDH) is either made up by the character 1Fh that indicates that more data will follow in the next telegram, or by 0Fh indicating the last telegram.

Check sum

The Check Sum is used to recognize transmission and synchronization faults. It is calculated from the arithmetical sum, of the bytes from the control field to the last user data, without taking carry digits into account .

10.1.2 Value Information Field codes

10.1.2.1 Standard VIF codes

VIF-code	Description	Range coding	Range
E000 0nnn	Energy	$10^{(nnn-3)}$ Wh	0.001Wh to 10000Wh
E010 1nnn	Power	$10^{(nnn-3)}$ W	0.001W to 10000W
E111 1000	Fabrication No.		00000000 to 99999999
E111 1010	Bus address		0–250
1111 1011	Extension of VIF-codes		Not used by the meter
1111 1101	Extension of VIF-codes		True VIF is given in the first VIFE and is coded using Table FD
1111 1111	Manufacturer specific		Next VIFE is manufacturer specific

10.1.2.2 Standard codes for VIFE used with extension indicator FDh

If the VIF contains the extension indicator FDh then the true VIF is contained in the first VIFE.

VIFE-code	Description
E000 1010	Manufacturer
E000 1100	Version
E000 1110	Firmware Version
E001 1010	Digital Output (binary)
E001 1011	Digital Input (binary)
E001 1100	Baud rate
E100 nnnn	$10^{(nnnn-9)}$ Volts
E101 nnnn	$10^{(nnnn-12)}$ A
E110 0001	Cumulating counter
E001 0110	Password

10.1.2.3 Standard codes for VIFE

The following value for VIFE's is defined for an enhancement of VIF's other than FDh and FBh:

VIFE-code	Description
1111 1111	Next VIFE is manufacturer specific

10.1.2.4 First manufacturer specific VIFE-codes

VIFE-code	Description
E000 0000	Total
E000 0001	L1
E000 0010	L2
E000 0011	L3
E000 0100	N
E000 0101	L1-L2
E000 0110	L3-L2
E000 0111	L1 - L3
E001 0000	Pulse frequency
E001 0011	Tariff
E001 0100	Installation check
E001 0101	Status of values
E001 0111	Current quadrant
E001 1000	Power fail counter
E010 0000	Current Transformer ratio numerator (CT ratio)
E010 0001	Voltage Transformer ratio numerator (VT ratio)
E010 0010	Current Transformer ratio denominator (CT ratio)
E010 0011	Voltage Transformer ratio denominator (VT ratio)
E010 0100	CO2 conversion factor (kg * 10 ⁻³ /kWh)
E010 0101	Currency conversion factor (curr * 10 ⁻³ /kWh)
E010 0110	Error flags
E010 0111	Warning flags
E010 1000	Information flags
E010 1001	Alarm flags
E100 0nnn	Phase angle voltage (degrees *10 ⁽ⁿⁿⁿ⁻³⁾)
E100 1nnn	Phase angle current (degrees *10 ⁽ⁿⁿⁿ⁻³⁾)

VIFE-code	Description
E101 0nnn	Phase angle power (degrees *10 ⁽ⁿⁿⁿ⁻³⁾)
E101 1nnn	Frequency (Hz *10 ⁽ⁿⁿⁿ⁻³⁾)
E110 0nnn	Power factor (*10 ⁽ⁿⁿⁿ⁻³⁾)
E110 1010	Change communication write access level
E110 1111	Event type
E111 0001	Reset counter for energy
E111 0010	Resettable register
E111 0110	Sequence number (audit log)
E111 1000	Extension of manufacturer specific VIFE's, next VIFE(s) used for numbering
E111 1001	Extension of manufacturer specific VIFE's, next VIFE(s) specifies actual meaning
E111 1110	Extension of manufacturer specific VIFE's, next VIFE(s) used for manufacturer specific record errors/status

10.1.2.5 VIFE-Codes for reports of record errors (meter to master)

VIFE-code	Type of record error	Error group
E000 0000	None	
E001 0101	No data available (undefined value)	
E001 1000	Data error	Data errors

10.1.2.6 VIFE-Codes for object actions (master to meter)

VIFE-code	Action	Description
E000 0111	Clear	Set data to zero

10.1.2.7 2:nd manufacturer specific VIFE followed after VIFE 1111 1000 (F8 hex):

VIFE-code	Description
Ennn nnnn	Used for numbering (0–127)

10.1.2.8 2:nd manufacturer specific VIFE followed after VIFE 1111 1001 (F9 hex):

VIFE-code	Description
E000 0110	Quantity specification of event log
E000 0110	Tariff source
E001 1010	Readout request of event log
E010 1110	System log

VIFE-code	Description
E010 1111	Audit log
E011 0000	Net quality log
E011 0010	Event log
E011 0011	Event type system log
E011 0100	Event type audit log
E011 0101	Event type net quality log
E011 0111	Event type event log
E011 0nnn	Energy in CO ₂ (kg * 10 ⁿⁿⁿ⁻⁷)
E011 1nnn	Energy in currency (currency * 10 ⁿⁿⁿ⁻³)

10.1.3 Communication process

General

The Data Link Layer uses two kinds of transmission services:

Send/Confirm	SND/CON
Request/Respond	REQ/RSP

When the meter has received a correct telegram it waits between 35 and 80 ms before it reponds. A telegram is considered as correct if it passes the following tests:

- Start /Parity /Stop bits per character
- Start /Check Sum /Stop characters per telegram format
- In case of a long frame, the number of additional characters received match the L-field (= L Field + 6).
- If the received data is reasonable

The time between a response from the meter and a new message from the master must be at least 20 ms.

Send/confirm procedure

SND_NKE is used to initiate communication with the meter. When the meter has received an NKE followed by a REQ_UD2(see description below), the 1st telegram from the meter is sent out.

If the meter was selected for secondary addressing then it will be deselected. The value of the FCB is cleared in the meter, i.e., the meter expects that the first telegram from a master with FCV=1 contains an FCB=1.

The meter can either confirm a correct reception with the single character acknowledge E5h), or it can omit confirmation because it did not receive the telegram correctly.

SND_UD is used to send data to the meter. The meter either confirms reception of a correct message or it omits confirmation because it did not receive the telegram correctly.

Request/respond procedure

REQ_UD2 is used by the master to request data from the meter. **RSP_UD** is used by the meter to transfer data to the master. The meter indicates to the master that more data will follow in the next telegram by sending 1Fh as the last user data.

If the meter does not respond to the REQ_UD2, then it is an indication that the message was not received correctly or that the address does not match.

10.1.3.1 Selection and secondary addressing

General

It is possible to communicate with the meter using secondary addressing. The secondary addressing takes place with the help of a selection:

68h	0Bh	0Bh	68h	53h	FDh	52h	ID 1-4	Manu- facturer 1-2	Gener- ation ¹	Me- dium	CS	16h
-----	-----	-----	-----	-----	-----	-----	-----------	--------------------------	------------------------------	-------------	----	-----

1. Generation means the same thing as version.

The master sends a SND_UD with the control information 52h to the address 253 (FDh) and fills the specific meter secondary address fields (identification number, manufacturer, version and medium) with the values of the meter that is to be addressed. The address (FDh) and the control information (52h) is the indication for the meter to compare the following secondary address with its own, and to change into the selected state should it match. In this case the meter answers the selection with an acknowledgement (E5h), otherwise it does not reply. Selected state means that the meter can be addressed with the bus address 253 (FDh).

Wild cards

During selection individual positions of the secondary addresses can be occupied by wildcards. Such a wildcard means that this position will not be taken into account during selection. In the identification number each individual digit can be wild-carded by a wildcard nibble Fh while the fields for manufacturer, version and medium can be wild-carded by a wildcard byte FFh. The meter will remain

selected until it receives a selection command with non-matching secondary addresses, a selection command with CI=56h, or a SND_NKE to address 253.

10.2 Standard Readout of Meter Data

General

This section describes the readout of the default telegrams containing energy and instrumentation values etc. The data readout procedure starts when the master sends a REQ_UD2 telegram to the meter. The meter responds with a RSP_UD telegram. A typical readout is a multi-telegram readout. The last DIF in the user data part of the telegram is 1F to indicate that there is more data in the next telegram, or 0F if there are no more telegrams.

For EQ meters there are up to 7 default telegrams to read.



Note – Note: Normally the meter is configured to send out power values as 32 bit integers, expressed in W (or var/VA) with 2 decimals. This means that the maximum power possible to express is approximately ± 21 MW

10.2.1 Example of the 1st telegram (all values are hexadecimal)

Byte No.	Size	Value	Description
1	1	68	Start character
2	1	FA	L-field, calculated from C field to last user data
3	1	FA	L-field, repeated
4	1	68	Start character
5	1	08	C-field, RSP_UD
6	1	xx	A-field, address
7	1	72	CI-field, variable data respond, LSB first
8–11	4	xxxxxxx	Identification Number, 8 BCD digits
12–13	2	4204	Manufacturer: ABB
14	1	02	Version
15	1	02	Medium, 02 = Electricity
16	1	xx	Number of accesses
17	1	xx	Status
18–19	2	0000	Signature (0000 = no encryption)
20	1	0E	DIF size, 12 digit BCD
21	1	84	VIF for units kWh with resolution 0,01kWh
22	1	xx	VIFE status
23–28	6	xxxxxxxxxxx	Active imported energy, Total
29	1	8E	DIF size, 12 digit BCD
30	1	10	DIFE, tariff 1
31	1	84	VIF for units kWh with resolution 0,01kWh
32	1	xx	VIFE status
33–38	6	xxxxxxxxxxx	Active imported energy, Tariff 1
39	1	8E	DIF size, 12 digit BCD
40	1	20	DIFE, tariff 2
41	1	84	VIF for units kWh with resolution 0,01kWh

Byte No.	Size	Value	Description
42	1	xx	VIFE status
43–48	6	xxxxxxxxxxxx	Active imported energy, Tariff 2
49	1	8E	DIF size, 12 digit BCD
50	1	30	DIFE, tariff 3
51	1	84	VIF for units kWh with resolution 0,01kWh
52	1	xx	VIFE status
53–58	6	xxxxxxxxxxxx	Active imported energy, Tariff 3
59	1	8E	DIF size, 12 digit BCD
60	1	80	DIFE,
61	1	10	DIFE, tariff 4
62	1	84	VIF for units kWh with resolution 0,01kWh
63	1	xx	VIFE status
64–69	6	xxxxxxxxxxxx	Active imported energy, Tariff 4
70	1	8E	DIF size, 12 digit BCD
71	1	40	DIFE, unit 1
72	1	84	VIF for units kWh with resolution 0,01kWh
73	1	xx	VIFE status
74–79	6	xxxxxxxxxxxx	Active exported energy, Total
80	1	8E	DIF size, 12 digit BCD
81	1	50	DIFE, tariff 1, unit 1
82	1	84	VIF for units kWh with resolution 0,01kWh
83	1	xx	VIFE status
84–89	6	xxxxxxxxxxxx	Active exported energy, Tariff 1
90	1	8E	DIF size, 12 digit BCD
91	1	60	DIFE, tariff 2, unit 1
92	1	84	VIF for units kWh with resolution 0,01kWh
93	1	xx	VIFE status
94–99	6	xxxxxxxxxxxx	Active exported energy, Tariff 2
100	1	8E	DIF size, 12 digit BCD
101	1	70	DIFE, tariff 3, unit 1
102	1	84	VIF for units kWh with resolution 0,01kWh
103	1	xx	VIFE status
104–109	6	xxxxxxxxxxxx	Active exported energy, Tariff 3
110	1	8E	DIF size, 12 digit BCD
111	1	C0	DIFE, unit 1
112	1	10	DIFE, tariff 4
113	1	84	VIF for units kWh with resolution 0,01kWh
114	1	xx	VIFE status
115–120	6	xxxxxxxxxxxx	Active exported energy, Tariff 4
121	1	01	DIF size, 8 bit integer
122	1	FF	VIF next byte is manufacturer specific

Byte No.	Size	Value	Description
123	1	93	VIFE current tariff
124	1	xx	VIFE status
125	1	xx	Current tariff
126	1	04	DIF size, 32 bit integer
127	1	FF	VIF next byte is manufacturer specific
128	1	A0	VIFE CT ratio numerator
129	1	xx	VIFE status
130–133	4	xxxxxxx	Current transformer ratio numerator
134	1	04	DIF size, 32 bit integer
135	1	FF	VIF next byte is manufacturer specific
136	1	A1	VIFE VT ratio numerator
137	1	xx	VIFE status
138–141	4	xxxxxxx	Voltage transformer ratio numerator
142	1	04	DIF size, 32 bit integer
143	1	FF	VIF next byte is manufacturer specific
144	1	A2	VIFE CT ratio denominator
145	1	xx	VIFE status
146–149	4	xxxxxxx	Current transformer ratio denominator
150	1	04	DIF size, 32 bit integer
151	1	FF	VIF next byte is manufacturer specific
152	1	A3	VIFE VT ratio denominator
153	1	xx	VIFE status
154–157	4	xxxxxxx	Voltage transformer ratio denominator
158	1	07	DIF size, 64 bit integer
159	1	FF	VIF next byte is manufacturer specific
160	1	A6	VIFE error flags (binary)
161	1	xx	VIFE status
162–169	8	xxxxxxxxxxxxxxxx	64 Error flags
170	1	07	DIF size, 64 bit integer
171	1	FF	VIF next byte is manufacturer specific
172	1	A7	VIFE warning flags (binary)
173	1	xx	VIFE status
174–181	8	xxxxxxxxxxxxxxxx	64 Warning flags
182	1	07	DIF size, 64 bit integer
183	1	FF	VIF next byte is manufacturer specific
184	1	A8	VIFE information flags (binary)
185	1	xx	VIFE status
186–193	8	xxxxxxxxxxxxxxxx	64 Information flags
194	1	07	DIF size, 64 bit integer
195	1	FF	VIF next byte is manufacturer specific
196	1	A9	VIFE alarm flags (binary)

Byte No.	Size	Value	Description
197	1	xx	VIFE status
198–205	8	xxxxxxxxxxxxxxxx	64 Alarm flags
206	1	0E	DIF size, 12 digit BCD
207	1	ED	VIF time/date
208	1	xx	VIFE status
209–214	6	xxxxxxxxxx	Time and date (sec,min,hour,day,month,year)
215	1	01	DIF size, 8 bit integer
216	1	FF	VIF next byte is manufacturer specific
217	1	F9	VIF extension of manufacturer specific VIFE's, next VIFE specifies actual meaning
218	1	81	VIFE DST, day of week, day type, season
219	1	xx	VIFE status
220	1	xx	DST data in bit 0: 1:DST active, 0:DST inactive Day of week data in bit 1–3: 001–111; Monday–Sunday Type of day data in bit 4–5: 00–11; Type of day 1–4 Season data in bit 6–7: 00–11; Season 1–4
221	1	0D	DIF size, variable length, ASCII coding
222	1	FD	VIF extension of VIF-codes
223	1	8E	VIFE Firmware
224	1	xx	VIFE status
225	1	0C*	Byte specifying length, *see note below
226–237	12*	xxxxxxxxxxxxxxxx xxxxxx	Firmware version (ASCII coded, LSB byte first), *see note below
238	1	0D	DIF size, variable length, ASCII coding
239	1	FF	VIF next byte is manufacturer specific
240	1	AA	VIFE Type designation
241	1	xx	VIFE status
242	1	0B	Byte specifying length
243–253	11	xxxxxxxxxxxxxxxx xxxxx	Type designation (ASCII coded, LSB byte first), for example: A44 552-100
254	1	1F	DIF, more records will follow in next telegram
255	1	xx	CS checksum, calculated from C field to last data
256	1	16	Stop character

10.2.2 Example of 2nd telegram (all values are hexadecimal)

Byte No.	Size	Value	Description
1	1	68	Start character
2	1	FC	L-field, calculated from C field to last user data
3	1	FC	L-field, repeated
4	1	68	Start character
5	1	08	C-field, RSP_UD
6	1	xx	A-field, address
7	1	72	CI-field, variable data respond, LSB first

Byte No.	Size	Value	Description
8–11	4	xxxxxxx	Identification Number, 8 BCD digits
12–13	2	4204	Manufacturer: ABB
14	1	02	Version
15	1	02	Medium, 02 = Electricity
16	1	xx	Number of accesses
17	1	xx	Status
18–19	2	0000	Signature (0000 = no encryption)
20	1	04	DIF size, 32 bit integer
21	1	FF	VIF next byte is manufacturer specific
22	1	98	VIFE Power fail counter
23	1	xx	VIFE status
24–27	4	xxxxxxx	Power fail counter
28	1	04	DIF size, 32 bit integer
29	1	A9	VIF for units W with resolution 0,01W
30	1	xx	VIFE status
31–34	4	xxxxxxx	Active power, Total
35	1	04	DIF size, 32 bit integer
36	1	A9	VIF for units W with resolution 0,01W
37	1	FF	VIFE next byte is manufacturer specific
38	1	81	VIFE L1
39	1	xx	VIFE status
40–43	4	xxxxxxx	Active power, L1
44	1	04	DIF size, 32 bit integer
45	1	A9	VIF for units W with resolution 0,01W
46	1	FF	VIFE next byte is manufacturer specific
47	1	82	VIFE L2
48	1	xx	VIFE status
49–52	4	xxxxxxx	Active power, L2
53	1	04	DIF size, 32 bit integer
54	1	A9	VIF for units W with resolution 0,01W
55	1	FF	VIFE next byte is manufacturer specific
56	1	83	VIFE L3
57	1	xx	VIFE status
58–61	4	xxxxxxx	Active power, L3
62	1	84	DIF size, 32 bit integer
63	1	80	DIFE (Unit = 0)
64	1	40	DIFE (Unit = 1, => xx10 (2))
65	1	A9	VIF for units var with resolution 0,01var
66	1	xx	VIFE status
67–70	4	xxxxxxx	Reactive power, Total
71	1	84	DIF size, 32 bit integer

Byte No.	Size	Value	Description
72	1	80	DIFE (Unit = 0)
73	1	40	DIFE (Unit = 1, => xx10 (2))
74	1	A9	VIF for units var with resolution 0,01var
75	1	FF	VIFE next byte is manufacturer specific
76	1	81	VIFE L1
77	1	xx	VIFE status
78–81	4	xxxxxxx	Reactive power, L1
82	1	84	DIF size, 32 bit integer
83	1	80	DIFE (Unit = 0)
84	1	40	DIFE (Unit = 1, => xx10 (2))
85	1	A9	VIF for units var with resolution 0,01var
86	1	FF	VIFE next byte is manufacturer specific
87	1	82	VIFE L2
88	1	xx	VIFE status
89–92	4	xxxxxxx	Reactive power, L2
93	1	84	DIF size, 32 bit integer
94	1	80	DIFE (Unit = 0)
95	1	40	DIFE (Unit = 1, => xx10 (2))
96	1	A9	VIF for units var with resolution 0,01var
97	1	FF	VIFE next byte is manufacturer specific
98	1	83	VIFE L3
99	1	xx	VIFE status
100–103	4	xxxxxxx	Reactive power, L3
104	1	84	DIF size, 32 bit integer
105	1	80	DIFE (Unit = 0)
106	1	80	DIFE (Unit = 0)
107	1	40	DIFE (Unit = 1, => x100 (4))
108	1	A9	VIF for units VA with resolution 0,01VA
109	1	xx	VIFE status
110–113	4	xxxxxxx	Apparent power, Total
114	1	84	DIF size, 32 bit integer
115	1	80	DIFE (Unit = 0)
116	1	80	DIFE (Unit = 0)
117	1	40	DIFE (Unit = 1, => x100 (4))
118	1	A9	VIF for units VA with resolution 0,01VA
119	1	FF	VIFE next byte is manufacturer specific
120	1	81	VIFE L1
121	1	xx	VIFE status
122–125	4	xxxxxxx	Apparent power, L1
126	1	84	DIF size, 32 bit integer
127	1	80	DIFE (Unit = 0)

Byte No.	Size	Value	Description
128	1	80	DIFE (Unit = 0)
129	1	40	DIFE (Unit = 1, => x100 (4))
130	1	A9	VIF for units VA with resolution 0,01VA
131	1	FF	VIFE next byte is manufacturer specific
132	1	82	VIFE L2
133	1	xx	VIFE status
134–137	4	xxxxxxxx	Apparent power, L2
138	1	84	DIF size, 32 bit integer
139	1	80	DIFE (Unit = 0)
140	1	80	DIFE (Unit = 0)
141	1	40	DIFE (Unit = 1, => x100 (4))
142	1	A9	VIF for units VA with resolution 0,01VA
143	1	FF	VIFE next byte is manufacturer specific
144	1	83	VIFE L3
145	1	xx	VIFE status
146–149	4	xxxxxxxx	Apparent power, L3
150	1	04	DIF size, 32 bit integer
151	1	FD	VIF extension of VIF-codes
152	1	C8	VIFE for units V with resolution 0,1V
153	1	FF	VIFE next byte is manufacturer specific
154	1	81	VIFE L1
155	1	xx	VIFE status
156–159	4	xxxxxxxx	Voltage L1 - N
160	1	04	DIF size, 32 bit integer
161	1	FD	VIF extension of VIF-codes
162	1	C8	VIFE for units V with resolution 0,1V
163	1	FF	VIFE next byte is manufacturer specific
164	1	82	VIFE L2
165	1	xx	VIFE status
166–169	4	xxxxxxxx	Voltage L2 - N
170	1	04	DIF size, 32 bit integer
171	1	FD	VIF extension of VIF-codes
172	1	C8	VIFE for units V with resolution 0,1V
173	1	FF	VIFE next byte is manufacturer specific
174	1	83	VIFE L3
175	1	xx	VIFE status
176–179	4	xxxxxxxx	Voltage L3 - N
180	1	04	DIF size, 32 bit integer
181	1	FD	VIF extension of VIF-codes
182	1	C8	VIFE for units V with resolution 0,1V
183	1	FF	VIFE next byte is manufacturer specific

Byte No.	Size	Value	Description
184	1	85	VIFE L1 - L2
185	1	xx	VIFE status
186–189	4	xxxxxxxx	Voltage L1 - L2
190	1	04	DIF size, 32 bit integer
191	1	FD	VIF extension of VIF-codes
192	1	C8	VIFE for units V with resolution 0,1V
193	1	FF	VIFE next byte is manufacturer specific
194	1	86	VIFE L2 - L3
195	1	xx	VIFE status
196–199	4	xxxxxxxx	Voltage L3 - L2
200	1	04	DIF size, 32 bit integer
201	1	FD	VIF extension of VIF-codes
202	1	C8	VIFE for units V with resolution 0,1V
203	1	FF	VIFE next byte is manufacturer specific
204	1	87	VIFE L1 - L3
205	1	xx	VIFE status
206–209	4	xxxxxxxx	Voltage L1 - L3
210	1	04	DIF size, 32 bit integer
211	1	FD	VIF extension of VIF-codes
212	1	DA	VIFE for units A with resolution 0,01A
213	1	FF	VIFE next byte is manufacturer specific
214	1	81	VIFE L1
215	1	xx	VIFE status
216–219	4	xxxxxxxx	Current L1
220	1	04	DIF size, 32 bit integer
221	1	FD	VIF extension of VIF-codes
222	1	DA	VIFE for units A with resolution 0,01A
223	1	FF	VIFE next byte is manufacturer specific
224	1	82	VIFE L2
225	1	xx	VIFE status
226–229	4	xxxxxxxx	Current L2
230	1	04	DIF size, 32 bit integer
231	1	FD	VIF extension of VIF-codes
232	1	DA	VIFE for units A with resolution 0,01A
233	1	FF	VIFE next byte is manufacturer specific
234	1	83	VIFE L3
235	1	xx	VIFE status
236–239	4	xxxxxxxx	Current L3
240	1	04	DIF size, 32 bit integer
241	1	FD	VIF extension of VIF-codes
242	1	DA	VIFE for units A with resolution 0,01A

Byte No.	Size	Value	Description
243	1	FF	VIFE next byte is manufacturer specific
244	1	84	VIFE N
245	1	xx	VIFE status
246–249	4	xxxxxxx	Current N
250	1	0A	DIF size, 4 digit BCD
251	1	FF	VIF next byte is manufacturer specific
252	1	E9	VIFE Frequency with resolution 0.01Hz
253	1	xx	VIFE status
254–255	2	xxxx	Frequency
256	1	1F	DIF more records will follow in next telegram
257	1	xx	CS checksum, calculated from C field to last data
258	1	16	Stop character

10.2.3 Example of 3rd telegram (all values are hexadecimal)

Byte No.	Size	Value	Description
1	1	68	Start character
2	1	F4	L-field, calculated from C field to last user data
3	1	F4	L-field, repeated
4	1	68	Start character
5	1	08	C-field, RSP_UD
6	1	xx	A-field, address
7	1	72	CI-field, variable data respond, LSB first
8–11	4	xxxxxxx	Identification Number, 8 BCD digits
12–13	2	4204	Manufacturer: ABB
14	1	02	Version
15	1	02	Medium, 02 = Electricity
16	1	xx	Number of accesses
17	1	xx	Status
18–19	2	0000	Signature (0000 = no encryption)
20	1	0E	DIF size, 12 digit BCD
21	1	FF	VIF next byte is manufacturer specific
22	1	EC	VIFE Power outage time
23	1	xx	VIFE status
24–29	6	xxxxxxxxxxx	Power outage time (sec, min, hour, days, LSB first)
30	1	02	DIF size, 16 bit integer
31	1	FF	VIF next byte is manufacturer specific
32	1	E0	VIFE power factor with resolution 0,001
33	1	xx	VIFE status
34–35	2	xxxx	Power factor, Total
36	1	02	DIF size, 16 bit integer
37	1	FF	VIF next byte is manufacturer specific

Byte No.	Size	Value	Description
38	1	E0	VIFE power factor with resolution 0,001
39	1	FF	VIFE next byte is manufacturer specific
40	1	81	VIFE L1
41	1	xx	VIFE status
42–43	2	xxxx	Power factor, L1
44	1	02	DIF size, 16 bit integer
45	1	FF	VIF next byte is manufacturer specific
46	1	E0	VIFE power factor with resolution 0,001
47	1	FF	VIFE next byte is manufacturer specific
48	1	82	VIFE L2
49	1	xx	VIFE status
50–51	2	xxxx	Power factor, L2
52	1	02	DIF size, 16 bit integer
53	1	FF	VIF next byte is manufacturer specific
54	1	E0	VIFE power factor with resolution 0,001
55	1	FF	VIFE next byte is manufacturer specific
56	1	83	VIFE L3
57	1	xx	VIFE status
58–59	2	xxxx	Power factor, L3
60	1	02	DIF size, 16 bit integer
61	1	FF	VIF next byte is manufacturer specific
62	1	D2	VIFE phase angle power with resolution 0.1
63	1	xx	VIFE status
64–65	2	xxxx	Phase angle power, Total
66	1	02	DIF size, 16 bit integer
67	1	FF	VIF next byte is manufacturer specific
68	1	D2	VIFE phase angle power with resolution 0.1
69	1	FF	VIFE next byte is manufacturer specific
70	1	81	VIFE L1
71	1	xx	VIFE status
72–73	2	xxxx	Phase angle power, L1
74	1	02	DIF size, 16 bit integer
75	1	FF	VIF next byte is manufacturer specific
76	1	D2	VIFE phase angle power with resolution 0.1
77	1	FF	VIFE next byte is manufacturer specific
78	1	82	VIFE L2
79	1	xx	VIFE status
80–81	2	xxxx	Phase angle power, L2
82	1	02	DIF size, 16 bit integer
83	1	FF	VIF next byte is manufacturer specific
84	1	D2	VIFE phase angle power with resolution 0.1

Byte No.	Size	Value	Description
85	1	FF	VIFE next byte is manufacturer specific
86	1	83	VIFE L3
87	1	xx	VIFE status
88–89	2	xxxx	Phase angle power, L3
90	1	02	DIF size, 16 bit integer
91	1	FF	VIF next byte is manufacturer specific
92	1	C2	VIFE phase angle voltage with resolution 0.1
93	1	FF	VIFE next byte is manufacturer specific
94	1	81	VIFE L1
95	1	xx	VIFE status
96–97	2	xxxx	Phase angle voltage, L1
98	1	02	DIF size, 16 bit integer
99	1	FF	VIF next byte is manufacturer specific
100	1	C2	VIFE phase angle voltage with resolution 0.1
101	1	FF	VIFE next byte is manufacturer specific
102	1	82	VIFE L2
103	1	xx	VIFE status
104–105	2	xxxx	Phase angle voltage, L2
106	1	02	DIF size, 16 bit integer
107	1	FF	VIF next byte is manufacturer specific
108	1	C2	VIFE phase angle voltage with resolution 0.1
109	1	FF	VIFE next byte is manufacturer specific
110	1	83	VIFE L3
111	1	xx	VIFE status
112–113	2	xxxx	Phase angle voltage, L3
114	1	02	DIF size, 16 bit integer
115	1	FF	VIF next byte is manufacturer specific
116	1	CA	VIFE phase angle current with resolution 0.1
117	1	FA	VIFE next byte is manufacturer specific
118	1	81	VIFE L1
119	1	xx	VIFE status
120–121	2	xxxx	Phase angle current, L1
122	1	02	DIF size, 16 bit integer
123	1	FF	VIF next byte is manufacturer specific
124	1	CA	VIFE phase angle current with resolution 0.1
125	1	FF	VIFE next byte is manufacturer specific
126	1	82	VIFE L2
127	1	xx	VIFE status
128–129	2	xxxx	Phase angle current, L2
130	1	02	DIF size, 16 bit integer
131	1	FF	VIF next byte is manufacturer specific

Byte No.	Size	Value	Description
132	1	CA	VIFE phase angle current with resolution 0.1
133	1	FF	VIFE next byte is manufacturer specific
134	1	83	VIFE L3
135	1	xx	VIFE status
136–137	2	xxxx	Phase angle current, L3
138	1	8E	DIF size, 12 digit BCD
139	1	80	DIFE,
140	1	40	DIFE, unit 2
141	1	84	VIF for units kvarh with resolution 0,01kvarh
142	1	xx	VIFE status
143–148	6	xxxxxxxxxxx	Reactive imported energy, Total
149	1	8E	DIF size, 12 digit BCD
150	1	90	DIFE, tariff 1
151	1	40	DIFE, unit 2
152	1	84	VIF for units kvarh with resolution 0,01kvarh
153	1	xx	VIFE status
154–159	6	xxxxxxxxxxx	Reactive imported energy, Tariff 1
160	1	8E	DIF size, 12 digit BCD
161	1	A0	DIFE, tariff 2
162	1	40	DIFE, unit 2
163	1	84	VIF for units kvarh with resolution 0,01kvarh
164	1	xx	VIFE status
165–170	6	xxxxxxxxxxx	Reactive imported energy, Tariff 2
171	1	8E	DIF size, 12 digit BCD
172	1	B0	DIFE, tariff 3
173	1	40	DIFE, unit 2
174	1	84	VIF for units kvarh with resolution 0,01kvarh
175	1	xx	VIFE status
176–181	6	xxxxxxxxxxx	Reactive imported energy, Tariff 3
182	1	8E	DIF size, 12 digit BCD
183	1	80	DIFE,
184	1	50	DIFE, tariff 4, unit 2
185	1	84	VIF for units kvarh with resolution 0,01kvarh
186	1	xx	VIFE status
187–192	6	xxxxxxxxxxx	Reactive imported energy, Tariff 4
193	1	8E	DIF size, 12 digit BCD
194	1	C0	DIFE, unit bit 0
195	1	40	DIFE, unit bit 1, unit bit0–1–> unit 3
196	1	84	VIF for units kvarh with resolution 0,01kvarh
197	1	xx	VIFE status
198–203	6	xxxxxxxxxxx	Reactive exported energy, Total

Byte No.	Size	Value	Description
204	1	8E	DIF size, 12 digit BCD
205	1	D0	DIFE, tariff 1, unit bit 0
206	1	40	DIFE, unit bit 1, unit bit 0–1→ unit 3
207	1	84	VIF for units kvarh with resolution 0,01kvarh
208	1	xx	VIFE status
209–214	6	xxxxxxxxxxx	Reactive exported energy, Tariff 1
215	1	8E	DIF size, 12 digit BCD
216	1	E0	DIFE, tariff 2, unit bit 0
217	1	40	DIFE, unit bit 1, unit bit 0–1→ unit 3
218	1	84	VIF for units kvarh with resolution 0,01kvarh
219	1	xx	VIFE status
220–225	6	xxxxxxxxxxx	Reactive exported energy, Tariff 2
226	1	8E	DIF size, 12 digit BCD
227	1	F0	DIFE, tariff 3, unit bit 0
228	1	40	DIFE, unit bit 1, unit bit 0–1→ unit 3
229	1	84	VIF for units kvarh with resolution 0,01kvarh
230	1	xx	VIFE status
231–236	6	xxxxxxxxxxx	Reactive exported energy, Tariff 3
237	1	8E	DIF size, 12 digit BCD
238	1	C0	DIFE, unit bit 0
239	1	50	DIFE, tariff 4, unit bit 1, unit bit 0–1→ unit 3
240	1	84	VIF for units kvarh with resolution 0,01kvarh
241	1	xx	VIFE status
242–247	6	xxxxxxxxxxx	Reactive exported energy, Tariff 4
248	1	1F	DIF, more records will follow in next telegram
249	1	xx	CS checksum, calculated from C field to last data
250	1	16	Stop character

10.2.4 Example of the 4th telegram (all values are hexadecimal)

Byte No.	Size	Value	Description
1	1	68	Start character
2	1	AE	L-field, calculated from C field to last user data
3	1	AE	L-field, repeated
4	1	68	Start character
5	1	08	C-field, RSP_UD
6	1	xx	A-field, address
7	1	72	CI-field, variable data respond, LSB first
8–11	4	xxxxxxx	Identification Number, 8 BCD digits
12–13	2	4204	Manufacturer: ABB
14	1	02	Version
15	1	02	Medium, 02 = Electricity

Byte No.	Size	Value	Description
16	1	xx	Number of accesses
17	1	xx	Status
18–19	2	0000	Signature (0000 = no encryption)
20	1	01	DIF size, 8 bit integer
21	1	FF	VIF next byte is manufacturer specific
22	1	97	VIFE current quadrant
23	1	xx	VIFE status
24	1	xx	Current quadrant, total
25	1	01	DIF size, 8 bit integer
26	1	FF	VIF next byte is manufacturer specific
27	1	97	VIFE current quadrant
28	1	FF	VIF next byte is manufacturer specific
29	1	81	VIFE L1
30	1	xx	VIFE status
31	1	xx	Current quadrant, L1
32	1	01	DIF size, 8 bit integer
33	1	FF	VIF next byte is manufacturer specific
34	1	97	VIFE current quadrant
35	1	FF	VIF next byte is manufacturer specific
36	1	82	VIFE L2
37	1	xx	VIFE status
38	1	xx	Current quadrant, L2
39	1	01	DIF size, 8 bit integer
40	1	FF	VIF next byte is manufacturer specific
41	1	97	VIFE current quadrant
42	1	FF	VIF next byte is manufacturer specific
43	1	83	VIFE L3
44	1	xx	VIFE status
45	1	xx	Current quadrant, L3
46	1	81	DIF size, 8 bit integer
47	1	40	DIFE (Unit = 1)
48	1	FD	VIF extension of VIF-codes
49	1	9A	VIFE digital output
50	1	xx	VIFE status
51	1	xx	Output 1, current state
52	1	81	DIF size, 8 bit integer
53	1	80	DIFE,
54	1	40	DIFE (Unit = 2)
55	1	FD	VIF extension of VIF-codes
56	1	9A	VIFE digital output
57	1	xx	VIFE status

Byte No.	Size	Value	Description
58	1	xx	Output 2, current state
59	1	81	DIF size, 8 bit integer
60	1	C0	DIFE (Unit = 1)
61	1	40	DIFE (Unit = 2)
62	1	FD	VIF extension of VIF-codes
63	1	9A	VIFE digital output
64	1	xx	VIFE status
65	1	xx	Output 3, current state
66	1	81	DIF size, 8 bit integer
67	1	80	DIFE,
68	1	80	DIFE,
69	1	40	DIFE (Unit = 4)
70	1	FD	VIF extension of VIF-codes
71	1	9A	VIFE digital output
72	1	xx	VIFE status
73	1	xx	Output 4, current state
74	1	81	DIF size, 8 bit integer
75	1	40	DIFE (Unit = 1)
76	1	FD	VIF extension of VIF-codes
77	1	9B	VIFE digital input
78	1	xx	VIFE status
79	1	xx	Input 1 current state
80	1	81	DIF size, 8 bit integer
81	1	80	DIFE,
82	1	40	DIFE (Unit = 2)
83	1	FD	VIF extension of VIF-codes
84	1	9B	VIFE digital input
85	1	xx	VIFE status
86	1	xx	Input 2 current state
87	1	81	DIF size, 8 bit integer
88	1	C0	DIFE (Unit = 1)
89	1	40	DIFE (Unit = 2)
90	1	FD	VIF extension of VIF-codes
91	1	9B	VIFE digital input
92	1	xx	VIFE status
93	1	xx	Input 3 current state
94	1	81	DIF size, 8 bit integer
95	1	80	DIFE,
96	1	80	DIFE,
97	1	40	DIFE (Unit = 4)
98	1	FD	VIF extension of VIF-codes

Byte No.	Size	Value	Description
99	1	9B	VIFE digital input
100	1	xx	VIFE status
101	1	xx	Input 4 current state
102	1	C1	DIF size, 8 bit integer, storage number 1
103	1	40	DIFE (Unit = 1)
104	1	FD	VIF extension of VIF-codes
105	1	9B	VIFE digital input
106	1	xx	VIFE status
107	1	xx	Input 1, stored state (1 if current state has been 1)
108	1	C1	DIF size, 8 bit integer, storage number 1
109	1	80	DIFE,
110	1	40	DIFE (Unit = 2)
111	1	FD	VIF extension of VIF-codes
112	1	9B	VIFE digital input
113	1	xx	VIFE status
114	1	xx	Input 2, stored state (1 if current state has been 1)
115	1	C1	DIF size, 8 bit integer, storage number 1
116	1	C0	DIFE (Unit = 1)
117	1	40	DIFE (Unit = 2)
118	1	FD	VIF extension of VIF-codes
119	1	9B	VIFE digital input
120	1	xx	VIFE status
121	1	xx	Input 3, stored state (1 if current state has been 1)
122	1	C1	DIF size, 8 bit integer, storage number 1
123	1	80	DIFE,
124	1	80	DIFE,
125	1	40	DIFE (Unit = 4)
126	1	FD	VIF extension of VIF-codes
127	1	9B	VIFE digital input
128	1	xx	VIFE status
129	1	xx	Input 4, stored state (1 if current state has been 1)
130	1	8E	DIF size, 12 digit BCD
131	1	40	DIFE (Unit = 1)
132	1	FD	VIF extension of VIF-codes
133	1	E1	VIFE cumulating counter
134	1	xx	VIFE status
135–140	6	xxxxxxxxxxx	Counter 1 (input 1)
141	1	8E	DIF size, 12 digit BCD
142	1	80	DIFE,
143	1	40	DIFE (Unit = 2)
144	1	FD	VIF extension of VIF-codes

Byte No.	Size	Value	Description
145	1	E1	VIFE cumulating counter
146	1	xx	VIFE status
147–152	6	xxxxxxxxxxxx	Counter 2 (input 2)
153	1	8E	DIF size, 12 digit BCD
154	1	C0	DIFE (Unit = 1)
155	1	40	DIFE (Unit = 2)
156	1	FD	VIF extension of VIF-codes
157	1	E1	VIFE cumulating counter
158	1	xx	VIFE status
159–164	6	xxxxxxxxxxxx	Counter 3 (input 3)
165	1	8E	DIF size, 12 digit BCD
166	1	80	DIFE,
167	1	80	DIFE,
168	1	40	DIFE (Unit = 4)
169	1	FD	VIF extension of VIF-codes
170	1	E1	VIFE cumulating counter
171	1	xx	VIFE status
172–177	6	xxxxxxxxxxxx	Counter 4 (input 4)
178	1	1F	DIF, more records will follow in next telegram
179	1	xx	CS checksum, calculated from C field to last data
180	1	16	Stop character

10.2.5 Example of the 5th telegram (all values are hexadecimal)

Byte No.	Size	Value	Description
1	1	68	Start character
2	1	A4	L-field, calculated from C field to last user data
3	1	A4	L-field, repeated
4	1	68	Start character
5	1	08	C-field, RSP_UD
6	1	xx	A-field, address
7	1	72	CI-field, variable data respond, LSB first
8–11	4	xxxxxxx	Identification Number, 8 BCD digits
12–13	2	4204	Manufacturer: ABB
14	1	02	Version
15	1	02	Medium, 02 = Electricity
16	1	xx	Number of accesses
17	1	xx	Status
18–19	2	0000	Signature (0000 = no encryption)
20	1	0E	DIF size, 12 digit BCD
21	1	84	VIF for units kWh with resolution 0,01kWh
22	1	FF	VIFE next byte is manufacturer specific

Byte No.	Size	Value	Description
23	1	F2	VIFE resettable energy
24	1	xx	VIFE status
25–30	6	xxxxxxxxxxx	Resettable active imported energy, Total
31	1	8E	DIF size, 12 digit BCD
32	1	40	DIFE (Unit = 1)
33	1	84	VIF for units kWh with resolution 0,01kWh
34	1	FF	VIFE next byte is manufacturer specific
35	1	F2	VIFE resettable energy
36	1	xx	VIFE status
37–42	6	xxxxxxxxxxx	Resettable active exported energy, Total
43	1	8E	DIF size, 12 digit BCD
44	1	80	DIFE
45	1	40	DIFE (Unit = 2)
46	1	84	VIF for units kvarh with resolution 0,01kvarh
47	1	FF	VIFE next byte is manufacturer specific
48	1	F2	VIFE resettable energy
49	1	xx	VIFE status
50–55	6	xxxxxxxxxxx	Resettable reactive imported energy, Total
56	1	8E	DIF size, 12 digit BCD
57	1	C0	DIFE (Unit = 1)
58	1	40	DIFE (Unit = 2)
59	1	84	VIF for units kvar with resolution 0,01kvarh
60	1	FF	VIFE next byte is manufacturer specific
61	1	F2	VIFE resettable energy
62	1	xx	VIFE status
63–68	6	xxxxxxxxxxx	Resettable reactive exported energy, Total
69	1	04	DIF size, 32 bit integer
70	1	FF	VIFE next byte is manufacturer specific
71	1	F1	VIFE reset counter
72	1	xx	VIFE status
73–76	4	xxxxxxx	Reset counter for active imported energy, Total
77	1	84	DIF size, 32 bit integer
78	1	40	DIFE (Unit = 1)
79	1	FF	VIFE next byte is manufacturer specific
80	1	F1	VIFE reset counter
81	1	xx	VIFE status
82–85	4	xxxxxxx	Reset counter for active exported energy, Total
86	1	84	DIF size, 32 bit integer
87	1	80	DIFE
88	1	40	DIFE (Unit = 2)
89	1	FF	VIFE next byte is manufacturer specific

Byte No.	Size	Value	Description
90	1	F1	VIFE reset counter
91	1	xx	VIFE status
92–95	4	xxxxxxx	Reset counter for reactive imported energy, Total
96	1	84	DIF size, 32 bit integer
97	1	C0	DIFE (Unit = 1)
98	1	40	DIFE (Unit = 2)
99	1	FF	VIFE next byte is manufacturer specific
100	1	F1	VIFE reset counter
101	1	xx	VIFE status
102–105	4	xxxxxxx	Reset counter for reactive exported energy, Total
106	1	0E	DIF size, 12 digit BCD
107	1	FF	VIFE next byte is manufacturer specific
108	1	F9	VIF extension of manufacturer specific VIFE's
109	1	C4	Energy in CO2 with resolution 0,001 kg
110	1	xx	VIFE status
111–116	6	xxxxxxxxxxx	CO2 for active imported energy, Total
117	1	0E	DIF size, 12 digit BCD
118	1	FF	VIFE next byte is manufacturer specific
119	1	F9	VIF extension of manufacturer specific VIFE's
120	1	C9	Energy in Currency with resolution 0,01 currency
121	1	xx	VIFE status
122–127	6	xxxxxxxxxxx	Currency for active imported energy, Total
128	1	04	DIF size, 32 bit integer
129	1	FF	VIFE next byte is manufacturer specific
130	1	A4	CO2 conversion factor in g/kWh
131	1	xx	VIFE status
132–133	4	xxxxxxx	CO2 conversion factor for active energy
134	1	04	DIF size, 32 bit integer
135	1	FF	VIFE next byte is manufacturer specific
136	1	A5	Currency conversion factor in 0,001 currency/kWh
137	1	xx	VIFE status
138–143	4	xxxxxxx	Currency conversion factor for active energy
144	1	8E	DIF size, 12 digit BCD
145	1	80	DIFE
146	1	80	DIFE
147	1	40	DIFE, Unit 4
148	1	84	VIF for unit kVAh with resolution 0,01kVAh
149	1	xx	VIFE status
150–155	6	xxxxxxxxxxx	Apparent imported energy, Total
156	1	8E	DIF size, 12 digit BCD
157	1	C0	DIFE, Unit bit 0

Byte No.	Size	Value	Description
158	1	80	DIFE, Unit bit 1
159	1	40	DIFE, Unit bit 2, Unit bit 0–2 → Unit 5
160	1	84	VIF for unit kVAh with resolution 0,01kVAh
161	1	xx	VIFE status
162–167	6	xxxxxxxxxxx	Apparent exported energy, Total
168	1	1F	DIF, more records will follow in next telegram
169	1	xx	CS checksum, calculated from C field to last data
170	1	16	Stop character

10.2.6 Example of the 6th telegram (all values are hexadecimal)

Byte No.	Size	Value	Description
1	1	68	Start character
2	1	F7	L-field, calculated from C field to last user data
3	1	F7	L-field, repeated
4	1	68	Start character
5	1	08	C-field, RSP_UD
6	1	xx	A-field, address
7	1	72	CI-field, variable data respond, LSB first
8–11	4	xxxxxxx	Identification Number, 8 BCD digits
12–13	2	4204	Manufacturer: ABB
14	1	02	Version
15	1	02	Medium, 02 = Electricity
16	1	xx	Number of accesses
17	1	xx	Status
18–19	2	0000	Signature (0000 = no encryption)
20	1	0E	DIF size, 12 digit BCD
21	1	84	VIF for units kWh with resolution 0,01kWh
22	1	FF	VIFE next byte is manufacturer specific
23	1	81	VIFE L1
24	1	xx	VIFE status
25–30	6	xxxxxxxxxxx	Active imported energy, L1
31	1	0E	DIF size, 12 digit BCD
32	1	84	VIF for units kWh with resolution 0,01kWh
33	1	FF	VIFE next byte is manufacturer specific
34	1	82	VIFE L2
35	1	xx	VIFE status
36–41	6	xxxxxxxxxxx	Active imported energy, L2
42	1	0E	DIF size, 12 digit BCD
43	1	84	VIF for units kWh with resolution 0,01kWh
44	1	FF	VIFE next byte is manufacturer specific
45	1	83	VIFE L3

Byte No.	Size	Value	Description
46	1	xx	VIFE status
47–52	6	xxxxxxxxxxxx	Active imported energy, L3
53	1	8E	DIF size, 12 digit BCD
54	1	80	DIFE
55	1	40	DIFE, Unit 2
56	1	84	VIF for units kvarh with resolution 0,01 kvarh
57	1	FF	VIFE next byte is manufacturer specific
58	1	81	VIFE L1
59	1	xx	VIFE status
60–65	6	xxxxxxxxxxxx	Reactive imported energy, L1
66	1	8E	DIF size, 12 digit BCD
67	1	80	DIFE
68	1	40	DIFE, Unit 2
69	1	84	VIF for units kvarh with resolution 0,01 kvarh
70	1	FF	VIFE next byte is manufacturer specific
71	1	82	VIFE L2
72	1	xx	VIFE status
73–78	6	xxxxxxxxxxxx	Reactive imported energy, L2
79	1	8E	DIF size, 12 digit BCD
80	1	80	DIFE
81	1	40	DIFE, Unit 2
82	1	84	VIF for units kvarh with resolution 0,01 kvarh
83	1	FF	VIFE next byte is manufacturer specific
84	1	83	VIFE L3
85	1	xx	VIFE status
86–91	6	xxxxxxxxxxxx	Reactive imported energy, L3
92	1	8E	DIF size, 12 digit BCD
93	1	80	DIFE
94	1	80	DIFE
95	1	40	DIFE, Unit 4
96	1	84	VIF for unit kVAh with resolution 0,01kVAh
97	1	FF	VIFE next byte is manufacturer specific
98	1	81	VIFE L1
99	1	xx	VIFE status
100–105	6	xxxxxxxxxxxx	Apparent imported energy, L1
106	1	8E	DIF size, 12 digit BCD
107	1	80	DIFE
108	1	80	DIFE
109	1	40	DIFE, Unit 4
110	1	84	VIF for unit kVAh with resolution 0,01kVAh
111	1	FF	VIFE next byte is manufacturer specific

Byte No.	Size	Value	Description
112	1	82	VIFE L2
113	1	xx	VIFE status
114–119	6	xxxxxxxxxxxx	Apparent imported energy, L2
120	1	8E	DIF size, 12 digit BCD
121	1	80	DIFE
122	1	80	DIFE
123	1	40	DIFE, Unit 4
124	1	84	VIF for unit kVAh with resolution 0,01kVAh
125	1	FF	VIFE next byte is manufacturer specific
126	1	83	VIFE L3
127	1	xx	VIFE status
128–133	6	xxxxxxxxxxxx	Apparent imported energy, L3
134	1	8E	DIF size, 12 digit BCD
135	1	40	DIFE, Unit 1
136	1	84	VIF for units kWh with resolution 0,01kWh
137	1	FF	VIFE next byte is manufacturer specific
138	1	81	VIFE L1
139	1	xx	VIFE status
140–145	6	xxxxxxxxxxxx	Active exported energy, L1
146	1	8E	DIF size, 12 digit BCD
147	1	40	DIFE, Unit 1
148	1	84	VIF for units kWh with resolution 0,01kWh
149	1	FF	VIFE next byte is manufacturer specific
150	1	82	VIFE L2
151	1	xx	VIFE status
152–157	6	xxxxxxxxxxxx	Active exported energy, L2
158	1	8E	DIF size, 12 digit BCD
159	1	40	DIFE, Unit 1
160	1	84	VIF for units kWh with resolution 0,01kWh
161	1	FF	VIFE next byte is manufacturer specific
162	1	83	VIFE L3
163	1	xx	VIFE status
164–169	6	xxxxxxxxxxxx	Active exported energy, L3
170	1	8E	DIF size, 12 digit BCD
171	1	C0	DIFE, Unit bit 0
172	1	40	DIFE, Unit bit 1, unit bit0–1→ unit 3
173	1	84	VIF for units kvarh with resolution 0,01 kvarh
174	1	FF	VIFE next byte is manufacturer specific
175	1	81	VIFE L1
176	1	xx	VIFE status
177–182	6	xxxxxxxxxxxx	Reactive exported energy, L1

Byte No.	Size	Value	Description
183	1	8E	DIF size, 12 digit BCD
184	1	C0	DIFE, Unit bit 0
185	1	40	DIFE, Unit bit 1, unit bit0-1-> unit 3
186	1	84	VIF for units kvarh with resolution 0,01 kvarh
187	1	FF	VIFE next byte is manufacturer specific
188	1	82	VIFE L2
189	1	xx	VIFE status
190-195	6	xxxxxxxxxxx	Reactive exported energy, L2
196	1	8E	DIF size, 12 digit BCD
197	1	C0	DIFE, Unit bit 0
198	1	40	DIFE, Unit bit 1, unit bit0-1-> unit 3
199	1	84	VIF for units kvarh with resolution 0,01 kvarh
200	1	FF	VIFE next byte is manufacturer specific
201	1	83	VIFE L3
202	1	xx	VIFE status
203-208	6	xxxxxxxxxxx	Reactive exported energy, L3
209	1	8E	DIF size, 12 digit BCD
210	1	C0	DIFE, Unit bit 0
211	1	80	DIFE, Unit bit 1
212	1	40	DIFE, Unit bit 2, unit bit0-2-> unit 5
213	1	84	VIF for unit kVAh with resolution 0,01kVAh
214	1	FF	VIFE next byte is manufacturer specific
215	1	81	VIFE L1
216	1	xx	VIFE status
217-222	6	xxxxxxxxxxx	Apparent exported energy, L1
223	1	8E	DIF size, 12 digit BCD
224	1	C0	DIFE, Unit bit 0
225	1	80	DIFE, Unit bit 1
226	1	40	DIFE, Unit bit 2, unit bit0-2-> unit 5
227	1	84	VIF for unit kVAh with resolution 0,01kVAh
228	1	FF	VIFE next byte is manufacturer specific
229	1	82	VIFE L2
230	1	xx	VIFE status
231-236	6	xxxxxxxxxxx	Apparent exported energy, L2
237	1	8E	DIF size, 12 digit BCD
238	1	C0	DIFE, Unit bit 0
239	1	80	DIFE, Unit bit 1
240	1	40	DIFE, Unit bit 2, unit bit0-2-> unit 5
241	1	84	VIF for unit kVAh with resolution 0,01kVAh
242	1	FF	VIFE next byte is manufacturer specific
243	1	83	VIFE L3

Byte No.	Size	Value	Description
244	1	xx	VIFE status
245–250	6	xxxxxxxxxxx	Apparent exported energy, L3
251	1	1F	DIF, more records will follow in next telegram
252	1	xx	CS checksum, calculated from C field to last data
253	1	16	Stop character

10.2.7 Example of the 7th telegram (all values are hexadecimal)

Byte No.	Size	Value	Description
1	1	68	Start character
2	1	B6	L-field, calculated from C field to last user data
3	1	B6	L-field, repeated
4	1	68	Start character
5	1	08	C-field, RSP_UD
6	1	xx	A-field, address
7	1	72	CI-field, variable data respond, LSB first
8–11	4	xxxxxxx	Identification Number, 8 BCD digits
12–13	2	4204	Manufacturer: ABB
14	1	02	Version
15	1	02	Medium, 02 = Electricity
16	1	xx	Number of accesses
17	1	xx	Status
18–19	2	0000	Signature (0000 = no encryption)
20	1	8E	DIF size, 12 digit BCD
21	1	80	DIFE
22	1	C0	DIFE, Unit 2
23	1	40	DIFE, Unit 4
24	1	84	VIF for unit kWh with resolution 0,01kWh
25	1	xx	VIFE status
26–31	6	xxxxxxxxxxx	Active net energy, Total
32	1	8E	DIF size, 12 digit BCD
33	1	80	DIFE
34	1	C0	DIFE, Unit 2
35	1	40	DIFE, Unit 4
36	1	84	VIF for unit kWh with resolution 0,01kWh
37	1	FF	VIFE next byte is manufacturer specific
38	1	81	VIFE L1
39	1	xx	VIFE status
40–45	6	xxxxxxxxxxx	Active net energy, L1
46	1	8E	DIF size, 12 digit BCD
47	1	80	DIFE
48	1	C0	DIFE, Unit 2

Byte No.	Size	Value	Description
49	1	40	DIFE, Unit 4
50	1	84	VIF for unit kWh with resolution 0,01kWh
51	1	FF	VIFE next byte is manufacturer specific
52	1	82	VIFE L2
53	1	xx	VIFE status
54–59	6	xxxxxxxxxxx	Active net energy, L2
60	1	8E	DIF size, 12 digit BCD
61	1	80	DIFE
62	1	C0	DIFE, Unit 2
63	1	40	DIFE, Unit 4
64	1	84	VIF for unit kWh with resolution 0,01kWh
65	1	FF	VIFE next byte is manufacturer specific
66	1	83	VIFE L3
67	1	xx	VIFE status
68–73	6	xxxxxxxxxxx	Active net energy, L3
74	1	8E	DIF size, 12 digit BCD
75	1	C0	DIFE, Unit 1
76	1	C0	DIFE, Unit 2
77	1	40	DIFE, Unit 4
78	1	84	VIF for unit kvarh with resolution 0,01kvarh
79	1	xx	VIFE status
80–85	6	xxxxxxxxxxx	Reactive net energy, Total
86	1	8E	DIF size, 12 digit BCD
87	1	C0	DIFE, Unit 1
88	1	C0	DIFE, Unit 2
89	1	40	DIFE, Unit 4
90	1	84	VIF for unit kvarh with resolution 0,01kvarh
91	1	FF	VIFE next byte is manufacturer specific
92	1	81	VIFE L1
93	1	xx	VIFE status
94–99	6	xxxxxxxxxxx	Reactive net energy, L1
100	1	8E	DIF size, 12 digit BCD
101	1	C0	DIFE, Unit 1
102	1	C0	DIFE, Unit 2
103	1	40	DIFE, Unit 4
104	1	84	VIF for unit kvarh with resolution 0,01kvarh
105	1	FF	VIFE next byte is manufacturer specific
106	1	82	VIFE L2
107	1	xx	VIFE status
108–113	6	xxxxxxxxxxx	Reactive net energy, L2
114	1	8E	DIF size, 12 digit BCD

Byte No.	Size	Value	Description
115	1	C0	DIFE, Unit 1
116	1	C0	DIFE, Unit 2
117	1	40	DIFE, Unit 4
118	1	84	VIF for unit kvarh with resolution 0,01kvarh
119	1	FF	VIFE next byte is manufacturer specific
120	1	83	VIFE L3
121	1	xx	VIFE status
122–127	6	xxxxxxxxxxx	Reactive net energy, L3
128	1	8E	DIF size, 12 digit BCD
129	1	80	DIFE
130	1	80	DIFE
131	1	80	DIFE
132	1	40	DIFE, Unit 8
133	1	84	VIF for unit kVAh with resolution 0,01kVAh
134	1	xx	VIFE status
135–140	6	xxxxxxxxxxx	Apparent net energy, Total
141	1	8E	DIF size, 12 digit BCD
142	1	80	DIFE
143	1	80	DIFE
144	1	80	DIFE
145	1	40	DIFE, Unit 8
146	1	84	VIF for unit kVAh with resolution 0,01kVAh
147	1	FF	VIFE next byte is manufacturer specific
148	1	81	VIFE L1
149	1	xx	VIFE status
150–155	6	xxxxxxxxxxx	Apparent net energy, L1
156	1	8E	DIF size, 12 digit BCD
157	1	80	DIFE
158	1	80	DIFE
159	1	80	DIFE
160	1	40	DIFE, Unit 8
161	1	84	VIF for unit kVAh with resolution 0,01kVAh
162	1	FF	VIFE next byte is manufacturer specific
163	1	82	VIFE L2
164	1	xx	VIFE status
165–170	6	xxxxxxxxxxx	Apparent net energy, L2
171	1	8E	DIF size, 12 digit BCD
172	1	80	DIFE
173	1	80	DIFE
174	1	80	DIFE
175	1	40	DIFE, Unit 8

Byte No.	Size	Value	Description
176	1	84	VIF for unit kVAh with resolution 0,01kVAh
177	1	FF	VIFE next byte is manufacturer specific
178	1	83	VIFE L3
179	1	xx	VIFE status
180–185	6	xxxxxxxxxxx	Apparent net energy, L3
186	1	0F	DIF, no more telegrams will follow
187	1	xx	CS checksum, calculated from C field to last data
188	1	16	Stop character

10.3 Special Readout of Meter Data

Introduction

Some data in the meter can only be read by first sending a SND_UD followed by a REQ_UD2.



Note – An NKE should always be sent before sending any of the commands described below. If the meter is in the middle of another special data readout process it will not respond correctly to the command.

After reading the first telegram, it is possible to continue reading by sending repeated REQ_UD2 commands

If the data item that has been read is normal and without any specific status associated with it, then no status-VIFE or 0 will be sent out. If the status is “data error” or “no data available”, then the standard M-Bus status coding will be sent out (18 hex or 15 hex).

Readable data

The data that can be read in this way is:

- Logs

10.3.1 Readout of Event Log Data

Read request

Each one of the existing logs can be read by sending the following SND_UD to the meter followed by a REQ_UD2 (all values are hexadecimal).

Byte No.	Size	Value	Description
1	1	68	Start character
2	1	12	L-field, calculated from C field to last user data
3	1	12	L-field, repeated
4	1	68	Start character
5	1	53/73	C-field, SND_UD
6	1	xx	A-field, address
7	1	51	CI-field, data send, LSB first
8	1	8E or EC	DIF size, 6 byte BCD, storage number bit 0 is 0 or 1
9	1	8x or Cx	DIFE storage number bits 1–4, unit bit 6 is 0 or 1
10	1	8x	DIFE storage number bits 5–8
11	1	8x	DIFE storage number bits 9–12
12	1	0x	DIFE storage number bits 13–16
13	2	ED	VIF time/date
14	1	FF	VIF next byte is manufacturer specific
15	1	F9	VIF extension of manufacturer specific VIFE's, next VIFE specifies actual meaning.

Byte No.	Size	Value	Description
16	1	1A	VIFE Specification for different Logs: System Log = 0x2e Audit Log = 0x2f Net Quality Log = 0x30 Event Log = 0x32
17–22	6	xxxxxxxxxxx	Time/date (sec:min:hour / day-month-year)
23	1	xx	CS checksum, calculated from C field to last data
24	1	16	Stop character

Event Offset

The meter supports offset values 0 and -1 for reading the System, Event, Audit, Net Quality logs. If the offset mentioned is 0 then meter will read the log in the forward direction. If the offset value mentioned is -1 then it will read the data in the backward direction from the given date.

Data

The data will be sent out with 5 events in each telegram. If less than 5 events is stored in the meter for the specified date/time and offset then all data in the telegram after the last stored event will have status byte marked as "no data available" (15 hex).

The data sent out for each event is:

- Event type (1 byte binary coded).
- Date/time stamp for start of the event (6 byte bcd in order sec:min:hour/day:month:year)
- Duration of the event (in seconds)

10.3.1.1 Example of readout of log data

Readout of Net Quality Log with date and time specified as input

Send Nke.

10 40 fe 3e 16

Meter Responds with E5

E5

Read request net quality log with Offset -1.

68 12 12 68 73 fe 51 ce c0 80 80 00 ed ff f9 30 01 02 03 22 12 11 b0 16;Read net quality log with offset value -1. Date and Time specified as input, 22-12-2011 01:02:03

Meter Responds with E5.

E5.

Send Req UD2.

10 7B FE 79 16.

Meter responds with long frame data for net quality Log:

68 88 88 68 08 00 72 00 00 00 00 42 04 20 02 16 2a 00 00 ; Header Information

02 ff f9 b5 00 e1 07;Event Type net quality Log

0e ed b9 00 21 47 23 06 01 10 ;Date and Time 10.01.06 23:47:21

04 a0 00 dd 03 00 00 ;Duration

02 ff f9 b5 00 de 07 ;Event Type net quality Log

0e ed b9 00 21 47 23 06 01 10 ;Date and Time 10.02.06 23:47:21

04 a0 00 dd 03 00 00 ;Duration

02 ff f9 b5 00 f0 03 ;Event Type net quality Log

0e ed b9 00 11 47 23 06 01 10 ;Date and time 10.02.06 23:47:11

04 a0 00 e7 03 00 00 ;Duration

02 ff f9 b5 00 e8 03

0e ed b9 00 11 47 23 06 01 10

04 a0 00 e7 03 00 00

02 ff f9 b5 00 e2 07

0e ed b9 00 11 47 23 06 01 10

04 a0 e7 03 00 00

1f 70 16;1F indicates there are more frames to follow.

Readout of 4 telegrams of event log data with offset -1

System sends event log read request command (date/time 14/3-06 09:51:40), offset -1

68 12 12 68 73 FE 51 CE C0 80 80 00 ED FF F9 1A 40 51 09 14 03 06 06 16

Meter sends out acknowledge:

E5

System sends out request UD2:

10 7B FE 79 16

Meter sends out data telegram:

68 7E 7E 68 08 00 72 42 10 00 00 42 04 02 02 05 00 00 00 ;Data header

01 FF 6F 01 ;Total power outage

0E ED 39 24 19 09 14 03 06 ;Time/date 39:24:09 / 14-03-06 (sec:min:hour / day-month-year)

04 20 FE 00 00 00 ;Duration 254 seconds

01 FF 6F 01 ;Total power outage

0E ED 39 12 45 15 13 03 06 ;Time/date 12:45:15 / 13-03-06 (sec:min:hour / day-month-year)

04 20 5B 00 00 00 ; Duration 91 seconds

01 FF 6F 0F ;Abnormal negative power

0E ED 39 28 44 15 13 03 06 04 20 23 00 00 00

01 FF 6F 01 ;Total power outage

0E ED 39 44 38 15 13 03 06 04 20 52 01 00 00

01 FF 6F 0D ;Undervoltage on phase 3, level 2

0E ED 39 36 25 15 13 03 06 04 20 3E 00 00 00

1F ;Dif 1F -> More events exist

00 00 00 00 00 00 00 00 00 00 00 00 00 00 00 ;Pad bytes

0A 16 ;Checksum and stopbyte

10.4 Sending Data to the Meter

General

This section describes the telegrams that can be sent to an EQ meter. Some of the telegrams contain data, others do not. Data sent in the telegram is sometimes stored in the meter, sometimes used by the meter to perform a certain action. Telegrams that contains no data usually initiates a certain action in the meter.

Write access level protection

Some of the commands can be protected by a password. There are 3 different levels of write access level protection:

- Open
- Open by password
- Closed

The write access level can be set either via the buttons directly on the meter or via communication using the *set write access level* command.

If the access level is set to *Open*, then the meter will always accept the command as long as the meter is properly addressed and the syntax and checksum are correct.

If the access level is set to *Open by password*, then the specific command sent to the meter must be preceded by a *send password* command in order for the meter to accept the command.

If the access level is set to *Closed*, then the meter will not accept any command, but will just return an acknowledge character (E5 hex). To change this access level protection, the access level has to be set to *Open* via the buttons directly on the meter.



Note – Commands that are not affected by the write access level protection only require a correct message with correct address, syntax and checksum to be accepted.

10.4.1 Set tariff

For meters with tariff control the active tariff is set by sending the following command (all values are hexadecimal). The command is not affected by the write protection level set.

Byte No.	Size	Value	Description
1	1	68	Start character
2	1	07	L-field, calculated from C field to last user data
3	1	07	L-field, repeated
4	1	68	Start character
5	1	53/73	C-field, SND_UD
6	1	xx	A-field, address
7	1	51	CI-field, data send, LSB first
8	1	01	DIF size, 8 bit integer

Byte No.	Size	Value	Description
9	1	FF	VIF next byte is manufacturer specific
10	1	13	VIFE tariff
11	1	xx	New tariff
12	1	xx	CS checksum, calculated from C field to last data
13	1	16	Stop character

10.4.2 Set primary address

The primary address is set by sending the following command (all values are hexadecimal). The command is not affected by the write protection level set.

Byte No.	Size	Value	Description
1	1	68	Start character
2	1	06	L-field, calculated from C field to last user data
3	1	06	L-field, repeated
4	1	68	Start character
5	1	53/73	C-field, SND_UD
6	1	xx	A-field, address
7	1	51	CI-field, data send, LSB first
8	1	01	DIF size, 8 bit integer
9	1	7A	VIFE Bus Address
10	1	xx	New primary address
11	1	xx	CS checksum, calculated from C field to last data
12	1	16	Stop character

10.4.3 Change baud rate

The baud rate of the electrical M-Bus interface is set by sending the following command (all values are hexadecimal). The command is not affected by the write protection level set.

Byte No.	Size	Value	Description
1	1	68	Start character
2	1	03	L-field, calculated from C field to last user data
3	1	03	L-field, repeated
4	1	68	Start character
5	1	53/73	C-field, SND_UD
6	1	xx	A-field, address
7	1	Bx	CI-field, New baud rate (where x=>8..F)
8	1	xx	CS checksum, calculated from C field to last data
9	1	16	Stop character

10.4.4 Reset power fail counter

The power fail counter is reset to 0 by sending the following command (all values are hexadecimal). The command is not affected by the write protection level set.

Byte No.	Size	Value	Description
1	1	68	Start character
2	1	07	L-field, calculated from C field to last user data
3	1	07	L-field, repeated
4	1	68	Start character
5	1	53/73	C-field, SND_UD
6	1	xx	A-field, address
7	1	51	CI-field, data send, LSB first
8	1	00	DIF size, no data
9	1	FF	VIF next byte is manufacturer specific
10	1	98	VIFE no. of power fails
11	1	07	VIFE clear
12	1	xx	CS checksum, calculated from C field to last data
13	1	16	Stop character

10.4.5 Set Current transformer (CT) ratio - numerator

The current transformer ratio (CT) numerator is set by sending the following command (all values are hexadecimal). The command is affected by the write protection level set.

Byte No.	Size	Value	Description
1	1	68	Start character
2	1	0a	L-field, calculated from C field to last user data
3	1	0a	L-field, repeated
4	1	68	Start character
5	1	53/73	C-field, SND_UD
6	1	xx	A-field, address
7	1	51	CI-field, data send, LSB first
8	1	04	DIF size, 32 bit integer
9	1	FF	VIF next byte is manufacturer specific
10	1	20	VIFE CT ratio numerator
11–14	4	xxxxxxx	New CT ratio numerator
15	1	xx	CS checksum, calculated from C field to last data
16	1	16	Stop character

10.4.6 Set current transformer (CT) ratio - denominator

The current transformer ratio (CT) denominator is set by sending the following command (all values are hexadecimal). The command is affected by the write protection level set.

Byte No.	Size	Value	Description
1	1	68	Start character
2	1	0a	L-field, calculated from C field to last user data
3	1	0a	L-field, repeated
4	1	68	Start character
5	1	53/73	C-field, SND_UD
6	1	xx	A-field, address
7	1	51	CI-field, data send, LSB first
8	1	04	DIF size, 32 bit integer
9	1	FF	VIF next byte is manufacturer specific
10	1	22	VIFE CT ratio denominator
11–14	4	xxxxxxx	New CT ratio denominator
15	1	xx	CS checksum, calculated from C field to last data
16	1	16	Stop character

10.4.7 Select status information

To change the way the status information is sent out the following command is sent (all values are hexadecimal). The command is not affected by the write protection level set.

Byte No.	Size	Value	Description
1	1	68	Start character
2	1	07	L-field, calculated from C field to last user data
3	1	07	L-field, repeated
4	1	68	Start character
5	1	53/73	C-field, SND_UD
6	1	xx	A-field, address
7	1	51	CI-field, data send, LSB first
8	1	01	DIF size, 8 bit integer
9	1	FF	VIF next byte is manufacturer specific
10	1	15	VIFE status of values (status byte on the values)
11	1	xx	0=never, 1=status if not OK=always
12	1	xx	CS checksum, calculated from C field to last data
13	1	16	Stop character

10.4.8 Reset of stored state for input 3

Reset of stored state for input 3 is performed by sending the following command (all values are hexadecimal). The command is not affected by the write protection level set.

Byte No.	Size	Value	Description
1	1	68	Start character
2	1	09	L-field, calculated from C field to last user data
3	1	09	L-field, repeated
4	1	68	Start character
5	1	53/73	C-field, SND_UD
6	1	xx	A-field, address
7	1	51	CI-field, data send, LSB first
8	1	C0	DIF size, no data, storage number 1
9	1	C0	DIFE unit=1
10	1	40	DIFE unit=2
11	1	FD	VIF extension of VIF codes
12	1	9B	VIFE digital input
13	1	07	VIFE clear
14	1	xx	CS checksum, calculated from C field to last data
15	1	16	Stop character

10.4.9 Reset of stored state for input 4

Reset of stored state for input 4 is performed by sending the following command (all values are hexadecimal). The command is not affected by the write protection level set.

Byte No.	Size	Value	Description
1	1	68	Start character
2	1	0A	L-field, calculated from C field to last user data
3	1	0A	L-field, repeated
4	1	68	Start character
5	1	53/73	C-field, SND_UD
6	1	xx	A-field, address
7	1	51	CI-field, data send, LSB first
8	1	C0	DIF size, no data, storage number 1
9	1	80	DIFE unit=0
10	1	80	DIFE unit=0
11	1	40	DIFE unit=4
12	1	FD	VIF extension of VIF codes
13	1	9B	VIFE digital input
14	1	07	VIFE clear
15	1	xx	CS checksum, calculated from C field to last data
16	1	16	Stop character

10.4.10 Reset of input counter 3

Reset of input counter 3 is performed by sending the following command (all values are hexadecimal). The command is not affected by the write protection level set.

Byte No.	Size	Value	Description
1	1	68	Start character
2	1	09	L-field, calculated from C field to last user data
3	1	09	L-field, repeated
4	1	68	Start character
5	1	53/73	C-field, SND_UD
6	1	xx	A-field, address
7	1	51	CI-field, data send, LSB first
8	1	80	DIF size, no data
9	1	C0	DIFE unit=1
10	1	40	DIFE unit=2
11	1	FD	VIF extension of VIF codes
12	1	E1	VIFE cumulating counters
13	1	07	VIFE clear
14	1	xx	CS checksum, calculated from C field to last data
15	1	16	Stop character

10.4.11 Reset of input counter 4

Reset of input counter 4 is performed by sending the following command (all values are hexadecimal). The command is not affected by the write protection level set.

Byte No.	Size	Value	Description
1	1	68	Start character
2	1	0A	L-field, calculated from C field to last user data
3	1	0A	L-field, repeated
4	1	68	Start character
5	1	53/73	C-field, SND_UD
6	1	xx	A-field, address
7	1	51	CI-field, data send, LSB first
8	1	80	DIF size, no data
9	1	80	DIFE unit=0
10	1	80	DIFE unit=0
11	1	40	DIFE unit=4
12	1	FD	VIF extension of VIF codes
13	1	E1	VIFE cumulating counters
14	1	07	VIFE clear
15	1	xx	CS checksum, calculated from C field to last data
16	1	16	Stop character

10.4.12 Set output 1

Setting the state of output 1 is performed by sending the following command (all values are hexadecimal). The command is not affected by the write protection level set.

Byte No.	Size	Value	Description
1	1	68	Start character
2	1	08	L-field, calculated from C field to last user data
3	1	08	L-field, repeated
4	1	68	Start character
5	1	53/73	C-field, SND_UD
6	1	xx	A-field, address
7	1	51	CI-field, data send, LSB first
8	1	81	DIF size, 8 bit integer
9	1	40	DIFE unit=1
10	1	FD	VIF extension of VIF codes
11	1	1A	VIFE digital output
12	1	xx	output 1, new state
13	1	xx	CS checksum, calculated from C field to last data
14	1	16	Stop character

10.4.13 Set output 2

Setting the state of output 2 is performed by sending the following command (all values are hexadecimal). The command is not affected by the write protection level set.

Byte No.	Size	Value	Description
1	1	68	Start character
2	1	09	L-field, calculated from C field to last user data
3	1	09	L-field, repeated
4	1	68	Start character
5	1	53/73	C-field, SND_UD
6	1	xx	A-field, address
7	1	51	CI-field, data send, LSB first
8	1	81	DIF size, 8 bit integer
9	1	80	DIFE unit=0
10	1	40	DIFE unit=2
11	1	FD	VIF extension of VIF codes
12	1	1A	VIFE digital output
13	1	xx	output 2, new state
14	1	xx	CS checksum, calculated from C field to last data
15	1	16	Stop character

10.4.14 Send password

Password is sent with the following command (all values are hexadecimal).

Byte No.	Size	Value	Description
1	1	68	Start character
2	1	0E	L-field, calculated from C field to last user data
3	1	0E	L-field, repeated
4	1	68	Start character
5	1	53/73	C-field, SND_UD
6	1	Xx	A-field, address
7	1	51	CI-field, data send, LSB first
8	1	07	DIF size, 8 byte integer
9	1	FD	VIF extension of VIF codes
10	1	16	VIFE password
11–18	8	xxxxxxxxxxxxxxxx	Password
19	1	xx	CS checksum, calculated from C field to last data
20	1	16	Stop character

10.4.15 Set password

Password is set by sending the following command (all values are hexadecimal).



Note – If the meter is password protected the old password must be sent before a new can be set.

Byte No.	Size	Value	Description
1	1	68	Start character
2	1	0F	L-field, calculated from C field to last user data
3	1	0F	L-field, repeated
4	1	68	Start character
5	1	53/73	C-field, SND_UD
6	1	xx	A-field, address
7	1	51	CI-field, data send, LSB first
8	1	07	DIF size, 8 byte integer
9	1	FD	VIF extension of VIF codes
10	1	96	VIFE password
11	1	00	VIFE write (replace)
12–19	8	xxxxxxxxxxxxxxxx	Password
20	1	xx	CS checksum, calculated from C field to last data
21	1	16	Stop character

10.4.16 Reset logs

All data for logs is cleared by sending the following command (all values are hexadecimal). The command is affected by the write protection level set.

Byte No.	Size	Value	Description
1	1	68	Start character
2	1	08	L-field, calculated from C field to last user data
3	1	08	L-field, repeated
4	1	68	Start character
5	1	53/73	C-field, SND_UD
6	1	xx	A-field, address
7	1	51	CI-field, data send, LSB first
8	1	00	DIF size, no data
9	1	FF	VIF next byte is manufacturer specific
10	1	F9	VIF extension of manufacturer specific VIFE's, next VIFE specifies actual meaning
11	1	xx	VIFE specifies data to be cleared: <ul style="list-style-type: none"> • 85: Event log • AE: System log • B0: Net quality log
12	1	07	VIFE clear
13	1	xx	CS checksum, calculated from C field to last data
14	1	16	Stop character

10.4.17 Reset resettable active energy import

Reset of resettable active energy import is performed by sending the following command (all values are hexadecimal). The command is affected by the write protection level set.

Byte No.	Size	Value	Description
1	1	68	Start character
2	1	08	L-field, calculated from C field to last user data
3	1	08	L-field, repeated
4	1	68	Start character
5	1	53/73	C-field, SND_UD
6	1	xx	A-field, address
7	1	51	CI-field, data send, LSB first
8	1	00	DIF size, no data
9	1	84	VIFE specifying energy
10	1	FF	VIFE next byte is manufacturer specific
11	1	F2	Resettable registers
12	1	07	VIFE clear
13	1	xx	CS checksum, calculated from C field to last data
14	1	16	Stop character

10.4.18 Reset resettable active energy export

Reset of resettable active energy export is performed by sending the following command (all values are hexadecimal). The command is affected by the write protection level set.

Byte No.	Size	Value	Description
1	1	68	Start character
2	1	09	L-field, calculated from C field to last user data
3	1	09	L-field, repeated
4	1	68	Start character
5	1	53/73	C-field, SND_UD
6	1	xx	A-field, address
7	1	51	CI-field, data send, LSB first
8	1	80	DIF size, no data
9	1	40	DIFE, unit=1
10	1	84	VIFE specifying energy
11	1	FF	VIFE next byte is manufacturer specific
12	1	F2	Resettable registers
13	1	07	VIFE clear
14	1	xx	CS checksum, calculated from C field to last data
15	1	16	Stop character

10.4.19 Reset resettable reactive energy import

Reset of resettable active energy export is performed by sending the following command (all values are hexadecimal). The command is affected by the write protection level set.

Byte No.	Size	Value	Description
1	1	68	Start character
2	1	08	L-field, calculated from C field to last user data
3	1	08	L-field, repeated
4	1	68	Start character
5	1	53/73	C-field, SND_UD
6	1	xx	A-field, address
7	1	51	CI-field, data send, LSB first
8	1	80	DIF size, no data
9	1	80	DIFE, unit=0
10	1	40	DIFE unit=2
11	1	84	VIFE specifying energy
12	1	FF	VIFE next byte is manufacturer specific
13	1	F2	Resettable registers
14	1	07	VIFE clear
15	1	xx	CS checksum, calculated from C field to last data
16	1	16	Stop character

10.4.20 Reset resettable reactive energy export

Reset of resettable active energy export is performed by sending the following command (all values are hexadecimal). The command is affected by the write protection level set.

Byte No.	Size	Value	Description
1	1	68	Start character
2	1	0A	L-field, calculated from C field to last user data
3	1	0A	L-field, repeated
4	1	68	Start character
5	1	53/73	C-field, SND_UD
6	1	xx	A-field, address
7	1	51	CI-field, data send, LSB first
8	1	80	DIF size, no data
9	1	C0	DIFE, unit=1
10	1	40	DIFE unit=3
11	1	84	VIFE specifying energy
12	1	FF	VIFE next byte is manufacturer specific
13	1	F2	Resettable registers
14	1	07	VIFE clear
15	1	xx	CS checksum, calculated from C field to last data
16	1	16	Stop character

10.4.21 Set write access level

The write access level is set by sending the following command (all values are hexadecimal). The command is affected by the write protection level set.

Byte No.	Size	Value	Description
1	1	68	Start character
2	1	07	L-field, calculated from C field to last user data
3	1	07	L-field, repeated
4	1	68	Start character
5	1	53/73	C-field, SND_UD
6	1	xx	A-field, address
7	1	51	CI-field, data send, LSB first
8	1	01	DIF size, 8 bit integer
9	1	FF	VIF next byte is manufacturer specific
10	1	6A	VIFE write control
11	1	xx	Write control (1: Closed, 2: Open by password, 3: Open)
12	1	xx	CS checksum, calculated from C field to last data
13	1	16	Stop character

10.4.22 Set tariff source

Tariffs can be controlled by inputs or communication.

The tariff source is set by sending the following command (all values are hexadecimal). The command is affected by the write protection level set.

Byte No.	Size	Value	Description
1	1	68	Start character
2	1	08	L-field, calculated from C field to last user data
3	1	08	L-field, repeated
4	1	68	Start character
5	1	53/73	C-field, SND_UD
6	1	xx	A-field, address
7	1	51	CI-field, data send, LSB first
8	1	01	DIF size, 8 bit integer
9	1	FF	VIF next byte is manufacturer specific
10	1	F9	VIF extension of manufacturer specific VIFE's, next VIFE specifies actual meaning
11	1	06	VIFE tariff source
12	1	xx	Tariff source (0: Internal clock, 1: Communication command, 2: Inputs)
13	1	xx	CS checksum, calculated from C field to last data
14		16	Stop character

10.4.23 Set CO2 conversion factor

The co2 conversion factor is set by sending the following command (all values are hexadecimal). The command is not affected by the write protection level set.

Byte No.	Size	Value	Description
1	1	68	Start character
2	1	0A	L-field, calculated from C field to last user data
3	1	0A	L-field, repeated
4	1	68	Start character
5	1	53/73	C-field, SND_UD
6	1	xx	A-field, address
7	1	51	CI-field, data send, LSB first
8	1	04	DIF size, 32 bit integer
9	1	FF	VIF next byte is manufacturer specific
10	1	24	VIFE CO2 conversion factor in g/kWh
11–14	4	xxxxxxx	CO2 conversion factor
15	1	xx	CS checksum, calculated from C field to last data
16	1	16	Stop character

10.4.24 Set currency conversion factor

The currency conversion factor is set by sending the following command (all values are hexadecimal). The command is not affected by the write protection level set.

Byte No.	Size	Value	Description
1	1	68	Start character
2	1	0A	L-field, calculated from C field to last user data
3	1	0A	L-field, repeated
4	1	68	Start character
5	1	53/73	C-field, SND_UD
6	1	xx	A-field, address
7	1	51	CI-field, data send, LSB first
8	1	04	DIF size, 32 bit integer
9	1	FF	VIF next byte is manufacturer specific
10	1	25	VIFE currency conversion factor
11–14	4	xxxxxxx	Currency conversion factor in currency/kWh with 3 decimals
15	1	xx	CS checksum, calculated from C field to last data
16	1	16	Stop character
