

ACH550

Installation Supplement ACH550-01+B055+F278 Drives



English	3
Dansk	5
Deutsch	7
Español	9
Français	11
Italiano	13
Nederlands	15
Português	17
Русский	19
Suomi	21
Svenska	23
Türkçe	25

ACH550 Drive manuals

GENERAL MANUALS

ACH550-01 User's Manual

3AFE68258537 (English)

ACH550-02 User's Manual

3AFE68262674 (English)

ACH550-UH User's Manual

3AUA0000004092 (English)

- Safety
- Installation
- Start-up
- Diagnostics
- Maintenance
- Technical data

HVAC Info Guide CD

3AFE68338743 (English)

- Detailed product description
 - Technical product description including dimensional drawings
 - Cabinet mounting information including power losses
 - Software and control
 - User interfaces and control connections
 - Complete options descriptions
 - Spare parts
 - Etc.
- Practical engineering guides
 - PID & PFA engineering guides
 - Dimensioning and sizing guidelines
 - Diagnostics and maintenance information
 - Etc.

OPTION MANUALS

(delivered with optional equipment)

BACnet Protocol

3AUA0000004591 (English)

Embedded Fieldbus (EFB) Control

3AFE68320658 (English)

MFDT-01 FlashDrop User's Manual

3AFE68591074 (English)

OREL-01 Relay Output Extension Module User's Manual

3AUA0000001935 (English)

RETA-01 Ethernet Adapter Module User's Manual

3AFE64539736 (English)

RLON-01 LonWorks Adapter Module User's Manual

3AFE64798693 (English)

ACH550-01+B055+F278 Installation Supplement

3AUA00000040634 (English)

Typical contents

- Safety
- Installation
- Programming/Start-up
- Fault tracing
- Technical data

MAINTENANCE MANUALS

Guide for Capacitor Reforming in ACS50, ACS55, ACS150, ACS350, ACS550 and ACH550

3AFE68735190 (English)

Operation principle and power cable installation

Applicability

This is a supplement to the *ACH550-01 User's Manual* [3AFE68258537 (English)]. The supplement applies to units with main switch option +F278. The main switch is available for drive types up to ACH550-01-045A-4 (power 22 kW) ie, frame sizes R1 to R3 with degree of protection of IP54. The supplement instructs how to install the input and motor cables.

The main switch option is not UL listed.

Safety

Follow the safety instructions given in the *ACH550-01 User's Manual* [3AFE68258537 (English)].



Warning! Before removing the front cover and working on the drive, isolate the input cables from the main supply at the distribution board or by opening the disconnecter of the supply transformer. The main switch (option +F278) does not isolate the input cables and terminals from the main AC supply.

Operation principle

The main switch is used for switching off the input power of the drive. In addition to the main contacts, the switch has one normally closed auxiliary contact that indicates the state of the switch.

The main circuit of the drive is shown below.

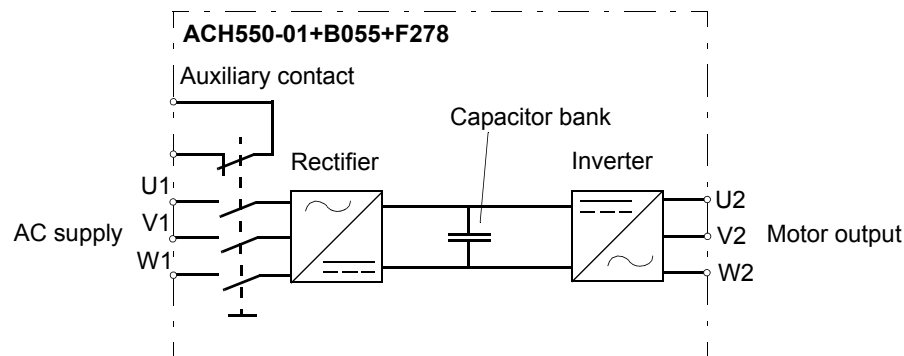

Dimensions

The handle of the main switch extends the depth of the drive 50 mm (1.97 in.).

Power cable installation procedure

1. Remove the front cover as shown in the user's manual.
2. Undo the two fastening screws of the switch assembly plate.
3. Turn the switch assembly plate aside.
4. Remove the rubber grommets and cut adequate holes into them. Slide the grommets onto the power cables the conical part downwards. Seal the lead-through plate holes with the grommets.
5. Strip off the outer sheathing of the cables under the 360 degrees grounding clamps and fasten the clamps onto the stripped parts of the cables.
6. Twist the shields of the cables into pigtails and connect the pig tails under the grounding screws with cable lugs. Keep the pigtails short to minimize electromagnetic emission.
7. Connect the motor cable conductors to the U2, V2 and W2 terminals.
8. Turn the switch assembly plate back to its original position and fasten the two fastening screws.
9. Connect the input cable conductors to the main switch terminals U1, V1 and W1.
10. Connect wires to the auxiliary contact (if used).
11. Connect the control cables as shown in the user's manual.
12. Replace the front cover.

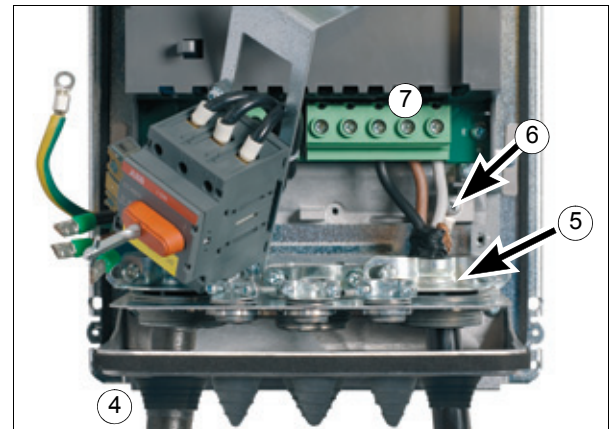
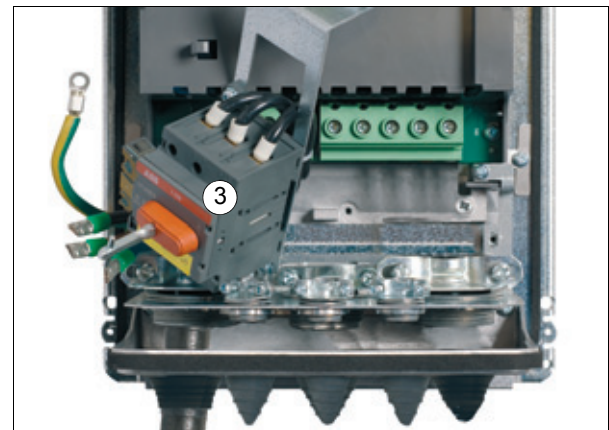
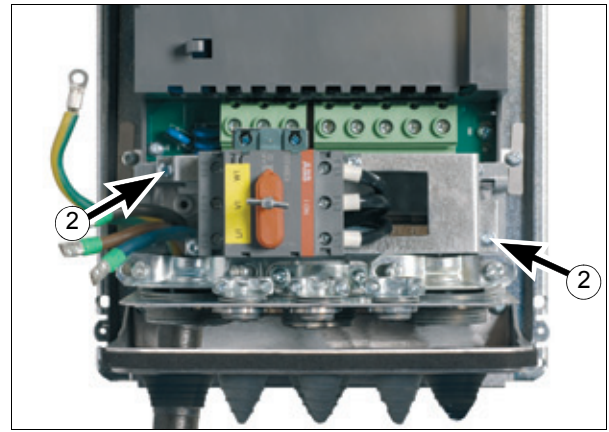

Frame size	Tightening torque			
	U1, V1, W1	U2, V2, W2	Grounding PE	
	N·m (lbf·ft)	N·m (lbf·ft)	N·m	lbf·ft
R1	0.8 (0.6)	1.4 (1.0)	1.4	1.0
R2	0.8 (0.6)	1.4 (1.0)	1.4	1.0
R3	2 (1.5)	1.8 (1.3)	1.8	1.3

Auxiliary contact: 0.8 N·m (0.6 lbf·ft)

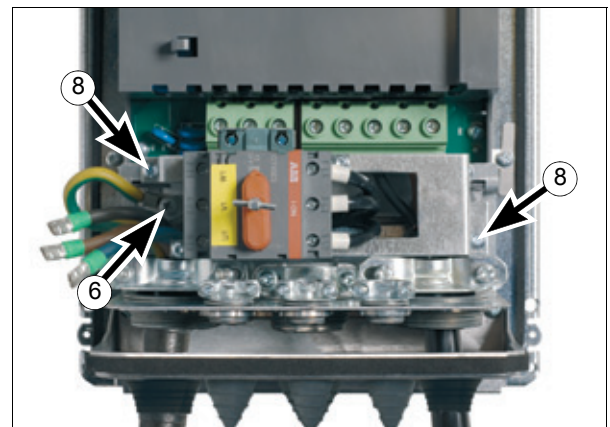
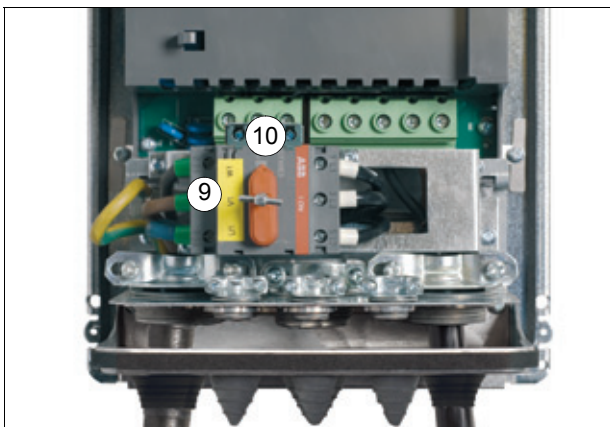

Betjeningsprincip og installation af strømkabel

Anvendelighed

Dette er et supplement til *ACH550-01 User's Manual* [3AFE68258537 (Engelsk)]. Supplementet gælder for enheder med hovedafbryderoption +F278. Hovedafbryderen er tilgængelig til drevtyper op til ACH550-01-045A-4 (netspænding 22 kW), dvs. modulstørrelserne R1 til R3 med en beskyttelsesgrad på IP54. Supplementet beskriver, hvordan indgangskablet og motorkablet installeres.

Hovedafbryderoptionen er ikke UL-godkendt.

Sikkerhed

Følg sikkerhedsinstruktionerne i *ACH550-01 User's Manual* [3AFE68258537 (Engelsk)].



Advarsel! Inden du fjerner frontdækslet og arbejder på drevet, skal du isolere indgangskablerne fra netforsyningen på fordelingstavlen eller ved at åbne forsyningstransformerens adskiller. Hovedafbryderen (option +F278) isolerer ikke indgangskablerne og terminalerne fra netforsyningen.

Betjeningsprincip

Hovedafbryderen bruges til at afbryde netforsyningen til drevet. Ud over hovedkontaktsættet har afbryderen en hjælpekontakt, som normalt er lukket og viser afbryderens status.

Drevets hovedstrømkreds viser herunder.

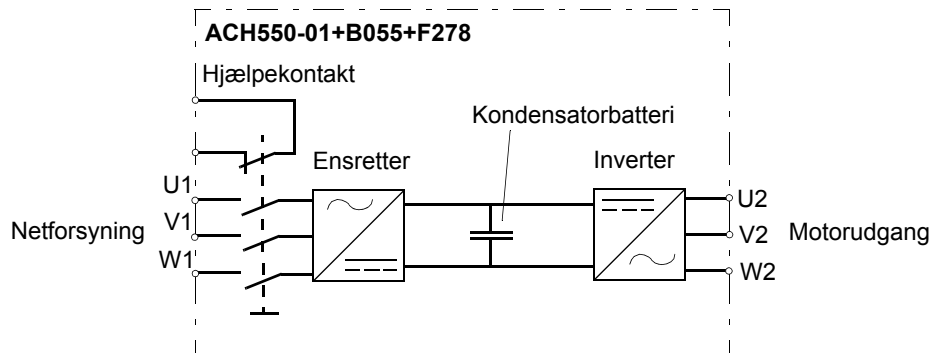

Dimensioner

Håndtaget på hovedafbryderen øger drevets dybde til 50 mm (1,97 tommer).

Installation af netkabel

1. Fjern frontdækslet som vist i brugermanualen.
2. Løsn de to spændeskruer på afbrydertilslutningspladen.
3. Skub afbrydertilslutningspladen til side.
4. Fjern gummimufferne, og skær tilstrækkeligt store huller i dem. Træk mufferne over netkablerne med den kegleformede del nedad. Forsegl gennemføringspladens huller med mufferne.
5. Afisolér kablernes udvendige beklædning under klemmerne til 360 graders jording, og fastgør klemmerne til den afisolerede del af kablerne.
6. Sno kablernes afskærmning, og tilslut snoningerne under jordings-skrueerne med kabelsko. Den sammensnoede skærm skal være så kort som muligt for at minimere den elektromagnetiske stråling.
7. Forbind motorkabellederne til U2-, V2- og W2-klemmerne.
8. Drej afbrydertilslutningspladen tilbage til dens oprindelige placering, og stram de to spændeskruer.
9. Tilslut indgangskabellederne til hovedafbryderklemmerne U1, V1 og W1.
10. Tilslut lederne til hjælpekontakten (hvis den bruges).
11. Tilslut styrekablerne som vist i brugermanualen.
12. Sæt frontdækslet på igen.

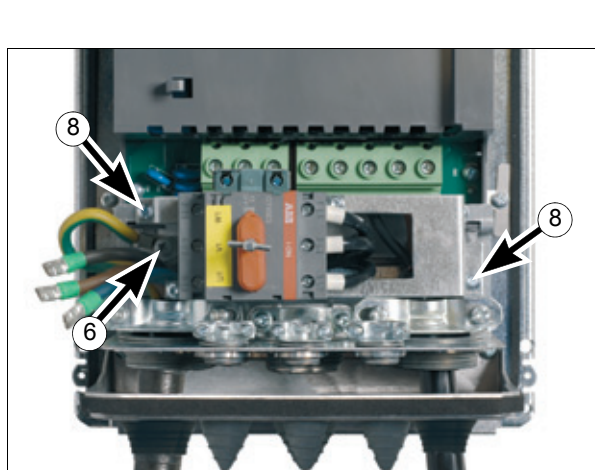
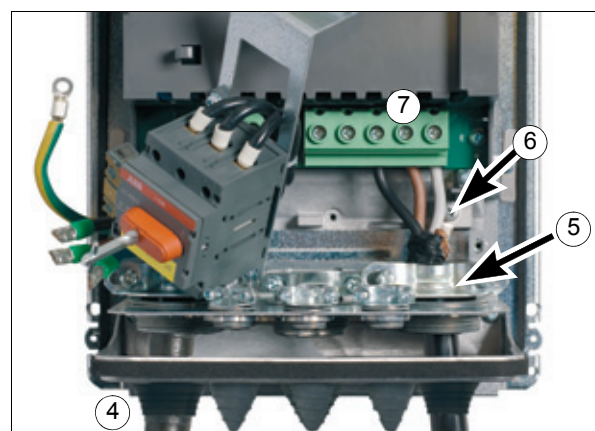
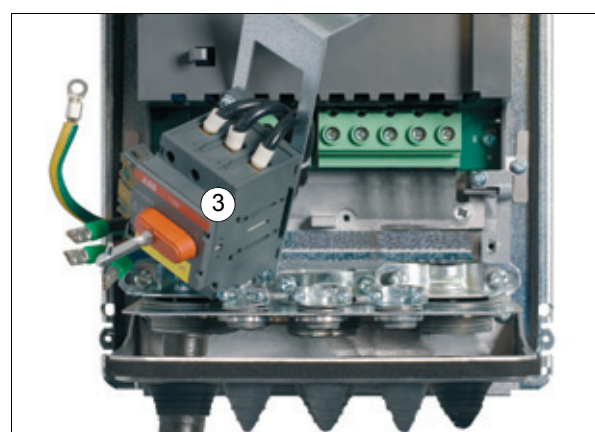
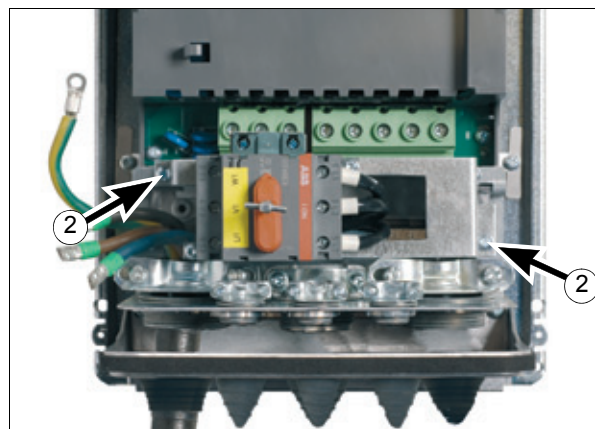

Modul-størrelse	Tilspændingsmoment			
	U1, V1, W1	U2, V2, W2	Jordings-PE	
	N·m (lbf·ft)	N·m (lbf·ft)	N·m	lbf·ft
R1	0.8 (0.6)	1.4 (1.0)	1.4	1.0
R2	0.8 (0.6)	1.4 (1.0)	1.4	1.0
R3	2 (1.5)	1.8 (1.3)	1.8	1.3

Hjælpekontakt: 0,8 N·m (0,6 lbf·ft)

Funktionsprinzip und Installation der Leistungskabel

Anwendungsbereich

Dies ist eine Ergänzung zum *ACH550-01 Benutzerhandbuch* [3AFE68265525]. Diese Ergänzung gilt für Frequenzumrichter mit der Hauptschalter-Option +F278. Der Hauptschalter ist für die Frequenzumrichtertypen bis ACH550-01-045A-4 (Leistung 22 kW), Baugrößen R1 bis R3 mit Schutzart IP54 verfügbar. Die Ergänzung enthält die Anweisungen zur Installation der Netz- und Motorkabel.

Die Hauptschalter-Option ist nicht UL-gelistet.

Sicherheit

Befolgen Sie die Sicherheitsvorschriften im *ACH550-01 Benutzerhandbuch* [3AFE68265525].



Warnung! Vor Abnehmen der vorderen Abdeckung und der Ausführung von Arbeiten am Frequenzumrichter, ist das Netzkabel am Versorgungstrafo abzuklemmen, oder der Hauptschalter zu öffnen. Der Hauptschalter (Option +F278) trennt das Netzkabel und die -klemmen nicht von der Netzspannungsversorgung.

Funktionsprinzip

Der Hauptschalter wird für das Abschalten der Einspeisespannung des Frequenzumrichters benutzt. Zusätzlich zu den Hauptkontakten, hat der Schalter einen Hilfskontakt vom Typ Öffner (NC), der den Status des Schalters anzeigt.

In der folgenden Abbildung wird der Hauptstromkreis des Frequenzumrichters dargestellt.

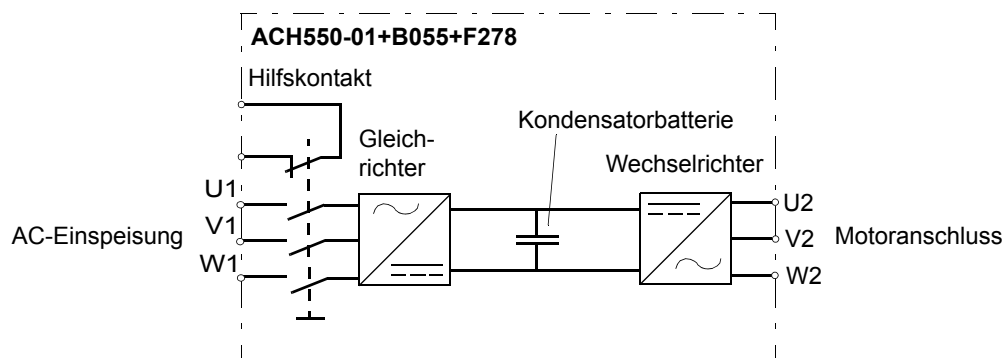

Abmessungen

Der Schaltgriff erhöht die Einbautiefe um 50 mm (1.97 in.).

Vorgehensweise bei der Installation der Leistungskabel

1. Die Gehäuseabdeckung wie in der Betriebsanleitung gezeigt und beschrieben abnehmen.
2. Die zwei Befestigungsschrauben der Schalter-Montageplatte lösen und herausdrehen.
3. Die Schalter-Montageplatte zur Seite schwenken.
4. Die Gummidichtungen herausnehmen und so weit wie nötig abschneiden. Die Dichtungen mit dem konischen Teil nach unten auf die Leistungskabel schieben. Die Öffnungen im Kabelanschlussblech mit den Dichtungen verschließen.
5. Den äußeren Kabelmantel unter den 360-Grad-Erdungsklemmen entfernen und die Klemmen über den abisolierten Teilen der Kabel befestigen.
6. Die Kabelschirmenden verdrillen und mit Kabelschuhen an die Erdungsschrauben anschließen. Die verdrillten Leiterenden so kurz wie möglich halten, um elektromagnetische Emissionen zu minimieren.
7. Die Leiter der Motorkabel an die Klemmen U2, V2 und W2 anschließen.
8. Die Schalter-Montageplatte zurückschwenken in die ursprüngliche Position und mit den zwei Befestigungsschrauben wieder befestigen.
9. Die Leiter des Netzkabels an die Klemmen U1, V1 und W1 des Hauptschalters anschließen.
10. Die Leiter des Hilfskontakts (falls benutzt) anschließen.
11. Die Steuerkabel wie in der Betriebsanleitung dargestellt anschließen.
12. Die Gehäuseabdeckung wieder montieren.

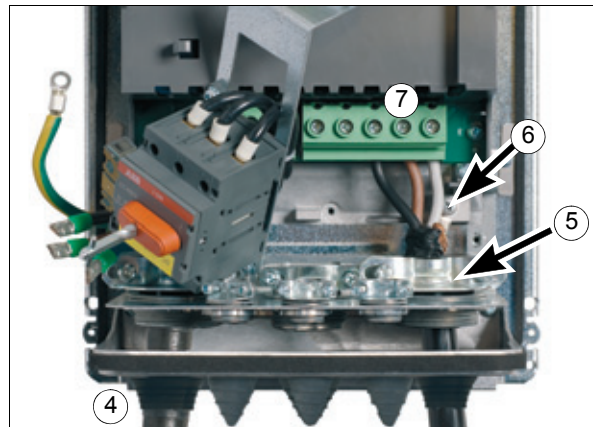
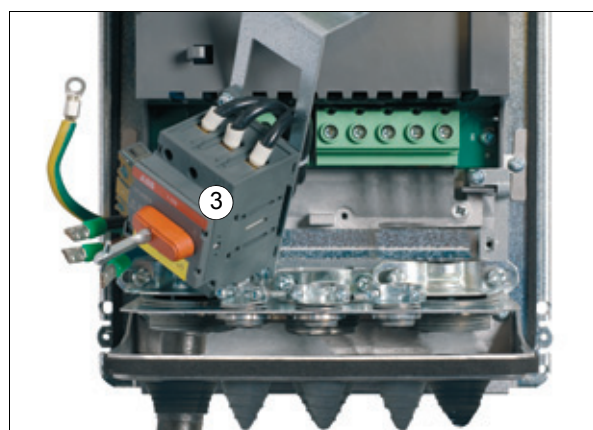
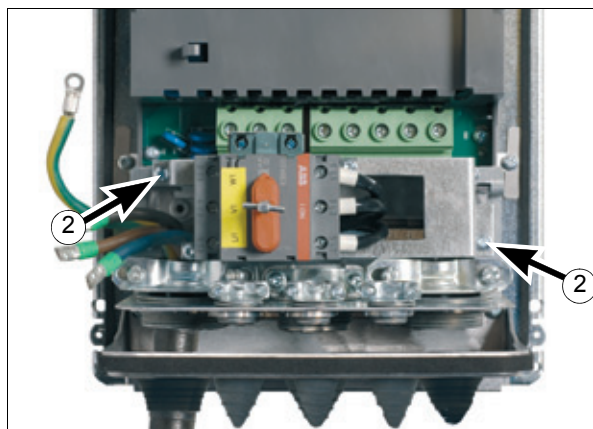

Bau- größe	Anzugsmomente			
	U1, V1, W1	U2, V2, W2	Erdung PE	
	Nm (lbf-ft)	Nm (lbf-ft)	Nm	lbf-ft
R1	0,8 (0,6)	1,4 (1,0)	1,4	1,0
R2	0,8 (0,6)	1,4 (1,0)	1,4	1,0
R3	2 (1,5)	1,8 (1,3)	1,8	1,3
Hilfskontakt: 0,8 Nm (0,6 lbf-ft)				

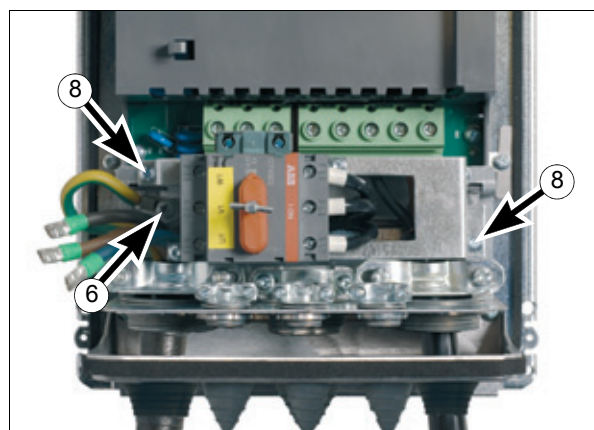
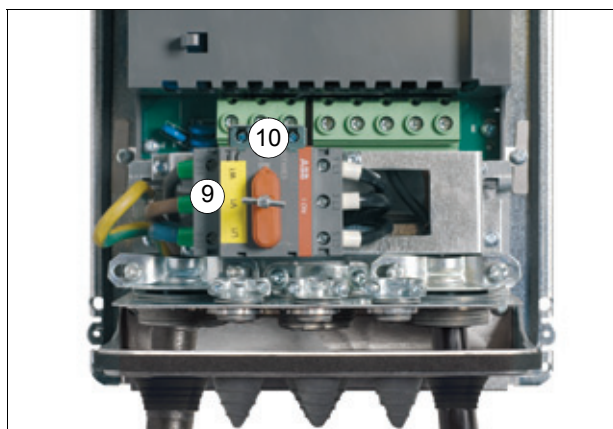

Principio de funcionamiento e instalación del cable de alimentación

Aplicabilidad

Este es un suplemento para el *Manual de usuario del ACH550-01* [3AUA0000040634 (Español)]. El suplemento se aplica a las unidades con la opción de interruptor principal +F278. El interruptor principal está disponible para los convertidores que lleguen hasta el modelo ACH550-01-045A-4 (potencia 22 kW), es decir, con bastidores de tamaño R1 a R3 y grado de protección IP54. El suplemento describe cómo instalar los cables de entrada y de motor.

La opción de interruptor principal no está listada en la normativa UL.

Seguridad

Siga las instrucciones de seguridad del *Manual de usuario del ACH550-01* [3AUA0000040634 (Español)].



¡Advertencia! Antes de retirar la cubierta frontal para trabajar en el convertidor, aisle los cables de entrada de la alimentación principal en el cuadro de distribución o abra el disyuntor del transformador de alimentación. El interruptor principal (opción +F278) no aísla los cables de entrada ni los terminales de la alimentación de CA principal.

Principio de funcionamiento

El interruptor principal se utiliza para desactivar la alimentación de entrada del convertidor. Además de los contactos principales, el interruptor tiene un contacto auxiliar normalmente cerrado que indica el estado del interruptor.

El circuito principal del convertidor se muestra a continuación.

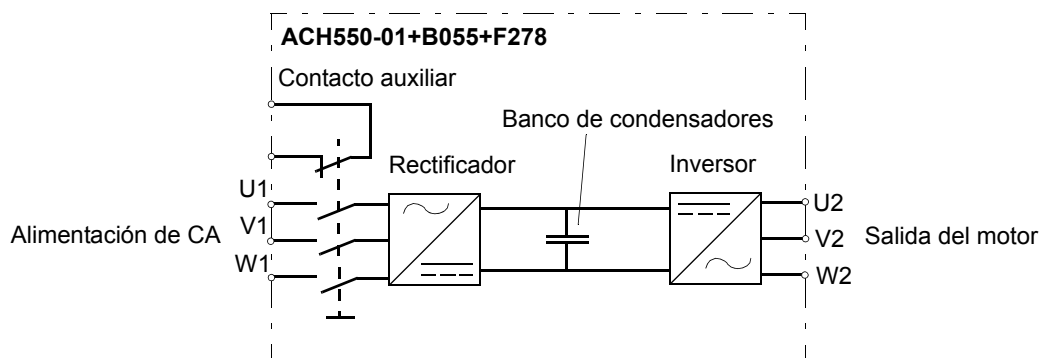

Dimensiones

El mando del interruptor principal aumenta en 50 mm (1,97 in) la profundidad del convertidor.

Procedimiento de instalación del cable de alimentación

1. Retire la cubierta frontal como se indica en manual del usuario.
2. Retire los dos tornillos de fijación de la placa de montaje del interruptor.
3. Ponga a un lado la placa de montaje del interruptor.
4. Retire las arandelas de goma y practique en ellas los orificios necesarios. Deslice las arandelas por los cables de alimentación con la parte cónica hacia abajo. Selle los orificios pasantes de la placa con las arandelas.
5. Pele el revestimiento superficial de los cables que se encuentran bajo las pinzas de conexión a tierra de 360 grados y fije las pinzas en las zonas peladas de los cables.
6. Trencen las pantallas de los cables y conecte las espirales creadas bajo los tornillos de conexión a tierra con las orejetas de los cables. Las espirales deben ser cortas para minimizar la emisión electromagnética.
7. Conecte los conductores del cable de motor a los terminales U2, V2 y W2.
8. Coloque la placa de montaje del interruptor en su posición inicial y apriete los tornillos de fijación.
9. Conecte los conductores del cable de entrada a los terminales U1, V1 y W1 del interruptor principal.
10. Conecte los cables al contacto auxiliar (si va a utilizarse).
11. Conecte los cables de control como se indica en manual de usuario.
12. Vuelva a colocar la cubierta frontal.

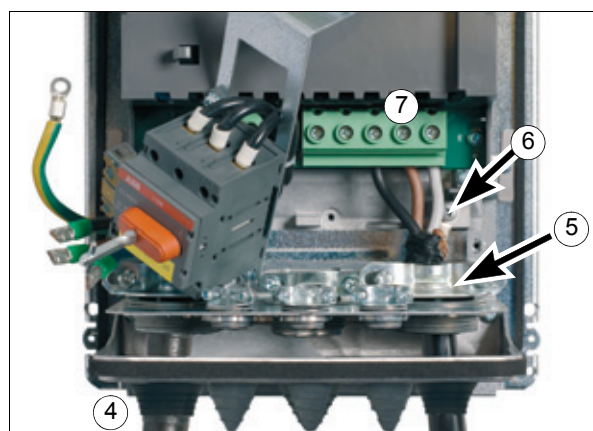
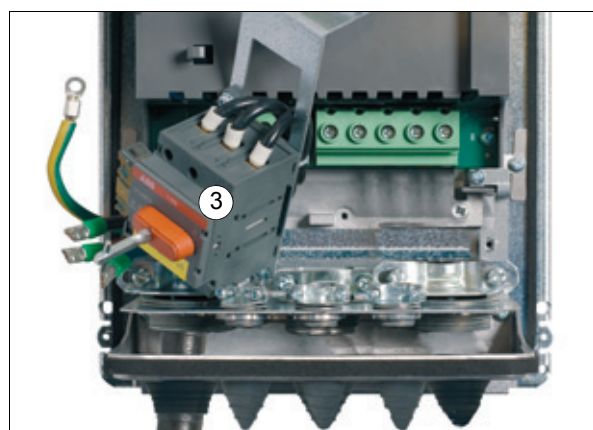
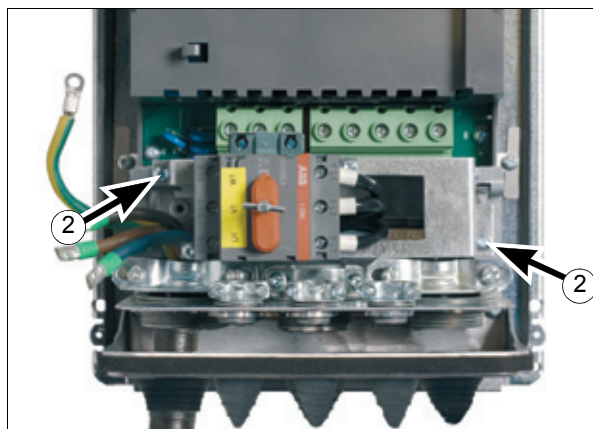

Tam. de bastidor	Par de apriete			
	U1, V1, W1	U2, V2, W2	Conexión a tierra	
	N·m (lbf ft)	N·m (lbf ft)	N·m	lbf·ft
R1	0,8 (0,6)	1,4 (1,0)	1,4	1,0
R2	0,8 (0,6)	1,4 (1,0)	1,4	1,0
R3	2 (1,5)	1,8 (1,3)	1,8	1,3

Contacto auxiliar: 0,8 N·m (0,6 lbf ft)

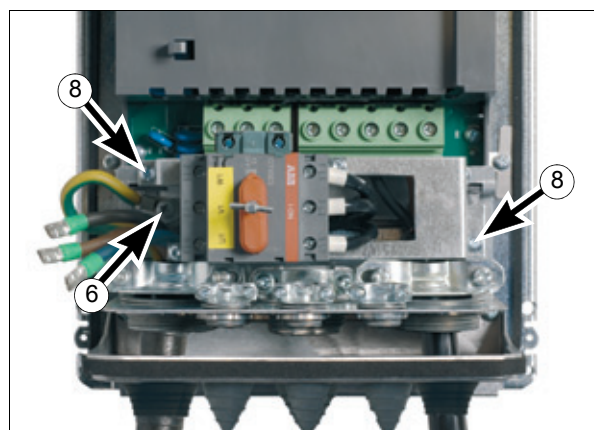
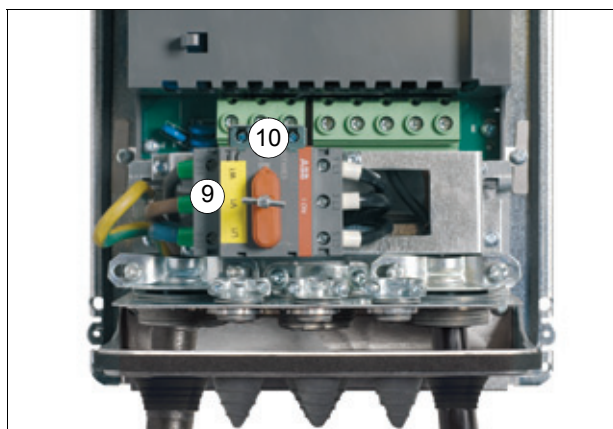

Principe de fonctionnement et raccordement des câbles de puissance

Produits concernés

Cette notice complète le document anglais *ACH550-01 User's Manual* [3AFE68258537]. Elle concerne les appareils équipés de l'option Interrupteur principal (code +F278), proposée pour les variateurs jusqu'au modèle ACH550-01-045A-4 (puissance 22 kW), de tailles R1 à R3 et en protection IP54. Elle décrit la procédure de raccordement des câbles réseau et moteur.

L'option Interrupteur principal n'est pas conforme aux normes UL.

Sécurité

Vous devez respecter les consignes de sécurité du manuel anglais *ACH550-01 User's Manual* [3AFE68258537].



Attention ! Ne soulevez pas le capot avant et n'intervenez pas sur le variateur avant d'avoir isolé les câbles d'alimentation du réseau, soit au niveau du tableau de distribution, soit en ouvrant le sectionneur du transformateur d'alimentation. L'interrupteur principal (code option +F278) ne coupe pas la tension d'alimentation CA des câbles d'alimentation et des bornes.

Principe de fonctionnement

L'interrupteur principal permet de couper la tension d'alimentation du variateur. Outre les contacts principaux, l'interrupteur possède aussi un contact auxiliaire, normalement fermé, qui indique son état.

La figure ci-dessous présente le circuit de puissance du variateur.

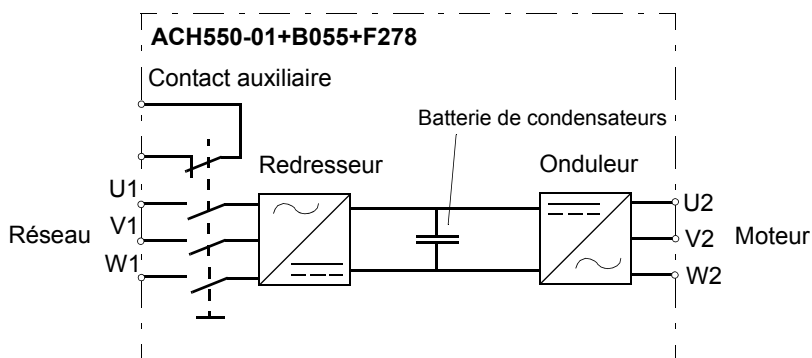

Dimensions

La poignée de l'interrupteur augmente la profondeur du variateur de 50 mm (1,97 in).

Raccordement des câbles de puissance

1. Démontez le capot avant comme indiqué dans le manuel de l'utilisateur.
2. Retirez les deux vis de fixation de la plaque de montage de l'interrupteur.
3. Tournez la plaque sur le côté.
4. Retirez les passe-fils en caoutchouc et coupez-les au diamètre requis. Enfilez les passe-fils, extrémité conique vers le bas, sur les câbles de puissance. Scellez les passe-fils sur les points d'entrée des ouvertures de la plaque.
5. Dénudez la gaine externe des câbles sous les colliers de reprises de masse sur 360°, puis fixez les colliers sur la partie dénudée des câbles.
6. Tordez le blindage des câbles pour former des queues de cochon que vous raccordez avec des cosses de câble sous les vis de terre. Les queues de cochon doivent être aussi courtes que possible pour minimiser les perturbations électromagnétiques.
7. Raccordez les conducteurs du câble moteur aux bornes U2, V2 et W2.
8. Remettez la plaque d'assemblage en place et resserrez les vis de fixation.
9. Raccordez les conducteurs du câble réseau aux bornes U1, V1 et W1.
10. Si vous utilisez un contact auxiliaire, raccordez-y les fils.
11. Raccordez les câbles de commande comme indiqué dans le manuel de l'utilisateur.
12. Remontez le capot avant.

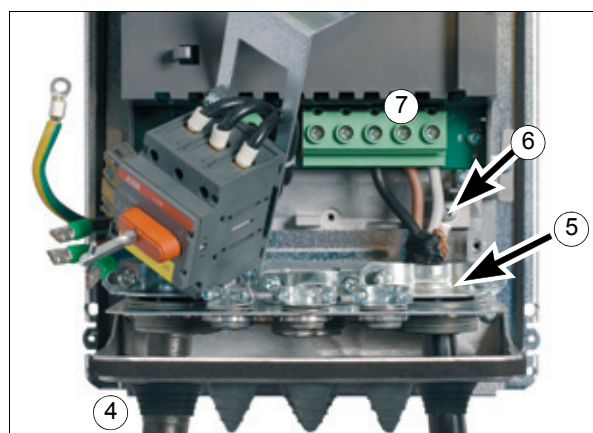
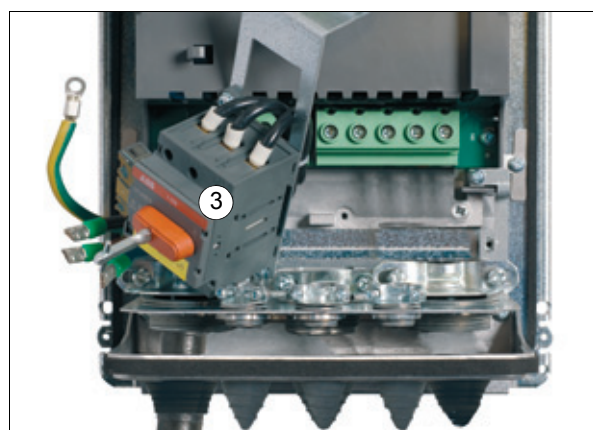
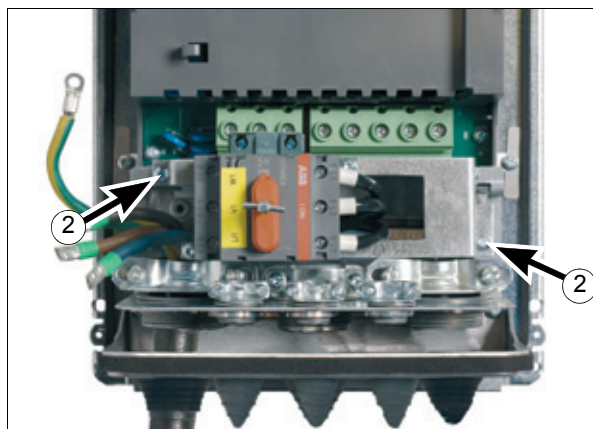

Taille	Couple de serrage			
	U1, V1, W1	U2, V2, W2	Terre de protection (PE)	
	N·m (lbf·ft)	N·m (lbf·ft)	N·m	lbf·ft
R1	0.8 (0.6)	1.4 (1.0)	1.4	1.0
R2	0.8 (0.6)	1.4 (1.0)	1.4	1.0
R3	2 (1.5)	1.8 (1.3)	1.8	1.3
Contact auxiliaire : 0,8 N·m (0,6 lbf·ft)				

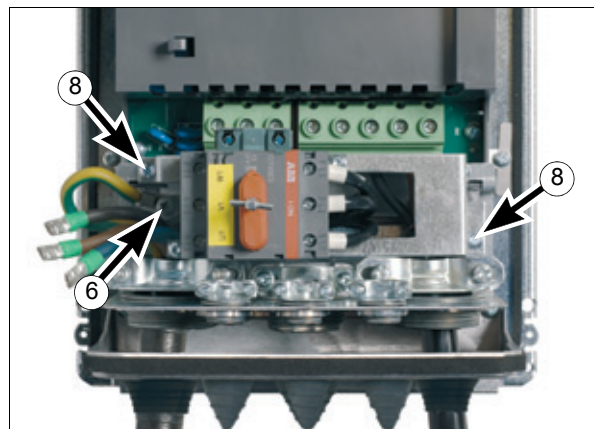
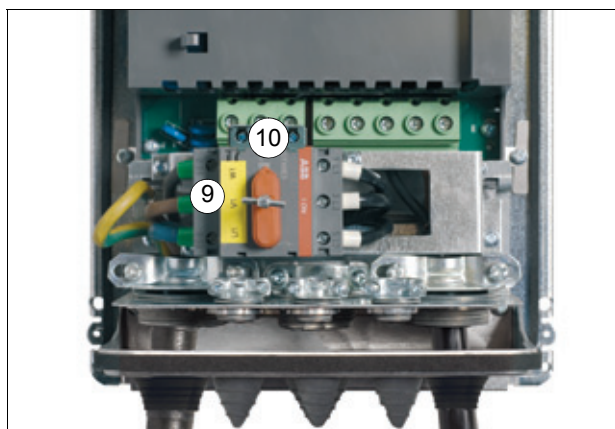

Principio di funzionamento e installazione dei cavi di potenza

Applicabilità

Queste istruzioni sono un supplemento del *Manuale utente dell'ACH550-01 3AFE68288908*. Si riferiscono alle unità dotate di interruttore principale opzionale +F278. L'interruttore principale è disponibile per i convertitori di frequenza fino ai modelli ACH550-01-045A-4 (potenza 22 kW), ossia i telai da R1 a R3 con grado di protezione IP54. Queste istruzioni spiegano la procedura di installazione del cavo di ingresso e del cavo motore.

L'interruttore principale opzionale non è certificato UL.

Sicurezza

Attenersi scrupolosamente alle norme di sicurezza contenute nel *Manuale utente dell'ACH550-01 3AFE68288908*.



Avvertenza! Prima di rimuovere il coperchio anteriore e di lavorare sul convertitore di frequenza, isolare i cavi di ingresso dall'alimentazione di rete in corrispondenza della scheda di distribuzione o aprire il sezionatore del trasformatore di alimentazione. L'interruttore principale (opzione +F278) non isola i cavi e i morsetti di ingresso dall'alimentazione di rete in c.a.

Principio di funzionamento

L'interruttore principale scollega l'alimentazione dal convertitore di frequenza. Oltre ai contatti principali, l'interruttore è dotato di un contatto ausiliario, normalmente chiuso, che indica lo stato dell'interruttore.

Lo schema seguente illustra il circuito principale del convertitore.

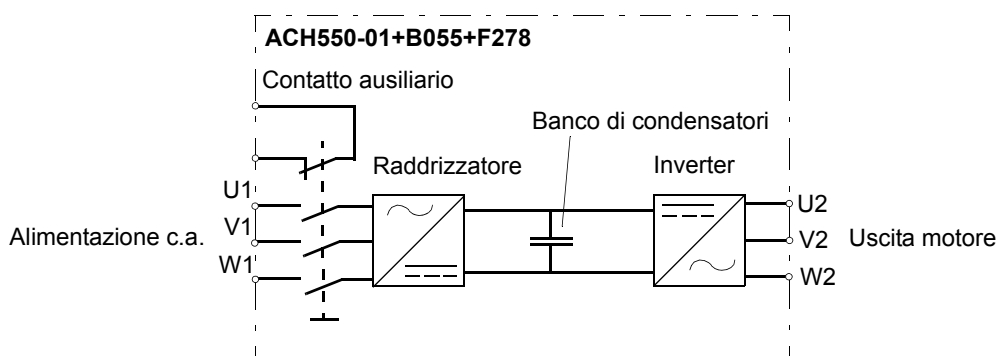

Dimensioni

La maniglia dell'interruttore principale aumenta di 50 mm (1.97 in.) la profondità del convertitore.

Procedura di installazione dei cavi di potenza

1. Rimuovere il coperchio anteriore come indicato nel Manuale utente.
2. Svitare le due viti della piastra di fissaggio dell'interruttore.
3. Spostare a lato la piastra di fissaggio dell'interruttore.
4. Rimuovere i gommini e forarli praticando dei fori di dimensioni adeguate. Infilare i gommini sui cavi di potenza con la parte conica rivolta verso il basso. Sigillare i fori della piastra passacavi con i gommini.
5. Spellare la guaina esterna dei cavi sotto i fissacavo di messa a terra a 360° e serrare i fissacavo sulla parte spellata dei cavi.
6. Intrecciare le schermature dei cavi e collegare le trecce sotto le viti di terra utilizzando dei capicorda. Le trecce devono essere il più corte possibile per ridurre al minimo le emissioni elettromagnetiche.
7. Collegare i conduttori del cavo motore ai morsetti U2, V2 e W2.
8. Riportare la piastra di fissaggio dell'interruttore principale nella posizione originaria e serrare le due viti di fissaggio.
9. Collegare i conduttori del cavo di ingresso ai morsetti U1, V1 e W1 dell'interruttore principale.
10. Collegare i fili al contatto ausiliario (se utilizzato).
11. Collegare i cavi di controllo come indicato nel Manuale utente.
12. Rimontare il coperchio anteriore.

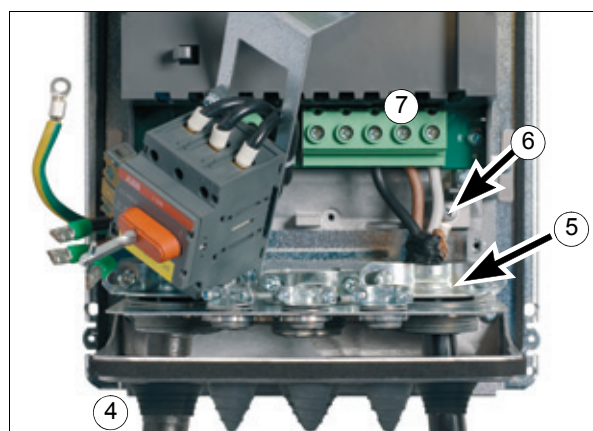
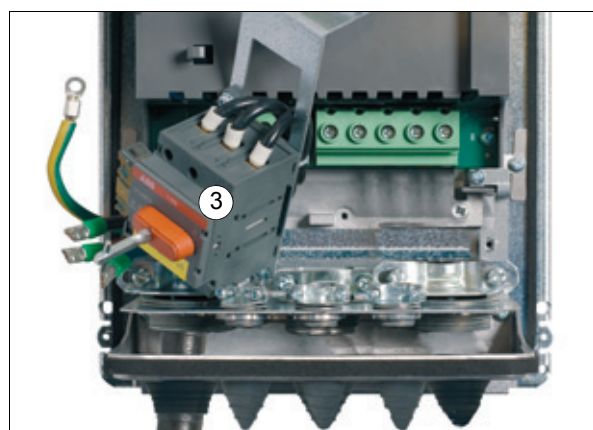
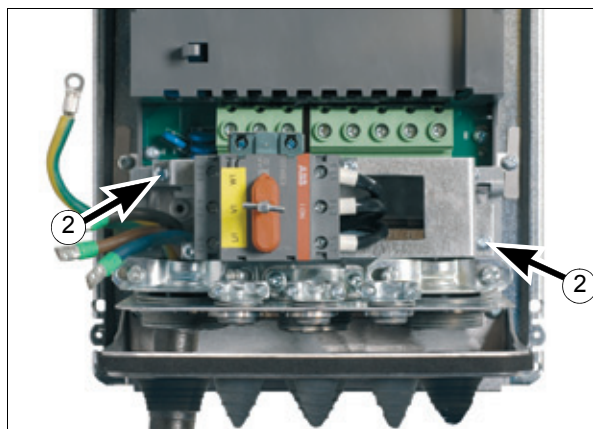

Telaio	Coppia di serraggio			
	U1, V1, W1	U2, V2, W2	Conduttore PE	
	N·m (lbf·ft)	N·m (lbf·ft)	N·m	lbf·ft
R1	0,8 (0.6)	1,4 (1.0)	1,4	1.0
R2	0,8 (0.6)	1,4 (1.0)	1,4	1.0
R3	2 (1.5)	1,8 (1.3)	1,8	1.3
Contatto ausiliario: 0,8 N·m (0.6 lbf·ft)				

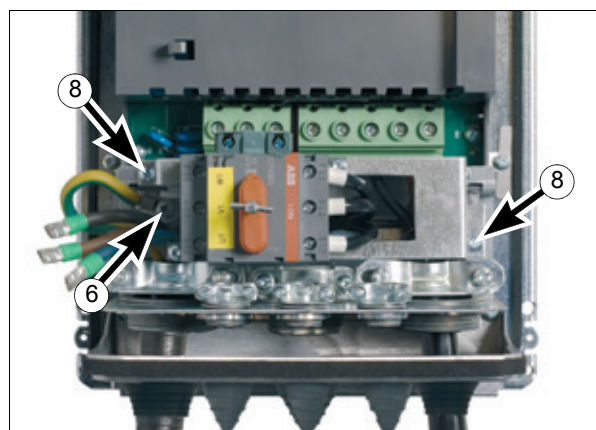
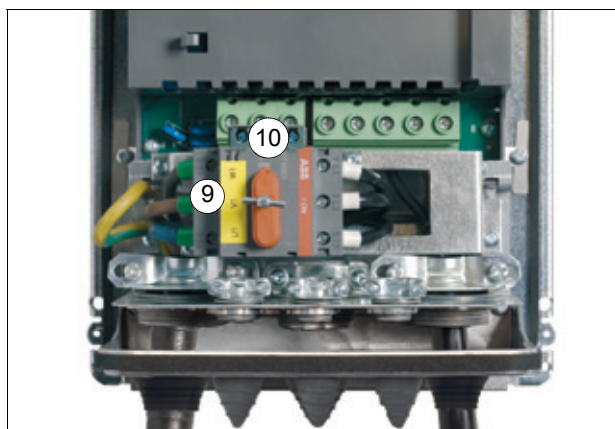

Werkingsprincipe en vermogenskabelinstallatie

Toepasbaarheid

Dit is een supplement bij de *ACH550-01 Gebruikershandleiding* [3AFE68258537 (Engels)]. Het supplement is van toepassing op units met hoofdschakelaaroptie +F278. De hoofdschakelaar is leverbaar voor omvormertypes tot ACH550-01-045A-4 (vermogen 22 kW) d.w.z. frame-afmetingen R1 tot R3 met beschermingsgraad IP54. Het supplement instrueert hoe de ingangs- en motorkabels geïnstalleerd moeten worden.

De hoofdschakelaar-optie is niet UL-goedgekeurd.

Veiligheid

Volg de veiligheidsinstructies uit de *ACH550-01 Gebruikershandleiding* [3AFE68258537 (Engels)].



Waarschuwing! Voordat u de frontkap verwijdert en aan de omvormer gaat werken, dient u de ingangskabels van de hoofdvoeding te scheiden bij de verdeelkast of door de disconnector van de voedingstransformator te openen. De hoofdschakelaar (optie +F278) scheidt de ingangskabels en klemmen niet van de hoofd-draaistroomvoeding.

Werkingsprincipe

De hoofdschakelaar wordt gebruikt om de voeding van de omvormer uit te schakelen. Naast de hoofdcontacten heeft de schakelaar één normaal gesloten hulpcontact dat de status van de schakelaar aangeeft.

De hoofdstroomkring van de omvormer wordt hieronder gegeven.

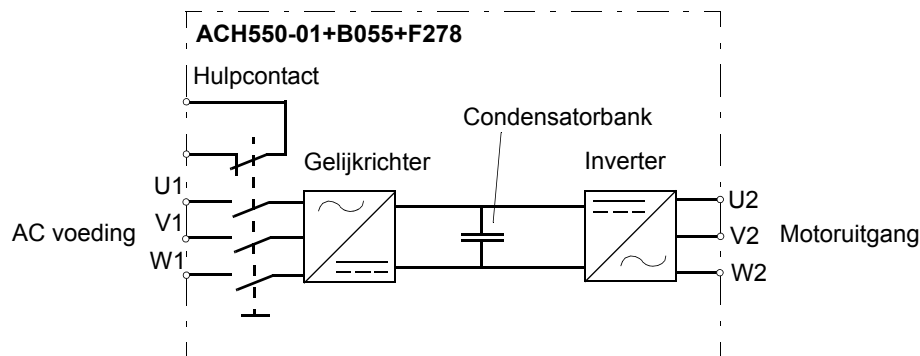

Afmetingen

De knop van de hoofdschakelaar vergroot de diepte van de omvormer met 50 mm (1,97 in.).

Installatieprocedure van de vermogenskabel

1. Verwijder de frontkap zoals getoond in de gebruikershandleiding.
2. Maak de twee bevestigingsschroeven van de schakelaar-montageplaat los.
3. Draai de schakelaar-montageplaat opzij.
4. Verwijder de rubberen doorvoertules en snij er voldoende grote gaten in. Schuif de doorvoertules op de vermogenskabels met het conische deel naar beneden. Dicht de gaten in de doorvoerplaat af met de doorvoertules.
5. Strip de buitenmantel van de kabels weg tot onder de 360 graden aardklemmen en bevestig de klemmen over de gestripte delen van de kabels.
6. Twist de kabelafschermingen tot pigtails en sluit de pigtails aan onder de aardingschroeven met kabelschoenen. Houdt de pigtails kort om elektromagnetische straling te minimaliseren.
7. Sluit de motorkabelgeleiders aan op de U2, V2 en W2 klemmen.
8. Draai de schakelaar-montageplaat terug naar zijn oorspronkelijke positie en maak de twee bevestigingsschroeven vast.
9. Sluit de ingangskabelgeleiders aan op de klemmen U1, V1 en W1 van de hoofdschakelaar.
10. Sluit draden op het hulpcontact aan (indien dit gebruikt wordt).
11. Sluit de besturingskabels aan zoals getoond in de gebruikershandleiding.
12. Zet de frontkap terug.

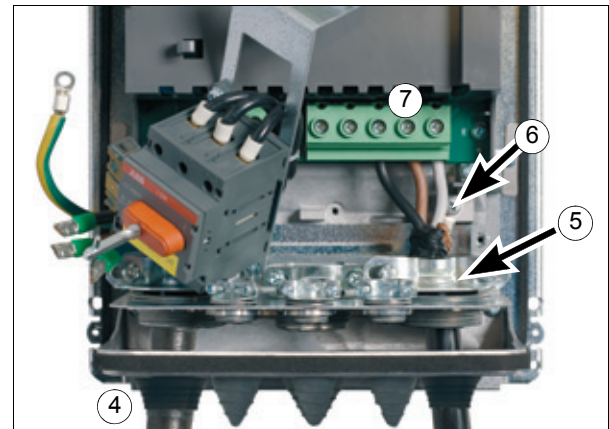
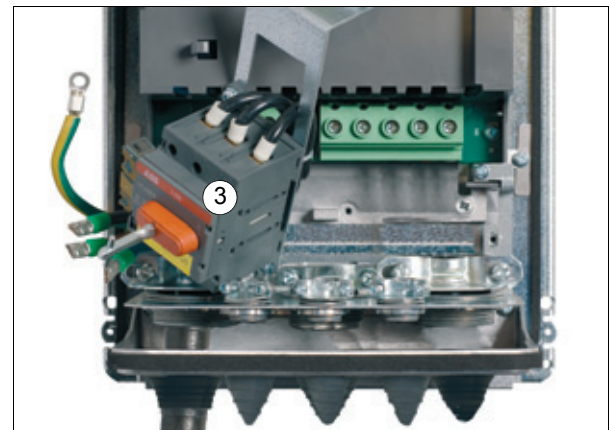
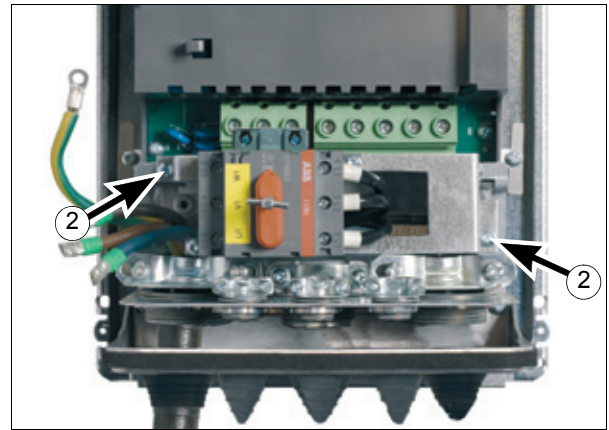

Frame	Aandraaimoment			
	U1, V1, W1	U2, V2, W2	PE aarde	
	N·m (lbf·ft)	N·m (lbf·ft)	N·m	lbf·ft
R1	0.8 (0.6)	1.4 (1.0)	1.4	1.0
R2	0.8 (0.6)	1.4 (1.0)	1.4	1.0
R3	2 (1.5)	1.8 (1.3)	1.8	1.3

Hulpcontact: 0.8 N·m (0.6 lbf·ft)

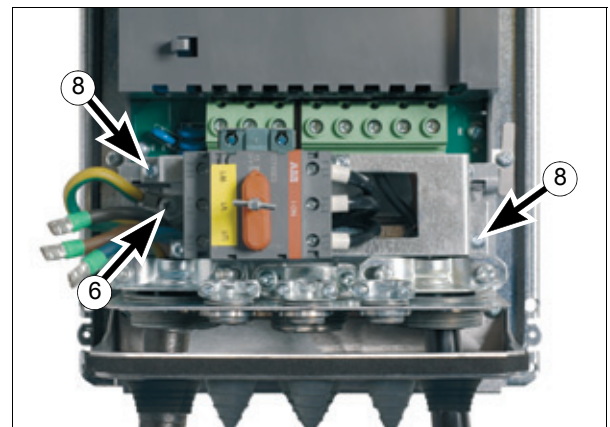
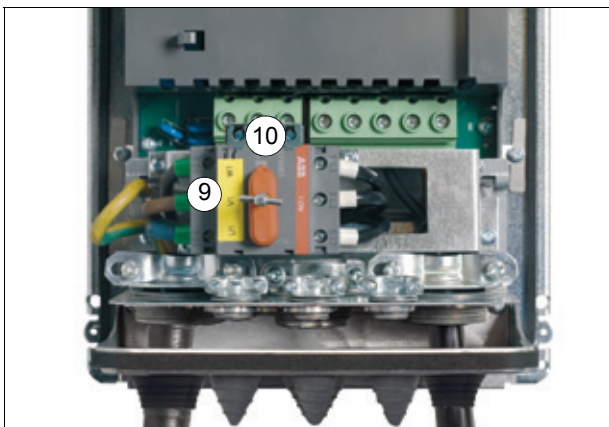

Princípio de operação e instalação do cabo de potência

Aplicação

Este é um suplemento para o *Manual do Utilizador do ACH550-01* [3AFE68258537 (English)]. O suplemento aplica-se a unidades com opção de interruptor principal +F278. O interruptor principal está disponível para conversores de frequência tipo ACH550-01-045A-4 (potência 22 kW) i.e., tamanhos de chassi R1 a R3 com grau de protecção de IP54. O suplemento apresenta instruções sobre como instalar os cabos de entrada e do motor.

A opção de interruptor principal não tem marcação UL.

Segurança

Cumpra as instruções de segurança apresentadas no *Manual do Utilizador do ACH550-01* [3AFE68258537 (English)].



Aviso! Antes de remover a tampa frontal e de efectuar qualquer trabalho no conversor de frequência, isole os cabos de entrada da rede de alimentação no painel de distribuição ou abrindo o seccionador do transformador de alimentação. O interruptor principal (opção +F278) não isola os cabos de entrada e terminais da rede de alimentação CA.

Princípio de operação

O interruptor principal é usado para desligar a potência de entrada do conversor de frequência. Além dos contactos principais, o interruptor tem normalmente um contacto auxiliar fechado que indica o estado do interruptor.

O circuito principal do conversor de frequência é apresentado abaixo.

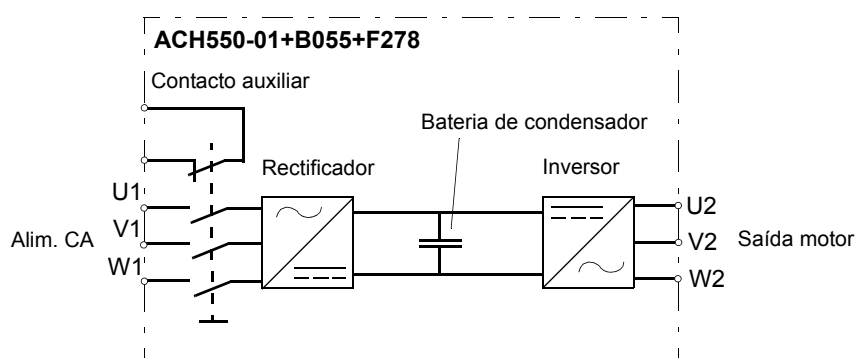

Dimensões

O punho do interruptor principal aumenta a profundidade do conversor de frequência em 50 mm (1.97 in.).

Procedimento de instalação do cabo de potência

1. Retire a tampa frontal como apresentado no manual de utilizador.
2. Desaperte os dois parafusos de aperto rápido da platine de montagem do interruptor.
3. Afaste a platine de montagem do interruptor.
4. Retire os passa-fios de borracha e faça os furos nos mesmos. Insira os passa-fios nos cabos de potência com a parte cónica para baixo. Isole os furos da platina condutora com os passa-fios.
5. Descarne o revestimento exterior dos cabos por baixo dos grampos de ligação à terra a 360 graus e aperte os grampos às partes descarnadas dos cabos.
6. Torça as blindagens dos cabos em espiral e ligue as espirais por baixo dos parafusos de terra com terminais de cabo. Mantenha as espirais de cabo o mais curto possível para minimizar a emissão electromagnética.
7. Ligue os condutores do cabo do motor aos terminais U2, V2 e W2.
8. Rode a platine de montagem do interruptor para a sua posição original e aperte os dois parafusos de aperto rápido.
9. Ligue os condutores do cabo de entrada aos terminais do interruptor principal U1, V1 e W1.
10. Ligue os cabos ao contacto auxiliar (se usado).
11. Ligue os cabos de controlo como apresentado no manual do utilizador.
12. Volte a colocar a tampa frontal.

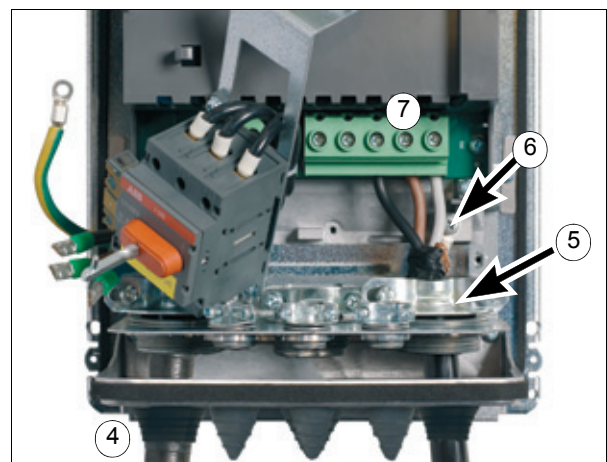
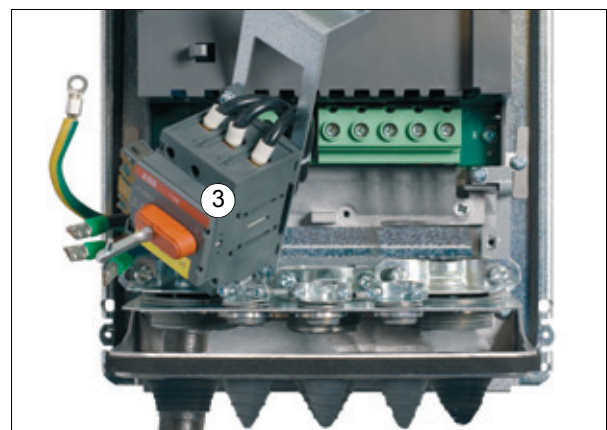
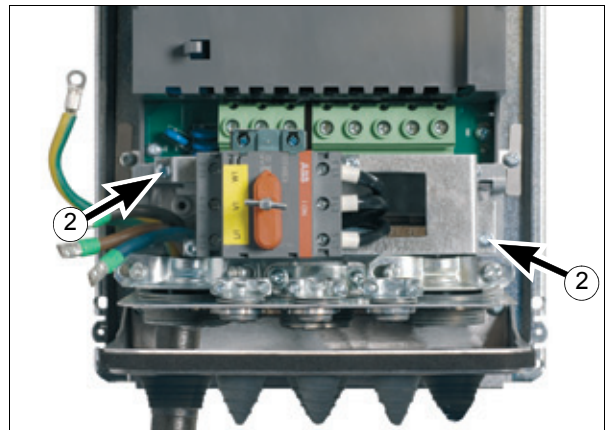

Tam. chassi	Binário de aperto			
	U1, V1, W1	U2, V2, W2	Terra PE	
	N·m (lbf·ft)	N·m (lbf·ft)	N·m	lbf·ft
R1	0.8 (0.6)	1.4 (1.0)	1.4	1.0
R2	0.8 (0.6)	1.4 (1.0)	1.4	1.0
R3	2 (1.5)	1.8 (1.3)	1.8	1.3

Contacto auxiliar: 0.8 N·m (0.6 lbf·ft)

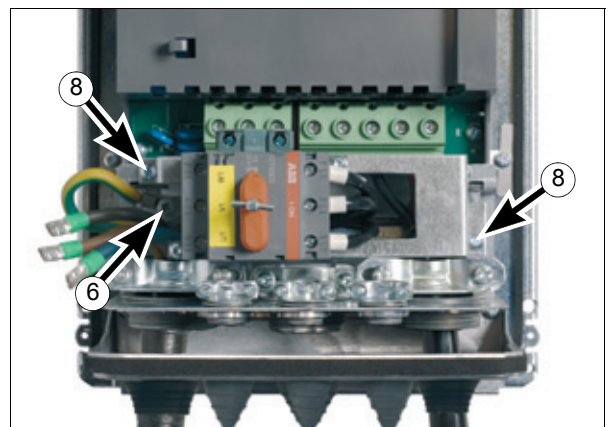
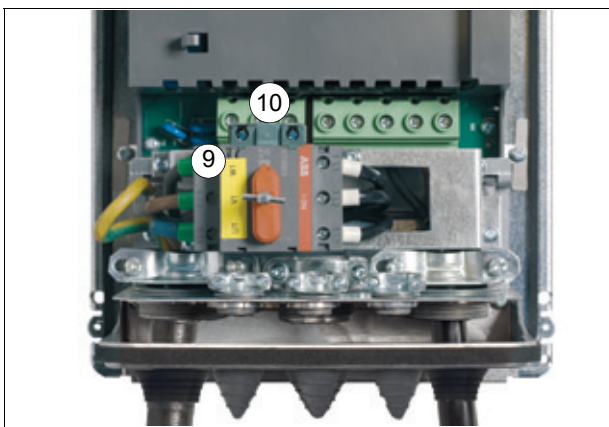

Принцип действия и монтаж силовых кабелей

Применимость

Настоящий документ является приложением к *Руководству пользователя АСН550-01* [ЗАФЕ68258537 (на английском языке)]. Приложение относится к устройствам с главным выключателем (опция +F278). Главный выключатель может быть установлен на приводах вплоть до АСН550-01-045А-4 (мощность 22 кВт), т.е. приводах типоразмеров от R1 до R3 со степенью защиты IP54. В приложении приведены инструкции по монтажу входного питающего кабеля и кабеля электродвигателя.

Опция главного выключателя не имеет сертификации UL.

Безопасность

Соблюдайте инструкции по безопасности, приведенные в *Руководстве пользователя АСН550-01* [ЗАФЕ68258537 (на английском языке)].



Внимание! Перед тем, как снять переднюю крышку и приступить к работе с приводом, следует изолировать питающий кабель от электросети на распределительном щите, или разомкнуть разъединитель трансформатора питания. Следует иметь в виду, что главный выключатель (опция +F278) не изолирует питающий кабель и входные клеммы привода от электросети.

Принцип действия

Главный выключатель служит для отключения входного электропитания привода. В дополнение к главным контактам выключатель имеет один нормально замкнутый вспомогательный контакт, который используется для индикации состояния выключателя.

Силовая цепь привода показана на приведенной ниже схеме.

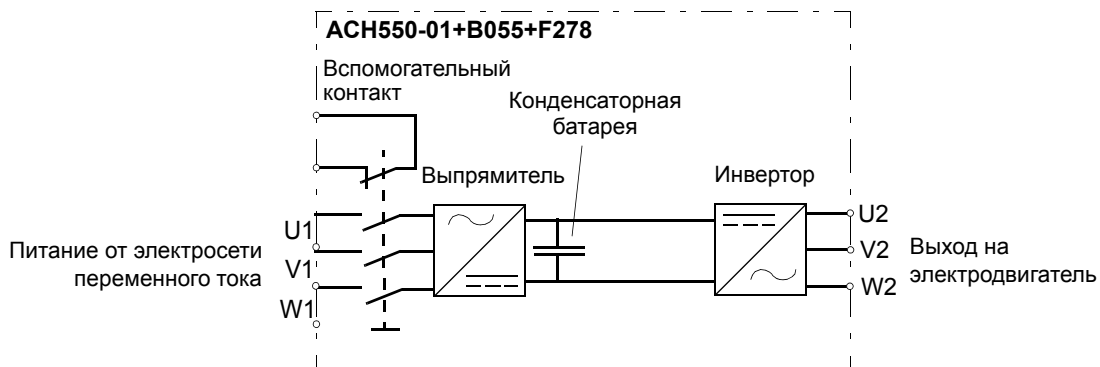

Размеры

Рукоятка главного выключателя выступает из шкафа привода на 50 мм (1,97 дюйма)

Процедура монтажа силового кабеля

13. Снимите переднюю крышку, как показано в руководстве пользователя.
14. Выверните два винта крепления монтажной пластины выключателя.
15. Поверните монтажную пластину выключателя в сторону.
16. Снимите резиновые втулки и прорежьте в них отверстия соответствующего диаметра. Наденьте втулки на силовые кабели конической частью вниз. Вставьте резиновые втулки в отверстия панели ввода кабелей.
17. Снимите наружную оболочку кабелей по всей окружности, проведите кабели через заземляющие зажимы и при помощи этих зажимов зажмите кабели через отрезки со снятой наружной оболочкой.
18. Скрутите экраны кабелей в канатики и, припаяв к ним кабельные наконечники, присоедините их к корпусу при помощи винтов клемм заземления. С целью сведения к минимуму электромагнитного излучения канатики экранов следует сделать как можно более короткими.
19. Подключите проводники кабеля электродвигателя к клеммам U2, V2 и W2.
20. Поверните монтажную пластину выключателя в первоначальное положение и закрепите ее двумя винтами.
21. Подключите проводники входного питающего кабеля к клеммам U1, V1 и W1 главного выключателя.
22. Подключите провода к вспомогательному контакту (если он используется).
23. Подключите кабели управления, как показано в руководстве пользователя.
24. Установите переднюю крышку.

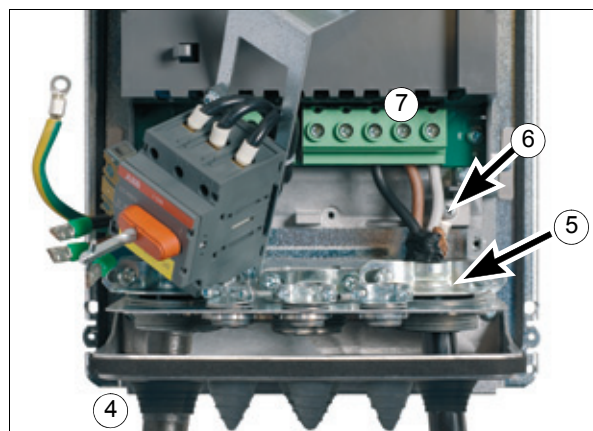
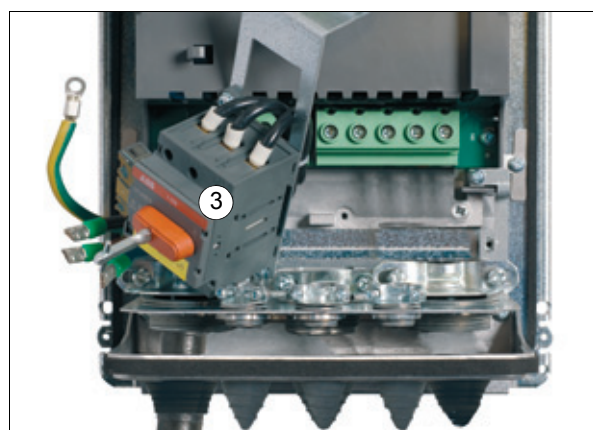
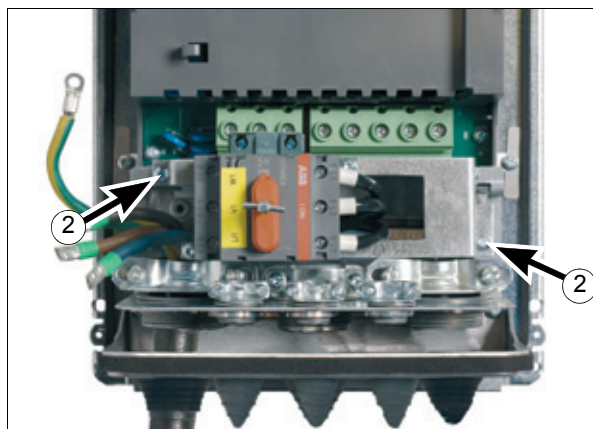

Типо-размер	Момент затяжки			
	U1, V1, W1	U2, V2, W2	Клемма защитного	
	Н·м (фунт-футы)	Н·м (фунт-футы)	Н·м	фунт-футы
R1	0,8 (0,6)	1,4 (1,0)	1,4	1,0
R2	0,8 (0,6)	1,4 (1,0)	1,4	1,0
R3	2 (1,5)	1,8 (1,3)	1,8	1,3

Вспомогательный контакт: 0,8 Н·м (0,6 фунт-фута)

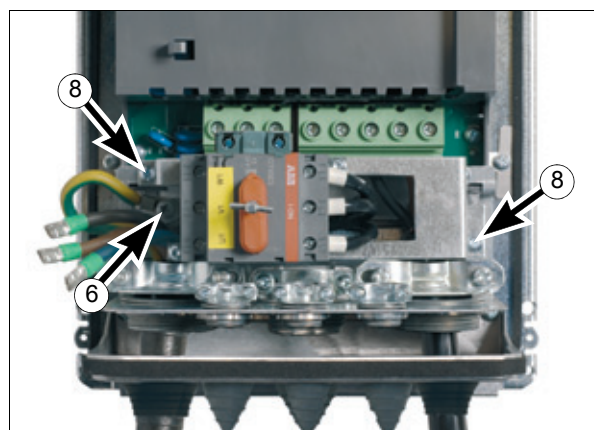
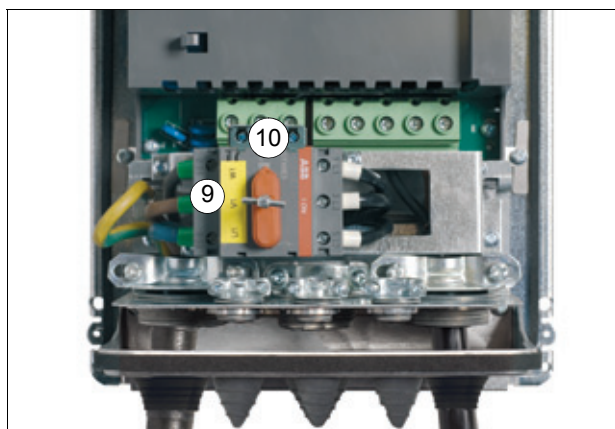

Toimintaperiaate ja tehokaapeleiden asentaminen

Sovellettavuus

Tämä opas täydentää *ACH550-01 Käyttäjän opasta* (3AFE68288878). Lisäopas koskee pääkytkimellisiä laitteita (lisävaruste +F278). Pääkytkin on saatavana IP54 koteloituun laitteisiin tyyppiin ACH550-01-045A-4 saakka (tehoon 22 kW saakka, runkokokoihin R1–R3). Lisäopas sisältää ohjeet syöttö- ja moottorikaapeleiden asentamista varten.

Pääkytkinlisävaruste ei ole UL-hyväksytty.

Turvallisuus

Noudata turvaohjeita, jotka on annettu *ACH550-01 Käyttäjän oppaassa* (3AFE68288878).



Varoitus! Ennen kuin irrotat etukannen ja alat käsitellä taajuusmuuttajaa, erota syöttökaapelit verkosta jakokeskuksessa tai avaamalla syöttömuuntajan kytkin. Pääkytkin (lisävaruste +F278) ei erota syöttökaapeleita ja -liittimiä päävaihdevirtasyötöstä.

Toimintaperiaate

Pääkytkimellä katkaistaan virransyöttö taajuusmuuttajaan. Pääkoskettimien lisäksi kytkimessä on yksi avautuva apukosketin, joka ilmaisee kytkimen tilan.

Taajuusmuuttajan pääpiiri on kuvattu alla.

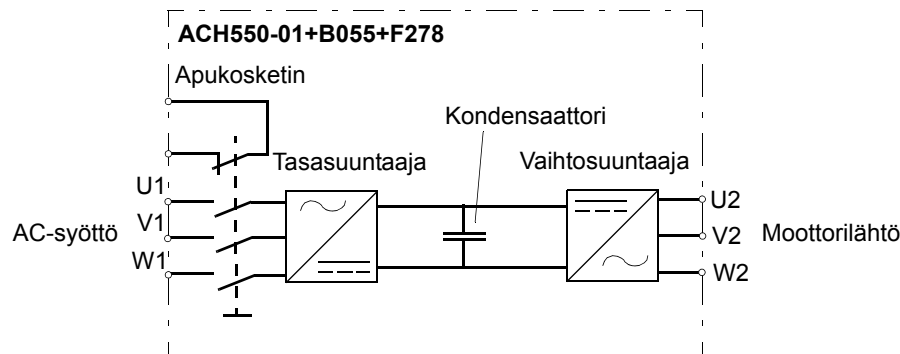

Mitat

Pääkytkimen kahva kasvattaa taajuusmuuttajan syvyyttä 50 mm.

Tehokaapeleiden asentaminen

1. Irrota etukansi käyttöoppaassa kuvatulla tavalla.
2. Avaa kytkimen asennuslevyn kaksi kiinnitysruuvia.
3. Käännä kytkimen asennuslevy sivuun.
4. Irrota kumitiivisteet ja leikkaa niihin tarvittavat reiät. Pujota tiivisteet tehokaapeleihin kartion muotoinen osa alaspäin. Tiivistä läpivientilevyn reiät tiivisteillä.
5. Kuori kaapelien ulompi suoja 360 asteen maadoitusliittimien alta ja kiinnitä liittimet kaapelien kuorittuun osaan.
6. Kierrä kaapelien suojat maadoituspunoksiksi ja kytke maadoituspunokset maadoitusruuvien alle kaapelikenkien avulla. Pidä maadoituspunokset lyhyinä sähkömagneettisten häiriöiden vähentämiseksi.
7. Kytke moottorikaapelin johtimet liittimiin U2, V2 ja W2.
8. Käännä kytkimen asennuslevy takaisin alkuperäiseen asentoonsa ja kiinnitä kaksi kiinnitysruuvia.
9. Kytke syöttökaapelin johtimet pääkytkimen liittimiin U1, V1 ja W1.
10. Kytke johtimet apukoskettimeen (jos se on käytössä).
11. Kytke ohjauskaapelit käyttöoppaassa kuvatulla tavalla.
12. Kiinnitä etukansi takaisin.

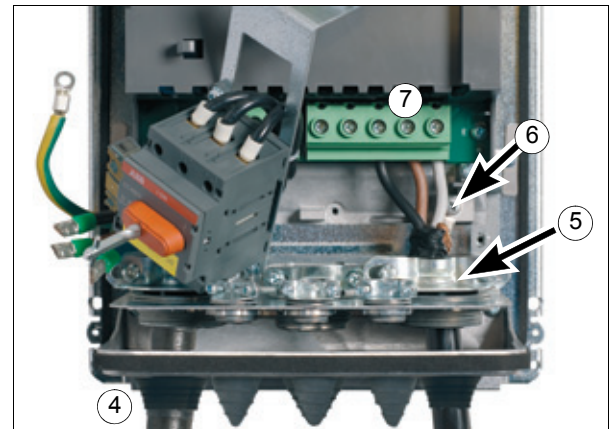
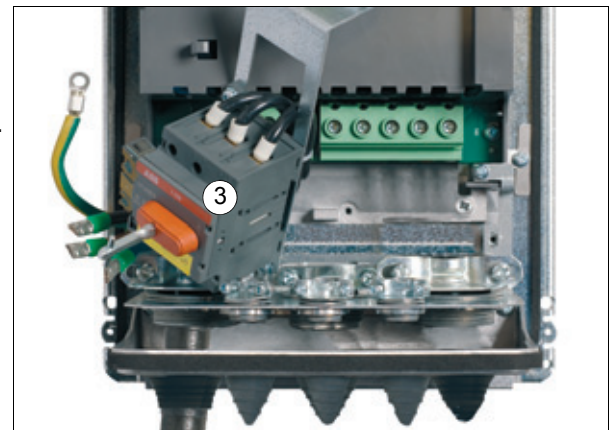
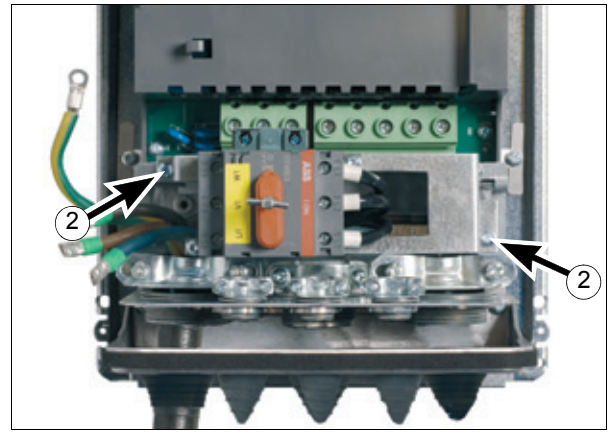

Runko koko	Kivistysmomentti		
	U1, V1, W1	U2, V2, W2	PE-maadoitus
	Nm	Nm	Nm
R1	0,8	1,4	1,4
R2	0,8	1,4	1,4
R3	2	1,8	1,8

Apukosketin: 0,8 Nm

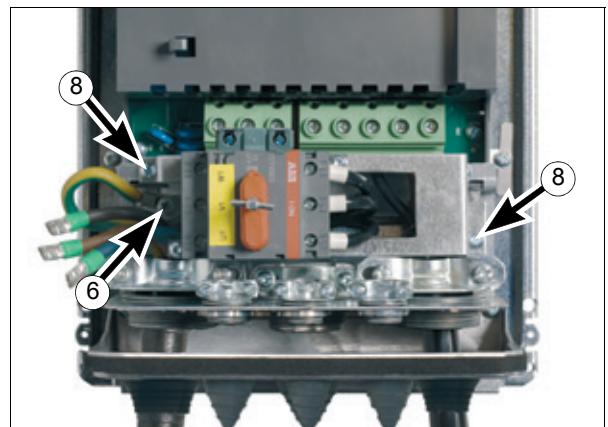
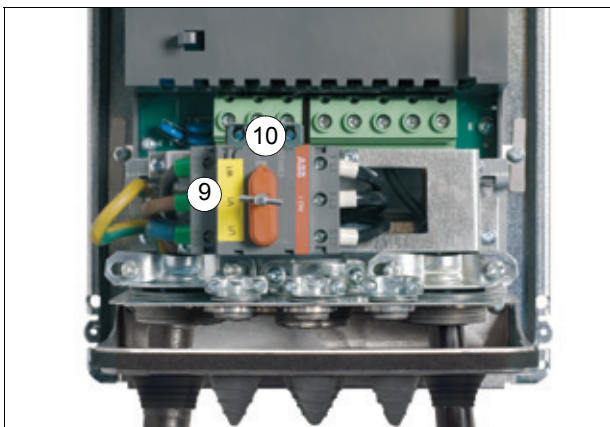

Funktionsprincip och kraftkabelinstallation

Tillämpbarhet

Detta är ett tillägg till *ACH550-01 User's Manual* [3AFE68258537 (engelska)]. Tillägget gäller för enheter som levereras med tillvalet huvudströmbrytare +F278.

Huvudströmbrytaren finns för frekvensomriktartyper upp till ACH550-01-045A-4 (effekt 22 kW) dvs. byggstorlek R1 R3 med kapslingsklass IP54. Tillägget beskriver installation av ingångs- och motorkablar.

Tillvalet huvudströmbrytare är inte UL-listat.

Säkerhet

Följ säkerhetsinstruktionerna i *ACH550-01 Användarhandledning* [3AFE68288941].



Varning! Före avtagning av frontkåpan och ingrepp i frekvensomriktaren, skilj nätkabeln från huvudmatning vid spänningsfördelningen eller öppna matningstransformatorns frånskiljare. Huvudströmbrytaren (tillval +F278) skiljer inte nätkabeln och plintarna från huvudmatningen.

Funktionsprincip

Huvudströmbrytaren används för att bryta inkommande matning till frekvensomriktaren. Förutom huvudkontaktarna har brytaren en normalt sluten hjälpkontakt som visar status för brytaren.

Huvudkretsschemat för frekvensomriktaren visas nedan.

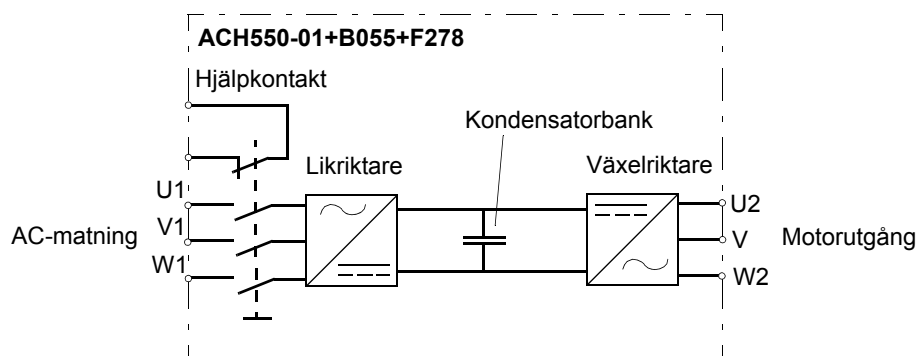

Mått

Handgreppet på huvudströmbrytaren motsvarar frekvensomriktarens djup, 50 mm.

Installationsprocedur för kraftkablar

1. Ta av frontkåporna så som framgår av användarhandledningen.
2. Lossa de två fästskruvarna för brytarens monteringsplatta.
3. Vrid brytarens monteringsplatta åt sidan.
4. Ta bort gummikragarna och skär lämpliga hål i dem. För upp kragarna på kraftkablarna med den koniska delen nedåt. Täta hålen i genomföringsplåten med kragarna.
5. Skala av kabelmantlarna under de 360° runtomgående jordklämmorna och fixera klämmorna över kablarnas skalade partier.
6. Tvinna samman kabelskärmarnas ändar och anslut de tvinnade ändarna till jordskruvarna med kabelskor. Håll de sammantvinnade kabelskärmändarna korta för att minimera den elektromagnetiska utstrålningen.
7. Anslut motorkabelns fasledare till anslutningarna U2, V2 och W2.
8. Vrid brytarens monteringsplatta tillbaka till sin ursprungliga position och dra åt de båda fästskruvarna.
9. Anslut nätkabelns fasledare till huvudströmbrytarens plintar U1, V1 och W1.
10. Anslut ledare till hjälpkontakten (om den används).
11. Anslut styrkablarna så som framgår av användarhandledningen.
12. Sätt tillbaka frontkåpan.

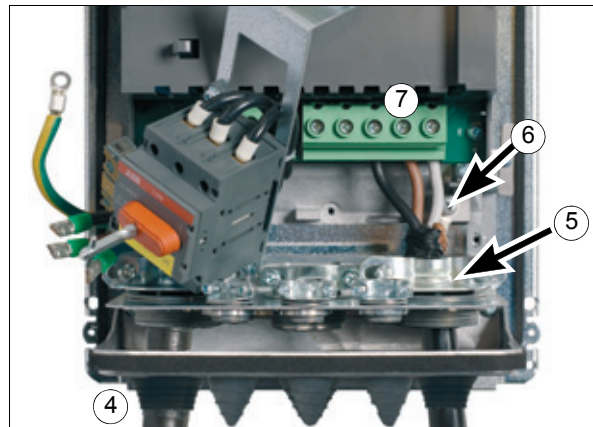
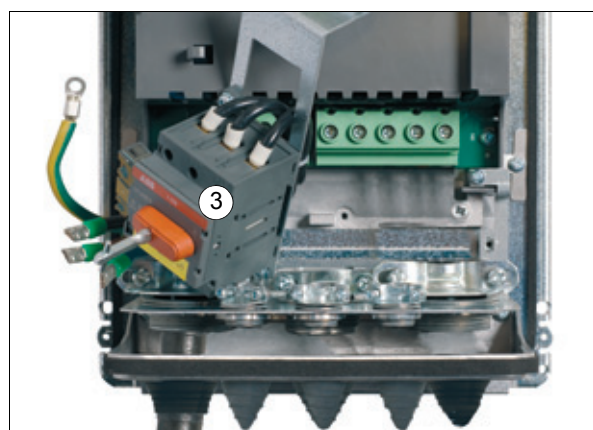
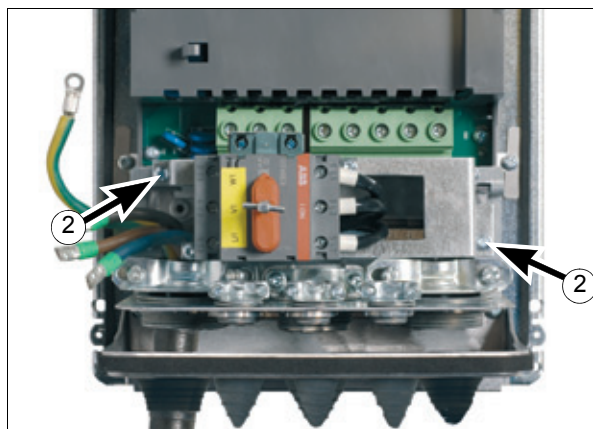

Byggstorl.	Åtdragningsmoment		
	U1, V1, W1	U2, V2, W2	Skyddsjord
	Nm	Nm	Nm
R1	0,8	1,4	1,4
R2	0,8	1,4	1,4
R3	2	1,8	1,8
Hjälpkontakt: 0,8 Nm			

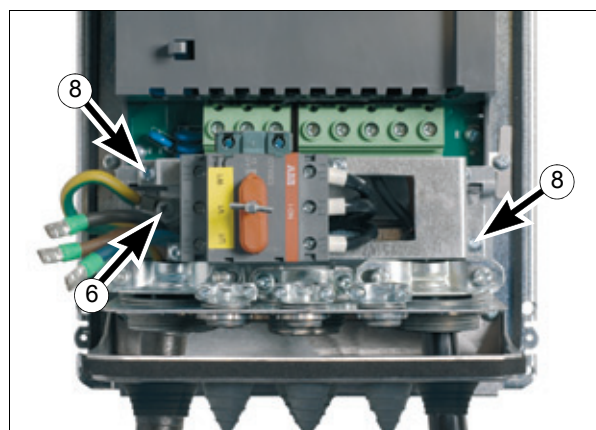
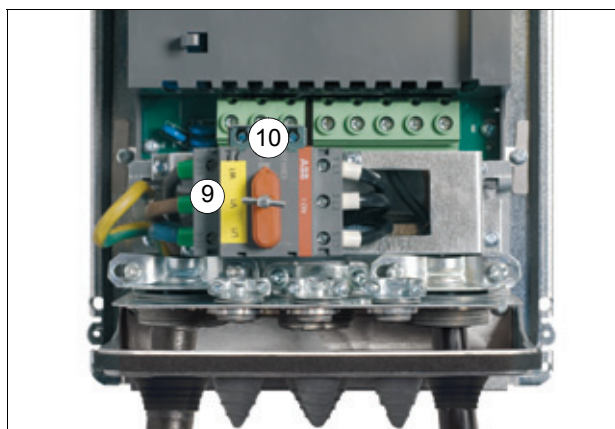

Çalışma ilkesi ve güç kablosu montajı

Uygulama

Bu belge, ACH550-01 Kullanım Kılavuzu [3AFE68258537 (İngilizce)] için ektir. Bu ek, +F278 ana anahtar seçenekli üniteler için geçerlidir. Ana anahtar, IP54 koruma sınıfına sahip R1 - R3 kasa tipleri olmak üzere ACH550-01-045A-4'e (22 kW gücüne) kadar olan sürücü tipleri için kullanılmaktadır. Bu ekte, giriş ve motor kablolarının nasıl takılacağı açıklanmıştır.

Ana anahtar seçeneği UL listesinde bulunmamaktadır.

Güvenlik

ACH550-01 Kullanım Kılavuzunda [3AFE68258537 (İngilizce)] verilen güvenlik talimatlarına uyun.



Uyarı! Ön kapağı çıkarmadan ve sürücü üzerinde çalışmaya başlamadan önce, ana beslemeden gelen kabloları dağıtım panosunda veya besleme transformatörünün ayırıcısını açarak yalıtın. Ana anahtar (seçenek +F278), ana AC beslemesinden gelen giriş kablolarını ve terminalleri yalıtmaz.

Çalışma ilkesi

Ana anahtar, sürücünün giriş gücünü kapatmak için kullanılır. Ana kontaklara ek olarak, anahtarda anahtar durumunu gösteren bir normalde kapalı yardımcı kontak da bulunur.

Sürücünün ana devresi aşağıda gösterilmiştir.

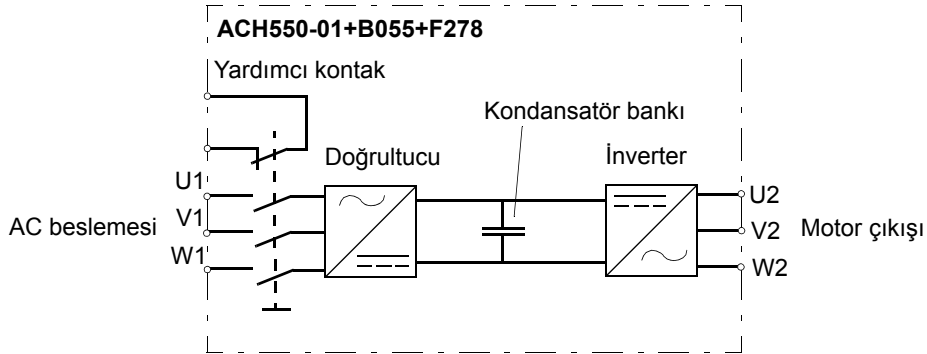

Boyutlar

Ana anahtarın kolu, sürücünün derinliğini 50 mm uzatır.

Güç kablosu montaj prosedürü

1. Ön kapağı kullanım kılavuzunda gösterilen şekilde çıkarın.
2. Anahtar montaj plakasının iki sabitleme vidasını çıkarın.
3. Anahtar montaj plakasını bir tarafa çevirin.
4. Kauçuk halkaları çıkarın ve üzerlerine uygun delikler açın. Halkaları, konik parça aşağı gelecek şekilde güç kablolarının üzerinde kaydırın. Kablo geçiş plakasının deliklerini halkalarla kapatın.
5. Kabloların dış kılıfını 360 derece topraklama kelepçelerinin altında sıyırın ve kelepçeleri kabloların sıyrılan kısmına sabitleyin.
6. Kablo muhafazalarını saç örgüsü şeklinde bükün ve örgüleri kablo pabuçlu topraklama vidalarının altına bağlayın. Elektromanyetik emisyonu azaltmak için örgüleri kısa tutun.
7. Motor kablosu iletkenlerini U2, V2 ve W2 terminallerine bağlayın.
8. Anahtar montaj plakasını orijinal konumuna döndürün ve iki sabitleme vidasını sıkın.
9. Giriş kablosu iletkenlerini U1, V1 ve W1 ana anahtar terminallerine bağlayın.
10. Telleri varsa yardımcı kontağa bağlayın.
11. Kontrol kablolarını kullanım kılavuzunda gösterilen şekilde bağlayın.
12. Ön kapağı tekrar takın.

Kasa tipi	Sıkma torku			
	U1, V1, W1	U2, V2, W2	Topraklama PE	
	N·m (lbf·ft)	N·m (lbf·ft)	N·m	lbf·ft
R1	0,8 (0,6)	1,4 (1,0)	1,4	1,0
R2	0,8 (0,6)	1,4 (1,0)	1,4	1,0
R3	2 (1,5)	1,8 (1,3)	1,8	1,3

Yedek kontak: 0,8 N·m (0,6 lbf·ft)

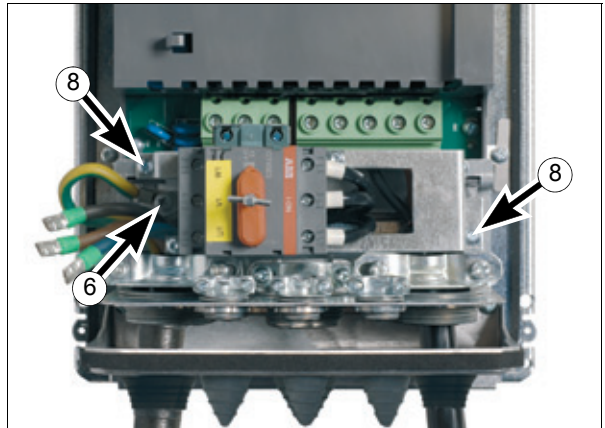
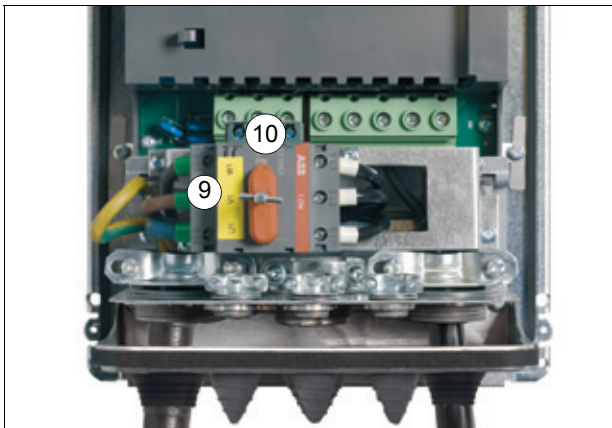
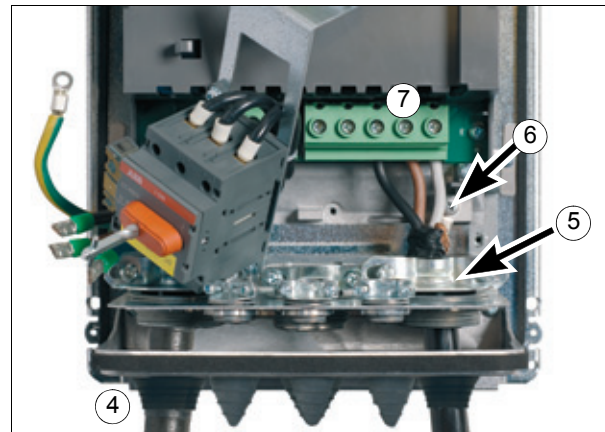
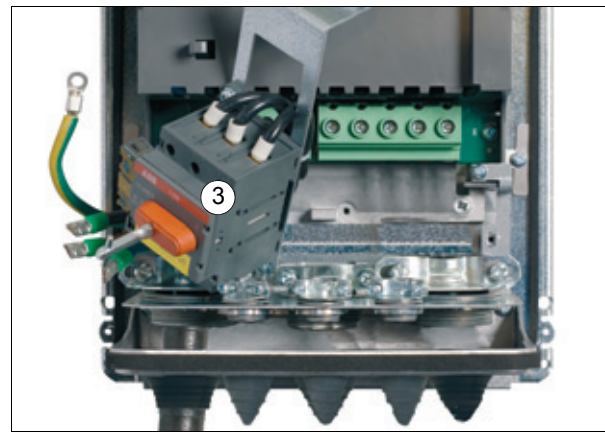
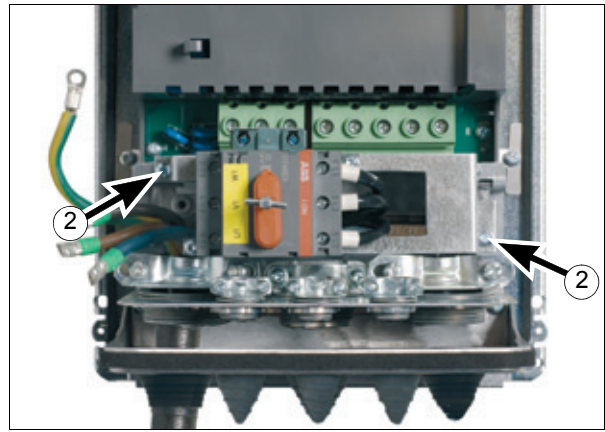



3AJA0000040634 REV B
EFFECTIVE: 14.11.2008
© 2008 ABB Oy. All rights reserved.

ABB Oy

AC Drives
P.O. Box 184
FI-00381 HELSINKI
FINLAND
Tel +358 10 22 11
Fax +358 10 22 22681
Internet www.abb.com

ABB Limited

Daresbury Park
Daresbury
Warrington
Cheshire
WA4 4BT
UNITED KINGDOM
Tel +44 1925 741 111
Fax +44 1925 741 693

ABB Inc.

Automation Technologies
Drives & Motors
16250 West Glendale Drive
New Berlin, WI 53151
USA
Tel +1 262 785-3200
+1 800-HELP-365
Fax +1 262 785-0397

ABB Beijing Drive Systems Co. Ltd.

No. 1, Block D, A-10 Jiuxianqiao Beilu
Chaoyang District
Beijing, P.R. China, 100015
Tel +86 10 5821 7788
Fax +86 10 5821 7618
Internet www.abb.com