

# AF38-22-00-.. / AF38Z-22-00-.. 4-pole Contactors AC / DC Operated - with Screw Terminals

AF38(Z) contactors are used for controlling power circuits up to 690 V AC and 440 V DC. They are mainly used for controlling non-inductive or slightly inductive loads (i.e. resistance furnaces...).

- AF..(Z) contactors include an electronic coil interface providing reduced pull-in and holding consumption, particularly for AC control circuits
- Only four coils are needed to cover control voltages between 24...500 V 50/60 Hz or 20...500 V DC.
- AF..(Z) offer extended operating limits and are suitable worldwide for different control voltages. e.g.: the coil 100...250 V 50/60 Hz - DC is suitable for Europe (230 V 50 Hz) and for North America (120 V 60 Hz and 208 V 60 Hz).
- AF..(Z) contactors can manage large control voltage variations.
- AF.Z contactors equipped with a 24...60 V 50/60 Hz - 20...60 V DC coil allow direct control by 24 V DC 500 mA PLC-output
- AF.Z contactors withstand short voltage dips and voltage sags (SEMI F47-0706 compliance)
- AF..(Z) contactors have built-in surge protection and do not require additional surge suppressors.



		55 A	
--	--	------	--

3D CAD outline drawings available on «Control Product 3D» portal

### Ordering Details

IEC	UL/CSA	Control voltage	Auxiliary contacts	Type	Order code	EAN	Weight
AC-1 Rated current	General use rating	Uc min. ... Uc max.	fitted				
$\theta \leq 40\text{ }^{\circ}\text{C}$ A	600 V AC A	V 50/60 Hz ; V DC					Pack <sup>(ing)</sup> 1 piece kg

### 4-pole Contactors 2 N.O. + 2 N.C. Main Poles

IEC	UL/CSA	Control voltage	Auxiliary contacts	Type	Order code	EAN	Weight
55	55	24...60	0 0	AF38-22-00-11	1SBL 297 501 R1100	3471523116511	0.360
		48...130	0 0	AF38-22-00-12	1SBL 297 501 R1200	3471523116528	0.360
		100...250	0 0	AF38-22-00-13	1SBL 297 501 R1300	3471523116535	0.360
		250...500	0 0	AF38-22-00-14	1SBL 297 501 R1400	3471523116542	0.400

Note: AF38-22-00-11 not suitable for a direct control by PLC-output. AF38-22-00-11 available in some countries: please consult your ABB representative.

### 4-pole Contactors 2 N.O. + 2 N.C. Main Poles - Low Consumption

IEC	UL/CSA	Control voltage	Auxiliary contacts	Type	Order code	EAN	Weight
55	55	-	0 0	AF38Z-22-00-20	1SBL 296 501 R2000	3471523116900	0.400
		24...60	0 0	AF38Z-22-00-21	1SBL 296 501 R2100	3471523116917	0.400
		48...130	0 0	AF38Z-22-00-22	1SBL 296 501 R2200	3471523116924	0.400
		100...250	0 0	AF38Z-22-00-23	1SBL 296 501 R2300	3471523116931	0.400

Note: Only AF..Z contactors with DC control voltage 12...20 V DC need to respect the connection polarities indicated close to the coil terminals: A1+ for the positive pole and A2- for the negative pole

### Certifications and Approvals

--	--	--	--	--	--	--	--	--	--

## Main Pole - Utilization Characteristics according to IEC

<b>Standards</b>	IEC 60947-1 / 60947-4-1 and EN 60947-1 / 60947-4-1	
<b>Rated operational voltage Ue max.</b>	690 V	
<b>Rated frequency limits</b>	25 ... 400 Hz	
<b>Conventional free-air thermal current Ith</b>	55 A	
acc. to IEC 60947-4-1, open contactors, $\theta \leq 40^\circ\text{C}$		
with conductor cross-sectional area	16 mm <sup>2</sup>	
<b>AC-1 Utilization category</b>		
for air temperature close to contactor		
<b>Ie / AC-1 rated operational current</b>	$\theta \leq 40^\circ\text{C}$	55 A
<b>Ue max. <math>\leq 690\text{ V}</math>, 50/60 Hz</b>	$\theta \leq 60^\circ\text{C}$	45 A
	$\theta \leq 70^\circ\text{C}$	37 A
with conductor cross-sectional area	16 mm <sup>2</sup>	
<b>Short-circuit protection</b>		
for contactors without thermal O/L relay - Motor protection excluded		
Ue $\leq 500\text{ V AC}$ - gG type fuse	63 A	
<b>Rated short-time withstand current Icw</b>	<b>1 s</b>	450 A
at 40 °C ambient temperature, in free air from a cold state	<b>10 s</b>	300 A
	<b>30 s</b>	225 A
	<b>1 min</b>	150 A
	<b>15 min</b>	55 A
<b>Heat dissipation per pole</b>	<b>Ie / AC-1</b>	2.3 W
<b>Max. electrical switching frequency</b>	<b>AC-1</b>	600 cycles/h

## Main Pole - Utilization Characteristics according to UL / CSA

<b>Standards</b>	UL 508, CSA C22.2 N°14	
<b>Rated operational voltage Ue max.</b>	600 V	
<b>UL General use rating</b>		
600 V AC	55 A	
With conductor cross-sectional area	AWG 6	
80 V DC - 1-pole for 4 N.O. main poles		
With conductor cross-sectional area		
80 V DC - 1-pole for 2 N.O. / 2 N.C. main poles	55 A	
With conductor cross-sectional area	AWG 6	
<b>Max. electrical switching frequency</b>		
for general use	600 cycles/h	

### Remark for 4-pole contactors fitted with 2 N.O. + 2 N.C. main poles

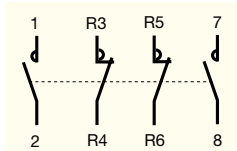

These contactors are suitable for controlling 2 separate circuits, i.e. 2 loads with 2 separate supplies, or 1 circuit comprising 2 separate loads with a single supply (see diagrams below). When the contactor operates there is no mechanical overlapping between the N.O. poles and the N.C. poles: BREAK before MAKE.



These contactors are not suitable for a reversing starter or for controlling a single load from 2 separate supplies.

### Block diagrams

- Single supply and 2 separate loads

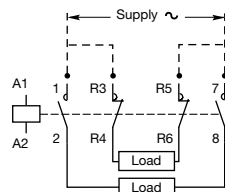

- 2 separate supplies and 2 separate loads

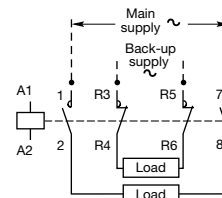

## General Technical Data

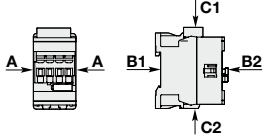
<b>Rated insulation voltage <math>U_i</math></b>	acc. to IEC 60947-4-1	690 V
	acc. to UL	600 V
<b>Rated impulse withstand voltage <math>U_{imp}</math></b>		6 kV
<b>Electromagnetic compatibility</b>		Devices complying with IEC 60947-1 / EN 60947-1 - Environment A
<b>Ambient air temperature</b> close to contactor		
Operation in free air		-40 ... +70 °C
Storage		-60 ... +80 °C
<b>Climatic withstand</b>		Category B according to IEC 60947-1 Annex Q
<b>Operating altitude</b>		≤ 3000 m
<b>Mechanical durability</b>		
Number of operating cycles		10 millions operating cycles
Max. switching frequency		3600 cycles/h
<b>Shock withstand</b> acc. IEC 60068-2-27 and EN 60068-2-27		
Mounting position 1		
	<b>Shock direction</b>	1/2 sinusoidal shock for 11 ms: no change in contact position
	<b>A</b>	30 g Closed position / 25 g Open position
	<b>B1</b>	25 g Closed position / 5 g Open position
	<b>B2</b>	15 g Closed position / 10 g Open position
	<b>C1</b>	25 g Closed position / 20 g Open position
	<b>C2</b>	25 g Closed position / 20 g Open position
<b>Vibration withstand</b>		
acc. to IEC 60068-2-6		5 ... 300 Hz 4 g Closed position / 2 g Open position

## Magnet System Characteristics

<b>Coil operating limits</b>		<b>AC supply</b>	at $\theta \leq 60$ °C 0.85 x $U_c$ min ... 1.1 x $U_c$ max at $\theta \leq 70$ °C 0.85 x $U_c$ min ... $U_c$ max
acc. to IEC 60947-4-1		<b>DC supply</b>	at $\theta \leq 60$ °C 0.85 x $U_c$ min ... 1.1 x $U_c$ max at $\theta \leq 70$ °C (AF) 0.85 x $U_c$ min ... $U_c$ max - (AF..Z) 0.85 x $U_c$ min ... 1.1 x $U_c$ max
<b>AC control voltage</b>	Rated control circuit voltage $U_c$		24 ... 500 V AC
50/60 Hz	Coil consumption	<b>Average pull-in value</b>	(AF) 50 VA - (AF..Z) 16 VA
		<b>Average holding value</b>	(AF) 2.2 VA / 2 W - (AF..Z) 1.7 VA / 1.5 W
<b>DC control voltage</b>	Rated control circuit voltage $U_c$		12 ... 500 V DC
	Coil consumption	<b>Average pull-in value</b>	(AF) 50 W - (AF..Z) 12 ... 16 W
		<b>Average holding value</b>	(AF) 2 W - (AF..Z) 1.7 W
<b>PLC-Output control</b>			(AF..Z) ≥ 500 mA 24 V DC
<b>Drop-out voltage in % of <math>U_c</math> min.</b>			≤ 60 % $U_c$ min
<b>Voltage sag immunity</b> according to SEMI F47-0706			(AF..Z) conditions of use on request
<b>Dips withstand</b> (level 0% according to IEC 61000-4-11)			(AF..Z) 22 ms average for $U_c = 24$ ... 250 V 50/60Hz
-20 °C ≤ $\theta$ ≤ +60 °C			
<b>Operating time</b>	between coil energization and:	<b>N.O. contact closing</b>	40 ... 95 ms
		<b>N.C. contact opening</b>	38 ... 90 ms
	between coil de-energization and:	<b>N.O. contact opening</b>	11 ... 95 ms
		<b>N.C. contact closing</b>	13 ... 98 ms

## Mounting Characteristics

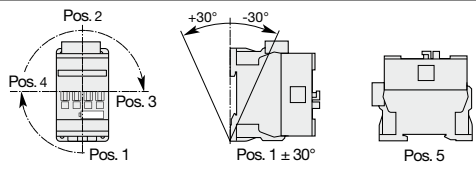
<b>Mounting positions</b>		
		Max. add-on N.C. auxiliary contacts: see accessory fitting details for a 4-pole contactor AF09 ... AF38
<b>Mounting distances</b>		The contactors can be assembled side by side.
<b>Fixing</b>	on rail according to IEC 60715, EN 60715	35 x 7.5 mm or 35 x 15 mm
	by screws (not supplied)	2 x M4 screws placed diagonally





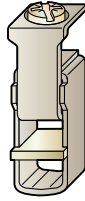









## Connecting Characteristics

### Main terminals





Screw terminals with double connector  
2 x (5.5 width x 6.8 depth)

### Connecting capacity (min. ... max.)

<b>Main conductors (poles)</b>		
 Rigid	solid ( $\leq 4 \text{ mm}^2$ )	1 x : 1.5 ... 16 mm <sup>2</sup>
 Rigid	stranded ( $\geq 6 \text{ mm}^2$ )	2 x : 1.5 ... 16 mm <sup>2</sup>
 Flexible with non insulated ferrule		1 x : 1.5 ... 16 mm <sup>2</sup>
 Flexible with non insulated ferrule		2 x : 1.5 ... 16 mm <sup>2</sup>
 Flexible with insulated ferrule		1 x : 1.5 ... 16 mm <sup>2</sup>
 Flexible with insulated ferrule		2 x : 1.5 ... 16 mm <sup>2</sup>
 Bars or lugs		L < -
Capacity according to UL/CSA		1 or 2 x : AWG 16 ... 6
Stripping length		12 mm
<b>Auxiliary conductors</b>		
 Rigid solid		1 x : 1 ... 2.5 mm <sup>2</sup>
 Rigid solid		2 x : 1 ... 2.5 mm <sup>2</sup>
 Flexible with non insulated ferrule		1 x : 0.75 ... 2.5 mm <sup>2</sup>
 Flexible with non insulated ferrule		2 x : 0.75 ... 2.5 mm <sup>2</sup>
 Flexible with insulated ferrule		1 x : 0.75 ... 2.5 mm <sup>2</sup>
 Flexible with insulated ferrule		2 x : 0.75 ... 1.5 mm <sup>2</sup>
 Bars or lugs		L < 8 mm
Capacity according to UL/CSA		1 or 2 x : AWG 18 ... 14
Stripping length		10 mm
<b>Degree of protection</b>		
acc. to IEC 60947-1 / EN 60947-1 and IEC 60529 / EN 60529		
Main terminals		IP20
Coil terminals		IP20
<b>Screw terminals</b>		(delivered in open position, screws of unused terminals must be tightened)
Main terminals		M4.5
Coil terminals		M3.5
<b>Screwdriver type</b>		Flat Ø 5.5 / Pozidriv 2
<b>Tightening torque</b>		
Main pole terminals		2.5 Nm / 22 lb.in
Coil terminals		1.2 Nm / 11 lb.in

## Accessory Fitting Details for a 4-pole Contactor

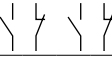
Many configurations of accessories are possible depending on whether these are front-mounted or side-mounted.

Main poles	Built-in auxiliary contacts	Front-mounted accessories				Side-mounted accessories		
		Auxiliary contact blocks			Electrical and mechanical interlock set (between 2 contactors)	Auxiliary contact blocks		
		1-pole CA4						
		1-pole CC4	2-pole CAT4-11	4-pole CA4	VEM4	Left side 2-pole CAL4-11	Right side	
Max. add-on N.C. auxiliary contacts: 3 N.C. max. on positions 1, 2, 3, 4 and 2 N.C. max. on positions 1 ±30°, 5								
2	2	0	0					
		4 max.	or 1	or 1	–	+	1	–
		2 max.	or 1	–	–	+	1	+ 1

## Overview of main accessories (other accessories available)

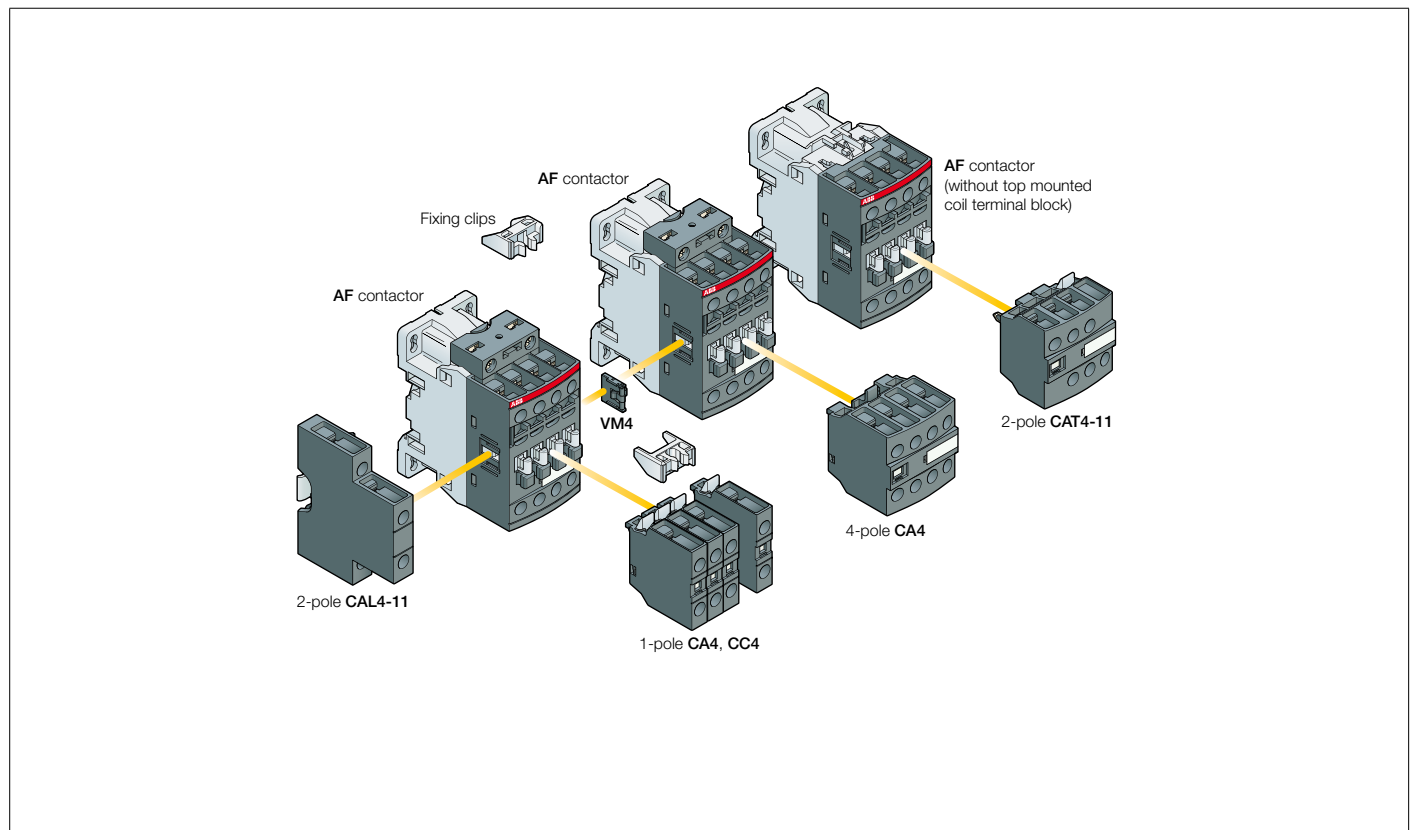

## Main Accessories

### Ordering Details

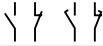
Description	Auxiliary contacts 	Type	Order code	EAN	Pack <sup>(ing)</sup> piece	Weight	
						kg <small>(1 pce)</small>	
Additional auxiliary contact blocks	Front-mounted instantaneous auxiliary contact blocks	0 1 - -	CA4-01	1SBN 010 110 R1001	3471523130029	1	0.014
		1 0 - -	CA4-10	1SBN 010 110 R1010	3471523130005	1	0.014
		0 1 - -	CA4-01-T	1SBN 010 110 T1001	3471523130395	10	0.014
		1 0 - -	CA4-10-T	1SBN 010 110 T1010	3471523130371	10	0.014
	Front-mounted auxiliary contact blocks with N.O. leading contact and N.C. lagging contact	- - 0 1	CC4-01	1SBN 010 111 R1001	3471523130432	1	0.014
		- - 1 0	CC4-10	1SBN 010 111 R1010	3471523130425	1	0.014
	Side-mounted instantaneous auxiliary contact blocks	1 1 - -	CAL4-11	1SBN 010 120 R1011	3471523130043	1	0.040
		1 1 - -	CAL4-11-T	1SBN 010 120 T1011	3471523130418	10	0.040
	Front-mounted instantaneous auxiliary contact blocks	2 2 - -	CA4-22E	1SBN 010 140 R1022	3471523130128	1	0.055
		3 1 - -	CA4-31E	1SBN 010 140 R1031	3471523130135	1	0.055
	4 0 - -	CA4-40E	1SBN 010 140 R1040	3471523130142	1	0.055	
Front-mounted instantaneous auxiliary contact and A1/A2 coil terminal blocks	1 1 - -	CAT4-11E	1SBN 010 151 R1011	3471523130067	1	0.040	
Additional coil terminal block		LDC4	1SBN 070 156 T1000	3471523130678	10	0.010	
Protective covers	Protective covers		BX4	1SBN 110 108 T1000	3471523130708	10	0.006
			BX4-CA	1SBN 110 109 W1000	3471523130715	50	0.001
Function markers	Function markers		BA4	1SNA 235 156 R2700	3472592351568	16	0.011
			HTP500-BA4	1SNA 235 712 R2400	3472592357126	1	0.220
			SPRC 1	1SNA 360 010 R1500	3472593600108	1	0.290

Note: CAT4 not fittable on AF..Z contactors with DC control voltage 12...20VDC.

## Terminal Marking and Positioning

Standard devices without addition of auxiliary contacts

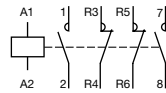
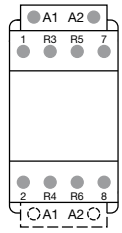

AF38-22-00-.. / AF38Z-22-00-..

AF38-22-00-.. / AF38Z-22-00-..

## Dimensions mm, inches

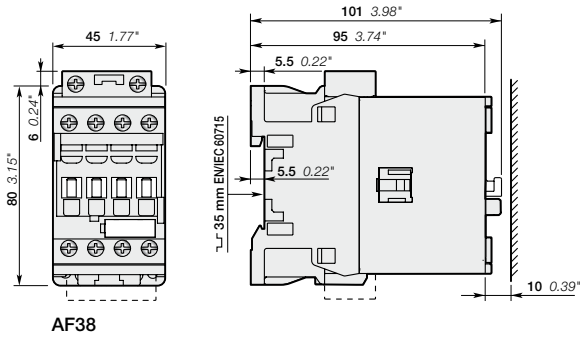

AF38

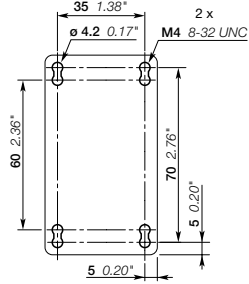

AF38

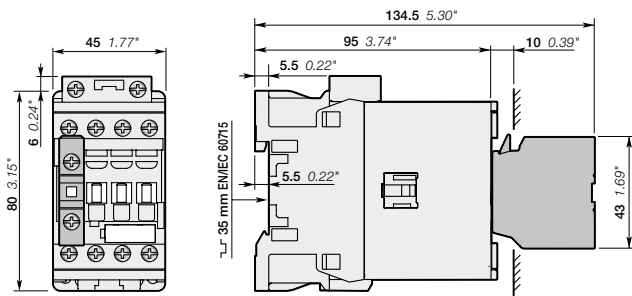

AF38  
+ CA4, CC4 1-pole auxiliary contact block

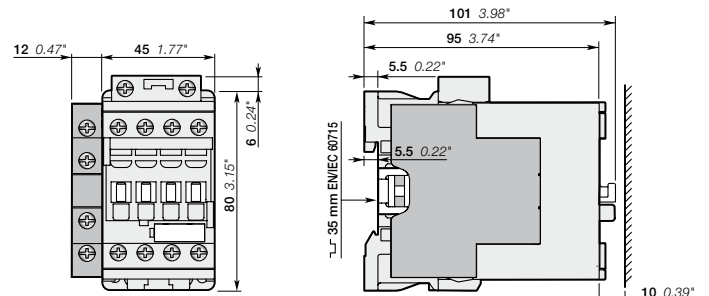

AF38  
+ CAL4-11 2-pole auxiliary contact block

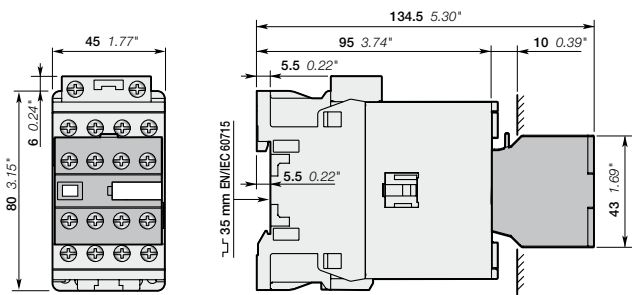

AF38  
+ CA4 4-pole auxiliary contact block

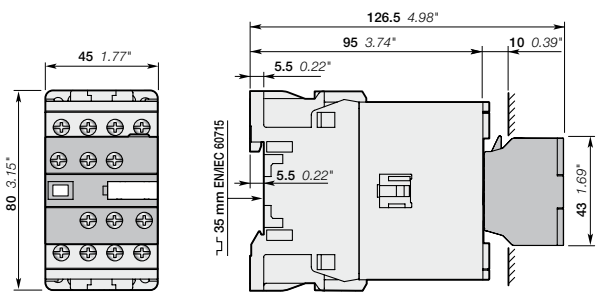

AF38  
+ CAT4 2-pole auxiliary contact and coil terminal block

Note: contactor lateral distance to grounded component 2 mm 0.08" min.

# Contact us

## **ABB France**

### **Low Voltage Products Division**

10, rue Ampère Z.I. - B.P. 114  
F-69685 Chassieu cedex / France

You can find the address of your local sales organisation  
on the ABB home page  
<http://www.abb.com/contacts> -> Low Voltage products

## **Note**

We reserve the right to make technical changes or modify the contents of this document without prior notice. With regard to purchase orders, the agreed particulars shall prevail. ABB does not accept any responsibility whatsoever for potential errors or possible lack of information in this document.

We reserve all rights in this document and in the subject matter and illustrations contained therein. Any reproduction, disclosure to third parties or utilization of its contents – in whole or in parts – is forbidden without prior written consent of ABB.

Copyright© 2011 ABB  
All rights reserved