

# Overcurrent Relay REJ 523

## Operator's Manual





## Contents

<b>1. About this manual .....</b>	<b>5</b>
1.1. Copyrights .....	5
1.2. Trademarks .....	5
1.3. Guarantee .....	5
1.4. General .....	5
1.5. Use of symbols .....	6
1.6. Terminology .....	6
1.7. Related documents .....	6
1.8. Document revisions .....	6
<b>2. Safety Information .....</b>	<b>7</b>
<b>3. Introduction .....</b>	<b>9</b>
3.1. Use of the relay .....	9
3.2. Features .....	9
<b>4. Instructions .....</b>	<b>11</b>
4.1. HMI features .....	11
4.1.1. Front panel .....	11
4.1.2. Display .....	12
4.1.2.1. Display test at power up .....	12
4.1.2.2. Display idle mode .....	12
4.1.2.3. Display backlight .....	12
4.1.2.4. How to adjust the display contrast .....	13
4.1.3. How to use the push-buttons .....	13
4.1.4. How to select language .....	14
4.1.5. Main menu .....	15
4.1.6. Submenu .....	15
4.1.7. How to switch between the front and the rear connector ..	16
4.1.8. Passwords .....	16
4.2. HMI operation levels .....	17
4.2.1. Main level .....	17
4.2.2. User level .....	17
4.2.2.1. Menu groups of the user level .....	17
4.2.2.2. How to monitor measured values .....	17
4.2.2.3. How to monitor recorded data .....	18
4.2.2.4. INFO .....	19
4.2.3. Technical level .....	19
4.2.3.1. Menu system of parameters .....	19
4.2.3.2. How to change settings .....	20
4.2.3.3. Configuration .....	21

---

4.2.3.4. How to acknowledge and reset indications, output contacts and memorized values .....	22
4.2.4. Menu chart .....	23
4.3. Protection relay indications .....	24
4.3.1. Indicator LEDs .....	24
4.3.1.1. Green indicator LED .....	24
4.3.1.2. Yellow indicator LED .....	25
4.3.1.3. Red indicator LED .....	25
4.3.2. Indication messages .....	26
4.3.2.1. Alarm indication messages .....	26
4.3.2.2. Disturbance recorder indication .....	26
4.3.2.3. Internal fault .....	27
<b>5. Service .....</b>	<b>29</b>
5.1. General .....	29
5.2. Commissioning testing .....	29
5.2.1. Function test .....	29
5.2.2. Binary input test .....	30
5.2.3. LED test .....	30
5.3. Secondary injection testing .....	30
5.3.1. Testing of the overcurrent measuring transformers .....	32
5.3.2. Testing of the overcurrent stages .....	32
5.3.2.1. Low-set stage I> .....	32
5.3.2.2. High-set stage I>> .....	32
5.3.3. Testing of the self-supervision system (IRF) .....	33
5.4. Spare parts .....	33
<b>6. Ordering information .....</b>	<b>35</b>
<b>7. Abbreviations .....</b>	<b>37</b>
<b>8. Index .....</b>	<b>39</b>

## **1. About this manual**

### **1.1. Copyrights**

The information in this document is subject to change without notice and should not be construed as a commitment by ABB Oy. ABB Oy assumes no responsibility for any errors that may appear in this document.

In no event shall ABB Oy be liable for direct, indirect, special, incidental or consequential damages of any nature or kind arising from the use of this document, nor shall ABB Oy be liable for incidental or consequential damages arising from use of any software or hardware described in this document.

This document and parts thereof must not be reproduced or copied without written permission from ABB Oy, and the contents thereof must not be imparted to a third party nor used for any unauthorized purpose.

The software or hardware described in this document is furnished under a license and may be used, copied, or disclosed only in accordance with the terms of such license.

Copyright © 2005 ABB Oy  
All rights reserved.

### **1.2. Trademarks**

ABB is a registered trademark of ABB Group.

All other brand or product names mentioned in this document may be trademarks or registered trademarks of their respective holders.

### **1.3. Guarantee**

Please inquire about the terms of guarantee from your nearest ABB representative.

### **1.4. General**

This manual provides the user with basic information on the overcurrent relay REJ 523 and presents detailed instructions on how to use the Human-Machine Interface (HMI) of the relay, also known as the Man-Machine Interface (MMI). In addition to the instructive part, a short chapter on the service of the relay has been included.

## 1.5. Use of symbols

This document includes warning, caution, and information icons that point out safety-related conditions or other important information. The corresponding icons should be interpreted as follows:



The electrical warning icon indicates the presence of a hazard which could result in electrical shock.



The caution icon indicates important information or warning related to the concept discussed in the text. It might indicate the presence of a hazard which could result in corruption of software or damage to equipment or property.



The information icon alerts the reader to relevant facts and conditions.

Although warning hazards are related to personal injury, and caution hazards are associated with equipment or property damage, it should be understood that operation of damaged equipment could, under certain operational conditions, result in degraded process performance leading to personal injury or death. Therefore, comply fully with all warning and caution notices.

## 1.6. Terminology

The following is a list of terms that you should be familiar with. The list contains terms that are unique to ABB or have a usage or definition that is different from standard industry usage.

Term	Description
IEC_103	IEC 60870-5-103, a communication protocol standardized by the International Electrotechnical Commission
SPA	A data communication protocol developed by ABB



## 1.7. Related documents

Name of the manual	MRS number
REJ 523 Technical Reference Manual	1MRS750940-MUM
RE_5__ Installation Manual	1MRS750526-MUM

## 1.8. Document revisions

Version	Date	History
C	15.08.2002	
D	14.11.2005	Relay face plate updated. Manual layout updated.

## 2. Safety Information

	Dangerous voltages can occur on the connectors, even though the auxiliary voltage has been disconnected.
	Non-observance can result in death, personal injury or substantial property damage.
	Only a competent electrician is allowed to carry out the electrical installation.
	National and local electrical safety regulations must always be followed.
	The frame of the device has to be carefully earthed.
	The device contains components which are sensitive to electrostatic discharge. Unnecessary touching of electronic components must therefore be avoided.
	Breaking the sealing tape on the rear panel of the device will result in loss of warranty and proper operation will no longer be guaranteed.





## 3. Introduction

### 3.1. Use of the relay

The REJ 523 is intended for three-phase overcurrent protection in medium voltage distribution networks but can also be used for protection of generators, motors and transformers.

The REJ 523 can also be used in applications requiring single- or two-phase overcurrent protection.

The REJ 523 is based on a microprocessor environment. A self-supervision system continuously monitors the operation of the electronics and the software.

The HMI includes a Liquid Crystal Display (LCD) which makes the local use of the relay safe and easy.

Local control of the relay can be carried out using a portable computer connected to the front connector and remote control via the rear connector connected to the distribution automation system through the serial interface and the fibre-optic bus.

### 3.2. Features

- Three-phase low-set overcurrent stage with definite-time or inverse definite minimum time (IDMT) characteristic
- Three-phase high-set overcurrent stage with instantaneous or definite-time characteristic
- Circuit-breaker failure protection unit (CBFP)
- Disturbance recorder
  - recording time up to 12 seconds
  - triggering by a start or a trip signal from either of the two protection stages and/or by a binary input signal
  - records three analogue channels and five digital channels
  - adjustable sampling rate
- Non-volatile memory for
  - up to 60 event codes
  - setting values
  - disturbance recorder data
  - recorded data of the five last events with time stamp
  - number of starts for each stage
  - alarm indication messages and LEDs showing the status at the moment of power failure
- Three accurate current inputs
- Galvanically isolated binary input with a wide input voltage range
- All settings can be modified with a personal computer
- HMI with an alphanumeric LCD and manoeuvring buttons
- IEC 60870-5-103 and SPA bus communication protocols

Operator's Manual

---

- Two normally open power output contacts
- Two change-over signal output contacts
- Output contact functions freely configurable for desired operation
- Optical PC-connector for two-way data communication (front)
- RS-485 connector (rear) for system communication
- Continuous self-supervision of electronics and software. At an internal relay fault (IRF), all protection stages and outputs are blocked.
- User-selectable rated frequency 50/60 Hz
- User-selectable password protection for the HMI
- Display of primary current values
- Multi-language support

## 4. Instructions

### 4.1. HMI features

#### 4.1.1. Front panel

The front panel of the protection relay includes:

- an alphanumeric 2 x 16 characters' LCD with backlight and contrast control
- three indicator LEDs (ready, start, trip)
- an HMI push-button section with four arrow buttons and buttons for clear and enter
- an optically isolated serial communication port

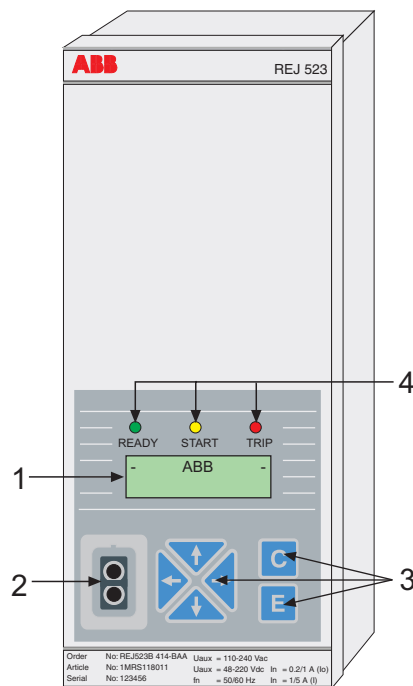

A051386

Fig. 4.1.1.-1 Front view of the relay

1. LCD
2. Optical PC-connector
3. HMI push-button section
4. Indicator LEDs:
  - Left: Ready (green)
  - Centre: Start (yellow)
  - Right: Trip (red)

## 4.1.2. Display

### 4.1.2.1. Display test at power up

When the auxiliary voltage is connected to the relay:

1. The backlight will be turned on after the relay has performed the internal power-up tests and entered into the protection mode.
2. The display will be tested by inverting it for a short time.
3. The display will be returned to the idle mode and the backlight turned off. However, if the non-volatile function is active, a message shown on the display before the auxiliary voltage was disconnected will reappear on the display.

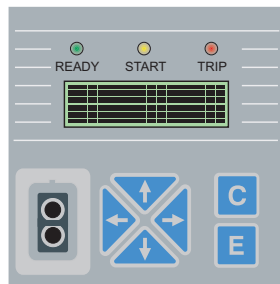

A051304

Fig. 4.1.2.1.-1 Display test at power up

### 4.1.2.2. Display idle mode

When the relay is in idle mode, the station name, which by default is “- ABB -” will be displayed. To change the station name, use SPA parameter M20.

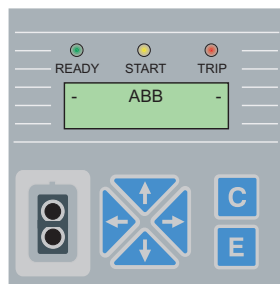

A051305

Fig. 4.1.2.2.-1 Display in idle mode

### 4.1.2.3. Display backlight

- Normally the backlight of the display is off.
- The backlight is turned on at the touch of an arrow button on the HMI. If the HMI panel has not been used for approximately five minutes, the backlight will be turned off automatically.
- A power saving built-in feature: pressing the [C] button will turn the backlight off within 20 seconds.

#### 4.1.2.4. How to adjust the display contrast

The display contrast is dependent on the temperature. The REJ 523 automatically adjusts the contrast for optimum readability. The contrast can also be adjusted manually. To adjust the contrast, the display must be in the idle mode.

- To increase the contrast, hold down the [E] button and adjust using the [↑] button.
- To decrease the contrast, hold down the [E] button and adjust using the [↓] button.



A051306

Fig. 4.1.2.4.-1 Adjusting the display contrast

After power-start up of the relay, the factory default value of the display contrast will automatically be restored.

#### 4.1.3. How to use the push-buttons

The HMI includes push-buttons for manoeuvring the relay.

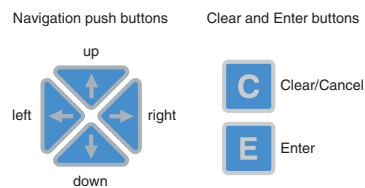

A051307

Fig. 4.1.3.-1 Navigation buttons

The navigation buttons are used to view, select and edit desired menu items. To move between the menu items, use the arrow buttons. The item to be edited is selected and the value stored by pressing the [E] button. To increase or decrease the activated digit and to shift the activated decimal point, use the [↑] and [↓] buttons. To cancel and return the HMI to the idle mode, press the [C] button..

Table 4.1.3-1 Button navigation and editing

Desired step or operation	Push-button
Step downward in the main menu or a submenu	↓
Step upward in the main menu or a submenu	↑
Entering a submenu from the main menu or a higher submenu	→
Leaving a submenu for the main menu or a higher submenu	←
Increasing a value in the setting mode	↑
Decreasing a value in the setting mode	↓
Moving the cursor in the setting mode	← or →
Selecting the front connection at power up	← and →
Entering or leaving the setting mode, storing a new value	E
Entering the monitoring state	E and ←

**Table 4.1.3-1 Button navigation and editing (Continued)**

Desired step or operation	Push-button
Adjusting the display contrast	E and ↓ or ↑
Resetting or cancelling, leaving the setting mode without storing a new value	C
Acknowledging and resetting indications, output contacts and memorized values	E and C

#### 4.1.4. How to select language

REJ 523 allows you to choose among several different languages. The default language is English. For selectable languages, see the picture below.

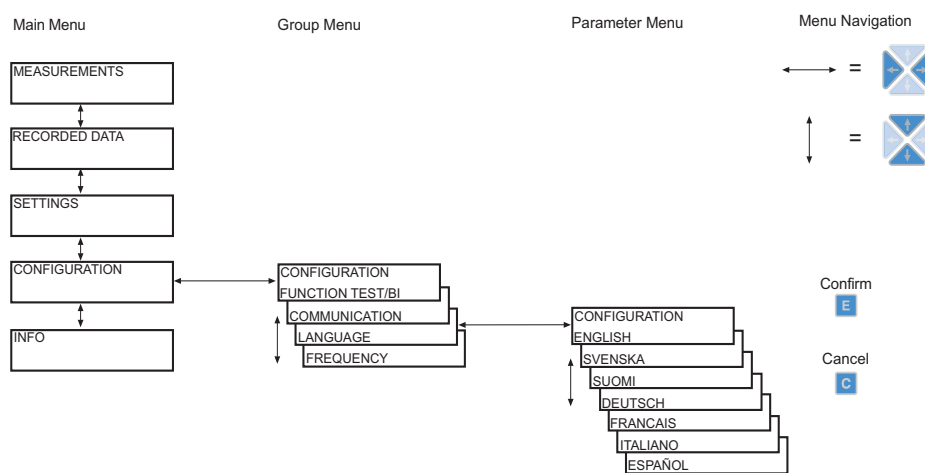

A051308

*Fig. 4.1.4.-1 Selection of language*

1. Press an arrow button to access the main menu.
2. Select “CONFIGURATION” in the main menu and “LANGUAGE” in the group menu.
3. Press the [→] button to enter the currently valid language.
4. Press the [E] button. The second line will start to flash indicating that it is allowed to set the language. A password will be required depending on the state of the password protection.
5. Move the cursor to the desired language and confirm the selection by pressing the [E] button. The selected language is shown on the display.
6. Press the [C] button to return the HMI to the idle mode.

By pressing the [C] button before confirming the selection, the former language will remain active and the display will be returned to the view mode. Pressing the [C] button again will return the display to the idle mode.

#### 4.1.5. Main menu

The main menu contains five main groups:

- MEASUREMENTS
- RECORDED DATA
- SETTINGS
- CONFIGURATION
- INFO

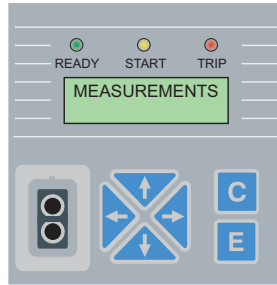

A051309

Fig. 4.1.5.-1 The display showing the first main menu group

- To navigate between the main menu groups, use the [↑] and [↓] buttons.
- To return the display to idle mode, press the [C] button.

The display will be returned to idle mode on expiration of the timeout.

#### 4.1.6. Submenu

The menu structure contains several subgroups. The name of the main menu group is always shown on the first line. On the second line either the name of the group menu, the name of the parameter and the parameter value, or just the parameter value, in which case it is also the name of the parameter, is shown.

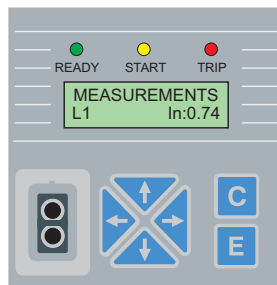

A051368

Fig. 4.1.6.-1 The display showing the first submenu

- To enter a submenu, press the [→] button; to exit, press the [←] button.
- Press the [C] button to return the display to idle mode.
- To navigate between the main levels in the submenus, use the [↑] or [↓] button.

**4.1.7. How to switch between the front and the rear connector**

The relay is provided with two serial connectors: rear connector RS-485 and the front optical PC-connector, of which the former is the default connector. To switch between the front and the rear connector, use the Front/Rear selector of the HMI:

1. Select “COMMUNICATION” under the main menu group “CONFIGURATION”.
2. Move the cursor to the currently used setting (“REAR CONNECTION/FRONT CONNECTION”) and press the [E] button. The lower line will start to flash.
3. Select the desired setting using the [↑] or [↓] button and press the [E] button to confirm the selection.

When the front connection has been selected but there has not been any communication for approximately five minutes, the rear connection will automatically be activated. To disable this function, press the [←] and [→] buttons simultaneously when applying the auxiliary voltage to the relay.

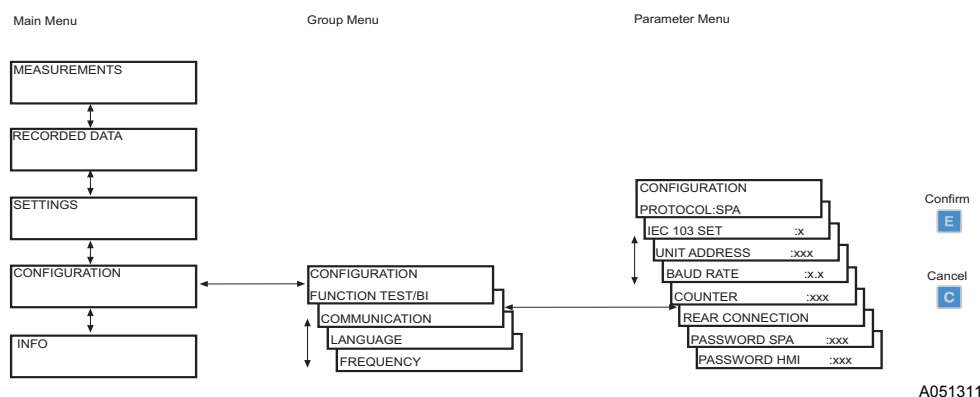

Fig. 4.1.7.-1 Switching between front and rear connection

**4.1.8. Passwords**

There are two passwords: one for the HMI and one for SPA bus communication.

The HMI password protects all user-changeable values from being changed by an unauthorized person. The HMI password protection function will remain inactive until the default password has been replaced. The default HMI password is “999” and the default SPA password “001”.

The passwords can be changed but not read from a remote unit. The SPA password can be changed via the serial bus by first entering the currently valid password into parameter V160 and then entering the new password into parameter V161. The HMI password is changed via parameter V162. For changing the passwords via the HMI, see also section Configuration.

As soon as the default HMI password has been replaced, the password will be required for altering parameter values. Once the valid password has been given, the HMI will remain in the setting mode until returned to the idle mode.



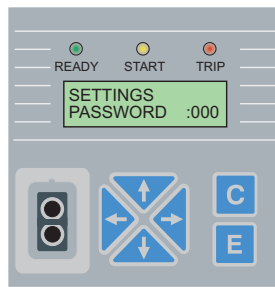

A051312

Fig. 4.1.8.-1 Password request for editing setting parameters

## 4.2. HMI operation levels

### 4.2.1. Main level

The main level of the HMI consists of a user and a technical level. The user level is used for measuring and monitoring whereas the technical level is used for advanced protection relay setting and can be configured to demand a password. The password will be required after the default value “999” has been replaced.

### 4.2.2. User level

#### 4.2.2.1. Menu groups of the user level

The user level contains three menu groups:

- MEASUREMENTS = monitors measured values
- RECORDED DATA = stored alarm event values from the protection stages
- INFO = information on the relay, e.g. relay name, serial number

Data of every menu group can be monitored without a password.

#### 4.2.2.2. How to monitor measured values

Measured values can be monitored either via “MEASUREMENTS” in the HMI menu or by activating the monitoring state.

To access measured values via the HMI menu:

1. Press the [→] button in the main menu group “MEASUREMENTS” to see the measured value on phase L1.
2. Use the [↑] and [↓] buttons to monitor the other measured values. Measured line currents on phases L1, L2 and L3 are shown as multiples of the rated current,  $I_n$ , of the energizing input.
3. Press the [→] button once more to see the corresponding value in amperes. If the conversion factors have not been set, dashes will be displayed instead.
4. Press the [C] button to return the HMI to the idle mode.

Operator's Manual

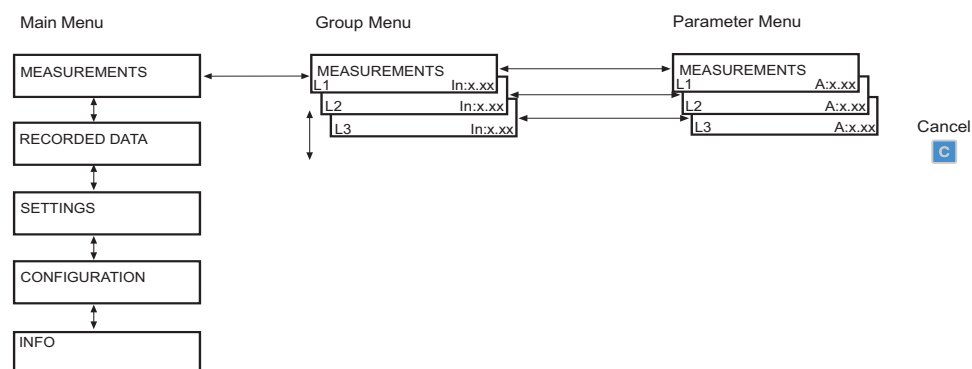

A051369

Fig. 4.2.2.2.-1 Measurements

To access measured values by activating the monitoring state:

1. Press the [E] and [←] buttons simultaneously to view the measured line currents on phases L1, L2 and L3.
2. To exit, press the [C] button.

The display has to be in idle mode to be able to activate the monitoring state.

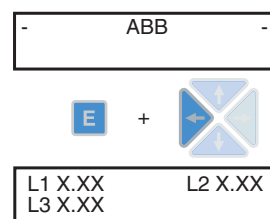

A051370

Fig. 4.2.2.2.-2 Monitoring state

The prerequisite for monitoring primary values is that serial parameter M80 has been set via serial communication.

**4.2.2.3. How to monitor recorded data**

The contents of the event register are found under the main menu group “RECORDED DATA”.

1. Choose “RECORDED DATA” in the main menu and press the [→] button to enter the first event.
2. To navigate between the events, use the [↑] and [↓] buttons.
3. To enter or exit a submenu, use the [→] or [←] button.
4. To see the maximum pickup value of the phases, use the [→] button.
5. To return the HMI to the idle mode, press the [C] button.

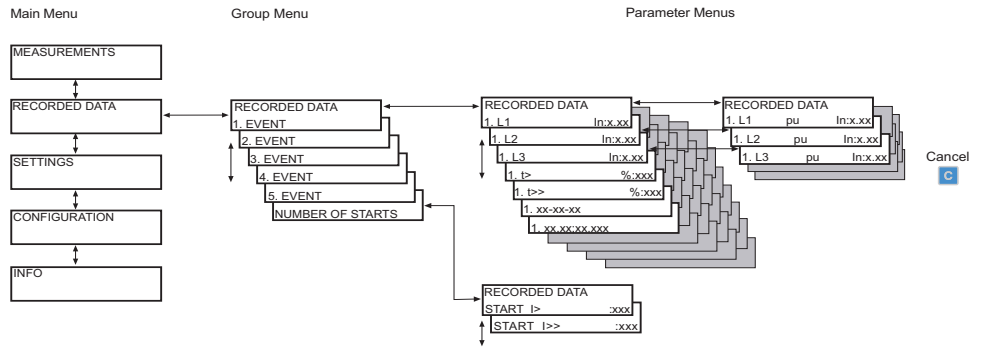

A051371

Fig. 4.2.2.3.-1 Recorded data

4.2.2.4.

INFO

The main menu group “INFO” contains information about the relay, such as type, software, article and serial numbers. Use this data when you need to order service, for instance. The submenu found under the software number displays the additional build number.

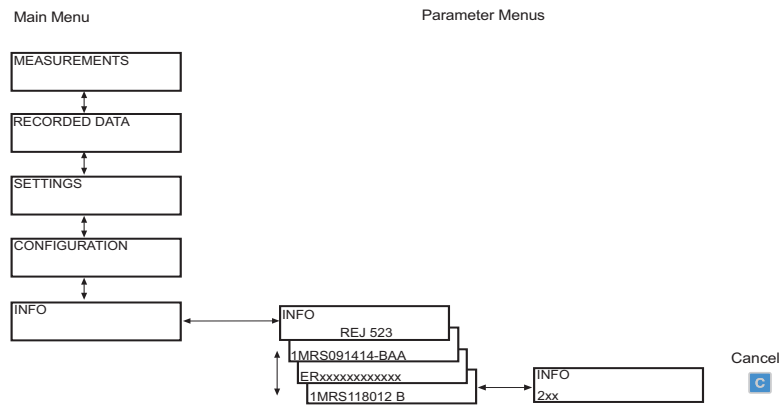

A051372

Fig. 4.2.2.4.-1 INFO

4.2.3.

Technical level

4.2.3.1.

Menu system of parameters

The interactive communication between the operator and the HMI is based on menus. Press an arrow button to activate the main menu. If the default password is in use, no password will be required to change the parameters. If the password protection is in use, “\*\*\*” will be shown on the display until the valid HMI password has been given.

The views are used for reading setting parameters, measured values, etc. The parameters are divided into two main groups:

- SETTINGS
- CONFIGURATION

## 4.2.3.2.

**How to change settings**

The actual settings are found in the first submenu and are not editable. These in turn consist of the settings of either group 1 or 2, depending on which one has been selected to be active. The settings of groups 1 and 2 can be edited in the setting mode; refer to the instructions later in this section.

Both setting groups have their related registers. By switching between setting groups 1 and 2, a whole group of settings can be changed at the same time. You can switch between these setting groups in three different ways:

1. by selecting “GROUP 1/GROUP 2” under the main menu group “SETTINGS”.
2. with a binary input signal, provided that SGB1/4 has been set to 1.
3. with parameter V150 via the serial communication bus.

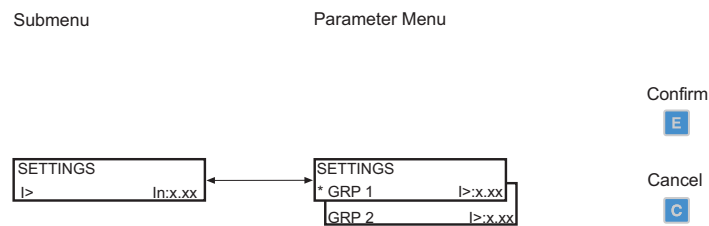

A051373

*Fig. 4.2.3.2.-1 Setting group 1/setting group 2*

When a large number of settings are to be altered, e.g. during commissioning of the relay systems, it is recommended that a personal computer provided with the necessary software should be used. If not available, or when only a few settings are to be altered, proceed as follows:

1. Select the main menu group “SETTINGS” and further “PROTECT.STAGES”. Press the [→] button to enter the first submenu group.
2. Use the arrow button [↓] to select the parameter to be changed and press the [→] button.
3. To enter setting group 2, press the [↓] button. The active setting group is indicated by an asterisk “\*”.
4. Enter the setting mode by pressing the [E] button. If the default password has been replaced, the text “PASSWORD” will appear on the display demanding a password. If the default password “999” is still valid, no password will be required.
5. The first digit of the setting value of the parameter to be edited will start to flash. Use the [→] and [←] buttons to move the cursor and the [↑] and [↓] buttons to increase or decrease the number.
6. To store a new value and return the display to the view mode, press the [E] button. If the parameter is of a numerical kind, the display will confirm the storage by once flashing “---” on the display.
7. To exit the setting mode without saving the changes, press the [C] button once before confirming and the display will be returned to the view mode.
8. Press the [C] button once more and the display will be returned to the idle mode.

Operator's Manual

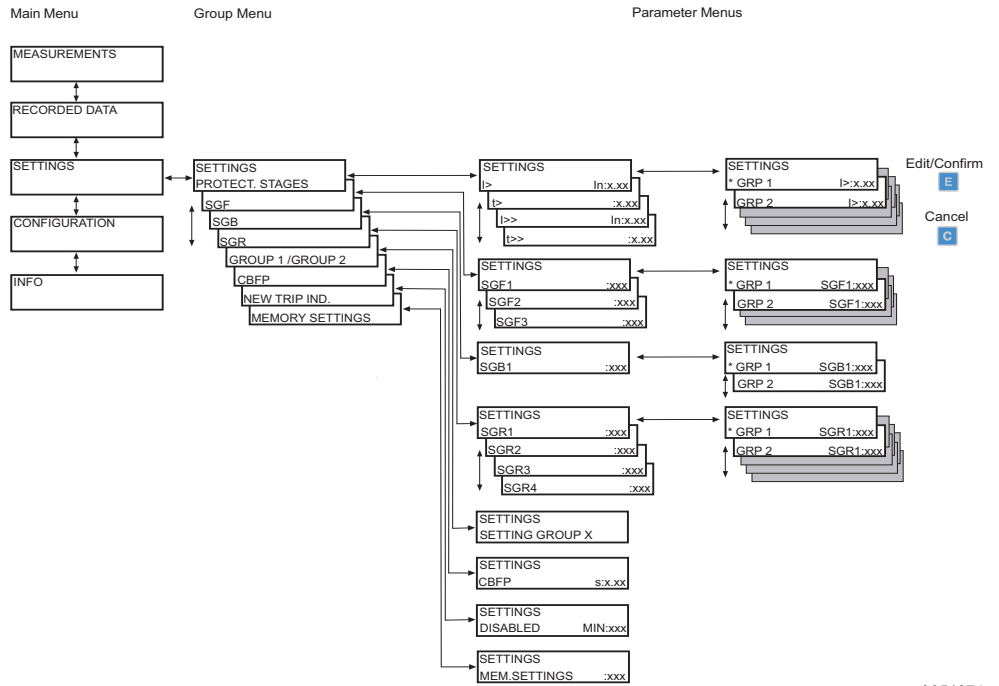

A051374

Fig. 4.2.3.2.-2 Settings

4.2.3.3.

Configuration

In general, the parameters found under “CONFIGURATION” are usually set only once by the customer during commissioning of the relay. These parameters are not related to the protection functions.

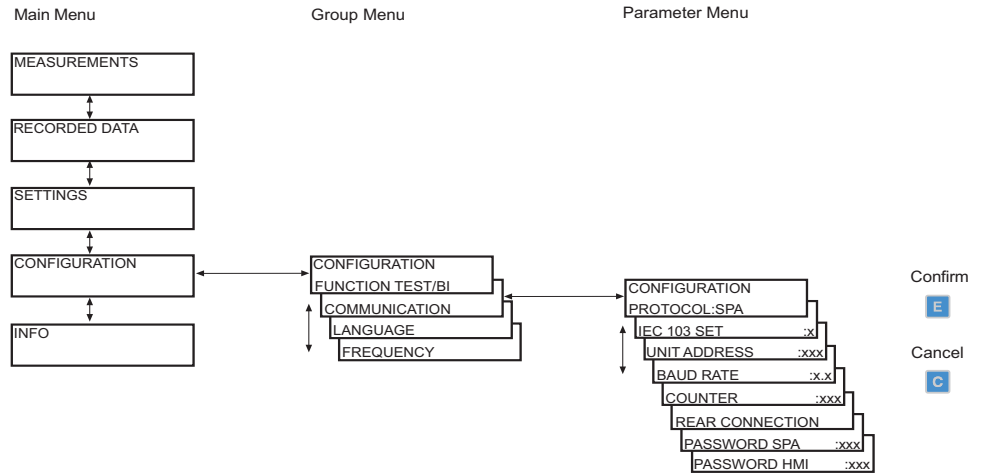

A051319

Fig. 4.2.3.3.-1 Configuration

To alter a parameter, proceed as follows:

1. Select the main menu group “CONFIGURATION” and enter the desired parameter using the arrow buttons.
2. Enter the setting mode by pressing the [E] button. If the default password has been replaced, the text “PASSWORD” will appear on the display demanding a password. If the default password “999” is still valid, no password will be required.
3. The text or the first digit of the setting value of the parameter to be edited will start to flash. Set the digit/character using the [↑] and [↓] buttons. The next digit/character to be set is activated by pressing the [→] or [←] button (when setting an enumerator, however, the left and right arrows have no function).
4. To store a new value and return the display to the view mode, press the [E] button. If the parameter is of a numerical kind, the display will confirm the storage by once flashing “---” on the display.
5. To exit the setting mode without saving changes, press the [C] button once before confirming and the display will be returned to the view mode.
6. Press the [C] button once more and the display will be returned to idle mode.

Parameter Menu

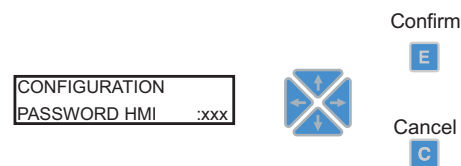

A051320

*Fig. 4.2.3.3.-2 Setting the HMI password*

If a setting value beyond the allowed limits is confirmed in the setting mode, the former value will be restored.

#### 4.2.3.4.

### How to acknowledge and reset indications, output contacts and memorized values

- To clear the LEDs and the display, press the [C] button. The LEDs and the display will be cleared only if the fault situation has disappeared.
- Press the [C] button for at least five seconds to unlatch the output contacts. Note that the LEDs and the display have to be cleared before this.
- Press the [C] and [E] buttons simultaneously for at least half a second to perform a master reset, i.e. to clear indications and memorized values and to unlatch the output contacts. The display being inverted confirms this action. Memorized values include recorded data, disturbance recorder data and average values.

4.2.4.

Menu chart

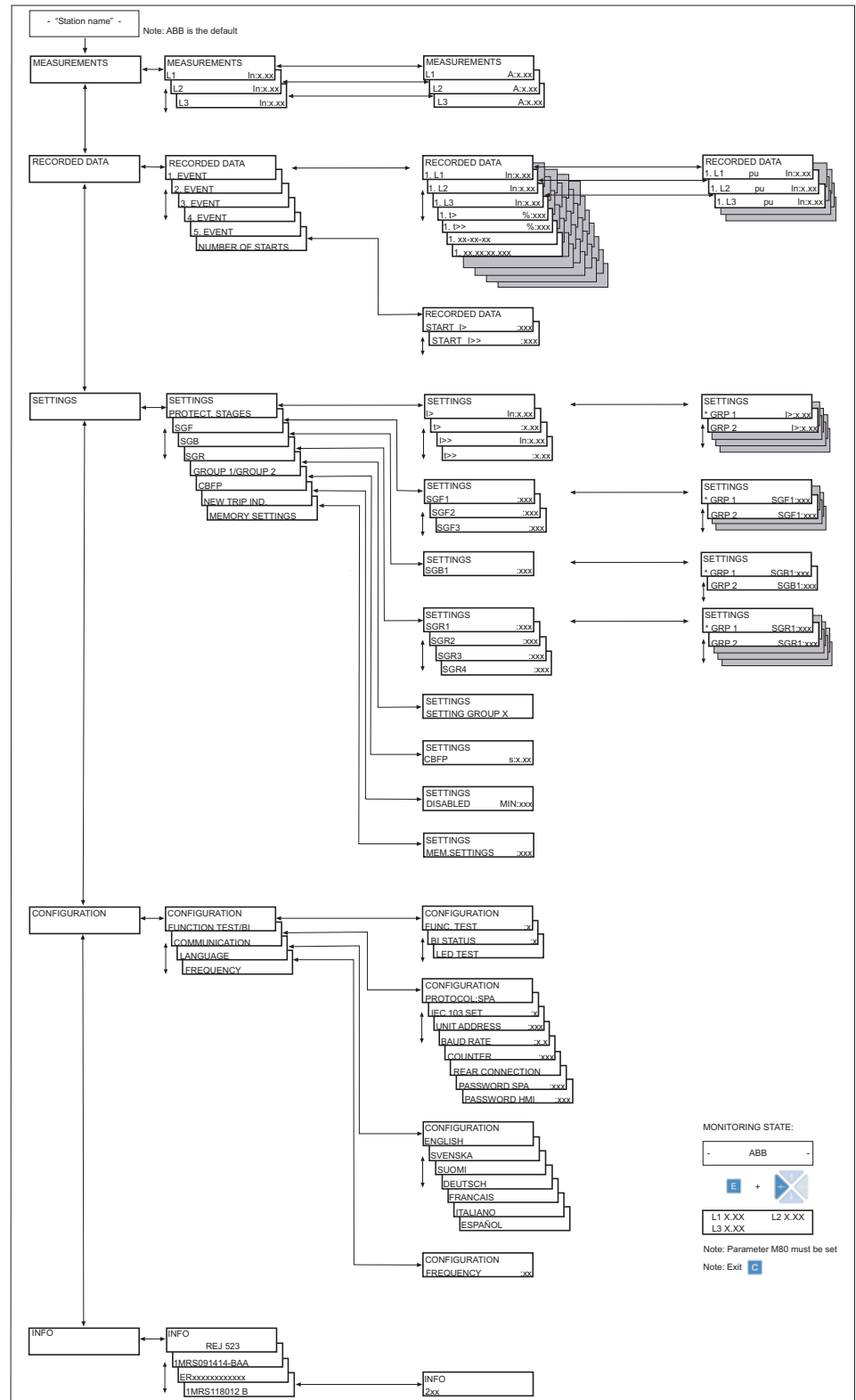

A051375

Fig. 4.2.4.-1 Menu structure

### 4.3. Protection relay indications

The operation of the relay can be monitored by means of two different kinds of indications on the HMI:

- LED indications: Start, Trip and Ready
- A text message on the LCD

The basic protection functions are not affected by fault indications.

#### 4.3.1. Indicator LEDs

When a protection stage starts, the yellow indicator LED will be lit. When a protection stage trips, the yellow indicator LED will remain lit and the red indicator LED will be lit. When a starting protection stage is blocked, the yellow indicator LED will start to blink.

##### 4.3.1.1. Green indicator LED



A051322

*Fig. 4.3.1.1.-1 Green indicator LED*

Two different functions are embedded in the READY indicator LED: power on and IRF (internal relay fault).

- Indicator off:  
The auxiliary voltage is not connected.
- Lit indicator:  
The relay is in normal operation, i.e. the CPU operates. No internal faults have occurred.
- Blinking indicator:  
An internal relay fault has occurred. Refer to section Internal fault.



**4.3.1.2.****Yellow indicator LED**

A051323

*Fig. 4.3.1.2.-1 Yellow indicator LED***START indicator**

- Indicator off:  
No protection stage has started.
- Lit indicator:  
A protection stage has started. The start indication can be selected to be latching or non-latching with the SGF switches. A non-latching indication will automatically be cleared when the fault has disappeared and the protection stage has been reset whereas a latching indication will remain lit until manually cleared.
- Blinking indicator:  
Starting protection stages have been blocked by an external binary input signal. The blocking indication is non-latching, i.e. it will disappear with the binary input signal.  
  
The START indicator LED will continue blinking for as long as a protection stage remains blocked. The blocking indication will disappear with the binary input signal or when the protection stage is no longer starting.  
  
If a protection stage is blocked when other protection stages are starting, the indicator will continue blinking. (Blocking has a higher priority than starting.)

**4.3.1.3.****Red indicator LED**

A051324

*Fig. 4.3.1.3.-1 Red indicator LED***TRIP indicator**

- Indicator off:  
No protection stage has tripped.
- Lit indicator:  
A protection stage has tripped. The trip indication is latching, i.e. it will remain lit until manually cleared.

### 4.3.2. Indication messages

The messages give an overview of protection operations and internal protection relay faults.

#### 4.3.2.1. Alarm indication messages

In case of a start or a trip of a protection stage, the text “ALARM” will appear on the display along with the name of the function. Additionally, in case of a latching start or trip indication also the name of the energizing input(s) which caused the fault will be displayed. The START indicator LED and/or the TRIP indicator LED will also be lit.

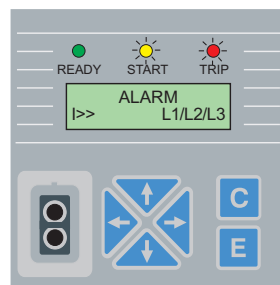

A051376

Fig. 4.3.2.1.-1 Alarm

A latching alarm indication message will remain on the display until manually cleared or until replaced by a message of higher priority. However, if the fault is stable and has not disappeared, the LED(s) will not be cleared. An alarm indication generated by a non-latching start will automatically be cleared when the stage is reset.

#### Priority of alarm indication messages

The messages on the display have a certain priority order. If different types of indications are activated simultaneously, the message with the highest priority will appear on the display. The priority order of the messages is:

1. CBFP
2. TRIP
3. START

When both protection stages start but do not trip, the last start indication message will be displayed. When both protection stages trip, the first trip indication message will be displayed until the time, as specified by the “NEW TRIP IND.” setting value, has expired. After this, a new trip indication message can displace the old one.

#### 4.3.2.2. Disturbance recorder indication

When the display is in the idle mode, an asterisk “\*” indicating that the disturbance recorder has been triggered and is ready to be unloaded will be shown in the lower right-hand corner on the display.

### 4.3.2.3. Internal fault

When the self-supervision system detects a permanent internal relay fault, the READY indicator LED will start to blink. At the same time the self-supervision alarm relay, which is normally picked up, will drop off and a fault code will appear on the display. The fault code is of a numerical kind and identifies the fault type. Record the fault code and state it when ordering service.

If an internal fault disappears, the fault message will remain on the display until manually cleared or until replaced by an alarm indication message.

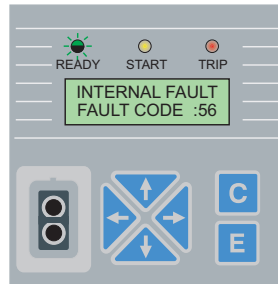

A051289

Fig. 4.3.2.3.-1 Internal fault

The fault codes are listed in the following table.

Fault code	Type of fault
4	No response on the output contact test, PO1
5	No response on the output contact test, PO2
6	No response on the output contact test, SO1
7	No response on the output contact test, SO2
20, 21	Auxiliary voltage dip
30	Faulty program memory
50, 59	Faulty work memory
51, 52, 53, 54, 56	Faulty parameter memory <sup>1)</sup>
55	Faulty parameter memory
103, 104	Faulty configuration set (for IEC_103)
131, 139, 195, 203, 222, 223	Internal reference voltage error
253	Error in the measuring unit

<sup>1)</sup> May be corrected by formatting to the factory setting.



## 5. Service

### 5.1. General

When the protection relay is operating under the specified conditions (refer to the Technical Reference Manual, sections Requirements and Technical data), the relay is practically maintenance-free. The relay includes no parts or components subject to abnormal physical or electrical wear under normal operating conditions.

If the environmental conditions at the relay operating site differ from those specified, e.g. temperature, humidity, or if the atmosphere around the relay contains chemically active gases or dust, the relay ought to be visually inspected. At the visual inspection the following should be noted:

- Signs of mechanical damage on the relay, contacts and relay case.
- Rust spots or signs of corrosion on the terminals or case.

If the relay fails in operation or if the operating values differ remarkably from the specified values, the relay is to be given a proper overhaul. All major measures involving overhaul of electronics are to be taken by the manufacturer. Please contact the manufacturer or the nearest representative for further information about checking, overhaul and recalibration of the relay.

When contacting ABB for ordering service, please give a description of the fault and state the possible fault code..



Static protection relays are measuring instruments which should be handled with care and protected against moisture and mechanical stress, especially during transport. If stored for a longer period of time, the surrounding temperature of the relay should be kept stable.

### 5.2. Commissioning testing

#### 5.2.1. Function test

The test mode is accessible via “FUNCTION TEST/BI” under “CONFIGURATION” in the HMI menu. In the test mode, all internal signals from both protection stages can be activated one by one, the self-supervision included. The internal signals are routed to the output contacts according to the SGR switchgroups.

1. Enter the test mode by pressing the [E] button and select the wanted signal with the [→] or [←] button.
2. To activate the signal, press the [E] button. The signal will remain active for as long as the [E] button remains pressed.

To leave the test mode, press the [C] button.

The table below shows the activation order and the corresponding digit flashing when a signal is being tested.

**Table 5.2.1-1 Function test**

Number	Function
1	I>
2	t>
3	I>>
4	t>>
0	IRF

### 5.2.2. Binary input test

To monitor the status of the binary input, navigate in the HMI menu as follows:

1. Select “FUNCTION TEST/BI” under “CONFIGURATION” in the main menu.
2. Select “BI STATUS” and the state of the binary input will be shown.

It is also possible to read the state of the binary input via SPA parameter I4.

### 5.2.3. LED test

The LED test is accessible via “FUNCTION TEST/BI” under “CONFIGURATION” in the HMI menu. All the LEDs not already lit can be lit in the test mode.

1. Enter the test mode by pressing the [E] button and the text “LED-TEST” will be flashed on the display.
2. To activate the LEDs not already lit, press the [E] button. The LEDs will remain lit for as long as the [E] button remains pressed.
3. To quit the test mode, press the [C] button.

The LED test can also be performed using SPA parameter V166.

### 5.3. Secondary injection testing

When the auxiliary voltage is connected to the protection relay, it will perform a self-testing program. This, however, does not include the matching transformers and the output contacts. The operational condition of the relay is tested by means of ordinary relay test equipment. Such a test also includes the matching transformers, output contacts and the accuracy of the operate values.

According to the manufacturer's recommendations, the relay should be submitted to secondary testing at five years' intervals to ensure proper operation. The testing should include the entire protection chain from the measuring transformers and should always be performed in accordance with national regulations and instructions.

The secondary testing described in this manual is based on the relay's setting values during normal operation. (If necessary, the secondary testing can be extended by testing the protection stages throughout their setting ranges.)

All setting values that are altered during the test procedure have to be read and stored prior to the tests.

Operator's Manual

To enable secondary testing, the relay has to be disconnected, either by disconnecting the terminal blocks or by fitting a test plug on the relay.



Do not open the secondary circuit of a current transformer during any phase of the testing when the primary circuit is live. The high voltage generated by an open CT secondary circuit may be lethal and damage instruments and insulation.

Equipment required for testing:

- adjustable voltage transformer 0...260 V, 1 A
- current transformer
- ammeter, accuracy  $\pm 0.5\%$
- stop watch or counter for time measurement
- ac/dc voltage source for the auxiliary supply
- switches and indicator lamps
- supply and pilot wires
- calibrated multimeter

The secondary current is to be selected on the basis of the rated current, 1 A or 5 A, of the relay energizing input to be tested..



For the limited current carrying capacity of the wiring, terminals and measuring transformers of the relay, refer to section Technical data in the Technical Reference Manual.

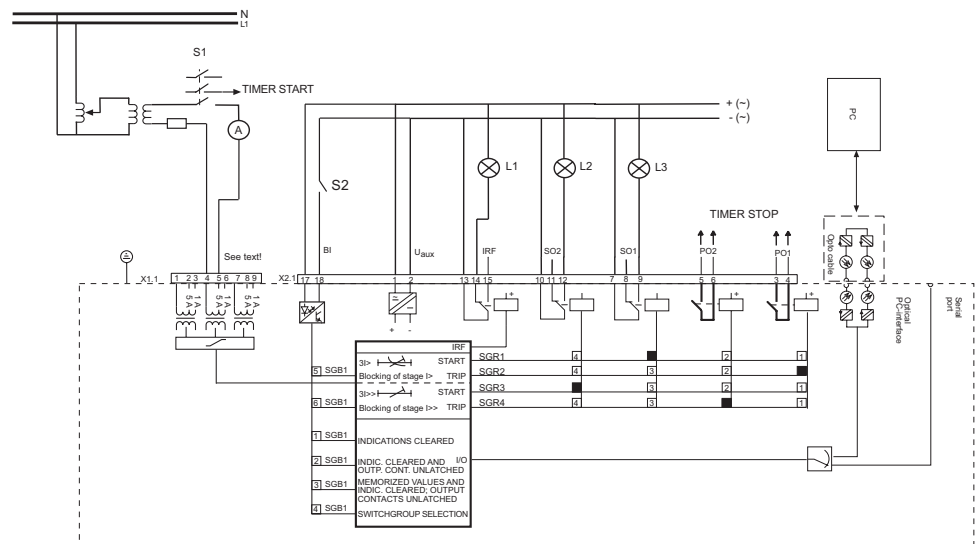

A051377

Fig. 5.3.-1 Secondary injection test circuitry

When the test circuit has been completed and the switchgroups have been set, the auxiliary voltage may be connected to the relay. The operation of the test circuit can be verified using a multimeter.

### 5.3.1. Testing of the overcurrent measuring transformers

Test each used current transformer input separately. Apply a pure sinusoidal voltage to the relay and compare the current value indicated on the display of the relay with that shown by the ammeter. The measurements can be made at the rated current of the relay, for instance. Note that the relay shows the measured current as a multiple of the rated current,  $I_n$ , of the energizing input used.

### 5.3.2. Testing of the overcurrent stages

The test is carried out as a single-phase test. Before the test is started:

- Record the currently used SGR settings for later restoring.
- Set the relay switchgroups as follows:

**Table 5.3.2-1 Switchgroup settings**

Setting	SGR
I> to SO1	SGR1 = 4
t> to PO1	SGR2 = 1
I>> to SO2	SGR3 = 8
t>> to PO2	SGR4 = 2

The setting values can be those currently in use.

#### 5.3.2.1. Low-set stage I>

##### Starting

Close switch S1 and slowly increase the test current until the relay starts and indicator L3 is lit. Read the start current value from the ammeter.

##### Operate time

Test according to the selected characteristics.

##### Definite-time characteristic

Set the test current to 2 x the setting value of stage I>.

Switch off S1, clear the indicators and unlatch the output contacts. The clock is started by closing switch S1 and stopped by closing output contact PO1.

##### Inverse-time characteristic

At inverse-time characteristic, the operate time is measured at two different test current values (2 x I> and 10 x I>). The operate times obtained are compared with those obtained from the current/time curves of the inverse-time characteristic in question.

The test procedure is the same as at definite-time characteristic.

#### 5.3.2.2. High-set stage I>>

##### Starting

Close switch S1 and slowly increase the test current until the relay starts and indicator L2 is lit. Read the start current value from the ammeter.



**Operate time**

Set the test current to 2 x the the setting value of stage I>>.

Switch off S1, clear the indicators and unlatch the output contacts. The clock is started by closing switch S1 and stopped by closing the output contact PO2.

**5.3.3.****Testing of the self-supervision system (IRF)**

The IRF output contact and the operation of the READY indicator LED can be tested by selecting the function test in the HMI menu. Indicator L1 will be lit when testing the self-supervision-system.

**5.4.****Spare parts**

To achieve the best possible operation accuracy, all parts of the relay have been calibrated together. Thus, each product forms a whole for which no separate spare parts can be supplied. In case of malfunction, please consult your relay supplier.



**6. Ordering information**

Refer to the Technical Reference Manual.



**7.****Abbreviations**

CBFP	Circuit-breaker failure protection
CPU	Central processing unit
IDMT	Inverse definite minimum time characteristic
IRF	Internal relay fault
LCD	Liquid Crystal Display
LED	Light-emitting diode
HMI	Human-Machine Interface
SGB	Switchgroups for binary input
SGF	Switchgroups for functions
SGR	Switchgroups for output contacts



**8.****Index**

<b>A</b>	
Abbreviations .....	37
<b>B</b>	
Binary input test .....	30
<b>C</b>	
Commissioning testing .....	29
Configuration .....	21
Connectors .....	16
<b>D</b>	
Display backlight .....	12
Display contrast .....	13
Display idle mode .....	12
Display test .....	12
<b>F</b>	
Fault code .....	27
Front panel .....	11
Function test .....	29
<b>H</b>	
HMI operation levels .....	17
<b>I</b>	
Indication messages .....	26
INFO .....	19
Internal relay fault .....	27
<b>L</b>	
Language .....	14
LED .....	24, 25
LED test .....	30
<b>M</b>	
Main menu .....	15
Master reset .....	22
Measured values .....	17
Memorized values .....	22
Menu chart .....	23
<b>P</b>	
Parameters .....	19
Passwords .....	16
Pickup value .....	18
Push-buttons .....	13

## Operator's Manual

---

**R**

Recorded data ..... 18

**S**

Secondary injection testing ..... 30

Service ..... 29

Setting groups ..... 20

Settings ..... 20

Submenu ..... 15











**ABB Oy**

Distribution Automation

P.O. Box 699

FI-65101 Vaasa

FINLAND

Tel. +358 10 22 11

Fax. +358 10 224 1094

[www.abb.com/substationautomation](http://www.abb.com/substationautomation)