

SMART GRID

Interface Protection System

Next level solutions

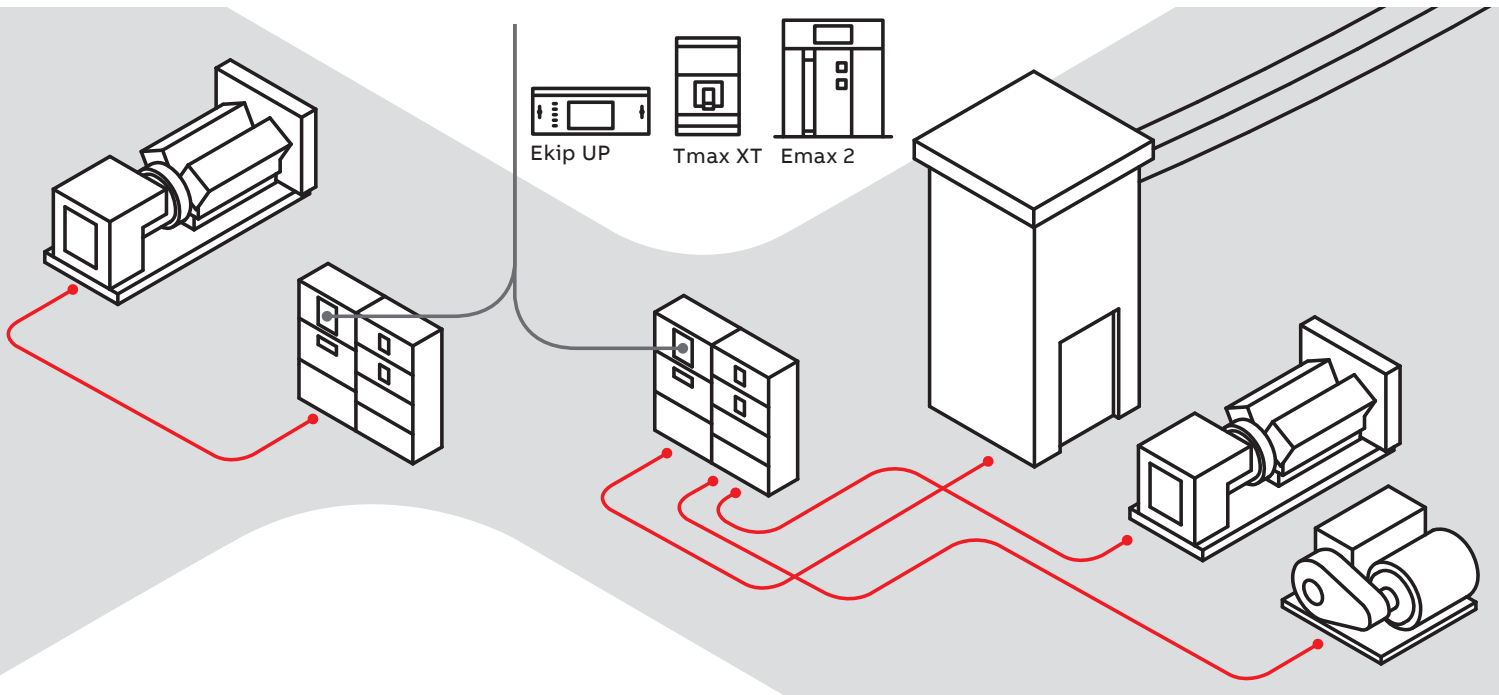

- 01 Tmax XT
- 02 Emax 2
- 03 Ekip UP

Embedding microgrid protection in a single device with Emax 2 and Tmax XT: Interface Protection System (IPS).

The connection of active users to Utilities is subject to electrical Standards requirements. In particular, the generating units installed in the user's plant shall be disconnected from the grid

whenever the voltage and frequency values of the grid itself are out of the ranges prescribed by the Standard.

Such disconnection is usually carried out by an Interface Device that trips after receiving an opening command sent by an external Interface Protection System.

With Emax 2 and Tmax XT, ABB designed a unique integrated solution which embeds both functions of Interface Protection System (IPS) and Interface Device (ID).

Moreover, with Ekip UP you can take advantage of the same functionalities even if various circuit breakers - either by ABB or by other manufacturers - are installed in your system.

This advanced feature is possible thanks to the implementation of several interface protections into Ekip G Hi-Touch trip unit installed on board of low-voltage circuit breakers and built-in inside Ekip UP Protect+ or Ekip UP Control+ digital units. Today, the embedded IPS is suitable for the connection of active users as prescribed by the main Standards.



Benefits

Thanks to Tmax XT and Emax 2 with embedded Interface Protection System, the following benefits are guaranteed:

- space saving in switchboards and a more compact solution. Installation of an external relay is no longer necessary.
- if Tmax XT or Emax 2 are installed on the generator feeder, the circuit breaker is able to perform the triple function of Interface Protection System, Interface Device and Generator Device thanks to the Interface Protection System embedded into the Ekip G Hi-Touch trip unit.
- ease of use, thanks to Ekip Connect software which allows an immediate and intuitive commissioning phase.

Application examples

Thanks to the embedded functions integrated in a single device, the number of components to be installed is reduced, with consequent space saving inside the switchboard. Tmax XT and Emax 2 are suitable to fully satisfy the requirements of the following scenarios.

In existing plants, Ekip UP enables interface protection system as a plug&play solution in a wide range of plant size. Ekip UP units share the same electronics of circuit breakers to satisfy all market opportunities of metering, protections and control in power distribution and generation.

Tmax XT or Emax 2 as microgrid main circuit-breaker

In such scenario, with a power of tens/hundreds of kVA and hundreds of kVA/some MVA flowing through Tmax XT and Emax 2 respectively, these circuit breakers can fulfill the double function of Interface Device and Interface Protection System. In case of IPS tripping, the low-voltage microgrid downstream of the main circuit breaker remains active thanks to both the local generation and the load shedding feature embedded in the main circuit breaker (either Tmax XT or Emax 2).

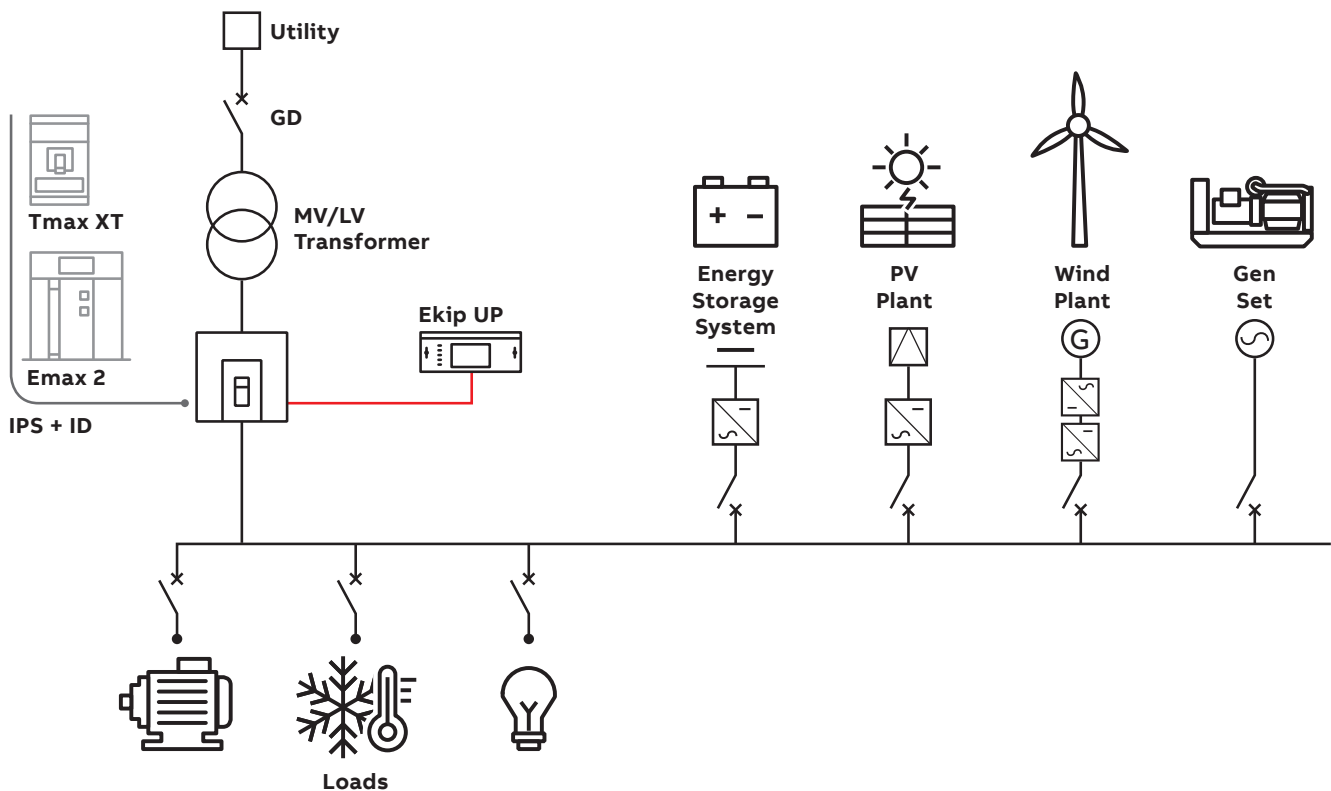

Tmax XT or Emax 2 as local generation circuit breaker

In such scenario, there are loads not working in islanding condition. Tmax XT or Emax 2, installed on the generator feeder, performs the triple function of Interface Protection System, Interface Device and Generator Device.

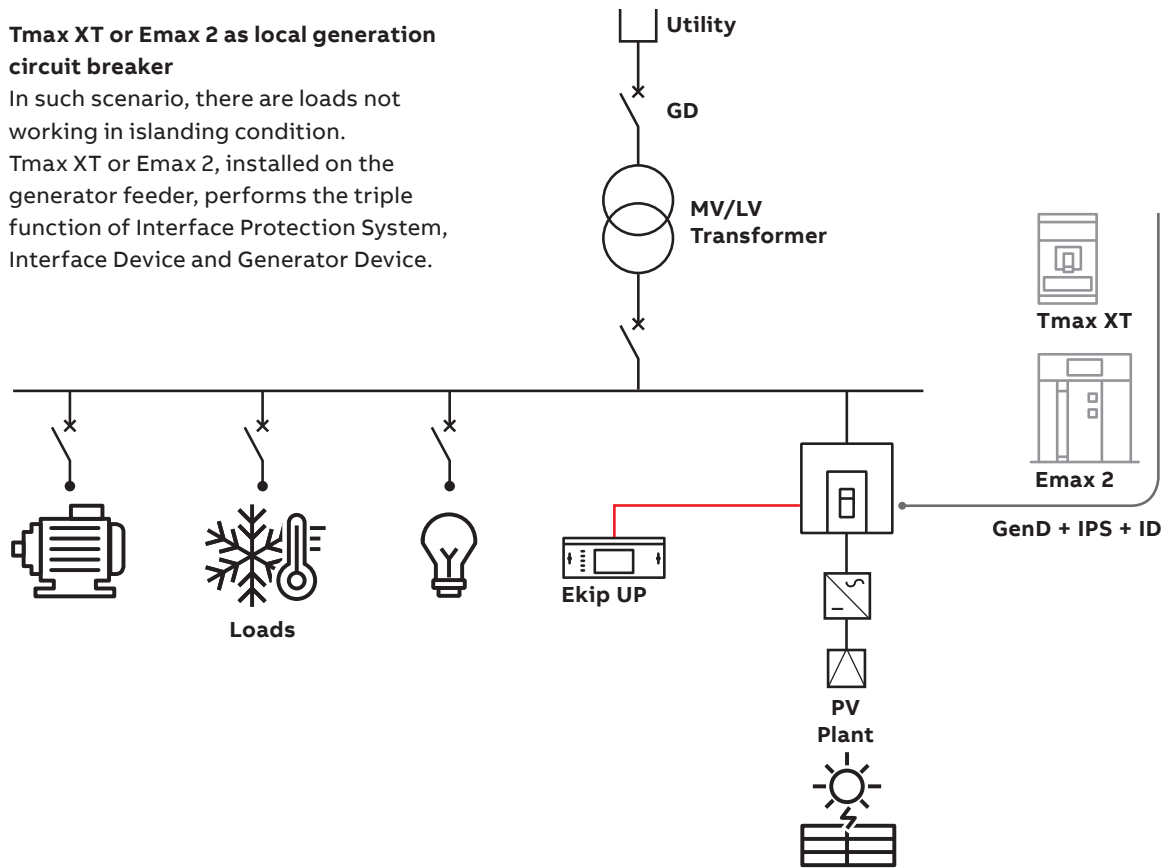

Functions available

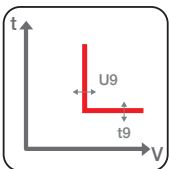

Voltage protections

- Overvoltage (ANSI 59) with double threshold S1, S2 - Function trips when the phase voltage exceeds the set thresholds.
- Undervoltage (ANSI 27) with double threshold S1, S2 - Function trips when the phase voltage falls below the set thresholds.

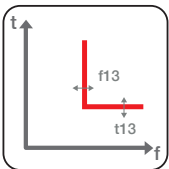

Frequency protections

- Overfrequency (ANSI 81H) with double threshold S1, S2 - Function trips when the frequency exceeds the set thresholds.
- Underfrequency (ANSI 81L) with double threshold S1, S2 - Function trips when the frequency falls below the set thresholds.

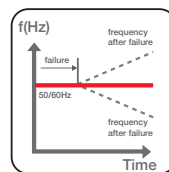

- Maximum positive-sequence voltage (ANSI 59 V0) - Function trips when the positive-sequence voltage exceeds the set threshold.

ROCOF (ANSI 81R)

- Function trips when the rate of change of frequency exceeds the set threshold.

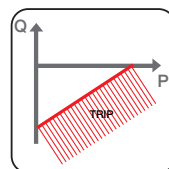

RQ (ANSI 40/32R)

- Function trips when the reverse reactive power exceeds the set threshold.

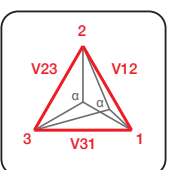

Voltage restrained

- Maximum zero-sequence voltage (ANSI 59 V0) - Function is tripped when the zero-sequence voltage exceeds the set threshold.
- Maximum negative-sequence voltage (ANSI 59 V0) - Function trips when the negative-sequence voltage exceeds the set threshold.

ABB SACE
A division of ABB S.p.A.
L.V. Breakers
Via Pescaria, 5
24123 Bergamo - Italy
Phone: +39 035 395.111
Fax: +39 035 395.306-433
abb.com/lowvoltage

We reserve the right to make technical changes or modify the contents of this document without prior notice. With regard to purchase orders, the agreed particulars shall prevail. ABB does not accept any responsibility whatsoever for potential errors or possible lack of information in this document.

We reserve all rights in this document and in the subject matter and illustrations contained therein. Any reproduction, disclosure to third parties or utilization of its contents – in whole or in parts – is forbidden without prior written consent of ABB.
Copyright © 2017 ABB
All rights reserved