

# C13 User Manual





**C13**

**User Manual**

**Document ID: 2CMC486004M0201**

**Revision: A**

**2013-06-19**

---

**Disclaimer**

The information in this document is subject to change without notice and should not be construed as a commitment by ABB AB. ABB AB assumes no responsibility for any errors that may appear in this document.

In no event shall ABB AB be liable for direct, indirect, special, incidental or consequential damages of any nature or kind arising from the use of this document, nor shall ABB AB be liable for incidental or consequential damages arising from use of any software or hardware described in this document.

---

**Copyrights**

This document and parts thereof must not be reproduced or copied without written permission from ABB AB, and the contents thereof must not be imparted to a third party nor used for any unauthorized purpose.

The software or hardware described in this document is furnished under a license and may be used, copied, or disclosed only in accordance with the terms of such license.

© Copyright 2013 ABB AB. All rights reserved.

---

**Trademarks**

ABB AB is a registered trademark of the ABB Group. All other brand or product names mentioned in this document may be trademarks or registered trademarks of their respective holders.

---

**Contact**

ABB AB  
P.O. BOX 1005  
SE-611 29 NYKÖPING  
SWEDEN  
Tel: +46 155 295000  
Fax: +46 155 288110

---

---

<b>1 About this Manual</b> .....	<b>3</b>
1.1 Conventions Used in this Document .....	4
<b>2 Product Overview</b> .....	<b>5</b>
2.1 Meter Parts .....	6
2.2 Meter Type .....	7
<b>3 Installation</b> .....	<b>9</b>
3.1 Mounting the Meter .....	10
3.2 Environmental Considerations .....	11
3.3 Installing the Meter .....	12
3.3.1 Wiring Diagrams .....	13
3.3.1.1 Outputs .....	13
<b>4 User Interface</b> .....	<b>15</b>
4.1 Display and buttons .....	16
4.2 Menu Structure .....	17
<b>5 Meter Settings</b> .....	<b>21</b>
5.1 Setting the Output .....	22
5.2 Setting the Alarm .....	24
<b>6 Technical Description</b> .....	<b>27</b>
6.1 Energy Values .....	28
6.2 Instrumentation .....	29
6.3 Outputs .....	30
6.4 Alarm .....	31
<b>7 Technical data</b> .....	<b>33</b>
7.1 Technical Specifications .....	34
7.2 Physical Dimensions .....	36
<b>8 Troubleshooting</b> .....	<b>37</b>
8.1 Error Codes and Warnings .....	38
<b>9 Service &amp; Maintenance</b> .....	<b>39</b>
9.1 Service and Maintenance .....	40



# Chapter 1: About this Manual

---

## Overview

This chapter describes the conventions used in this manual. It also contains explanations and definitions of terms and definitions that are used in the document.

---

---

## In this chapter

The following topics are covered in this chapter:

- 1.1 Conventions Used in this Document ..... 4





### 1.1 Conventions Used in this Document

---

#### Symbols

This document contains warning, caution, note and tip icons that point out safety related conditions and other important or useful information.

---

Symbol	Description
	The electrical warning icon indicates the presence of a hazard which could result in electrical shock.
	The caution icon indicates important information or a warning related to the concept discussed in the text. It might indicate the presence of a hazard which could result in corruption of software or damage to equipment or property.
	The note icon alerts the reader to important facts and conditions.
	The tip icon gives the reader useful information related to the concept discussed in the text.



## Chapter 2: Product Overview

---

### Overview

This chapter describes the parts of the meter. It also contains information about the meter type.

---

---

### In this chapter

The following topics are covered in this chapter:

2.1 Meter Parts .....	6
2.2 Meter Type .....	7

## 2.1 Meter Parts

---

### Illustration

The parts of the meter are shown in the illustration below:

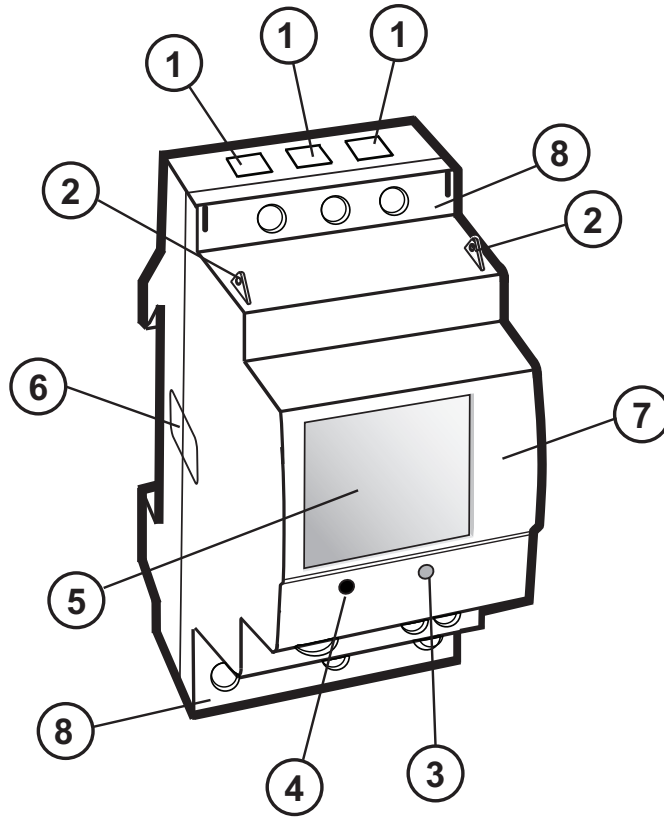

### Parts description

The following table describes the parts of the meter:

Item	Description	Comments
1	Terminal for output connections	
2	Sealing points	
3	Push button	For programming and reading metering data
4	LED	Flashes in proportion to the energy measured
5	Display	LCD for meter reading
6	Sealing label	
7	Product data	
8	Terminal block	

---

## 2.2 Meter Type

### C13 meter

The C13 is a compact meter for 3-phase metering. The meter is direct connected for currents up to max. 40 A.

### Product label

The meter type information that is reflected on the product label is shown in the example picture below:

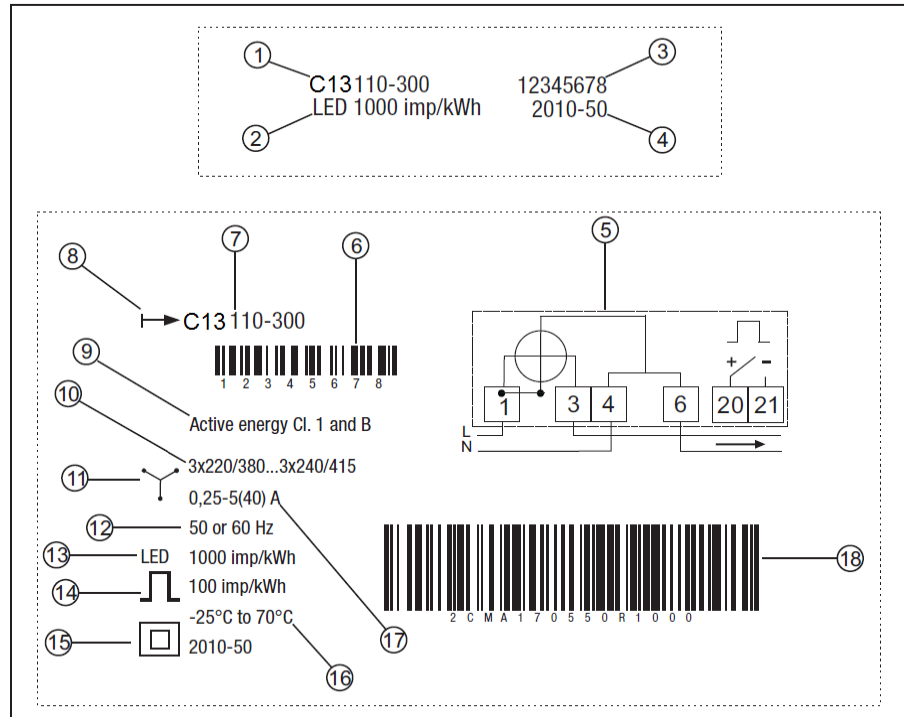

### Label information

The information on the type label is explained in the table below:

Item	Description
1	Type designation
2	LED pulse frequency
3	Serial number
4	Manufacturing date (year and week)
5	Wiring diagram
6	Bar code with serial number
7	Type designation
8	Energy import
9	Accuracy (active energy)
10	Nominal voltage
11	3-element metering

# Product Overview

---

Item	Description
12	Frequency
13	LED pulse frequency
14	Pulse frequency
15	Protection class II
16	Operating temperature range
17	Rated current
18	ABB ID

---

## Chapter 3: Installation

---

### Overview

This chapter describes how to mount the C13 meter and how to connect it to an electricity network.

---

---

### In this chapter

3.1 Mounting the Meter .....	10
3.2 Environmental Considerations .....	11
3.3 Installing the Meter .....	12
3.3.1 Wiring Diagrams .....	13

### 3.1 Mounting the Meter

---

**General**

This section describes different ways to mount the C13 meter. For some methods of mounting, additional accessories are needed. For further information about accessories, refer to Main Catalog (2CMC481003C0201).

---

**DIN-rail mounted**

The C13 meters are intended to be mounted on a standard (DIN 50022) DIN-rail. If this method of mounting is used no extra accessories are needed and the meter is fastened on the rail by snapping the DIN-rail lock onto the rail.

---

**Wall mounted**

The recommended way to mount the meter on a wall is to mount a separate DIN-rail on the wall and then mount the meter on the rail.

---

**Standard DIN-rail**

The following picture shows a standard DIN-rail.

---

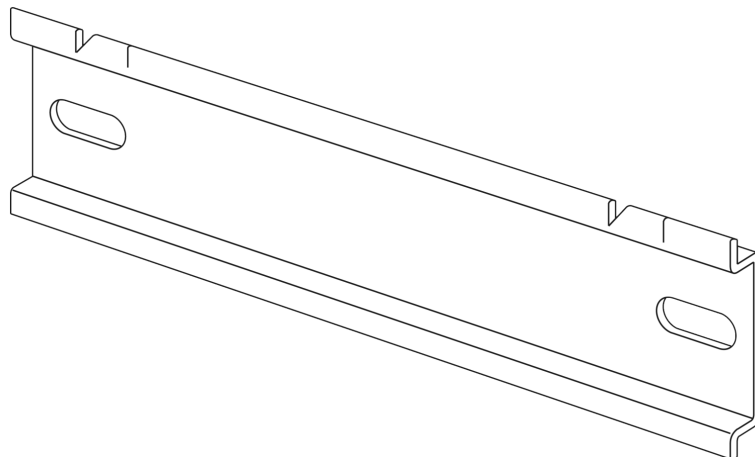

## 3.2 Environmental Considerations

---

### Ingress protection

To comply with the protection requirements the product must be mounted in protection class **IP 51** enclosures, or better, according to **IEC60259**.

---

### Mechanical environment

In accordance with the Measuring Directive (**2004/22/EC**), the product complies with **M1**, which means that it can be operated in "...locations with vibration and shocks of low significance, e.g. for instruments fastened to light supporting structures subject to negligible vibrations and shocks transmitted from local blasting or pile-driving activities, slamming doors, etc."

---

### Electromagnetic environment

In accordance with the Measuring Directive (**2004/22/EC**), the product complies with **E2**, which means that it can be operated "...in locations with electro magnetic disturbances corresponding to those likely to be found in other industrial buildings."

---

### Climatic environment

In order to work properly the product should not be operated outside the specified temperature range of  $-40^{\circ}\text{C} - +70^{\circ}\text{C}$ .

In order to work properly the product should not be exposed to humidity exceeding the specified 75% yearly average, 95% on 30 days/year.

---

## 3.3 Installing the Meter



**Warning** – Electrical equipment should only be installed, accessed, serviced and maintained by qualified electrical personnel.

Working with high voltage is potentially lethal. Persons subjected to high voltage may suffer cardiac arrest, burn injuries, or other severe injuries. To avoid such injuries, make sure to disconnect the power supply before you start the installation.



**Warning** – For safety reasons it is recommended that the equipment is installed in a way that makes it impossible to reach or touch the terminal blocks by accident.

The best way to make a safe installation is to install the unit in an enclosure. Further, access to the equipment should be limited through use of lock and key, controlled by qualified electrical personnel.



**Warning** – The meters must always be protected by fuses on the incoming side.

In order to allow for maintenance of transformer rated meters, it is recommended that there should be a short circuiting device installed near the meter.

---

### Installation requirements

To comply with the protection requirements the meter must be mounted in protection class IP 51 enclosures, or better, according to IEC 60259.

Meters with wireless communication should not be installed closer than 20 cm from people.

---

### Install the meter

Follow the steps in the table below to install the meter:

Step	Action
1	Switch off the mains power.
2	Place the meter on the DIN-rail and make sure it snaps onto it.
3	Strip the cable insulation to the length that is indicated on the meter.
4	Connect the cables according to the wiring diagram that is printed on the meter and tighten the screws (0.8 Nm).
5	Install the circuit protection (max 40 A).
6	Connect the output to an external power supply (max 5–40 V). See the wiring diagram printed on the meter.
7	Turn on the mains power.

---

### Verify the installation

The C13 meter has a red LED next to the push button on the front of the meter that flashes proportionally to the active energy. The LED has a fixed pulse frequency of 1000 imp/kWh and can be used to test and verify the installation. If the LED flashes when the mains power is turned on, the installation was successful.



### 3.3.1 Wiring Diagrams

**4-wire connection** The following diagram shows a 4-wire connection of a direct connected 3-phase meter:

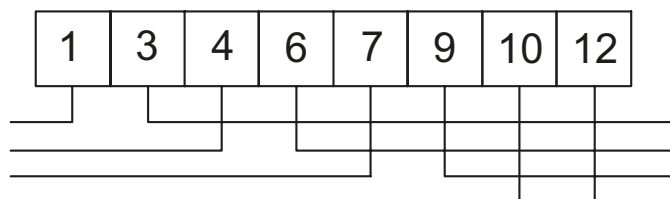

#### 3.3.1.1 Outputs

**Fixed, 1 output**

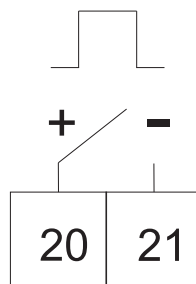



# Chapter 4: User Interface

---

**Overview**

This chapter gives an overview of the display and of the functions of the button on the meter.

---

---

**In this chapter**

The following topics are covered in this chapter:

- 4.1 Display and buttons ..... 16
- 4.2 Menu Structure ..... 17

## 4.1 Display and buttons

---

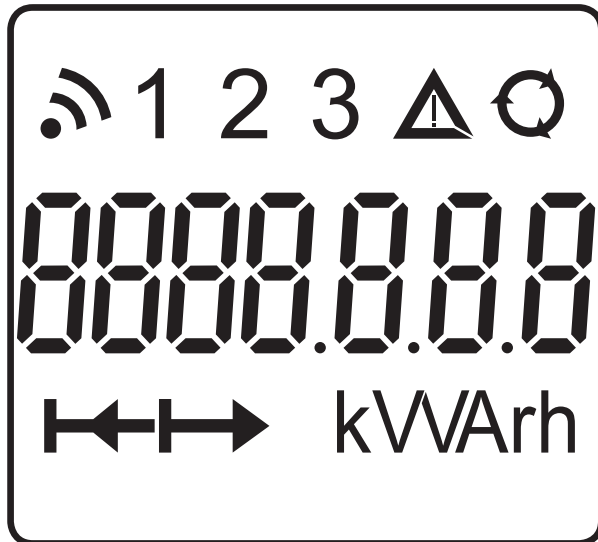

### Display

The display consists of icons, digits and letters. The measured value/menu options are displayed with large letters. The measured unit is displayed on the bottom-right side of the display, and the status icons are displayed at the upper part of the display, see figure below.



### Status Icons

The status icons are shown in the table below.

Icon	Indication	Comment
	Active error	When a error has been detected, the icon will be lit on the display. When no error has been detected, the icon will be turned off.
	Metering in progress.	When a load is connected to the meter, the icon will flash to indicate metering. When no load is connected, the icon will be turned off.

### Button

The meter has one push button which is located below the display. A short press on the button (less than 1 sec) will step through the menu/submenu. A long press (more than 1 sec) followed by a release of the button will open the set menu or select an item in the menu.

---

### 4.2 Menu Structure

**Overview** This section will give an introduction to the menu structure.

**Menu structure** The menu structure of the meter can be viewed in the following figure

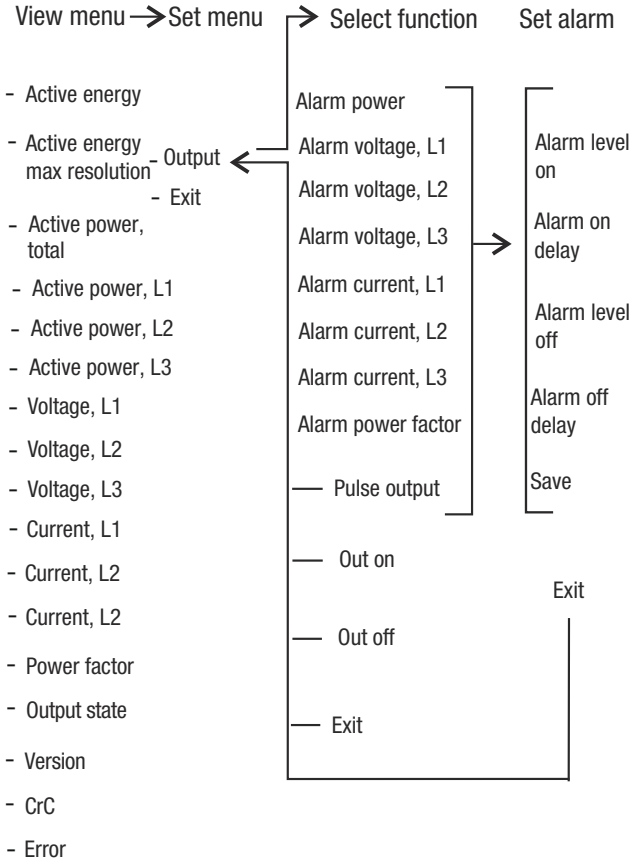

**Navigation** To navigate in the menu, use the short press to navigate between the different menu items, and the long press to select a menu item. When performing settings, the short press is used to change the value of a specific setting, and the long press is used to toggle between different digits.

**View menu** In the view menu, the following choices can be made.

Choice in menu	Output on display	No. of digits	No. of decimals	Unit	Min. value	Max. value
Active energy	<numerical value> kWh	7	0	kWh	0	9999999

Choice in menu	Output on display	No. of digits	No. of decimals	Unit	Min. value	Max. value
Active energy max resolution	<numerical value> Wh	6	3	Wh	0	999.999
Active power Total	<numerical value> W	5	0	W	0	99999
Active power Phase 1	<numerical value> W	5	0	W	0	99999
Active power Phase 2	<numerical value> W	5	0	W	0	99999
Active power Phase 3	<numerical value> W	5	0	W	0	99999
Voltage Phase 1	<numerical value> V	3	0	V	0	999
Voltage Phase 2	<numerical value> V	3	0	V	0	999
Voltage Phase 3	<numerical value> V	3	0	V	0	999
Current Phase 1	<numerical value> A	3	1	A	0	99.9
Current Phase 2	<numerical value> A	3	1	A	0	99.9
Current Phase 3	<numerical value> A	3	1	A	0	99.9
Power factor	<numerical value>	4	3	N/A	0	1
Output state						
- Alarm on, or	AL ON	N/A	N/A	N/A	N/A	N/A
- Alarm off, or	AL OFF	N/A	N/A	N/A	N/A	N/A
- Output on, or	OUT ON	N/A	N/A	N/A	N/A	N/A
- Output off, or	OUT OFF	N/A	N/A	N/A	N/A	N/A
- Pulse out	PUL OUT	N/A	N/A	N/A	N/A	N/A
Firmware version Part 1	N/A	3	N/A	N/A	1	255
Firmware version Part 2	N/A	3	N/A	N/A	0	255
Firmware version Part 3	N/A	3	N/A	N/A	0	255

Choice in menu	Output on display	No. of digits	No. of decimals	Unit	Min. value	Max. value
CRC Part 1	N/A	4	N/A	N/A	0000	FFFF
CRC Part 2	N/A	4	N/A	N/A	0000	FFFF
Error	Er <numerical value>	4	N/A	N/A	N/A	N/A

**Set menu**

The set menu is used to set different options in the meter. The set menu is reached by using the long press when located in the view menu. The following choices are available in the set menu, see table below.

Choice in menu	Output on display
Output	SEt OUT
Exit	EH t

**Set alarm menu**

When choosing Exit, the menu will return to the view menu. When choosing Out-put, the following choices will be available.

Choice in menu	Output on display	Explanation
Alarm power	AL P VV	By choosing this option, the alarm will be set with regards to the measured power.
Alarm voltage	AL U L1 V	By choosing this option, the alarm will be set with regards to the measured voltage on Phase 1.
Alarm voltage	AL U L2 V	By choosing this option, the alarm will be set with regards to the measured voltage on Phase 2.
Alarm voltage	AL U L3 V	By choosing this option, the alarm will be set with regards to the measured voltage on Phase 3.
Alarm current	AL C L1 A	By choosing this option, the alarm will be set with regards to the measured current on Phase 1.
Alarm current	AL C L2 A	By choosing this option, the alarm will be set with regards to the measured current on Phase 2.
Alarm current	AL C L3 A	By choosing this option, the alarm will be set with regards to the measured current on Phase 3.

Choice in menu	Output on display	Explanation
Alarm power factor	<i>AL PF</i>	By choosing this option, the alarm will be set regarding to the measured power factor.
Pulse output	<i>PULOUT</i>	By choosing this option, the pulse output function will be activated.
Out on	<i>OUTON</i>	By choosing this option, the output will be set to static on.
Out off	<i>OUTOFF</i>	By choosing this option, the output will be set to static off.
Exit	<i>EXIT</i>	Go back to the set menu.

When either Alarm power, Alarm voltage, Alarm current or Alarm factor has been chosen, the following choices will be available.

Choice	Output on display	Unit	Explanation
Alarm level on	<i>AL ON</i>	W/V/A/-	When the measured value passes the set value, the alarm will be triggered.
Alarm on delay	<i>dEL ON</i>	seconds	When the measured value passes the set value and remains for the set time, the alarm will be triggered.
Alarm level off	<i>AL OFF</i>	W/V/A/-	When the measured value passes the set value, the alarm will be cleared.
Alarm off delay	<i>dEL OFF</i>	seconds	When the measured value passes the set value and remains for the set time, the alarm will be cleared.
Save	<i>SAVE</i>	N/A	This option saves the alarm settings.
Exit	<i>EXIT</i>	N/A	Go back to the set menu without saving. Use this option to view the current alarm settings.

---



## Chapter 5: Meter Settings

---

### Overview

This chapter describes how to configure the functions of the meter, including alarm settings.

---

### In this chapter

The following topics are covered in this chapter:

5.1 Setting the Output .....	22
5.2 Setting the Alarm .....	24

## 5.1 Setting the Output

### About the output

The C13 meter has one output which can be used for three different purposes. When one of the three options has been chosen for the output, the remaining two options are automatically disabled.

- Alarm monitoring  
The output is used for monitoring if an alarm has been triggered or not.
- Static level  
The output is set as static, either as static on or static off.
- Pulse output  
The output is set as a pulse output.

### Output state

The Output state in the main menu indicates what function is activated. See table below for the different functions that can be activated

Activated function	Output on display	Comment
Alarm on	<i>AL On</i>	The alarm is set and has been triggered. The pulse output exit is deactivated.
Alarm off	<i>AL OFF</i>	The alarm is set but has not been triggered. The pulse output exit is deactivated.
Output on	<i>OUTOn</i>	There is always a continuous signal on the output.
Output off	<i>OUTOFF</i>	The output is closed for all traffic, both inbound and outbound.
Pulse out	<i>PULOUT</i>	The output is activated with a frequency based on measured energy. The alarm function is deactivated.

### Set output to pulse output

To set the pulse output to be available for pulse measuring, perform the following steps when located in the view menu.

Step	Action	Comment
1	When located in the view menu, use the long press to get to the set menu.	-
2	Use the long press to get to the selection of functions menu.	-
3	Toggle through the menu to get to the Pulse out choice. Use the long press to choose Pulse out ( <i>PULOUT</i> on the display).	The Pulse out choice in the selection of function menu is displayed as: <i>PULOUT</i>

**Disable output**

The output can also be disabled by performing the following steps when located in the view menu.

Step	Action	Comment
1	When located in the view menu, use the long press to get to the set menu	-
2	Use the long press to get to the selection of function menu.	-
3	Toggle through the menu to get to the Output off choice ( <i>OUTOFF</i> on the display). Use the long press to choose the Output off.	The Output off choice in the view menu is displayed as: <i>OUTOFF</i>

**Activate output**

To activate the output, perform the following steps when located in the view menu.

Step	Action	Comment
1	When located in the view menu, use the long press to get to the set menu.	-
2	Use the long press to get to the selection of function menu.	-
3	Toggle through the menu to get to the Output on choice ( <i>OUTON</i> on the display). Use the long press to choose the Output on.	The Output on choice in the view menu is displayed as: <i>OUTON</i>

## 5.2 Setting the Alarm

### About the alarm

The alarm function gives the user the possibility to set an alarm that will trigger when a defined limit is reached by the measured value. See table for more information.

Choice in menu	Unit	Output on display	Range
Alarm power	W	AL P W	0–99999 W
Alarm voltage Phase 1	V	AL U L1 V	0–299 V
Alarm voltage Phase 2	V	AL U L2 V	0–299 V
Alarm voltage Phase 3	V	AL U L3 V	0–299 V
Alarm current Phase 1	A	AL I L1 A	0–40.00 A
Alarm current Phase 2	A	AL I L2 A	0–40.00 A
Alarm current Phase 3	A	AL I L3 A	0–40.00 A
Alarm power factor	-	AL PF	0–0.999

If the value is set above the max range, the meter will automatically set the value to the max value allowed by the range.

Example: Alarm current is set to 100.0 A by the user, but the max value is 40.0 A, so the meter will use the max value, in this case 40.0 A.

If an alarm has been set, the output state will indicate if the alarm is triggered (AL On) or not (AL OFF). The magnitude of the set alarm is also displayed in the output state.

### Set alarm

To set an alarm, perform the following steps when located in the view menu.

Step	Action	Comment
1	Use the long press to get to the set menu	-
2	Use the long press to get to the selection of function menu	-
3	Toggle through the menu to choose what magnitude to set. Choose one of the following: Alarm power (W), Alarm voltage (V), Alarm current (A) and Alarm factor (no magnitude).	Use the long press to choose.
4	Set the alarm value that the measured value must pass in order for the alarm to trigger (Alarm level on).	Use the short press to change the value of the digit, and the long press to step through the different digits.

Step	Action	Comment
5	Set the time frame that the measured value must pass the set alarm value in order for the alarm to trigger (Alarm on delay).	Use the short press to change the value of the digit, and the long press to step through the different digits.
6	Set the alarm value that the measured value must pass in order for the alarm to be cleared (Alarm level off).	Use the short press to change the value of the digit, and the long press to step through the different digits.
7	Set the time frame that the measured value must pass the set alarm value in order for the alarm to be cleared (Alarm off delay).	Use the short press to change the value of the digit, and the long press to step through the different digits.
8	To save the alarm settings and enable the alarm function, use the long press when located in the save-menu ( <i>SAVE</i> on the display). After performing this setting, the alarm is set.	If not choosing the option save, the settings will not be saved and the previously saved setting will be used instead. The alarm will not be activated.

**Read alarm**

The Output option in the View menu shows whether a programmed alarm has been triggered or not. A triggered alarm displays as AL On, and an alarm that has not been triggered displays as AL OFF.



## Chapter 6: Technical Description

---

### Overview

This chapter describes the technical functions of the C13 meter.

---

### In this chapter

The following topics are covered in this chapter:

6.1 Energy Values .....	28
6.2 Instrumentation .....	29
6.3 Outputs .....	30
6.4 Alarm .....	31

### 6.1 Energy Values

---

**General**

The energy values are stored in energy registers. The different energy registers can be divided into:

- Registers containing active energy.

The energy values can be read directly on the display by using the button on the meter.

---

**Presentation of register values**

In direct connected meters the energy is usually displayed with a fixed unit and number of decimals (normally kWh, with no decimals).

In case the energy is displayed with fixed units and number of decimals the energy will “roll over” to zeros when the energy is incremented if all nines are displayed. The meter can however contain more digits internally, which can be read out via communication if the meter is equipped with a communication interface.

---



## 6.2 Instrumentation

### Instrumentation functions

The following table shows the complete instrumentation functions of the C13 meter.

Instrumentation	C13
Active power L1	X
Active power L2	X
Active power L3	X
Voltage L1 - N	X
Voltage L2 - N	X
Voltage L3 - N	X
Current L1	X
Current L2	X
Current L3	X
Power factor, Total	X

### Accuracy

All instrumentation data accuracy is defined within the voltage range -20% – +15% of the stated nominal voltage and within the current range 5% of the base current to the maximum current.

### 6.3 Outputs

---

#### About outputs

The C13 meter has one output which can be used for three different purposes. When one of the three options has been chosen for the output, the remaining two options are automatically disabled.

- Alarm monitoring  
The output is used for monitoring if an alarm has been triggered or not.
- Static level  
The output is set as static, either as static on or static off.
- Pulse output  
The output is set as a pulse output.

On the pulse output the meter sends out a specified number of pulses (pulse frequency) per kilowatt hour (kilovar for reactive pulse outputs). The amount of pulses sent out are in proportion to the energy flowed through the meter.

The meter has a pulse output frequency of 100 imp/kWh and the pulse width is 200 ms.

---

## 6.4 Alarm

---

### General

The purpose of the alarm function is to enable monitoring of quantities in the meter. Monitoring can be set to high or low level detection. High level detection gives an alarm when the level of a quantity goes above the set level. Low level detection gives an alarm when the value goes below the set level.

---

### Quantities

Depending on the meter type all or a subset of the following quantities can be monitored:

- Active power
  - Power factor
  - Current L
  - Voltage L-N
- 

### Functional description

When the value of the monitored quantity passes the activation level, and remains there for a period of time equal or longer than the specified time delay, the alarm is activated. In the same way, the alarm is deactivated when the value passes the deactivation level and remains there for a time equal to or longer than the specified time delay.

If the activation level is higher than the deactivation level, the alarm is activated when the value of the monitored quantity is higher than the activation level.

If the activation level is lower than the deactivation level, the alarm is activated when the value of the monitored quantity is lower than the activation level.

---



## Chapter 7: Technical data

---

### Overview

This chapter contains the technical specifications and the physical dimensions of the meter.

---

---

### In this chapter

The following topics are covered in this chapter:

7.1 Technical Specifications .....	34
7.2 Physical Dimensions .....	36

### 7.1 Technical Specifications

#### Specifications for C13 direct connected meter

<b>Voltage/current inputs</b>	
Nominal voltage	3x230/400 VAC
Voltage range	3x220–240 VAC (-20% – +15%)
Power dissipation voltage circuits	1.5 VA (0.6 W) total
Power dissipation current circuits	0.04 VA (0.04 W) per phase at 230 VAC and $I_b$
Base current $I_b$	5 A
Reference current $I_{ref}$	5 A
Transitional current $I_{tr}$	0.5 A
Maximum current $I_{max}$	40 A
Minimum current $I_{min}$	0.25 A
Starting current $I_{st}$	< 20 mA
Terminal wire area	0.5–10 mm <sup>2</sup>
Recommended tightening torque	0.8 Nm
<b>General data</b>	
Frequency	50 or 60 Hz ± 5%
Accuracy	1% (Cl. 1, Cl. B)
Display of energy	7-digit LCD
<b>Mechanical</b>	
Material	Polycarbonate in transparent front glass. Glass reinforced polycarbonate in bottom case and upper case. Polycarbonate in terminal cover.
Weight	190 g
<b>Environmental</b>	
Operating temperature	-25°C – +70°C
Storage temperature	-25°C – +85°C
Humidity	75% yearly average, 95% on 30 days/year.
Resistance to fire and heat	Terminal 960°C, cover 650°C (IEC 60695-2-1)
<b>Pulse output</b>	
Current	2–100 mA
Voltage	5–40 VDC
Pulse output frequency	100 imp/kWh
Pulse length	200 ms
Terminal wire area	0.5–6 mm <sup>2</sup>
Recommended tightening torque	0.8 Nm
<b>Pulse indicator(LED)</b>	
Pulse frequency	1000 imp/kWh
Pulse length	40 ms
<b>EMC compatibility</b>	

Impulse voltage test	6 kV 1.2/50µs (IEC 60060-1)
Surge voltage test	4 kV 1.2/50µs (IEC 61000-4-5)
Fast transient burst test	4 kV (IEC 61000-4-4)
Immunity to electromagnetic HF-fields	80 MHz – 2 GHz at 10 V/m (IEC61000-4-3)
Immunity to conducted disturbance	150kHz – 80MHz (IEC 61000-4-6)
Immunity to electromagnetic disturbances	2–150 kHz for kWh-meters
Radio frequency emission	EN 55022, class B (CISPR22)
Electrostatic discharge	15 kV (IEC 61000-4-2)
<b>Standards</b>	IEC 62052-11, IEC 62053-21 class 1, GB/T 17215.211-2006, GB/T 17215.321-2008 class 1 & 2, GB 4208-2008, EN 50470-1, EN 50470-3 category B

### 7.2 Physical Dimensions

**C13** The following drawing shows the physical dimensions of the C13 meter

---

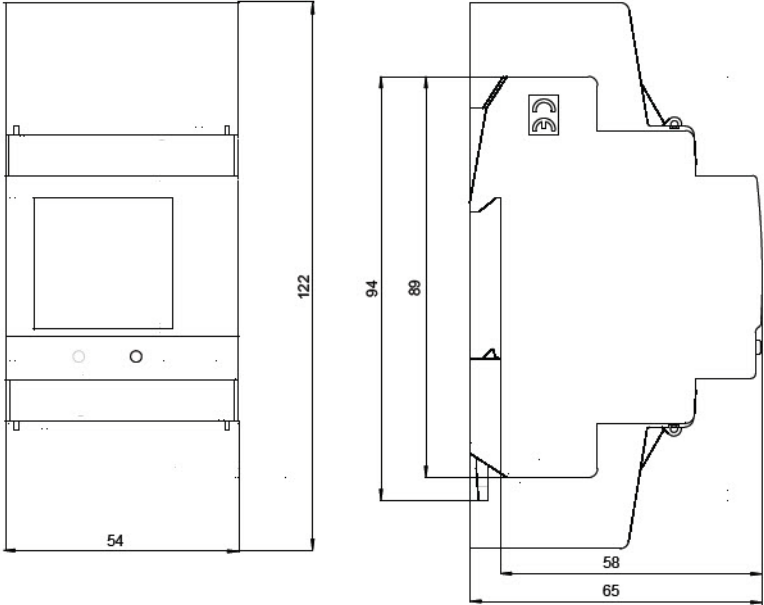



## Chapter 8: Troubleshooting

---

### Overview

This chapter describes the error codes and the warnings that can be received from the meter.

---

### In this chapter

The following topics are covered in this chapter:

8.1 Error Codes and Warnings .....	38
------------------------------------	----

### 8.1 Error Codes and Warnings

---

#### Error codes

Error code	Description
Er0041	Program CRC error
Er0042	Persistent storage CRC error
Er0051	Vref is not vdd/2
Er0052	Temperature sensor error

---

#### Warnings

Warning	Description
Er1007	Negative power
Er1008	Frequency outside meter specification

---

## Chapter 9: Service & Maintenance

---

### Overview

This chapter contains information about service and maintenance of the product.

---

---

### In this chapter

The following topics are covered in this chapter:

9.1 Service and Maintenance ..... 40

**9.1 Service and Maintenance**

---

**Service** This product contains no parts that can be repaired or exchanged. A broken meter must be replaced.

---

**Cleaning** If the meter needs to be cleaned, use a lightly moistened cloth with a mild detergent to wipe it.

**!** **Caution – Be careful that no liquid gets into the meter since it can ruin the equipment.**

---