

Data sheet TS-T/343/21 Aug 22

5STP 18F1810

Phase control thyristor

- $V_{DRM}, V_{RRM} = 1800\text{ V}$
- $I_{TAVm} = 1780\text{ A}$
- $I_{TSM} = 21000\text{ A}$
- $V_{T0} = 0.923\text{ V}$
- $r_T = 0.188\text{ m}\Omega$
- Patented free-floating silicon technology
- Low on-state losses
- Designed for energy and industrial applications
- Optimum power handling capability



Maximum rated values ¹⁾

Parameter	Symbol	Conditions	Min.	Max.	Unit
Repetitive peak off-state and reverse voltage	V_{DRM}, V_{RRM}	$T_j = -40 \div 125\text{ }^\circ\text{C}$ ²⁾		1800	V
Peak off-state current	I_{DM}	$V_D = V_{DRM}$		200	mA
Peak reverse current	I_{RM}	$V_R = V_{RRM}$		200	mA
Average on-state current	I_{TAVm}	half sine waveform, $f = 50\text{ Hz}$	$T_c = 70\text{ }^\circ\text{C}$	1780	A
RMS on-state current	I_{TRMS}	half sine waveform, $f = 50\text{ Hz}$	$T_c = 70\text{ }^\circ\text{C}$	2790	A
Non repetitive peak surge current	I_{TSM}	half sine pulse, $V_D = V_R = 0\text{ V}$	$t_p = 8.3\text{ ms}$	22400	A
			$t_p = 10\text{ ms}$	21000	A
Limiting load integral	I^2t	half sine pulse, $V_D = V_R = 0\text{ V}$	$t_p = 8.3\text{ ms}$	2080000	A ² s
			$t_p = 10\text{ ms}$	2205000	A ² s
Critical rate of rise of on-state current	$(di_T/dt)_{cr}$	$I_T = I_{TAVm}$, half sine waveform, $V_D = 2/3 V_{DRM}$, $I_{GM} = 2\text{ A}$, $t_r = 0.3\text{ }\mu\text{s}$	$f = 50\text{ Hz}$	200	A/ μs
			$f = 1\text{ Hz}$	1000	
Critical rate of rise of off-state voltage	$(dv_D/dt)_{cr}$	$V_D = 2/3 V_{DRM}$		1000	V/ μs
Maximum average gate power losses	P_{GAVm}			3	W
Peak gate current	I_{FGM}			10	A
Peak gate voltage	V_{FGM}			12	V
Reverse peak gate voltage	V_{RGM}			10	V
Operating temperature range	$T_{jmin} - T_{jmax}$		-40	125	$^\circ\text{C}$
Storage temperature range	T_{STG}		-40	140	$^\circ\text{C}$

Unless otherwise specified $T_j = 125\text{ }^\circ\text{C}$

¹⁾ Maximum rated values indicate limits beyond which damage to the device may occur per IEC 60747

²⁾ De-rating factor of 0.13% V_{RRM} or V_{DRM} per $^\circ\text{C}$ is applicable for T_j below $25\text{ }^\circ\text{C}$

Characteristic values

Parameter	Symbol	Conditions	Min.	Typ.	Max.	Unit
Threshold voltage	V_{T0}	$I_{T1} = 1000 \text{ A}, I_{T2} = 3000 \text{ A}$			0.923	V
Slope resistance	r_T				0.188	m Ω
Maximum peak on-state voltage	V_{TM}	$I_{TM} = 2000 \text{ A}$			1.300	V
Holding current	I_H		$T_j = 25 \text{ }^\circ\text{C}$	150		mA
			$T_j = 125 \text{ }^\circ\text{C}$	130		mA
Latching current	I_L		$T_j = 25 \text{ }^\circ\text{C}$	600		mA
			$T_j = 125 \text{ }^\circ\text{C}$	370		mA
Gate trigger voltage	V_{GT}		$T_j = -40 \text{ }^\circ\text{C}$		4	V
			$T_j = 25 \text{ }^\circ\text{C}$		3	V
			$T_j = 125 \text{ }^\circ\text{C}$	0.25	2	V
Gate trigger current	I_{GT}	$V_D = 12 \text{ V}, I_T = 4 \text{ A}$	$T_j = -40 \text{ }^\circ\text{C}$		1000	mA
			$T_j = 25 \text{ }^\circ\text{C}$		500	mA
			$T_j = 125 \text{ }^\circ\text{C}$	10	300	mA
Delay time	t_{gd}	$T_j = 25 \text{ }^\circ\text{C}, V_D = 0.4 V_{DRM}, I_{TM} = I_{TAVM}, I_{GM} = 2 \text{ A}, t_r = 0.3 \text{ } \mu\text{s}$			3.0	μs
Turn-off time	t_q	$I_T = 2000 \text{ A}, di_T/dt = -1.5 \text{ A}/\mu\text{s}, V_R = 200 \text{ V}, V_D = 2/3 V_{DRM}, dv_D/dt = 20 \text{ V}/\mu\text{s}$		100		μs
Recovered charge	Q_{rr}	the same conditions as at t_q		1400		μC
Reverse recovery maximum current	I_{rRM}	the same conditions as at t_q		50		A

Unless otherwise specified $T_j = 125 \text{ }^\circ\text{C}$

Hitachi Energy s.r.o.
Semiconductors
Novodvorska 1768/138a
142 21 Praha 4
Czech Republic
Tel: +420 261 306 250

E-Mail: salesdesksem@hitachienergy.com

www.hitachienergy.com/semiconductors

We reserve the right to make technical changes or modify the contents of this document without prior notice. With regard to purchase orders, the agreed particulars shall prevail.

Hitachi Energy s.r.o. does not accept any responsibility whatsoever for potential errors or possible lack of information in this document.

We reserve all rights in this document and in the subject matter and illustrations contained therein. Any reproduction, disclosure to third parties or utilization of its contents – in whole or in parts – is forbidden without prior written consent of Hitachi Energy s.r.o.

Mechanical properties

Parameter	Symbol	Conditions	Min.	Typ.	Max.	Unit
Mounting force	F_m		20	22	24	kN
Mass	m			0.45		kg
Acceleration resistance	a				50	m/s^2
Surface creepage distance	D_s		25			mm
Air strike distance	D_a		14			mm

Mechanical drawing

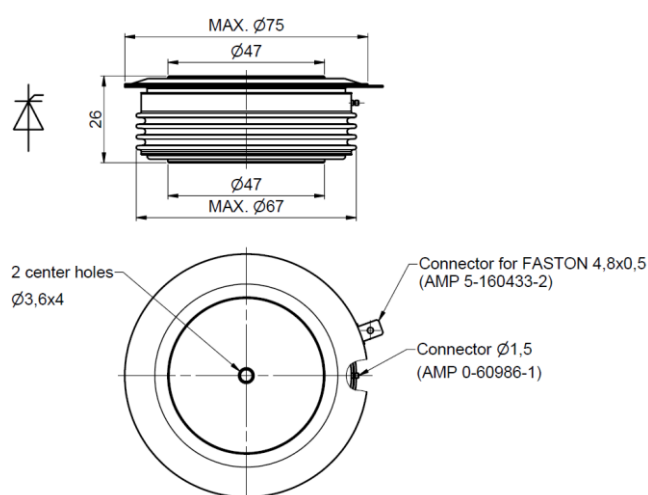

Fig. 1 Case

Note: all dimensions are shown in millimeters

Hitachi Energy s.r.o.
Semiconductors
Novodvorska 1768/138a
142 21 Praha 4
Czech Republic
Tel: +420 261 306 250

E-Mail: salesdesksem@hitachienergy.com

www.hitachienergy.com/semiconductors

We reserve the right to make technical changes or modify the contents of this document without prior notice. With regard to purchase orders, the agreed particulars shall prevail.

Hitachi Energy s.r.o. does not accept any responsibility whatsoever for potential errors or possible lack of information in this document.

We reserve all rights in this document and in the subject matter and illustrations contained therein. Any reproduction, disclosure to third parties or utilization of its contents – in whole or in parts – is forbidden without prior written consent of Hitachi Energy s.r.o.

Thermal properties

Parameter	Symbol	Conditions	Min.	Typ.	Max.	Unit
Thermal resistance junction to case	R_{thjc}	double side cooling			17.0	K/kW
		anode side cooling			33.0	
		cathode side cooling			35.0	
Thermal resistance case to heatsink	R_{thch}	double side cooling			4.0	
		single side cooling			8.0	

Analytical function for transient thermal impedance

$$Z_{th(j-c)}(t) = \sum_{i=1}^n R_i (1 - e^{-t/\tau_i})$$

i	1	2	3	4
τ_i (s)	0.4413	0.0425	0.0026	0.0003
R_i (K/kW)	10.08	4.66	2.17	0.09

Correction for periodic waveforms

180°	sine	1.5	K/kW
180°	rectangular	2.0	K/kW
120°	rectangular	3.0	K/kW
60°	rectangular	5.0	K/kW

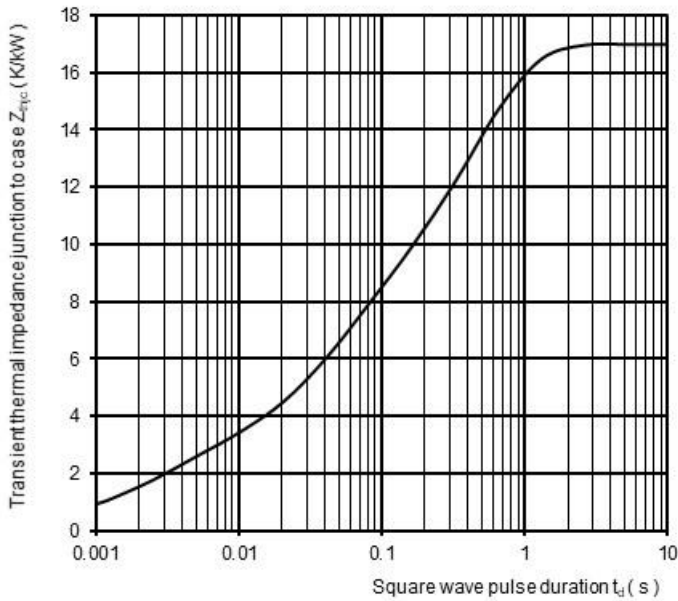

Fig. 2 Dependence transient thermal impedance junction to case on square pulse

Hitachi Energy s.r.o.
Semiconductors
Novodvorska 1768/138a
142 21 Praha 4
Czech Republic
Tel: +420 261 306 250

E-Mail: salesdesksem@hitachienergy.com

www.hitachienergy.com/semiconductors

We reserve the right to make technical changes or modify the contents of this document without prior notice. With regard to purchase orders, the agreed particulars shall prevail.

Hitachi Energy s.r.o. does not accept any responsibility whatsoever for potential errors or possible lack of information in this document.

We reserve all rights in this document and in the subject matter and illustrations contained therein. Any reproduction, disclosure to third parties or utilization of its contents – in whole or in parts – is forbidden without prior written consent of Hitachi Energy s.r.o.

On-state and surge characteristics

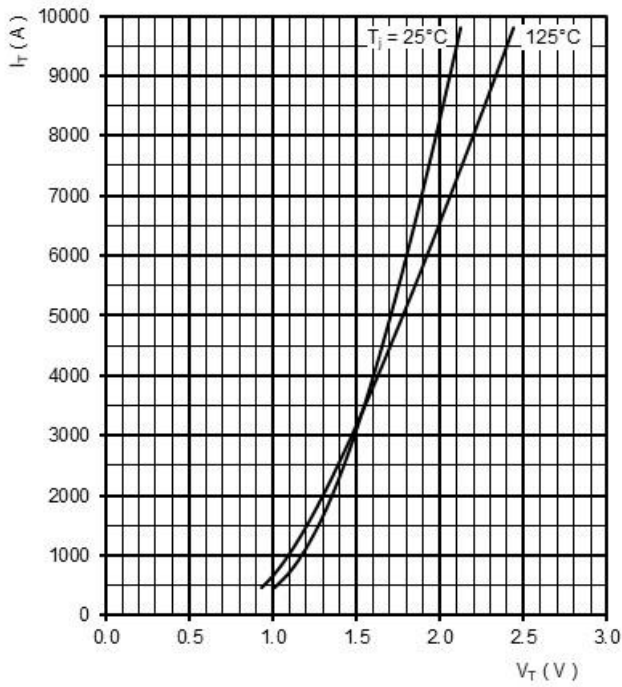

On-state characteristics model

Analytical function for maximum on-state characteristic

$$V_T = A + B \cdot I_T + C \cdot \ln(I_T + 1) + D \cdot \sqrt{I_T}$$

T_{vj}	A	B	C	D
25°C	$85.83 \cdot 10^{-3}$	$54.12 \cdot 10^{-6}$	$139.9 \cdot 10^{-3}$	$2.254 \cdot 10^{-3}$
125°C	$195.3 \cdot 10^{-3}$	$115.4 \cdot 10^{-6}$	$107.9 \cdot 10^{-3}$	$1.183 \cdot 10^{-3}$

Fig. 3 Maximum on-state characteristics

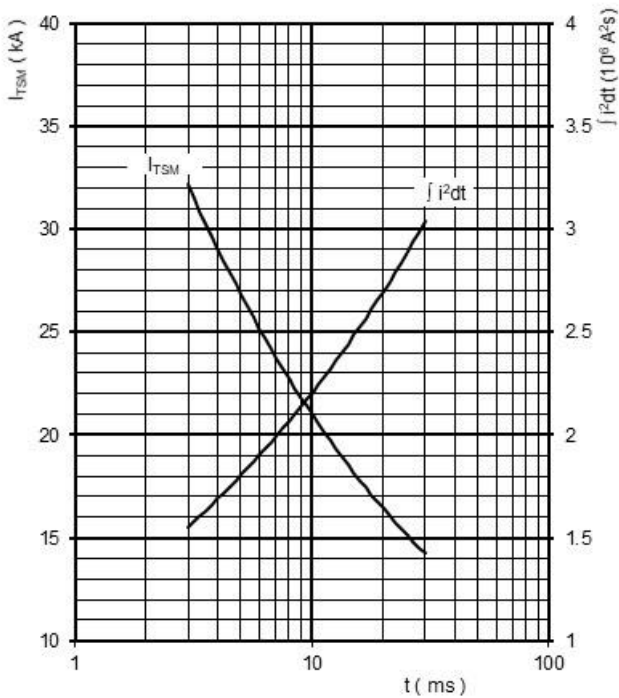

Fig. 4 Surge on-state current vs. pulse length, half sine wave, single pulse, $V_D = V_R = 0$ V, $T_j = T_{jmax}$

Hitachi Energy s.r.o.
Semiconductors
Novodvorska 1768/138a
142 21 Praha 4
Czech Republic
Tel: +420 261 306 250

E-Mail: salesdesksem@hitachienergy.com

www.hitachienergy.com/semiconductors

We reserve the right to make technical changes or modify the contents of this document without prior notice. With regard to purchase orders, the agreed particulars shall prevail.

Hitachi Energy s.r.o. does not accept any responsibility whatsoever for potential errors or possible lack of information in this document.

We reserve all rights in this document and in the subject matter and illustrations contained therein. Any reproduction, disclosure to third parties or utilization of its contents – in whole or in parts – is forbidden without prior written consent of Hitachi Energy s.r.o.

Gate trigger characteristics

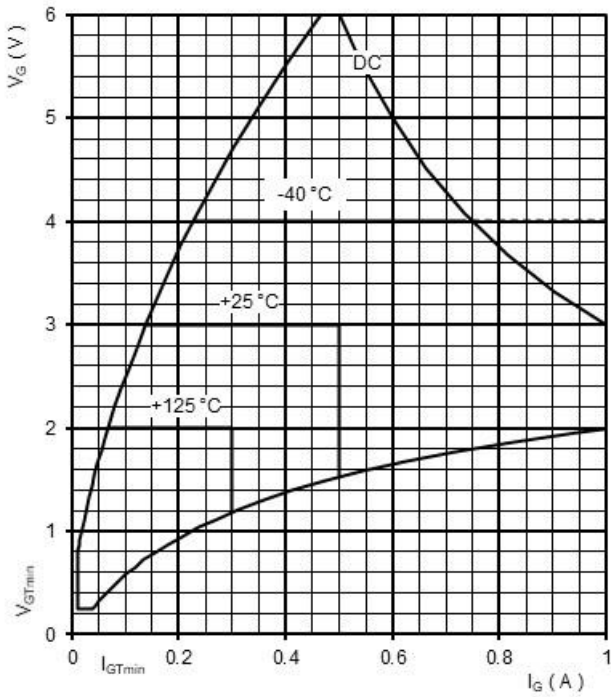

Fig. 5 Gate trigger characteristics

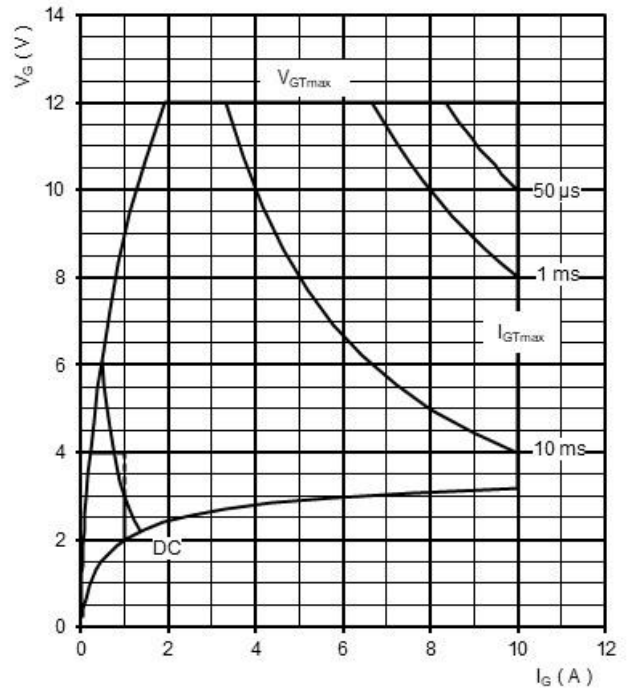

Fig. 6 Maximum peak gate power loss

Hitachi Energy s.r.o.
Semiconductors
Novodvorska 1768/138a
142 21 Praha 4
Czech Republic
Tel: +420 261 306 250

E-Mail: salesdesksem@hitachienergy.com

www.hitachienergy.com/semiconductors

We reserve the right to make technical changes or modify the contents of this document without prior notice. With regard to purchase orders, the agreed particulars shall prevail.

Hitachi Energy s.r.o. does not accept any responsibility whatsoever for potential errors or possible lack of information in this document.

We reserve all rights in this document and in the subject matter and illustrations contained therein. Any reproduction, disclosure to third parties or utilization of its contents – in whole or in parts – is forbidden without prior written consent of Hitachi Energy s.r.o.

Power loss and maximum case temperature characteristics

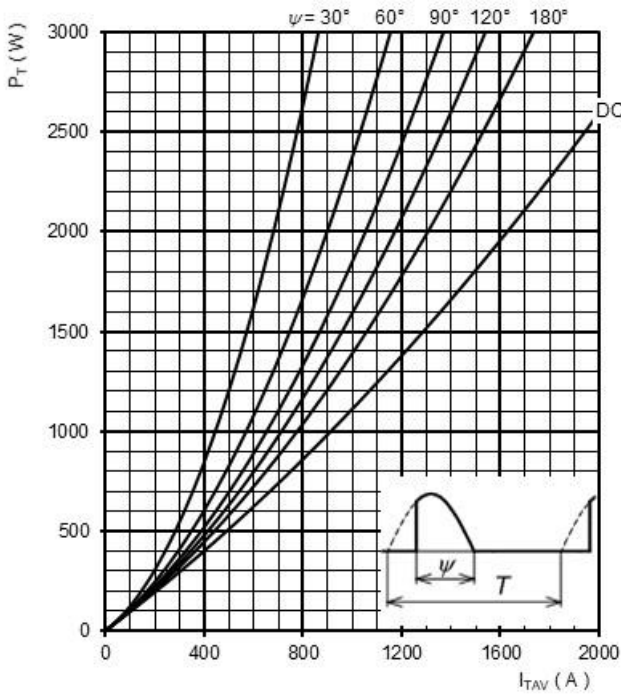

Fig. 7 On-state power loss vs. average on-state current, sine waveform, $f = 50 \text{ Hz}$, $T = 1/f$

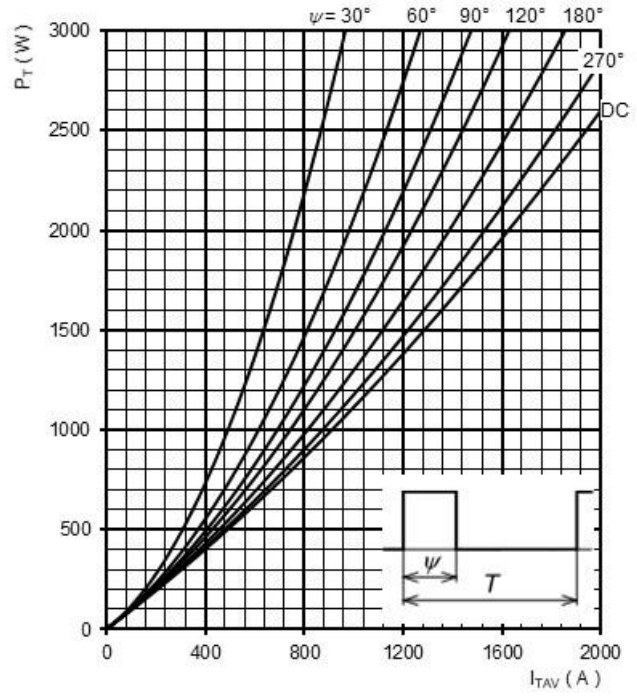

Fig. 8 On-state power loss vs. average on-state current, square waveform, $f = 50 \text{ Hz}$, $T = 1/f$

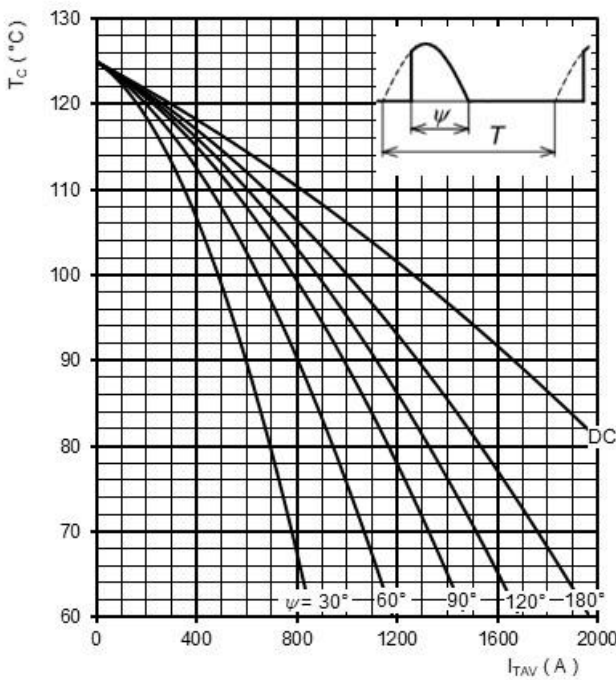

Fig. 9 Max. case temperature vs. aver. on-state current, sine waveform, $f = 50 \text{ Hz}$, $T = 1/f$

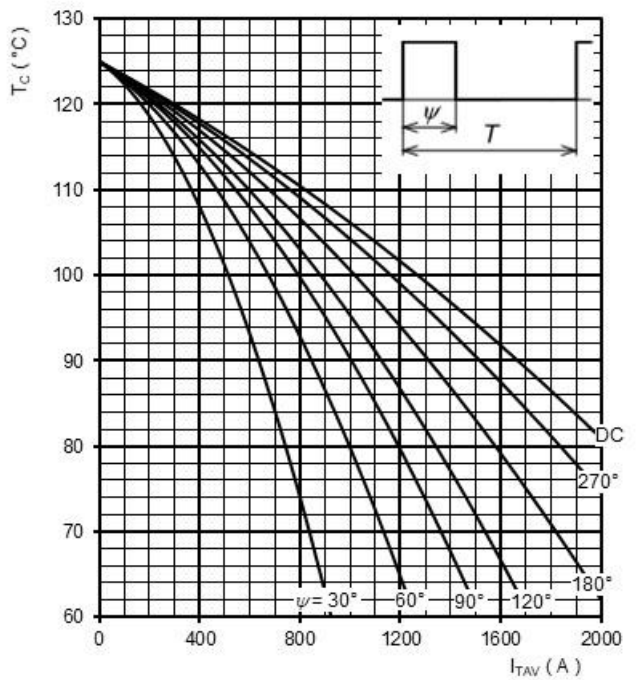

Fig. 10 Max. case temperature vs. aver. on-state current, square waveform, $f = 50 \text{ Hz}$, $T = 1/f$

Note: Figures number 7 ÷ 10 have been calculated without considering any turn-on and turn-off losses. They are valid for $f = 50$ or 60 Hz operation.

Hitachi Energy s.r.o.
Semiconductors
Novodvorska 1768/138a
142 21 Praha 4
Czech Republic
Tel: +420 261 306 250

E-Mail: salesdesksem@hitachienergy.com

www.hitachienergy.com/semiconductors

We reserve the right to make technical changes or modify the contents of this document without prior notice. With regard to purchase orders, the agreed particulars shall prevail.

Hitachi Energy s.r.o. does not accept any responsibility whatsoever for potential errors or possible lack of information in this document.

We reserve all rights in this document and in the subject matter and illustrations contained therein. Any reproduction, disclosure to third parties or utilization of its contents – in whole or in parts – is forbidden without prior written consent of Hitachi Energy s.r.o.