

Electrical installation solutions for buildings

Accessories for MCBs, RCDs, AFDDs and Switch disconnectors

Index

Selection guide	4/2
Auxiliary elements for MCBs S 200, S 300 P, SN 201, RCDs F 200, DS 200, DS201-DS202C, DS203NC, DSE201 M, AFDD S-ARC1 and Switch disconnectors SD 200,series	4/14
Auxiliary elements for MCBs, RCDs, AFDDs and Switch Disconnectors	4/25
Motor operating and autoreclosing devices for MCBs, RCDs and Switch Disconnectors	4/26
Busbars and busbars'accessories for MCBs, RCDs and AFDDs	4/30
Busbars and busbars'accessories for MCBs, RCDs and AFDDs - Selection guide	4/34
Busbars and busbars'accessories for MCBs, RCDs and AFDDs - Busbars PS	4/41
Busbars and busbars' accessories for MCBs, RCDs and AFDDs - Accessories for Busbars	4/49
Busbars and accessories for Compact RCBOs DS301C	NEW 4/54
Accessories for S 200, SN 201, F 200, DS 200 and other series	4/62
Auxiliary elements for S750 DR	4/72
Auxiliary elements for MCBs S800 series	4/73
UNIFIX rapid wiring system	4/93

Auxiliary elements for MCBs, RCDs, AFDDs and Switch Disconnectors

Selection guide

Combination of auxiliary elements with S200, S200M, S200P, S300P, DDA200 + S200 or DS200
(for S200 80-100A no combination with DDA)

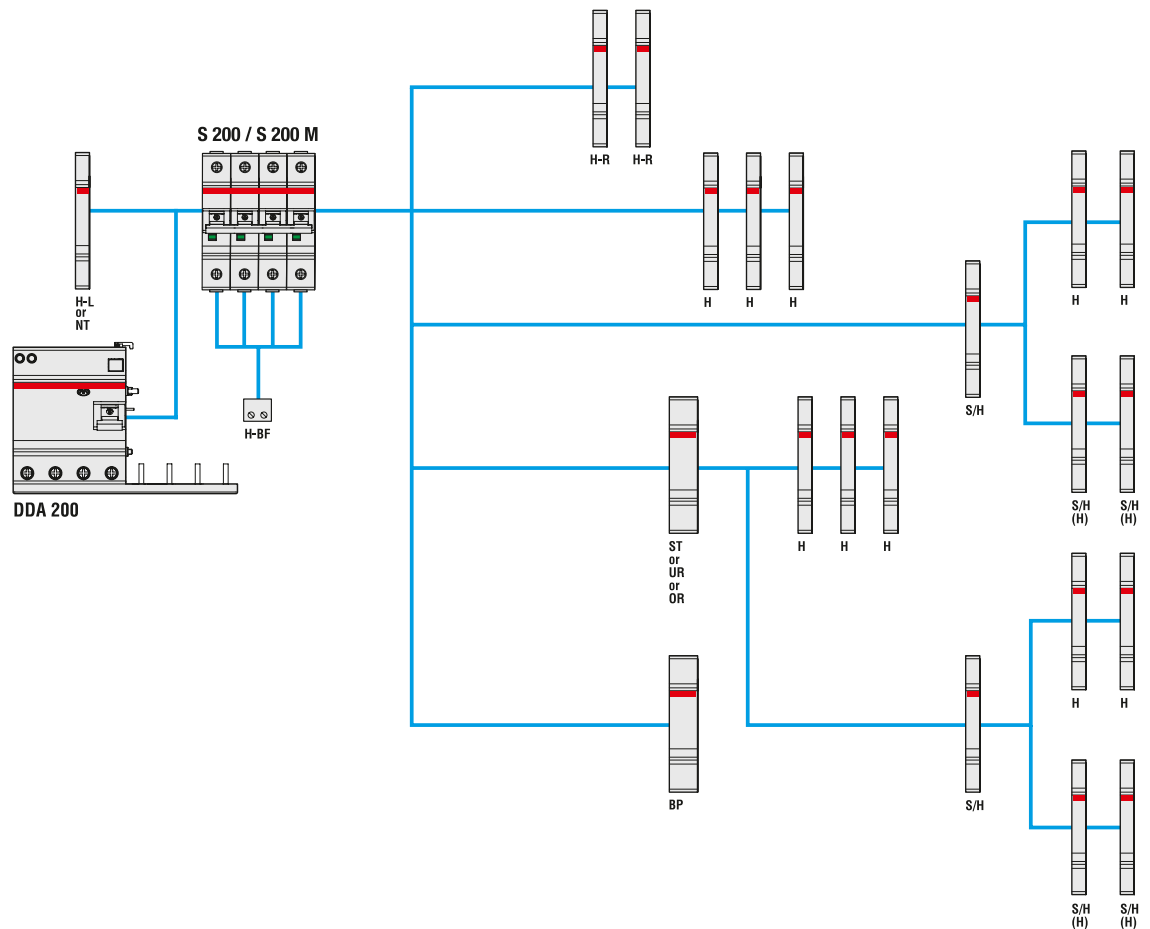

H	Auxiliary contact	S2C-H6R
H-R	Auxiliary contact	S2C-H6-...R
S/H	Signal/Auxiliary contact	S2C-S/H6R
S/H (H)	Signal/Auxiliary contact used as auxiliary contact	S2C-S/H6R
ST	Shunt trip for S 200 MCB	S2C-A...
UR	Undervoltage release	S2C-UA
OR	Overtoltage release	S2C-OVP
H-L *	Auxiliary contact for S 200 MCBs to be mounted on the left	S2C-H...L
H-BF **	Auxiliary contact for MCBs bottom fitting (1 for each pole of MCB)	S2C-H01/S2C-H10
BP	Mechanical tripping device	S2C-BP
NT	Switched neutral	S2C-Nt

In case of using rotary operating mechanism S2C-DH (only right side mountable) the auxiliary devices left side and bottom fitting auxiliary contact could be used.

* H-L and H-BF cannot be coupled with DS200.

** H-BF cannot be coupled with MCB's neutral pole.

Auxiliary elements for MCBs, RCDs, AFDDs and Switch Disconnectors

Selection guide

Combination of auxiliary elements with S200MUC

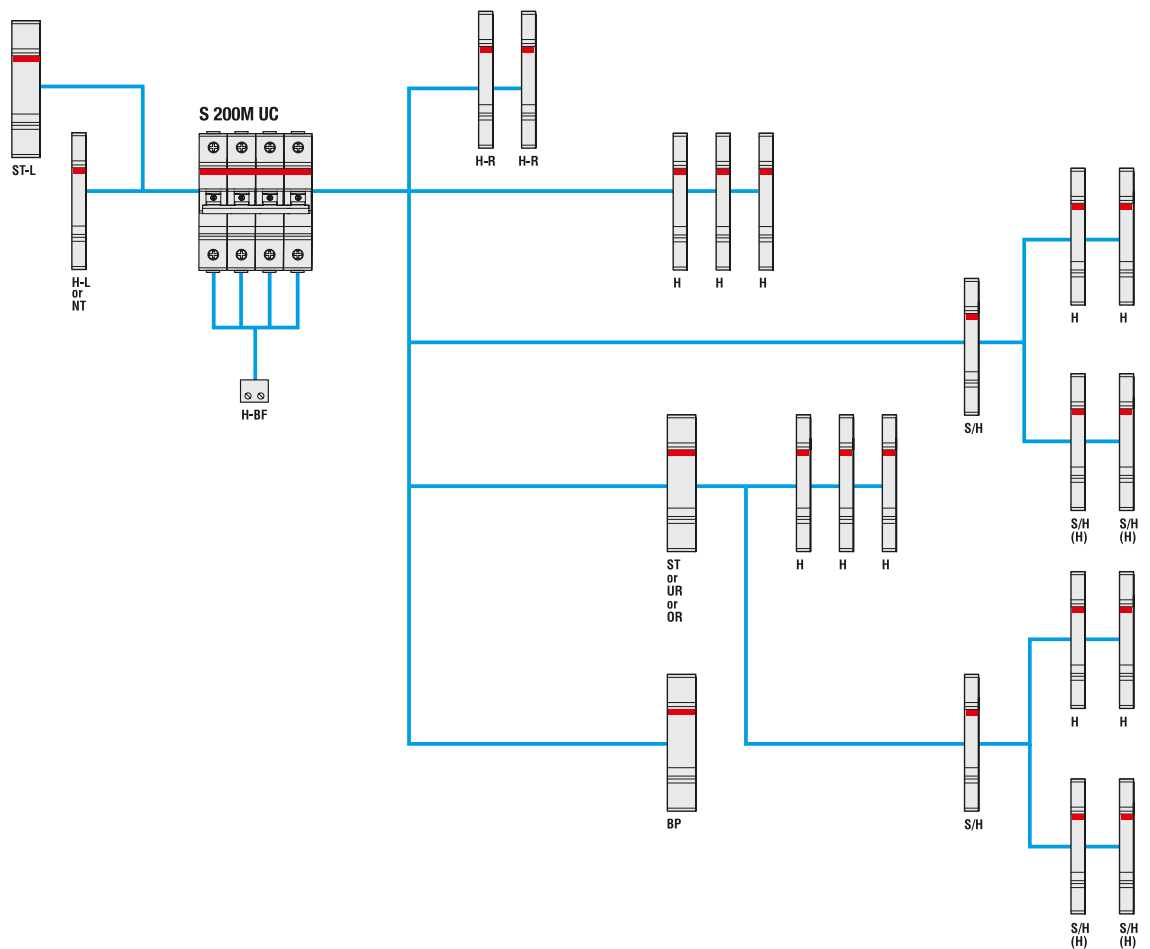

H	Auxiliary contact	S2C-H6R
H-R	Auxiliary contact	S2C-H6-...R
S/H	Signal/Auxiliary contact	S2C-S/H6R
S/H (H)	Signal/Auxiliary contact used as auxiliary contact	S2C-S/H6R
ST	Shunt trip for S 200 MCB	S2C-A...
ST-L	Shunt trip to be mounted on the left	S2C-A...L
UR	Undervoltage release	S2C-UA
OR	Oversvoltage release	S2C-OVP
H-L	Auxiliary contact for S 200 MCBs to be mounted on the left	S2C-H...L
H-BF	Auxiliary contact for MCBs bottom fitting (1 for each pole of MCB)	S2C-H01/S2C-H10
BP	Mechanical tripping device	S2C-BP
NT	Switched neutral	S2C-Nt

Auxiliary elements for MCBs, RCDs, AFDDs and Switch Disconnectors

Selection guide

Combination of auxiliary elements with S200MR

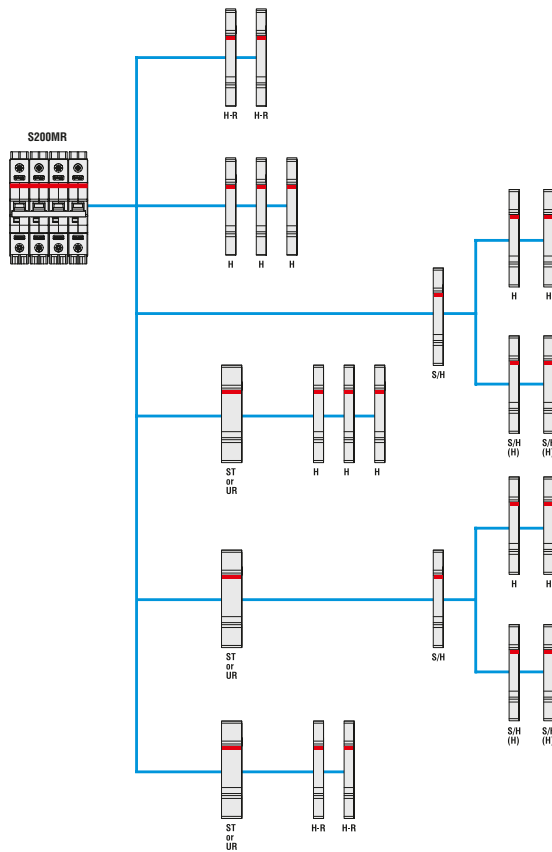

H	Auxiliary contact	S2C-H6R
H-R	Auxiliary contact	S2C-H6-...R
S/H	Signal/Auxiliary contact	S2C-S/H6R
S/H (H)	Signal/Auxiliary contact used as auxiliary contact	S2C-S/H6R
ST	Shunt trip	S2C-A...
UR	Undervoltage release	S2C-UA

Auxiliary elements for MCBs, RCDs, AFDDs and Switch Disconnectors

Selection guide

Combination of auxiliary elements with SU200M, S200UDC and SU200MR

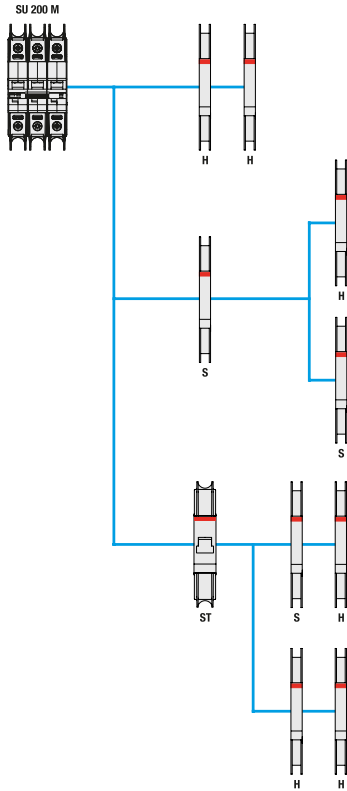

H	Auxiliary contact	S2C-H6RU
S	Signal contact	S2C-S6RU
ST	Shunt trip	S2C-A...U

Auxiliary elements for MCBs, RCDs, AFDDs and Switch Disconnectors

Selection guide

Combination of auxiliary elements with SN201

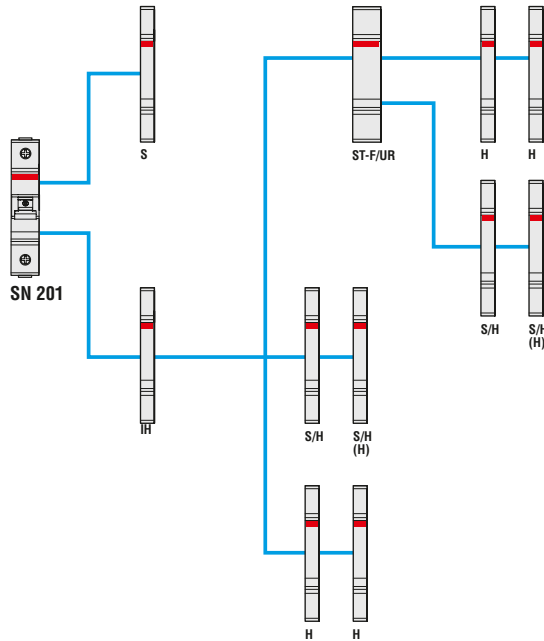

IH	Coupling interface/ auxiliary contact	SN201-IH
S	Signal contact	SN201-S
H	Auxiliary contact	S2C-H6R
S/H	Signal/auxiliary contact	S2C-S/H6R
S/H (H)	Signal/auxiliary contact used as auxiliary contact	S2C-S/H6R
ST-F	Shunt trip of F200 RCD	F2C-A
UR	Undervoltage release	S2C-UA

Auxiliary elements for MCBs, RCDs, AFDDs and Switch Disconnectors

Selection guide

Combination of S200/SD200 with motor operating device

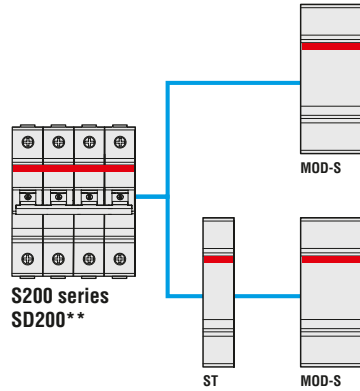

ST	Shunt trip for S 200 MCB	S2C-A...
MOD-S*	Motor operating device	S2C-CM...

* in case of using S 200 coupled with DDA 200, MOD-S doesn't operate in case of earth-leakage fault
 ** S200 series MCBs and SD200 switch disconnectors up to 3P or 2P+ST can be coupled with MOD-S

Combination of S200P, S 300 P with motor operating device

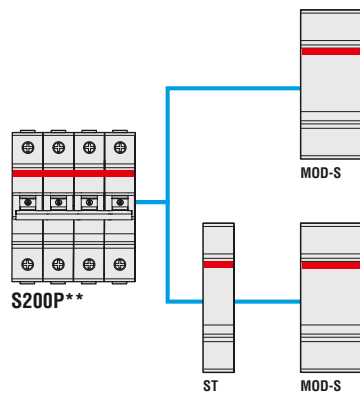

ST	Shunt trip for S 200 MCB S	S2C-A...
MOD-S*	Motor operating device	S2C-CM...

* in case of using S 200 coupled with DDA 200, MOD-S doesn't operate in case of earth-leakage fault
 ** S200P, S 300 P MCBs in all poles variants can be coupled with MOD-S and ST+MOD-S

Auxiliary elements for MCBs, RCDs, AFDDs and Switch Disconnectors

Selection guide

Combination of auxiliary elements with F200

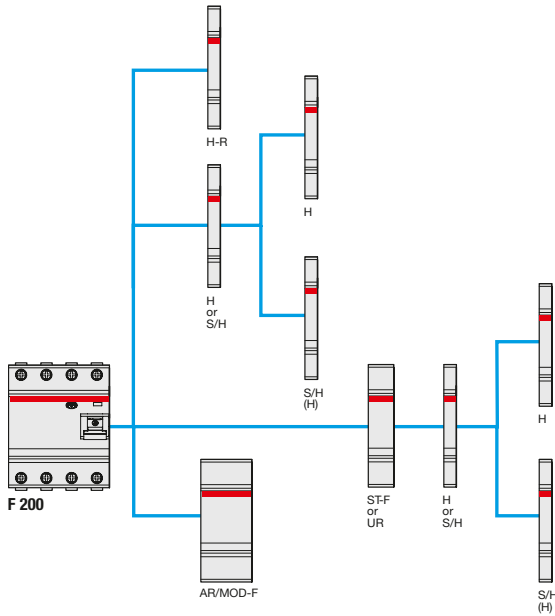

H	Auxiliary contact	S2C-H6R
S/H	Signal/Auxiliary contact	S2C-S/H6R
S/H (H)	Signal/Auxiliary contact used as auxiliary contact	S2C-S/H6R
H-R	Auxiliary contact	S2C-H6-...R
UR	Undervoltage release	S2C-UA
OR	Overvoltage release	S2C-OVP
AR	Auto reclosing unit	F2C-ARI
MOD-F	Motor operating device	F2C-CM
ST-F	Shunt trip for F 200 RCCB	F2C-A

Combination of home automatic resetting unit with F200

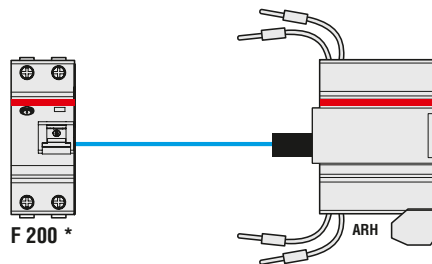

ARH	Home automatic resetting unit	F2C-ARH
------------	-------------------------------	---------

* F 202 30 mA or 100 mA (depending on ARH model), max 63 A

Combination of auxiliary elements with F204 125 A, F200 B high ratings

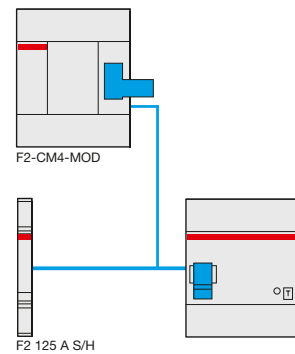

F2-125A-B-S/H	Signal/Auxiliary contact
F2-CM4-MOD	Motor operating device

Auxiliary elements for MCBs, RCDs, AFDDs and Switch Disconnectors

Selection guide

Combination of auxiliary elements with DS201, DS202C

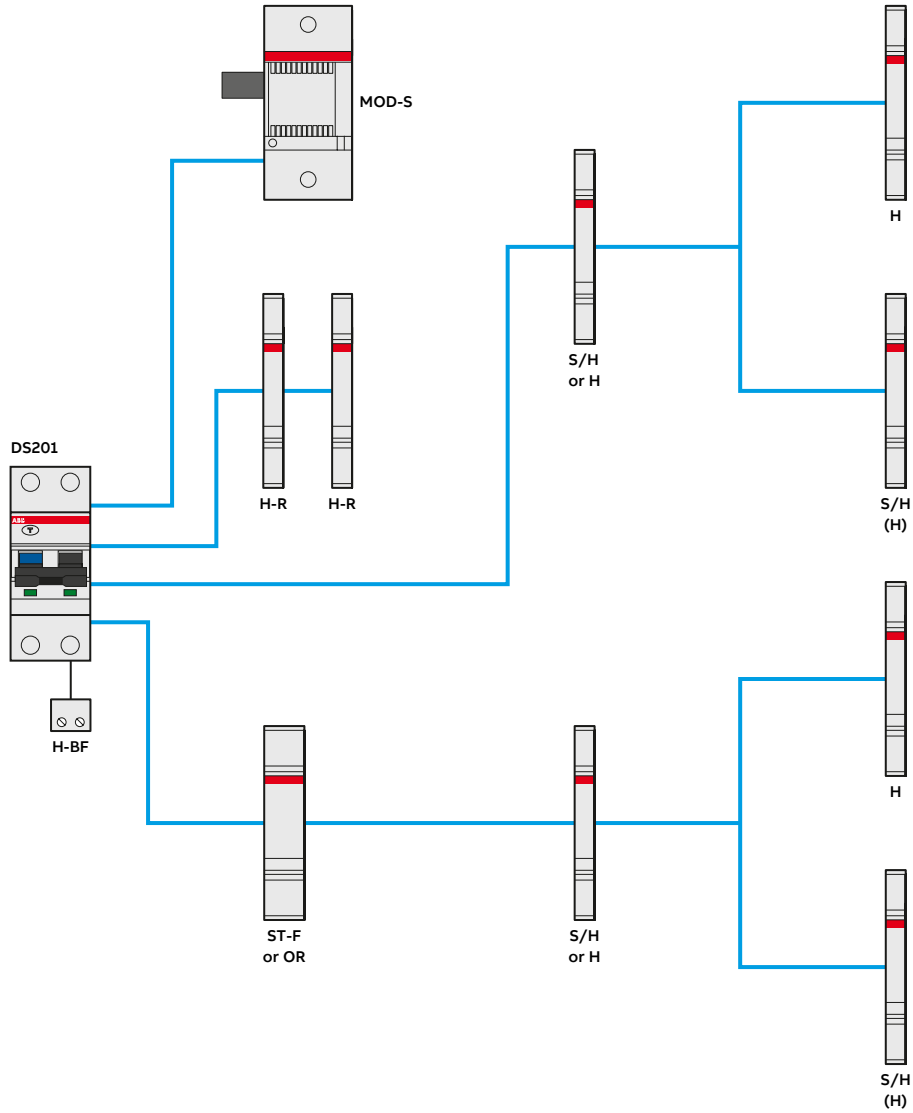

H	Auxiliary contact	S2C-H6R
H-R	Auxiliary contact	S2C-H6-xxR
S/H	Signal / auxiliary contact	S2C-S/H6R
S/H (H)	Signal / auxiliary contact used as auxiliary contact	S2C-S/H6R
ST-F	Shunt Trip	F2C-A
OR	Overtoltage release	S2C-OVP
H-BF	Auxiliary contact for bottom fitting (only DS201 (2019))	S2C-H01 / S2C-H10
MOD-S	Motor operating device (for DS201)	S2C-CM2/3
MOD-S	Motor operating device (for DS202C)	DS2C-CM

Auxiliary elements for MCBs, RCDs, AFDDs and Switch Disconnectors

Selection guide

Combination of auxiliary elements with DS203NC

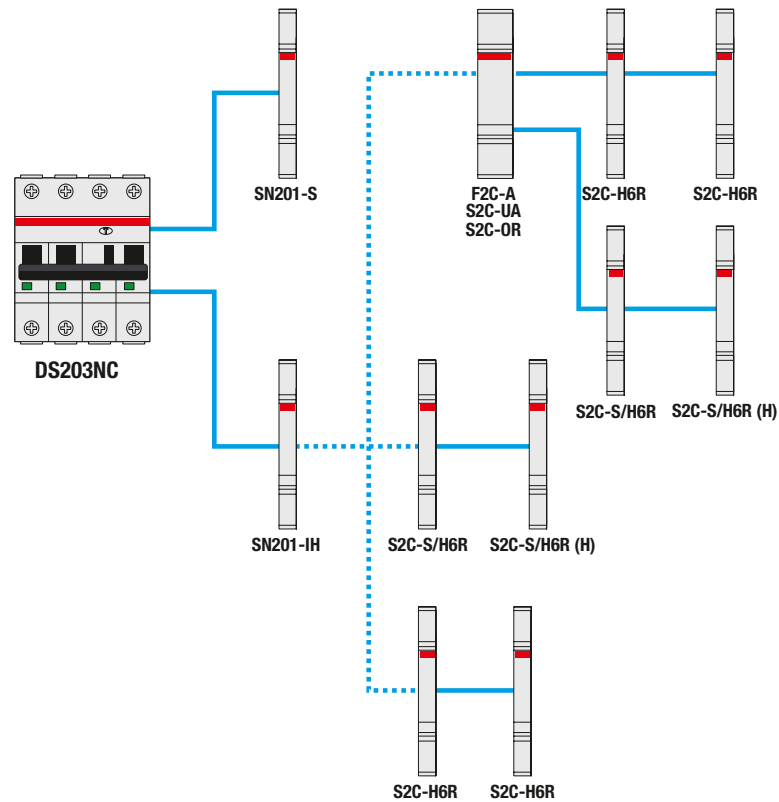

IH	coupling interface / auxiliary contact	SN201-IH
S	signal contact	SN201-S
H	auxiliary contact	S2C-H6R
S/H	signal/ auxiliary contact	S2C-S/H6R
S/H (H)	signal/ auxiliary contact used as auxiliary contact	S2C-S/H6R (H)
ST-F	shunt trip	F2C-A
UR	undervoltage release	S2C-UA
OR	overvoltage release	S2C-OR

Auxiliary elements for MCBs, RCDs, AFDDs and Switch Disconnectors

Selection guide

Combination of auxiliary elements with DSE201M

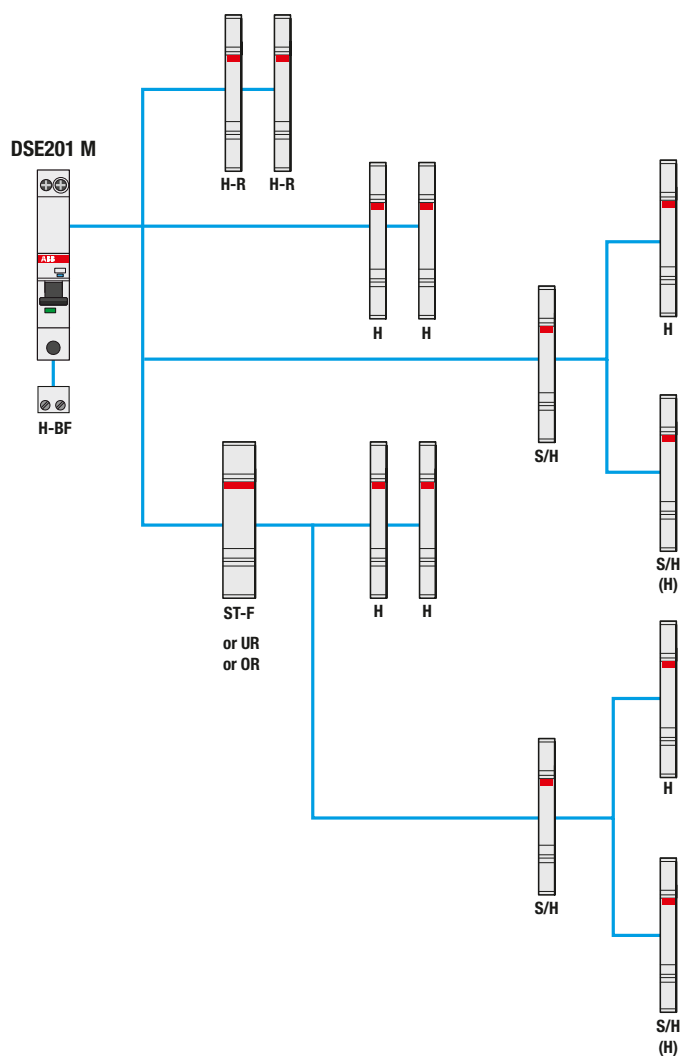

H	Auxiliary contact	S2C-H6R
H-R	Auxiliary contact	S2C-H6R / S2C-H6-xxR
S/H	Signal/Auxiliary contact	S2C-S/H6R
S/H (H)	Signal/Auxiliary contact used as auxiliary contact	S2C-S/H6R
ST-F	Shunt trip for RCD	F2C-A
UR	Undervoltage release	S2C-UA
OR	Overtoltage release	S2C-OVP
H-BF	Auxiliary contact for bottom fitting	S2C-H01 / S2C-H10

Auxiliary elements for MCBs, RCDs, AFDDs and Switch Disconnectors

Selection guide

Combination of auxiliary elements with S-ARC1 and S-ARC1M

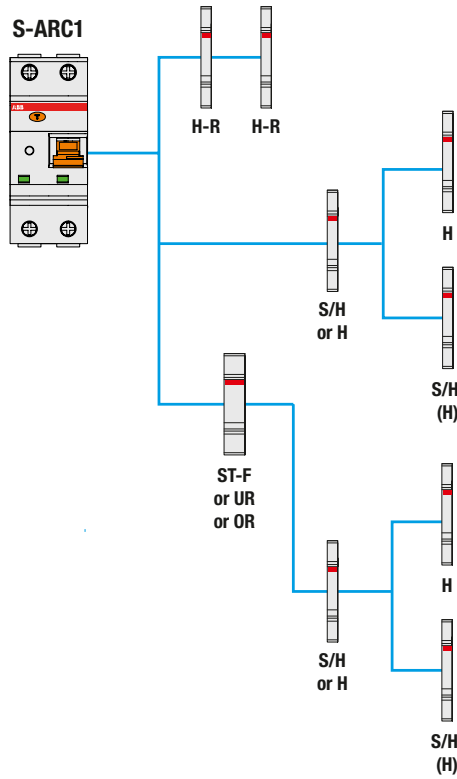

Combination of auxiliary elements with DS-ARC1

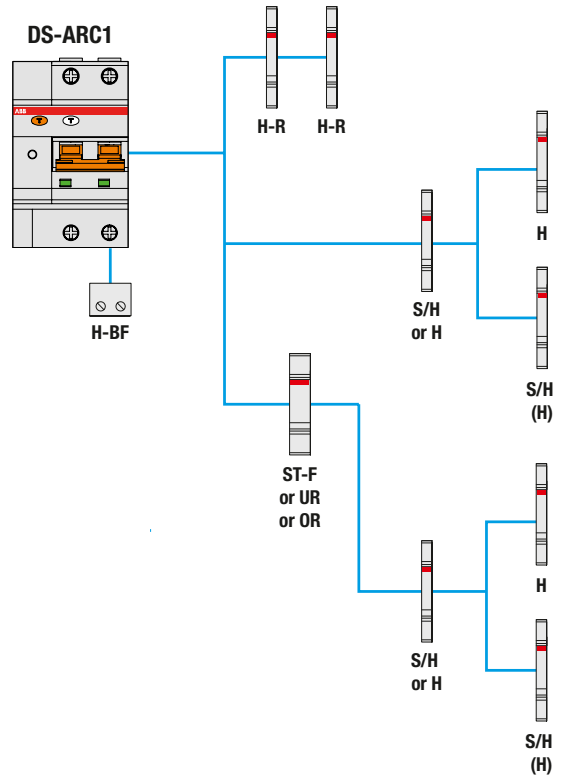

H	Auxiliary contact	S2C-H6R
H-R	Auxiliary contact	S2C-H6R / S2C-H6-xxR
S/H	Signal/Auxiliary contact	S2C-S/H6R
S/H (H)	Signal/Auxiliary contact used as auxiliary contact	S2C-S/H6R
ST-F	Shunt trip for RCD	F2C-A
UR	Undervoltage release	S2C-UA
OR	Overvoltage release	S2C-OVP

H	Auxiliary contact	S2C-H6R
H-R	Auxiliary contact	S2C-H6R / S2C-H6-xxR
S/H	Signal/Auxiliary contact	S2C-S/H6R
S/H (H)	Signal/Auxiliary contact used as auxiliary contact	S2C-S/H6R
ST-F	Shunt trip for RCD	F2C-A
UR	Undervoltage release	S2C-UA
OR	Overvoltage release	S2C-OVP
H-BF	Auxiliary contact for bottom fitting	S2C-H01 / S2C-H10

Auxiliary elements for MCBs, RCDs, AFDDs and Switch Disconnectors

Selection guide

Combination of auxiliary elements with SD200

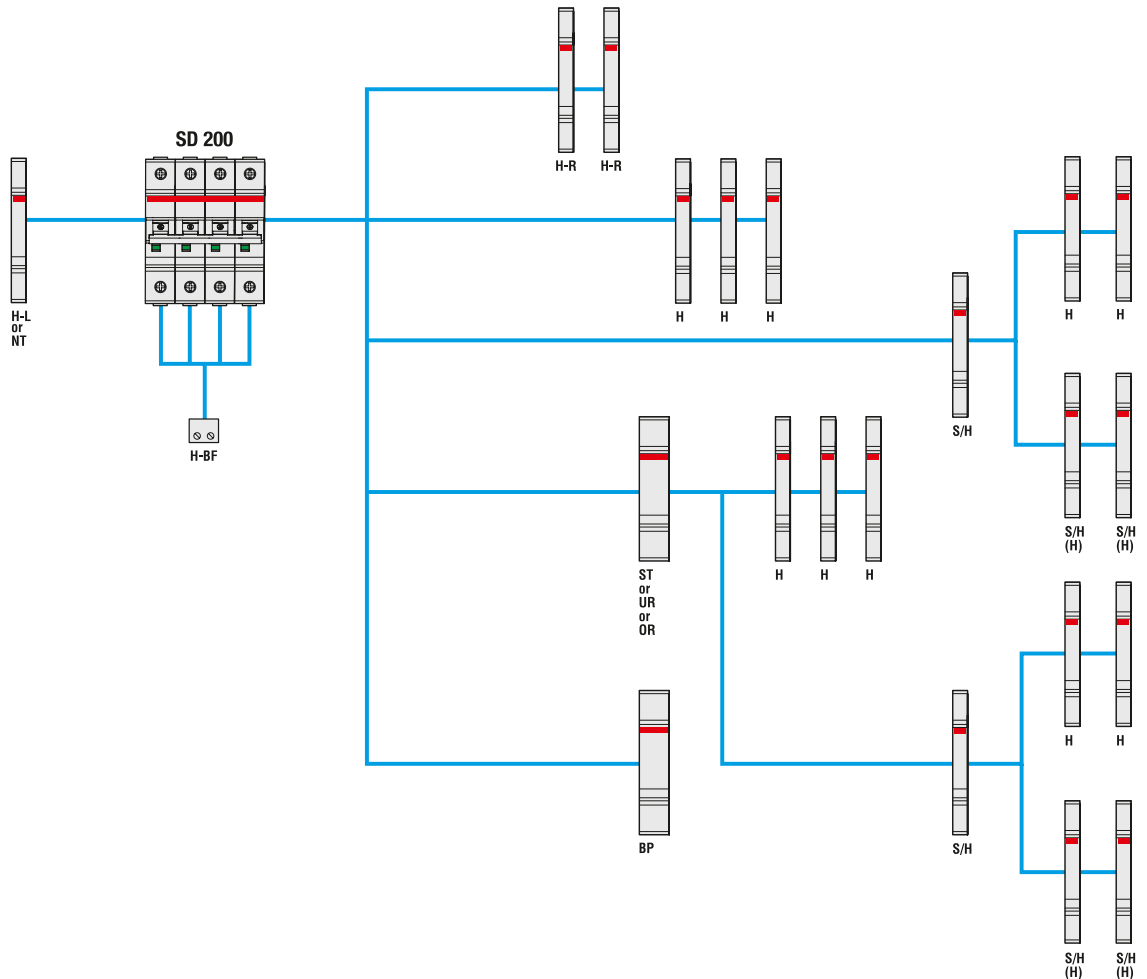

H	Auxiliary contact	S2C-H6R
H-R	Auxiliary contact	S2C-H6-...R
S/H	Signal/Auxiliary contact	S2C-S/H6R
S/H (H)	Signal/Auxiliary contact used as auxiliary contact	S2C-S/H6R
NT	Switched neutral	S2C-Nt
OR	Overtoltage release	S2C-OVP
BP	Mechanical tripping device	S2C-BP
ST	Shunt trip	S2C-A...
UR	Undervoltage release	S2C-UA

Auxiliary elements for MCBs, RCDs, AFDDs and Switch Disconnectors

Auxiliary and signal contacts



Auxiliary elements

Auxiliary contact and signal/auxiliary contact		
S2C-S/H6R, S2C-H6R, S2C-H11L, S2C-H20L and S2C-H02L		
Suitable for		MCBs S200 series, S300P, SN201, RCDs F200, DS200, DS201-DS202C, DS203NC, DSE201M, AFDDs S-ARC1, DS-ARC1 and Switch disconnectors SD200
Utilization category		AC14 1A/400V, 2A/230V - DC12 1A/220V, 1,5A/110V - DC13 2A/60V, 4A/24V
Conventional free air thermal current	A	10
Min. operational current/voltage*		10 mA at 12 V; 5 mA at 24 V
Rated conditional short-circuit current	V	230 V AC 1,000 A with S201 K4
Overvoltage category		III
Rated impuls withstand voltage (1.2/50µs)	kV	4
Cross-section of conductors	mm ²	0.75...2.5 (up to 2 x 1.5 mm ² for S2C-H11L, S2C-H20L and S2C-H02L)
Tightening torque	Nm	1.2 (max. 0.8 for S2C-H11L, S2C-H20L and S2C-H02L)
Contact stability in vibration test according to IEC/EN 60 068-2-6		5g, 20 sweep cycles 5...150...5 Hz at 24 V AC/DC, 5 mA automatic reclosing < 10 ms
Mechanical service life		10000 operations
Dimensions (H x D x W)	mm	85 x 69 x 8.8

Auxiliary contact and signal/auxiliary contact		
S2C-H6-11R, S2C-H6-20R, S2C-H6-02R		
Suitable for		MCBs S200 series, S300P, SN201, RCDs F200, DS200, DS201-DS202C, DS203NC, DSE201M, AFDDs S-ARC1, DS-ARC1 and Switch disconnectors SD200
Utilization category		AC14: 1A/400V, 2A/230V DC12/DC13: 1A/50V, 2A/30V
Conventional free air thermal current	A	10
Min. rated operational current/voltage*		10 mA at 12 V; 5 mA at 24 V
Rated conditional short-circuit current	V	230 V AC 1,000 A with S201 K4
Overvoltage category		III
Rated impuls withstand voltage (1.2/50µs)	kV	4
Cross-section of conductors	mm ²	0.75...2.5
Tightening torque	Nm	1.2
Contact stability in vibration test according to IEC/EN 60068-2-6		5g, 20 sweep cycles 5...150...5 Hz at 24 V AC/DC, 5mA automatic reclosing < 10 ms
Mechanical service life		10000 operations
Dimensions (H x D x W)	mm	85 x 69 x 8.8

* ensures safe contacting without current interruption by pollution layer

Auxiliary elements for MCBs, RCDs, AFDDs and Switch Disconnectors

Auxiliary and signal contacts



S2C-S/H6R

Signal/auxiliary contacts

Signal contacts indicate if a device tripped due to a failure (overcurrent/short-circuit for MCBs and RCBOs; earth fault for RCCBs and RCBOs). Auxiliary contacts indicate the position of the contacts, independent if a failure occurred or the device was operated manually.

S2C-S/H6R: choice through a selector between signal and auxiliary contact.

S2C-H6R and S2C-HxxR: Auxiliary contacts with contact configuration according the following table. All right-side mounted contacts are suitable for MCBs, RCDs, AFDD and switch disconnectors SD200 according the "Selection tables" which are displayed in the beginning of chapter 4.

S2C-HxxL: Auxiliary contacts with contact configuration according the following table. These contacts are left-side mounted and fit to S200 MCBs and switch disconnectors SD200 according the "Selection tables" which are displayed in the beginning of chapter 4. Especially when using a motor operating device this is a possibility to add a contact as the right side mounted ones do not fit within this combination.

S2C-Hxx: Unique bottom-fitting contact for the S200 compact range, DS201 (2019), DSE201M and SD200 switch disconnectors. Simple and space-saving solution. Also intended for retrofitting.



S2C-H6...

Description	Bbn	Order details		Price	Weight	Pack
	4016779	EAN	Type code	1 piece	1 piece	unit
			Order code		kg	pc.
Signal contact/ auxiliary switch 1CO	563819	S2C-S/H6R	2CDS200922R0001		0.04	1
Auxiliary contact 1CO	563826	S2C-H6R	2CDS200912R0001		0.04	1
Auxiliary contact 1NO/1NC	697941	S2C-H6-11R	2CDS200946R0001		0.04	1
Auxiliary contact 2NO	697958	S2C-H6-20R	2CDS200946R0002		0.04	1
Auxiliary contact 2NC	697965	S2C-H6-02R	2CDS200946R0003		0.04	1

Auxiliary contacts mounting on the left side

Description	Bbn	Order details		Price	Weight	Pack
	4016779	EAN	Type code	1 piece	1 piece	unit
			Order code		kg	pc.
Auxiliary contact 1 NO/1NC	648820	S2C-H11L	2CDS200936R0001		0.04	1
Auxiliary contact 2 NO	648837	S2C-H20L	2CDS200936R0002		0.04	1
Auxiliary contact 2 NC	648844	S2C-H02L	2CDS200936R0003		0.04	1

Auxiliary elements for MCBs, RCDs, AFDDs and Switch Disconnectors

Auxiliary and signal contacts



S 2C-H01

Bottom-fitting auxiliary contact		
S2C-H10 and S2C-H01		
Suitable for		MCBs S200 series, S300P, RCDs DS201, DSE201M, AFDDs DS-ARC1 and Switch disconnectors SD200
Conventional free air thermal current	A	7.5
Utilization category		AC14 2A/230V - DC 12 identical DC13 1A /50V, 2A/30V
Min. operational current/voltage*	V	10 mA at 12 V AC/DC
Rated conditional short-circuit current		230 VAC 1000 A, fault protection with S 201-K2 or Z2
Tightening torque	Nm	0.5
Cross-section of conductors	mm ²	0.75 to 2.5
Mechanical service life		4 000 operations
Dimensions (HxDxW)		19 x 17 x 17.5

* ensures safe contacting without current interruption by pollution layer

Bottom-fitting auxiliary contacts for S 200, S 200 M, S 200 P, S 300 P, S 200 S, SD 200, DS201 (2019), DSE201 M, DS-ARC1

Description	Bbn 4016779	Order details		Price 1 piece	Weight 1 piece	Pack unit
		EAN	Type code			
1 NC	065108	22C-H01	2CDS200970R0031		0.01	1
1 NO	065139	S 2C-H10	2CDS200970R0032		0.01	1

packing unit 15 parts

Description	Bbn 4016779	Order details		Price 1 piece	Weight 1 piece	Pack unit
		EAN	Type code			
1 NC	065160	S 2C-H01 15x	2CDS200970R0041		0.01	15
1 NO	065191	S 2C-H10 15x	2CDS200970R0042		0.01	15



HKB

Auxiliary contact bridge for bottom-fitting auxiliary contacts

Wire jumper for integrated auxiliary contact S2C-H01/S2C-H10 for series connections (HKB) or parallel connections (HKB1).

Description	Bbn 4016779	Order details		Price 1 piece	Weight 1 piece	Pack unit
		EAN	Type code			
1/2 mod.	523134	HKB	GHV0360504R0100		0.001	1000
1 mod.	524209	HKB 1	GHV0360504R0101		0.001	1000

Signal and auxiliary contacts

		SN201-S	SN201-IH
Terminals	mm ²	2x1,5	
Tightening torque	N	1.2	
Dimensions	mm	H: 85 x D: 68 x W: 8.9	H: 85 x D: 68,7 x W: 8.9
Rated voltage	V	230	
Rated current	A	2	

Auxiliary elements for MCBs, RCDs, AFDDs and Switch Disconnectors

Auxiliary and signal contacts



SN201-S

SN201-S, SN201-IH					
Utilization category / contact capacity					
AC14	Ue	V	400	230	
	Ie	A	1	2	
DC12	Ue	V	220	110	
	Ie	A	1	1,5	
DC13	Ue	V	60	24	
	Ie	A	2	4	

Signal contact for SN201 MCBs and DS203NC RCBOs

Function: indication of the device contact positions only after the automatic release of the MCBs/RCBOs due to overcurrent.



SN201-IH

Description	Bbn	Order details		Price	Weight	Pack
	8012542	EAN	Type code	Order code	1 piece	1 piece unit
					kg	pc.
Signal contact 1CO	104957	SN201-S	2CSS200924R0001		0.040	1

Auxiliary contact / interface module for SN201 MCBs and DS203NC RCBOs

Function: indication of the device contact positions. The auxiliary contact can be used as an interface module between SN201, DS203NC and other compact auxiliary elements.

Description	Bbn	Order details		Price	Weight	Pack
	8012542	EAN	Type code	Order code	1 piece	1 piece unit
					kg	pc.
Interface module/Aux. Contact 1CO	104858	SN201-IH	2CSS200923R0001		0.050	1

Signal and auxiliary contacts for F 200 125A and F 200 B 80-100 A

F2 125A-S/H			
Rated current	AC	A	6
	DC	A	1
Min. rated voltage Ub min	AC	V	230
	DC	V	110
Connection cross section		mm ²	1...1.5
Tightening torque		Nm	0.8
Dimensions (H x D x W)		mm	85 x 69 x 8.8

Auxiliary/Signal contact for F 200 125A and F 200 B 80-100 A

Function: choice through a selector between indication of the position of the device's contacts and signalling of the earth fault. Suitable for RCCBs F 200 125A and F 200 B 80-100 A series



F2-125A-B-S/H

Description	Bbn	Order details		Price	Weight	Pack
	8012542	EAN	Type code	Order code	1 piece	1 piece unit
					kg	pc.
Auxiliary/Signal contact 1CO+1NC	600527	F2-125A-B-S/H	2CSF200922R0001		0.04	1

Clamping cover for F200 125A-F200 B type

Description	Bbn	Order details		Price	Weight	Pack
	4016779	EAN	Type code	Order code	1 piece	1 piece unit
					kg	pc.
	999638	CPV B	2CSF200988R0001			1

Auxiliary elements for MCBs, RCDs, AFDDs and Switch Disconnectors

Auxiliary and signal contacts

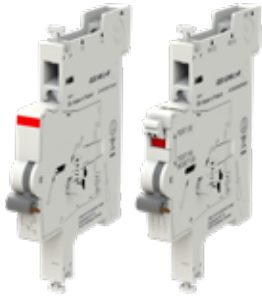

G2C

G2C-S

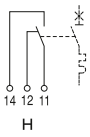

H

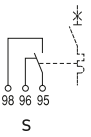

S

G2C: Auxiliary and signal contact

Auxiliary (H):

Provides the status of the protection device, OPEN/CLOSED.

Auxiliary or signal (S/H):

This device can act as an auxiliary contact (function H) or as a signal contact (function S).

The user can change the function at the moment of installation.

Used as signal contact (function S) it provides the information about the automatic tripping of the protection devices: overload or short-circuit for MCBs, earth leakage tripping for RCDs.

- Test button on the front to simulate the function (acting as a function H or S)
- Reset button for the contacts (function S)
- Tripping signal on the front (function S)
- Version with golden contacts, available for low current as well as low voltage applications.

Mounting:

on the left or right, up to 4 G2C units (On S203C accepted only on the left)

Performances

Suitable for	MCBs S200C and RCBOs DS202CR
Product standard	IEC/EN 62019
Change-over contacts	1
Rated current I_n (A)	5
Rated voltage AC U_n (V)	240
Minimum application voltage	24 V AC/DC; 12 V AC/DC for version with golden contacts
Minimum application current	10 mA AC; 200 mA DC -- 2 mA AC; 25 mA DC for version with golden contacts
Electrical endurance (operations)	10000
Terminal capacity flexible/rigid cable (mm ²)	0.75...2.5 / 1...2.5
Terminal capacity for two rigid cables (mm ²)	2 × 1.5
Dimension [D×W×H] (mm)	69 × 8.7 × 92
Net weight (g)	70
Tightening torque (Nm)	0.5

Ordering code

Type	Bbn 4053546 EAN	Order details		Weight 1 piece kg	Pack unit pc.
		Type code	Order code		
Auxiliary (H)	046427	G2C-H6 L+R	2CDS200931R0001	0.07	1
Auxiliary or signal (S/H)	046434	G2C-S/H6 L+R	2CDS200932R0001	0.07	1
Auxiliary or signal golden contact (S/H G)	046441	G2C-S/H6 L+R KL	2CDS200932R0011	0.07	1

Auxiliary elements for MCBs, RCDs, AFDDs and Switch Disconnectors

Shunt trip



S2C-A

Shunt trip for S200 and S300P MCBs								
S2C-A1								
Rated voltage	AC	V	12...60					
	DC	V	12...60					
Max release duration		ms	<10 @ Rated voltage					
Min. release voltage	AC	V	8.4					
	DC	V	10					
Power consumption	U _b	V	12 VDC	12 VAC	24 VDC	24 VAC	60 VDC	60 VAC
	I _{b_{max}} /A	A	3.4	3.4	6.5	6.5	16.5	16.5
Coil resistance		Ω	3.7					
Terminals	Fale-safe bi-directional cylinder-lift-terminal							
Tightening torque		Nm	2.8					
Dimensions (H x D x W)		mm	85 x 69 x 17.5					
S2C-A2								
Rated voltage	AC	V	110...415					
	DC	V	110...250					
Max release duration		ms	<10 @ Rated voltage					
Min. release voltage	AC	V	8.4					
	DC	V	10.0					
Power consumption	U _b	V	110 VDC	110 VAC	220 VDC	230 VAC	415 VAC	
	I _{b_{max}} /A	A	0.5	0.5	1.1	1.1	2.1	
Coil resistance		Ω	225					
Terminals	Fale-safe bi-directional cylinder-lift-terminal							
Tightening torque		Nm	2.8					
Dimensions (H x D x W)		mm	85 x 69 x 17.5					

Shunt trips

Function: remote opening of the device when a voltage is applied. Suitable for MCBs S 200 series, RCBOs DS 200 series, SD 200 switch disconnectors series.

Shunt trips use a coil like MCBs for tripping. To trip a shunt it is necessary to choose the right voltage and make sure the corresponding I_{bmax} (as mentioned in the table above) is provided by the power supply used. If the power supply can provide higher currents the shunt trip will reduce the current to I_{bmax} due to its internal resistance.

As soon as the shunt tripped, the contact inside is open – the electrical circuit is disconnected even if the shunt trip is still powered on. The free-tripping mechanism of the shunt trip allows a restart of the MCB only after the shunt trip gets no external release signal anymore.

Rated voltage	Bbn	Order details		Price	Weight	Pack
	4016779	Type code	Order code	1 piece	1 piece	unit
	EAN			kg	pc.	
AC/DC 12...60 V	570992	S2C-A1	2CDS200909R0001	0.15	1	
AC 110...415 V/DC110...250 V	571005	S2C-A2	2CDS200909R0002	0.15	1	

Auxiliary elements for MCBs, RCDs, AFDDs and Switch Disconnectors

Shunt trip



F2C-A

Shunt trip for F 200 RCCBs							
F2C-A1							
Rated voltage	AC	V	12...60				
	DC	V	12...60				
Max release duration		ms	10				
Min. release voltage	AC	V	6				
	DC	V	4.5				
Consumption on release	Ub	V	12 DC	12 AC	24 DC	60 DC	60 AC
	Ib max	A	0.88	0.65	1.58	5.8	5
Coil resistance		Ω	5.5				
Terminals		mm ²	2x1.5				
Tightening torque		Nm	0.2				
Dimensions (H x D x W)		mm	85 x 69 x 17.5				
F2C-A2							
Rated voltage	AC	V	110...415				
	DC	V	110...250				
Max release duration		ms	10				
Min. release voltage	AC	V	75				
	DC	V	55				
Consumption on release	Ub	V	110 DC	110 AC	250 DC	415 AC	
	Ib max	A	0.05	0.03	0.1	0.16	
Coil resistance		Ω	1355				
Terminals		mm ²	2x1.5				
Tightening torque		Nm	0.2				
Dimensions (H x D x W)		mm	85 x 69 x 17.5				

Function: remote opening of the device when a voltage is applied. Suitable for RCCBs F 200 series and RCBOs DS201, DS201 (2019), DS202C, DSE201 M, AFDD S-ARC1.

It can be used with MCBs SN201 and RCBOs DS203NC series by means of SN201-IH interface module.

Rated voltage	Bbn	Order details			Price	Weight	Pack
	8012542				1 piece	1 piece	unit
	EAN	Type code	Order code		kg	pc.	
AC/DC 12...60V	974901	F2C-A1	2CSS200933R0011		0.15	1	
AC 110...415V / DC 110...250V	975007	F2C-A2	2CSS200933R0012		0.15	1	

Auxiliary elements for MCBs, RCDs, AFDDs and Switch Disconnectors

Undervoltage release



S2C-UA

Undervoltage release			S2C-UA 12 DC	S2C-UA 24 AC	S2C-UA 24 DC	S2C-UA 48 AC	S2C-UA 48 DC
Suitable for			MCBs S200 series, S300P, SN201, RCDs F200, DS200, DS201-DS202C, DS203NC, DSE201M, AFDDs S-ARC1, DS-ARC1 and Switch disconnectors SD200				
Standards			IEC/EN 60947-1				
Rated voltage	AC	V	24		48		
	DC	V	12	24		48	
Frequency		Hz	50...60				
Release trip		V	0.35 Un \geq V \geq 0.7 Un				
Terminals		mm ²	2x1.5				
Consumption		VA	2.2	3.6	2	3.6	2.1
Resistance to corrosion		°C/RH	constant atmosphere: 23/83 - 40/93 - 55/20; variable atmosphere: 25/95 - 40/93				
Protection degree			IPXXB/IP2X				
Tightening torque		Nm	0.4				
Dimensions (H x D x W)		mm	85 x 69 x 17.5				
			S2C-UA 110 AC	S2C-UA 110 DC	S2C-UA 230 AC	S2C-UA 230 DC	S2C-UA 400 AC
Standards			IEC/EN 60947-1				
Rated voltage	AC	V	110		230		400
	DC	V	110		230		
Frequency		Hz	50...60				
Release trip		V	0.35 Un M V M 0.7 Un				
Terminals		mm ²	2x1.5				
Consumption		VA	3.5	2.2	3.7	2.3	2.4
Resistance to corrosion		°C/RH	constant atmosphere: 23/83 - 40/93 - 55/20; variable atmosphere: 25/95 - 40/93				
Protection degree			IPXXB/IP2X				
Tightening torque		Nm	0.4				
Dimensions (H x D x W)		mm	85 x 69 x 17.5				

Undervoltage releases

Function: protection of the load in the event of a voltage drop (between 70% and 35% of its rated value); positive safety (device's tripping when the voltage is disconnected) emergency stop by means of a button. Suitable for MCBs S 200 series, RCCBs F200 series and RCBOs DS202C, DSE201M, AFDD S-ARC1 series, DS 200 series, SD 200 switch disconnectors series. It can be used with MCBs SN201 and RCBOs DS203NC series by means of SN201-IH interface module.

Rated voltage	Bbn 8012542	Order details		Price 1 piece	Weight 1 piece	Pack unit
	EAN	Type code	Order code		kg	pc.
12VDC	839705	S2C-UA 12 DC	2CSS200911R0001		0.09	1
24VAC	839804	S2C-UA 24 AC	2CSS200911R0002		0.09	1
24VDC	896401	S2C-UA 24 DC	2CSS200911R0007		0.09	1
48VAC	839903	S2C-UA 48 AC	2CSS200911R0003		0.09	1
48VDC	896500	S2C-UA 48 DC	2CSS200911R0008		0.09	1
110VAC	840008	S2C-UA 110 AC	2CSS200911R0004		0.09	1
110VDC	896609	S2C-UA 110 DC	2CSS200911R0009		0.09	1
230VAC	840107	S2C-UA 230 AC	2CSS200911R0005		0.09	1
230VDC	896708	S2C-UA 230 DC	2CSS200911R0010		0.09	1
400VAC	840206	S2C-UA 400 AC	2CSS200911R0006		0.09	1

Auxiliary elements for MCBs, RCDs, AFDDs and Switch Disconnectors

Overvoltage release



S2C-OVP

Overvoltage release		S2C - OVP2		S2C - OVP1	
Suitable for		MCBs S200 series, S300P, SN201, RCDs F200, DS200, DS201-DS202C, DS203NC, DSE201M, AFDDs S-ARC1, DS-ARC1 and Switch disconnectors SD200			
Rated voltage	VAC	230			
Rated frequency	Hz	50			
Max non-tripping voltage AC	V	253			
Max tripping voltage AC	V	290		275	
Tripping time	@ 290V AC	s	t<1		
	@ 380V AC	s	t<0.1		
Peak current	@ 315V AC	A	1		
	@ 440V AC	A	1.8		
Max duration of impulse command	ms	7			
Operating temperature	°C	-5....+40			

Overvoltage release

Function: monitoring voltage between the neutral and phase; when an overvoltage reaches the threshold value, the OVP device causes the tripping of the associated MCB or RCCB. Suitable for MCBs of the S200 series up to 63 A, and RCCBs of the F200 series up to 100 A and RCBOs DS201, DS201 (2019), DS202C, DSE201M, AFDD S-ARC1 series, Suitable for SD 200 switch disconnectors series. It can be used with MCBs SN201 and RCBOs DS203NC series by means of SN201-IH interface module.

Description	Bbn	Order details		Price	Weight	Pack
	8012542			1 piece	1 piece	unit
	EAN	Type code	Order code		kg	pc.
Overvoltage release (max tripping voltage AC: 275V)	748137	S2C-OVP1	2CSS200910R0005		0.100	1/5
Overvoltage release (max tripping voltage AC: 290V)	952039	S2C-OVP2	2CSS200993R0005		0.100	1/5

Auxiliary elements for MCBs, RCDs, AFDDs and Switch Disconnectors

Auxiliary and signal contacts for UL applications



S 2C-S6R U



S 2C-H6R U

Auxiliary contact and signal contact		
S2C-H6R U, S2C-S6RU		
Suitable for		S 200 U/S 200 UP/S 200 UDC
Rating according UL 489 / CSA22-2 No.5		1A / 480 VAC 2A / 277 VAC 1.5 A / 125 VDC 2A / 60 VDC 4 A / 24 VDC
Conventional free air thermal current	A	10
Min. operational current/voltage*		10 mA at 12 V; 5 mA at 24 V
Rated conditional short-circuit current	V	230 V AC 1,000 A with S201 K4
Overvoltage category		III
Rated impuls withstand voltage (1.2/50µs)	kV	4
Cross section of conductors	mm ²	0.75...2.5
Tightening torque	Nm	1.2
Contact stability in vibration test according to IEC/EN60068-2-6		5g, 20 sweep cycles 5...150...5 Hz according to DIN IEC 68-2-6 at 24 V AC/DC, 5 mA automatic reclosing < 10 ms
Mechanical service life		10000 operations
Dimensions (H x D x W)	mm	100 x 69 x 8.8

* ensures safe contacting without current interruption by pollution layer.

Auxiliary contact						
Description	Bbn	Order details		Price	Weight	Pack
	4016779			1 piece	1 piece	unit
	EAN	Type code	Order code	kg	pc.	
only for range U/UP/UDC	615617	S 2C-H6R U	2CDS200914R0001		0.035	1

Signal contact						
Description	Bbn	Order details		Price	Weight	Pack
	4016779			1 piece	1 piece	unit
	EAN	Type code	Order code	kg	pc.	
only for range U/UP/UDC	615624	S 2C-S6R U	2CDS200924R0001		0.035	1

Auxiliary elements for MCBs, RCDs, AFDDs and Switch Disconnectors

Shunt trip for UL applications



S 2C-A1 U

Shunt trip								
S2C-A1 U								
Suitable for	S 200 U/S 200 UP/S 200 UDC							
Rated voltage	AC	V	12...60					
	DC	V	12...60					
Max release duration		ms	<10					
Min. release voltage	AC	V	8.4					
	DC	V	10					
Power consumption	Ub	V	12 VDC	12 VAC	24 VDC	24 VAC	60 VDC	60 VAC
	Ib _{max} /A	A	3.4	3.4	6.5	6.5	16.5	16.5
Coil resistance		Ω	3.7					
Terminals	Fale-safe bi-directional cylinder-lift-terminal							
Tightening torque		Nm	2.8					
Dimensions (H x D x W)		mm	111 x 69 x 17.5					
S2C-A2 U								
Rated voltage	AC	V	110...415					
	DC	V	110...250					
Max release duration		ms	<10					
Min. release voltage	AC	V	8.4					
	DC	V	10.0					
Power consumption	Ub	V	110 VDC	110 VAC	220 VDC	230 VAC	415 VAC	
	Ib _{max} /A	A	0.5	0.5	1.1	1.1	2.1	
Coil resistance		Ω	225					
Terminals	Fale-safe bi-directional cylinder-lift-terminal							
Tightening torque		Nm	2.8					
Dimensions (H x D x W)		mm	111 x 69 x 17.5					
Shunt trip								
Description	Bbn	Order details				Price	Weight	Pack
	4016779				1 piece	1 piece	unit	
	EAN	Type code	Order code		kg	pc.		
12 - 60 V AC/DC	64472 3	S 2C-A1 U	2CDS200908R0001		0.15	1		
110-415 V AC,110-250V DC	64473 0	S 2C-A2 U	2CDS200908R0002		0.15	1		

Auxiliary elements for MCBs, RCDs, AFDDs and Switch Disconnectors

Mechanical accessories



S 2C-TC20 U

IP20 Terminal cover						
Description	Bbn 4016779	Order details		Price 1 piece	Weight 1 piece	Pack unit
	EAN	Type code	Order code		kg	pc.
Only for range U/UP/UDC	877565	S 2C-TC20 U	2CDS200917R0001		0.0002	20

Mechanical tripping device

Function: it causes the automatic tripping of the circuit-breakers which it is associated to, when the panel or the door of the electrical switchboard are opened or removed.

Suitable for MCBs S 200 series (on both sides of the devices) and for DS 200 (only on the right side, because on the left side there's RCD-block DDA 200). Suitable for SD 200 switch disconnectors series.



S 2C-BP

Description	Bbn 8012542	Order details		Price 1 piece	Weight 1 piece	Pack unit
	EAN	Type code	Order code		kg	pc.
Mechanical tripping device	941309	S2C-BP	2CSS200998R0001		0.048	1

Plug-in base

Function: it is possible to transform a standard circuit-breaker of the S 200 and F 200 range in a plug-in device which can be pulled out of the circuit where it is installed in one operation. Suitable for MCBs S 200 series and for RCCBs F 200 series up to 63 A and RCBOs DS201, DS202C and AFDD S-ARC1 series.



S 2C-EST

Description	Bbn 8012542	Order details		Price 1 piece	Weight 1 piece	Pack unit
	EAN	Type code	Order code		kg	pc.
Plug-in base	940708	S2C-EST	2CSS200999R0001		0.115	1

Hand operated neutral left side mounted		
S2C-Nt		
Suitable for		MCBs S200 series, S300P and Switch disconnectors SD200
Rated current	A	max. 40
Terminal	mm ²	10; cage terminal
Tightening torque	Nm	1.2
Dimensions (H x D x W)	mm	85 x 69 x 8.8



S2C-Nt

Hand operated neutral

The hand operated neutral has to be mounted to the left side of the MCB or switch disconnector and be snapped on the DIN rail. It is used for measuring duties where the neutral conductor must be in the open position. Due to the special design of the handle - when switching ON the MCB - the neutral will make before the MCB is closed.

The S2C - Nt is not to switch with a tool (screw driver).

Description	Bbn 4016779	Order details		Price 1 piece	Weight 1 piece	Pack unit
	EAN	Type code	Order code		kg	pc.
Max 40A	647625	S2C-Nt	2CDS200918R0001		0.06	1

Motor operating and autoreclosing devices for MCBs, RCDs and Switch Disconnectors

Motor Operator



S2C-CM

Motor operating devices			S2C-CM1, F2C-CM	CM2/3, CM4
Supply		V	12 ... 30 V a.c. +10% - 15% (50-60Hz); 12 ... 48 V d.c. +10% - 15%	
Power consumption during the operation	12 V a.c.	VA	< 15	< 16
	24 V a.c.	VA	< 22	< 27
	30 V a.c.	VA	< 25	< 28
	12 ... 48 Vd.c.	VA	< 20	< 22
Power consumption at rest		VA	< 1.5	
Make-time at ambient temperature		sec	< 1	
Opening time at ambient temperature		sec	< 0.5	
Number of operations			< 20.000	
Operating temperature		°C	- 25 ... + 55	
Cables length of control circuit		m	< 1500	
Cables cross-section		mm ²	< 2.5	
Signal contact (terminals 3 – 4 – 5) Current carrying capacity			1NA + 1NC (change-over contact) 5 A (250 V AC) (inductive-ohmic load)	
Auxiliary contact (terminals 6 – 7 – 8) Current carrying capacity			1NA + 1NC (change-over contact) 3 A (250 V AC) (inductive-ohmic load)	
Remote control*			By means of dry contacts	
Remote control terminals			Terminal 9 = make contact; Terminal 10 = opening contact Terminal 11 = common reference for control contacts, +5V d.c. (supplied by the motor operating device)	

* Note: In case of the device opening due to a fault, please wait 8 seconds before attempting to reclose the motor operator.

Motor operating and autoreclosing devices for MCBs, RCDs and Switch Disconnectors

Motor Operator



S2C-CM

Motor operating devices		DS2C-CM	
Supply	V	12 ... 30 V a.c. +10% - 15% (50-60Hz); 12 ... 48 V d.c. +10% - 15%	
Insulation voltage	V	2500 for 1 minute	
Power consumption during the operation	12 V a.c.	VA	< 15
	24 V a.c.	VA	< 22
	30 V a.c.	VA	< 25
	12 ... 48 V d.c.	VA	< 20
Power consumption at rest	VA	< 1.5	
Remote control *		by means of dry contacts	
Make-time at ambient temperature	sec	< 1	
Opening time at ambient temperature	sec	< 0.5	
Time before attempting to reclose the motor operator	sec	8	
Number of operations		< 20.000	
Operating temperature	°C	- 25 ... + 55	
Storage temperature	°C	- 40 ... + 70	
Mounting		on DIN rail EN 60715 by means of fast clip device	
Protection degree (EN 60529)		terminals: IP2X	
		enclosure: IP4X	
Cables length of control circuit	m	< 1500	
Cables cross-section	mm ²	< 2.5	
Signal contact (terminals 3 – 4 – 5)		1NO + 1NC (change-over contact)	
Current carrying capacity		5 A (250 V AC) (resistive load)	
Auxiliary contact (terminals 6 – 7 – 8)		1NO + 1NC (change-over contact)	
Current carrying capacity		3 A (250 V AC) (resistive load)	
Remote control terminals		Terminal 9 = make contact; Terminal 10 = opening contact Terminal 11 = common reference for control contacts, +5 V d.c. (supplied by the motor operating device)	

* Note: In case of the device opening due to a fault, please wait 8 seconds before attempting to reclose the motor operator.

Motor operating devices

Function: S2C-CM, F2C-CM and DS2C-CM allow the remote control (opening or closing) of the coupled device. Suitable for S200 series MCBs, SD200 switch disconnectors, F200 RCCBs, RCBOs DS201, DS201 (2019), DS202C.

Description	Bbn	Order details		Price 1 piece	Weight 1 piece	Pack unit
	8012542	Type code	Order code			
	EAN	Type code	Order code		kg	pc.
Motor operating device for 1P S200 series MCBs and SD200 switch disconnectors	026259	S2C-CM1	2CSS201997R0013		0,166	1
Motor operating device for 2P and 3P S200 series MCBs, 2P DS201 (2019) RCBOs and SD200 switch disconnectors	026358	S2C-CM2/3	2CSS203997R0013		0,166	1
Motor operating device for 4P S200P MCBs	026457	S2C-CM4	2CSS204997R0013		0,166	1
Motor operating device for 2P and 4P F200 RCCBs	026556	F2C-CM	2CSF200997R0013		0,166	1
Motor operating device for 1P+N and 2P DS201, DS202C RCBOs	135951	DS2C-CM	2CSR201997R0013		0,166	1
Motor operating device for F200 125A RCCB	020721	F2-125A-24V-CM4	2CSF200997R1214		0,36	1
Motor operating device for F200 125A RCCB	600626	F2-125A-230V-CM4	2CSF200997R1205		0,36	1

Motor operating and autoreclosing devices for MCBs, RCDs and Switch Disconnectors

Autoreclosing unit



F2C-ARI

		Auto-reclosing unit	
		F2C-ARI	F2C-ARI30
Supply	V	12 ... 30 V a.c. +10% - 15% (50-60Hz); 12 ... 48 V d.c. +10% - 15%	
Number of automatic reset attempts		3	
Time of reset of the auto-reset meter	sec	12	45
Power consumption during the operation	12 V a.c.	VA	< 15
	24 V a.c.	VA	< 22
	30 V a.c.	VA	< 25
	12...48 V d.c.	VA	< 20
Power consumption at rest	VA	< 1.5	
Waiting time between auto-reset attempts	sec	3	30
Closing time at ambient temperature	sec	< 1	
Opening time at ambient temperature	sec	< 0.5	
Number of operations		< 20.000	
Operating temperature	°C	- 25 ... + 55	
Cables length of control circuit	m	< 1500	
Cables cross-section	mm ²	< 2.5	
Signaling contact to signal a locked state following three auto-reset attempts (terminals 3-4-5)		1NA + 1NC (change-over contact)	
Current carrying capacity		5 A (250 V AC) (ohmic load)	
Auxiliary contact (terminals 6-7-8)		1NA + 1NC (change-over contact)	
Current carrying capacity		3 A (250 V AC) (ohmic load)	
Remote control		By means of dry contacts	
Remote control terminals		Terminal 9 = closing and remote reset contact for locked state; Terminal 10 = opening contact Terminal 11 = common reference for control contacts, +5V d.c. (supplied by the motor operating device)	

Auto-reclosing units

Function: F2C-ARI and F2C-ARI30 allow the auto-reclosing of the coupled device in case of unwanted tripping. Suitable for F 200 RCCBs up to 100 A.

Description	Bbn	Order details		Price	Weight	Pack
	8012542			1 piece	1 piece	unit
	EAN	Type code	Order code		kg	pc.
Auto-reclosing unit for 2P and 4P F200 RCCBs	026655	F2C-ARI	2CSF200996R0013		0.166	1
Auto-reclosing unit for 2P and 4P F200 RCCBs (30")	064350	F2C-ARI30	2CSF200995R0013		0.166	1

Motor operating and autoreclosing devices for MCBs, RCDs and Switch Disconnectors

Autoreclosing unit



F2C-ARH



F2C-ARH-T

Home automatic resetting unit		
F2C-ARH /F2C-ARH-T		
Power supply	VAC	230
Number of automatic reclosing attempts		1
Reset time for counter of automatic reclosing attempts	sec	12
Power absorbed during the operation	VA	(t<0.5s) 20 max
Power consumption in stand-by	W	0.4 max
Number of operations		≤ 10.000
Operating temperature	°C	-25 ... + 55
Signal contact cable section	mm ²	≤ 2.5
Signal contact for the locked state (terminals 1-2)		1NA (change-over contact)
Signal contact rated current	A	3 (250V AC)

Home automatic resetting unit (for domestic and similar applications)

Function: it recloses the associated residual current device, only after having checked that there are no effective faults in the system protected by the RCCB.

Suitable for 2-pole RCCB series with 30 mA or 100 mA sensitivities, max 63 A

Description	Bbn	Order details		Price 1 piece	Weight 1 piece	Pack unit
	8012542	EAN	Type code			
Home automatic resetting unit (30 mA)	732433	F2C-ARH	2CSF200992R0005		0.200	1
Home automatic resetting unit (100 mA)	658535	F2C-ARH100	2CSF200990R0005		0.200	1

Home automatic resetting unit with autotest (for domestic and similar applications)

Function: it recloses the associated residual current device, only after having checked that there are no effective faults in the system protected by RCCB.

Suitable for 2-pole RCCB series with 30 mA or 100 mA sensitivities, max 63 A.

F2C-ARH-T allows the RCCB automatic test every six months.

Description	Bbn	Order details		Price 1 piece	Weight 1 piece	Pack unit
	8012542	EAN	Type code			
Home automatic resetting unit (30 mA) with RCCB autotest	733232	F2C-ARH-T	2CSF200991R0005		0.200	1
Home automatic resetting unit (100 mA) with RCCB autotest	593836	F2C-ARH-T100	2CSF200989R0005		0.200	1

Busbars and busbars' accessories for MCBs, RCDs and AFDDs

Technical features

		Busbars PS	Busbars BR	Busbars BS9 and F2-S9	Busbars BB			
Suitable for		MCB: S200, S200M, S200P, S300 RCD: F200, DDA-blocks	RCBO: DS202CR	MCB: SN201 RCBO: DS301C	MCB: S200C			
Electrical Data	Standards	IEC/EN 60947-1		IEC/EN 60947-1: 2007 IEC/EN 61439-1:2011				
	Approvals	—						
	Rated voltage Ue	V	1P, 2P, 3P, 4P: 690 V AC/DC	400 V AC	1P: 100 V AC/DC 2P, 3P, 4P: 480 V AC/DC	400 V AC		
	Rated frequency	Hz	50 / 60 Hz, DC		50 Hz			
	Current carrying capacity / Phase (35°C ambient temperature)	A	10 mm ²	16 mm ²	30 mm ²	10 mm ²	16 mm ²	
			End feeding ①	63 A	80 A	120 A	63 A	80 A
	Non-end feeding ①	100 A	130 A	160 A	100 A	130 A	100 A	1P: 80 A 2P, 3P, 4P: 100 A
Short-circuit withstand capacity	kA	25 kA in series with fuse NH3 355 A gG 500 V		25 kA in series with 100 A fuse	1P: 15 kA in series with fuse NH3 250 A gL 500 V 2P, 3P, 4P: 50 kA in series with fuse NH3 250 A gL 500 V	25 kA in series with 100 A gL fuse		
Mechanical Data	Housing	light grey, RAL 7035		light grey, RAL 7035	light grey, RAL 7035	light grey, RAL 7035		
	Environmental conditions acc. to	DIN EN 60068		DIN EN 60068	DIN EN 60068	DIN EN 60068		
	Overvoltage category	III		III	III	III		
	Pollution degree	2		2	2	2		
Installation	Cross-Section Busbar	10 mm ² , 16 mm ² , 30 mm ²		10 mm ² , 16 mm ²	10 mm ²	10 mm ²		
	Mounting position	optional		optional (BS9), dedicated up/down versions (F2-S9)	optional (BS9), dedicated up/down versions (F2-S9)	optional (BS9), dedicated up/down versions (F2-S9)		
	Supply	Feed on terminal of the device (supply side optional) or use of feeder terminal range AST; SZ-ESK		Feed on terminal of the device or use of feeder terminal range BR-FS	Feed on terminal of the device or use of feeder terminal range	Feed on terminal of the device or use of feeder terminal range BB-FS		

① In case of feed in from the middle of the busbar it needs to be ensured, that the sum of junction currents per side must not exceed the max busbar current I_s/phase. Irrespective of the current carrying capacity (I_s) of the busbar, the max. rated current of the devices terminal may not be exceeded.

Busbars and busbars' accessories for MCBs, RCDs and AFDDs

Technical features

Busbars PSc	Busbars PS...CB	Busbars PS...BP	Busbars PS...BP-C	Busbars PS...BP-CR	Busbars PS..DC
MCB: SN201 RCBO: DS301C	MCB: S200, S200M, S200P, S200MUC, S300 S200MTUC	MCB: SU200M, S200UDC, S200U, S200UP	MCB: SU200M, S200UDC, S200U, S200UP	MCB: S200 MR, SU200 MR and ST200 MTR	MCBs, Fuseholders E90
IEC/EN 60947-1: 2007 + A1: 2011	IEC/EN 60947-1 UL1077	IEC/EN 60947-1 UL489	IEC/EN 60947-1 UL508	EN 60947-1 / IEC 60947-1:2004 UL508	IEC/EN 60947-1
	UL508	UL489	UL 489		-
400 V AC/DC	1P: 1000 V AC/DC 2P, 3P: 600 V AC/DC	1P, 2P, 3P: 480 V AC	600 V AC/DC	600 V AC	690 V AC / 1000 V DC
50/60 Hz	50 / 60 Hz	50 / 60 Hz	50 Hz (IEC) / 60 Hz (UL)	50 Hz (IEC) / 60 Hz (UL)	50 / 60 Hz, DC
	18 mm ² 25 mm ²				
63 A (connection cross section 10mm ²)	End feeding ①	80 A 100 A	80 A (115A for cubicle size ≥ 30"x30"x10")	End 100 A feeding ①	100 A
100 A (connection cross section 25mm ²)	Non- end feeding ①	160 A 200 A		Non-end 200 A feeding ①	200A
	10 kA 3 cycles @ 480 V / 100 kA Fuse Class J 175 A / 18 mm ² – 200 A / 25 mm ²	10 kA in series with fuse NH3 355 A gG 500 V	10 kA 3 cycles @ 600 V / 140 kA Fuse Class J 200 A	140 kA Fuse Class J 200 A	25 kA/0,1 s, 100 kA in series with fuse NH3 355 A gG
light grey, RAL 7035	light grey, RAL 7035	light grey, RAL 7035	light grey, RAL 7035	grey, RAL 7035	light grey, RAL 7035
	DIN EN 60068	DIN EN 60068	DIN EN 60068	acc. to DIN EN 60068	DIN EN 60068
III	III	III	III	III	III
2	2	2	2	2	2
10 mm ²	18 mm ² , 25 mm ²	16 mm ²	25 mm ²	25 mm ²	30 mm ²
Bottom	optional	optional	optional	optional	optional
Through RCBO terminal: Maximum wire cross section 10 mm ² (rigid, ferrule, stranded)	Feed on terminal of the device (supply side optional) or use of feeder terminals AST 35/... CB; SZ-ESK SP	Feed on terminal of the device (supply side optional) or use of feeder terminals AST 35/15 BP; SZ-ESK BP	Feed on terminal of the device (supply side optional) or use of feeder terminal AST 35/58 BP-C	Feedin via cable with ring tongue	Feed on terminal of the device (supply side optional) or use of feeder terminal AST 35/18 DC or AST 35/45 DC
Through feed-in terminal: Maximum wire cross section 25 mm					

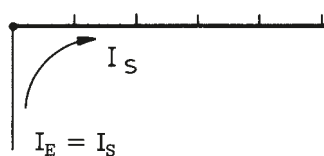

Feed in from the end of the busbar

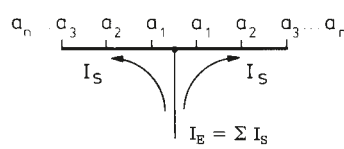

Feed in from the middle of the busbar

Busbars and busbars' accessories for MCBs, RCDs and AFDDs

Technical features

		Busbars PS	Busbars BR	Busbars BS9 and F2-S9	Busbars BB
Accessories	Shock-protection caps	BSK, SZ-BSK	BR-BS		
	Feeder terminals	range AST, SZ-ESK	BR-FS	FEED-IN	BB-FS
	End caps	range END, PS-END, PSB-END	BB-END	BS9-END	BB-END

		Feeder Terminals AST , SZ-ESK	Feeder terminal BR-FS	Feeder terminal FEED-IN	Feeder terminal BB-FS		
Electrical Data	Max. operating voltage	V	690 V AC, 690 V DC	Limited by the busbar system used	690 V AC/ 1500 V DC	Limited by the busbar system used	
	Current carrying capacity / phase	A	see below ①	Limited by the busbar system used	80 A	Limited by the busbar system used	
	Cross-Section	mm ²	SZ-ESK	6 - 35 mm ² 100 A	solid/stranded: 6 - 25 mm ² with ferrule: 6 - 16 mm ²	solid/stranded: 6 - 25 mm ² with ferrule: 4 - 16 mm ²	solid/stranded: 6 - 25 mm ² with ferrule: 6 - 16 mm ²
				6 - 50 mm ² 125 A			
	mm ²	AST	6 - 25 mm ² 80 A				
			6 - 50 mm ² 125 A				

		Busbars PS	Busbars BR	Busbars BS9 and F2-S9	Busbars BB
Instruction of installation		When cutting the busbar, ensure that the insulation profile exceeds the copper bar by approx. 10 mm on each side. Shock protection only with mounted end caps ensured. For DC applications the required increased clearance and creepage distances needs to be ensured.			

① In case of feed in from the middle of the busbar it needs to be ensured, that the sum of junction currents per side must not exceed the max busbar current I_s /phase. Irrespective of the current carrying capacity (I_s) of the busbar, the max. rated current of the devices terminal may not be exceeded.

Busbars and busbars' accessories for MCBs, RCDs and AFDDs

Technical features

Busbars PSc	Busbars PS...CB	Busbars PS...BP	Busbars PS...BP-C	Busbars PS...BP-CR	Busbars PS..DC
BSKc	BSK CB	BSK BP	BSK BP-C	BSK BP-CR	BSK BP-C
AST 25/27 QS	AST 35/15.. CB; AST 35/38.. CB SZ-ESK SP	AST 35/15 BP SZ-ESK BP	AST 35/58 BP-C		AST 35/18 DC (for use with 1-phase busbar) AST 35/45 DC (for use with 2-phase busbar)
PSc-END	PS-END SP; PS-END1 SP	-	PS-END 3 BP-C	PS-END 3 BP-C	PS-END0, PS-END3

AST 25/27 QS	Feeder Terminals AST... CB and SZ-ESK SP	Feeder Terminals AST 35/15 BP and SZ-ESK BP	Feeder Terminals AST 35/58 BP-C	-	Feeder Terminals AST 35/58 BP-C
	AST.. CB 1000 V AC/DC; SZ-ESK SP 690 V AC/DC	480 V AC	1000 V AC/DC		
	115 A ①	115 A ①	115 A use 75° wire 95 A use 60° wire		
	SZ-ESK SP 35 mm ² / 2AWG flexible with ferrules 50 mm ² / 1AWG solid / stranded	SZ-ESK BP 35 mm ² / 2AWG flexible with ferrules 50 mm ² / 1AWG solid / stranded	AST 35/58 BP-C 28mm ² / 2AWG		
	AST.. CB 35 mm ² / 2AWG flexible with ferrules 50 mm ² / 1AWG solid / stranded	AST 35/15 BP 25 mm ² / 3AWG flexible with ferrules 35 mm ² / 2AWG solid / stranded			

Busbars PSc	Busbars PS...CB	Busbars PS...BP	Busbars PS...BP-C	Busbars PS...BP-CR	Busbars PS..DC
	When cutting the busbar, ensure that the installation profile exceeds the copper bar by approx. 10mm on each side. Shock protection only with mounted end caps ensured.	Cutting of busbar is not permitted.	Shock protection only with mounted end caps ensured. For DC applications the required increased clearance and creepage distances needs to be ensured.		The copper bus has to be cut to a length that is app. 10 mm less than the corresponding length of the plastic busbar housing. Toch-safe only when used with the required end caps. Independant from the rated voltage of the devices like busbars or feeder terminals the creepage distances and distances over the air needs to be considered. This is depending on the particular application as well as on the complete assembling.

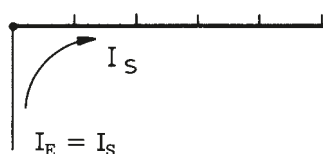

Feed in from the end of the busbar

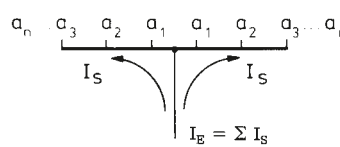

Feed in from the middle of the busbar

Busbars and busbars' accessories for MCBs, RCDs and AFDDs

Selection guide

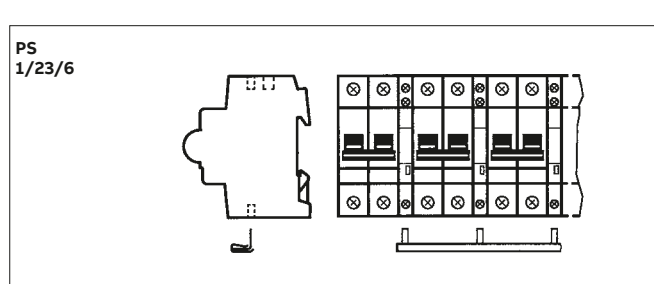
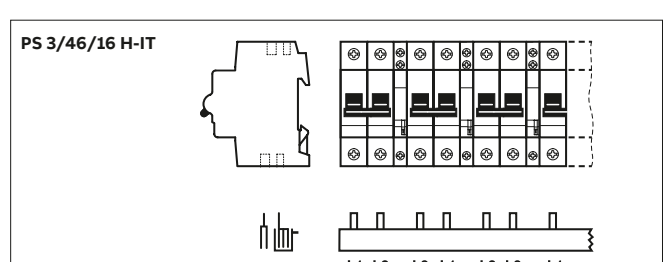
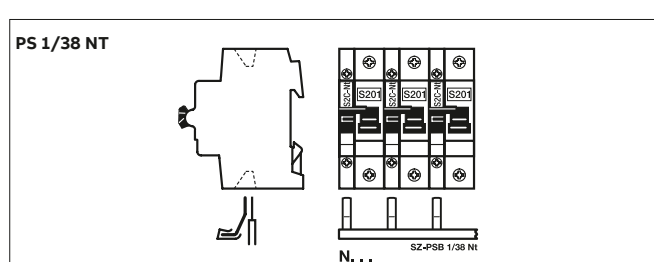
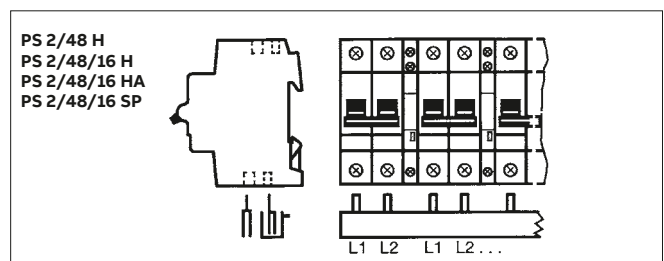
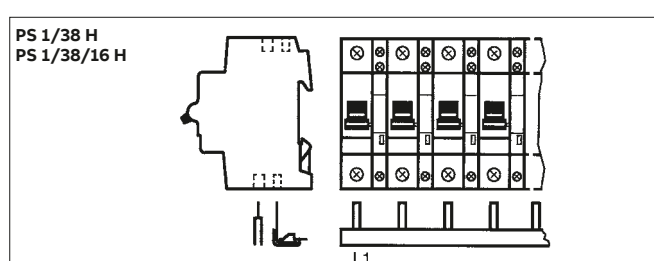
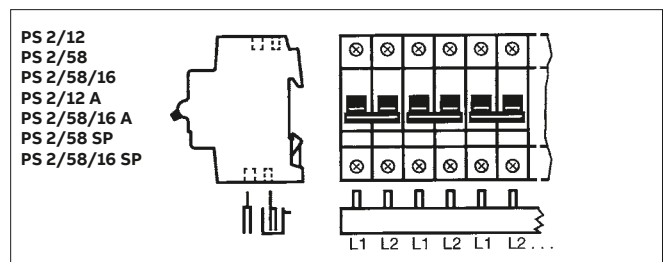
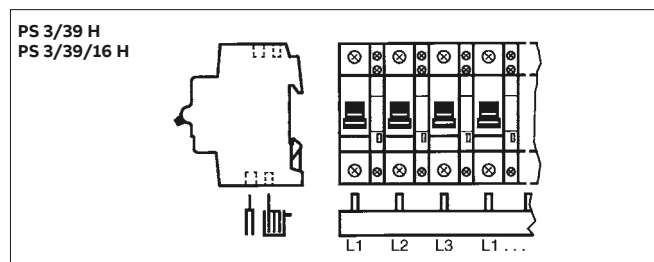
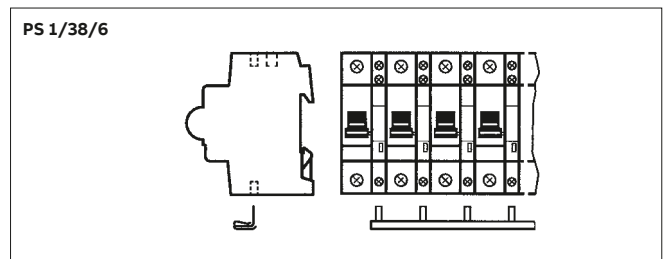
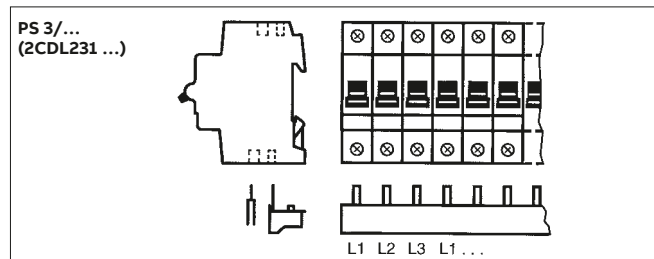
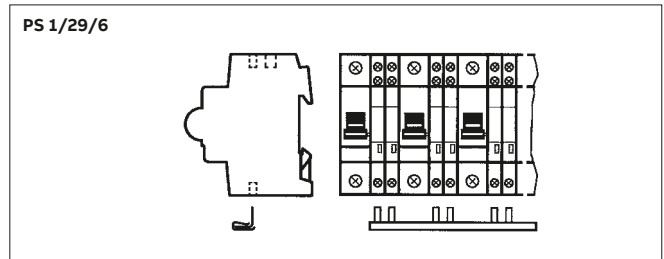
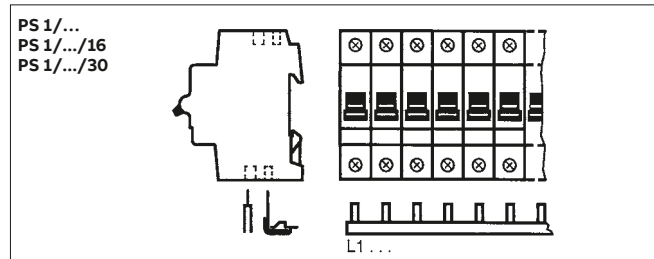

Busbars and busbars' accessories for MCBs, RCDs and AFDDs

Selection guide

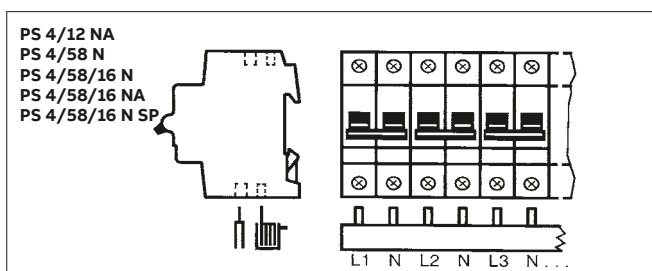
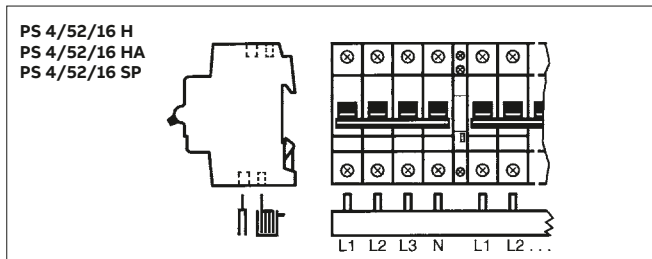
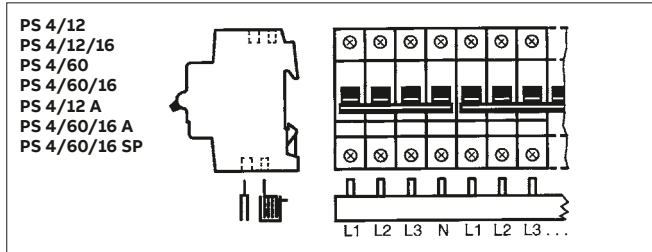
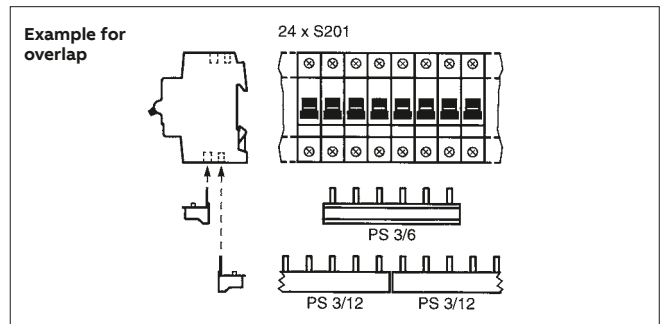
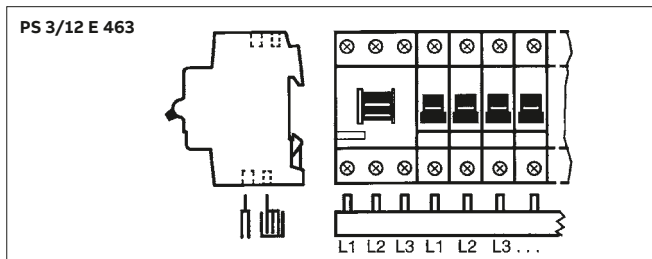
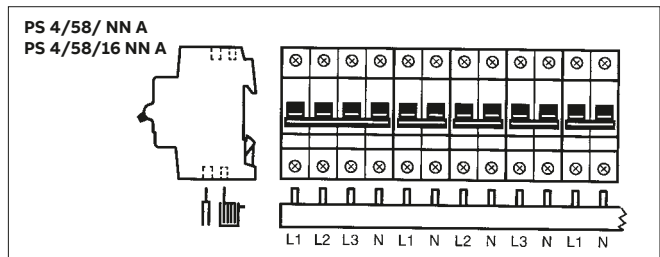
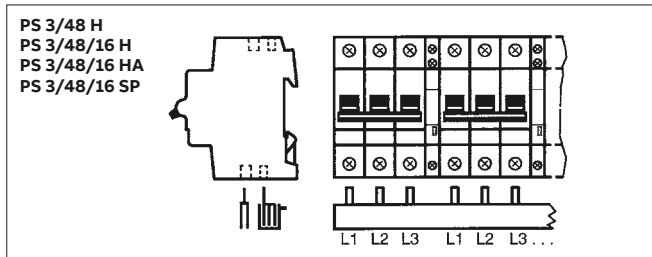
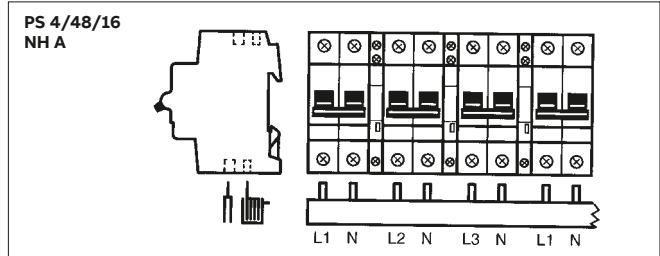
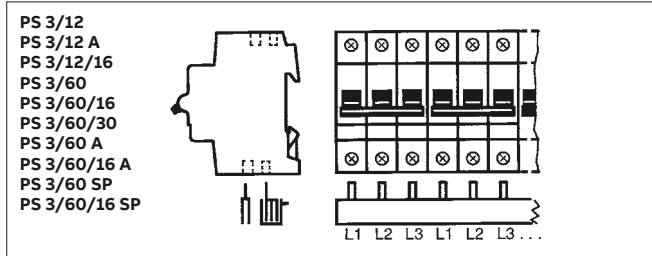

Busbars and busbars' accessories for MCBs, RCDs and AFDDs

Selection guide

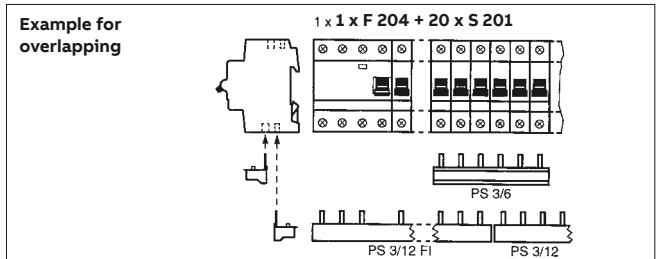
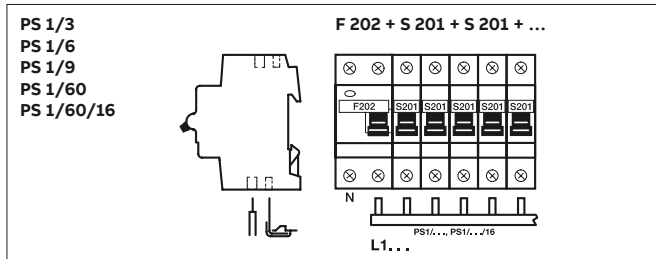
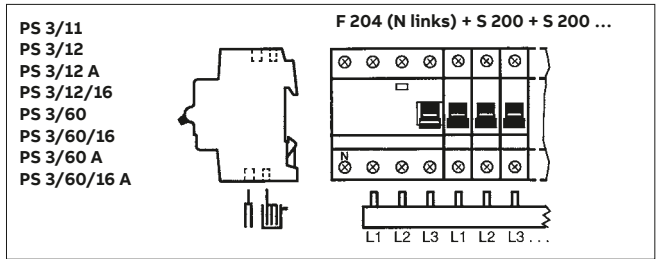
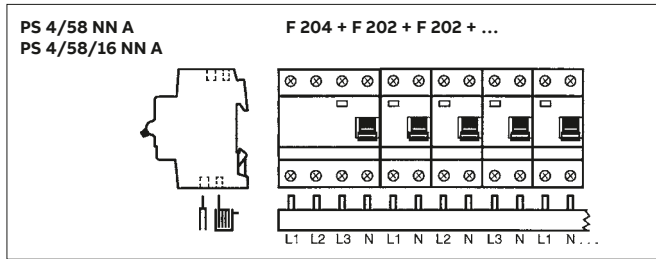
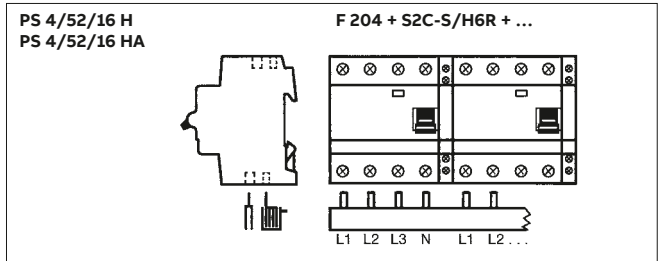
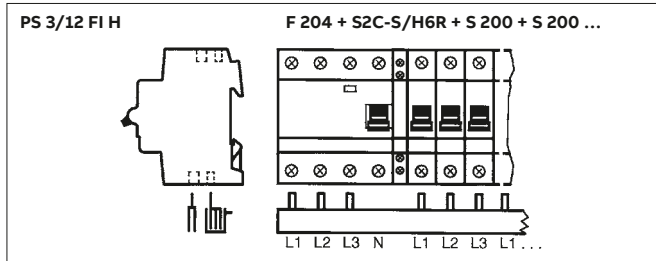
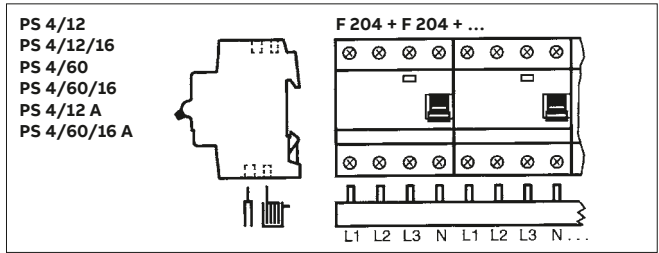
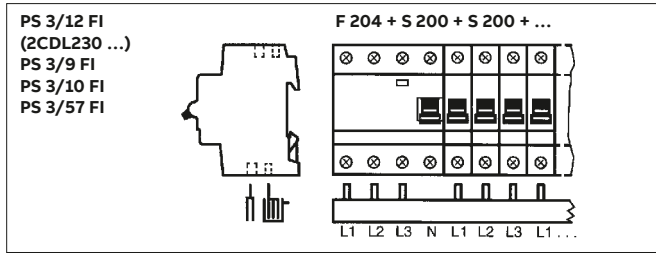
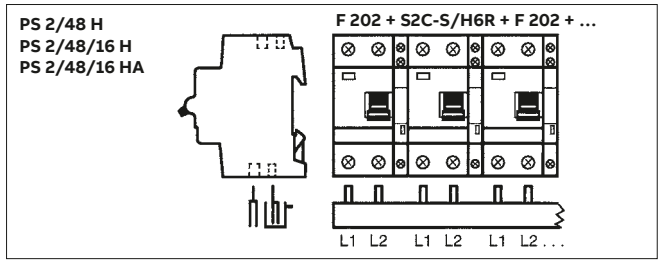
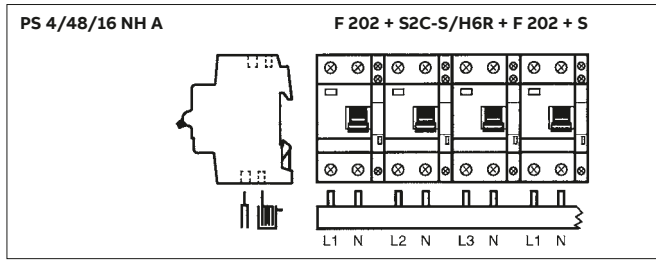
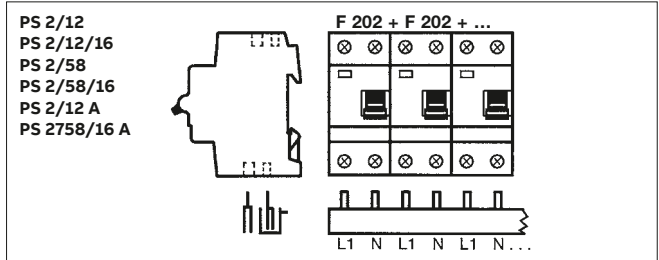
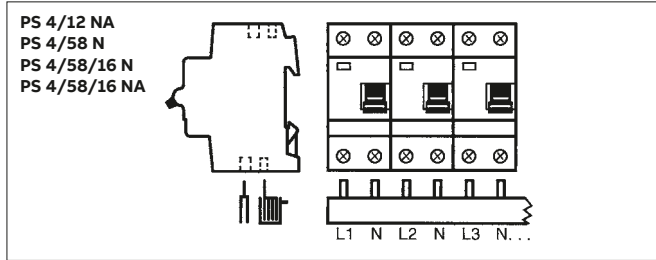

Busbars and busbars' accessories for MCBs, RCDs and AFDDs

Selection guide

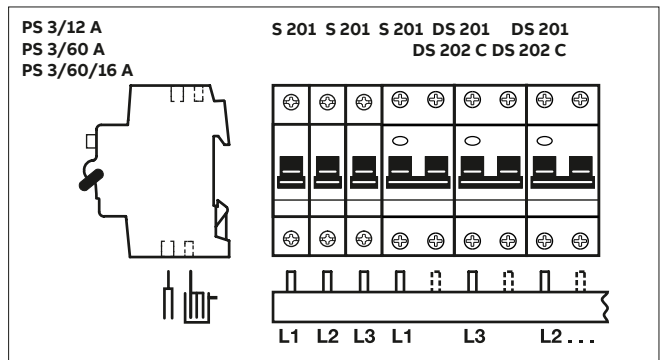
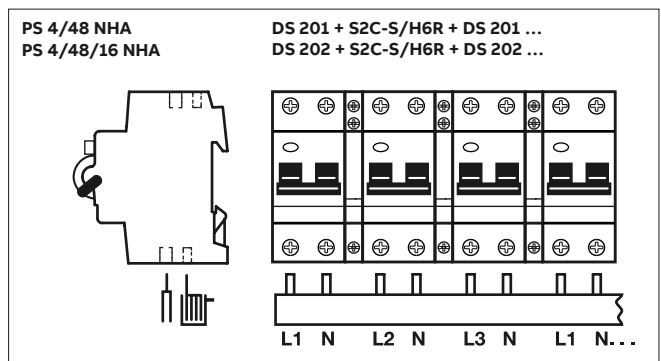
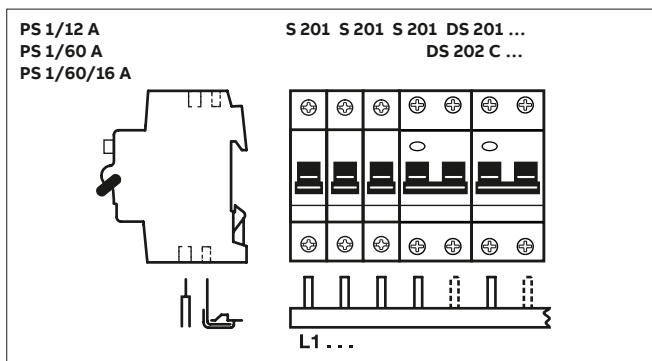
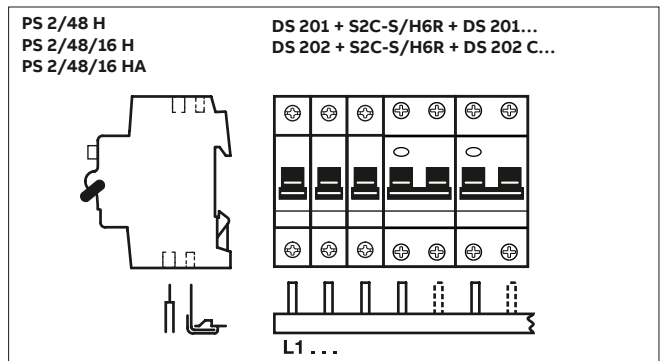
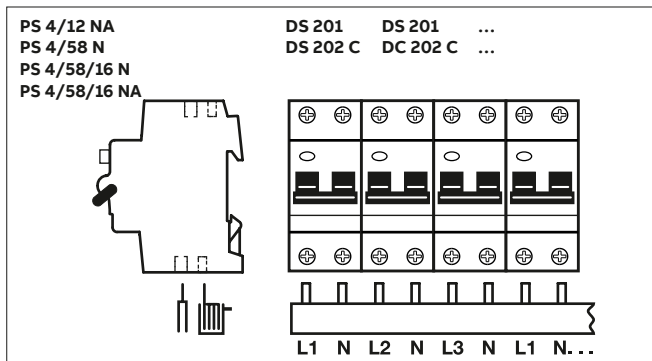
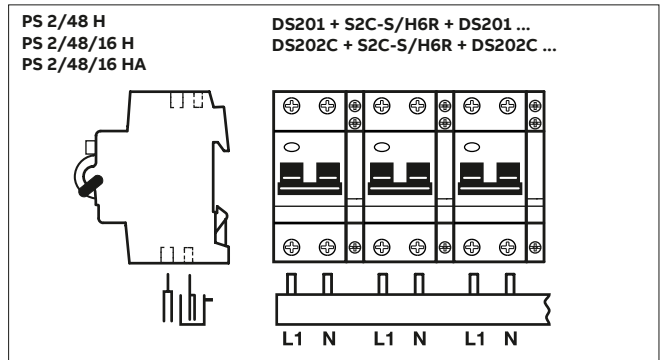
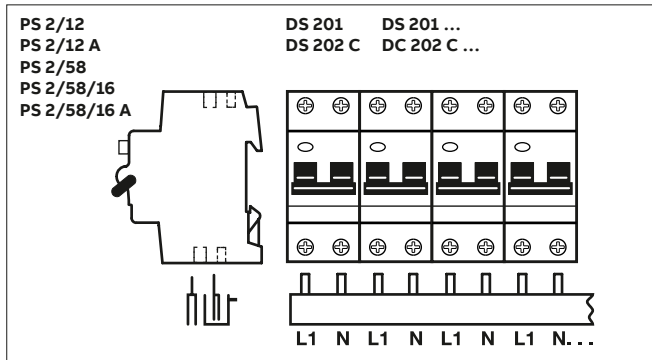

Busbars and busbars' accessories for MCBs, RCDs and AFDDs

Selection guide

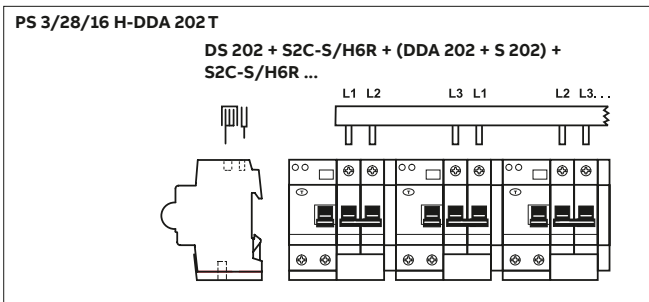
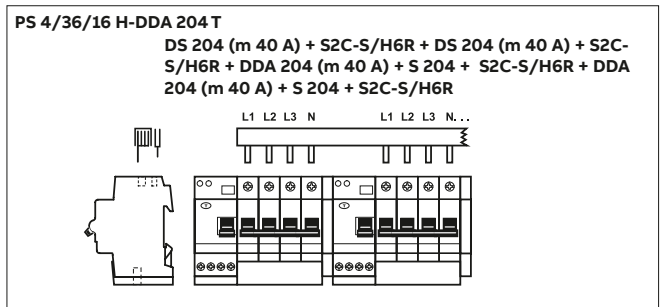
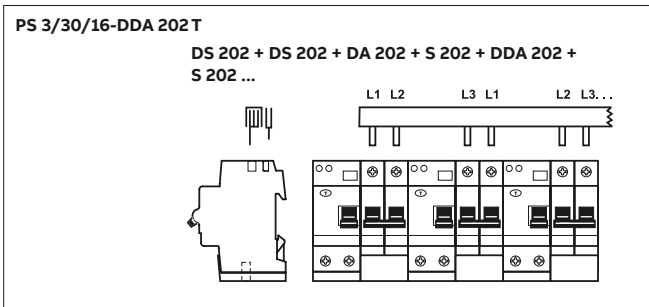
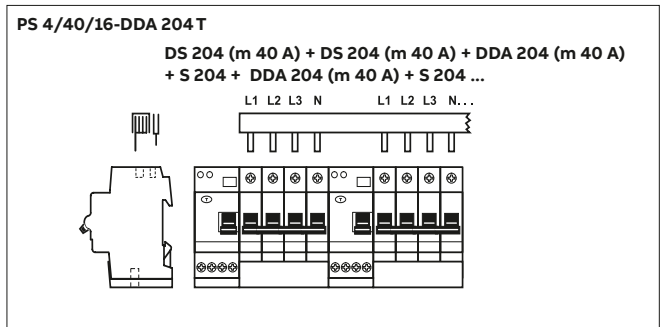
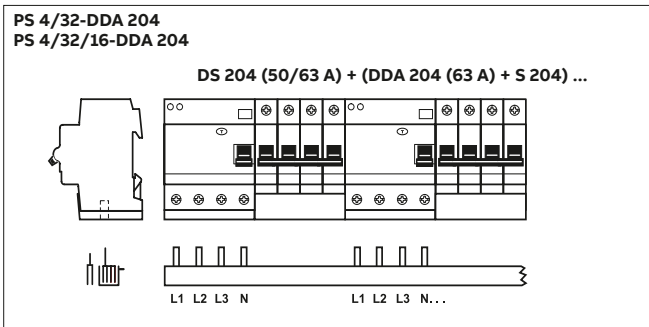
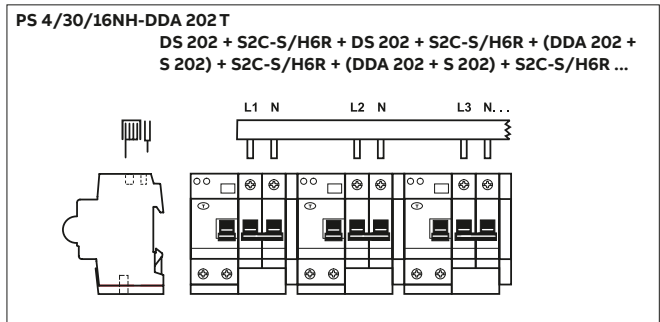
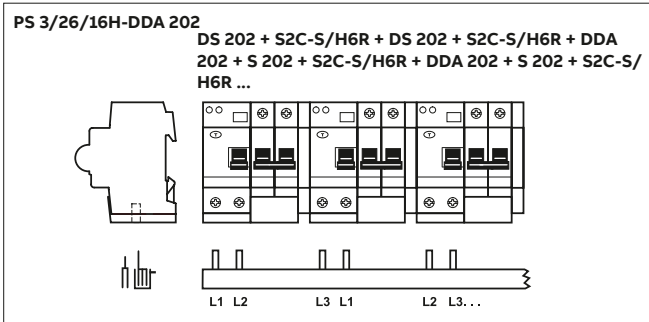
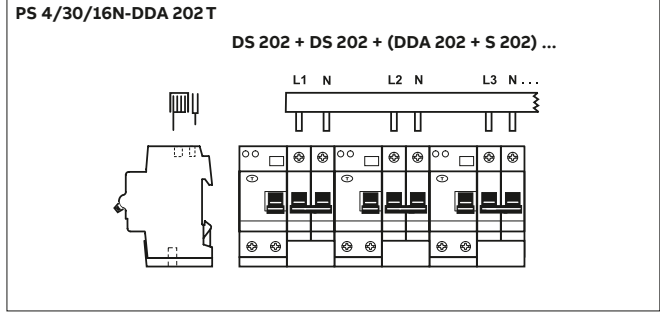
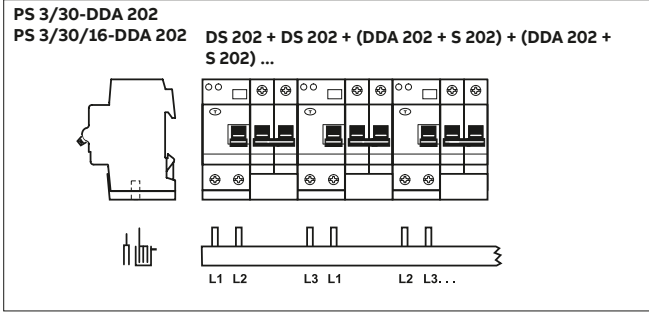

Busbars and busbars' accessories for MCBs, RCDs and AFDDs

Selection guide

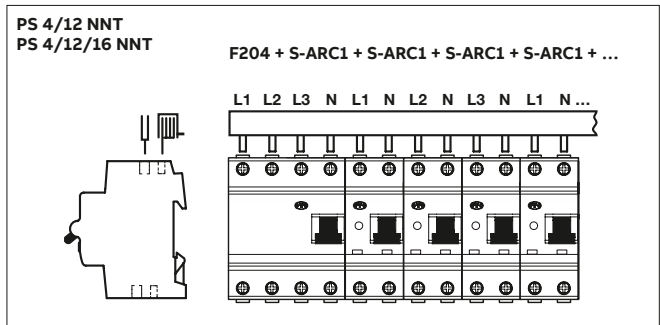
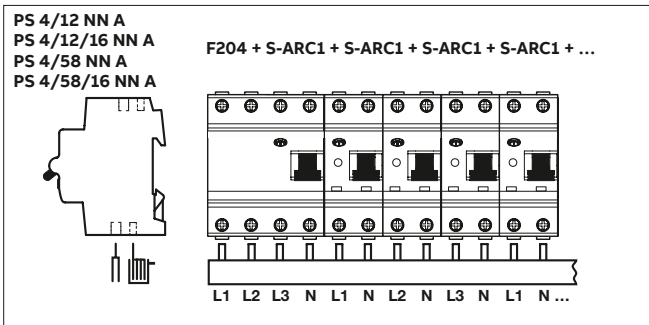
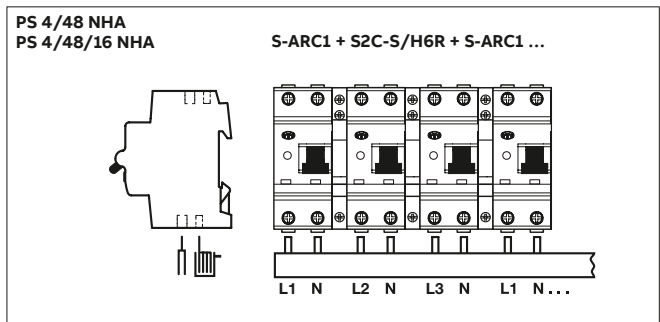
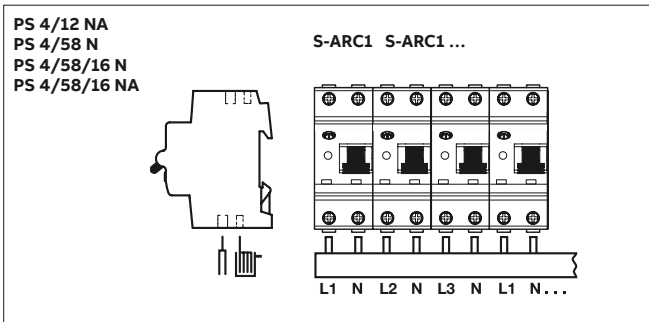
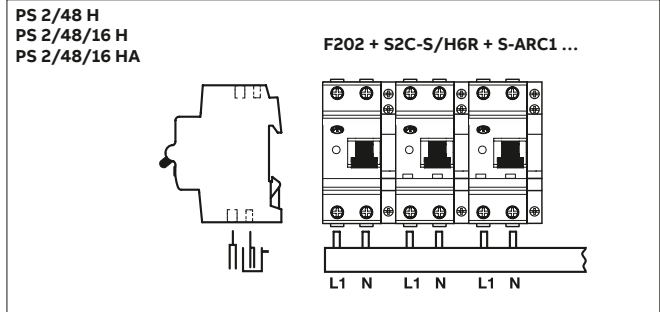
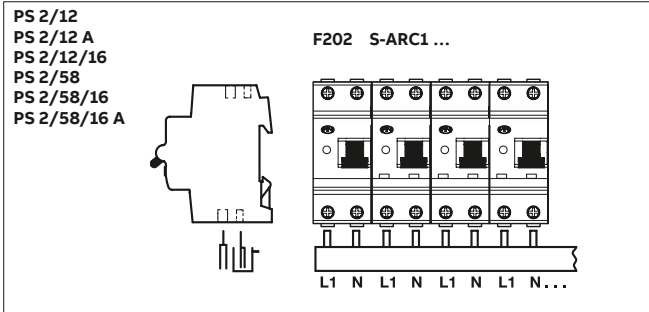

Busbars and busbars' accessories for MCBs, RCDs and AFDDs

Selection guide

Short description

ABB busbar systems enable the safe and fast cross connection of MCBs, RCCBs, RCBOs and AFDDs.

Selection criteria:

- Type of devices (MCB, RCCB, RCBO or AFDD)
- Number of devices
- Number of phases (1, 1P+N, 2, 3, 3P+N, 4)
- Phases sequence
- Busbar cross section (for current carrying capacity)
- Use of side mounted half module accessories

	1	2	3	4	5	6	7	8	9
Product range	PS; PSc; BS9; BF2-S9; BB; BR								
Phases									
1 phase	1								
2 phase	2								
3 phase	3								
4 phase	4								
Number of pins									
Busbar cross-section									
10 mm ²					-	**			
6 mm ²					6	-			
16 mm ²					1	6			
30 mm ²					3	0			
Application									
Cross connection of RCCB and MCB (4th pin removed for RCCB 3+N)							F	I	
Use of neutral conductor (phase sequence e.g. L1-N-L2-N-L3-N-L1...)					N				
Space for 1 side mounted auxiliary contact					H				
Pins for breaking off									A
Cross connection of devices 3P+N + 1P+N (phase sequence L1-L2-L3-N-L1-N-L2-N-L1-N-...)							N	N	
Busbars for IT networks							I	T	
Busbars acc. to UL 489 (Branch Protection)							B	P	
Busbars acc. to UL 1077 (Supplementary Protection)							C	B	
Busbars for direct current applications							D	C	
Note: Combinations of above applications are possible									

* only right side mounted auxiliary elements and bottom fixed auxiliary contacts can be considered for busbar connection

** 10 for Sn201, S200C, DS301C busbars

Busbars and busbars' accessories for MCBs, RCDs and AFDDs

Busbars PS

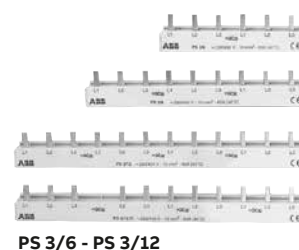
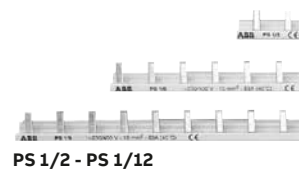

Pre-assembled busbars (not to be cut)

1-phase busbars, pin distance 17.6 mm, end caps PS-END 0									
No. of pins	Phases	mm ²	Cu-No.	Bbn	Order details		Price 1 piece	Weight 1 piece	Pack unit
			kg	4016779	Type code	Order code			
2	1	10	0.01	463003	PS1/2	2CDL210001R1002		0.01	180
3	1	10	0.03	514651	PS1/3	2CDL210001R1003		0.03	120
4	1	10	0.03	648233	PS1/4	2CDL210001R1004		0.03	100
6	1	10	0.03	463102	PS1/6	2CDL210001R1006		0.03	60
9	1	10	0.04	463201	PS1/9	2CDL210001R1009		0.04	30
12	1	10	0.05	463300	PS1/12	2CDL210001R1012		0.05	30
12	1	10	0.05	682985	PS1/12A ②	2CDL210010R1012		0.05	30

3-phase busbars, pin distance 17.6 mm									
No. of pins	Phases	mm ²	Cu-No.	Bbn	Order details		Price 1 piece	Weight 1 piece	Pack unit
			kg	4016779	Type code	Order code			
6	3	10	0.04	463409	PS3/6	2CDL231001R1006		0.04	60
9	3	10	0.07	463508	PS3/9	2CDL231001R1009		0.07	30
12	3	10	0.10	463607	PS3/12	2CDL231001R1012		0.10	30
12	3	10	0.10	463706	PS3/12FI *	2CDL231002R1012		0.09	50

* phase sequence: L1, L2, L3, free, L2, L3, L1, ...

Busbars suitable for cutting

1-phase busbars, pin distance 17.6 mm, end caps PS-END 0									
No. of pins	Phases	mm ²	Cu-No.	Bbn	Order details		Price 1 piece	Weight 1 piece	Pack unit
			kg	4016779	Type code	Order code			
60	1	10	0.26	514668	PS1/60	2CDL210001R1060		0.26	20
60	1	10	0.26	682992	PS1/60A ②	2CDL210010R1060		0.28	50
60	1	16	0.41	516655	PS1/60/16	2CDL210001R1660		0.41	20
60	1	16	0.41	683005	PS1/60/16A ②	2CDL210010R1660		0.39	50
5	1	30	0.04	653244	PS1/5/30 ①	2CDL210001R3005		0.04	100
10	1	30	0.09	653268	PS1/10/30 ①	2CDL210001R3010		0.09	100
11	1	30	0.09	653275	PS1/11/30 ①	2CDL210001R3011		0.10	100
14	1	30	0.120	653282	PS1/14/30 ①	2CDL210001R3014		0.120	50
15	1	30	0.130	653299	PS1/15/30 ①	2CDL210001R3015		0.130	50
18	1	30	0.150	653305	PS1/18/30 ①	2CDL210001R3018		0.150	50
19	1	30	0.160	653312	PS1/19/30 ①	2CDL210001R3019		0.160	50
60	1	30	0.520	653596	PS1/60/30	2CDL210001R3060		0.520	20

1-phase busbars, connection of 1-pole devices with auxiliary, end caps PS-END 0									
No. of pins	Phases	mm ²	Cu-No.	Bbn	Order details		Price 1 piece	Weight 1 piece	Pack unit
			kg	4016779	Type code	Order code			
38	1	10	0.27	586139	PS1/38H	2CDL210001R1038		0.27	30
38	1	16	0.45	586146	PS1/38/16H	2CDL210001R1638		0.45	30

① inclusive of end caps

② pre-cutted pins

Busbars and busbars' accessories for MCBs, RCDs and AFDDs

Busbars PS



PS 1/2 - PS 1/...

1-phase busbars, connection of neutral (blue insulation), end caps END 1.1									
No. of pins	Phases	mm ²	Cu-No.	Bbn 4016779	Order details		Price 1	Weight 1 piece	Pack unit
					Type code	Order code			
			kg	EAN			piece	kg	pc.
28	1	10	0.24	629546	PS1/28N	2CDL210001R1028		0.14	50
28	1	16	0.32	629560	PS1/28/16N	2CDL210001R1628		0.20	50
57	1	10	0.24	579728	PS1/57NA ②	2CDL210011R1057		0.14	50
57	1	10	0.24	629539	PS1/57N	2CDL210001R1057		0.14	50
57	1	16	0.32	579735	PS1/57/16NA ②	2CDL210011R1657		0.20	50
57	1	16	0.32	629553	PS1/57/16N	2CDL210001R1657		0.20	50

1-phase busbars, connection of auxiliaries, end caps END 1.1 except PS 1/57/6									
No. of pins	Phases	mm ²	Cu-No.	Bbn 4016779	Order details		Price 1	Weight 1 piece	Pack unit
					Type code	Order code			
			kg	EAN			piece	kg	pc.
23	1	6	0.16	584739	PS1/23/6	2CDL210005R0623		0.09	50
29	1	6	0.14	580823	PS1/29/6	2CDL210005R0629		0.10	50
38	1	6	0.14	580816	PS1/38/6	2CDL210005R0638		0.09	50
57	1	6	0.11	585309	PS1/57/6	2CDL210005R0657		0.08	50

1-phase busbars, connection of hand operated neutral S2C-Nt (blue insulation), end caps END 1.1									
No. of pins	Phases	mm ²	Cu-No.	Bbn 4016779	Order details		Price 1	Weight 1 piece	Pack unit
					Type code	Order code			
			kg	EAN			piece	kg	pc.
38	1	10	0.410	655361	PS1/38 NT	2CDL210002R1038			10



PS 2/12 - PS 2/...

2-phase busbars, pin distance 17.6 mm, end caps PS-END									
No. of pins	Phases	mm ²	Cu-No.	Bbn 4016779	Order details		Price 1	Weight 1 piece	Pack unit
					Type code	Order code			
			kg	EAN			piece	kg	pc.
12	2	10	0.07	556521	PS2/12 ①	2CDL220001R1012		0.08	50
12	2	10	0.07	584616	PS2/12A ①②	2CDL220010R1012		0.08	50
12	2	16	0.11	646918	PS2/12/16	2CDL220001R1612		0.09	50
58	2	10	0.32	556552	PS2/58	2CDL220001R1058		0.36	10
58	2	16	0.55	556569	PS2/58/16	2CDL220001R1658		0.49	10
58	2	16	0.55	584746	PS2/58/16A ②	2CDL220010R1658		0.49	10
58	2	30	1.81	654272	PS2/58/30 ③④	2CDL220001R3058		1.81	10

Note: PS...A is a busbar with removable pin

2-phase busbars, connection of 2-pole devices with auxiliary, end caps PS-END									
No. of pins	Phases	mm ²	Cu-No.	Bbn 4016779	Order details		Price 1	Weight 1 piece	Pack unit
					Type code	Order code			
			kg	EAN			piece	kg	pc.
48	2	10	0.47	556538	PS2/48H	2CDL220001R1048		0.35	10
48	2	16	0.68	556545	PS2/48/16H	2CDL220001R1648		0.48	10
48	2	16	0.68	584630	PS2/48/16HA ②	2CDL220012R1648		0.48	10

① inclusive of end caps

② pre-cutted pins

③ use end cap PS-END 3

④ removal of installed MCB not possible

Busbars and busbars' accessories for MCBs, RCDs and AFDDs

Busbars PS



PS 3/11 - PS 3/...

3-phase busbars, pin distance 17.6mm, end caps PS-END									
No. of pins	Phases	mm ²	Cu-No.	Bbn 4016779	Order details		Price 1	Weight 1 piece	Pack unit
					Type code	Order code			
			kg	EAN			piece	kg	pc.
11	3	10	0.10	649926	PS3/11 ①	2CDL230001R1011		0.08	50
12	3	10	0.09	576116	PS3/12 ①	2CDL230001R1012		0.09	50
12	3	10	0.09	584647	PS3/12A ①②	2CDL230010R1012		0.09	50
12	3	16	0.16	562805	PS3/12/16 ①	2CDL230001R1612		0.12	50
60	3	10	0.51	514699	PS3/60	2CDL230001R1060		0.47	10
60	3	10	0.51	563758	PS3/60A ②	2CDL230010R1060		0.47	10
60	3	16	0.76	514705	PS3/60/16	2CDL230001R1660		0.65	10
60	3	16	0.76	563765	PS3/60/16A ②	2CDL230010R1660		0.65	10
60	3	30	2.65	654289	PS3/60/30 ③⑤	2CDL230001R3060		2.65	10

3-phase busbars, connection of 1-pole devices with auxiliary, end caps PS-END									
No. of pins	Phases	mm ²	Cu-No.	Bbn 4016779	Order details		Price 1	Weight 1 piece	Pack unit
					Type code	Order code			
			kg	EAN			piece	kg	pc.
39	3	10	0.51	556590	PS3/39H	2CDL230001R1039		0.43	10
39	3	16	0.76	556606	PS3/39/16H	2CDL230001R1639		0.60	10

3-phase busbars, connection of 2-pole devices (Phase+N) with auxiliary, end caps PS-END									
No. of pins	Phases	mm ²	Cu-No.	Bbn 4016779	Order details		Price 1	Weight 1 piece	Pack unit
					Type code	Order code			
			kg	EAN			piece	kg	pc.
24	3	10	0.80	556576	PS3/24H	2CDL230001R1024		0.41	10

3-phase busbars, connection of 2-pole devices (Phase+Phase) with auxiliary, end caps PS-END									
No. of pins	Phases	mm ²	Cu-No.	Bbn 4016779	Order details		Price 1	Weight 1 piece	Pack unit
					Type code	Order code			
			kg	EAN			piece	kg	pc.
46	3	16	0.98	662109	PS3/46/16H-IT	2CDL230006R1646		0.98	10

3-phase busbars, connection of 3-pole devices with auxiliary, end caps PS-END									
No. of pins	Phases	mm ²	Cu-No.	Bbn 4016779	Order details		Price 1	Weight 1 piece	Pack unit
					Type code	Order code			
			kg	EAN			piece	kg	pc.
48	3	10	0.51	556613	PS3/48H	2CDL230001R1048		0.43	10
48	3	16	0.76	556644	PS3/48/16H	2CDL230001R1648		0.60	10
48	3	16	0.76	584654	PS3/48/16HA ②	2CDL230012R1648		0.60	10

3-phase busbars, connection of 1+N or RCBOs, end caps PS-END									
No. of pins	Phases	mm ²	Cu-No.	Bbn 4016779	Order details		Price 1	Weight 1 piece	Pack unit
					Type code	Order code			
			kg	EAN			piece	kg	pc.
30	3	10	0.50	556583	PS3/30	2CDL230001R1030		0.42	10

① inclusive of end caps

② pre-cutted pins

③ use end cap PS-END 3

④ use end cap PS-END 3.1

⑤ removal of installed MCB not possible

Busbars and busbars' accessories for MCBs, RCDs and AFDDs

Busbars PS



PS 3/9 - PS 3/...

3-phase busbars, N of the RCD omitted, end caps PS-END									
No. of pins	Phases	mm ²	Cu-No.	Bbn 4016779	Order details		Price 1	Weight 1 piece	Pack unit
					Type code	Order code			
			kg	EAN			piece	kg	pc.
9	3	10	0.10	517515	PS3/9FI ①	2CDL230002R1009		0.06	50
10	3	10	0.10	517522	PS3/10FI ①	2CDL230002R1010		0.07	50
12	3	10	0.11	571074	PS3/12FI ①	2CDL230002R1012		0.09	50
57	3	10	0.55	556651	PS3/57FI	2CDL230002R1057		0.46	10

3-phase busbars, N of the RCD omitted, with auxiliary at RCD end caps PS-END									
No. of pins	Phases	mm ²	Cu-No.	Bbn 4016779	Order details		Price 1	Weight 1 piece	Pack unit
					Type code	Order code			
			kg	EAN			piece	kg	pc.
12	3	10	0.11	571081	PS3/12FIH ①	2CDL230003R1012		0.09	50

4-phase busbars, pin distance 17.6 mm, end caps PS-END 1									
No. of pins	Phases	mm ²	Cu-No.	Bbn 4016779	Order details		Price 1	Weight 1 piece	Pack unit
					Type code	Order code			
			kg	EAN			piece	kg	pc.
12	4	10	0.12	656054	PS4/12 ①	2CDL240101R1012		0.11	30
12	4	10	0.12	656061	PS4/12A ①②	2CDL240110R1012		0.11	30
12	4	16	0.24	656078	PS4/12/16 ①	2CDL240101R1612		0.16	30
60	4	10	0.80	656085	PS4/60	2CDL240101R1060		0.64	10
60	4	16	1.21	656092	PS4/60/16	2CDL240101R1660		0.89	10
60	4	16	1.21	656108	PS4/60/16A ②	2CDL240110R1660		0.89	10
60	4	30	3.37	654296	PS4/60/30 ④⑤	2CDL240001R3060		3.37	10

Note: PS...A is a busbar with removable pin

① inclusive of end caps

② pre-cutted pins

③ use end cap PS-END 3

④ use end cap PS-END 3.1

⑤ removal of installed MCB not possible

Busbars and busbars' accessories for MCBs, RCDs and AFDDs

Busbars PS



PS 4/12 - PS 4/...

4-phase busbars, connection of 4-pole devices with auxiliary, end caps PS-END 1									
No. of pins	Phases	mm ²	Cu-No. kg	Bbn 4016779 EAN	Order details		Price 1 piece	Weight 1 piece kg	Pack unit pc.
					Type code	Order code			
52	4	16	1.30	656115	PS4/52/16H	2CDL240101R1652		0.78	10
52	4	16	1.30	656122	PS4/52/16HA ②	2CDL240212R1652		0.78	10

4-phase busbars, connection of 1+N or RCBOs, end caps PS-END 1									
No. of pins	Phases	mm ²	Cu-No. kg	Bbn 4016779 EAN	Order details		Price 1 piece	Weight 1 piece kg	Pack unit pc.
					Type code	Order code			
12	4	10	0.14	656139	PS4/12NA ①②	2CDL240213R1012		0.10	30
58	4	10	0.80	656146	PS4/58N	2CDL240101R1058		0.59	10
58	4	16	1.21	656153	PS4/58/16N	2CDL240101R1658		0.77	10
58	4	16	1.21	656221	PS4/58/16NA ②	2CDL240213R1658		0.77	10

4-phase busbars, connection of 1+N or RCBOs with auxiliary, end caps PS-END 1									
No. of pins	Phases	mm ²	Cu-No. kg	Bbn 4016779 EAN	Order details		Price 1 piece	Weight 1 piece kg	Pack unit pc.
					Type code	Order code			
48	4	16	1.48	656160	PS4/48/16NHA ②	2CDL240114R1648		0.76	10

4-phase busbars, connection of 4-pole RCD with 1+N, end caps PS-END 1									
No. of pins	Phases	mm ²	Cu-No. kg	Bbn 4016779 EAN	Order details		Price 1 piece	Weight 1 piece kg	Pack unit pc.
					Type code	Order code			
58	4	10	0.80	656177	PS4/58NNA ②	2CDL240110R1058		0.58	10
58	4	16	1.21	656184	PS4/58/16NNA ②	2CDL240110R1658		0.80	10

Busbars and busbars' accessories for MCBs, RCDs and AFDDs

Busbars PS



PS 4/12 - PS 4/...

Busbars for S-ARC1 installation

4-phase busbars, connection of 4-pole F204 with 1+N S-ARC1, end caps PS-END 1, Bottom side installation									
No. of pins	Phases	mm ²	Cu-No. kg	Bbn 4016779 EAN	Order details		Price 1 piece	Weight 1 piece kg	Pack unit pc.
					Type code	Order code			
12	4	10	0.105	060301	PS4/12NN 1)	2CDL240102R1012		0.110	30
12	4	16	0.149	060332	PS4/12/16NN 1)	2CDL240102R1612		0.145	30
4-phase busbars, connection of 4-pole F204 with 1+N S-ARC1, end caps PS-END 1, Top side installation									
12	4	10	0.105	060356	PS4/12NNT 1)	2CDL240103R1012		0.110	30
12	4	16	0.149	060370	PS4/12/16NNT 1)	2CDL240103R1612		0.145	30

Busbars for DS-ARC1 installation

2-phase busbar, end caps PS-END; both top and bottom side mounting									
No. of pins	Phases	mm ²	Cu-No. kg	Bbn 4016779 EAN	Order details		Price 1 piece	Weight 1 piece kg	Pack unit pc.
					Type code	Order code			
8	2	16	0.105	063104	PS 2/8/16 AFDD	2CDL220102R1608		0.095	50
40	2	16	0.495	063111	PS 2/40/16 AFDD	2CDL220102R1640		0.51	10
4-phase busbar, end caps PS-END 1; first one: top side mounting; second one: bottom side mounting									
36	4	16	0.985	063128	PS 4/36/16 AFDD T	2CDL240103R1636		0.67	10
36	4	16	0.985	063135	PS 4/36/16 AFDD	2CDL240102R1636		0.67	10
4-phase busbar, connection with auxiliary, end caps PS-END 1; first one: top side mounting; second one: bottom side mounting									
30	4	16	0.915	063142	PS4/30/16HAFDDT	2CDL240103R1630		0.62	10
30	4	16	0.915	063159	PS4/30/16HAFDD	2CDL240102R1630		0.62	10

Busbars and accessories for MCBs, RCDs and AFDDs

Busbars PS



PS 3/16 - PS 3/...

Busbars (suitable for cutting) for DDA 200 and DS 200 – bottom mounting (RCD)

3-phase busbars, connection of DDA 202 and DS 202, end caps PSB-END 3
(phase sequence L1-L2-free-free-L3-L1.....without N)

No. of pins	Phases	mm ²	Cu-No.	Bbn	Order details		Price	Weight	Pack
			4016779	4016779	Type code	Order code	1	1 piece	unit
			kg	EAN	Type code	Order code	piece	kg	pc.
30	3	10	0.97	647472	PS 3/ 30-DDA 202	2CDL230202R1030		0.41	10
30	3	16	1.46	647502	PS 3/30/ 16-DDA 202	2CDL230202R1630		0.55	10

3-phase busbars, connection of DDA 202 and DS 202 with auxiliary, end caps PSB-END 3
(phase sequence L1-L2-aux.(free)-free-free-L3-L1-aux.(free).....without N)

No. of pins	Phases	mm ²	Cu-No.	Bbn	Order details		Price	Weight	Pack
			4016779	4016779	Type code	Order code	1	1 piece	unit
			kg	EAN	Type code	Order code	piece	kg	pc.
26	3	16		648912	PS 3/26/ 16H-DDA 202	2CDL230202R1626			

4-phase busbars, connection of DDA 204 63 A and DS 204 50 A and 63 A, end caps PSB-END 4
(phase sequence L1-L2-L3-N-free-free-free-free-L1.....)

No. of pins	Phases	mm ²	Cu-No.	Bbn	Order details		Price	Weight	Pack
			4016779	4016779	Type code	Order code	1	1 piece	unit
			kg	EAN	Type code	Order code	piece	kg	pc.
32	4	10	1.41	647458	PS 4/ 32-DDA 204	2CDL240204R1032		0.56	10
32	4	16	2.12	647465	PS 4/32/ 16-DDA 204	2CDL240204R1632		0.77	10

Busbars (suitable for cutting) for DDA 200 and DS 200 – top side mounting (MCB)

2-phase busbars, connection of DDA 202 and DS 202, end caps PSB-END 3
(phase sequence L1-L2/N-free-free-.....)

No. of pins	Phases	mm ²	Cu-No.	Bbn	Order details		Price	Weight	Pack
			4016779	4016779	Type code	Order code	1	1 piece	unit
			kg	EAN	Type code	Order code	piece	kg	pc.
30	2	16	0.512	697675	PS 2/30/ 16N-DDA 202T	2CDL020202R1630			10

3-phase busbars, connection of DDA 202 and DS 202, end caps PSB-END 3
(phase sequence L1-L2-free-free-L3-L1.....without N)

No. of pins	Phases	mm ²	Cu-No.	Bbn	Order details		Price	Weight	Pack
			4016779	4016779	Type code	Order code	1	1 piece	unit
			kg	EAN	Type code	Order code	piece	kg	pc.
30	3	16	1.25	652629	PS 3/30/ 16-DDA 202T	2CDL033202R1630			10

3-phase busbars, connection of DDA 202 and DS 202 with auxiliary, end caps PSB-END 3
(phase sequence L1-L2-aux.(free)-free-free-L3-L1-aux.(free).....without N)

No. of pins	Phases	mm ²	Cu-No.	Bbn	Order details		Price	Weight	Pack
			4016779	4016779	Type code	Order code	1	1 piece	unit
			kg	EAN	Type code	Order code	piece	kg	pc.
28	3	16	1.31	652636	PS 3/28/ 16H-DDA 202T	2CDL034202R1628			10

Busbars and accessories for MCBs, RCDs and AFDDs

Busbars PS



PS 4/36 - PS 4/...

4-phase busbars, connection of DDA 202 and DS 202, end caps PSB-END 4 (phase sequence L1-N-free-free-L2-N...)

No. of pins	Phases	mm ²	Cu-No.	Bbn 4016779	Order details		Price 1	Weight 1 piece	Pack unit
					Type code	Order code			
			kg	EAN			piece	kg	pc.
30	4	16	1.67	652852	PS 4/30/ 16N-DDA 202T	2CDL040202R1630			10

4-phase busbars, connection of DDA 202 and DS 202 with auxiliary, end caps PSB-END 4 (phase sequence L1-N-aux.(free)-free-free-L2-N-aux.(free)...)

No. of pins	Phases	mm ²	Cu-No.	Bbn 4016779	Order details		Price 1	Weight 1 piece	Pack unit
					Type code	Order code			
			kg	EAN			piece	kg	pc.
30	4	16	1.72	652599	PS 4/30/ 16NH-DDA 202T	2CDL041202R1630			10

4-phase busbars, connection of DDA 204 25 A and 40 A and DS 204 up to 40 A, end caps PSB-END 4 (phase sequence L1-L2-L3-N-free-free-L1.....)

No. of pins	Phases	mm ²	Cu-No.	Bbn 4016779	Order details		Price 1	Weight 1 piece	Pack unit
					Type code	Order code			
			kg	EAN			piece	kg	pc.
40	4	16	1.79	652605	PS 4/40/ 16-DDA 204T	2CDL040204R1640			10

4-phase busbars, connection of DDA 204 25 A and 40 A and DS 204 up to 40 A with auxiliary, end caps PSB-END 4 (phase sequence L1-L2-L3-N-aux.(free)-free-free-free-free-L1)

No. of pins	Phases	mm ²	Cu-No.	Bbn 4016779	Order details		Price 1	Weight 1 piece	Pack unit
					Type code	Order code			
			kg	EAN			piece	kg	pc.
36	4	16	1.73	652612	PS 4/36/ 16H-DDA 204T	2CDL041204R1636			10

Busbars and busbars' accessories for MCBs, RCDs and AFDDs

Accessories for Busbars PS



PS-END

Accessories for busbars PS ...

End caps					
	Bbn 4016779	Order details		Weight 1 piece	Pack unit
	EAN	Type code	Order code	kg	pc.
	638913	END 1.1	2CDL200011R0011	0.001	50
	652261	PS-END 0	2CDL200001R0004	0.001	50
	514729	PS-END	2CDL200001R0001	0.001	50
	570114	PS-END 1	2CDL200001R0002	0.001	50
	646505	PS-END SP	2CDL200110R0001	0.001	50
	646512	PS-END 1 SP	2CDL200110R0002	0.001	50
	654302	PS-END 3	2CDL200001R3001	0.001	50
	654319	PS-END 3.1	2CDL200001R3002	0.001	50
	556304 ^①	PSB-END 3	GHV0361325R0001	0.001	50
	556403 ^①	PSB-END 4	GHV0361325R0002	0.001	50
	950060	PS-END 3 BP-C	2CDL200489R0003	0.001	50

^① bbn-No. 4012233



SZ-BSK



BSK

Shock-protection caps for busbars PS...

No. of pins	Phases	mm ²	Cu-No.	Bbn 4016779	Order details		Weight 1 piece	Pack unit
				kg	EAN	Type code	Order code	kg
5 parts				420006	SZ-BSK	2CDL200001R0011	0.003	10
5 parts				649834	BSK*	2CDL200001R0012	0.003	10

* closed version

Busbars and busbars' accessories for RCBOs DS202CR

Busbars BR



BR-S 2/12/10

Busbars for DS202CR

Busbars							
No. of Pins	Phases	mm ²	Bbn 405354	Order details		Weight 1 piece	Pack unit
			EAN	Type code	Order code	kg	pc.
12	2	10	6054347	BR-S 2/12/10	2CDL824001R1012	0,026	10
56	2	16	6054361	BR-S 2/56/16	2CDL824001R1656	0,241	20
10	2	10	6054323	BR-S 2/10/10H	2CDL824001R1010	0,026	10
46	2	16	6054354	BR-S 2/46/16H	2CDL824001R1646	0,241	20
12	4	10	6054453	BR-S 4/12/10	2CDL844001R1012	0,026	5
54	4	10	6054460	BR-S 4/54/10	2CDL844001R1054	0,241	15
54	4	16	6054477	BR-S 4/54/16	2CDL844001R1654	0,241	15

Accessories

End Caps							
No. of Pins	Phases	mm ²	Bbn 405354	Order details		Weight 1 piece	Pack unit
			EAN	Type code	Order code	kg	pc.
		10/16	6046717	BB-END 2.1	2CDL800001R0021	0,001	10
		16	6046731	BB-END 3.2	2CDL800001R0030	0,001	10
		10/16	6046823	BB-END 4.1	2CDL800001R0040	0,001	10



BR-FS 25/14

Feeder terminal							
No. of Pins	Phases	mm ²	Bbn 405354	Order details		Weight 1 piece	Pack unit
			EAN	Type code	Order code	kg	pc.
		25	6062366	BR-FS 25/14	2CDL800001R2514	0,018	30



BR-BS

Shock protection caps							
No. of Pins	Phases	mm ²	Bbn 405354	Order details		Weight 1 piece	Pack unit
			EAN	Type code	Order code	kg	pc.
			6062403	BR-BS	2CDL800001R0051	0,018	10

Busbars and busbars' accessories for compact MCBs SN201

Busbars BS9 and BF2-S9

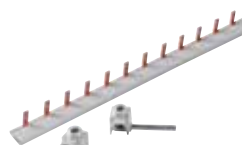

BS9+FEED-IN

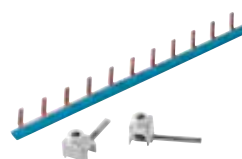

BS9 NA+FEED-IN

Busbars for SN 201 range (Maximum rated current 63 A)							
No. pins	Phases	Cross section	Bbn 8012542	Order details		Weight 1 piece	Pack unit
				EAN	Type code		
		mm ²				kg	pc.
12	1	10	047650	BS9 1/12	2CSL910001R1012	0.050	10
12	1	10	047759	BS9 1/12 NA	2CSL910011R1012	0.050	10
56	1	10	047353	BS9 1/56	2CSL910001R1056	0.140	10
56	1	10	047452	BS9 1/56 NA	2CSL910011R1056	0.140	10
12	3	10	047551	BS9 3/12	2CSL930001R1012	0.090	5
57	3	10	047858	BS9 3/57	2CSL930001R1057	0.470	5

Busbars for F200/S200 and SN 201 range (Maximum rated current 63 A)							
No. pins	Phases	Cross section	Bbn 8012542	Order details		Weight 1 piece	Pack unit
				EAN	Type code		
		mm ²				kg	pc.
2 + 10 x 1+N	2	10	046950	BF2-S9 UP 1N/12	2CSL920009R1012	0.110	5
4 + 8 x 1+N	4	10	047056	BF2-S9 UP 3N/12	2CSL940009R1012	0.110	5
2 + 10 x 1+N	2	10	047155	BF2-S9 DOWN 1N/12	2CSL920002R1012	0.110	5
4 + 8 x 1+N	4	10	047254	BF2-S9 DOWN 3N/12	2CSL940002R1012	0.110	5

Accessories

Feeder Terminal							
Conn. capacity	Type of connection	Terminal lug L	Bbn 8012542	Order details		Weight 1 piece	Pack unit
				EAN	Type code		
		mm				kg	pc.
25	pin	15	047957	FEED-IN 25/15 1P	2CSL980001R2515	0.010	5
25	pin	30	048053	FEED-IN 25/30 3P	2CSL980001R2530	0.010	5

End caps							
			Bbn 4012233	Order details		Weight 1 piece	Pack unit
				EAN	Type code		
						kg	pc.
			064251	BS9-END 3P ①	2CSL980001R0001	0.001	20

① In combination with BS9 3/57

Busbars and busbars' accessories for compact MCBs S200C

Busbars BB



BB-SU 1/13/10 GREY



BB-FS 25/27 Q



BB-END

Busbars available for the connection with S200C series

No. pins	Phases	Distrib.	Supply	mm ²	Bbn 4053546 EAN	Order details		Weight 1 piece	Pack unit
						Type code	Order code		
13	1P	1P+N MCBs	10	046830	BB-SU 1/13/10 GREY ⁽¹⁾	2CDL801141R1013	0.044	15	
13	1P	1P+N MCBs	10	046847	BB-S 1/13/10 BLUE ⁽²⁾	2CDL801145R1013	0.044	15	
36	2P	2P or 1P +N MCBs	10	046755	BB-SU 2/36/10	2CDL802141R1018	0.112	20	
112	2P	2P or 1P +N MCBs	10	046816	BB-SU 2/112/10	2CDL802141R1055	0.336	20	
24	3P	2P MCBs	10	046762	BB-SU 3/24/10	2CDL803141R1024	0.125	15	
112	3P	2P MCBs	10	046779	BB-SU 3/112/10	2CDL803141R1111	0.579	15	
108	3P+N	2P MCBs	10	046809	BB-SU 4/108/10 N	2CDL804142R1110	0.752	10	
112	3P+N	4P or 3P +N MCBs	10	046786	BB-SU 4/112/10 Kit*	2CDL804141R1055	0.640	5	

* incl. 4 end caps and 4 connection clamps

(1) Phase connection

(2) Neutral connection

Accessories

Feeder Terminal

mm ²	Bbn 4053546 EAN	Order details		Weight 1 piece	Pack unit
		Type code	Order code		
25	046748	BB-FS 25/27 Q	2CDL800001R2527	0.015	30

End Caps

mm ²	Bbn 4053546 EAN	Order details		Weight 1 piece	Pack unit
		Type code	Order code		
10/16	046717	BB-END 2.1	2CDL800001R0021	0.001	10
16	046731	BB-END 3.2	2CDL800001R0030	0.001	10
10/16	046823	BB-END 4.1	2CDL800001R0040	0.001	10

Busbars and busbars' accessories for compact RCBOs DS301C

NEW

Busbars PSc

PSc Busbars							
No.of Modules	Phases	mm ²	EAN	Type code	Order code	Weight 1 piece	Pack unit
12	1	10	4053546050516	PSc 1/24/10 N	2CDL210331R1012	0.103	10
56	1	10	4053546050530	PSc 1/120/10 N	2CDL210331R1060	0.511	10
12	3	10	4053546050554	PSc 3/24/10 N	2CDL230331R1012	0.145	10
56	3	10	4053546050561	PSc 3/120/10 N	2CDL230331R1060	0.725	10
Accessories							
End Caps							
EAN	Type code	Order code	Weight 1 piece	Pack unit			
4053546051131	PSc-END	2CDL200331R0003	0.015	10			
Shock protection Caps							
EAN	Type code	Order code	Weight 1 piece	Pack unit			
4053546051124	BSKc	2CDL200331R0013	0.001	10			
Feeder Terminal							
EAN	Type code	Order code	Weight 1 piece	Pack unit			
4016779655316	AST 25/27 QS	2CDL200001R2506	0.011	50			



Busbars and busbars' accessories for MCBs acc. UL 489

Busbars PS...BP



PS2/6/16 BP



BSK BP



AST35/15BP



SZ-ESK BP

Pre-assembled busbars (not to be cut), suitable for SU200 M, S200 UDC, S200 U and S200 UP

1-phase busbars, pin distance 17.6 mm, UL 489								
No. of pins	Phases	mm ²	Cu-No.	Bbn 4016779	Order details		Weight 1 piece	Pack unit
					Type code	Order code		
6	1	16	0.04	644969	PS 1/6/16 BP	2CDL210489R1606	0.05	1
12	1	16	0.07	644976	PS 1/12/16 BP	2CDL210489R1612	0.11	1
18	1	16	0.11	644983	PS 1/18/16 BP	2CDL210489R1618	0.16	1

2-phase busbars, pin distance 17.6 mm, UL489								
No. of pins	Phases	mm ²	Cu-No.	Bbn 4016779	Order details		Weight 1 piece	Pack unit
					Type code	Order code		
6	2	16	0.07	644990	PS 2/6/16 BP	2CDL220489R1606	0.06	1
12	2	16	0.14	645003	PS 2/12/16 BP	2CDL220489R1612	0.13	1
18	2	16	0.21	645010	PS 2/18/16 BP	2CDL220489R1618	0.20	1

3-phase busbars, pin distance 17.6 mm, UL 489								
No. of pins	Phases	mm ²	Cu-No.	Bbn 4016779	Order details		Weight 1 piece	Pack unit
					Type code	Order code		
6	3	16	0.11	645027	PS 3/6/16 BP	2CDL230489R1606	0.07	1
12	3	16	0.22	645034	PS 3/12/16 BP	2CDL230489R1612	0.15	1
18	3	16	0.33	645041	PS 3/18/16 BP	2CDL230489R1618	0.24	1

Accessories for busbars PS...BP

Feeder Terminals for PS...BP (UL 489)							
Conn. capacity	Cu-No.	Bbn 4016779	Order details			Weight 1 piece	Pack unit
			mm ²	kg	EAN		
35	0.035	710350	AST 35/15 BP	2CDL201489R3515	0.035	25	

Single-pole terminal, can be mounted side by side, feed on the pin of the busbar							
50		710367	SZ-ESK BP	2CDL201489R5001	0.038	50	

Shock-protection caps for PS...BP (UL 489)							
	Bbn 4016779	Order details			Weight 1 piece	Pack unit	
		EAN	Type code	Order code			
3 parts	656368	BSK BP	2CDL200489R0001	0.001	10		

- ① inclusive of end caps
- ② pre-cutted pins
- ③ use end cap PS-END 3
- ④ use end cap PS-END 3.1
- ⑤ removal of installed MCB not possible

Busbars and busbars' accessories for MCBs acc. UL 489

Busbars PS...BP-C



PS1/57/25BP-C

Busbars PS....BP-C (suitable for cutting), suitable for:
SU200 M, S200 UDC, S200 U and S200 UP

1-phase busbars, pin distance 17.6 mm, end caps PS-END 3 BP-C								
No. of pins	Phases	mm ²	Cu-No.	Bbn 4016779	Order details		Weight 1 piece	Pack unit
			kg	EAN	Type code	Order code	kg	pc.
57	1	25	0.47	949910	PS1/57/25BP-C	2CDL210489R5725	0.775	10
1-phase busbars, connection of 1-pole devices with auxiliary, end caps PS-END 3 BP-C								
No. of pins	Phases	mm ²	Cu-No.	Bbn 4016779	Order details		Weight 1 piece	Pack unit
			kg	EAN	Type code	Order code	kg	pc.
37	1	25	0.5	949934	PS1/37/25HBP-C	2CDL210489R3725	0.661	10
2-phase busbars, pin distance 17.6 mm, end caps PS-END 3 BP-C								
No. of pins	Phases	mm ²	Cu-No.	Bbn 4016779	Order details		Weight 1 piece	Pack unit
			kg	EAN	Type code	Order code	kg	pc.
56	2	25	0.888	949941	PS2/56/25BP-C	2CDL220489R5625	0.969	10
2-phase busbars, connection of 2-pole devices with auxiliary, end caps PS-END 3 BP-C								
No. of pins	Phases	mm ²	Cu-No.	Bbn 4016779	Order details		Weight 1 piece	Pack unit
			kg	EAN	Type code	Order code	kg	pc.
46	2	25	0.87	949958	PS2/46/25HBP-C	2CDL220489R4625	0.943	10
3-phase busbars, pin distance 17.6 mm, end caps PS-END 3 BP-C								
No. of pins	Phases	mm ²	Cu-No.	Bbn 4016779	Order details		Weight 1 piece	Pack unit
			kg	EAN	Type code	Order code	kg	pc.
57	3	25	1,31	949965	PS3/57/25BP-C	2CDL230489R5725	1.198	10
3-phase busbars, connection of 3-pole devices with auxiliary, end caps PS-END 3 BP-C								
No. of pins	Phases	mm ²	Cu-No.	Bbn 4016779	Order details		Weight 1 piece	Pack unit
			kg	EAN	Type code	Order code	kg	pc.
48	3	25	1,28	949972	PS3/48/25HBP-C	2CDL230489R4825	1.129	10
39	3	25	1,305	949989	PS3/39/25HBP-C	2CDL230489R3925	1.115	10

Accessories for busbars PS....BP-C

Feeder Terminal								
Conn. capacity mm ²	Cu-No.	Bbn 4016779	Order details		Weight 1 piece	Pack unit		
	kg	EAN	Type code	Order code	kg	pc.		
25	0.038	950060	AST 35/58 BP-C	2CDL201489R3558	0.045	10		
Shock-protection caps for PS....BP-C								
Phases	Bbn 4016779	Order details		Weight 1 piece	Pack unit			
	EAN	Type code	Order code	kg	pc.			
3 parts	950077	BS BP-C	2CDL200489R0002	0.005	10			

Busbars and busbars' accessories for MCBs acc. UL 1077

Busbars PS...CB



PS 3/57/18 CB

Busbars PS...CB (suitable for cutting)

			Bbn 4016779	Order details		Weight 1 piece	Pack unit
No. of pins	Phases	mm ²	EAN	Type code	Order code	kg	pc.
1-phase busbars, pin distance 17.6 mm, end caps PS-END 1 CB							
57	1	18	906760	PS 1/57/18 CB	2CDL210508R5718	0.289	10
57	1	25	906913	PS 1/57/25 CB	2CDL210508R5725	0.360	10
1-phase busbars, connection of 1-pole devices with auxiliary, end caps PS-END 1 CB							
37	1	18	906784	PS 1/37/18 H CB	2CDL210508R3718	0.254	10
37	1	25	906937	PS 1/37/25 H CB	2CDL210508R3725	0.310	10
2-phase busbars, pin distance 17.6 mm, end caps PS-END 3 CB							
56	2	18	906807	PS 2/56/18 CB	2CDL220508R5618	0.639	10
56	2	25	906951	PS 2/56/25 CB	2CDL220508R5625	0.795	10
2-phase busbars, connection of 2-pole devices with auxiliary, end caps PS-END 3 CB							
46	2	18	906821	PS 2/46/18 H CB	2CDL220508R4618	0.672	10
46	2	25	906975	PS 2/46/25 H CB	2CDL220508R4625	0.782	10
3-phase busbars, pin distance 17.6 mm, end caps PS-END 3 CB							
57	3	18	906852	PS 3/57/18 CB	2CDL230508R5718	0.929	10
57	3	25	906999	PS 3/57/25 CB	2CDL230508R5725	1.026	10
3-phase busbars, connection of 3-pole devices with auxiliary, end caps PS-END 3 CB							
48	3	18	906876	PS 3/48/18 H CB	2CDL230508R4818	0.788	10
48	3	25	907019	PS 3/48/25 H CB	2CDL230508R4825	0.974	10
3-phase busbars, connection of 1-pole devices with auxiliary, end caps PS-END 3 CB							
39	3	18	906890	PS 3/39/18 H CB	2CDL230508R3918	0.794	10
39	3	25	907033	PS 3/39/25 H CB	2CDL230508R3925	0.974	10

Accessories

Description	Bbn 4016779	Order details		Weight 1 piece	Pack unit
	EAN	Type code	Order code	kg	pc.
Feeder terminals with pin contact					
for use with MCB and 1-phase busbar	907156	AST 35/15-2 CB	2CDL202508R3515	0.025	25
for use with MCB and 2-/3-phase busbar	067904	AST 35/38-2 CB	2CDL202508R3538	0.032	10
for use with E90 and 2-/3-phase busbar	907132	AST 35/38-1 CB	2CDL201508R3538	0.032	10
for use with E90 and 1-phase busbar	907118	AST 35/15-1 CB	2CDL201508R3515	0.025	25
Single-pole terminal, can be mounted side by side, feed to the busbar pin					
	710381	SZ ESK SP	2CDL200111R5001	0.032	50
End caps					
for use with PS 1...CB	907057	PS-END 1 CB	2CDL200508R0001	0.001	50
for use with PS 2...CB and PS3...CB	907071	PS-END 3 CB	2CDL200508R0003	0.002	50
Shock-protection cap					
	907095	BSK CB	2CDL200508R0011	0.008	10

Busbars and busbars' accessories for MCBs acc. UL 1077

Busbars PS...CB

Installation of busbars and use of feeder terminals/cables for feed

MCB with 1-phase busbar
Feeder terminal AST 35/15-2 CB

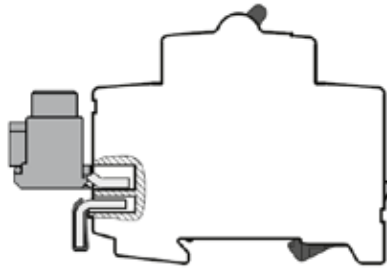

MCB with 1-phase busbar
Feed using cable

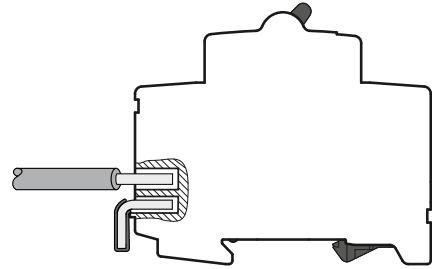

E90 with 1-phase busbar
Feeder terminal AST 35/15-1 CB

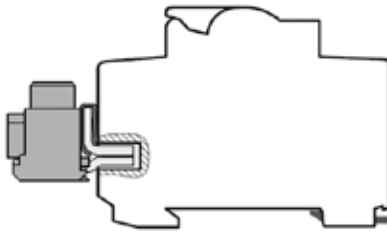

E90 with 1-phase busbar
Feed using cable

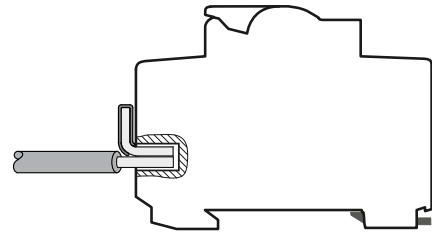

E90 with 2-/3-phase busbar
Feeder terminal AST 35/38-1 CB

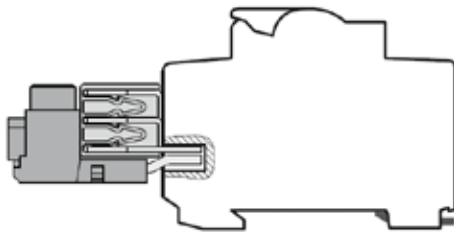

E90 with 2-/3-phase busbar
Feed using cable

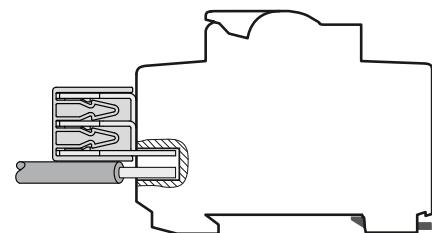

MCB with 2-/3-phase busbar
Feeder terminal AST 35/38-2 CB

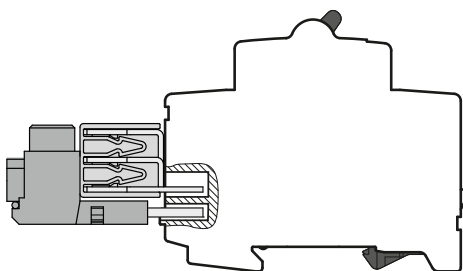

MCB with 2-/3-phase busbar
Feed using cable

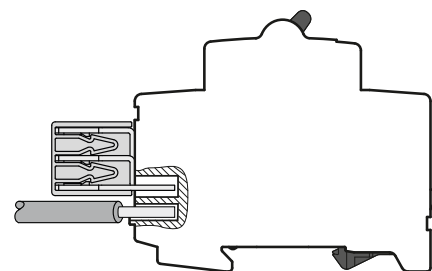

Busbars and busbars' accessories for ST200 MRT

Busbars PS...BP-CR



Busbars PS...BP-CR (suitable for cutting)

No. of pins	Phases	mm ²	Bbn	Order details		Weight 1 piece	Pack unit
			4016779	EAN	Type code		
57	1	25	949996	PS1/57/25BP-CR	2CDL211489R5725	0,810	10
37		25	950008	PS1/37/25BP-CR	2CDL211489R3725	0,684	10
56	2	25	950015	PS2/56/25BP-CR	2CDL221489R5625	1,009	10
46		25	950022	PS2/46/25BP-CR	2CDL221489R4625	0,967	10
57	3	25	950039	PS3/57/25BP-CR	2CDL231489R5725	1,244	10
48		25	950046	PS3/48/25BP-CR	2CDL231489R4825	1,168	10
39		25	950053	PS3/39/25BP-CR	2CDL231489R3925	1,147	10

Accessories

Description	Bbn	Bbn	Order details		Weight 1 piece	Pack unit		
	4013614	4016779	EAN	EAN			Type code	Order code
Schock-protection cap	511219				BSK BP-CR	2CDL200489R0005	0,005	50
End cap		950060			PS-END 3 BP-C	2CDL200489R0003	0,001	50

Busbars and busbars' accessories for 1000 V DC applications

Busbars PS...DC



PS 2/60/30 DC

Busbars PS...DC (cuttable) for use with end caps PS-END0 and PS-END3

No. of phases	Phase sequence	Bbn 4016779	Order details		Pack unit pcs.	Weight 1 pc. kg
		EAN	Type code	Order code		
1	L1-L1-L1...	960168	PS1/60/30DC	2CDL210130R6030	10	0.485
	L1-Aux (free)-L1-Aux (free)... ¹	960175	PS1/39/30HDC	2CDL210130R3930	10	0.435
2	L1-L2-L1-L2...	960199	PS2/60/30DC	2CDL220130R6030	10	0.94
	L1-Aux (free)-L2-Aux (free)... ¹	960212	PS2/38/30HDC	2CDL220130R3830	10	0.85

¹ for devices with auxiliary contact (half module) after each phase sequence or for devices with 27mm module width

Accessories

Description	Bbn 4016779	Order details		Pack unit pcs.	Weight 1 pc. kg
	EAN	Type code	Order code		
Feeder Terminals					
Feeder terminal in combination with 1-phase busbar	962483	AST35/18DC	2CDL200130R3518	10	0.025
Feeder terminal in combination with 2-phase busbar	962490	AST35/45DC	2CDL200130R3545	10	0.032
End caps					
End caps 1-phase busbar	652261	PS-END0 ²	2CDL200001R0004	25	0.001
End caps 2-phase busbar	654302	PS-END3	2CDL200001R3001	50	0.001
Shock protection caps					
Tooth covers, for 5 pins (pin distance 17.6 mm)	420006	SZ-BSK	2CDL200001R0011	10	0,003

² 1 pair (= left and right end cap)

Accessories

for S 200, SN 201, F 200, DS 200 and other series

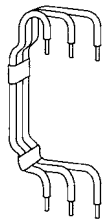

RV 3

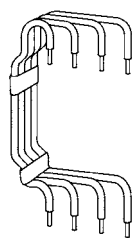

RV 4



identification label

Rail connectors

For wiring of component rails in the consumer unit, rail-to-rail clearance 125 mm. In the case of the 4-pole connector, the color of the N conductor is blue.

No. of pins	Phases	mm ²	Cu-No.	Bbn 4016779	Order details		Price 1	Weight 1 piece	Pack unit
					EAN	Type code			
	3-pole	10		512381	RV 3	GHV0360504R0023		0.080	25
	4-pole	10		512244	RV 4	GHV0360504R0024		0.114	25

Auxiliary contact bridge for bottom-fitting auxiliary contacts

Wire jumper for integrated auxiliary contact (MCB S200 H or auxiliary contacts S2C-H01/S2C-H10) for series connections (HKB) or parallel connections (HKB1).

No. of pins	Phases	mm ²	Cu-No.	Bbn 4016779	Order details		Price 1	Weight 1 piece	Pack unit
					EAN	Type code			
	1/2 mod.				523134	GHV0360504R0100		0.001	1000
	1 mod.				524209	GHV0360504R0101		0.001	1000

Labelling system

Package comes with 40 labels, marked or blank. Blank labels can be labeled by hand with an indelible, waterproof pen or using a computerised labelling system (plotter).

Description	Bbn 4016779	Order details		Price 1	Weight 1 piece	Pack unit	
		EAN	Type code				Order code
identification labels blank	478106	BS		GHS2001946R0001		0.004	30
identification labels with pictograms	478205	BS Pikto		GHS2001946R0002		0.004	30
identification labels marked 4 x 1 – 10	478304	BS 1/10		GHS2001946R0003		0.004	30
identification labels marked 2 x 1 – 20	478403	BS 1/20		GHS2001946R0004		0.004	30
identification labels marked 1 – 40	478502	BS 1/40		GHS2001946R0005		0.004	30
identification labels marked 41 – 80	585910	BS 41 – 80		GHS2001946R0006		0.004	30
identification labels marked 81 – 120	585927	BS 81 – 120		GHS2001946R0007		0.004	30
identification labels marked 121 – 160	585934	BS 121/160		GHS2001946R0008		0.004	30

Accessories

for S 200, SN 201, F 200, DS 200 and other series

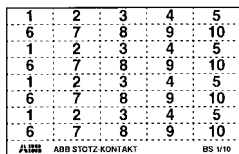

BS 1/10

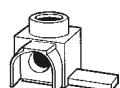

Ast 25/15 QS

Ast 25/15 Q

Ast 25/30 QS

Ast 25/30 Q

Ast 50/15 QS

Ast 50/15 Q

Ast 50/18 Q

Ast 50/32 Q

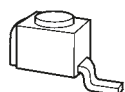

SZ-Ast 95 gk

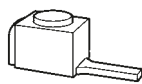

SZ-Ast 95

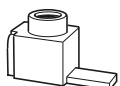

Ast 25/15 S

Ast 50/15 S

Ast 50/15

Ast 50/18

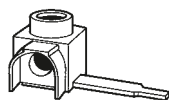

Ast 50/32 Q

Identification system ILS

The ILS individual identification system for labels is a DIN A5 polyester film for ink jet and laser printers with high temperature resistance. (If laser printers are used, please check whether self-adhesive film with thickness of 250 µm can be fed.) Adhesive coating 3MTM9471 LE has obtained UL approval (file No. MH 11410). There are two types of sheet: uncut for making individual labels or pre-cut with 23 stripes (6 x 191 mm each) for labelling 11 devices (1-module width) per stripe. Word template can be downloaded from www.abb.de/stotz-kontakt. Can also be used as write-on labels (ink, ballpoint pen, pencil, marker).

Description	Bbn 4016779	Order details		Price 1 piece	Weight 1 piece kg	Pack unit pc.
		EAN	Type code			
1 sheet DIN A5 uncut for laser printer	663076	ILS-L	2CDL200002R0003		0.011	1
1 sheet DIN A5 pre-cut in 23 stripes (6 x 191 mm) for laser printer	663083	ILS-LS	2CDL200002R0004		0.011	1
1 sheet DIN A5 uncut for inkjet printer	663090	ILS-I	2CDL200002R0005		0.011	1
1 sheet DIN A5 pre-cut in 23 stripes (6 x 191 mm) for inkjet printer	663106	IILS-IS	2CDL200002R0006		0.011	1

Terminals, insulated with pin contact

Technical features			
Connection capacity	6-25 mm ²	6-50 mm ²	25-95 mm ²
Max. electrical load	63 A	100 A	225 A
Max. operating voltage	600 V AC	600 V AC	690 V AC
Max. tightening torque	2 Nm	3 Nm	19 Nm

The terminals are single-phase. When combined in a multi-phase installation the required clearance and creepage distances needs to be considered!

Conn. capacity	Terminal lug	Type of connection	Cu-No.	Bbn 4016779	Order details		Price 1 piece	Weight 1 piece kg	Pack unit pc.
					EAN	Type code			
mm ²	LxW mm		kg	EAN	Type code	Order code			
6-25	14/6	90°	0.012	656535	Ast 25/15 QS	2CDL200010R2515			50
6-25	15/4	straight	0.012	656542	Ast 25/15 S	2CDL200011R2515			50
6-25	13.5/7	90°	0.012	656474	Ast 25/15 Q	2CDL200000R2515			50
6-25	22/4	90°	0.012	669436	Ast 25/22 QS	2CDL200010R2522			50
6-25	30/4	90°	0.012	656481	Ast 25/30 QS	2CDL200010R2530			50
6-25	30/6	90°	0.014	656498	Ast 25/30 Q	2CDL200000R2530			50
6-50	13.5/4	90°	0.014	656504	Ast 50/15 QS	2CDL200000R5015			50
6-50	14/4	straight	0.014	656566	Ast 50/15 S	2CDL200011R5015			50
6-50	15/7	90°	0.014	656559	Ast 50/15 Q	2CDL200010R5015			50
6-50	15/7	straight	0.014	656511	Ast 50/15	2CDL200001R5015			50
5-50	17.5/7	90°	0.019	656580	Ast 50/18 Q	2CDL200100R5018			50
6-50	17.5/7	straight	0.019	656573	Ast 50/18	2CDL200101R5018			50
6-50	32/6	90°	0.017	656528	Ast 50/32 Q	2CDL200000R5032			50
25-95	21/6.5	straight	0.06	522618	SZ-Ast 95 gk*	GHV0360501R0012		0.067	50
25-95	21/6.5	straight	0.06	522625	SZ-Ast 95*	GHV0360501R0013		0.067	50

Abbreviations: Q terminal 90°

* not for pro M compact S narrow connection pin

Accessories

for S 200, SN 201, F 200, DS 200 and other series



SZ-ESK 2

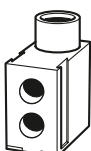

SZ-ESK 3

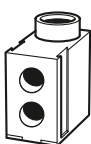

SZ-ESK 3 S



SZ-DB 121



SZ-DB 232 N



SZ-DB 125 N

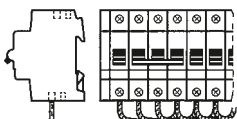

example 1
wiring of devices
consisting of modules
with different lengths
with SZ-DB 125 N or 312

Feeder terminals

Single-pole terminals can be mounted side by side with multipole terminals.

Conn. capacity	Termi- nal lug LxW mm	Type of con- nec- tion	Cu-No. kg	Bbn 4016779 EAN	Order details		Price 1 piece	Weight 1 piece kg	Pack unit pc.
					Type code	Order code			
6-35				646765	SZ-ESK 2	2CDL200001R3501		0.024	10
6-50				652575	SZ-ESK 3	2CDL200003R5001		0.025	10
6-50				652889	SZ-ESK 3 S	2CDL200003R5003		0.024	10

Flexible connecting wires

Advantages: smaller dimensions for the same cross-section (more space in terminal)

nearly no transition resistances

more reliability; conductor sleeves could be loosen under specific conditions

with fork-type cable lug (black)

Conn. capacity	Lenght		Bbn 4012233 EAN	Order details		Price 1 piece	Weight 1 piece kg	Pack unit pc.
				Type code	Order code			
6	125	0.006	556502	SZ-DB 121	GHV0361425R0001		0.025	1000/50
10	135	0.010	556700	SZ-DB 122 N	GHV0361425R0031		0.02	500/25
6	260	0.014	556809	SZ-DB 231 N	GHV0361425R0032		0.02	500/25
10		0.022	556908	SZ-DB 232 N	GHV0361425R0033		0.04	250/25
10	330	0.029	557004	SZ-DB 311	GHV0361425R0034		0.05	100/25

with fork-type cable lug and ultrasonic compacted cable ends (black)

Conn. capacity	Lenght		Bbn 4012233 EAN	Order details		Price 1 piece	Weight 1 piece kg	Pack unit pc.
				Type code	Order code			
6	125	0.007	556601	SZ-DB 123	GHV0361425R0006		0.01	1000/50
10	135	0.012	557103	SZ-DB 124 N	GHV0361425R0035		0.02	500/25
6	260	0.014	557202	SZ-DB 235	GHV0361425R0036		0.02	500/25
10		0.024	557301	SZ-DB 236	GHV0361425R0037		0.04	250/25

with ultrasonic compacted cable ends (black)

Conn. capacity	Lenght		Bbn 4012233 EAN	Order details		Price 1 piece	Weight 1 piece kg	Pack unit pc.
				Type code	Order code			
6	125	0.007	557400	SZ-DB 125 N	GHV0361425R0038		0.01	1000/50
6	260	0.015	557509	SZ-DB 233 N	GHV0361425R0039		0.02	500/25
10	135	0.013	557608	SZ-DB 126 N	GHV0361425R0040		0.02	500/25
10	260	0.025	557707	SZ-DB 234 N	GHV0361425R0041		0.04	250/25
10	330	0.032	557806	SZ-DB 312	GHV0361425R0042		0.05	100/25

with ultrasonic compacted cable ends (blue)

Conn. capacity	Lenght		Bbn 4016779 EAN	Order details		Price 1 piece	Weight 1 piece kg	Pack unit pc.
				Type code	Order code			
10	135	0.013	663526	SZ-DB 10/135 N	2CDL200301R0135		0.02	25
10	260	0.025	663533	SZ-DB 10/260 N	2CDL200301R0260		0.04	25
10	330	0.032	663540	SZ-DB 10/330 N	2CDL200301R0330		0.05	25

Accessories

for S 200, SN 201, F 200, DS 200 and other series



SZ-6/3

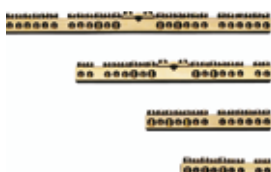

SZ-KLB 8, 12, 16, 24



SZ-Ktr



SZ-Ktr with KLB

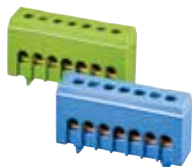

SZ-N6/3



SZ-N11/3

Neutral and protective-conductor terminals with insulation holder for quick fastening onto DIN rails EN 50 022

Input	Output	Bbn 4016779	Order details		Price 1	Weight 1 piece	Pack unit
mm ²	mm ²	EAN	Type code	Order code	piece	kg	pc.
1 x 16	6 x to 16	50592 5a	SZ-6/3	GHV0360876R0003		0.022	10
1 x 16	2 x to 16 6 x to 10	59660 7	SZ-KLB 8	GJI2320131R0001		0.025	30
1 x 16	2 x to 16 10 x to 10	59530 3	SZ-KLB 12	GJI2320071R0013		0.035	30
1 x 35	4 x to 16 12 x to 10	59540 2	SZ-KLB 16	GJI2320072R0017		0.077	30
1 x 35	4 x to 16 20 x to 10	59550 1	SZ-KLB 24	GJI2320073R0016		0.100	30

Holders for SZ-KLB terminals

Screw-fixing

SZ-KLB 8 and 12 each 1 piece required

SZ-KLB 16 and 24 each 2 pieces required

Conn. capacity	Lenght	Bbn 4012233	Order details		Price 1	Weight 1 piece	Pack unit
mm ²		EAN	Type code	Order code	piece	kg	pc.
		59450 4	SZ-Ktr	GJI2024027R0001		0.003	100

Neutral and protective-conductor terminals with insulation holder for quick fastening onto DIN rails EN 50 022

Neutral with blue insulation holder; type C finger safe, conductor opening closed on one side

Input	Output	Bbn 4012233	Order details		Price 1	Weight 1 piece	Pack unit
mm ²	mm ²	EAN	Type code	Order code	piece	kg	pc.
1 x 16	6 x 16	55570 3	SZ-N 6/3	GHV0360876R0001		0.027	20
1 x 16	11 x 16	55580 2	SZ-N 11/3	GHV0360876R0002		0.043	20
1 x 16	6 x 16	57095 4 ①	SZ-N 6/3 C	GHV0360876R0011		0.028	20
1 x 16	6 x 16	57096 1 ①	SZ-N 11/3 C	GHV0360876R0012		0.046	20

Protective conductor with green/yellow insulation holder; type C finger safe, conductor opening closed on one side

Conn. capacity	Lenght	Bbn 4012233	Order details		Price 1	Weight 1 piece	Pack unit
mm ²		EAN	Type code	Order code	piece	kg	pc.
1 x 16	6 x 16	55600 7	SZ-PE 6/3	GHV0360876R0004		0.027	20
1 x 16	11 x 16	55610 6	SZ-PE 11/3	GHV0360876R0005		0.043	20
1 x 16	6 x 16	57097 8 ①	SZ-PE 6/3 C	GHV0360876R0014		0.028	20
1 x 16	11 x 16	57098 5 ①	SZ-PE 11/3 C	GHV0360876R0015		0.046	20

① bbn-No. 4016779

Accessories

for S 200, SN 201, F 200, DS 200 and other series



SZ-BP 1



SZ-B



SZ-BP 2

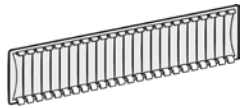

SZ-BP 12 G



SZ-BP R



SZ-VP 1500



END



SZ-FDT 2

Blanking plates

For device covers with materials of a thickness of 1 to 3mm, width: 1 module = 17.5 mm; color: grey RAL 7035, white RAL 9001

Input	Output	Bbn 4012233	Order details		Price 1	Weight 1 piece	Pack unit
mm ²	mm ²	EAN	Type code	Order code	piece	kg	pc.
46/grey	213	06050 4	SZ-BP 1	GHL5301904R0001		0.028	100
46/white	17.5	12857 4 a	SZ-BP	GHS2701913R0001		0.005	
46/grey	17.5	12861 1 a	SZ-BP 2	GHS2701913R0002		0.005	
46/grey	220	65227 8 a	SZ-BP 12 G	2CDL000001R1220		0.022	50
46/white	220	66355 7 b	SZ-BP 12 W	2CDL000001R2220		0.020	50

	Bbn 4016779	Order details		Price 1	Weight 1 piece	Pack unit
	EAN	Type code	Order code	piece	kg	pc.
Locking devices for SZ-BP 12 G	652285 a	SZ-BP R	2CDL000001R1001		0.001	30

Sealing plate

Seal-proof locking of stamped-out device covers.

Detachable only from the inside of the device cover.

Can be used for device covers with 1.5 to 3mm material thickness.

Height of cutout/color	Width	Bbn 4012233	Order details		Price 1	Weight 1 piece	Pack unit
mm	mm	EAN	Type code	Order code	piece	kg	pc.
46/grey	1500	60290 2	SZ-VP 1500	GJI9959038R0001		0.366	10

End bracket

Prevents lateral shifting of built-in devices mounted on DIN rails according to DIN EN 60 715, 35 x 7.5 mm.

	Bbn 4012233	Order details		Price 1	Weight 1 piece	Pack unit
	EAN	Type code	Order code	piece	kg	pc.
	59090 2	END	GJI1001814R0001		0.02	50

Filling piece

e.g. for heat dissipation of closely mounted devices that generate much heat. Width 8.75 mm, as spacer, two different heights, breakable, for DIN rails according to DIN EN 60 715, 35 x 7.5 mm.

	Bbn 4012233	Order details		Price 1	Weight 1 piece	Pack unit
	EAN	Type code	Order code	piece	kg	pc.
8.75	06070 2	SZ-FST 2	GHL5301908R0002		0.01	25

Spring piece

Holder for device covers, various heights available (in connection with FST 2 filling piece)

	Bbn 4012233	Order details		Price 1	Weight 1 piece	Pack unit
	EAN	Type code	Order code	piece	kg	pc.
	06080 1	SZ-FDT 2	GHL5301908R0005		0.002	25

Accessories

for S 200, SN 201, F 200, DS 200 and other series



SZ-FST 2 + SZ-FDT 2

Filling piece

Two different heights, breakable, for DIN rails according to DIN EN 60 715, 35 x 7.5 mm for MCBs S 220 (3 different heights)

	Bbn 4012233	Order details		Price 1 piece	Weight 1 piece	Pack unit
	EAN	Type code	Order code		kg	pc.
8.75	59410 8	SZ-FST	GJI1480003R0001		0.01	25

① bbn-Nr. 4016779

Spring catch for mounting devices onto DIN rails (DIN EN 60715, 35 x 7.5)



SZ-FST

	Bbn 4012233	Order details		Price 1 piece	Weight 1 piece	Pack unit
	EAN	Type code	Order code		kg	pc.
for screw type M4	64560 2	SZ-FB 45.53-3	GJI1842013P0003		0.03	50
for screw type M5	64580 0	SZ-FB 45.53-1	GJI1842013P0004		0.03	50

False poles

	Bbn 8012542	Order details		Price 1 piece	Weight 1 piece	Pack unit
	EAN	Type code	Order code		kg	pc.
False pole - 1 module	061304	FP1	16021765		0.01	100
False pole - 2 modules	061403	FP2	16021773		0.014	50
False pole - 4 modules	061502	FP4	16021781		0.022	30
False pole - 6 modules	061601	FP6	16021799		0.031	20
Support for false pole	061700	SFP	16021831		0.012	10



SZ-FB 45.53-1



SZ-FB 45.53-3



FP



Accessories

for S 200, SN 201, F 200, DS 200 and other series



SKV-GTS 1



SZ-SI 45.460



SZ-TS 7.5 L2



SZ-SI 45.472



SZ-TS 15 L2

DIN rails

DIN rails (DIN EN 60 715 – 35 x 7.5) for individual installation with 2 screws on an even surface (1 module = 17.5mm)

	Bbn 4012233	Order details		Price 1 piece	Weight 1 piece	Pack unit
	EAN	Type code	Order code		kg	pc.
for 1 module	13580 6	DSW 1	GHS2101926R0001		0.060	10
for 2 modules	13590 5	DSW 2	GHS2101926R0002		0.012	10
for 3 modules	13600 1	DSW 3	GHS2101926R0003		0.018	10
for 4 modules	13610 0	DSW 4	GHS2101926R0004		0.024	10
for 6 modules	13620 9	DSW 6	GHS2101926R0006		0.036	10

DIN rail DIN EN 60 715, 35 x 7.5, material thickness 1mm, surface protected, galvanised.

	Bbn 4012233	Order details		Price 1 piece	Weight 1 piece	Pack unit
	EAN	Type code	Order code		kg	pc.
241	04090 2	SKV-GTS 1	GHL1101915R0001		0.09	40

DIN rails DIN EN 60715, 35 x 7.5, material thickness 1mm, surface galvanised.

	Bbn 4012233	Order details		Price 1 piece	Weight 1 piece	Pack unit
	EAN	Type code	Order code		kg	pc.
1000	59730 7	SZ-SI 45.460	GJI2322218R0001		0.35	10
2000	59760 4	SZ-TS 7.5 L2	GJI2322218R0007		0.70	20

DIN rails DIN EN 60715, 35 x 15, material thickness 1.5 mm, surface galvanised

	Bbn 4012233	Order details		Price 1 piece	Weight 1 piece	Pack unit
	EAN	Type code	Order code		kg	pc.
2000	59780 2	SZ-SI 45.472	GJI2322218R0010		1.30	10
2000	59770 3	SZ-TS 15 L2	GJI2322218R0009		0.78	10

Accessories

for S 200, SN 201, F 200, DS 200 and other series



S2C-DH

Rotary operating mechanism (usable just with S200 devices)

For the actuation of 2-, 3- or 4pole miniature circuit-breakers in closed distribution boards for driveaxles of 5 or 6 mm²

Bbn	Order details		Price	Weight	Pack
4016779			1	1	unit
EAN	Type code	Order code		kg	pc.
57960 5	S2C-DH	GHS2001901R0003		0.175	1

Note: S2C-DH cannot be used on DS200

Handles

Handle IP 65, 65 x 65 mm, padlockable with max. 3 padlocks (bail diameter 5 - 8 mm), door interlock in ON-position, adjustable*



OH

Color	Suitable for switches	Bbn	Order details		Price	Weight	Pack
		6417019			1	1	unit
		EAN	Type code	Order code		kg	pc.
Black	OT16...40F	40978 8	OHBS2AJ	1SCA105213R1001			1
Yellow-red	OT16...40F	41226 9	OHYS2AJ	1SCA105296R1001			1
Silver	OT16...40F	41199 6	OHSS2AJ	1SCA105278R1001			1
Grey	OT16...40F	41186 6	OHGS2AJ	1SCA105265R1001			1

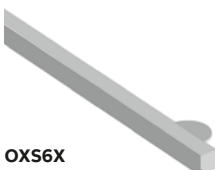

OX56X

Handle IP 65, 65 x 65 mm, padlockable with max. 3 padlocks (bail diameter 5 - 8 mm), door interlock in ON-position

Color	Suitable for switches	Bbn	Order details		Price	Weight	Pack
		6417019			1	1	unit
		EAN	Type code	Order code		kg	pc.
Black	OT16...40F	41140 8	OHBS2AJ1	1SCA105215R1001			1
Yellow-red	OT16...40F	41227 6	OHYS2AJ1	1SCA105297R1001			1
Silver	OT16...40F	41210 8	OHSS2AJ1	1SCA105279R1001			1
Grey	OT16...40F	41187 3	OHGS2AJ1	1SCA105266R1001			1

* OH_2_J enables selection of MCB behavior when opening panel door (remain switched on or switch off).
OH_2_J1 will cause MCB to switch off when opening panel door.

Axle extension

Type and order numbers are for one piece. For selector type handles. Shaft diameter 6 mm.

Lenght	Suitable for switches	Bbn	Order details		Price	Weight	Pack
		6417019			1	1	unit
		EAN	Type code	Order code		kg	pc.
85	OT16...40F	36571 8	OX56X85	1SCA101647R1001		0.02	10
105	OT16...40F	42411 8	OX56X105	1SCA108043R1001		0.02	10
120	OT16...40F	36578 7	OX56X120	1SCA101654R1001		0.03	10
130	OT16...40F	36577 0	OX56X130	1SCA101655R1001		0.03	10
160	OT16...40F	36580 0	OX56X160	1SCA101656R1001		0.04	10
180	OT16...40F	36583 1	OX56X180	1SCA101659R1001		0.04	10
250	OT16...40F	36584 8	OX56X250	1SCA101660R1001		0.05	10
330	OT16...40F	36585 5	OX56X330	1SCA101661R1001		0.05	10

Accessories

for S 200, SN 201, F 200, DS 200 and other series



SZ-ES 68/83

Elevation piece

Compensates for different size of built-in devices with a mounting height of 68 mm and power MCBs of series S500 (83 mm)

	Bbn 4012233	Order details		Price 1 piece	Weight 1 piece	Pack unit
	EAN	Type code	Order code		kg	pc.
	53390 9	SZ-ES 68/83	GHV0211425R0001		0.003	100



SA 1

Locking devices for MCBs, RCDs and switches

The locking devices prevent unauthorized or dangerous operation of circuit breakers' switching lever. An adaptor (SA 1) makes it possible to block the circuit breaker lever with a padlock having cross bar section or either 3 or 6 mm max. For multipole configuration it is sufficient to apply a single lock.

To purchase multiple padlocks that all have the same key use SA 2 i.

To purchase padlocks that each have a different key use SA 2.

The lock adaptor can be used for all MCBs of the S 200, S 280 series, SN201 and DSN201 series, RCCBs F200, RCBOs DS201-DS202C as well as for switches E 200.



SA 3



SA 2

	Bbn 4012233	Order details		Price 1 piece	Weight 1 piece	Pack unit
	EAN	Type code	Order code		kg	pc.
locking devices adaptor for padlock bar	3mm	58760 5	SA 1	GJF1101903R0001	0.004	10
	6mm	58790 2	SA 1E	GJF1101903R0004	0.004	10
padlock with 2 keys		58770 4	SA 2	GJF1101903R0002	0.02	10
padlock, with 2 identical keys		96940 1	SA 2 i	GJF1109999R0001	0.02	10
transparent box incl. adaptor and padlock with 3 keys		58780 3	SA 3	GJF1101903R0003	0.05	10



KA 27 H + KA 27 S

Terminal cover KA 27

Provides overall touch protection of live parts. Suitable for installations acc. to DIN EN 50274 (DIN VDE 0660 Part 514) and BGV A2.

End parts can be snapped onto mounting rails EN 60 715, 35 mm. Covers are 486 mm = 27 modules (18 mm each) long. Knockouts for each half module for individualised use.

	Bbn 4012233	Order details		Price 1 piece	Weight 1 piece	Pack unit
	EAN	Type code	Order code		kg	pc.
cover, 1 piece	13630 8	KA 27 H	GHS2101933R0001		0.104	10
end part, 1 piece	13640 7	KA 27 S	GHS2101934R0001		0.027	10



PCD 2 N



PCD 4 N

Terminal covers with base plate, protection IP 40

Material: high-impact and flame-retardant (UL 94 V-0),

color: white (RAL 9016), glow-wire test 960 °C according to IEC 695-2-1

The base plate has an integrated top-hat rail for snap-on fixing of MCBs, RCDs, modular built-in devices, etc.

	Bbn 8000126	Order details		Price 1 piece	Weight 1 piece	Pack unit
	EAN	Type code	Order code		kg	pc.
for 2 modules	118698	PCD 2 N	GHS2701921R0002		0.09	1
for 4 modules	118728	PCD 4 N	GHS2701921R0004		0.15	1
for 6 modules	118773	PCD 6 N	GHS2701921R0006		0.2	1

Accessories

for S 200, SN 201, F 200, DS 200 and other series



ME

Flanges

	Bbn	Order details		Price 1 piece	Weight 1 piece kg	Pack unit pc.
	8012542	EAN	Type code			
Flange for rear board fixing 1 module - IP40	304401	ME 1	16219300		0.040	1
Flange for rear board fixing 2 modules - IP40	304500	ME 2	16219318		0.045	1
Flange for rear board fixing 3 modules - IP40	304609	ME 3	16219326		0.055	1
Flange for rear board fixing 4 modules - IP40	304708	ME 4	16219334		0.060	1
Flange for rear board fixing 6 modules - IP40	304807	ME 6	16219342		0.070	1
Flange for rear board fixing 8 modules - IP40	304906	ME 8	16219359		0.080	1

Auxiliary elements for S750 DR series

Auxiliary contact for S750 DR



S750DR-AUX

S750DR-AUX

Electrical data									
Standards	DIN EN 62019 (VDE 0640), IEC/EN 62019 DIN EN 60947-5-1 (VDE 0660-200), IEC/EN 60947-5-1								
Conventional free air thermal current I _{th}	6 A								
Utilisation categories	AC14		AC15		DC12		DC13		
U _e	400 V	230 V	400 V	230 V	250 V	125 V	60 V	24 V	
I _e (max)	2 A	6 A	2 A	6 A	0.5 A	1.5 A	2 A	4 A	
Rated insulation voltage U _{acc.} to IEC/EN 60664-1	690 V AC								
Overvoltage category	IV								
Pollution Degree	3								
Protection degree acc. to IEC/EN 60529	IP20								
Min. switching power DC	5V DC/5 mA, 12V DC/5 mA								
Rated impuls withstand voltage U _{imp} (1.2/50 μs)	6 kV								
Installation									
Cross-section of	1 conductor	0.75 - 2.5 mm ² solid, flexibel with and without insulated ferrule conductors							
	2 conductor	2 x 0.75 - 2 x 2.5 mm ² solid, flexibel with and without insulated ferrule							
Tightening torque	0.8 Nm								
Mechanical data									
Vibration resistance according to IEC/EN 60 068-2-6	5g, 20 cycles at 5 ...150...5 Hz with 24 V AC/DC, 5 mA, without switching operation								
Mechanical endurance	10,000 ops.								
Pole dimensions (H x D x W)	128 x 77 x 8.7								
Mounting									
Only 1 auxiliary contact mountable on the right site									
Not mountable to S751DR/3									



S750DR-AUX

Auxiliary contact S750DR-AUX

Two change-over contacts indicate the contact position of the S750 DR pole(s) independently and potential-free. A test button can be used to verify the correct indication of the contact position without switching the pole(s).

The change-over contacts fulfill the requirements of electrical separation of the main circuit connected to the pole(s).

The S750DR-AUX can be mounted on S750 DR 1-4 pole-devices without tools.

	Bbn 4016779	Order details		Price 1 piece	Weight 1 piece	Pack unit
	EAN	Type code	Order code		kg	pc.
Auxiliary contact	941891	S750DR-AUX	2CDH700901R0001		0.07	1

Auxiliary elements for MCBs S800 series

Selection table

Combination between auxiliary elements and S800

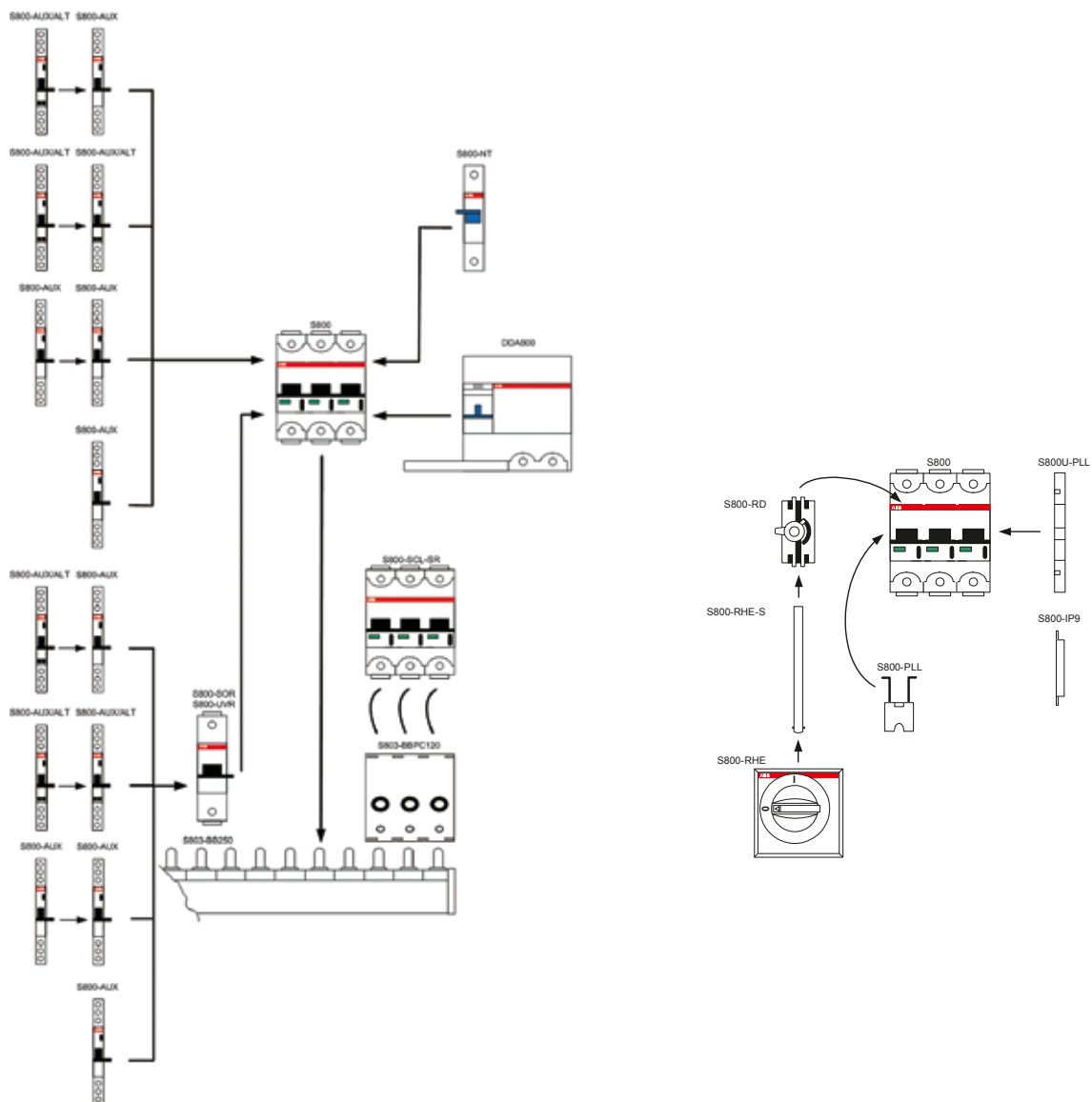

S800-AUX	Auxiliary contact for external display
S800-AUX/ALT	Combined auxiliary and signal contact for the external display
S800-NT	Disconnectable neutral conductor 63A
S800-SOR	Shunt opening release
DDA800	RCD block
S803-BB	Busbar system
S800RD	Rotary drive
S800-RHE	Rotary handle
S800-IP	Intermediate piece
S800-PLL/S800U-PLL	Padlock device/Locking device for American market
S800-UVR	Undervoltage release
S800-SCL-SR	Short-circuit current limiter self resetting

Auxiliary elements for S800

S800-AUX



S800-AUX

S800-AUX

Auxiliary contact for external display

The S800-AUX auxiliary contact is for electrical display of the operating state of the high performance MCB. Both changeover contacts always switch simultaneously with the live conductor contact and detect the following operating states:

- Manual tripping
- Tripping due to thermal overload
- Tripping due to magnetic overload (short-circuit)

Mode of function of the test button

The test button is operated by a tool and allows the user to simulate the mode of function of the auxiliary contact when switched on without tripping the high performance MCB itself.

Mode of function of the two changeover contacts

- Off position of the high performance MCB contacts 11–12 and 21–22 closed
- On position of the high performance MCB contacts 11–14 and 21–24 closed

Mounting ability of the auxiliary contact

- Two S800-AUX auxiliary contacts can be mounted by the user at the left on the high performance MCB.

Auxiliary contact S800-AUX

Utilisation categories compliant to IEC 60947-5-1		AC15 400/2A, AC15 240/6A, DC13 250/0.55A, DC13 125V/1.1A, DC13 60V/2A, DC13 24V/4A
Rated values compliant to UL 489		125VAC/6A, 250VAC/5A, 24VDC/4A, 125VDC/0.3A, 250VDC/0.15A
Conventional free air thermal current I_{th}	A	6
Minimum operational current I_{min}	mA	3
Minimum operational voltage U_{min}	V	24
Rated insulation voltage U_i	V	690
Number of contacts		2
Rated impulse withstand voltage U_{imp}	kV	6
Pollution degree		3
Standard		IEC 60947-5-1 / UL 489
Contact function		Changeover contact
Connection C_u	mm ²	1 x 2.5 2 x 1.5 14 AWG
Tightening torque	Nm	1
AC/DC feed		any
Mounting on DIN top hat rail		EN 60715
Protection category		IP20
Permissible operating ambient temperature	°C	-25 ... +60
Storage temperature	°C	- 40 ... +70
Mech. lifetime of device		6000 switching cycles
I_{cu}	A	1000
Vibration resistance		IEC 60068-2-6; EN 61373 Cat.1/Class B 5g, 20 frequency cycle 5 ... 150 ... 5 Hz at 24V AC/DC, 5mA short-term interruption <10ms

Article	GTIN	Order details		Price	Weight	Pack
	761227	Type code	Order code	1	1 piece	unit
	EAN			piece	kg	pc.
Auxiliary contact	1206802	S800-AUX	2CCS800900R0011		0.05	1

Auxiliary elements for S800

S800-AUX/ALT



S800-AUX/ALT

Technical data

Combined auxiliary and signal contact S800-AUX/ALT

Utilisation categories compliant to IEC 60947-5-1		AC15 400/2A, AC15 240/6A DC13 250/0.55A DC13 125V/1.1A DC13 60V/2A DC13 24V/4A
Rated values compliant to UL 489		125VAC/6A 250VAC/5A 24VDC/4A 125VDC/0.3A 250VDC/0.15A
Conventional free air thermal current I_{th}	A	6
Minimum operational I_{min}	mA	3
Minimum operational voltage U_{min}	V	24
Rated insulation voltage U_i	A	690
Number of contacts		2 (1x AUX, 1x AUX/ALT)
Rated impulse withstand voltage U_{imp}	kV	6
Pollution degree		3
Standard		IEC 60947-5-1 / UL 489
Contact function		Changeover contact
Connection C_u	mm ²	1 x 2.5 2 x 1.5 14 AWG
Tightening torque	Nm	1
AC/DC feed.		any
Mounting on DIN top hat rail		EN 60715
Protection category		IP20
Permissible operating ambient temperature	°C	-25 ... +60
Storage temperature	°C	-40 ... +70
Mech. lifetime of device		6000 switching cycles
I_{cu} with S450E	A	1000
Vibration resistance		IEC 60068-2-6; EN 61373 Cat.1/Class B 5g, 20 frequency cycle 5 ... 150 ... 5 Hz at 24V AC/DC, 5 mA short-term interruption <10ms

Article	GTIN	Order details		Price	Weight	Pack	
	761227	Type code	Order code	1	1 piece	unit	
Auxiliary/signal contact	EAN	1206819	S800-AUX/ALT	2CCS800900R0021	piece	kg	pc.
					0.05	1	

Auxiliary elements for S800

S800-NT



S800-NT

S800-NT

Disconnectable neutral conductor 63 A

The S800 high performance MCB is force-opened before actuating the disconnectable neutral conductor S800-NT.

Mounting ability of the S800-NT neutral conductor

The neutral conductor can be mounted by the user at the right on the high performance MCB.

	GTIN 761227	Order details		Price 1	Weight 1 piece	Pack unit
Article	EAN	Type code	Order code	piece	kg	pc.
Disconnectable neutral conductor 63 A	1208196	S800-NT	2CCS800900R0061		0.12	1

Auxiliary elements for S800

S800-RSU system



S800-RSU-H

S800-RSU-H IEC version

S800W-RSU World version

Remote Switching Units for High Performance MCB

The S800-RSU makes the use of S800 even more convenient. Driven by a brushless high precision DC motor, S800-RSU ensures fast remote-controlled operation.

Mounting ability

The S800-RSU is mountable on any multipole S800 High Performance MCB. Wiring and operation is feasible on field. The connection has to be done by a 10-pole Micro Fit 3.0 (not included in delivery). S800-RSU operated with standard MDRC pushbuttons and indicator lights or can be done via programmable logic controllers (PLCs).

Switching times

OFF → ON <<500 ms
from signal to contact closing

ON → OFF <<250 ms
from signal to contact opening

TRIP → OFF → ON <<1500 ms
from signal to contact closing

For differing requirements, please contact your local ABB partner

Safety Intelligence

- When detecting manual use, inputs are deactivated for 10 seconds
- If the spindle is rotated more than 360°, all outputs become active
- Manual switch off via lever is possible (S803, S804)
- Manual switch on via lever is not possible (S802)
- RSU is locked for five minutes after three switching attempts leading to a trip
- Mechanical fixation via lock slider blocking the spindle

S800-RSU-CP

S800-RSU cable incl. 10-pole Micro Fit 3.0 plug

Length of cable: 3m
Cross section: 10 x 0.5 mm²

Temperature range

moving state: -5 °C ... +70 °C
fixed state: -30 °C ... +80 °C
Rated voltage: 300 V
Conductor resistance: 39.0 Ω/km
Approvals: S+, UL



S800-RSU-H-CP

Auxiliary elements for S800

S800-RSU system



S800-RSU-H

Technical data

S800-RSU-H IEC version S800W-RSU World version Remote Switching Units for High Performance MCB

Operating Voltage		24VDC
Current Consumption I_{rms}	A	2.5
Stand-by Current	mA	< 50
Switching Time OFF-ON	ms	< 500
Switching Time ON-OFF	ms	< 250
Ambient Operation Temperature	°C	-25 ... 70
Switching Cycles over Lifetime		10.000
Standard		S800-RSU-H IEC60947-2 Annex N S800W-RSU UL489
Protection		IP20
Weight	g	300
Connection		10 pole Micro Fit 3.0

Article	GTIN	Order details		Price	Weight	Pack
	761227	Type code	Order code	1	1 piece	unit
	EAN			piece	kg	pc.
Remote Switching Unit* S800-RSU-H	1411244	S800-RSU-H	2CCS800900R0501		0.30	1
Remote Switching Unit* S800W-RSU	1411169	S800W-RSU	2CCS800900R0511		0.30	1
S800-RSU cable incl. plug 3 meters cable 0,5 mm ² (AWG20) incl. 10-pole Micro Fit 3.0 plug	1412869	S800-RSU-CP	2CCS800900R0541		0.35	1
10-pole Micro Fit 3.0 plug	1412845	S800-RSU-P	2CCS800900R0551		0.00	1

* High performance circuit breaker is not included in delivery

Auxiliary elements for S800

S800-SOR



S800-SOR

S800-SOR

Shunt opening release

The S800-SOR shunt opening release is for remote release of the S800- high performance MCB using an electrical impulse. Operation of the trigger is guaranteed at a voltage between 70% and 110% of the rated mains voltage U_n both for AC and DC.

Mounting ability of the S800-SOR operating current release

The S800-SOR can be mounted by the user at the left side of the high performance MCB.

Shunt release S800-SOR

		S800-SOR12	S800-SOR24	S800-SOR130	S800-SOR250	S800-SOR400
Rated operational voltage U_e	VAC/DC	12	24	48 ... 130	110 ... 250	220 ... 400
Operating range	% U_e	70 ... 110	70 ... 110	70 ... 110	70 ... 110	70 ... 110
Rated insulation voltage U_i	V	690	690	690	690	690
Coil pull in consumption	W/VA	15.5	16.6/17*	41.9 ... 307.3 42 ... 310*	23 ... 119 20 ... 105*	45 ... 148.1
Rated frequency	Hz	DC; 50/60	DC; 50/60	DC; 50/60	DC; 50/60	DC; 50/60
Pollution degree		3	3	3	3	3
Standard		IEC 60947-2/ UL 489	IEC 60947-2/ UL 489	IEC 60947-2/ UL 489	IEC 60947-2/ UL 489	IEC 60947-2/ UL 489
Connection C_u	mm ²	1 ... 25 (14-2 AWG) strand 1 ... 35 (14-3 AWG) cable	1 ... 25 (14-2 AWG) strand 1 ... 35 (14-3 AWG) cable	1 ... 25 (14-2 AWG) strand 1 ... 35 (14-3 AWG) cable	1 ... 25 (14-2 AWG) strand 1 ... 35 (14-3 AWG) cable	1 ... 25 (14-2 AWG) strand 1 ... 35 (14-3 AWG) cable
Tightening torque	Nm	3.5	3.5	3.5	3.5	3.5
AC/DC supply		any	any	any	any	any
Mounting on DIN top hat rail		EN 60715	EN 60715	EN 60715	EN 60715	EN 60715
Protection category		IP20 IP40	IP20 IP40	IP20 IP40	IP20 IP40	IP20 IP40
		(actuating end only)	(actuating end only)	(actuating end only)	(actuating end only)	(actuating end only)
Permissible operating ambient temperature	°C	-25 ... +60	-25 ... +60	-25 ... +60	-25 ... +60	-25 ... +60
Storage temperature	°C	-40 ... +70	-40 ... +70	-40 ... +70	-40 ... +70	-40 ... +70
Vibration resistance		IEC 60068-2-6; EN 61373 Cat.1/ Class B	IEC 60068-2-6; EN 61373 Cat.1/ Class B	IEC 60068-2-6; EN 61373 Cat.1/ Class B	IEC 60068-2-6; EN 61373 Cat.1/ Class B	IEC 60068-2-6; EN 61373 Cat.1/ Class B

Shunt operation release	GTIN	Order details		Price 1 piece	Weight 1 piece kg	Pack unit pc.
	761227	EAN	Type code			
12VAC/DC	1212070	S800-SOR12	2CCS800900R0201	0,15	1	
24VAC/DC	1208318	S800-SOR24	2CCS800900R0191	0,15	1	
48...130VAC/DC	1208349	S800-SOR130	2CCS800900R0221	0,15	1	
110...250VAC/DC	1208332	S800-SOR250	2CCS800900R0211	0,15	1	
220...400VAC/DC	1208356	S800-SOR400	2CCS800900R0231	0,15	1	

Auxiliary elements for S800

S800-UVR



S800-UVR

S800-UVR

Undervoltage release

The S800-UVR undervoltage release can be used as an emergency-stop cut-as by use of suitable emergency stop buttons. The undervoltage release switches the power supply to the high performance MCB off in case of a failure or if the value falls below $0.7 \times U_n$. After tripping, the high performance MCB can be switched back on as soon as the voltage is over $0.85 \times U_n$.

Mounting ability of the S800-UVR undervoltage release

The S800-UVR can be mounted by the user at the left side of the high performance MCB.

Undervoltage release S800-UVR

		S800-UVR36	S800-UVR60	S800-UVR130	S800-UVR250
Rated operational voltage U_e	VAC/DC	24 ... 36	48 ... 60	110 ... 130	220 ... 250
Operating range					
open	% U_e	35 ... 70	35 ... 70	35 ... 70	35 ... 70
closed	% U_e	85	85	85	85
Rated insulation voltage U_i	V	690	690	690	690
Power loss of coil when attracted	W/VA	1.11 ... 1.14/1.2*	1.14 ... 1.25/1.3*	1.3 ... 1.41/1.4*	1.71 ... 1.91/1.9*
Rated frequency	Hz	DC; 50/60	DC; 50/60	DC; 50/60	DC; 50/60
Pollution degree		3	3	3	3
Standard		IEC 60947-2 / UL 489	IEC 60947-2 / UL 489	IEC 60947-2 / UL 489	IEC 60947-2 / UL 489
Connection C_u	mm ²	1 ... 25 (14-2 AWG) strand 1 ... 35 (14-3 AWG) cable	1 ... 25 (14-2 AWG) strand 1 ... 35 (14-3 AWG) cable	1 ... 25 (14-2 AWG) strand 1 ... 35 (14-3 AWG) cable	1 ... 25 (14-2 AWG) strand 1 ... 35 (14-3 AWG) cable
Tightening torque	Nm	3.5	3.5	3.5	3.5
AC/DC supply		any	any	any	any
Mounting on DIN top hat rail		EN 60715	EN 60715	EN 60715	EN 60715
Protection category		IP20 IP40 (actuating end only)	IP20 IP40 (actuating end only)	IP20 IP40 (actuating end only)	IP20 IP40 (actuating end only)
Permissible operating ambient temperature	°C	-25 ... +60	-25 ... +60	-25 ... +60	-25 ... +60
Storage temperature	°C	-40 ... +70	-40 ... +70	-40 ... +70	-40 ... +70
Vibration resistance		IEC 60068-2-6; EN 61373 Cat.1/Class B	IEC 60068-2-6; EN 61373 Cat.1/Class B	IEC 60068-2-6; EN 61373 Cat.1/Class B	IEC 60068-2-6; EN 61373 Cat.1/Class B

Undervoltage release	GTIN	Order details		Price 1 piece	Weight 1 piece	Pack unit
	761227	Type code	Order code			
24...36 VAC/DC	1208363	S800-UVR36	2CCS800900R0241		0,15	1
48...60 VAC/DC	1208370	S800-UVR60	2CCS800900R0251		0,15	1
110...130 VAC/DC	1208387	S800-UVR130	2CCS800900R0261		0,15	1
220...250 VAC/DC	1208394	S800-UVR250	2CCS800900R0271		0,15	1

Auxiliary elements for S800

S800-SCL-SR



S800S-SCL-SR

S800-SCL-SR

Self-resetting short-circuit limiter

The S800-SCL-SR can be used together with S800S, S800N, S800C High Performance MCBs or Manual Motor Starters. It limits the short-circuit current until the downstream means of protection trips. Its current continuity makes it as the ideal solution for group protection. All parallel branches remain operative.

S800-SCL-SR is available at rated voltages 400/690 Vac and 580/100 Vac acc.to the type.

Self-resetting short-circuit current limiter		S800S-SCL-SR	S803W-SCL-SR
Rated operational current I_e	A	32, 63, 100	
Pole		1, 2, 3	3
Rated operational voltage U_e (AC) according to IEC 60947-2 50/60Hz	V	400/690	690
(AC) according to UL 508 50/60Hz	V		600
Rated insulation voltage U_i	V	690	690
Rated impulse withstand voltage U_{imp}	kV	8	8
Rated ultimate short-circuit breaking capacity $I_{cu} = I_{cs}$ according to IEC 60947-2*			
(AC) 50/60 Hz 240/415 V	kA	100	100
(AC) 50/60 Hz 254/440 V	kA	100	100
(AC) 50/60 Hz 289/500 V	kA	65	65
(AC) 50/60 Hz 400/690 V	kA	50	50
Short-circuit rating according to UL 508*			
(AC) 50/60 Hz 480 V	kA	65	65
(AC) 50/60 Hz 600 V	kA	65	65
Rated frequency	Hz	50/60	50/60
Mounting position		any	any
Connections C_u	mm ²	1 ... 50 rigid (solid/ stranded)	1 ... 50 rigid (solid/ stranded)
	mm ²	1 ... 70 flexible	1 ... 70 flexible
	AWG		14-1
Tightening torque	Nm	3.5	3.5
	in. lbs.		31
Feeding		optional	optional
Mouting on DIN top hat rail		EN 60715	EN 60715
Ambient air temperature	°C	-40 ... +70	-40 ... +70
	°C	-40 ... +85	-40 ... +85
Degree of protection		IP20	IP20
Classification acc. to NF F 16-101, NF F 16-102		I3, F2	I3, F2
Damp Heat		IEC 60068-2-30, 55 °C / 95% r.h.	IEC 60068-2-30, 55 °C / 95% r.h.
Vibration		IEC 60068-2-6, 5-10 Hz / 3 mm and 10-500 Hz / 2 g at 0.5 x I_e	IEC 60068-2-6, 5-10 Hz / 3 mm and 10-500 Hz / 2 g at 0.5 x I_e
Random Vibration		IEC 60068-2-64, 5-500 Hz / 2 g at 0.5 x I_e	IEC 60068-2-64, 5-500 Hz / 2 g at 0.5 x I_e
Resistance to climatic conditions		IEC 60068-2-1 /-2-2 /-2-30	IEC 60068-2-1 /-2-2 /-2-30
Standard		IEC 60947-2 IEC 60947-4-1	IEC 60947-2 IEC 60947-4-1 UL 508, CSA 22.2 No. 14

* Valid only for approved combinations

Please refer to section B of the catalogue

Auxiliary elements for S800

S800-SCL-SR



S800S-SCL-SR

S803HV-SCL-SR in combination with S803HV-K		
General data		
Standard		IEC 60947-2
Poles		3
Rated frequency f	Hz	50/60
Data acc. to IEC 60947-2		
Rated operational voltage U_e	V	AC 580/1000
Rated operational current I_n	A	32, 63, 100
Rated ultimate short-circuit breaking capacity I_{cu}	kA	15
Rated service short-circuit capacity I_{cs}	kA	10
Rated insulation voltage U_i	V	AC 1000
Rated impulse withstand voltage U_{imp}	kV	8
Mechanical data		
Housing		Material group I, RAL 7035
Toggle		black, lockable
Protection degree acc. to IEC / EN 60529		IP20; IP40 (actuating side only)
Classification acc. to NF F16-101, NF F 16-102		I3, F2
Classification acc. to IEC 61373 (shock and vibration)		Cat. 1, Class B
Shock resistance acc. to IEC / EN 60068-2-27		Test Ea: 5g / 30ms
Vibration resistance acc. to IEC / EN 60068-2-6		Test Fc: 2-13.2 Hz / 1 mm 13.2-100 Hz / 0.7 g with load 100% x I_e
Environmental conditions (damp heat) acc. to IEC / EN 60068-2-30		12+12 cycle with 55 °C / 90 - 96% RH and 25 °C / 95 - 100% RH
Environmental conditions (dry heat) acc. to IEC / EN 60068-2-2		16 hours 55 °C / 2 hours 70 °C / 55% RH
Ambient temperature	°C	-25 ... +60
Storage temperature	°C	-40 ... +70
Installation		
Terminal		Failsafe cage terminal
Connection (top/bottom) – C_u only	mm ²	1 ... 50 solid / stranded 1 ... 70 flexible
Tightening torque	Nm	3.5
Screwdriver		POZI 2
Mounting		EN 60715
Mounting position		any
Supply side		any
Dimension and weight		
Pole dimension (H x L x W)	mm	142 x 76.5 x 26.5
Pole weight	kg	0.25

Auxiliary elements for S800

S800-SCL-SR



S803S-SCL100-SR

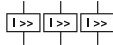

Self-resetting short-circuit limiter IEC version [A]	GTIN	Order details		Price	Weight	Pack
	7612271	EAN	Type code	Order code	1 piece	1 piece unit
32	412012	S801S-SCL32-SR	2CCS801901R0539	0.25	1	
63	412036	S801S-SCL63-SR	2CCS801901R0599	0.25	1	
100	411992	S801S-SCL100-SR	2CCS801901R0639	0.25	1	
32	412074	S802S-SCL32-SR	2CCS802901R0539	0.5	1	
63	412098	S802S-SCL63-SR	2CCS802901R0599	0.5	1	
100	412050	S802S-SCL100-SR	2CCS802901R0639	0.5	1	
32	411930	S803S-SCL32-SR	2CCS803901R0539	0.75	1	
63	411947	S803S-SCL63-SR	2CCS803901R0599	0.75	1	
100	411954	S803S-SCL100-SR	2CCS803901R0639	0.75	1	



S803W-SCL100-SR

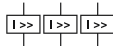

Self-resetting short-circuit limiter World version (IEC/UL) [A]	GTIN	Order details		Price	Weight	Pack
	7612271	EAN	Type code	Order code	1 piece	1 piece unit
32	412319	S803W-SCL32-SR	2CCS803917R0539	0.75	1	
63	412326	S803W-SCL63-SR	2CCS803917R0599	0.75	1	
100	412302	S803W-SCL100-SR	2CCS803917R0639	0.75	1	



S803HV-SCL100-SR

Self-resetting short-circuit limiter [A]	GTIN	Order details		Price	Weight	Pack
	7612271	EAN	Type code	Order code	1 piece	1 piece unit
32	37008	S803HV-SCL32-SR	2CCF019047R0001	0.75	1	
63	37107	S803HV-SCL63-SR	2CCF019048R0001	0.75	1	
100	37114	S803HV-SCL100-SR	2CCF019049R0001	0.75	1	

Auxiliary elements for S800

S800-RD



S800-RD

S800-RD

Rotary drive

The rotary drive for 2–4 pole devices can be delivered for assembly on the switching field door. Switching is effortless due to the ergonomic design of the swivel lever. It is equipped with a lock for the OFF position that prevents switching on of the S800 high performance MCB.

The slot hole of the lock can accept up to 3 padlocks with lug diameters of 7 mm (not included in delivery). Operation of the trigger and a view of the characteristics are not prevented. Additionally, a rotary drive can also be supplied to switch machines; it has a red grip on a yellow background.

The rotary drive on the switching field door is comprised of the following three components:

- Rotary handle S800-RHE-H, -EM
- Axle (500 mm) S800-RHE-S



S800-RD

Rotary drive adapter for 2- to 4-pole high performance MCB	GTIN	Order details		Price	Weight	Pack
	76122712	Type code	Order code	1	1 piece	unit
	EAN			piece	kg	pc.
Rotary drive	08172	S800-RD	2CCS800900R0041		0.08	1



S800-RHE-H

Anthracite/Standard rotary handle for door assembly	GTIN	Order details		Price	Weight	Pack
	80156446	Type code	Order code	1	1 piece	unit
	EAN			piece	kg	pc.
Anthracite rotary handle	25571	S800-RHE-H	1SDA060150R0001		0.02	1



S800-RHE-EM

Red/Emergency rotary handle for door assembly	GTIN	Order details		Price	Weight	Pack
	80156446	Type code	Order code	1	1 piece	unit
	EAN			piece	kg	pc.
Red rotary handle	25771	S800-RHE-EM	1SDA060151R0001		0.02	1



S800-RHE-S

Axle extension Rotary drive-rotary handle 6x6mm	GTIN	Order details		Price	Weight	Pack
	80156446	Type code	Order code	1	1 piece	unit
	EAN			piece	kg	pc.
Axial extension 500mm	26242	S800-RHE-S	1SDA060179R0001		0.2	1

IP54 kit for door mounting	GTIN	Order details		Price	Weight	Pack
	80156446	Type code	Order code	1	1 piece	unit
	EAN			piece	kg	pc.
IP54 Kit	26259	S800-RHE-IP54	1SDA060180R0001		0.08	1

Auxiliary elements for S800

S800-IP9, S800-PLL, S800U-PLL



S800-IP9

S800-IP9

Intermediate piece

The S800-IP9 intermediate piece fits the profile of the high performance MCB and is used to fill in empty device slots. Thanks to its width of just 9mm, the slots of all devices of the S800 range can be expanded using this intermediate piece.

	GTIN 76122712	Order details		Price 1	Weight 1 piece	Pack unit
Intermediate piece 9 mm	EAN	Type code	Order code	piece	kg	pc.
Intermediate piece 9 mm	08202	S800-IP9	2CCS800900R0031		0.01	1



S800-PLL

S800-PLL

Padlock device

The S800-PLL padlock device safely prevents unintentional switching on and off. Simply insert the lug of the padlock device through the borehole on the high performance MCB and lock with a padlock with lug diameter Ø 4 mm (not included in delivery). Even when the high performance MCB is secured with a padlock device against unintentional switching off, tripping remains possible in case of overload or short-circuit by the S800-SOR, S800-UVR and DDA800.

	GTIN 76122712	Order details		Price 1	Weight 1 piece	Pack unit
Padlock lever lock with hasp	EAN	Type code	Order code	piece	kg	pc.
Padlock lever lock with hasp 4 mm	08189	S800-PLL	2CCS800900R0051		0.12	10



S800U-PLL

S800U-PLL

Locking device – for the American market

The S800U-PLL locking device prevents unintentional switch-on or off of the S800U high performance MCB, or switch on/off by third parties. It is mounted at the side of the high performance MCB and can only be removed using a special tool. A standardised American padlock (not included in delivery) is hung onto the round recess on the locking device, which can be secured by max six locks. Of course, tripping is possible by the S800-SOR or S800-UVR in case of overload or short-circuit.

	GTIN 76122712	Order details		Price 1	Weight 1 piece	Pack unit
UL locking device*	EAN	Type code	Order code	piece	kg	pc.
UL locking device	15057	S800U-PLL	2CCS800017R0001		0.02	1

*High performance circuit breaker and lockout tag are not included in delivery

Auxiliary elements for S800

S800-CT, -RT, S800-ILS



S800-CT



S800-RT

S800-CT, -RT

Interchangeable adapter kit

The S800 interchangeable adapter kit allows the cable clamp – ring terminal connections to be exchanged. Ring terminal connection -> Cage Terminal connection

The following is included in the S800-CT replaceable interchangeable adapter kit:

- Cage terminal
- Insulator

Cage Terminal connection -> ring terminal connection

The following is included in the S800-RT replaceable interchangeable adapter kit:

- Nut, insulation nut – cable lug, Allen screw
- Insulator with 25 mm insulation walls

Interchangeable adapter kit	GTIN	Order details		Price	Weight	Pack
	76122712	EAN	Type code	1	1 piece	unit
			Order code	piece	kg	pc.
Cage terminal	08264	S800-CT2125	2CCS800900R0181		0.03	2
Cage terminal	08233	S800-CT4125	2CCS800900R0151		0.06	4
Ring terminal connection	08240	S800-RT2125	2CCS800900R0161		0.03	2
Ring terminal connection	08219	S800-RT4125	2CCS800900R0131		0.06	4

S800-ILS

Identification labelling system

The individual identification labelling system for ILS legend plates is a DIN A5 polyester foil for inkjet and laser printers with high temperature resistance (if a laser printer is used please check whether self-sticking foils with a thickness of 250 µm can be printed with it). The 3M™9471 LE adhesive backing is UL-approved with Appl. No. MH 11410. The single plates are butt-cut on one side. Can be manually labelled with ink, pen, pencil and felt pen.

S800-ILS	GTIN	Order details		Price	Weight	Pack
	76122712	EAN	Type code	1	1 piece	unit
			Order code	piece	kg	pc.
Identification labeling system 168 x 6 x 11.5mm	08271	S800-ILS	2CCS800900R0121		0.01	1

Auxiliary elements for S800

S802-LINK

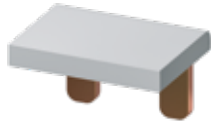

S802-LINK50



S802-LINK125

S802-LINK50

Pole connector up to 50 A

The pole connector S802-LINK50 can be used up to 50 A.

S802-LINK125

Pole connector up to 125 A

The pole connector S802-LINK125 can be used up to 125 A.

Pole connector S802-LINK125

Rated insulation voltage U_i	V	DC 1500
Tightening torque	Nm	3.5
	in. lbs.	31

Combination S800PV-SP with S802-LINK50 / -LINK125 (devices mounted separately)

I_o [A]	10°C	15°C	20°C	25°C	30°C	35°	40°C	45°C	50°C	55°C	60°C
10	11.6	11.4	11.2	11.0	10.7	10.4	10.0	9.6	9.3	9.0	8.7
13	15.1	14.9	14.6	14.3	13.9	13.5	13.0	12.5	12.1	11.7	11.3
16	18.6	18.2	17.9	16.6	17.1	16.6	16.0	15.4	14.9	14.4	13.9
20	23.2	22.8	22.4	22.0	21.4	20.8	20.0	19.2	18.6	18.0	17.4
25	29.0	28.5	28.0	27.5	26.8	26.0	25.0	24.0	23.3	22.5	21.8
32	37.1	36.5	35.8	35.2	34.2	33.3	32.0	30.7	29.8	28.8	27.8
40	46.5	45.6	44.8	44.0	42.8	41.6	40.0	38.4	37.2	36.0	34.8
50	58.1	57.0	56.0	55.0	53.5	52.0	50.0	48.0	46.5	44.6	42.9
63	69.9	68.8	67.6	66.5	65.3	64.2	63.0	60.5	58.1	55.7	53.5
80	88.8	87.3	86.0	84.4	82.9	81.5	80.0	76.8	73.7	70.8	67.9
100	111.0	109.2	107.3	105.6	103.7	101.8	100.0	96.0	92.2	88.5	84.9
125	138.8	136.5	134.2	131.9	129.6	127.3	125.0	116.3	108.1	100.5	93.5

These values are valid for the combination with S802-LINK50

Combination S800PV-SD with S802-LINK50 / -LINK125 (devices mounted separately)

I_o [A]	10°C	15°C	20°C	25°C	30°C	35°C	40°C	45°C	50°C	55°C	60°C
32	32	32	32	32	32	32	32	32	32	32	32
63	63	63	63	63	63	63	63	63	63	63	63
125	125	125	125	125	125	125	110	110	100	100	100

The tables are based on measurements using cable as stated in IEC 60947-2. Any derivation from these cable diameters and lengths might lead to higher temperatures.

Therefore ABB recommends to perform temperature measurements to verify the real maximum temperature in the application.

Pole connector	GTIN	Order details		Price	Weight	Pack
	7612271	Type code	Order code	1	1 piece	unit
	EAN			piece	kg	pc.
Pole connector 50 A	211295	S802-LINK50	2CCS800900R0411		0.03	10
Pole connector 125 A	419103	S802-LINK125	2CCS800900R0562		0.15	2

Auxiliary elements for S800

S800 Busbar system



S800 Busbar system

S800 Busbar system

The S800 busbar system is comprised of:

S804-BBPC120	120 mm ² feed block, 4-pole
S804-BB250	250A busbar, 4-pole and neutral with 24 contacts pins
S804-BB6	250A busbar, 4-pole with 6 contacts pins
S803-BB250	250A busbar, 3-pole with 24 terminal lugs and 2 end caps
S803-BBPC120	120 mm ² feed block, 3-pole
S800-BBIC	Optional contact-protection cap for exposed terminal lugs
S800-END	Optional end cap

The busbar, which can be shortened in length by the user, ensures the safe and rational connection of the S800 high performance MCB. A cable cross-section of up to 120 mm² can be connected at the feed block.

Busbar S803-BB250/S804-BB250

Max. rated current I_n		
Side feed	A	125
Middle feed	A	250
Conditional rated short-circuit current	kA eff	100 with T_{max} connected upstream
Poles		3/4
Rated operational voltage U_e		
(AC) 50/60 Hz	V	400/690
Rated insulation voltage U_i	V	690
Rated impulse withstand voltage U_{imp}	kV	8
Rated frequency	Hz	50
Standard		EN/IEC 60439-2
Material of rails		E-C _u 58 half-standard, rolled F25
Material of insulation profile		Material group I; UL94 V-0
Material of end caps		Material group I; UL94 V-0 Free of halogen and phosphate
Busbar cross sections	mm ²	60
Overvoltage category		III
Pollution degree		2

Feed block S803-BBPC120/S804-BBPC120

Max. rated current I_n	A	250
Poles		3/4
Rated operational voltage U_e	V	400/690
Rated frequency	Hz	50
Standard		EN/IEC 60439-2
Material of terminals		Material group I
Housing material		Material group I; UL94 V-0, Free of halogen and phosphate
Tightening torque		-
on feed side	Nm	19
on busbar side	Nm	3
Connection cross-section	mm ²	1.6...120
Pollution degree		2

Auxiliary elements for S800

S800 Busbar system



S803-BB250

	GTIN 76122712	Order details		Price 1	Weight 1 piece	Pack unit
Busbar	EAN	Type code	Order code	piece	kg	pc.
Busbar 250A with 24 contacts pins, 3P	08288	S803-BB250	2CCS800900R0071		1.05	1



S804-BB250

	GTIN 76122714	Order details		Price 1	Weight 1 piece	Pack unit
Busbar	EAN	Type code	Order code	piece	kg	pc.
Busbar 250 A with 24 contacts pins, 3P+N	41807	S804-BB250	2CCF019568R0001		2	1
Busbar 250 A with 6 contacts pins, 3P	41302	S803-BB6	2CCF019562R0001		0.375	1



S804-BBPC120

	GTIN 7612271	Order details		Price 1	Weight 1 piece	Pack unit
Feed block	EAN	Type code	Order code	piece	kg	pc.
Feed block 4p 120mm ²	441807	S804-BBPC120	2CCF019569R0001		0.58	1
Feed block 3P 120mm ²	1208301	S803-BBPC120	2CCS800900R0101		0.46	1



S800-END

	GTIN 76122712	Order details		Price 1	Weight 1 piece	Pack unit
Contact-protection cover	EAN	Type code	Order code	piece	kg	pc.
Contact-protection cover	08967	S800-BBIC	2CCS800900R0081		0.02	12

	GTIN 76122712	Order details		Price 1	Weight 1 piece	Pack unit
End cap	EAN	Type code	Order code	piece	kg	pc.
End cap	08295	S800-END	2CCS800900R0091		0.04	10

Auxiliary elements for S800

27mm wide universal adapter S800



27mm wide universal adapter S800

27mm wide universal adapter to mount S800 MCB on SMISLINE TP system

The universal adapter with the new 9mm dummy housing is specially designed for the High performance breaker S800. This allows to have a 27mm adapter on the SMISLINE TP busbar system. The S800 High performance MCB can be easily mounted and wired on the universal adapter. The complete unit can be clicked on to the plug-in socket system quickly and safely. The input wiring is then already finished.

- Max. Incoming 400A (T5/XT5) rated conditional short-circuit current I_{cc} 40kA (415V) with S800S
- Time-saving mounting of S800 MCB units up to 30% faster than conventional DIN rail mounting
- Input wiring is already integrated in the SMISLINE plug-in socket system

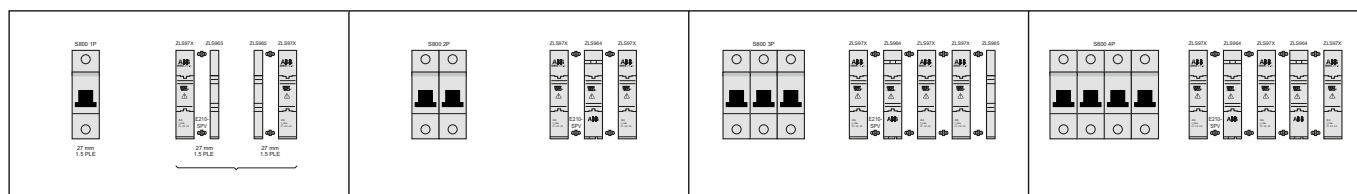

Smisline adapter for S800 (up to 50 A)	GTIN	Order details		Price	Weight	Pack
	761227	EAN	Type code	1	1 piece	unit
L1 or L2 or L3 wire bottom	1444716	ZLS973	2CCA180556R0001	0.024	10	
L1 or L2 or L3 wire bottom	1444716	ZLS973	2CCA180556R0001	0.024	10	
N wire top	1444723	ZLS972N	2CCA180557R0001	0.024	10	
N wire bottom	1444730	ZLS973N	2CCA180558R0001	0.024	10	
Dummy housing						
9mm dummy housing	1501440	ZLS965	2CCA180545R1001			5
18mm dummy housing	1444556	ZLS964	2CCA180550R0001	0.011	10	
Connection piece (2 connectors are needed to connect)	1414801	E210-SPV	2CCC703715R0001	0.050	30	

Auxiliary elements for S800

27mm wide universal adapter S800



27mm wide universal adapter S800

Unifix H

The Unifix H System with feed module up to 400A provides the user a high standardised design of energy distribution. The wide range of assembly and adapter combinations which are also available for the S800 range increase flexibility allowing for compact and cost-effective design of the electrical distribution network. See dedicated System pro E power offering

The following adapters are available for the S800 range:

- ED2557 L1 ≤ 32 A
- ED2558 L2 ≤ 32 A
- ED2559 L3 ≤ 32 A
- ED2560 N ≤ 32 A
- ED2551 L1 125 A
- ED2552 L2 125 A
- ED2553 L3 125 A
- ED2554 N 125 A
- ED2550 filler

Plug-in systems

UNIFIX rapid wiring system

UNIFIX – Rapid Wiring System

UNIFIX makes bench pre-cabling possible, with installation in the switchboard only carried out at a later time, without any limit to the types or combination of apparatus you may need to install...and this becomes even easier, thanks to the rigid coupled connectors, standardized for the different types of apparatus.

Unifix H allows modular and moulded-case circuit-breakers up to 250A to be mounted on an apparatus frame, which can be connected directly to the rear busbar system. This means many fewer conductors circulating inside the switchboard with considerable advantages in terms of space

taken up, connections needed to be checked, and cabling times, with consequent cost savings. Unifix L means traditional wire cabling on the supply side of the circuit-breakers can be replaced. It is thanks to the characteristics of its connections that cabling can be done rapidly and without any possibility of error, obtaining a more essential switchboard without conductors and cabling ducts around. Flexibility is its strong point: several independent circuits can be realized on the same DIN rail, and circuit-breakers of different types, with different polarity and characteristics can be mounted.

Customer Benefits with UNIFIX

Wiring Time

The use of Unifix reduces considerably wiring time.

Use of Standard Devices

Unifix can be applied to all standard versions of ABB Sace modular devices, Tmax T1 - T2 - T3 - XT1 - XT3 moulded-case circuit breakers

Flexible

Unifix has variable modular capacity, it is possible to place both circuit-breakers with different polarities side by side on the same line and auxiliary elements.

Reduce Space

Space taken up by Unifix is extremely low

For order codes and technical details please check the Distribution Switchgear Catalogue 1STC008001D0203, pages 3/19-20, 4/18-19-20, 5/50-51-52



Plug-in systems

UNIFIX rapid wiring system

—
Unifix H

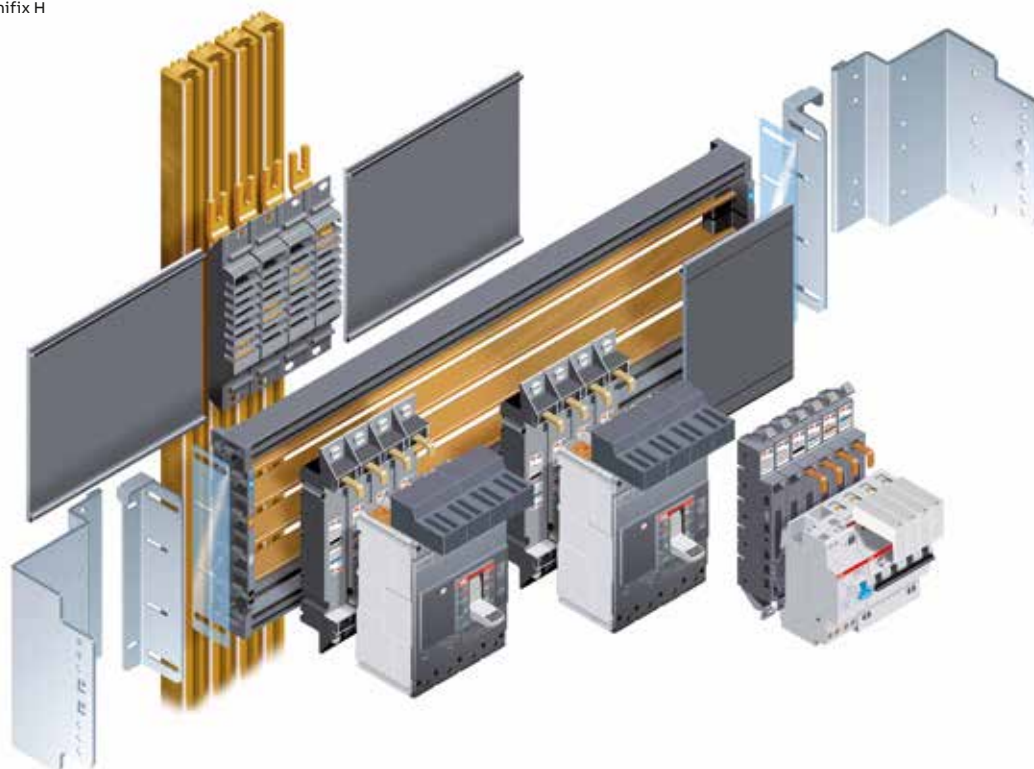

—
Unifix L

