









































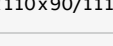





Electrical installation solutions for buildings

General purpose enclosures

Index	
MultiBox	24/3
Small multi-purpose boxes	24/3
APO	24/10
Modular polyester boxes	24/10
VMS	24/22
Modular system	24/22
ARIA	24/40
Universal polyester enclosures	24/40
PolySafe	24/46
Multi-function polyester enclosures	24/46
Accessories	24/60
Gemini	24/88
Basic configuration - Gemini switchboards	24/96
Components for automation applications	24/99
Components for distribution and mixed applications	24/104
Accessories	24/112
Fast selection table	24/117
Configurations examples	24/121
SR2	24/124
General characteristics of SR2 Enclosures	24/124
Selection table - SR2 enclosures	24/127
Ordering codes - SR2 enclosures	24/128
Overall dimensions - Drillings SR2	24/145
SRX	24/146
General characteristics and applications - SRX enclosures	24/146
Selection of the structure - SRX enclosures	24/148
Ordering codes - SRX enclosures	24/149
Overall dimensions - Drillings SRX	24/159
Switchboards for industrial applications with black front	24/160

General Purpose Enclosures

Range overview

IP66 Multibox	IP67 APO	IP65/66 ARIA	IP54/55/65 PolySafe
 65x65x57/81	 186x151x140	 300x200x170	 500x500x320
 94x65x57/81	 302x186x175	 400x300x170	 500x750x320
 94x94x57/81	 302x302x175	 500x400x230	 500x1000x320
 110x110x66/90	 372x302x175	 600x400x230	 750x500x320
 130x94x57/81	 488x302x175	 700x500x270	 750x750x320
 130x130x75/99	 558x302x175	 800x600x300	 750x1000x320
 180x94x57/81	 603x302x175	 1000x800x300	 750x1250x320
 180x110x90/111/165	 603x372x175		 1000x500x320
 182x180x90/111/165	 603x302x175		 1000x750x320
 254x180x90/111/165	 603x372x175		 1000x1000x320
 361x254x111/165	 603x603x175		 1000x1000x320
			 1000x1250x320
			 1250x750x320
			 1250x1000x320
			 1250x1000x320
			 1250x1000x320
			 1250x1000x320
			 1250x1000x320
			 1250x1000x320

General purpose enclosures

MultiBox - Small multi-purpose boxes for all types of application



MultiBox

Applications

- Ideal for industrial automation and control, machinery and OEM.
- Electronic applications in the telecommunications industry.
- May also be used in tertiary and energy distribution applications.

Standard: EN/IEC 60670-22 (Polystyrene), EN/IEC 61439-2 (Polycarbonate)

Specifications and advantages

- 11 different sizes of box are available (from 65 x 65 mm up to 361 x 254 mm) plus 3 different cover heights.
- Material: polystyrene or polycarbonate reinforced with glass fiber.
- Color: RAL 7035 gray
- High protection rating, IP66-IK07 for polystyrene and IP66-IK08 for polycarbonate, thanks to the injected polyurethane gasket.
- Polycarbonate boxes are available with a smooth surface (one single entry) or with multiple metric cutouts.
- Polystyrene boxes are available with a smooth surface or with multiple metric cutouts.
- Opaque gray or transparent covers available in various heights.
- Designed for installation on all types of surface.
- Vertical and horizontal coupling.
- Polystyrene boxes (glow wire tested to 650°C) can withstand temperatures of up to +70°C, polycarbonate boxes (glow wire tested to 950°C) can withstand temperatures of up to +120°C.
- Total insulation \square .
- High level of resistance to chemical and aggressive environments.
- Halogen-free.
- Self-extinguishing (UL94-V2).
- Insulation voltage $U_i = 1000 \text{ V}$

Why choose MultiBox?

Would you prefer a standard product or a custom one?

Or, would you prefer a “turnkey” solution (assembled/wired)?

ABB can offer you custom products and comprehensive solutions to meet your requirements!

General purpose enclosures

MultiBox - Small boxes for all types of application

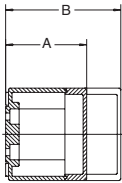

		Polystyrene		Polycarbonate ⁽¹⁾			
		Gray cover RAL 7035		Gray cover RAL 7035		Cover transparent	
Back box	Depth	Type	Order code	Type	Order code	Type	Order code
MB 11 HxL = 65x65mm							
With one metric cutout	A = 57	MB861612	4TBG861612C0100	MB861500	4TBG861500C0100	MB861501	4TBG861501C0100
	B = 81	MB861614	4TBG861614C0100	MB861502	4TBG861502C0100	MB861503	4TBG861503C0100
Smooth	A = 57	MB861668	4TBG861668R0100				
	B = 81	MB861670	4TBG861670C0100				
MB 21 HxL = 94x65mm							
With one metric cutout	A = 57	MB861616	4TBG861616C0100	MB861504	4TBG861504C0100	MB861505	4TBG861505C0100
	B = 81	MB861618	4TBG861618C0100	MB861506	4TBG861506C0100	MB861507	4TBG861507C0100
Smooth	A = 57	MB861672	4TBG861672C0100				
	B = 81	MB861674	4TBG861674C0100				
MB 22 HxL = 94x94mm							
With one metric cutout	A = 57	MB861620	4TBG861620R0100	MB861508	4TBG861508C0100	MB861509	4TBG861509C0100
	B = 81	MB861622	4TBG861622C0100	MB861510	4TBG861510C0100	MB861511	4TBG861511C0100
Smooth	A = 57	MB861676	4TBG861676R0100				
	B = 81	MB861678	4TBG861678C0100				
MB 33 HxL = 110x110mm							
With one metric cutout	A = 66	MB861624	4TBG861624R0100	MB861512	4TBG861512C0100	MB861513	4TBG861513C0100
	B = 90	MB861626	4TBG861626R0100	MB861514	4TBG861514C0100	MB861515	4TBG861515C0100
Smooth	A = 66	MB861680	4TBG861680C0100				
	B = 90	MB861682	4TBG861682C0100				
MB 42 HxL = 130x94mm							
With one metric cutout	A = 57	MB861628	4TBG861628R0100	MB861516	4TBG861516C0100	MB861517	4TBG861517C0100
	B = 81	MB861630	4TBG861630R0100	MB861518	4TBG861518R0100	MB861519	4TBG861519C0100
Smooth	A = 57	MB861684	4TBG861684R0100				
	B = 81	MB861686	4TBG861686C0100				
MB 44 HxL = 130x130mm							
With one metric cutout	A = 75	MB861632	4TBG861632R0100	MB861520	4TBG861520R0100	MB861521	4TBG861521C0100
	B = 99	MB861634	4TBG861634R0100	MB861522	4TBG861522R0100	MB861523	4TBG861523C0100
Smooth	A = 75	MB861688	4TBG861688C0100				
	B = 99	MB861690	4TBG861690R0100				
MB 52 HxL = 180x94mm							
With one metric cutout	A = 57	MB861636	4TBG861636R0100	MB861524	4TBG861524C0100	MB861525	4TBG861525C0100
	B = 81	MB861638	4TBG861638R0100	MB861526	4TBG861526C0100	MB861527	4TBG861527C0100
Smooth	A = 57	MB861692	4TBG861692C0100				
	B = 81	MB861694	4TBG861694C0100				

(1) Smooth = one metric cutout on the short side for a supply cable.

Pack = 1

General purpose enclosures

MultiBox - Small boxes for all types of application



(for terminals)



(for terminals and equipment)

Mounting plate (insulated)		DIN profile 15 x 5 x 1		DIN profile 35 x 7.5 x 1	
Type	Order code	Type	Order code	Type	Order code
				-	
74x45 mm					
MB861731	4TBG861731C0100			-	
				-	
74x74 mm		L=49.5 short side			
MB861732	4TBG861732C0100	MB861741	4TBG861741C0100	-	
90x90 mm		L=80 long/short side			
MB861733	4TBG861733R0100	MB861742	4TBG861742R0100		
110x74 mm		L=92 long/short side		L=81 long/short side	
MB861734	4TBG861734R0100	MB861743	4TBG861743C0100	MB861746	4TBG861746R0100
110x110 mm		L=111 long/short side		L=106 long/short side	
MB861735	4TBG861735R0100	MB861744	4TBG861744R0100	MB861747	4TBG861747R0100
160x74 mm		L=154 long side		L=144 long side	
MB861736	4TBG861736R0100	MB861745	4TBG861745C0100	MB861748	4TBG861748R0100

General purpose enclosures

MultiBox - Small boxes for all types of application

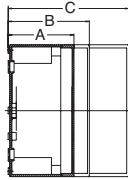

		Polystyrene		Polycarbonate ⁽¹⁾			
		Gray cover RAL 7035		Gray cover RAL 7035		Transparent cover	
Back box	Depth	Type	Order code	Type	Order code	Type	Order code
MB 53 HxL = 180x110mm							
With a metric cutout	A = 90	MB861640	4TBG861640R0100	MB861528	4TBG861528C0100	MB861529	4TBG861529C0100
	B = 111	MB861642	4TBG861642R0100	MB861530	4TBG861530R0100	MB861531	4TBG861531R0100
	C = 165	MB861644	4TBG861644R0100	MB861532	4TBG861532C0100	MB861533	4TBG861533C0100
Smooth	A = 90	MB861696	4TBG861696R0100				
	B = 111	MB861698	4TBG861698C0100				
	C = 165	MB861700	4TBG861700C0100				
MB 65 HxL = 182x180mm							
With a metric cutout	A = 90	MB861646	4TBG861646R0100	MB861534	4TBG861534C0100	MB861535	4TBG861535C0100
	B = 111	MB861648	4TBG861648R0100	MB861536	4TBG861536R0100	MB861537	4TBG861537R0100
	C = 165	MB861650	4TBG861650R0100	MB861538	4TBG861538C0100	MB861539	4TBG861539C0100
Smooth	A = 90	MB861702	4TBG861702R0100				
	B = 111	MB861704	4TBG861704C0100				
	C = 165	MB861706	4TBG861706C0100				
MB 75 HxL = 254x180mm							
With a metric cutout	A = 90	MB861654	4TBG861654R0100	MB861542	4TBG861542C0100	MB861543	4TBG861543C0100
	B = 111	MB861656	4TBG861656R0100	MB861544	4TBG861544R0100	MB861545	4TBG861545R0100
	C = 165	MB861658	4TBG861658C0100	MB861546	4TBG861546R0100	MB861547	4TBG861547R0100
Smooth	A = 90	MB861710	4TBG861710R0100				
	B = 111	MB861712	4TBG861712R0100				
	C = 165	MB861714	4TBG861714R0100				
MB 87 HxL = 361x254mm							
With a metric cutout	B = 111	MB861662	4TBG861662R0100			MB861551	4TBG861551R0100
	C = 165	MB861664	4TBG861664R0100	MB861552	4TBG861552C0100	MB861553	4TBG861553C0100
Smooth	B = 111	MB861718	4TBG861718C0100				
	C = 165	MB861720	4TBG861720R0100				

(1) Smooth = one metric cutout on the short side for a supply cable.
Pack = 1

Table of dimensions

MB (MultiBox)	Height	Width
11	65	65
21	94	65
22	94	94
33	110	110
42	130	94
44	130	130
52	180	94
53	180	110
65	182	180
75	254	180
87	361	254

General purpose enclosures

MultiBox - Small boxes for all types of application



(for terminals
and equipment)

Mounting plate (insulated)		DIN profile 35 x 7.5 x 1	
Type	Order code	Type	Order code
150x90mm			
MB861737	4TBG861737R0100		
150x150mm		L=144 long side	
MB861738	4TBG861738R0100	MB861748	4TBG861748R0100
220x150mm		L=216 long side	
MB861739	4TBG861739R0100	MB861749	4TBG861749R0100
331x220mm		L=336 long side	
MB861740	4TBG861740R0100	MB861750	4TBG861750C0100

General purpose enclosures

MultiBox - Accessories

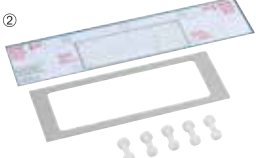
Product	Type	Order code	Pack
Coupling kit			
For assembling multiple boxes horizontally and/or vertically			
① 	① Small M20	MB861753 4TBG861753C0100	5
	① Small M25	MB861754 4TBG861754C0100	5
② 	① Small M32	MB861755 4TBG861755C0100	5
	② Large from MB 53	MB861756 4TBG861756C0100	1

Hinges

Open all boxes using the hinged covers

	Large from MB 53	MB861758 4TBG861758R0100	1
--	------------------	--------------------------	---

Fixing lugs

For external securing of the entire range

	1 set of 4 lugs	MB861759 4TBG861759C0100	1
---	-----------------	--------------------------	---

Spacers

Plastic material (6 + 8 mm), sets the distance between the boxes or the mounting plate and the base of the box

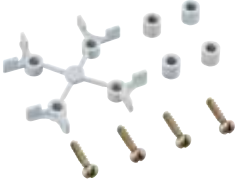
	1 set of 8 parts. (includes securing screws)	MB861762 4TBG861762C0100	1
---	---	--------------------------	---

Product	Type	Order code	Pack
Carry handle			
(plastic, green in color)			
	Includes plastic screws	MB861764 4TBG861764C0100	1
	Includes self-tapping screws	MB861765 4TBG861765C0100	1

IP66 double membrane nipple

IP66 double membrane connection. For assembly without locking nuts. Membrane includes 2 integral seals

	M16	MB861724 4TBG861724R0100	50
	M20	MB861725 4TBG861725R0100	50
	M25	MB861726 4TBG861726R0100	50
	M32	MB861727 4TBG861727C0100	25

Vent (IPx4)

Provides ventilation and prevents condensation. Vents should preferably be installed in the upper and lower sections of the box.

	MB861728 4TBG861728R0100	25
--	--------------------------	----

Cover screws

(plastic, green in color)

	Short for the cover. Depth A	MB861769 4TBG861769R0100	20
	Long for the cover. Depth B & C	MB861770 4TBG861770C0100	20

General purpose enclosures

APO - Modular polyester boxes



APO

Applications

- Heavy industry
- Refineries
- Shipyards
- Steelworks
- Breweries
- Petro-chemical industry
- Public works
- Solar energy applications

Standard: EN/IEC 62208

Specifications

- The range comprises nine different sizes with 300 and 185 mm modules.
- The base is fabricated from polyester, hot press molded and reinforced with glass fiber, dyed in mass RAL 7035 light gray color. It is equipped with M4 inserts (Dodge-type) for attaching a mounting plate or a frame.
- The cover may be fabricated from transparent polycarbonate or hot press molded polyester, reinforced with glass fiber, dyed in mass RAL 7035 light gray color.
- Maximum protection for the user and equipment thanks to its total insulation \square and IP67 protection rating in accordance with EN/IEC 60529.
- IK08 protection rating against external mechanical impacts in accordance with EN/IEC 62208.
- Each box, which is a multiple of a smaller one, also has a variety of the mounting points of the smaller box. These points have non-threaded holes for embedded M4 inserts.
- The base also includes four to six non-threaded holes for embedded M6 inserts.
- The box may be wall-mounted or on a pedestal.
- Material is simple to work with using conventional tools such as drills, mills, saws, etc.
- Polyester boxes can resist temperatures of up to 70°C under continuous operation and peak temperatures of up to 130°C. The transparent polycarbonate covers can resist operating temperatures of up to 120°C.
- Insulation voltage $U_i = 1000 \text{ V}$ and 1500 V dc .
- APO enclosures are UL Listed, in accordance with the UL Standard 508. They are also CSA-certified.

Standards/Certification



- Boxes with polyester cover: types 3, 3R, 4, 4X, 6, 6P, 12 and 13
- Enclosures with polycarbonate cover: types 3, 3R, 4, 4X, 12 and 13
- Boxes with hinged cover: types 3, 3R, 4, 4X, 6, 12 and 13
Available upon request.



- Boxes with polyester cover: types 3, 3R, 4, 4X, 6, 6P, 12 and 13
- Boxes with polycarbonate cover: types 3, 3R, 4, 4X, 12 and 13
- Boxes with hinged cover: types 3, 3R, 4, 4X, 6, 12 and 13
Available upon request.

Lloyd's Register of Shipping⁽¹⁾

⁽¹⁾ Except APO 12

General purpose enclosures

APO - Modular polyester boxes

Modular insulated box system

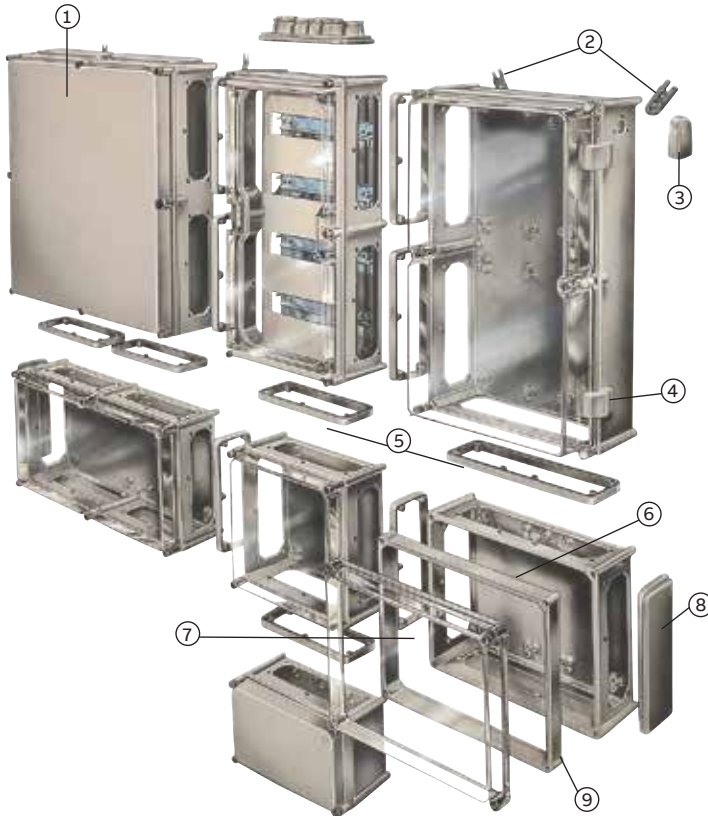

1. Polyester cover
2. Fixing lugs, stainless steel or polyamide
3. Fan
4. Hinge made from insulating material
5. Coupling frame
6. Depth extension frame
7. Transparent polycarbonate cover
8. Solid polyester closure plate
9. Polyurethane gasket

Optimal modular application

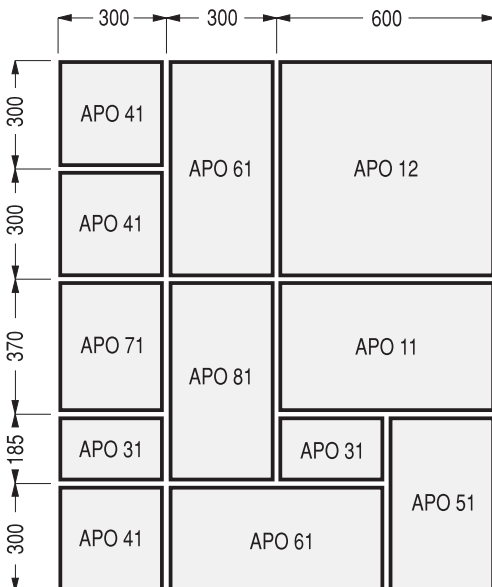

Technical data





Protection classification in accordance with IEC 60529		
Polyester cabinets	with 100% polyester cover	IP67
	with transparent polycarbonate cover	IP66
	with hinged cover	IP67
Cabinet with rubber cable entry		IP43/54 ⁽²⁾
Cabinet combination(s)		IP67 ⁽¹⁾
Cabinet with raised frame		IP66

(1) Depending on cover used
 (2) IP54 if cable entry is mounted at the bottom of the cabinet.

General purpose enclosures

APO - Modular polyester boxes



	Type	APO 1	APO 31	APO 41	APO 71
 <p>Enclosure with polyester cover □ IP67 Solid cover with securing screws</p>	HxWxD	186x151x140	302x186x175	302x302x175	370x300x175
	Type	AP1P	AP31P	AP41P	AP71P
	Order code	4TBO856048C0100	4TBO856049C0100	4TBO856050C0100	4TBO856051C0100
 <p>Enclosure with polycarbonate cover: □ IP66 Transparent cover with securing screws</p>	HxWxD	185x151x140	300x185x175	300x300x175	370x300x175
	Type	AP1T	AP31T	AP41T	AP71T
	Order code	4TBO856057C0100	4TBO856058C0100	4TBO856059C0100	4TBO856060C0100
 <p>Enclosure with pivoting cover □ IP67 Transparent cover with clip-in buttons</p>	HxWxD	-	300x185x175	300x300x175	370x300x175
	Type	-	AP31THC	AP41THC	AP71THC
	Order code	-	4TBO856066C0100	4TBO856067C0100	4TBO856068C0100
 <p>Enclosure with hinged cover □ IP55 Solid cover</p>	HxWxD	185x151x140	300x185x175	300x300x175	370x300x175
	Type	AP1PHC	AP31PHC	AP41PHC	AP71PHC
	Order code	4TBO856071C0100	4TBO856072C0100	4TBO856073C0100	4TBO856074C0100

Pack = 1

(2) UL/CSA certified

General purpose enclosures

APO - Modular polyester boxes

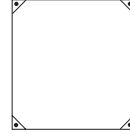

APO 51	APO 81	APO 61	APO 11	APO 12
488x302x175	558x302x175	602x302x175	603x372x175	603x603x175
AP51P	AP81P	AP61P	AP11P	AP12P
4TBO856052C0100	4TBO856053C0100	4TBO856054C0100	4TBO856055C0100	4TBO856056C0100

485x300x210	555x300x210	600x300x210	600x370x210	600x600x210
AP51T	AP81T	AP61T	AP11T	AP12T
4TBO856061C0100	4TBO856062C0100	4TBO856063C0100	4TBO856064C0100	4TBO856065C0100







485x300x175		600x300x175		
AP51THC	-	AP61THC	-	-
4TBO856069C0100		4TBO856070C0100		

485x300x175	555x300x175	600x300x175	600x370x175	600x600x175
AP51PHC	AP81PHC	AP61PHC	AP11PHC	AP12PHC
4TBO856075C0100	4TBO856076C0100	4TBO856077C0100	4TBO856078C0100	4TBO856079C0100

General purpose enclosures

APO - Modular polyester boxes

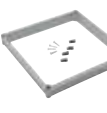
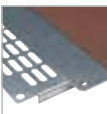

	Type	APO 1	APO 31	APO 41	APO 71	
	Base with solid walls	HxWxD	186 x 151 x 85	302 x 186 x 131	302 x 302 x 131	372 x 302 x 131
		Type	AP1B	AP31B	AP41B	AP71B
		Order code	4TBO856000C0100	4TBO856001C0100	4TBO856002C0100	4TBO856003C0100
		Pack	4	4	1	4
	Base with 2 open walls	HxWxD		302 x 186 x 131	302 x 302 x 131	372 x 302 x 131
		Type	-	AP31B2	AP41B2	AP71B2
	The dimensions with shading are those of the open walls	Order code		4TBO856009C0100	4TBO856010C0100	4TBO856011C0100
		Pack		4	4	4
	Base with 4 open walls	HxWxD		302 x 186 x 131	302 x 302 x 131	372 x 302 x 131
		Type	-	AP31B4	AP41B4	AP71B4
		Order code		4TBO856017C0100	4TBO856018C0100	4TBO856019C0100
		Pack		4	4	4
	Polyester cover	HxWxD	186 x 151 x 45	302 x 186 x 45	302 x 302 x 45	372 x 302 x 45
		Type	AP1PC	AP31PC	AP41PC	AP71PC
	Solid cover including securing screws	Order code	4TBO856025C0100	4TBO856026C0100	4TBO856027C0100	4TBO856028C0100
		Pack	4	4	4	4
	Polycarbonate cover	HxWxD	186 x 151 x 45	302 x 186 x 45	302 x 302 x 45	372 x 302 x 45
		Type	AP1TC	AP31TC	AP41TC	AP71TC
	Transparent cover with securing screws	Order code	4TBO851196C0100	4TBO851173C0100	4TBO851277C0100	4TBO851176C0100
		Pack	4	4	4	4
	Pivoting cover	HxWxD		302 x 186 x 35	302 x 302 x 45	372 x 302 x 45
	Transparent cover with clip-in buttons for the frame	Type	-	AP31STHC	AP41STHC	AP71STHC
		Order code		4TBO856034C0100	4TBO856035C0100	4TBO856036C0100
		Pack		4	4	4
	Depth extension frame	HxWxD	186 x 151 x 35	302 x 186 x 35	302 x 302 x 35	372 x 302 x 35
		Type	AP1DE	AP31DE	AP41DE	AP71DE
	Reinforced with PA6 polyamide glass fiber	Order code	4TBO856040C0100	4TBO856041C0100	4TBO856042C0100	4TBO856043C0100
		Pack	4	4	4	4
	Mounting plate	HxWxD	140 x 105	228 x 139	254 x 228	298 x 254
	Pertinax 5mm	Type	AP1MHP	AP31MHP	AP41MHP	AP71MHP
	Galvanized steel	Order code	4TBO851190C0100	4TBO851187C0100	4TBO851278C0100	4TBO851181C0100
	Sendzimir 2mm	HxWxD	134 x 99	249 x 134	249 x 249	319 x 249
		Type	AP1MS	AP31MS	AP41MS	AP71MS
	1.5 mm perforated plate	Order code	4TBO851191C0100	4TBO851188C0100	4TBO851279C0100	4TBO851185C0100
	(Slide nuts, see I.22)	HxWxD	134 x 99	249 x 134	249 x 249	319 x 249
		Type	-	AP31MSP	AP41MSP	AP71MSP
	Order code		4TBO852875C0100	4TBO852876C0100	4TBO852877C0100	
	Pack	1	1	1	1	

General purpose enclosures

APO - Modular polyester boxes

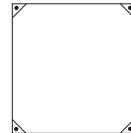
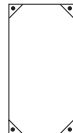

APO 51	APO 81	APO 61	APO 11	APO 12
488 x 302 x 131	558 x 302 x 131	603 x 302 x 131	603 x 372 x 131	603 x 603 x 131
AP51B	AP81B	AP61B	AP11B	AP12B
4TBO856004C0100	4TBO856005C0100	4TBO856006C0100	4TBO856007C0100	4TBO856008C0100
2	2	2	2	2
488 x 302 x 131	558 x 302 x 131	603 x 302 x 131	603 x 372 x 131	603 x 603 x 131
AP51B2	AP81B2	AP61B2	AP11B2	AP12B2
4TBO856012C0100	4TBO856013C0100	4TBO856014C0100	4TBO856015C0100	4TBO856016C0100
2	2	2	2	2
488 x 302 x 131	558 x 302 x 131	603 x 302 x 131	603 x 372 x 131	603 x 603 x 131
AP51B4	AP81B4	AP61B4	AP11B4	AP12B4
4TBO856020C0100	4TBO856021C0100	4TBO856022C0100	4TBO856023C0100	4TBO856024C0100
2	2	2	2	2
488 x 302 x 45	558 x 302 x 45	603 x 302 x 45	603 x 372 x 45	603 x 603 x 45
AP51PC	AP81PC	AP61PC	AP11PC	AP12PC
4TBO856029C0100	4TBO856030C0100	4TBO856031C0100	4TBO856032C0100	4TBO856033C0100
2	2	2	2	2
488 x 302 x 80	558 x 302 x 80	603 x 302 x 80	603 x 372 x 80	603 x 603 x 80
AP51TC	AP81CP	AP61TC	AP11TC	AP12TC
4TBO852092C0100	4TBO851193C0100	4TBO851282C0100	4TBO851290C0100	4TBO852280C0100
-	-	603 x 302 x 45	-	-
2	2	2	2	2
488 x 302 x 45	-	603 x 302 x 45	603 x 372 x 115	-
AP51STHC	-	AP61STHC	AP11STHC	-
4TBO856037C0100	-	4TBO856038C0100	4TBO856039C0100 ⁽¹⁾	-
2	-	2	2	-
-	558 x 302 x 60	603 x 302 x 60	603 x 372 x 60	603 x 603 x 60
-	AP81DE	AP61DE	AP11DE	AP12DE
-	4TBO856044C0100	4TBO856045C0100	4TBO856046C0100	4TBO856047C0100
-	2	2	2	2
413 x 254	484 x 254	528 x 254	528 x 324	555 x 555
AP51MHP	AP81MHP	AP61MHP	AP11MHP	AP12MHP
4TBO852091C0100	4TBO851170C0100	4TBO851286C0100	4TBO851289C0100	4TBO852174C0100
435 x 249	505 x 249	550 x 249	550 x 319	550 x 555
AP51MS	AP81MS	AP61MS	AP11MS	AP12MS
4TBO852095C0100	4TBO851171C0100	4TBO851287C0100	4TBO851292C0100	4TBO852178C0100
435 x 249	505 x 249	550 x 249	550 x 319	550 x 555
AP51MSP	-	-	-	-
4TBO852878C0100	-	-	-	-
1	1	1	1	1

(1) 4TBO856039C0100 2

Pivoting cover with deep frame



General purpose enclosures

APO - Accessories

Product	Type	Order code	Pack
Polystyrene closure plates			
PG/Metric specifications	Width		
4xM20/16 + 1xM32/25	185	APEP185 4TBO856096C0100	1
2xM32/25 + 3xM25/M20 + 4xM20/16	300	APEP35 4TBO856131C0100	1
9xM25/20	300	APEP31 4TBO856097C0100	1
2xM50/40 + 2xM25/	300	APEP32 4TBO856098C0100	1
13xM20/16	300	APEP33 4TBO856099C0100	1
3xM40/32 + 2xM20/16	300	APEP34 4TBO856100C0100	1
1xM40/32 + 10xM25/20	370	APEP371 4TBO856101C0100	1
13xM25/20	370	APEP372 4TBO856102C0100	1



Product	Type	Order code	Pack
Solid polyester closure plates			
	Width		
	185	APBP185 4TBO856103C0100	1
	300	APBP3 4TBO856104C0100	1
	370	APBP37 4TBO856105C0100	1

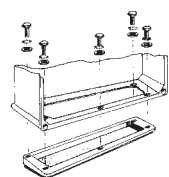

Dimensions for maximum cut-out, see Technical Guide

Product	Type	Order code	Pack
Coupling frames			
Made of glass fiber-reinforced polyamide.			
- Supplied with a template.			
- The slimmest section of the frame must be mounted toward the front of the base.			
- The maximum obtainable passage between two bases is that indicated by the template.			
The required number of openings may be applied within this space.			

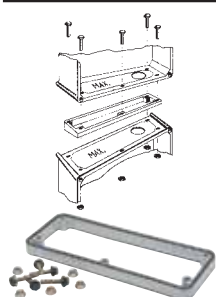

Width

185

300

370

APCF185 4TBO856106C0100 1

APCF3 4TBO856107C0100 1





APCF37 4TBO856108C0100 1

Dimensions for maximum cut-out, see Technical Guide

For walls	Type	Cable max. Ø (mm)	Number of clamps supplied	Made of polyester		
300	APO31	1 x 75	1	AP31CEB	4TBO856115C0100	1
300	APO31	2 x 75	2	AP31CEB2	4TBO856116C0100	1
300	APO41	1 x 75	1	AP41CEB	4TBO856117C0100	1
300	APO61	1 x 75	1	AP61CEB	4TBO781936C0100	1
300	APO71	1 x 71	1	AP71CEB	4TBO781937C0100	1
370	APO71	3 x 75	1	AP71CEB2	4TBO856118C0100	1

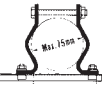

Dimensions, see Technical Guide

Cable grip clamps⁽¹⁾		
		For attaching directly inside the cable end box. Cable max. Ø: 75mm Used on APO 31 and APO 71 For 185, 300 and 370 mm enclosures
AP31CC75	4TBO851105C0100	1
		Universal cable grip clamp Cable max. Ø: 75mm Used on APO 41 For 300, 370 and 600mm enclosures
AP41CC75	4TBO851110C0100	1
		Additional bracket for attaching to the clamp support. Cable max. Ø: 75mm
APCC75	4TBO851111C0100	1

(1) See Technical Guide

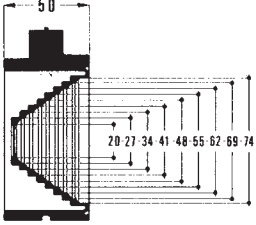
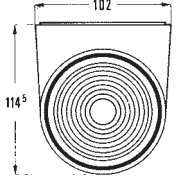

General purpose enclosures

APO - Accessories

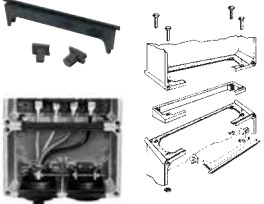
Product	Type	Order code	Pack
Rubber cable entry			
- For direct mounting - Supplied with a template			
	APRCS	4TBO851106C0100	1
			
			
For creating cable end. Cable max. Ø: 75mm			

Product	Type	Order code	Pack
Cable routing insert			
Makes connecting large-section cables simple while maintaining the original level of protection.			
	For 300mm side.		
	APBR3	4TBO851103C0100	1
	For 370mm side.		
	APBR37	4TBO851112C0100	1

Product	Type	Order code	Pack
Locks⁽¹⁾			
Supplied with drilling template and mounting accessories.			
	Handle with 2 keys V2432E		
	APL2432E	4TBO852020C0100	1
(1) Not for use with pivoting cover			

Product	Type	Order code	Pack
IP44 Vent			
Install 2 vents per enclosure for ventilation to prevent the formation of condensation.			
Supplied with a template and fixings. Recommended installation: one vent at the highest and lowest points on each side of the enclosure.			
	Set of 2 polyamide pieces. RAL 7035		
	PS833677	4TBP833677C0100	1
			

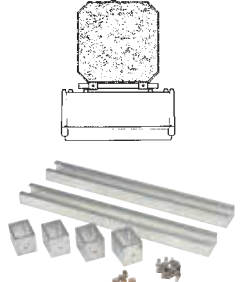
Product	Type	Order code	Pack
Pedestal mounting			
- The C profiles are mounted directly to the rear of the base using the bosses provided.			
- The brackets may be distributed along the length of the C profile according to the width of the pedestal.			
	Set of 2 C profiles and screws. For enclosure 300 and 370mm side.		
	APPM	4TBO890510C2100	1

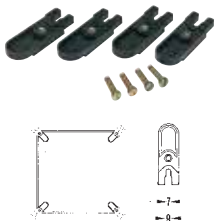
Product	Type	Order code	Pack
Fixing lugs			
Set of 4 supports and screws, in glass fiber-reinforced polyamide.			
	- For external mounting points. - Direct mounting through the 4 corner holes of the enclosure. - If using depth extension frames, first attach the supports. - Max equipment weight: 100 kg.		
	APMBPA	4TBO851266C0100	1

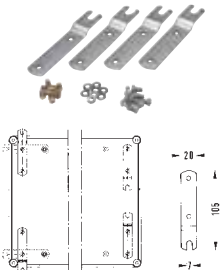
Product	Type	Order code	Pack
Set of 4 stainless supports and screws (304-type)			
	- For very severe operating conditions. - The 4 brackets are mounted directly onto the rear of the base in the section that is reinforced for this purpose. - Mounting by means of M4 threaded inserts (provided). - Max equipment weight: 100 kg.		
	APMBRVS	4TBO852025C0100	1

General purpose enclosures

APO - Accessories

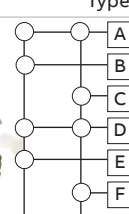
Product	Type	Order code	Pack
Hinges			
Type	Type	Hinges	
	A	A	
	B	B	
	C	C	
	D	D	
	E	E	
	F	F	

Options table	Back box	
APO 31-41-71-51	A	- If hinges are to be installed, the cover and the base or the depth extension frame must be drilled. Drilling templates are provided; the type to be used will obviously depend on the combination selected. - As a result, there is a range of 6 kits comprising 2 hinges, fixing hardware, drilling template, instructions and optional reinforcement plates.
81-61-11-12	A	
Polyester cover	A	
Polyester cover + depth extension frame	B	
Polycarbonate cover	D	
Polycarbonate cover + depth extension frame	E	

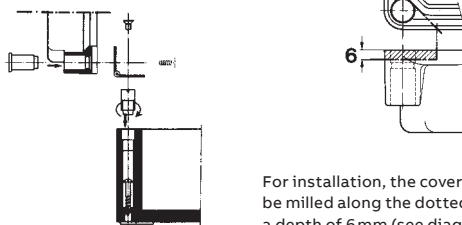
Stainless hinges	
	Set of 2 steel hinges (complete with accessories)
	APHRVS 4TBO851268C0100 1
	For installation, the cover must be milled along the dotted line to a depth of 6 mm (see diagram).

Cover screws	
	Cover screws
	APCS 4TBO851255C0100 50

Clip-in button	
	For cover or strip hinge screws
	Set of 2 pieces
	APCS2 4TBO851258C0100 1

Product	Type	Order code	Pack
Strip hinges			
	Set of 2 pieces		
	APHS	4TBO851256C0100	1
	Warning: the base must be secured before mounting strip hinges.		

Blanking screws with triangular head (TTR)	
For fixed cover	Set of 2 pieces
	APHSTTR 4TBO851262C0100 1

For pivoting cover	Set of 2 pieces
	APHSTTRD 4TBO852016C0100 1

Wrench	
For triangular head screw (TTR)	APTTRK 4TBO851016C0100 1
	











Sealing plate	
	Set of 2 pieces
	APSP 4TBO851260C0100 1

Padlock installation kit	
	APPL 4TBO852004C0100 1
	Maximum shackle diameter: 8mm

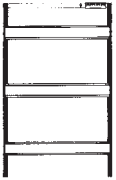
Inserts	
	M4 Dodge-type
	APTIM4 4TBO851026C0100 100
	M6 Dodge-type x 12.5mm
	APTIM6 4TBO851371C0100 100
	M4 punch
	APTIM4T 4TBO851027C0100 1
	M6 punch
	APTIM6T 4TBO852003C0100 1

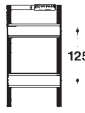
General purpose enclosures

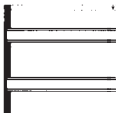
APO - Functions for modular equipment

Type	APO 31	APO 41	APO 71	APO 51	APO 61
					
	302 x 186	302 x 302	372 x 302	488 x 302	603 x 302
	14 modules	14 modules	28 modules	42 modules	42 modules
Type	AP31D141	AP41D141	AP71D282	APACC852283	AP61D423
Order code	4TBO851326C0100	4TBO851336C0100	4TBO851353C0100	4TBO852283C0100	4TBO851345C0100
					
	302 x 186	302 x 302	372 x 302		603 x 302
	14 modules	28 modules	36 modules		56 modules
Type	AP31D142	AP41D282	AP71D362		AP61D564
Order code	4TBO851330C0100	4TBO851338C0100	4TBO851358C0100		4TBO851347C0100

Functions for modular equipment

- Includes:
- Bare chassis, equipped with a ground terminal and a front plate.
 - Securing screws.
 - 4 x 30mm rise pillars.

Accessories

Module cover



Length: 72 mm
Cut-out width: 45 mm
Divisible by 9 mm sections

FORSTBP4	4TBR610142C0200	5
FORSTBP500	4TBR610484C0200	500

Product	Type	Order code	Pack
---------	------	------------	------

Label holders



	Adhesive		
	APLB1M	4TBC851321C0100	1m

Connection busbars

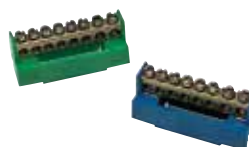

6 x 10 mm² + 2 x 16 mm², Clip onto 12 x 2 mm rail



	Ground busbar - green		
	FORSTTPE	4TBR610186C0200	4
	Neutral busbar - blue		
	FORSTTN	4TBR610187C0200	1

General purpose enclosures

APO - Stand-alone equipped boxes

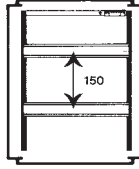
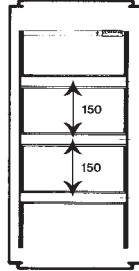
Type	APO 31	APO 41	APO 71	APO 61	APO 11
					
Boxes for modular equipment					
Includes:	186 x 302 x 175		372 x 302 x 175	603 x 302 x 175	
- base with two open sides	14 modules		28 modules	42 modules	
- with combi cable glands	Type AP31DIN1		Type AP71DIN2	Type AP61DIN3	
top: 13 x M20/16	Order code 4TBO856119C0100		4TBO856120C0100	4TBO856121C0100	
bottom: 2 x M32/25 +					
3 x M25/20 +					
4 x M20/16					
- bare chassis, equipped with a ground terminal and a front plate					
- transparent pivoting cover					

General purpose enclosures

APO 61 - □ IP44-IK10 distribution enclosures



APO 61

- Made from polyester, self-extinguishing reinforced with glass fiber.
- Meet AREI requirements.
- Equipped with a circuit breaker for circuit protection.
- Also equipped with a 300 mA differential switch for general protection.
- Distribution cabinets are equipped with wall mounting lugs.
- Wired and equipped with a sufficiently sized entry.
- May be coupled to a meter enclosure.
- 3 x 230 V/3 x 400 V+N network inverter.
- Dimensions: 600x300x175mm

Distribution enclosures with industrial and domestic power outlets

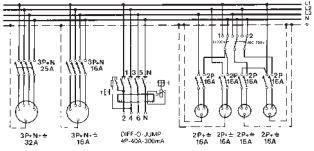
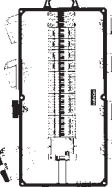
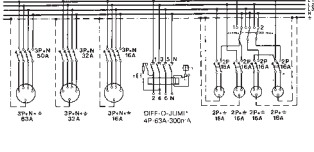
	Equipment	Single-line diagram	Type	Order code
32 A type 	1 x 32 A 5P 6h 400 V EEC power outlet 1 x 16 A 5P 6h 400 V EEC power outlet 4 x power outlets with ground braid and child safety function. Inverter 3P+N 400V / 3x230 V Protection: 1 Diff-o-Jump type A 4P 40 A 300 mA 1 6 kA 3P+N 25 A Car. C. circuit breaker 1 x 6 kA 3P+N 16 A car. C. circuit breaker 4 x 6kA 2P 16 A car. C circuit breaker		AP61BWK32AH	4TBO890501N2100
63 A type 	1 x 63 A 5P 6h 400 V EEC power outlet 1 x 32 A 5P 6h 400 V EEC power outlet 1 x 16 A 5P 6h 400 V EEC power outlet 4 x power outlets with ground braid and child safety function. Inverter 3P+N 400V / 3x230 V Protection: 1 Diff-o-Jump type A 4P 63A 300 mA 1 6 kA 3P+N 50A Car. C. circuit breaker 1 x 6 kA 3P+N 32A car. C. circuit breaker 1 x 6 kA 3P+N 16 A car. C. circuit breaker 4 x 6kA 2P 16 A car. C circuit breaker		AP61BWK63AH	4TBO890502N2100

Distribution enclosures with industrial power outlets

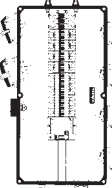
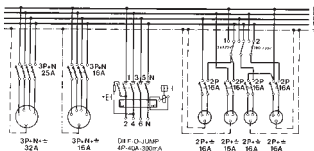
	Equipment	Single-line diagram	Type	Order code
32 A type 	1 x 32 A 5P 6h 400 V EEC power outlet 1 x 16 A 5P 6h 400 V EEC power outlet 4 x 16 A 3P 6h 400 V EEC power outlets Inverter 3P+N 400V / 3 x 230 V Protection: 1 Diff-o-Jump type A 4P 40 A 300 mA 1 6 kA 3P+N 25 A Car. C. circuit breaker 1 x 6 kA 3P+N 16 A car. C. circuit breaker 4 x 6kA 2P 16 A car. C circuit breaker		AP61BWK32AIND	4TBO890505N2100

General purpose enclosures

VMS - Modular system



Applications

- Manufacturing
- Public works
- Controls for motors
- Electronic instrumentation
- Low-voltage distribution boards

Standard: EN / IEC 61439-2, EN / IEC 60529, EN / IEC 62208

Specifications

- The range comprises five base dimensions, multiples of the 100 mm module.
- The ingenious and unique coupling system makes assembly simple and quick, for any combination of enclosures without the need for any tooling.
- The open base affords excellent options for cabling and installation for the connection, even when already coupled.
- The open sides can easily be fitted with smooth walls or walls with cutouts without impacting the protection ratings.
- Each large base is a multiple of smaller bases. The equipment securing points are inset by 25 mm increments, at the top and bottom of the base.
- The base and the closure plates are made from glass fiber-reinforced polycarbonate, halogen-free, self-extinguishing, light gray dyed in the mass (RAL 7035) color. The cover is fabricated from transparent or light gray (RAL 7035) polycarbonate.
- A comprehensive range of closure and mounting plates meeting a wide range of requirements for all installations.
- VMS enclosures are halogen-free.
- Enclosures offer maximized protection to users and equipment thanks to their double insulation \square and IP65 protection rating in accordance with the EN/IEC 60529 standard.

General purpose enclosures

VMS - Modular system

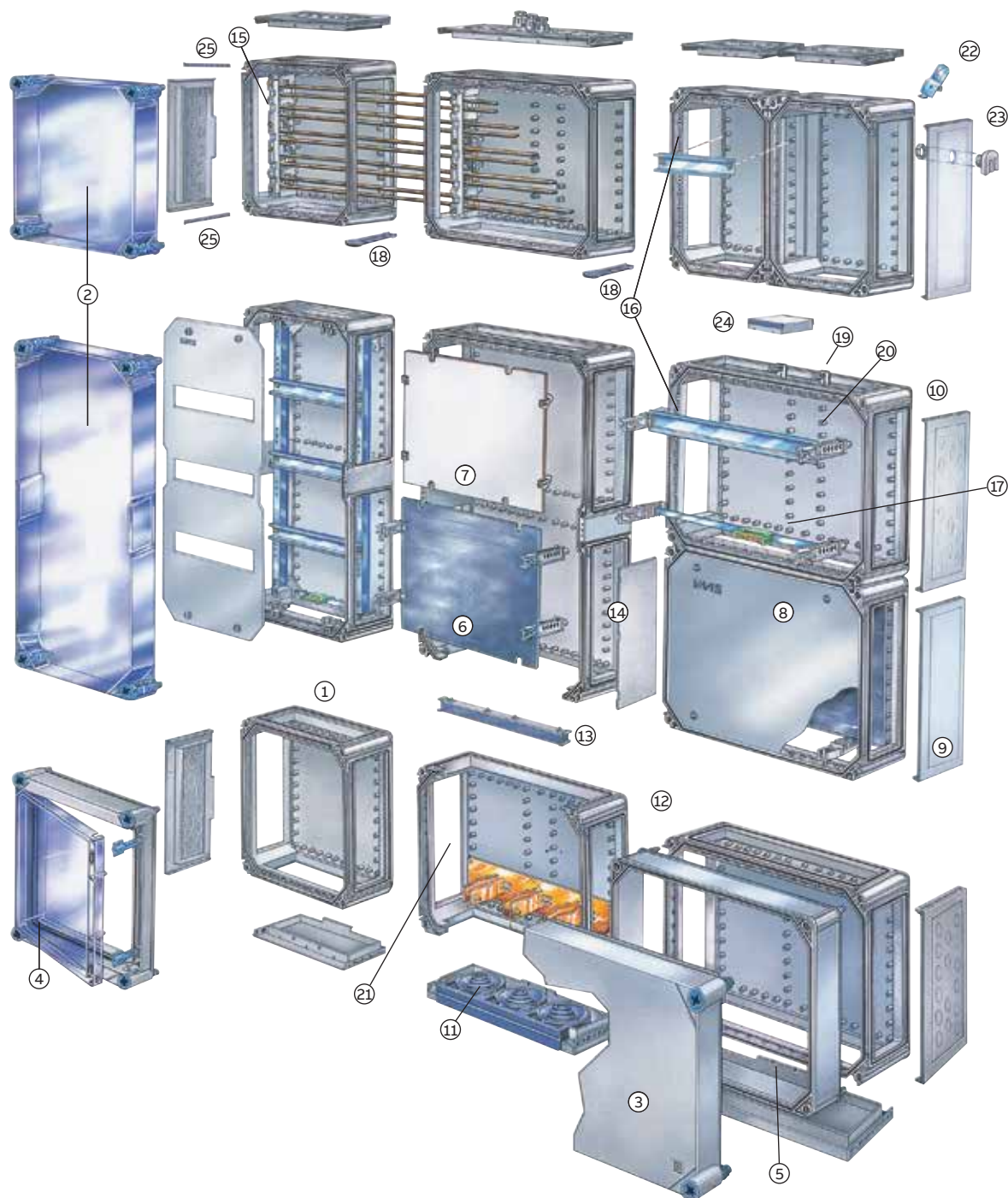

1. Base
2. Transparent cover
3. Opaque cover
4. Pivoting cover
5. Depth extension frame
6. Mounting plate: metal
7. Mounting plate: pertinax

8. Solid cover panel
9. End plate
10. End plate with punch-out
10. End plate with cable entry
12. Cable grip support
13. Bridge
14. Partition plate

15. Busbar support
16. DIN rail
17. Mounting rail 12x2 mm
18. Coupling dowels
19. Coupling clamp
20. Universal support
21. Stress-relieving cable clamp

22. Mounting brackets
23. Air vent
24. Coupling set 2x220 mm
25. Locking pin

General purpose enclosures

VMS - Features and benefits



Modular dimensions in increments of 100mm in height and width, available in five sizes:

320×220 mm	320×320 mm
440×320 mm	640×320 mm
640×440 mm	



Assorted covers: transparent, opaque, or hinged; common design and depth.

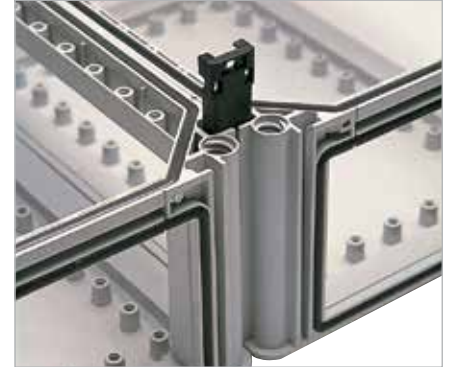

Quick coupling thanks to the coupling dowels inserted into the four corner slots of the boxes.



End plates are snapped on from the outside and fixed by means of vertically sunk keys at the front of the base.



After installation, the end-plates fit perfectly into the side panels of the base.

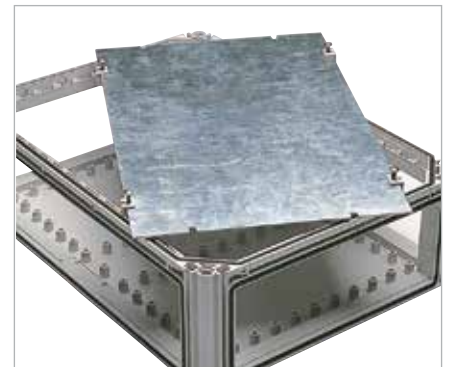

Mounting plates (2 mm in metal or 5mm in insulating material (pertainax), with mounting accessories).



Universal support for screwless and depth adjustable installation of DIN rails. This universal support is simply clicked over the base.

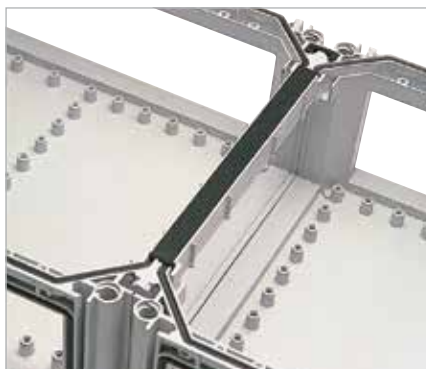

Removable bridges facilitate the introduction of large-section cables. After connecting the cables, insert the bridges (320 and 440 mm sides).

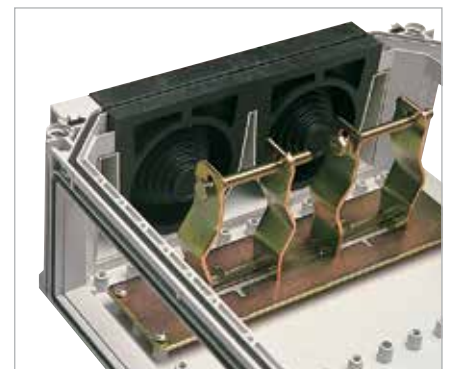

Universal cable entries and stress-relieving cable clamps to Ø 75 mm are attached to all base on side 320 mm (for 2 cables) and side 440 mm (for 3 cables).

General purpose enclosures

VMS - features and benefits

Vertical and horizontal stacking of enclosures

Enclosures are assembled using dowel pins mounted on the front end. The dowel pins are universal for the entire range of VMS enclosures.

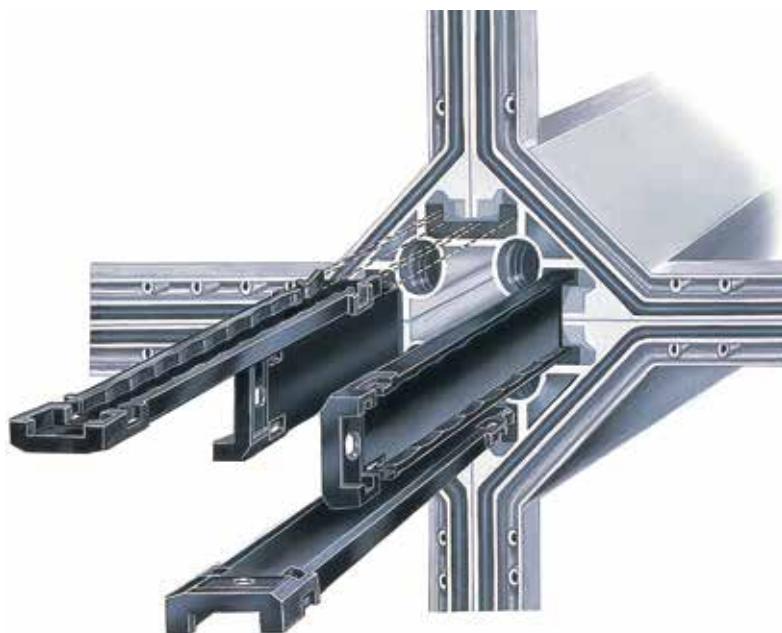

Installation of end plates

After insertion from outside, the end plate is locked in position by two dowel pins and pressed against the enclosure body joint.



General purpose enclosures



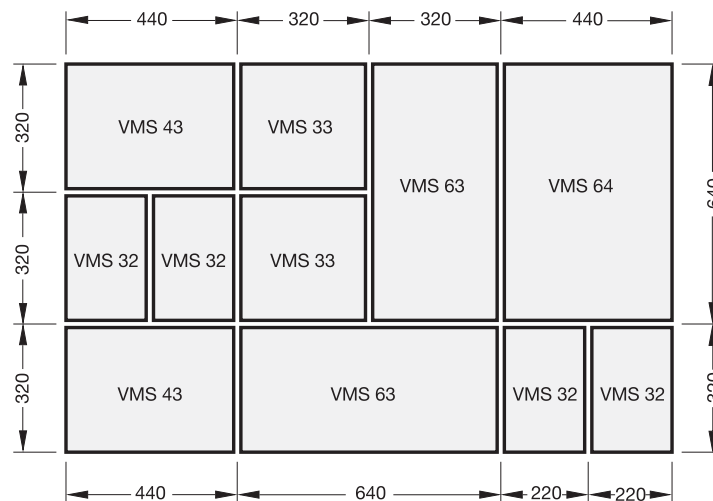

VMS - Technical data

Degree of protection according to IEC 60529	
individual and coupled	IP65
with coupling set 2 x 220	IP44
with extension frame	IP65
with cable entries	IP43
with bridges	IP55
Protection degree against external mechanical impacts according to EN 62262 and IEC 62262	
base + end plates + covers	IK08
hinged cover	IK06
Materials	
base + end-plates	Reinforced fiber-glass polycarbonate
covers	Polycarbonate
cover screws	Polyamide
gasket	PUR, neoprene
Temperature resistance	
materials	See page 158–159
continuous use	-20 °C up to +80 °C
Colours	
base + end-plates	RAL 7035
covers	RAL 7035 / transparent
Protection	Double isolation <input type="checkbox"/>
Rated voltage	415 V AC / 1000 V DC
Rated insulation voltage	1000 V AC
Rated current	max. 1100 A
Rated short time withstand current	max. 30 kA (1.0 s.)
Rated peak short-circuit current	max. 63 kA peak
Standards	EN 61439-2, DIN VDE 0660, IEC 61439-2

Optimal modular application









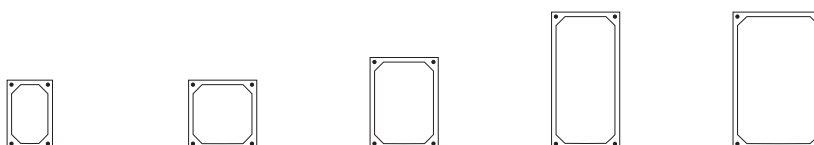

VMS - Range overview

IP65 VMS (modular)				
				
320×220×179 mm	320×320×179 mm	440×320×179 mm	640×320×179 mm	640×440×179 mm

General purpose enclosures

VMS - Modular system components













	Type	VMS 32	VMS 33	VMS 43	VMS 63	VMS 64	
	Base	H×W×D	320×220×130	320×320×130	440×320×130	640×320×130	640×440×130
	With four open sides	Type	V32BWNJ6	V33BWNJ6	V43BWNJ6	V63BWNJ6	V64BWNJ6
		Order code	4TBV853000C0100	4TBV853001C0100	4TBV853002C0100	4TBV853003C0100	4TBV853004C0100
		Emb.	4	2	2	1	1
	Cover transparent	H×W×D	320×220×50	320×320×50	440×320×50	640×320×50	640×440×50
	With slotted screws	Type	V32CTNJ6	V33CTNJ6	V43CTNJ6	V63CTNJ6	V64CTNJ6
		Order code	4TBV853005C0100	4TBV853006C0100	4TBV853007C0100	4TBV853008C0100	4TBV853009C0100
		Emb.	4	2	2	1	1
	Cover solid	H×W×D	320×220×50	320×320×50	440×320×50	640×320×50	640×440×50
	With slotted screws	Type	V32CBNJ6	V33CBNJ6	V43CBNJ6	V63CBNJ6	V64CBNJ6
		Order code	4TBV853010C0100	4TBV853011C0100	4TBV853012C0100	4TBV853013C0100	4TBV853014C0100
		Emb.	4	2	2	1	1
	Cover Hinged	H×W×D	-	320×320×50	440×320×50	-	-
	With double closure system Opening at 215°	Type	-	V33CPNJ6	V43CPNJ6	-	-
		Order code	-	4TBV853015C0100	4TBV853016C0100	-	-
		Emb.	-	2	2	-	-
	Depth extension frame	H×W×D	320×220×75	320×320×75	440×320×75	640×320×75	640×440×75
	With fixing screws	Type	V32WDNJ6	V33WDNJ6	V43WDNJ6	V63WDNJ6	V64WDNJ6
		Order code	4TBV853030C0100	4TBV853031C0100	4TBV853032C0100	4TBV853033C0100	4TBV853034C0100
		Emb.	4	2	2	1	1
	Metal mounting plate, 2mm	H×W×D	260×160	260×260	380×260	580×260	580×380
	With mounting set	Type	V32MWNJ6	V33MWNJ6	V43MWNJ6	V63MWNJ6	V64MWNJ6
		Order code	4TBV853068C0100	4TBV853069C0100	4TBV853070C0100	4TBV853071C0100	4TBV853072C0100
		Emb.	1-10	1-10	1-10	1-10	1-10
	Pertinax, 5mm	H×W×D	260×160	260×260	380×260	580×260	580×380
	With mounting set	Type	V32IWNJ6	V33IWNJ6	V43IWNJ6	V63IWNJ6	V64IWNJ6
		Order code	4TBV853113C0100	4TBV853114C0100	4TBV853115C0100	4TBV853116C0100	4TBV853117C0100
		Emb.	1-10	1-10	1-10	1-10	1-10
	Solid cover plate Grey (RAL7035)	H×W×D	301×201	301×301	421×301	621×301	621×421
	Insulated material, 2mm With mounting set	Type	V32PWNJ7	V33PWNJ7	V43PWNJ7	V63PWNJ7	V64PWNJ7
		Order code	4TBV853103C0100	4TBV853104C0100	4TBV853105C0100	4TBV853106C0100	4TBV853107C0100
		Emb.	1-10	1-10	1-10	1-10	1-10

General purpose enclosures

VMS - Accessories











Closure plates						
		Metric sizes	Type	Order code	Pack Size	
		3 x M32 / M25 + 3 x M20	VX2EWNJ7	4TBV855029C0100	1/10	220
		1 x M50 / M40 + 4 x M25 / M20	VX2EWNJ8	4TBV855030C0100	1/10	220
		3 x M50 / M40 + 4 x M16	VX3EWNJ9	4TBV855032C0100	1/10	320
		17 x M20	VX3EWNJ0	4TBV855033C0100	1/10	320
		1 x M50 / M40 + 2 x M32 / M25 + 4 x M25 / M20	VX3EWNJA	4TBV855034C0100	1/10	320
		12 x M25 / M20	VX3EWNJB	4TBV855035C0100	1/10	320
		4 x M40 / M32 + 3 x M20	VX3EWNJC	4TBV855036C0100	1/10	320
		1 x M40 / M32 + 16 x M25 / M20	VX4EWNJ8	4TBV855037C0100	1/10	440
		1 x M50 / M40 + 2 x M40 / M32 + 8 x M25 / M20	VX4EWNJ9	4TBV855038C0100	1/10	440

Product	Type	Order code	Pack	Product	Type	Order code	Pack	
Closure plates				Fixation pin				
	Side (mm) 220				For end-plates (as a spare part)			
	VX2EWNJ6	4TBV853017C0100	1/10		VXXEWNJ6	4TBV853055C0100	10	
	Side (mm) 320			Coupling set 2 x 220				
	VX3EWNJ6	4TBV853020C0100	1/10		To couple two sides of 220mm to one side of 440mm With mounting accessories			
Side (mm) 440			VXXAWNJA		4TBV853063C0100	1		
VX3EWNJ7	4TBV853027C0100	1/10	Coupling clamp					
Plates with cable entries					For coupling in special cases			
	Ø cable max.: 2 x 75 mm				VXXAWNJ9	4TBV853062C0100	10	
	Side (mm) 320			Universal support				
	VX3EWNJ6	4TBV853082C0100	1/5		To fit:			
	Ø cable max.: 3 x 75 mm				- mounting plates and DIN-rails			
Side (mm) 440			- copper rails 15 x 3					
VX4EWNJ6	4TBV853083C0100	1/5		- copper rails 9 x 6.5				
				- mounting rail 12 x 2mm				
				VX3UWNJ6	4TBV853060C0100	10		
Cable grip support				Marking strip				
With a cable clamp Ø max.: 75mm					Self-adhesive			
	Side (mm) 320				ZA10	2CPX038241R9999	1m	
	VX3LWNJ6	4TBV853036C0100	1/5		Stress-relieving cable clamp			
	Side (mm) 440				For fixing on the cable clamp support			
	VX4LWNJ6	4TBV853037C0100	1/5		Ø cable max.: 75mm			
Bridges					VXXLWNJ6	4TBV853035C0100	1	
Facilitate the connection of large-section cables					Coupling dowels			
Side (mm) 320					For base coupling			
VX3AWNJ6	4TBV853073C0100	1			VXXAWNJ8	4TBV853059C0100	20	
Side (mm) 440			Bridges					
VX4AWNJ6	4TBV853074C0100	1	Facilitate the connection of large-section cables					

General purpose enclosures

VMS - Accessories

Product	Type	Order code	Pack
Symmetrical DIN-profiles			
Always supplied with two universal supports			
	Side (mm) 220		
	VX2AWNJ6	4TBV853094C0100	1
	Side (mm) 320		
	VX3AWNJ6	4TBV853095C0100	1
	Side (mm) 440		
	VX4AWNJ6	4TBV853096C0100	1
	Side (mm) 640		
	VX6AWNJ6	4TBV853269C0100	1
Mounting rails 12 x 2mm			
To fit connection terminal blocks. Always delivered with 2 universal supports.			
	Side (mm) 320		
	VX3AWNJ7	4TBV853098C0100	1
	Side (mm) 440		
	VX4AWNJ7	4TBV853099C0100	1
Partition plates			
For complete compartmentalization of coupled bases.			
	Side (mm) 220		
	VX2TWNJ6	4TBV853065C0100	1
	Side (mm) 320		
	VX3TWNJ6	4TBV853066C0100	1
	Side (mm) 440		
	VX4TWNJ6	4TBV853067C0100	1
Fixing lugs			
Set of 4 brackets with screws.			
<ul style="list-style-type: none"> - In stainless steel. - For external fixing points. - Direct fitting through the four corner shafts of the base. - To be installed prior to the extension frame or hinge installation. - Three optional mounting positions (0°, 45°, 90°). 			
	VXXAWNJB	4TBV853064C0100	1
Air vent - IP45			
Installation of two air vents per box to obtain ventilation preventing the formation of condensation. Set of 2 pieces.			
	ACC818078	4TBJ818078R0100	1
Blanking plate			
For 12 modules			
	ZA1P5	2CPX062384R9999	5
	ZA1P50	2CPX062378R9999	50

Product	Type	Order code	Pack
Cover screws			
	Set of 4 pieces.		
	VXXCWNJ6	4TBV853057C0100	1
Hinge screws			
The base must be bed before fixed prior to hinge installation.			
Set of 2 pieces.			
	VXXHWNJ6	4TBV853061C0100	1
Hinges made of molded material			
To mount the hinges, the cover and the base must be pierced. Drilling templates are provided. The kit includes: two hinges, screws, reinforcement plates, drilling gage and instructions. Set of 2 pieces.			
	VXXHWNJ7	4TBV853340C0100	1
Clip-in button			
For cover screws or hinge screws. Set of 4 pieces.			
	VXXAWNJ7	4TBV853058C0100	1
Clip-in button			
For fixation in the base.			
5 x 13			
	VXXAWNJC	4TBV853100C0100	50
	5 x 16		
	VXXAWNJD	4TBV853101C0100	50
	5x22		
	VXXAWNJA	4TBV853102C0100	50
	To fix the equipment onto the metal mounting plates.		
Screws for depth extension frame			
Replacement parts			
	VXXDWNJ6	4TBV853056C0100	4
Fixation set for cover plate			
Replacement parts			
	VXXPWNJ7	4TBV853053C0100	1
Fixation set for mounting plate			
For metal or Pertinax			
Replacement parts			
	VXXIWNJ6	4TBV853054C0100	1

General purpose enclosures

VMS - Accessories

Product	Type	Order code	Pack
Cover plate for DIN rail functions			
	VMS33 2 rows For V33BWDJ6		
	V33PWNJ9	4TBV853327C0100	1
	VMS43 2 horizontal rows For V43BWDJ7		
	V43PWNJ9	4TBV853330C0100	1
	VMS63 2 horizontal rows For V63BWDJ6		
	V63PWNJ0	4TBV853333C0100	1
	VMS63 4 rows For V63BWDJ6		
	V63PWNJ9	4TBV853332C0100	1
	VMS64 4 rows For V64BWDJ6		
	V64PWNJ8	4TBV853334C0100	1

Product	Type	Order code	Pack
Cover plate for fuse switch-disconnectors and for other components mounted on a 60mm rail system with screws.			
	VMS 32 (Cut-out 195x135 mm)		
	V32PWNJ8	4TBV853173C0100	1
	VMS 33 pour V33BWHE5 (Cut-out 195x235 mm)		
	V33PWNJ8	4TBV853174C0100	1
	VMS 63 pour V33BWHE5 (Cut-out 195x240 mm 2 pieces)		
	V63PWNJ8	4TBV853176C0100	1

General purpose enclosures

VMS - Supporting frame for wall mounting

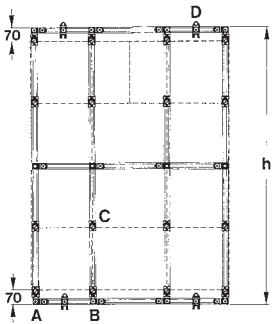

- Fixing small units onto the wall can be done using the stainless steel mounting brackets.
- To transport and fix units with more than five enclosures, the use of a frame is essential.
- The frame includes at least 2 horizontal C-profiles (of an equal length to the width of the unit) and vertical C-profiles (equal to the number of rows +1).
- If the unit exceeds a height of 1000mm, three horizontal C-profiles are required.
- The vertical C-profiles are 140mm longer than the height of the assembled panel.
- The frame and the unit are built simultaneously.



The horizontal and vertical C-profiles of the first row of enclosures are attached to each other by clamping brackets with sliding nuts. The following clamping brackets are mounted in the same way on the horizontal profile.



The following rows are mounted in the same way on the frame.



The first row of enclosures is then mounted on vertical profile with the clamping plates.

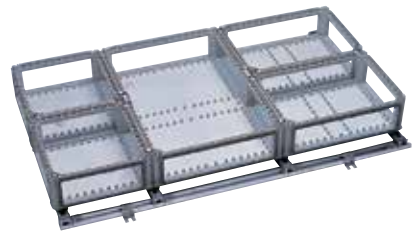

Frame and enclosure assemblies are mounted simultaneously.

Product	Type	Order code	Pack
C-Profile in aluminum			
	30 x 17 x 3mm Length = 3m	APACC851254 4TBO851254C0100 5	

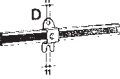
Product	Type	Order code	Pack
Fixation plate			
	Delivered with bolt and sliding nut. To fix the enclosures onto the vertical support profiles.	APACC851415 4TBO851415C0100 1	

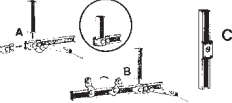
Product	Type	Order code	Pack
Clamping bracket			
	With bolts and two sliding nuts M8. To mount the upper and lower C-profiles to the vertical support-profiles	APACC851253 4TBO851253C0100 1	

Product	Type	Order code	Pack
Clamping bracket			
	To fix the enclosures onto the fixation plate.	APACC851249 4TBO851249C0100 1	

General purpose enclosures

VMS - Supporting frame for floor standing

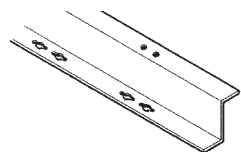
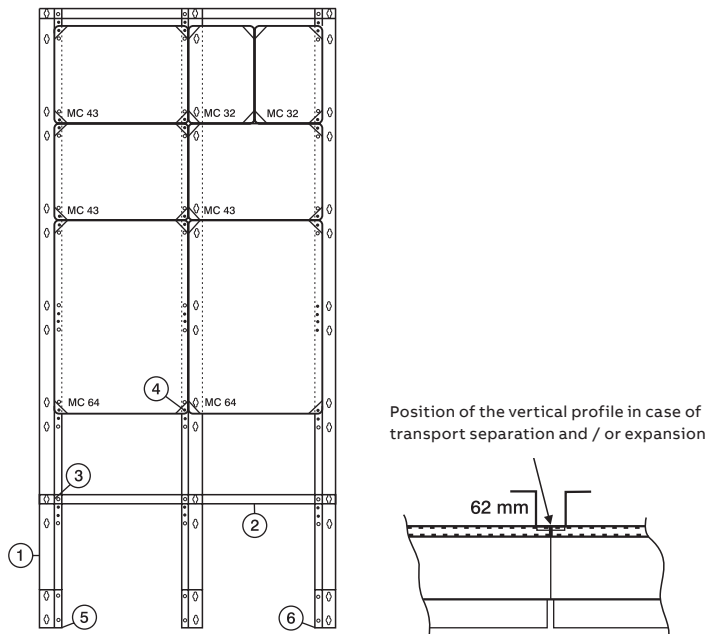

Z-Profile



C-Profile



M5x16 DIN 7500-C-TORX























Stand support

Accessories

	Type	Order code	Pack
① Vertical Z-profile - RAL 9001			
Aluzinc - L = 2 360mm, for 6 × 320	VXXFWNJ7	4TBV855515C0100	
Aluzinc - L = 2 040mm, for 5 × 320	VXXFWNJ8	4TBV855516C0100	
Aluzinc - L = 1 080mm, for 3 × 320	VXXFWNJ9	4TBV855517C0100	
Aluzinc - L = 760 mm, for 2 × 320	VXXFWNJ0	4TBV855518C0100	1
② Horizontal - C-profile			
Length = 3 000 mm	ACC811619	4TBC811619C0100	1
③ Fixation bracket			
Fixation bracket M5 × 16 mm to connect the vertical and horizontal profiles	VXXFWNJA	4TBV855519C0100	1
④ Screw			
M5x16 DIN 7500-C - TORX	VXXFWNJB	4TBV855520C0100	50
Stand support			
⑤ Left	VXXFWNJC	4TBV855521C0100	
⑥ Right	VXXFWNJD	4TBV855522C0100	1

General purpose enclosures

VMS - Modular insulated enclosures

Type	VMS 32	VMS 33	VMS 43	VMS 63	VMS 64
Enclosures for DIN equipment					
Without cover and combi end-plates for assembly of modular units.	 		  	    	    
Includes:					
- base with four open sides					
- mounting frame with earth-rail and cover plate					
- earth terminal					
DIN rail distance 125mm	(horizontal)		(horizontal)	(horizontal)	(vertical)
	14 modules	28 modules	40 modules	56 modules	80 modules
Type	V32BWDJ6	V33BWDJ6	V43BWDJ7	V63BWDJ6	V64BWDJ6
Order code	4TBV853125C0100	4TBV853127C0100	4TBV853266C0100	4TBV853267C0100	4TBV853268C0100
			(vertical)	(vertical)	
			42 modules	56 modules	
Type			V43BWDJ6	V63BWDJ6	
Order code			4TBV853129C0100	4TBV853131C0100	

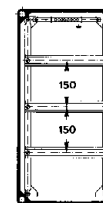
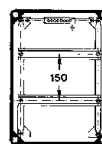
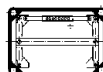

Enclosures for DIN equipment



Includes:

- base with four closed sides
- with combi end-plates:
 - at the top: 17 x M20
 - at the bottom: 1 x M50 / 40
 - + 2 x M40 / 32 + 8 x M25 / 20
- bare frame fitted with an earth terminal and cover plate
- transparent pivoting cover (VMS 43)
- transparent cover, attached with screws (VMS 32 - VMS 63)

	320 x 220 x 179 mm	440 x 320 x 179 mm	640 x 320 x 179 mm
	14 modules	28 modules	42 modules
Type	V32BTDJ7	V43BTDJ6	V63BTDJ7
Order code	4TBV853159C0100	4TBV853160C0100	4TBV853161C0100

General purpose enclosures

VMS - Modular insulated enclosures

Type	VMS 32	VMS 33	VMS 43	VMS 63	VMS 64
Metering enclosures Without cover and end-plates With installed meter board incl. meter fixation screws For covers and plates see selection table on pages 24/27 and 24/28					
			440 x 320 x 179 mm	640 x 320 x 179 mm	
Type			V43BWKJ6	V63BWKJ6	
Order code			4TBV853250C0100	4TBV853251C0100	

General purpose enclosures

VMS - Busbar system

Accessories

Product	Type	Order code	Pack
Flat configuration 125A / 250A - Parallel arrangement 250A			
	VXXSWNE5	4TBV853075C0100	10

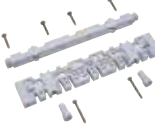
Flat configuration 125A / 250A - Parallel arrangement 400A			
	VXXSWNF5	4TBV853076C0100	10

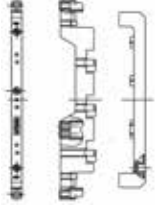



Flat configuration 60mm			
	160 up to 630A		
	VXXSW65	4TBV828322C0100	10

Product	Type	Order code	Pack
Parallel arrangement 630A / 1100A			
	5 pole 100%		
	VXBB855177N	4TBV855177C0100	10

Rail connector			
	1P, 630 A		
	VXXRWNG1	4TBV783267C0100	1

General purpose enclosures

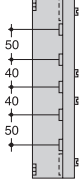
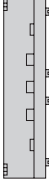
VMS - Busbar system 125 A–1 100 A

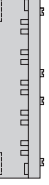
	Flat configuration		Parallel arrangement	
				
				
Rated nominal current in	125/160A		250A	250A
Busbar supports	VXXSWNE5			
Order code	4TBV853075C0100			
Pack	1	1	1	1
Center distance of phase bars (mm)	40	40	40	50
Distance between N or $\bar{\phi}$ and the closest phase (mm)	50	50	50	45
Busbars				
Number and dimensions of phase bars (L1 - L2 - L3)	1 x (12 x 5)	1 x (12 x 10)	2 x (12 x 5)	2 x (12 x 5)
Number and dimensions of bars N- $\bar{\phi}$	1 x (12 x 5)	1 x (12 x 5)	1 x (12 x 5)	2 x (12 x 5)
Section by phase (mm ²)	60	120	120	120
Section by N - $\bar{\phi}$ (mm ²)	60	60	60	120
Specifications				
Center distance of busbar supports (mm)	320	320	320	320
Dynamic short-circuit resistance (kA peak)	40	40	40	30
Dynamic short-circuit resistance (kA. eff.)	20	20	20	15

General purpose enclosures

VMS - Busbar system 125 A–1 100 A



400A



630A



630A



1100A

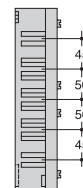

1100A

VXXSWNF5		VXXSWNI5		
4TBV853076C0100		4TBV853077C0100		
1	1	1	1	1
50	50	50	50	50
45	45	45	45	45
2 x (20x5)	2 x (20x10)	4 x (20x5)	2 x (30x10)	4 x (30x5)
2 x (12x5)	2 x (20x5)	2 x (20x5)	2 x (30x5)	2 x (30x5)
200	400	400	600	600
120	200	200	300	300
320	320/250	320/250	320	250
42	43.6/52.5	43.6/52.5	52.5	52.5
20	20.8/25	20.8/25	25	25

General purpose enclosures

VMS - Busbar system 125 A–1 250 A

Flat configuration

Product			Type	Order code	Pack	
Cable-bar connection sockets 12 × 5 / 12 × 10						
Main bar width	Cable section		Clamp width X (mm)	Cable clamp		
	(mm ²)					
	Min.	Max.				
5	1.5	16	11.5	APACC858026	4TBO858026C0100	20
5	1.5	35	15.5	APACC858028	4TBO858028C0100	10
5	16	70	20.5	APACC858032	4TBO858032C0100	10
5	16	120	23.5	APACC858033	4TBO858033C0100	10
10	1.5	16	11.5	APACC858027	4TBO858027C0100	20
10	1.5	35	15.5	APACC858029	4TBO858029C0100	10
10	16	70	20.5	APACC858030	4TBO858030C0100	10
10	16	120	30.5	APACC858031	4TBO858031C0100	10



General purpose enclosures

VMS - Parallel busbar arrangement

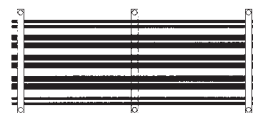
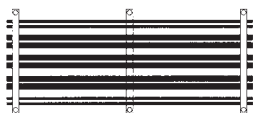

Type	Order code	Pack
Busbars with horizontal fixation		
Connecting blocks		
	For flat copper with widths of 25, 30 or 40 APACC858003 4TBO858003C0100	10
	For flat copper with widths of 20 or 25 APACC858004 4TBO858004C0100	10
	For flat copper with widths of 15 or 20 APACC858005 4TBO858005C0100	10



Anchor bolts																													
	For 5mm thick bars M10x60 APACC858008 4TBO858008C0100 10																												
	M10x80 APACC858010 4TBO858010C0100 10																												
	For 10mm thick bars M10x60 APACC858013 4TBV858013C0100 10																												
	M10x80 APACC858011 4TBO858011C0100 10																												
	<table border="1"> <thead> <tr> <th>b</th> <th>s</th> <th>x</th> <th>L</th> </tr> </thead> <tbody> <tr><td>12</td><td>5</td><td>40</td><td>60</td></tr> <tr><td>12</td><td>10</td><td>45</td><td>60</td></tr> <tr><td>20</td><td>5</td><td>48</td><td>60</td></tr> <tr><td>20</td><td>10</td><td>53</td><td>60</td></tr> <tr><td>30</td><td>5</td><td>58</td><td>60</td></tr> <tr><td>30</td><td>10</td><td>63</td><td>80</td></tr> </tbody> </table>	b	s	x	L	12	5	40	60	12	10	45	60	20	5	48	60	20	10	53	60	30	5	58	60	30	10	63	80
b	s	x	L																										
12	5	40	60																										
12	10	45	60																										
20	5	48	60																										
20	10	53	60																										
30	5	58	60																										
30	10	63	80																										

Type	Order code	Pack
Cable-bar connection sockets - 16-35-70-120mm²		
Wing contact block		
	APACC858006 4TBO858006C0100	10
	APACC858007 4TBO858007C0100	10



Anchor bolts																																									
	For 5mm thick rails M10x60 APACC858008 4TBO858008C0100 10																																								
	M10x80 APACC858010 4TBO858010C0100 10																																								
	For 10mm thick rails M10x60 APACC858013 4TBV858013C0100 10																																								
	M10x80 APACC858011 4TBO858011C0100 10																																								
	<table border="1"> <thead> <tr> <th>b</th> <th>s</th> <th>x</th> <th>L</th> </tr> </thead> <tbody> <tr><td>12</td><td>-</td><td>42</td><td>60</td></tr> <tr><td>12</td><td>5</td><td>47</td><td>60</td></tr> <tr><td>12</td><td>10</td><td>52</td><td>60</td></tr> <tr><td>20</td><td>-</td><td>50</td><td>60</td></tr> <tr><td>20</td><td>5</td><td>55</td><td>60</td></tr> <tr><td>20</td><td>10</td><td>60</td><td>60</td></tr> <tr><td>30</td><td>-</td><td>60</td><td>60</td></tr> <tr><td>30</td><td>5</td><td>65</td><td>80</td></tr> <tr><td>30</td><td>10</td><td>70</td><td>80</td></tr> </tbody> </table>	b	s	x	L	12	-	42	60	12	5	47	60	12	10	52	60	20	-	50	60	20	5	55	60	20	10	60	60	30	-	60	60	30	5	65	80	30	10	70	80
b	s	x	L																																						
12	-	42	60																																						
12	5	47	60																																						
12	10	52	60																																						
20	-	50	60																																						
20	5	55	60																																						
20	10	60	60																																						
30	-	60	60																																						
30	5	65	80																																						
30	10	70	80																																						



Koppelkit IP65 / IP54			
Cable clamps for fixing to the contact block wings			
Cable section mm ²	Cable section mm ²	Clamp width X (mm)	
Min.	Max.		
1.5	16	11.5	APACC858026 4TBO858026C0100 20
1.5	35	15.5	APACC858028 4TBO858028C0100 10
16	70	20.5	APACC858032 4TBO858032C0100 10
16	120	23.5	APACC858033 4TBO858033C0100 10

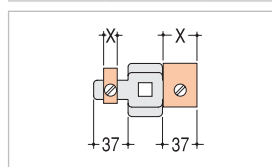

Legend:
 b: height of rectangular bars
 s: thickness of the rectangular bar or cable-shoe or flat copper
 x: minimum bolt length required
 L: length of fitting hook bolt or bolt with rectangular head

General purpose enclosures

ARIA - Universal polyester enclosures



ARIA

Applications

- Manufacturing
- Breweries
- Steelworks
- Public works
- Petro-chemical industry
- Road signage
- Temporary connections
- Telecoms
- Solar energy applications

Standard: EN/IEC 61439-2, EN/IEC 60529, EN/IEC 62262, EN/IEC 62208

Standards/Certification



- UL types 3, 3R, 3S, 4, 4X, 12 and 13
Available upon request.



- CSA types 3, 3R, 3S, 4, 4X, 12 and 13
Available upon request.

LR - Lloyd's Register of Shipping
(IP66 versions with center lock)

Specifications

- Seven different types, from 315x215 to 1035x835 mm.
- Enclosures made from light gray polyester (RAL 7035), hot press molded, glass fiber-reinforced, dyed in the mass.
- The enclosure is equipped with 4 threaded rods and 4 nuts for securing a mounting plate or frame and is equipped as standard with a double-bit key lock.
- Maximum protection for the user and equipment thanks to its total insulation \square and IP65/66 protection rating in accordance with EN/IEC 62208 (IP54 for enclosures with inspection windows).
- IK08 protection rating against external mechanical impacts in accordance with EN/IEC 62208 (IK07 for cabinets with windows).
- Polyester boxes can resist temperatures of up to 70°C under continuous operation and peak temperatures of up to 130 °C.
- Self-extinguishing polyester, halogen-free.
- Insulation voltage $U_i = 1000$ V ac and 1500 V dc.



General purpose enclosures







ARIA - Universal polyester enclosures

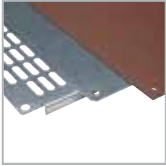

1. Monobloc base
2. Detachable door, left-hand or right-hand opening
3. No water stagnation on the seal
4. Mounting point in the door
5. Front plate:
 - polyester RAL 7035
 - hinged
 - detachable
 - stand-alone
 - sealable
 - quick installation
6. Interchangeable cylinders
7. Individual connection busbars
8. Mounting frame:
 - removable
 - perforated
 - reinforced DIN rails
9. Integral hinges 180° pivoting door
10. Mounting plate
 - metal
 - pertinax
 - perforated
11. Mounts directly onto the wall or via external mounting lugs made from stainless or synthetic material

General purpose enclosures

ARIA - Universal polyester enclosures

		☐	☐
		ARIA 32	ARIA 43
Individual front plates HxW x D		315x215x170	415 x 315 x 170
	Enclosure ☐ IP65 - IK08. With one or two double-bit, 3 mm locks two-point closure	Type - Order code 4TBA831035C0100	AR043P13 ⁽¹⁾ 4TBA831035C0100
	Enclosure with inspection window ☐ IP54 - IK07 With one or two double-bit, 3 mm locks	Type - Order code 4TBA831128C0100	AR043T33 4TBA831128C0100
	Enclosure ☐ IP66 - IK08 With 1 double-bit, 3 mm center lock three-point closure mechanism	Type AR032P13 ⁽¹⁾ Order code 4TBA831025C0100 ²	AR043P33 4TBA831036C0100 ²
	Enclosure with inspection window ☐ IP54 - IK07 with 1 double-bit, 3mm center lock	Type - Order code 4TBA831815C0100	AR043T23 4TBA831815C0100
	Enclosure ☐ IP66 - IK08 With 1 security lock handle	Type AR032T13 Order code 4TBA831307C0100	AR043H33 4TBA831034C0100 ²
	Mounting plates Dimensions HxW	250 x 150	350 x 250
	Pertinax 5 mm	Type AR032I03 Order code 4TBA831027C0100	AR043I03 4TBA831038C0100
	2 mm Sendzimir galvanized steel panel	Type AR032M03 Order code 4TBA831026C0100	AR043M03 4TBA831037C0100
	1.5 mm perforated metal panel	Type AR032Q03 Order code 4TBA831332C0100	AR043Q03 4TBA831333C0100
	Mounting frame	Type AR032D03 Order code 4TBA831030C0100	AR043D03 4TBA831041C0100
	Rows	2	2
	Modules	12	24
	Full cover plates Solid	Type AR032C03 Order code 4TBA831028C0100	AR043C03 4TBA831039C0100
	With openings for DIN rail equipment	Type AR032S03 Order code 4TBA831029C0100	AR043S03 4TBA831040C0100
	With openings for individual modular front plates	Type - Order code 4TBA831790C0100	AR043E03 4TBA831790C0100
	Number of individual modular front plates possible	-	2
Note: the ARIA 43 and 86 cabinets and ARIA 64 and 108 cabinets contain the same modular closure plates (Closed and with openings)			
	Individual front plates HxW	-	150 x 239
	IP20 individual modular protective plates (PVC) Solid	Type - Order code 4TBA831797C0100	AR043N03 4TBA831797C0100
	With openings for DIN rail equipment	Type - Order code 4TBA831796C0100	AR043R03 4TBA831796C0100
	Modules	-	12

(1) single-point closure
Pack = 1

(2) UL/CSA certified

General purpose enclosures



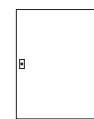

ARIA - Universal polyester enclosures









ARIA 54	ARIA 64	ARIA 75	ARIA 86	ARIA 108
515x415x230	615x415x230	735x535x270	835x635x300	1035x835x300
AR054P23	AR064P23	AR075P23	AR086P23	AR108P23
4TBA831809C0100	4TBA831810C0100	4TBA831811C0100	4TBA831059C0100	4TBA831073C0100
AR054T23	AR064T23	AR075T23	-	-
4TBA831812C0100	4TBA831813C0100	4TBA831814C0100		
two-point closure	two-point closure	two-point closure		
AR054P33	AR064P33	AR075P33	AR086P33	AR108P33
4TBA831052C0100 ²	4TBA831065C0100 ²	4TBA831081C0100 ²	4TBA831098C0100 ²	4TBA831112C0100 ²
AR054T33	AR064T33	AR075T33	AR086T33	AR108T33
4TBA831129C0100	4TBA831130C0100	4TBA831131C0100	4TBA831132C0100	4TBA831133C0100
AR054H33	AR064H33	AR075H33	AR086H33	AR108H33
4TBA831051C0100 ²	4TBA831064C0100 ²	4TBA831080C0100 ²	4TBA831097C0100 ²	4TBA831111C0100 ²
450 x 350	550 x 350	650 x 450	750 x 550	950 x 750
AR054I03	AR064I03	AR075I03	AR086I03	AR108I03
4TBA831054C0100	4TBA831067C0100	4TBA831083C0100	4TBA831100C0100	4TBA831114C0100
AR054M03	AR064M03	AR075M03	AR086M03	AR108M03
4TBA831053C0100	4TBA831066C0100	4TBA831082C0100	4TBA831099C0100	4TBA831113C0100
AR054Q03	AR064Q03	AR075Q03	AR086Q03	AR108Q03
4TBA831334C0100	4TBA831335C0100	4TBA831336C0100	4TBA831337C0100	4TBA831338C0100
AR054D03	AR064D03	AR075D03	AR086D03	AR108D03
4TBA831057C0100	4TBA831070C0100	4TBA831086C0100	4TBA831103C0100	4TBA831117C0100
3	3	4	4	5
54	54	88	96	180
AR054C03	AR064C03	AR075C03	AR086C03	AR108C03
4TBA831055C0100	4TBA831068C0100	4TBA831084C0100	4TBA831101C0100	4TBA831115C0100
AR054S03	AR064S03	AR075S03	AR086S03	AR108S03
4TBA831056C0100	4TBA831069C0100	4TBA831085C0100	4TBA831102C0100	4TBA831116C0100
AR054E03	AR064E03	AR075E03	AR086E03	AR108E03
4TBA831791C0100	4TBA831792C0100	4TBA831793C0100	4TBA831794C0100	4TBA831795C0100
3	3	4	8	10
150 x 343	150 x 343	150 x 239	150 x 239	150 x 343
AR054N03	AR064N03	AR075N03	AR043N03	AR064N03
4TBA831799C0100	4TBA831801C0100	4TBA831803C0100	4TBA831797C0100	4TBA831801C0100
AR054R03	AR064R03	AR075R03	AR043R03	AR064R03
4TBA831798C0100	4TBA831800C0100	4TBA831802C0100	4TBA831796C0100	4TBA831800C0100
17	18	22	12	18

General purpose enclosures







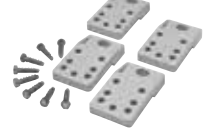

ARIA - Universal polyester enclosures - Accessories

Product	Type	Order code	Pack
Locks			
With interchangeable cylinders (Supplied with 1 key)			
3mm			
	AR831008	4TBA831008C0100	1
8mm			
	AR831005	4TBA831005C0100	1
8mm			
	AR831006	4TBA831006C0100	1
11mm			
	AR831007	4TBA831007C0100	1
Other locks: please contact us.			

Product	Type	Order code	Pack
Handles			
Neutral handle (without lock)			
	AR831003	4TBA831003R0100	1
With lock and 2 keys V2432E			
	AR831004	4TBA831004R0100	1
With lock and 2 keys 1242E			
	AR831180	4TBA831180R0100	1
With lock and 2 keys 405E			
	AR831152	4TBA831152C0100	1
With lock and 2 keys 455E			
	AR831153	4TBA831153C0100	1
Handle for lock, 45 mm semi-cylindrical profile			
	AR831821	4TBA831821C0100	1
For replacing a double-bit lock or other locks for Aria 54, a mechanical adaptation of the door openings is required.			
Handle for lock with semi-cylindrical profile and locking by padlock			
	AR831822	4TBA831822C0100	1
For replacing a double-bit lock or other locks for Aria 54, a mechanical adaptation of the door openings is required.			

Product	Type	Order code	Pack
Fixing lugs⁽¹⁾			
In 304 grade stainless steel			
Set of 4 pieces			
	ARACCB03	4TBA831000C0100	1
Set of 4 polyamide pieces			
	ARACCB13	4TBA831001C0100	1
(1) not supplied as standard			

Product	Type	Order code	Pack
Hinge supports for inner door			
Set of 2 pieces, for front plate			
	AR831010	4TBA831010C0100	1
A lower door may be installed together with a closed front plate.			

Product	Type	Order code	Pack
Profile half cylinder locks			
Standard: D = 40 mm - L = 30.5 mm			
With 2 keys V2432-E			
	PS832030	4TBP832030C0100	1
Replacement keys for 832030			
	PS832741	4TBP832741R0100	2
With 2 keys 1242-E			
	PS832031	4TBP832031C0100	1
With 2 keys 455-E			
	PS832465	4TBP832465C0100	1
With 2 keys 405-E			
	PS832466	4TBP832466R0100	1
With a replacement key, 8 mm			
	PS832032	4TBP832032C0100	1
With an 8 mm triangular key			
	PS832033	4TBP832033C0100	1
With an 11 mm triangular key			
	PS832034	4TBP832034C0100	1
With 3 mm double-bit key			
	PS832029	4TBP832029C0100	1

Product	Type	Order code	Pack
Vents			
(IP44 if fitting in the double corner)			
Set of 2 ventilation grilles.			
Bore hole Ø 34.9 mm			
	AR831009	4TBA831009C0100	1
See Sect. Cabinet ventilation for additional ventilation options.			

General purpose enclosures

ARIA - Universal polyester enclosures - Accessories

Product	Type	Order code	Pack
Pole mounting assembly			
	For ARIA 54/64		
	AR891608	4TBA891608C0100	1
	Fixing lugs in stainless steel included. Steel strips not included.		

Product	Type	Order code	Pack
Self-adhesive drip molding profile			
	Length 415 mm for ARIA 54 and 64		
	AR831530	4TBA831530C0100	1
	May also be used for ARIA 32 and 43 after cutting out.		
	Length 835 mm for ARIA 108		
AR831533	4TBA831533C0100	1	
May also be used for ARIA 75 and 86 after cutting out.			

Product	Type	Order code	Pack
Module covers			
	Sectionable by 1/2 module		
	12 modules		
	FORSTBP4	4TBR610142C0200	5
	4 modules		
FORSTBP500	4TBR610484C0200	500	

Product	Type	Order code	Pack
Label holders			
	Adhesive		
	ZA10	4TBC851321C0100	1m

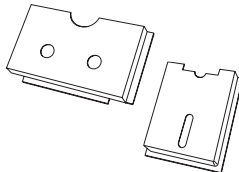
Product	Type	Order code	Pack
Document pocket			
	DIN A4 - LxH = 325x180 mm		
	AR811516	4TBC811516C0100	1
	DIN A5 - LxH = 155x225 mm		
	PS832000	4TBP832000C0100	1

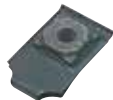
Product	Type	Order code	Pack
Slide nuts			
For perforated mounting plate			
	M4		
	AR831328	4TBA831328C0100	50
	M5		
	AR831329	4TBA831329C0100	50
	M6		
AR831330	4TBA831330C0100	50	

Product	Type	Order code	Pack
Hinge pins			
	Length 66 mm for ARIA 32		
	AR831653	4TBA831653C0100	20
	Length 100.5 mm for ARIA 43, 54 and 64		
AR831652	4TBA831652C0100	20	
	Length 131.5 mm for ARIA 75, 86 and 108		
AR831953	4TBA831953C0100	10	

General purpose enclosures

PolySafe - Multi-function polyester enclosures



PolySafe

Standards/Certification



- Single-door enclosure: type 3, 3R, 3S, 4, 4X, 12, 12K and 13
- Double-door enclosure: type 3R
- Coupled enclosures: type 3, 3R, 3S, 4, 4X, 12, 12K and 13 Available upon request.

LR - Lloyd's Register of Shipping

Standard: EN/IEC 60529, EN/IEC 61439-2, EN/IEC 62208, EN/IEC 62262

Specifications

- 16 standard dimensions (from 500x500 mm to 1250x1000 mm) with a depth of 320 mm.
- Enclosures supplied assembled (empty or equipped).
- IP55 and IP65 high protection ratings in accordance with EN/IEC 60529 and IK10 (20J) in accordance with EN/IEC 62262.
- Protection rating for enclosure with inspection window: IP54-IP65.
- Material: polyester reinforced with glass fiber, halogen-free, hot press molded and self-extinguishing.
- Color: RAL 7035 gray, dyed in the mass.
- Designed for wall, floor or pedestal mounting.
- Option of stacking vertically or horizontally widthwise or depthwise.
- Total insulation \square .
- 5-point door closure mechanism.
- Optional version on a DIN base.
- Insulation voltage $U_i = 1000 \text{ V ac}$ and 1500 V dc
- Product is easy to recycle: no molded metal parts.

Conditions for use

Polyester boxes can withstand temperatures between -25°C et $+70^\circ\text{C}$ under continuous operation and peak temperatures of up to 130°C .



General purpose enclosures

PolySafe - Multi-function polyester enclosures



Applications

- Commercial
Leisure (marketplaces, camps, leisure ports, attraction parks, etc.), gas stations, carwashes, laundromats, industrial laundries, construction site enclosures, etc.
- Industrial
Ship building, mining, automobile industry, paper industry, sugar refinery, food industry, distilleries, petrochemical industry, heavy industry, processing, surveillance systems, etc.
- Utilities
Water treatment sites, gray water processing, telecommunications, traffic signaling, traffic management, public transport, energy distribution (electricity, gas, water), cable television, public lighting, railways, etc.



General purpose enclosures

PolySafe - Universal polyester enclosures



Depth = 320 mm

PS 220

Factory-assembled enclosures

Equipped with AISI 304 stainless steel fixing lugs and handle (lock not supplied)

Dimensions (HxL)	500 x 500
Enclosure with IP55 solid door	Type PS833194 Order code 4TBP833194N0100
Enclosure with IP65 solid door	Type PS220P63 Order code 4TBP833000C0100 ⁽¹⁾
Enclosure with IP54 inspection window (polycarbonate inspection window)	Type PS220T43 Order code 4TBP833850C0100
Weight (kg)	16



IP65 depth extension kit

For increasing the standard depth of the enclosure from 320 mm to 640 mm. The kit comprises 2 side panels, 1 upper panel, 1 lower panel, 2 rear open panels (frames).

Type	PS220D63
Order code	4TBP833584C0100



Hoods

Necessary if efficient (IP44) ventilation is required, includes drilled holes in the upper panel and the use of fins.

Type	PS200R03
Order code	4TBP833566C0100

The basic enclosure is IP65 rated, the hood is optional. If larger widths or depths are required, please contact us.

Base for ground installation

The enclosure and base are anchored together into the ground. H = 65 mm

Type	PS200Z03
Order code	4TBP833574C0100

Adaptor frame for DIN-base mounting

The enclosure and adaptation kit are anchored together onto the DIN socket (polyester)

Type	-
Order code	-
DIN base	Type EH3SEXEI
Polyester - RAL 7035	Order code 4TBE843204R0100



Mounting plates

Dimensions (H - 110 mm x L - 110 mm)

2 mm Sendzimir galvanized sheet metal	Type PS220M03 Order code 4TBP833500C0100
Pertinax 5 mm	Type PS220I03 Order code 4TBP833508C0100
Pertinax 10mm	Type - Order code -



(1) UL/CSA certified

General purpose enclosures

PolySafe - Universal polyester enclosures

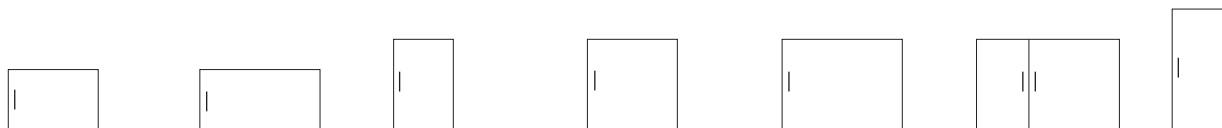

PS 230	PS 240	PS 320	PS 330	PS 340	PS 352	PS 420
500 x 750	500 x 1000	750 x 500	750 x 750	750 x 1000	750 x 1250	1000 x 500
PS833195	-	PS833196	PS833197	PS833198	PS833235 (*)	PS833199
4TBP833195N0100		4TBP833196N0100	4TBP833197N0100 ¹	4TBP833198N0100 ¹	4TBP833235N0100 ¹	4TBP833199N0100
PS230P63	PS240P63	PS320P63	PS330P63	PS340P63	PS352P63	PS420P63
4TBP833004C0100 ¹	4TBP833193C0100 ¹	4TBP833008C0100 ¹	4TBP833012C0100 ¹	4TBP833016C0100 ¹	4TBP833020C0100 ¹	4TBP833024C0100 ¹
PS230T43	-	PS320T43	PS330T43	PS340T43	PS352T43	PS420T43
4TBP833851C0100		4TBP833852C0100	4TBP833853C0100	4TBP833854C0100	4TBP833855C0100	4TBP833856C0100
19	25	20	25	30	38	25
PS230D63	-	PS320D63	PS330D63	PS340D63	PS350D63	PS420D63
4TBP833585C0100		4TBP833586C0100	4TBP833587C0100	4TBP833588C0100	4TBP833589C0100	4TBP833590C0100
PS300R03	PS400R03	PS200R03	PS300R03	PS400R03	PS500R03	PS200R03
4TBP833568C0100	4TBP833570C0100	4TBP833566C0100	4TBP833568C0100	4TBP833570C0100	4TBP833572C0100	4TBP833566C0100
PS300Z03	PS400Z03	PS200Z03	PS300Z03	PS400Z03	PS500Z03	PS200Z03
4TBP833575C0100	4TBP833576C0100	4TBP833574C0100	4TBP833575C0100	4TBP833576C0100	4TBP833577C0100	4TBP833574C0100
PS300A03	PS400A03	-	PS300A03	PS400A03	-	-
4TBP833582C0100	4TBP833583C0100		4TBP833582C0100	4TBP833583C0100		
EH3SE1EI	EH3SE2EI	EH3SEXEI	EH3SE1EI	EH3SE2EI	-	EH3SEXEI
4TBE843206R0100	4TBE843207R0100	4TBE843204R0100	4TBE843206R0100	4TBE843207R0100		4TBE843204R0100
PS320M03	PS420M03	PS320M03	PS330M03	PS430M03	PS530M03	PS420M03
4TBP833501C0100	4TBP833503C0100	4TBP833501C0100	4TBP833502C0100	4TBP833504C0100	4TBP833506C0100	4TBP833503C0100
PS320I03	PS420I03	PS320I03	PS330I03	PS430I03	PS530I03	PS420I03
4TBP833509C0100	4TBP833511C0100	4TBP833509C0100	4TBP833510C0100	4TBP833512C0100	4TBP833514C0100	4TBP833511C0100
-	-	-	-	-	PS833385	-
					4TBP833385N0100	

(*) on request

General purpose enclosures

PolySafe - Universal polyester enclosures



Depth = 320 mm

PS 430

Factory-assembled enclosures

Equipped with AISI 304 stainless steel fixing lugs and handle (lock not supplied)

Dimensions (HxL)	1000 x 750
Enclosure with IP55 solid door	Type PS833204 Order code 4TBP833204N0100 ²
Enclosure with IP65 solid door	Type PS430P63 Order code 4TBP833028C0100 ²
Enclosure with IP54 inspection window (polycarbonate inspection window)	Type PS430T43 Order code 4TBP833857C0100
Weight (kg)	30



IP65 depth extension kit

For increasing the standard depth of the enclosure from 320 mm to 640 mm. The kit comprises 2 side panels, 1 upper panel, 1 lower panel, 2 rear open panels (frames).

Type	PS430D63
Order code	4TBP833591C0100



Hoods

Necessary if efficient (IP44) ventilation is required, includes drilled holes in the upper panel and the use of fins.

Type	PS300R03
Order code	4TBP833568C0100

The basic enclosure is IP65 rated, the hood is optional. If larger widths or depths are required, please contact us.

Base for ground installation

The enclosure and base are anchored together into the ground. H = 65 mm

Type	PS300Z03
Order code	4TBP833575C0100

Adaptor frame for DIN-base mounting

The enclosure and adaptation kit are anchored together onto the DIN socket (polyester)

Type	PS300A03
Order code	4TBP833582C0100

DIN base

Polyester - RAL 7035

Type	EH3SE1EI
Order code	4TBE843206R0100



Mounting plates

Dimensions (H - 110 mm x L - 110 mm)

2 mm Sendzimir galvanized sheet metal

Pertinax 5 mm

Pertinax 10mm

Type	PS430M03
Order code	4TBP833504C0100
Type	PS430I03
Order code	4TBP833512C0100
Type	-
Order code	



General purpose enclosures

PolySafe - Universal polyester enclosures

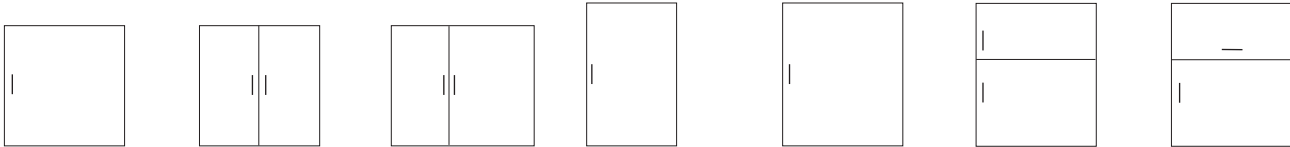

PS 440	PS 442	PS 452	PS 530	PS 540 ⁽¹⁾	PS 542	PS 546
1000 x 1000	1000 x 1000	1000 x 1250	1250 x 750	1250 x 1000	1250 x 1000	1250 x 1000
PS833212	PS442P53 (*)	PS452P53 (*)	PS833233	PS833889	PS542P53 (*)	-
4TBP833212N0100 ²	4TBP833241C0100 ²	4TBP833242C0100 ²	4TBP833233N0100 ²	4TBP833889C0100	4TBP833243C0100 ²	-
PS440P63	PS442P63	PS452P63	PS530P63	-	PS542P63	PS833056
4TBP833032C0100 ²	4TBP833036C0100 ²	4TBP833040C0100 ²	4TBP833044C0100 ²	-	4TBP833052C0100 ²	4TBP833056C0100 ²
-	PS442T43	PS452T43	PS530T43	-	PS542T43	-
-	4TBP833858C0100	4TBP833859C0100	4TBP833860C0100	-	4TBP833861C0100	-
36	39	41	37	42	45	45
PS440D63	PS440D63	PS833593	PS530D63	-	PS540D63	PS540D63
4TBP833592C0100	4TBP833592C0100	4TBP833593C0100	4TBP833594C0100	-	4TBP833595C0100	4TBP833595C0100
PS400R03	PS400R03	PS500R03	PS300R03	PS400R03	PS400R03	PS400R03
4TBP833570C0100	4TBP833570C0100	4TBP833572C0100	4TBP833568C0100	4TBP833570C0100	4TBP833570C0100	4TBP833570C0100
PS400Z03	PS400Z03	PS500Z03	PS300Z03	PS400Z03	PS400Z03	PS400Z03
4TBP833576C0100	4TBP833576C0100	4TBP833577C0100	4TBP833575C0100	4TBP833576C0100	4TBP833576C0100	4TBP833576C0100
PS400A03	PS400A03	-	PS300A03	PS400A03	PS400A03	PS400A03
4TBP833583C0100	4TBP833583C0100	-	4TBP833582C0100	4TBP833583C0100	4TBP833583C0100	4TBP833583C0100
EH3SE2EI	EH3SE2EI	-	EH3SE1EI	EH3SE2EI	EH3SE2EI	EH3SE2EI
4TBE843207R0100	4TBE843207R0100	-	4TBE843206R0100	4TBE843207R0100	4TBE843207R0100	4TBE843207R0100
PS440M03	PS440M03	PS540M03	PS530M03	PS540M03	PS540M03	PS540M03
4TBP833505C0100	4TBP833505C0100	4TBP833507C0100	4TBP833506C0100	4TBP833507C0100	4TBP833507C0100	4TBP833507C0100
PS440I03	PS440I03	PS540I03	PS530I03	PS540I03	PS540I03	PS540I03
4TBP833513C0100	4TBP833513C0100	4TBP833515C0100	4TBP833514C0100	4TBP833515C0100	4TBP833515C0100	4TBP833515C0100
PS833386	PS833386	PS833387	PS833385	PS833387	PS833387	PS833387
4TBP833386C0100	4TBP833386C0100	4TBP833387C0100	4TBP833385N0100	4TBP833387C0100	4TBP833387C0100	4TBP833387C0100

(1) PolySafe PS540 only available in IP54 execution
(*) on request

General purpose enclosures

PolySafe - Modular framework for DIN-rail equipment - IP20



Supplied as a self-assembly kit

Kit contains:

- 2 x support for left-hand vertical profile
- 2 x support for right-hand vertical profile
- 2 x vertical profiles
- 2 x IP20 insulated vertical profiles
- 2 x IP20 insulated horizontal profiles
- assembly accessories

Product	Type	Order code
---------	------	------------

2 rows		
	40 mod. - HxL = 500x500	
	PS220F03	4TBP833264C0100
	68 mod. - HxL = 500x750	
	PS230F03	4TBP833265C0100

Product	Type	Order code
---------	------	------------

4 rows		
	80 mod. - HxL = 750x500	
	PS320F03	4TBP833266C0100
	136 mod. - HxL = 750x750	
	PS330F03	4TBP833267C0100

6 rows		
--------	--	--

	120 mod. - HxL = 1000x500	
	PS420F03	4TBP833268C0100
	204 mod. - HxL = 1000x750	
	PS430F03	4TBP833269C0100

7 rows		
--------	--	--

	238 mod. - HxL = 1250x750	
	PS530F03	4TBP833270C0100

General purpose enclosures

PolySafe - Modular functions and accessories

Modular functions for DIN equipment (to be mounted on the modular frame)



Contents:
- DIN rail
- cover plate with rectangular opening
- mounting accessories

Center line distance 150mm

Height	Width	500mm	750mm
150mm			
	Modules (1 mod. = 18mm)	20	34
	Type	PS833272	PS833278
	Order code	4TBP833272C0100	4TBP833278C0100

Modular functions for terminals or other equipment (to be mounted on the modular frame)



Contents:
- DIN rail
- solid cover plate
- mounting accessories

Center line distance 150mm

Height	Width	500mm	750mm
150mm			
	Type	PS833271	PS833277
	Order code	4TBP833271C0100	4TBP833277C0100
300mm			
	Type	PS833274	PS833280
	Order code	4TBP833274C0100	4TBP833280C0100

Accessories (to be mounted on the modular frame)







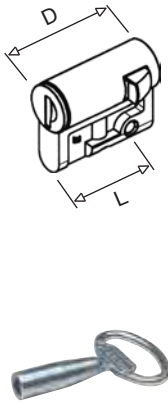

Product	Type	Order code	Pack
Metal mounting plates			
	HxL = 150x500mm	PS833275	4TBP833275C0100
	HxL = 150x750mm	PS833281	4TBP833281C0100
	HxL = 300x500mm	PS833276	4TBP833276C0100
	HxL = 300x750mm	PS833282	4TBP833282C0100

Accessories (to be mounted on the modular frame)

Product	Type	Order code	Pack	
Depth extension studs for metal mounting plates with n. 2 M5x10 screws - (1 set = 2 pieces)				
	Length 20-35-50mm	VMW2050	4TBW828059C0100	
	Length 25-40-55mm	VMW2555	4TBW828060C0100	
	Length 30-45-60mm	VMW3060	4TBW828061C0100	
	Length 65-80-95mm	VMW6595	4TBW828062C0100	
	Length 70-85-100mm	VMW70100	4TBW828063C0100	
	Length 75-90-105mm	VMW75105	4TBW828064C0100	
	Length 110-125-140mm	VMW110	4TBW828031C0100	

General purpose enclosures



PolySafe - Accessories

Product	Type	Order code	Pack
Profile half cylinder locks			
Standard: D = 40 mm - L = 30.5 mm			
	With 2 keys V2432-E		
	 PS832030	4TBP832030C0100	1
	Replacement keys for PS832030		
	PS832741	4TBP832741R0100	2
	With 2 keys 1242-E		
	 PS832031	4TBP832031C0100	1
	With 2 keys 455-E		
	 PS832465	4TBP832465C0100	1
	With 2 keys 405-E		
	 PS832466	4TBP832466R0100	1
With 1 square key, 8 mm			
 PS832032	4TBP832032C0100	1	
With an 8 mm triangular key			
 PS832033	4TBP832033C0100	1	
With an 11 mm triangular key			
 PS832034	4TBP832034C0100	1	
With 1 double-bit key, 3 mm			
 PS832029	4TBP832029C0100	1	

Handle			
	For lock with half cylinder profile (as replacement)		
	PS833629	4TBP833629C0100	1

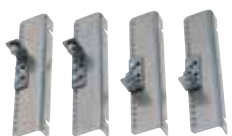
Padlocking handle			
	For padlock (Ø10mm max.)		
	PS833630	4TBP833630R0100	1

Depth adjustment kit			
	Set of 4 brackets for adjusting the depth of the mounting plates (12.5 mm increments)		
	PS833528	4TBP833528C0100	1

Product	Type	Order code	Pack
Door stop/Canopy stop			
Opening angle of 100° of the door or canopy (for >750-wide enclosures)			
	Left turning		
	PS833649	4TBP833649C0100	1
	Right turning		
	PS833650	4TBP833650C0100	1

Wall mounting supports for standard cabinets			
	Kit comprising 4 fixing lugs that clip into the rear of the enclosure. In Type 304 grade stainless steel. (replacement)		
	PS833651	4TBP833651C0100	1

Wall fixing lugs for enclosures equipped with a hood.			
	Kit comprising 4 fixing lugs that clip into the rear of the enclosure.		
	PS833624	4TBP833624C0100	1

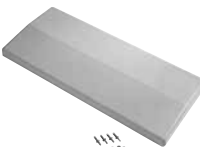
Rainhood			
	Rainhoods for enclosure combinations. Standard rainhoods in the enclosure selection tables.		

For enclosures dimensions (WxD)			
1500x320mm	PS833656	4TBP833656C0100	1
1750x320mm	PS833657	4TBP833657C0100	1
2000x320mm	PS833658	4TBP833658C0100	1
2250x320mm	PS833659	4TBP833659C0100	1
2500x320mm	PS833660	4TBP833660C0100	1
3000x320mm	PS833661	4TBP833661C0100	1
500x640mm	PS833693	4TBP833693C0100	1
750x640mm	PS833692	4TBP833692C0100	1
1000x640mm	PS833783	4TBP833783C0100	1
1250x640mm	PS833784	4TBP833784C0100	1
1750x640mm	PS833743	4TBP833743C0100	1
2000x640mm	PS833691	4TBP833691C0100	1
2500x640mm	PS833764	4TBP833764C0100	1

General purpose enclosures

PolySafe - Accessories

Product	Type	Order code	Pack
---------	------	------------	------

Pole mounting



Width = 500 mm

PS833625 4TBP833625C0100 1

Width = 750 mm

PS833626 4TBP833626C0100 1

By C profiles, at the rear of the enclosure and affixed to the lugs.

Metal sheet is used for securing to the pedestal.

Securing clamps are attached to the profiles to ensure that the metal sheet is held fast.



IP65/IP54 coupling kit

H/B	G	J	Depth 320 mm	
500	330	6	PS833608	4TBP833608R0100 1
750	580	8	PS833610	4TBP833610R0100 1
1000	830	12	PS833612	4TBP833612R0100 1
1250	1080	14	PS833614	4TBP833614R0100 1

The kit contains the neoprene seal and the securing screws.

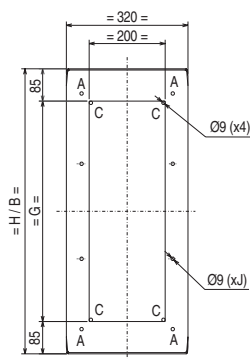
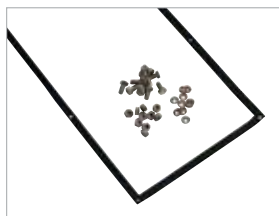

Corner profile

To fill up the corner between two coupled enclosures

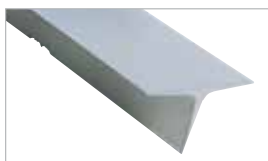

Length = 308 mm

PS833653 4TBP833653R0100 1

Use 2 profiles when coupling n.4 enclosures

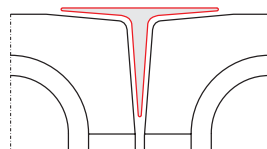

Product	Type	Order code	Pack
---------	------	------------	------

IP20 inner door

HxW

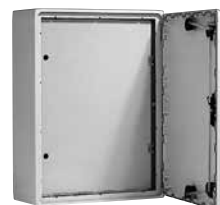

500x500 mm

PS833556 4TBP833556C0100 1

500x750 mm

PS833557 4TBP833557C0100 2

750x500 mm

PS833558 4TBP833558C0100 1

750x750 mm

PS833559 4TBP833559C0100 1

1000x500 mm

PS833561 4TBP833561C0100 1

1000x750 mm

PS833562 4TBP833562C0100 1

Frame and door with two double-bit closures. For control and automation applications.



Solid front plates for 19"/ETSI frame

For filling remaining empty spaces

For cabinets H x W = 500 x 750

Front plate height = 32 mm

PS833684 4TBP833684C0100 1

For cabinets H x W = 750 x 750

Front plate height = 15 mm

PS833685 4TBP833685C0100 1

For cabinets H x W = 1250 x 750

Front plate height = 28 mm

PS833686 4TBP833686C0100 1

Metal: RAL 7035 epoxy coating

Note: not required for H x W

= 1000 x 750 cabinets

General purpose enclosures

PolySafe - Accessories

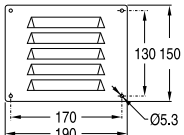
Product	Type	Order code	Pack
Ventilation grille 			
	PS832019	4TBP832019C0100	1
Adaptable to the ventilation opening. Kit comprises 2 grilles and 4 nylon screws.			
			

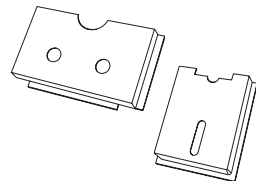
Product	Type	Order code	Pack
Document pocket 			
	DIN A4 - BxL = 325x180mm		
	AR811516	4TBC811516C0100	1
	DIN A5 - BxL= 155x225mm		
	PS832000	4TBP832000C0100	1

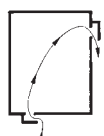
Product	Type	Order code	Pack
Air vents IP44 			
	Set of 2 polyamide pieces RAL 7035		
	PS833677	4TBP833677C0100	1
2 fins must be provided per enclosure in order to provide efficient ventilation and to prevent the formation of condensation. Supplied with a template and fixings. It is recommended to install the fins in the upper and lower sections of the enclosure.			
			

Product	Type	Order code	Pack
Screws 			
	Mounting plate installation kit (8 nuts and bolts).		
	PS833790	4TBP833790C0100	1 set
7.2 x 22 + M8 x 19 assembly screws for assembling the mounting plate and side panel with the lower panel/hood.			
	PS833687	4TBP833687C0100	100
7.2 x 22 securing screw for rear panel			
	PS833688	4TBP833688C0100	100

General purpose enclosures

PolySafe - accessories

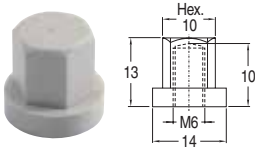
Product	Type	Order code	Pack
Nut made from insulating material			
	RAL 7035		
	KIM601225	4TBC601225C0100	100

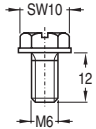
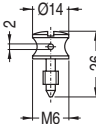
Screws			
	M6 flange screw		
	ACC811483	4TBC811483C0100	100
	PVC M6 screw for cover plate (sealable)		
	ACC811451	4TBC811451R0100	100

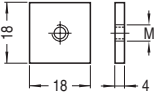

Metal nut			
	M6		
	ACC811435	4TBC811435C0100	100
	M4		
	ACC811438	4TBC811438C0100	100
	M6		
	ACC811446	4TBC811446C0100	100
	M8		
	ACC811447	4TBC811447C0100	100

General purpose enclosures

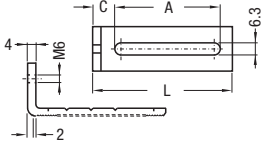
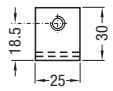
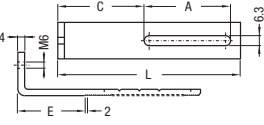
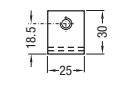
PolySafe - accessories

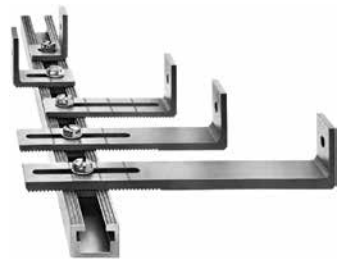
Product	Type	Order code	Pack
Brackets			
	L = 40 - A = 24 - C = 9,5	ACC811478	4TBC811478R0100 100
	L = 80 - A = 64 - C = 9,5	ACC811479	4TBC811479R0100 100
	L = 120 - A = 64 - C = 49,5 - E = 41.5	ACC811480	4TBC811480C0100 100
			
			
			

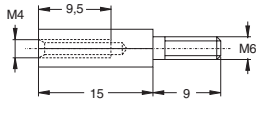
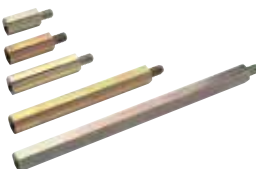
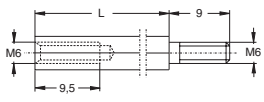

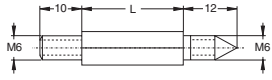
Product	Type	Order code	Pack	
Spacers				
Type 1 - M4-M6				
	L = 15	ACC811336	4TBC811336C0100 100	
				
Type 2 - M6-M6				
	L = 15	ACC811337	4TBC811337C0100 100	
	L = 20	ACC811338	4TBC811338C0100 100	
	L = 25	ACC811454	4TBC811454R0100 100	
	L = 30	ACC811339	4TBC811339C0100 100	
	L = 35	ACC811455	4TBC811455R0100 100	
	L = 45	PS811456	4TBP811456R0100 100	
	L = 55	ACC811457	4TBC811457R0100 100	
	L = 65	ACC811458	4TBC811458R0100 100	
	L = 70	ACC811340	4TBC811340C0100 100	
	L = 80	ACC811460	4TBC811460R0100 100	
	L = 100	ACC811461	4TBC811461R0100 100	
	L = 120	ACC811341	4TBC811341C0100 100	
				
	Type 3 - M6-M6			
	L = 60	ACC811342	4TBC811342C0100 100	
	L = 30	ACC811343	4TBC811343C0100 100	
				

General purpose enclosures

Accessories - Heater units

Function

Small heaters for electrical enclosures are important accessories for ensuring the operational safety of control and distribution assemblies.

They are essentially used to prevent the formation of condensation or to ensure that a minimum temperature is maintained inside the electrical enclosures, i.e. at a few degrees above ambient temperature.

Operating principle

The small heaters are equipped with PTC heating resistors (semiconductors with a positive temperature coefficient). The self-regulating and self-limiting semiconductor heating elements maintain a constant temperature over the heating surface of the small heaters. The aluminum body transfers heat to the surrounding air through natural radiation. Special extruded profiles guarantee perfect heat radiation.

Calculation model for determining the power requirement

According to the formula: $P = A \times \Delta T \times k$

- P = power to be supplied via the resistor (W)
- A = exterior free surface of the enclosure (m²)
- ΔT = temperature difference between the interior temperature after heating and the exterior temperature in °K.
- k = thermal radiation coefficient:
 - steel: 5.5 W/m²K
 - polyester: 3.5 W/m²K

Rule of thumb: recommended value 100 W/m³ of enclosure volume. The calorific value must be doubled for an exterior installation. Multiple small heaters are preferable to a single heater unit.

Advantages

- Energy efficiency
- Dynamic heating
- Self-regulating
- Self-limiting
- Quick clip-in fitting
- Zero maintenance
- Long service life
- Compact unit

Standards

EN 60335-1 / EN 62233
UL
EAC

Applications

Electrical enclosures, instrumentation units, display panels, control cabinets, ATM machines, access control system for parking lots, etc.

Installation

Quick installation on 35 mm DIN rail (EN 50 022). Recommended installation in the lower section of the enclosure, at least 40 mm from the equipment itself.



General purpose enclosures

Accessories - Heater units



CSK 060



CS 060



CSF 060

CSK 060

Small heating resistor for compact boxes and enclosures, to prevent the formation of condensation or temperatures below a minimum threshold. The resistors have been designed for permanent use.

CS 060 / CSF 060

Compact heating resistor to regulate the temperature of cabinets and enclosures containing electrical and electronic components. Due to its construction, it produces optimized natural convection, which generates an effective flow of hot air. The plastic casing has been designed so that the surface temperature remains low. The heating resistor is equipped by default with a fixed-range thermostat. The thermostat connects directly to the heating resistor and requires no additional wiring. The resistors have been designed for permanent use. The resistor is also available as a version without a thermostat (CS 060 series).

Technical specifications

Nominal voltage	120-240 V ⁽¹⁾ AC/DC (min. 110 V, max. 265 V)
Heating element	PTC resistor, self-regulating
Surface temperature	< +85°C (+185°F) (in accordance with VDE 0100), except for the protective grille
Connection	2.5 mm ² 2-pole terminal, max. tightening torque 0.8 Nm
Box	plastic material in accordance with UL94 V-0, black
Attachment	clip for 35 mm DIN rail, EN 60715
Installation	vertical air flow (blowing upwards/connection below)
Operating/storage temperature	-45 to +70°C (-49 to +158°F)
Operating/storage humidity	max. 90% RH (condensation-free)
Protection rating	IP20/class II (double insulation)
Certification	VDE, UL, EAC
Note:	other voltage options upon request

(1) For power supplies below 140 V AC/DC, heat production is reduced by 10%.

Ordering information CSK 060, CS 060

	W ⁽¹⁾	I max. (A)	H x W x D (mm)	Weight (kg)	Type	Order code	Pack
CSK 060	10	0.8	98 x 38 x 75	0.2	ACC818225	4TBJ818225C0100	1
	20	2.5	98 x 38 x 75	0.3	ACC818226	4TBJ818226C0100	1
CS 060	50	2.5	110 x 60 x 90	0.3	ACC818227	4TBJ818227C0100	1
	100	4.5	110 x 60 x 90	0.5	ACC818228	4TBJ818228C0100	1
	150	8	150 x 60 x 90	0.5	ACC818229	4TBJ818229C0100	1

(1) Bij omgevingstemperatuur van 20°C

Ordering information CSF 060

W ⁽¹⁾	I max. (A)	H x W x D (mm)	Cut-out temperature ⁽²⁾	Start-up temperature ⁽²⁾	Weight (kg)	Type	Order code	Pack
50	2.5	110 x 60 x 90	+15°C	+5°C	0.3	ACC818230	4TBJ818230C0100	1
50	2.5	110 x 60 x 90	+25°C	+15°C	0.3	ACC818231	4TBJ818231C0100	1
100	4.5	110 x 60 x 90	+15°C	+5°C	0.3	ACC818232	4TBJ818232C0100	1
100	4.5	110 x 60 x 90	+25°C	+15°C	0.3	ACC818233	4TBJ818233C0100	1
150	8	150 x 60 x 90	+15°C	+5°C	0.5	ACC818234	4TBJ818234C0100	1
150	8	150 x 60 x 90	+25°C	+15°C	0.5	ACC818235	4TBJ818235C0100	1

(1) At an ambient temperature of 20°C

(2) Tolerance of ±5 K

General purpose enclosures

Accessories - Heaters



CS 028 / CSL 028

Heating resistor for maintaining a constant temperature inside the enclosures. Prevents malfunctions due to the formation of condensation or ice. Connection via an internal terminal. Thanks to their reduced dimensions, the CS 028 and CSL 028 heating resistors are ideal for installation in enclosures and cabinets with restricted space.

Technical specifications

Heating element	PTC resistor, self-regulating
Surface temperature	150 W/250 W: max. +50°C (+122°F), 400 W: max. 65°C (149°F), with the exception of the upper protective grille, for an ambient temperature of +20°C (+68°F)
Axial fan, with ball bearing roller bearing	air flow rate, unimpeded blowing, CS 028: 13.8 m ³ /h (230 V AC), 54 m ³ /h (120 V AC), life cycle 40,000 h at +40 °C (+104°F)
Connection	2.5 mm ² 2-pole terminal (CSL 028 with cable gland), max. tightening torque 0.8 Nm
Box	plastic material in accordance with UL94 V-0, black
Attachment	clip for 35 mm DIN rail, EN 60715 or screw attachment (Ø 5.3 mm)
Installation	vertical air flow (blowing upwards)
Operating/storage temperature	-45 to +70°C (-49 to +158°F)
Operating/storage humidity	max. 90% RH (condensation-free)
Certification	IP20/class II (double insulation)
Directives	file no. UL E150057 (in accordance with UL 508A, NITW file upon request), EAC, 230 V only: VDE

Ordering information CSL 028

Type	Nominal voltage	Heating power ⁽¹⁾	Max. start-up current	Fuse (slow-blow)	Dimensions (mm)	Weight (ca) (kg)	Type	Order code	Pack
CS 028	230 V, 50 / 60 Hz	150 W	12.0 A	10.0	75 x 65 x 90	0.3	ACC818242	4TBJ818242C0100	1
CSL 028	230 V, 50 / 60 Hz	250 W	9.0A	10.0	90 x 85 x 111	0.5	ACC818243	4TBJ818243C0100	1
CSL 028	230 V, 50 / 60 Hz	400 W	15.0A	16.0	90 x 85 x 111	0.5	ACC818244	4TBJ818244C0100	1

(1) At an ambient temperature of 20°C

General purpose enclosures

Accessories - Heaters



CSF 028

Compact blown-air heating resistor to maintain a constant temperature inside cabinets and enclosures containing electrical and electronic components. Prevents the formation of condensation or ice. Thanks to their reduced dimensions and anti-touch casing, this heating resistor is ideal for installation in enclosures and cabinets with restricted space. CSF 028 is equipped with a pre-set thermostat. Connection via external terminals. The resistor may be installed in two ways: by threaded bracket or by clip. Mounting by threaded bracket is highly robust and is particularly suitable for applications subjected to strong vibration.

Technical specifications

Heating element	PTC resistor, self-regulating
Surface temperature	250 W: max. +50°C (+122°F), 400 W: max. +65°C (+149°F) m.u.v. bovenliggend roosteroppervlak bij +20°C (+68°F) omgevingstemperatuur
Temperature limiter	prevents any overheating in the event of fan failure, automatic reactivation
Axial fan, with ball bearing roller bearing	air flow rate, unimpeded blowing, CSF 028: 45 m ³ /h (230 V AC), 54 m ³ /h (120 V AC), life cycle 40,000 h at +40 °C (+104°F)
Connection	2.5 mm ² double 2-pole spring terminal for solid cable or 1.5 mm ² for multi-strand wire with terminal connectors
Box	plastic material in accordance with UL94 V-0, black
Attachment	clip for 35 mm DIN rail, EN 60715 or screw attachment (Ø 5.5 mm), max. tightening torque 2 Nm, washers recommended
Installation	vertical air flow (blowing upwards) and horizontal
Dimensions	model with clip/screw attachment: 105x85x118 mm
Weight	model with clip/screw attachment: 0.5 kg
Operating/storage temperature	+40 to +70°C (-40 to +158°F) / -45 to +70°C (-49 to +158°F)
Operating/storage humidity	max. 90% RH (condensation-free)
Usage classification	IP20/class II (total insulation)
Certification	VDE, UL File No. E150057, EAC

Ordering information CSF 028

Type	Nominal voltage	Heating power ⁽¹⁾	Max. start-up current	Fuse (slow-blow)	Cut-out temperature ⁽²⁾	Start-up temperature ⁽²⁾	Type	Order code	Pack
CSF 028	AC 230 V, 50 / 60 Hz	250 W	9.0	10.0	+15°C (+59°F)	+5°C (+41°F)	ACC818247	4TBJ818247C0100	1
CSF 028	AC 230 V, 50 / 60 Hz	250 W	9.0	10.0	+25°C (+77°F)	+15°C (+59°F)	ACC818248	4TBJ818248C0100	1
CSF 028	AC 230 V, 50 / 60 Hz	400 W	15.0	16.0	+15°C (+59°F)	+5°C (+41°F)	ACC818245	4TBJ818245C0100	1
CSF 028	AC 230 V, 50 / 60 Hz	400 W	15.0	16.0	+25°C (+77°F)	+15°C (+59°F)	ACC818246	4TBJ818246C0100	1

(1) At an ambient temperature of +20°C (+68°F); ² tolerance ± 5 K

(2) Another start-up/cut-out temperature is available upon request.

General purpose enclosures

Accessories - Heaters



HVI 030 without fan



HVI 030

Compact heating resistor to regulate the temperature of cabinets and enclosures containing electrical and electronic components. Prevents malfunctions due to the formation of condensation or ice. The heating resistor may only be used in combination with a fan, but it is also available without an axial fan (self-installation). Choice of screw-attachment model or new rotary clip secured model. The latter is simple and quick to fit.

Technical specifications

Nominal voltage	230 V AC, 50 / 60 Hz
Heating element	hoogwaardig verwarmingspatroon
Temperature limiter	prevents any overheating in the event of fan failure, automatic reactivation, additional protection via an irreversible fuse
Axial fan, with ball bearing roller bearing	air flow rate of 150 m ³ /h, unimpeded air flow life cycle 50,000 h at +25 °C (+77°F)
Connection	2.5 mm ² double 3-pole spring terminal for solid cable or 1.5 mm ² for multi-strand wire with terminal connectors
Box	plastic material in accordance with UL94 V-0, black
Attachment	rotary clip for 35 mm DIN rail, EN 60715
Installation	vertical air flow (blowing upwards)
Dimensions (HxW xD)	169 x 127 x 89mm
Weight	1.3 kg approximately
Operating temperature	VDE: -10 to +50°C (+14 to +122°F) / UL: -10 to +40°C (+14 to +104°F)
Storage temperature	-45 to +70°C (-49 to +158°F)
Operating/storage humidity	max. 90% RH (condensation-free)
Protection rating	IP20/heating: class II (double insulation), fan: class I (grounded)
Certification	VDE, UL File No. E234324, EAC
Directives	other heating outputs and voltages available upon request

Important instruction: only use resistors with a fan (min. 150 m³/h).
Risk of overheating!

Ordering information

	Heating power ⁽¹⁾	Type	Order code	Pack
HVI 030	500	ACC818236	4TBJ818236C0100	1
	600	ACC818237	4TBJ818237C0100	1
	700	ACC818238	4TBJ818238C0100	1
HVI 030 without fan	500	ACC818239	4TBJ818239C0100	1
	600	ACC818240	4TBJ818240C0100	1
	700	ACC818241	4TBJ818241C0100	1

(1) At an ambient temperature of 20°C

General purpose enclosures

Accessories - Heaters



350 W



475 / 550 W

Semi-conductor heating resistor to regulate the temperature inside electrical cabinets. Prevents malfunctions due to the formation of condensation or ice. The integral thermostat can be used to adjust the temperature.

Technical specifications

Nominal voltage	220-240 V AC, 50 / 60 Hz
Heating element	PTC resistor, self-regulating
Temperature limiter	prevents any overheating in the event of fan failure, automatic shut-down
Axial fan, with ball bearing roller bearing	air flow rate: see table, life cycle 50,000 h at +25 °C (+77°F)
Connection	2.5 mm ² 2-pole terminal, max. tightening torque 0.8 Nm
Box	plastic material UL94 V-0, light gray
On/Off indicator	LED indicator
Attachment	clip voor 35 mm rail DIN, EN 60715
Installation	vertical air flow (blowing upwards)
Dimensions (HxW xD)	100 x 128 x 165 mm
Operating/storage temperature	-45 to +70°C (-49 to +158°F)
Operating/storage humidity	max. 90% RH (condensation-free)
Protection rating	IP20/class II (total insulation)
Certification	VDE, UL File No. E204590, EAC
Directives	other heating outputs and voltages available upon request

Ordering information

Nominal voltage	Heating power ⁽¹⁾ (50 Hz)	Heating power ⁽¹⁾ (60 Hz)	Max. start-up current	Air flow rate, unimpeded blowing	Temperature regulator adjustment range ⁽²⁾	Weight (approximate)	Type	Order code	Pack
220-240 V AC, 50 / 60Hz	350 W	550 W	8.5A	45 m ³ /h	0°C to +60°C	1.1	ACC818193	4TBJ818193C0100	1
220-240 V AC, 50 / 60Hz	475 W	550 W	11.0A	35 m ³ /h	0°C to +60°C	0.9	ACC818249	4TBJ818249C0100	1
220-240 V AC, 50 / 60Hz	550 W	650 W	13.0A	45 m ³ /h	0°C to +60°C	1.1	ACC818250	4TBJ818250C0100	1

(1) At an ambient temperature of 20°C

(2) 7 K start-up temperature hysteresis (tolerance of ±4 K)

General purpose enclosures

Accessories - Heaters



CR 130

Powerful heating resistor to regulate the temperature of cabinets and enclosures containing electrical and electronic components. Prevents malfunctions due to the formation of condensation or ice. The plastic casing provides protection against burns when coming into contact with hot parts. The heating resistor is available with an integral temperature regulator or a fixed-range hygrostat.

Technical specifications

Heating element	PTC resistor, self-regulating
Temperature limiter	prevents any overheating in the event of fan failure, automatic shut-down
Axial fan, with ball bearing roller bearing	air flow rate of 160 m ³ /h, unimpeded air flow life cycle 50,000 h at 25 °C (77°F)
Connection	2.5 mm ² max. 2-pole with securing bolt cable gland, max. tightening torque 0.8 NM
Box	plastic material in accordance with UL94 V-0, black
Attachment	clip attachment for 35 mm DIN rail, EN 60715 or screw attachment (M6)
Installation	vertical air flow (blowing upwards) + other
Dimensions	182 x 160 x 120 mm
Weight	1.3 kg approximately
Operating/storage temperature	-45 to +70°C (-49 to +158°F)
Operating/storage humidity	max. 90% RH (condensation-free)
Protection rating	IP20/class II (total insulation)

Ordering information CS 130

Type	Nominal voltage	Heating power ⁽¹⁾	Adjustment range ⁽²⁾	Fuse T (slow-blow)	Dimensions (mm)	Weight (approximate)	Type	Order code	Pack
CR 130	AC 230 V, 50 / 60Hz	950W	0°C to +60°C	6.3A	99 x 160 x 182	1.5	ACC818251	4TBJ818251C0100	1
CS 130	AC 230 V, 50 / 60Hz	1200W	Resistor without thermostat	10.0A	120 x 160 x 182	1.3	ACC818253	4TBJ818253C0100	1

(1) At an ambient temperature of 20°C

(2) 7 K start-up temperature hysteresis (tolerance of ±4 K)

General purpose enclosures

Accessories - Thermostat



KTO



KTS

Function

KTO and KTS elements regulate and control the temperature inside the enclosure by controlling the small heaters, fans, heat exchangers and cooling units.

KTO 011

Thermostat (contact normally closed) for heating resistor regulation. The contact is opened when the temperature increases.

KTS 011

Thermostat (contact normally open) for regulating filter fans, heat exchangers and air conditioning units or for triggering signals when the temperature threshold is exceeded. The contact is closed when the temperature increases.

Technical specifications

Type	KTO	KTS
Adjustment range:	+10 - +50°C or 0 - +60°C	+10 - +50°C or 0 - +60°C
hysteresis temperature	7 K (±4 K tolerance)	7 K (±4 K tolerance)
Contact type	NC	NO
Power	250 V AC, 10 (2) A 120 V AC, 15 (2) A 30 W DC on 24 V DC to 72 V DC	250 V AC, 10 (2) A 120 V AC, 15 (2) A 30 W DC on 24 V DC to 72 V DC
Max. start-up current	16 A AC for 10 s	16 A AC for 10 s
Weight	36 g	36 g
Dimensions (HxW xD) mm	60 x 33 x 43 mm	60 x 33 x 43 mm
Wiring diagram	red button: heating	blue button: cooling, ventilation, alarm signal
Protection rating	IP20	IP20
Connection	2-pole terminal, max. tightening torque 0.5 Nm: 2.5 mm ² solid cable (AWG 16), 1.5 mm ² flexible cable (AWG 14)	
Installation	clip for 35 mm DIN rail, EN 60715	
Box	plastic material UL94 V-0, light gray	
Anti-interference	N in accordance with VDE 0875	

Values between parentheses: inductive load $\cos \varphi = 0.80$

Connection diagram

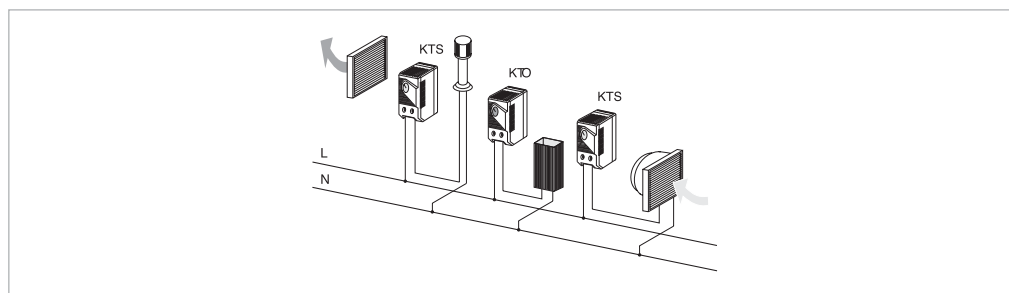
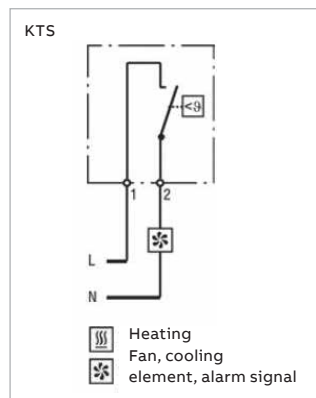
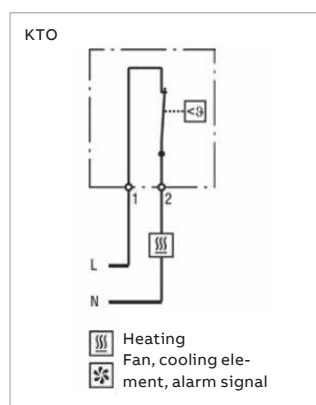

Ordering information

	Temperature	Type	Order code	Pack
KTO	-10° to +50°C	ACC818265	4TBJ818265C0100	1
KTO	0° to +60°C	ACC818080	4TBJ818080C0100	1
KTS	-10° to +50°C	ACC818266	4TBJ818266C0100	1
KTS	0° to +60°C	ACC818081	4TBJ818081C0100	1

General purpose enclosures

Accessories - Thermostat



FZK 011



ZR 011



ETR 011

Connection diagram

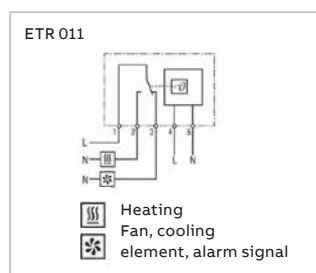
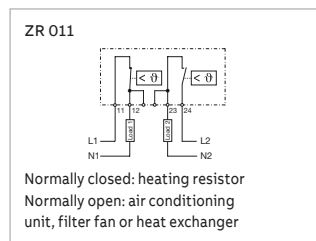
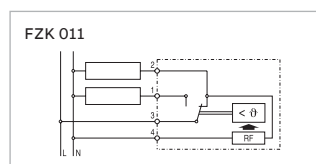

Function

FZK 011, ZR 011 and ETR 011 elements regulate and control the temperature inside the enclosure by controlling the small heaters, fans, heat exchangers and cooling units.

FZK 011

Mechanical thermostat used for controlling heating resistors, air conditioning units, filter fans or signaling. It obtains ambient temperature readings and can switch resistive and inductive loads thanks to its snap switching.

ZR 011

Two thermostats in one unit:

- thermostat (contact normally closed) for heating resistor regulation.;
- thermostat (contact normally open) for regulating filter fans, heat exchangers and air conditioning units or for triggering signals when the temperature threshold is exceeded.

Unlike a thermostat with inverter switch, the dual thermostat allows the heating resistor and air conditioning unit to be connected independently at different temperature ranges.

ETR 011

The mechanical thermostat is used for controlling heating resistors, air conditioning units, filter fans or signaling. The thermostat obtains ambient temperature readings and can switch resistive and inductive loads thanks to its inverter switch (relay). The LED integral to the adjustment button lights up when the contact is closed (when the heating resistor is in operation, for example).

Technical specifications

Type	FZK 011	ZR 011	ETR 011
Adjustment range:	+5 to +60°C or -20 - +35°C	0 to 60°C	+20°C
hysteresis temperature	0.5 K	7 K	4 K (±1 K tolerance)
Contact type	switching contact: single-pole	NC	NO
Power	NC 10 A (4) 250 V AC NO 5 A (2) 250 V AC Resistive load	10 A (2) 250 V AC Resistive load	AC 240 V, 8 (1.6) A AC 120 V, 8 (1.6) A DC 100 W to DC 24 V
Max. start-up current	-	-	16 A AC for 10 s
Weight	100g	90g	70g
Dimensions (HxWxD) mm	67 x 50 x 38	60 x 50 x 46	64.5 x 42 x 38
Wiring diagram	(see left)	(see left)	/
Protection rating	IP20	IP20	IP20
Connection	2-pole terminal, max. tightening torque 0.5 Nm: 2.5 mm ² solid cable (AWG 14) 1.5 mm ² flexible cable (AWG 16)		
Installation	clip for 35 mm DIN rail, EN 60715		
Box	plastic material UL94 V-0, light gray		
Anti-interference	N in accordance with VDE 0875		

Values between parentheses = inductive load $\cos \varphi = 0.8$

Ordering information

	Temperature	Type	Order code	Pack
FZK 011	+5° to +60°C	ACC818079	4TBJ818079C0100	1
FZK 011	-20° to +35°C	ACC818269	4TBJ818269C0100	1
ZR 011	0° to +60°C	ACC818217	4TBJ818217C0100	1

(1) At an ambient temperature of 20°C

General purpose enclosures

Accessories - Thermostat



FTO 011



FTS 011

Function

The mechanical thermostat is a dual switch with low hysteresis. The thumb wheel is for anti-icing adjustment. The casing ensures optimal air circulation around the bimetallic element.

STO 011

Thermostat (contact normally closed) for heating resistor regulation. The contact is opened when the temperature increases.

STS 011

Thermostat (contact normally open) for regulating filter fans, heat exchangers and air conditioning units or for triggering signals when the temperature threshold is exceeded. The contact is closed when the temperature increases.

Technical specifications

Type	
Hysteresis	4 K (± 3 K tolerance)
Heat sensor	with bimetal element
Contact type	snap switching
Life cycle	> 100,000 cycles
Power	250 V AC, 10 (2) A 120 V AC, 15 (2) A 30 W DC on 24 V DC to 72 V DC
Max. start-up current	16 A AC for 10 s
Connection	2-pole terminal, max. tightening torque 1 Nm: 2.5 mm ² flexible/solid cable (AWG 14)
Attachment	clip for 35 mm DIN rail, EN 60715
Box	plastic material UL94 V-0, light gray
Dimensions	70 x 33 x 42 mm
Weight	50g approximately
Installation	mandatory
Operating/storage temperature	-45 to +80°C (-49 to +176°F)
Operating/storage humidity	max. 90% RH (condensation-free)
Protection rating	IP20
Certification	VDE, UL File No. E164102, EAC

Connection diagram

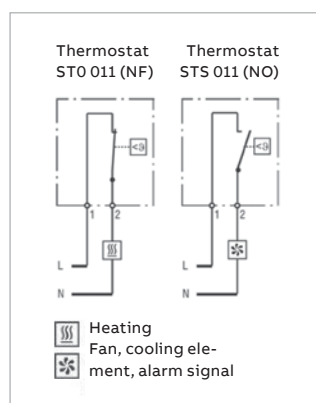

Ordering information

	Contact	Temperature	Type	Order code	Pack
STO 011	NC	0° to 60°C	ACC818267	4TBJ818267C0100	1
STS 011	NO	0° to 60°C	ACC818268	4TBJ818268C0100	1

General purpose enclosures

Accessories - Hygrotherm



ETF 012

The hygrostat/thermostat measures both temperature and humidity, and is able to activate heating or cooling independently.

Technical specifications

Adjustment range:	
- Temperature	0°C to 60°C
- Hysteresis	2K
- Relative humidity of the air	50% to 90%
- Rest time	160 secs.
Power supply voltage	100-240 V / 50-60 Hz
Contact type	relay output: NO/NF switch
Power output ⁽¹⁾	8 A (4) 250 V AC 0.5 A 100 V DC 8 A 12 V DC 5 A 35 V DC
On/Off indicator	LED
Weight	140 g
Dimensions (HxW xD)	50 x 67 x 43 mm
Protection rating	IP20
Connection	2.5 mm ² screw-in terminals
Attachment	35 mm DIN rail(EN 50022)
Box	plastic UL 94 V0
Anti-interference	N in accordance with VDE 0875

(1) Values between parentheses: inductive load $\cos \varphi = 0.80$

Ordering information

	Type	Order code	Pack
ETF 012	ACC818083	4TBJ818083C0100	1
ETF 012 with external sensor	ACC818271	4TBJ818271C0100	1

Connection diagram

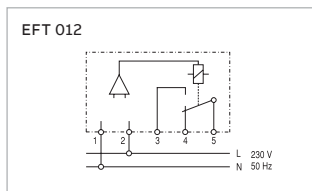

General purpose enclosures

Accessories - Hygrostat



MFR 012



EFR 012

The humidity regulator is designed to control the temperature and air humidity inside the enclosure. The regulator is activated when the humidity level reaches 65%. In doing so, the system efficiently prevents the risk of condensation and corrosion.

Technical specifications

	MFR 012	EFR 012
Adjustment range	35 to 95% RV	40 to 90% RV
Switching hysteresis	tolerance of $\pm 3\%$ RH	tolerance of $\pm 3\%$ RH
Nominal voltage	250 V AC	230 V AC, 50/60 Hz
Switching capacity, max. load:		
- Resistive load	5 A 250 V	240 V AC, 8 (1.6) A
- Inductive load $\cos \varphi$ 0.8	0.2 A 250 V AC	120 V AC, 8 (1.6) A
- Inductive load L/R = 3 ms	1 A 50 V DC to 75 V DC	100 W AC to 24 V DC
Switching capacity, min. load:	100 mA DC / AC 20 V	
Contact type	CO NO / NC	CO (relay)
Connection	terminal plate inside the casing, 3 x 2.5 mm ²	5-pole terminal, max. tightening torque 0.5 Nm: 2.5 mm ² solid/flexible cable (AWG 14)
Box	plastic, light gray	plastic material UL94 V-0, light gray
Installation	35 mm DIN rail	clip for 35 mm DIN rail, EN 60715
Protection rating	IP20	IP20
Dimensions (H x W x D)	67 x 50 x 38 mm	64.5 x 42 x 38 mm
Weight	60 g	70 g

(1) Values between parentheses: inductive load $\cos \varphi = 0.80$

Ordering information

	Type	Order code	Pack
MFR 012	ACC818190	4TBJ818190C0100	1
EFR 012	ACC818270	4TBJ818270C0100	1

Connection diagram

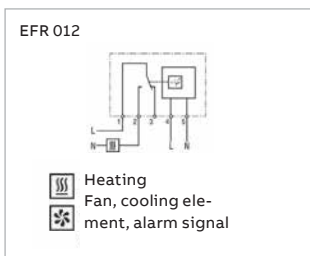
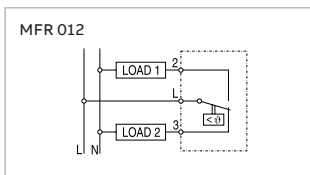

General purpose enclosures

Accessories - Passive cabinet ventilation

The differences between ambient temperature and the temperature inside a cabinet with a high protection rating may generate variations in pressure. In the event of under-pressure, the cabinet may draw in dust and moisture. Any moisture trapped inside the cabinet will be deposited as condensation. This condensation can be prevented through the use of ventilation grilles.

Product	Type	Order code	Pack
IP44 ventilation grille			
Suitable for a ventilation opening Includes 2 grilles and 4 nylon nails. Total insulation.			



2000mm ² grille	PS832019	4TBP832019C0100	1
----------------------------	----------	-----------------	---

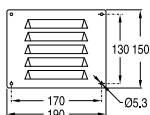

3000mm ² grille	PS832743	4TBP832743C0100	1
----------------------------	----------	-----------------	---

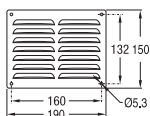

4500mm ² grille	PS832744	4TBP832744C0100	1
----------------------------	----------	-----------------	---

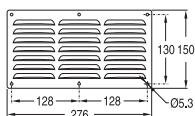

IP44 vent (RAL 7035)

In order to guarantee sufficient ventilation and to avoid condensation, two vents must be installed; one at the top and a second one at the bottom. Kit includes: drilling template.

Set of 2 polyamide pieces	PS833677	4TBP833677C0100	1
---------------------------	----------	-----------------	---



Vents (IPx4)

Improve ventilation and prevent condensation. Recommended installation above or below the cabinet - M20

MB861728	4TBG861728R0100	25
----------	-----------------	----



Product	Type	Order code	Pack
IP55 pressure compensation plug			

Hermetically sealed cabinets and enclosures are subjected to thermal or exterior influences, which result in temperature fluctuations during changes in pressure. Pressure compensation plugs compensate for changes in pressure and prevent the ingress of dust and moisture. The plug is suitable for use in electrical cabinets and enclosures, in accordance with the DIN EN 62208 standard.

Set of 2 pieces	ACC818078	4TBJ818078R0100	1
-----------------	-----------	-----------------	---

Technical specifications

Dimensions	ø 65.5 mm x 30.5 mm
Cut-out	ø 37 mm
Attachment	PG 29 threaded or nut
Material	ABS/PC
Air inlet	±1.5 cm ²
Protection rating	IP55

Note: compensation for optimal pressure revolves around the use of 2 plugs, diagonally opposed. If the plug is not installed vertically, the protection rating is reduced to IP54.



Vents - IP44⁽¹⁾

Set of 2 pieces, bore diameter ø 34.9 mm	AR831009	4TBA831009C0100	1
--	----------	-----------------	---







(1) If positioned in the corners of an Aria cabinet or under the hood of a PolySafe cabinet

General purpose enclosures

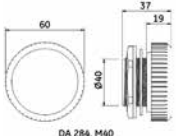

Accessories - Passive cabinet ventilation

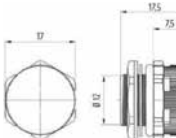
Product	Type	Order code	Pack	
Pressure regulator plug - IP66				
Set of 2 pieces				
	M40	ACC818223	4TBJ818223R0100	1
Highly resistant to poor weather conditions and UV, compliant with the UL746C standard	M40	ACC870418	4TBJ870418C0100	1
	M12	ACC818287	4TBJ818287C0100	1

Installation	M40 x 1.5 or M12 x 1.5 thread with nut.
Torque	M40: 5 Nm, M12: 0.5 Nm
Mounting depth	M40: approximately 16 mm, M12: approximately 8 mm
Sealing	NBR seal
Filter	waterproof membrane
Dimensions	M40: Ø 60 x 37 mm, M12: Ø 17 x 17.5 mm
Installation	mandatory
Certification	UL (870418), EAC

Pressure compensation plug - IP66			
STAINLESS AISI 304	ACC818288	4TBJ818288C0100	1
STAINLESS AISI 304	ACC818289	4TBJ818289C0100	1
STAINLESS AISI 316L	ACC818290	4TBJ818290C0100	1

			
---	---	---	---

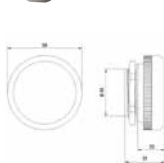
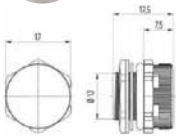
Installation	M40 x 1.5 thread with nut.
Torque	5 Nm
Mounting depth	9 mm approximately
Sealing	NBR seal
Filter	waterproof membrane
Air permeability	1200 l/h with a pressure difference of 70 mbar min.
Dimensions	Ø 58 x 31 mm
Installation	mandatory
Operating/storage temperature	-45 to +80°C (-49 to +176°F)
Certification	EAC

DAK 284

Product	Type	Order code	Pack	
Ventilated cable gland - IP66/IP67				
Air permeability		Torque		
25 l/h	M12 2Nm	ACC818291	4TBJ818291C0100	1
25 l/h	M16 2Nm	ACC818292	4TBJ818292C0100	1
40 l/h	M20 5Nm	ACC818293	4TBJ818293C0100	1

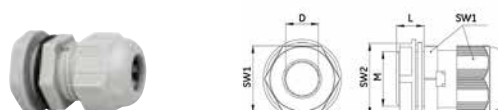

Installation	M12 x 1.5 / M16 x 1.5 / M20 x 1.5 thread
Mounting depth	0.5 – 3 mm with nut
Material	plastic, light gray
Protection rating	IP66 / IP67 (EN 60529)
Sealing	NBR seal
Filter	PTFE
Installation	mandatory
Operating/storage temperature	-20 to +80°C (-4 to +176°F)
Certification	VDE, UL, EAC

Dimensions (mm)

Type	ACC818291	ACC818292	ACC818293
Order code	4TBJ818291C0100	4TBJ818292C0100	4TBJ818293C0100
	M12	M16	M20
L	8	10	10
D	4 - 8	4 - 8	6 - 12
SW1	19	19	24
SW2	18	22	26

DD 084

Product	Type	Order code	Pack
Drainage plug - IP66/IP67/IP69K			
	AC818294	4TBJ818294C0100	1

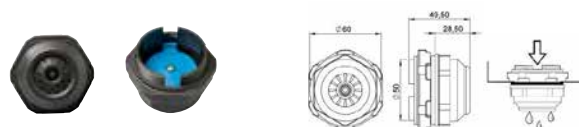

Torque	M12 x 1.5 / M16 x 1.5 / M20 x 1.5 thread
Mounting depth	0.5 – 3 mm with nut
Material	plastic in accordance with UL94 V-0, dark gray, highly resistant to poor weather conditions and UV, compliant with the UL746C standard
Protection rating	IP66 / IP67 (EN 60529)
Sealing	NBR seal
Filter	PTFE
Installation	mandatory
Operating/storage temperature	-20 to +80°C (-4 to +176°F)
Certification	VDE, UL, EAC

Installation instructions: drill a Ø 50.5+ mm hole in the lower section of the enclosure and install the drainage system with a nut. Important: the hole must have no burred edges and the seal must be fitted on the exterior side of the enclosure.

General purpose enclosures



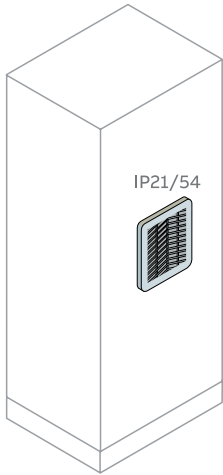

Accessories - Ventilation kits



Temperature management

IP21/54 natural ventilation kit

Gratings made of insulating material (self-extinguishing ABS UL94V-0) RAL7035 colour, complete with high dust collection capacity filter cloth (600g/m²), able to reduce maintenance interventions (cleaning by means of washing in water or by beating). Degree of protection IP21 without filter, IP54 with filter according to IEC 60529, Type 1 without filter, Type 12 with filter according to UL approval 508 fitted with pre-assembled gasket seal. CE and cURus approval.

Air entry surface for ventilation		Dimensions (mm)		Type	Order code	Package/ No. of pieces
Without filter cm ²	With filter cm ²	W	H			
Grille+air passage filter kit						
27	6	105	105		EN0105K	1/1
53	10	150	150		EN0150K	1/1
121	22	204	204		EN0204K	1/1
225	32	250	250		EN0250K	1/1
317	55	325	325		EN0325K	1/1



General purpose enclosures



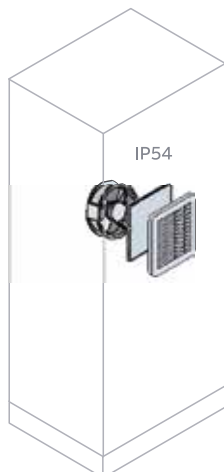





Accessories - Ventilation kits



Temperature management

IP54 forced ventilation Kit

Grilles made of insulating material (ABS self-extinguishing UL94V-0) RAL7035 colour, complete with filter cloth with high dust accumulation capacity (600g/m²), able to reduce maintenance interventions (cleaning by washing with water or beating). IP54 degree of protection with filter according to UL approval 508 fitted with pre-mounted tightness gasket. Operating temperature -10 °C + 50 °C. The fans allow reversible flow of air. CE and cURus (see mark) approval.

Air entry surface for ventilation		Dimensions (mm)		Type	Order code	Package/ No. of pieces
Consumption 50/60Hz (W)	Capacity 50/60Hz (m ³ /h)	W	H			
Ventilation filter with IP54 230V ~ fan						
10/8	23/30	105	105	 EN1105K		1/1
20/19	57/61	150	150	 EN1150K		1/1
17/15	120/135	204	204	 EN1204K		1/1
29/29	240/270	250	250	 EN1250K		1/1
67/87	520/580	325	325	EN2325K		1/1
Ventilation filter with IP 54 1150V~ fan						
9/7	23/30	105	105	 EN2105K		1/1
20/18	57/61	150	150	 EN2150K		1/1
17/15	120/135	200	200	 EN2204K		1/1
30/30	240/270	250	250	 EN2250K		1/1
50/64	520/580	325	325	EN3325K		1/1

General purpose enclosures

Accessories - General accessories

Cable gland - PG - IP54 polycarbonate (gray)										
PG	D1 (mm)	Drill diameter ∅ (mm)	D3	D5	L5	S1	S2	Type	Order code	Pack
11	18.6	19	11	24	8	19	22	APACC851038	4TBO851038C0100	50
13.5	20.4	21	13	26.5	9	21	24	APACC851042	4TBO851042C0100	50
16	22.5	23	16	29.5	10	23	27	APACC851046	4TBO851046C0100	50
21	28.3	29	21	35	11	30	32	APACC851051	4TBO851051C0100	25
29	37	38	27.5	45	11	41	42	APACC851056	4TBO851056C0100	10
36	47	48	34	57	13	50	53	APACC851060	4TBO851060C0100	5
42	54	55	42	64	12.5	55	60	APACC851062	4TBO851062C0100	5

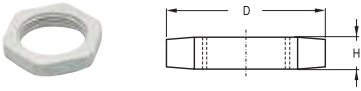
Nuts - Polycarbonate (gray)		PG	D	H	Type	Order code	Pack
		11	25	5	APACC851075	4TBO851075C0100	50
		13.5	27.5	5.5	APACC851076	4TBO851076C0100	50
		16	31	6	APACC851077	4TBO851077C0100	50

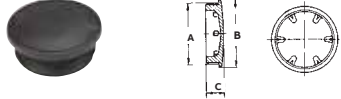





Plugs (black)		A	B	C	Type	Order code	Pack
		PG16	26	11	APACC851064	4TBO851064C0100	50
		PG21	32	11.5	APACC851065	4TBO851065C0100	50
		PG29	41	13	APACC851066	4TBO851066C0100	50
		PG36	51	12.5	APACC851068	4TBO851068C0100	50

Pipe entries - Non-threaded (black)										
Pipe ∅	A	B	C	D	E	F	G	Type	Order code	Pack
5 / 8"	PG-16	26	17	21	14.1	15	9	APACC851069	4TBO851069C0100	20
3 / 4"	PG-16	26	20	24	16	21	9	APACC851070	4TBO851070C0100	20

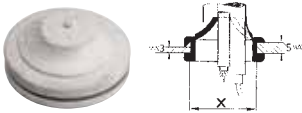
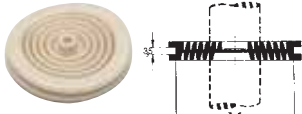
Pipe entries - Non-threaded (black)										
Pipe ∅	A	B	C	D	E	F	G	Type	Order code	Pack
5 / 8"	PG-16	26	17	21	14.1	15	9	FOB61TUB3	4TBB600933C0200	25
3 / 4"	PG-16	26	20	24	16	21	9	FOB61TUB4	4TBB600934C0200	25

General purpose enclosures

Accessories - General accessories

Universal entries (gray)								
		Cable Ø max.	PG	Drill diameter Ø (mm)	Color	Type	Order code	Pack
		18	16	23	gray	FORJRPG16	4TBR610130C0200	25
		24	21	29	gray	FORJRPG21	4TBR610132C0200	25
		32	29	38	gray	FORJRPG29	4TBR610133C0200	25
		49	42	54	gray	APACC852191	4TBO852191C0100	1
		12	48	55	gray	APACC851096	4TBO851096C0100	20
		12	30	35	gray	APACC851097	4TBO851097C0100	20
		12	36	45	gray	APACC851098	4TBO851098C0100	20
		22	66	75	gray	APACC851099	4TBO851099C0100	10
		22	58	65	gray	APACC851100	4TBO851100C0100	10
Railstellen						Type	Order code	Pack
	- RSTN busbars - I = 63 A - Busbar cross-section 6.5x9 - DIN rail mounting - Peak current: 15 kA (10 msec)					ACC610022	4TBR610022C0200	18
		- RSTN busbars - Busbar cross-section 12 x 5 - I = 160A - DIN rail mounting - Peak current: 35kA (10 msec)					ACC610020	4TBR610020C0200
		- Protective screen for 610020					ACC610021	4TBR610021C0200
	- Busbars 12x5 - Length 1.2 m + 50 jumpers and 50 screws - Maximum span: 200mm - To be combined with 610018 supports					ACC610017	4TBC610017C0100	10
	- Busbar support for four 12x5 busbars - Max. spacing of supports: max. 200mm - DIN rail mounting - To be combined with the busbars above					ACC610018	4TBC610018C0100	1

(1) The ACC610017 and ACC610018 assembly has a peak current of: 15 kA (10 msec)

General purpose enclosures

Accessories - General accessories

Busbar/cable terminals		Type	Order code	Pack			
	With 4 bypasses - For Al/Cu cable - Max. thickness: 12 mm - Width: unlimited	35-70 mm ² + 4 bypasses (16 mm ²)					
		2 cables	ACC779221	4TBC779221C0100	4		
		3 cables	ACC779222	4TBC779222C0100	4		
		90-150 mm ² + 4 bypasses (25 mm ²)					
		2 cables	ACC779218	4TBC779218C0100	4		
		3 cables	ACC779219	4TBC779219C0100	4		
Rubber insulation cap		Type	Order code	Pack			
	For 35-70 mm ² terminal						
			ACC779224	4TBC779224C0100	4		
	For 95-150 mm ² terminal						
			ACC779223	4TBC779223C0100	4		
Connection busbars		Type	Order code	Pack			
	- Phase - black - 6x10mm ² and 2x16 mm ² - Interlocking on flat bar 12 x 2 mm	FORSTTL	4TBR610185C0200	4			
	- Ground - green - 6x10mm ² and 2x16 mm ² - Interlocking on flat bar 12 x 2 mm	FORSTTPE	4TBR610186C0200	4			
	- Neutral - blue - 6x10mm ² and 2x16 mm ² - Interlocking on flat bar 12 x 2 mm	FORSTTN	4TBR610187C0200	4			
	- 14 x 16 mm ² - DIN rail mounting	ACC610065	4TBC610065C0100	4			
	- Ground busbar - 12 x 4 with 3 terminals - Screw fixing	APACC851021	4TBO851021C0100	4			
Busbar/busbar terminals		Type	Order code	Pack			
	Main busbar	Secondary busbars	Min. total thickness	Clamped bars			
	20	15 - 20	5 - 4	26 - 24	APACC851120	4TBO851120C0100	10
30	15 - 20 - 30	7 - 6 - 5	28 - 27 - 26	APACC851129	4TBO851129C0100	10	





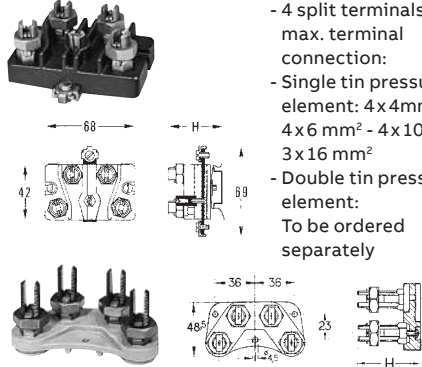

General purpose enclosures

Accessories - General accessories

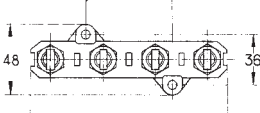
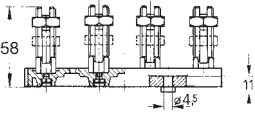
Busbar/busbar terminals							
	Cable max. Ø (mm ²)	Busbar thickness (mm)	Busbar width (mm)	Type	Order code	Pack	
	10 to 50	5 to 6	30	APACC851117	4TBO851117C0100	10	
	4 to 35	3 to 5	15	APACC851118	4TBO851118C0100	10	
Terminal rosettes for 10-16 mm ² Al and Cu cable							
		Attachment	Ground clamp	H	Type	Order code	Pack
 <p>- 4 split terminals with max. terminal connection: - Single tin pressure element: 4 x 4 mm² - 4 x 6 mm² - 4 x 10 mm² - 3 x 16 mm² - Double tin pressure element: To be ordered separately</p>		screw-fit	none	46	ACC779212	4TBC779212C0100	5
		on DIN rail	none	48	ACC779213	4TBC779213C0100	5
		screw-fit	included	46	ACC779214	4TBC779214C0100	5
		on DIN rail	included	48	ACC779215	4TBC779215C0100	5
		screw-fit	none	48	ACC890705	4TBC890705C0100	5
Double pressure element					Type	Order code	Pack
Set of 4 securing nuts					ACC779216	4TBC779216C0100	1
Insulation cap					Type	Order code	Pack
Made of rubber					ACC890704	4TBC890704C0100	20

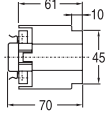

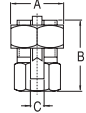
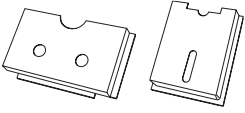







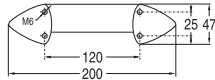

General purpose enclosures

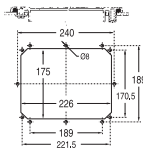
Accessories - General accessories

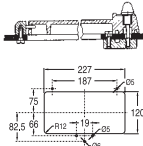
25-35 mm ² terminal blocks					Type	Order code	Pack			
  	- Without insulation caps				ACC779201	4TBC779201C0100	10			
	- 1 securing nut									
	- Al/Cu cable									
	- 2 securing nuts				ACC779202	4TBC779202C0100	10			
- Al/Cu cable										
- With insulation caps				ACC779204	4TBC779204C0100	10				
- 2 securing nuts										
- Al/Cu cable										
- With insulation caps and attachment				ACC779205	4TBC779205C0100	10				
- 2 securing nuts										
- Al/Cu cable										
Insulation cap					Type	Order code	Pack			
 					ACC890838	4TBC890838C0100	10			
Double pressure element					Type	Order code	Pack			
Set of 4 securing nuts					ACC779203	4TBC779203C0100	10			
Cable clamps for overhead lines		Cross-section	A	B	C	Type	Order code	Pack		
 		10 mm ²	14	24	4.5	KIM601227	2CDB710029R0000	100		
		16 mm ²	22	29	5.5	KIM601228	2CDB710019R0000	50		
		35 mm ²	25	35	7.5	KIM601229	2CDB710022R0000	25		
		50 mm ²	28	43.5	9.0	KIM601230	2CDB710031R0000	25		
Document pocket					Type	Order code	Pack			
					DIN A4, 325 B x 180H, self-adhesive - gray			PS811516	4TBC811516C0100	1
					DIN A5, 155 B x 225H, self-adhesive - transparent			PS832000	4TBP832000C0100	1
Insulated cover plate (color: orange)					Type	Order code	Pack			
					Thickness 3mm, 1900 x 900 x 3mm			ACC811096	4TBC811096C0100	1

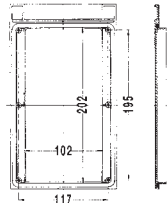
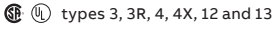
General purpose enclosures

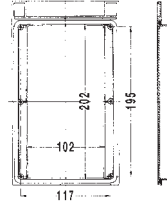
Accessories - General accessories

Module covers	Type	Order code	Pack	
	12 modules, sectionable by 1/2 module			
	FORSTBP4	4TBR610142C0200	5	
Handle	Type	Order code	Pack	
 	Height 50mm, with reinforcement molding + Vyncolite screws			
	APACC851244	4TBO851244C0100	1	
IP54 windows	Type	Order code	Pack	
 	Includes a template and fixings			
	77x60 mm - 2 mod.	ACCWD2M	4TBO861395C0100	1
	77x96 mm - 4 mod.	ACCWD4M	4TBO861396C0100	1
	77x130 mm - 6 mod.	ACCWD6M	4TBO861397C0100	1
	77x163 mm - 8 mod.	ACCWD8M	4TBO861398C0100	1
	Screw-fit IP67	AP9X7WD	4TBO866001C0100	1
				
 	With hinges and seal IP55			
	77x60 mm - 2 mod.	APACC890837	4TBO890837C0100	1
 	Screw-fit IP67, with label holders			
		AP8X4WDL	4TBO866002C0100	1
				
 	Screw-fit IP67, without label holders			
		AP8X4WD	4TBO866003C0100	1
				

General purpose enclosures

Accessories - General accessories

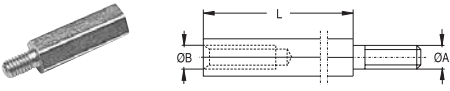
M4 type rise pillars	L (mm)	Ø A	Ø B	Type	Order code	Pack
	10	M4	M4	APACC890800	4TBO890800C0100	50
	15	M4	M4	APACC890801	4TBO890801C0100	50
	20	M4	M4	APACC890802	4TBO890802C0100	50
	25	M4	M4	APACC890803	4TBO890803C0100	50
	30	M4	M4	APACC890804	4TBO890804C0100	50
	60	M4	M4	APACC890805	4TBO890805C0100	50
	65	M4	M4	APACC890806	4TBO890806C0100	50
	97	M4	M4	APACC890807	4TBO890807C0100	20
	102	M4	M4	APACC890808	4TBO890808C0100	20

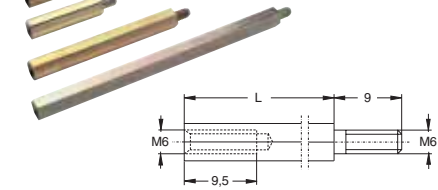
M6 type rise pillars	L (mm)	Ø	Type	Order code	Pack
	15	M6-M6	ACC811337	4TBC811337C0100	100
	20	M6-M6	ACC811338	4TBC811338C0100	100
	25	M6-M6	ACC811454	4TBC811454R0100	100
	30	M6-M6	ACC811339	4TBC811339C0100	100
	35	M6-M6	ACC811455	4TBC811455R0100	100
	45	M6-M6	PS811456	4TBP811456R0100	100
	55	M6-M6	ACC811457	4TBC811457R0100	100
	65	M6-M6	ACC811458	4TBC811458R0100	100
	70	M6-M6	ACC811340	4TBC811340C0100	100
	80	M6-M6	ACC811460	4TBC811460R0100	100
	100	M6-M6	ACC811461	4TBC811461R0100	100
	120	M6-M6	ACC811341	4TBC811341C0100	100

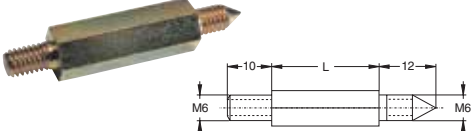

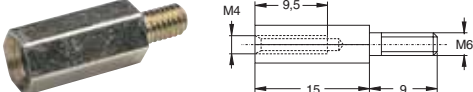

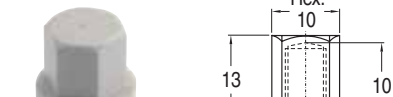



M6 type rise pillars	L (mm)	Ø	Type	Order code	Pack
	60	M6-M6	ACC811342	4TBC811342C0100	100
	30	M6-M6	ACC811343	4TBC811343C0100	100

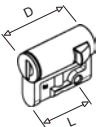



M4-M6 Type	L (mm)	Ø	Type	Order code	Pack
	15	M6-M4	ACC811336	4TBC811336C0100	100

Insulated cap nuts (RAL 7035 Light Gray)	A	B	C	D	Ø E	Type	Order code	Pack	
	M4	15	13.5	8.5	M4	11	KIM601223	2CDB601223R0000	100
	M5	18	17.0	10	M5	14	KIM601224	4TBS601224C0200	100
	M6	22.3	20.4	9	M6	17	KIM601225N	4TBC601225C0100	100
	M8	25.3	24.2	10	M8	20	KIM601226	2CDB601226R0000	50

General purpose enclosures

Accessories - General accessories

Locks with semi-cylindrical profile M4 Type		Type	Order code	Pack
Standard: D = 40 mm - L = 30.5 mm				
	 With 2 keys V2432-E	PS832030	4TBP832030C0100	1
	 With 2 keys 1242-E	PS832031	4TBP832031C0100	1
	 With 2 keys 455-E	PS832465	4TBP832465C0100	1
	 With 2 keys 405-E	PS832466	4TBP832466R0100	1
	 With 1 square key, 8 mm	PS832032	4TBP832032C0100	1
	 With 1 square key, 8 mm	PS832033	4TBP832033C0100	1
	 With 1 square key, 11 mm	PS832034	4TBP832034C0100	1
	 With 1 double-bit key, 3 mm	PS832029	4TBP832029C0100	1

M4 type keys		Type	Order code	Pack
	For security lock no. V2432E	PS832022	4TBP832022C0100	2
	 For security lock, 8mm square	PS832026	4TBP832026C0100	1
	 For security lock, 8mm triangular	PS832027	4TBP832027C0100	1
	 For security lock, 11mm triangular	PS832072	4TBP832072C0100	1
	 For security lock, double-bit 3mm	PS832028	4TBP832028C0100	1

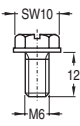
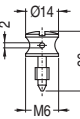

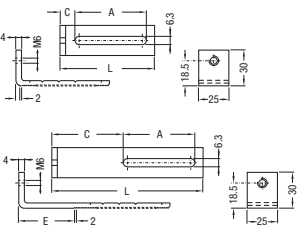

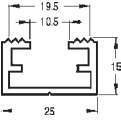
Screws		Type	Order code	Pack
	M6 flange screw	ACC811483	4TBC811483C0100	100
	PVC M6 screw for cover plate (sealable)	ACC811451	4TBC811451R0100	100

Brackets		L	A	C	E	Type	Order code	Pack
	40	24	9.5	-		ACC811478	4TBC811478R0300	100
	80	64	9.5	-		ACC811479	4TBC811479R0300	100
	120	64	49.5	41.5		ACC811480	4TBC811480C0100	100

Aluminum profiles		Type	Order code	Pack
	Profile length = 3m	ACC811417	4TBC811417C0100	1

General purpose enclosures

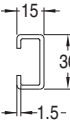

Accessories - General accessories

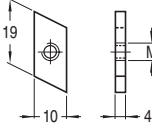
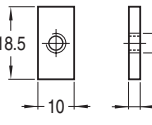
Galvanized profiles		Type	Order code	Pack	
		DIN profile 35x7.3x1 Length: 3m	APACC890847	4TBO890847C0100	1
		C profile 30x15x1.5 Length: 3m	ACC811619	4TBC811619C0100	1
		Slide nuts for C profile 30 x 15 M6	ACC811363	4TBC811363C0100	25
		Slide nuts for C profile 25 x 10 M6	ACC811365	4TBC811365C0100	50
		Jumpers + screws M5 x 13 Max. 2 x 10 mm ² per jumper	APACC851123	4TBO851123C0100	10

Metal nuts		Type	Order code	Pack	
		M6	ACC811435	4TBC811435C0100	100
		M4	ACC811438	4TBC811438C0100	100
		M6	ACC811446	4TBC811446C0100	100
		M8	ACC811447	4TBC811447C0100	100

General purpose enclosures

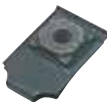
Accessories - General accessories

Slide nuts	Type	Order code	Pack
	For perforated mounting plate		
	M4 bolt	AR831328	4TBA831328C0100 50
	M5 bolt	AR831329	4TBA831329C0100 50
	M6 bolt	AR831330	4TBA831330C0100 50
Rise pillars	Type	Order code	Pack
	For mounting on symmetrical DIN rail, height: 21 mm		
		ACC610312	4TBC610312C0100 10
Mounting equipment	Type	Order code	Pack
	Slide + M4 screw		
		APACC890835	4TBO890835C0100 10
	Slide + washer + M4 screw		
		APACC890836	4TBO890836C0100 10
	M5 screw for meter L = 21 mm		
		APACC890844	4TBO890844C0100 20
	M 4 x 8 screw		
		APACC890849	4TBO890849C0100 50
	M4 slider		
		APACC890841	4TBO890841C0100 50
	M4 washer		
		APACC890850	4TBO890850C0100 20
	Coupling set		
		APACC890840	4TBO890840C0100 20

General purpose enclosures

Accessories - General accessories

Profiles	Profile length	Enclosure width	Type	Order code	Pack
Type AB (C 15 x 8)					
	100mm	150	APACC890809	4TBO890809C0100	10
	135mm	185	APACC890812	4TBO890812C0100	10
	250mm	300	APACC890817	4TBO890817C0100	10
Type UB⁽¹⁾					
	90mm	150	APACC890810	4TBO890810C0100	10
	100mm	150	APACC890811	4TBO890811C0100	10
	135mm	185	APACC890814	4TBO890814C0100	10
	200mm	250	APACC890816	4TBO890816C0100	10
	250mm	300	APACC890820	4TBO890820C0100	10
	276mm	300	APACC890819	4TBO890819C0100	10
	320mm	370	APACC890824	4TBO890824C0100	10
	550mm	600	APACC890833	4TBO890833C0100	10
Type ZB (C 15 x 8)					
	476mm	55	APACC890830	4TBO890830C0100	10

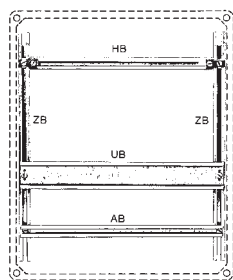

(1) DIN 46.277

Gemini: the improved range

Robust and flexible thermoplastic enclosures

Six different box sizes with internal space which accommodates from 24 to 216 DIN modules

Opaque or transparent doors, opening at more than 180°.

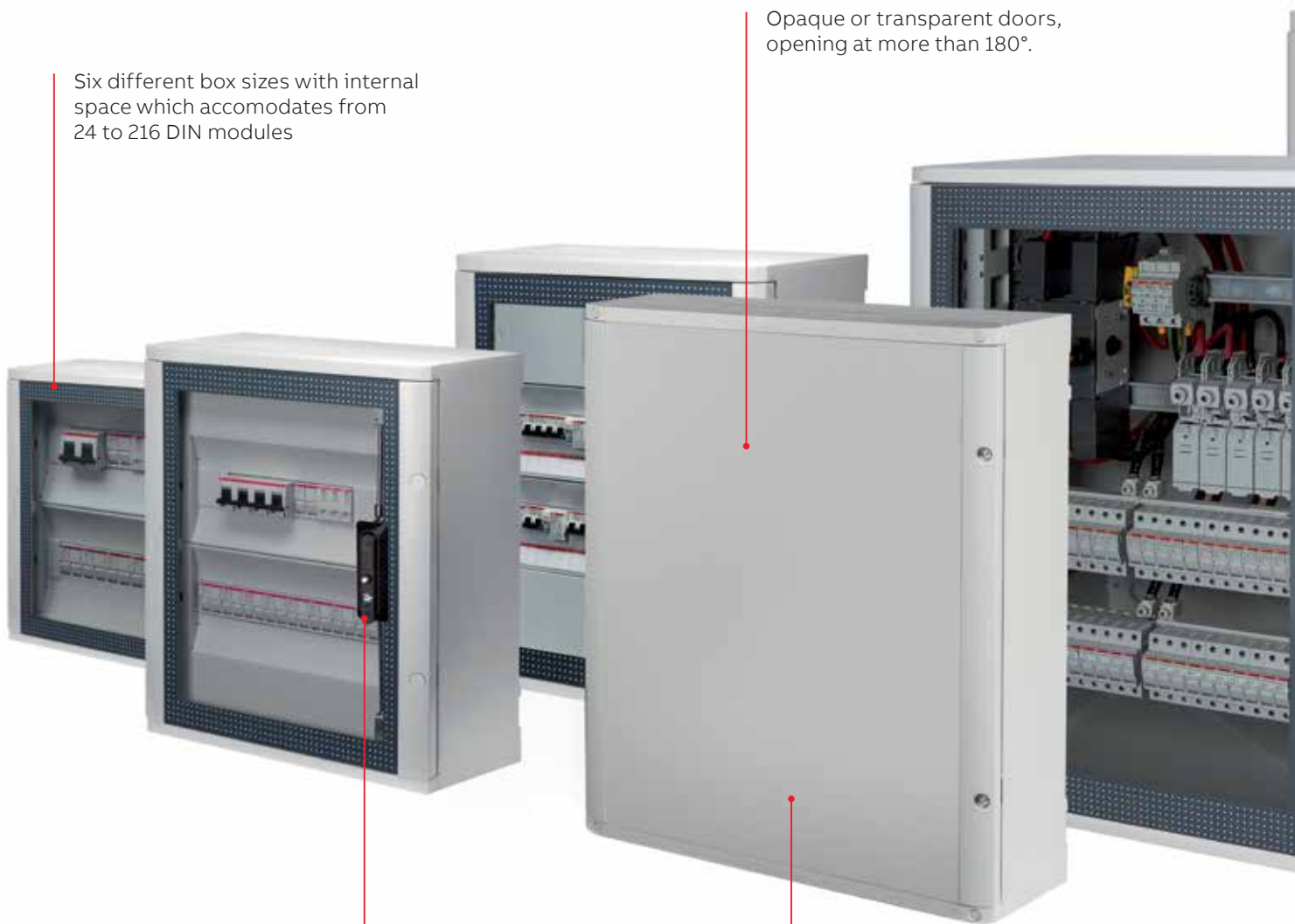

A single handle operates the door closing mechanism and it can be ordered separately.

Gemini is compliant to IEC62208 and UL 508A standards. IP66 certifies Gemini is completely protected against the infiltration of solid bodies and is resistant to the penetration of jets of water similar to sea waves.

High resistance: flexible and extremely sturdy. Resistant to harsh environments, chemical and atmospheric agents.



Suitable for outdoor installations, in any operating conditions: IP66, IK10, GWT=750°C, -25°C to 100°C.



Easy to install

Ready-to-use solutions are available to quickly install all the devices without using tools.



High degree of protection

Extremely sturdy, even against 20 joules impact, dust and water jets (IK10 and IP66 degree of protection), able to operate in a wide range of temperatures (25 up to 100°C), exceptionally resistant to UV and chemical agents and compliant with IEC 62208 and UL 508A standards.



Adaptable to customers' requirements

Available in 6 sizes and with transparent or blind door, with full metal and plastic base plates. Gemini can be used even in very difficult application circumstances and extreme weather conditions.



Eco-friendly

Thanks to co-injection technology, Gemini's thermoplastic not only ensures sturdiness, mechanical features and resistance to oils but it also reduces at the same time the environmental impact at the end of its useful life since it's 100% recyclable.

The thermoplastic co-injection molding process

It's like a "sandwich" of two materials: a compact external covering and an expanded core. This technology ensures the highest level of mechanical protection against impacts (IK10).



Easy to install

Versatile and simple. To meet any application.

Offering the best technology for more reliable energy distribution solutions, by protecting people, equipments and resources.

ABB's Gemini enclosures provide a real system of integrated and complementary functions making them configurable into different applications: for automation, distribution and combined automation and distribution.

Gemini is designed to be perfectly compatible with ABB components for low voltage control and monitoring. In mixed applications, the Gemini enclosure is designed to be fitted with System pro M modular devices and Tmax XT moulded-case circuit breakers. To respect safety standards, all the enclosure components are easy to fit and can be fixed to the base plate or to the box frame without using any tools.

Wiring operations are carried out from the front followed by snapping the base plate or the distribution frame onto the box.

The patented frame is fitted with the cable duct incorporated in the uprights.

Gemini is also flexible thanks to six different box sizes and internal space to accommodate from 24 to 216 DIN modules.

For control and command applications, three typologies of base plates are available: standard metal, perforated metal and insulated.

Lightweight thermoplastic material makes handling operation easier compared to traditional enclosure, for easier handling.



- Few parts: **snap-on fixing, no tools needed**
- **Pre-assembled hinges**
- Door with **180 degree rotation**
- Frame with **integrated vertical wiring duct**
- Frontal cabling: **comfort in the wiring process**
- **A wide range of accessories for automation and distribution applications**

—
01 Gemini doors open at an angle of more than 180° giving easy access to the devices installed inside the switchboard.

—
02 No tools are needed for installation. The doors hook onto the hinges with special hinge pins and are reversible.

—
03 The frame can be extracted to make wiring operations easier at the workbench.

—
04 The fixing hooks supplied in the standard versions are applied without having to use tools.

—
05 Fixing hooks and feet allow the frame to be snap-mounted inside the box.



High degree of protection

Designed to operate in harsh environments

Gemini is developed and designed by ABB together with the direct collaboration of panel builders, installers and designers in order to create insulating enclosures to better face extreme weather conditions.

Gemini represents the best solution for both distribution and automation (control and command) applications.

For a valid enclosure, the degree of protection is an important factor. Gemini thermoplastic enclosures are totally protected against the infiltration of solid bodies thanks to an IP66 degree of protection (IP30 with the door open and with the appropriate components installed) and a double insulation, even in the event of indirect contact.

—

They are suitable for environments with extreme temperatures, in outdoor applications and severe conditions.

Thermoplastic material retains its characteristics for a long time since it's not subject to corrosion from chemical and atmospheric agents such as dust and sand. In Mining or Construction applications as well as manufacturing plants, Gemini withstands harsh chemicals with high levels of performance.

Typical examples of some Gemini applications can be seen in Manufacturing sites, Solar power plants, greenhouses, chemical plants and in any other environments where distribution and automation demand specific safety requirements and service continuity.

It is particularly recommended in photovoltaic and greenhouse applications, also because of its strong resistance to UV rays.



- **IP66 degree of protection** (IP30 with the door open and with the appropriate components installed)
- **Double insulation from dust and water jets**, even in the event of indirect contact
- Adaptation to environments with extremely high or low temperatures (**-25°C to 100°C**), in outdoor applications and in severe conditions
- **Resistance to aggressive chemical agents and UV radiation**
- Resistance to fire and abnormal heat (**GWT up to 750°C**).
- Insulation Voltage: **1000 Vac; 1500 Vdc**
- UL Type **1, 3R, 4, 4X, 12**

Additional tests completed

- Dust/sand resistance (factory internal tested)
- Saline environments (according to IEC 60068-2-52)
- Weathering (according to IEC 60068-2-5)
- Permanent sun exposure (IEC 60068-2-5)





Photovoltaic

In a typical photovoltaic plant the direct current section comprises a generator consisting of strings composed of photovoltaic modules connected in series. The Gemini series of IP66 enclosures are ideal for use as field combiners or as parallel switchboards, i.e. for outdoor installation near the modules. ABB has a range which is currently unique on the market, and has developed a family of plug & operate solutions, i.e. a series of finished, wired and certified switchboards to meet the needs of a huge range of plant types: from single string for residential applications to large-scale solar fields (for more information see specific documentation on abb.com).

Adaptable to customers' requirements

Widest range and numerous accessories for a complete solution

With Gemini, you can benefit from a wide range of enclosures with different dimensions and the possibility to arrange the devices into the DIN-Rail as you need. Moreover, Gemini enclosures have a wide range of accessories for both automation and distribution applications, ensuring maximum versatility and integration.



Accessories

- Various locking systems can be installed (triangular, squared, with handles and ciphered type)
- Ventilation and anti-condensation kits: protecting devices from the effects of heat and humidity
- Wall brackets, pole mounting kit and pedestal make it easier to install the enclosures in any context.
- Kit for installing Tmax XT circuit-breakers
- The universal drill bit can be used to create the holes to install the cable glands for cable derivations
- Doors with single central handle (as per picture beside) can be fitted with half cylinder locking systems and/or padlock

—
01



—
02



—
03



—
01 Doors with central single handle are also available.

—
02 Wall-mounted installation is possible using the special mounting brackets.

—
03 ABB logo with its minimal graphic design fits well to hinged doors .

—
04 Pole-mounted or mounted on a special pedestal installation is also possible.

—
05 The standard double-bit locks supplied can be replaced by the version with ciphered key and handle or with square or triangular impression.

—
04



—
05

General purpose enclosures

Basic configuration - Gemini switchboards

In the basic configuration, Gemini switchboards are composed of boxes in six different sizes ranging from 335x400x210 mm to 840x1005x360 mm (WxHxD, external measurements) and with opaque or transparent doors. In both versions, the doors are reversible and clip onto the hinges without the need to use tools; the fact that they open at an angle of more than 180° means that it is easy to work on the components installed inside the switchboard. The seal applied by extrusion along the sides of the doors guarantees IP66 degree of protection. Access to the inside of the switchboard is protected by a standard double bit

lock that can be replaced by locks of another type available in the accessories. Boxes and doors can be requested either separately or as combined "box + door" codes, to make filling out the order form more flexible. Inside the packages, the door is always wrapped separately and inserted inside a pocket that protects it from accidental damage until wiring is completed and the switchboard is installed. Hole-cover plugs to guarantee IP protection and double insulation for wall mounting are also supplied with the pack together with the instruction sheet.

Specifications	
Protection	IP66 (IEC EN 60529) Class II insulation
Strength	Thermoplastic material moulded in co-injection Resistance to abnormal heat and fire up to a temperature of 750 °C (IEC EN 60695-2-11) IK10 (IEC EN 50102) degree of resistance to impacts Protection against chemical and atmospheric agents (water, saline solutions, acids, basic agents, mineral oils, UV rays) Operating temperature -25 °C ÷ +100 °C
Performances	Rated service voltage up to 1000 V Rated insulating DC voltage up to 1000 V Rated insulating AC voltage up to 1500 V
Flexibility of use	6 sizes from 335x400x210 mm to 840x1005x360 mm (WxHxD, external dimensions) DIN 24 to 216 modules
Installation	Snap-on mounting of all components in compliance with safety Standards
Quality and environment	Compliance with CEI EN 62208 international reference Standard, qualification for the requirements of CEI EN 61439-1 Standard, IMQ mark according to EN 62208 Standard. 100% recyclable EN 60068-2-52 resistance to marine environments EN60068-2-5 resistance direct sun exposure UL Listed: UL508A, UL50, UL50E Nema: Types 1, 3R, 4, 4X, 12



Gemini doors open at an angle of more than 180° giving easy access to the devices installed inside the switchboard.



No tools are needed for installation. The doors hook onto the hinges with special hinge pins and are reversible.



The special structure of the inner perimeter of the box ensures further protection against the penetration of water. The box is supplied with a spirit level.

General purpose enclosures

Basic configuration - Gemini switchboards

Boxes and doors

- Available in 6 sizes
- Single order code combined with box and transparent and opaque door
- Pack with door dismounted and wrapped separately
- Door designed so that it can be hooked onto hinges at both vertical sides and mounted without the use of tools
- To be mounted to the wall using internal holes or fixing brackets supplied as accessories
- Door opening at an angle of more than 180°
- RAL 7035 grey color
- Doors supplied with 2 standard double bit locks (3 for sizes 5 and 6) that can be replaced with locks for ciphered key or with square/triangular impression (the standard triplex key is suitable for use with three types of impressions).

Transparent door

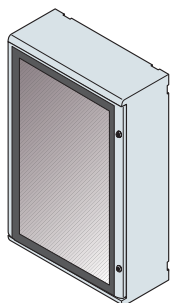

Transparent door switchboard

Size	External		Modules		Code	Unit/Pack
	Dimensions WxHxD (mm)	Internal WxHxD (mm)	Max No. DIN mod.	No. vertical mod. (H=150 mm)		
1	335x400x210	250x300x180	24 (12x2)	2	1SL0211A00	1/1
2	460x550x260	375x450x230	54 (18x3)	3	1SL0212A00	1/1
3	460x700x260	375x600x230	72 (18x4)	4	1SL0213A00	1/1
4	590x700x260	500x600x230	96 (24x4)	4	1SL0214A00	1/1
5	590x855x360	500x750x330	120 (24x5)	5	1SL0215A00	1/1
6	840x1005x360	750x900x330	216 (36x6)	6	1SL0216A00	1/1

Opaque door

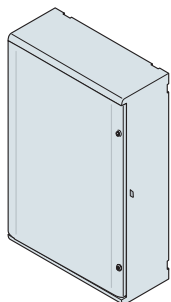

Opaque door switchboard

Size	External		Modules		Code	Unit/Pack
	Dimensions WxHxD (mm)	Internal WxHxD (mm)	Max No. DIN mod.	No. vertical mod. (H=150 mm)		
1	335x400x210	250x300x180	24 (12x2)	2	1SL0201A00	1/1
2	460x550x260	375x450x230	54 (18x3)	3	1SL0202A00	1/1
3	460x700x260	375x600x230	72 (18x4)	4	1SL0203A00	1/1
4	590x700x260	500x600x230	96 (24x4)	4	1SL0204A00	1/1
5	590x855x360	500x750x330	120 (24x5)	5	1SL0205A00	1/1
6	840x1005x360	750x900x330	216 (36x6)	6	1SL0206A00	1/1

General purpose enclosures

Basic configuration - Gemini switchboards

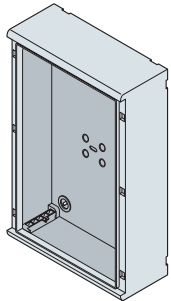

Single box

Single boxes

Size	External dimensions WxHxD (mm)	Internal WxHxD (mm)	Code	Unit/Pack
1	335x400x210	250x300x180	1SL0221A00	1/1
2	460x550x260	375x450x230	1SL0222A00	1/1
3	460x700x260	375x600x230	1SL0223A00	1/1
4	590x700x260	500x600x230	1SL0224A00	1/1
5	590x855x360	500x750x330	1SL0225A00	1/1
6	840x1005x360	750x900x330	1SL0226A00	1/1

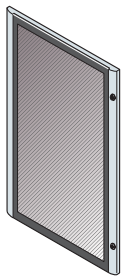

Transparent door

Single doors

Transparent door

Size	Box dimensions WxHxD (mm)	Code	Unit/Pack
1	335x400x210	1SL0241A00	1/1
2	460x550x260	1SL0242A00	1/1
3	460x700x260	1SL0243A00	1/1
4	590x700x260	1SL0244A00	1/1
5	590x855x360	1SL0245A00	1/1
6	840x1005x360	1SL0246A00	1/1

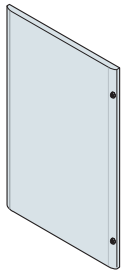

Opaque door

Opaque door

Size	Box dimensions WxHxD (mm)	Code	Unit/Pack
1	335x400x210	1SL0231A00	1/1
2	460x550x260	1SL0232A00	1/1
3	460x700x260	1SL0233A00	1/1
4	590x700x260	1SL0234A00	1/1
5	590x855x360	1SL0235A00	1/1
6	840x1005x360	1SL0236A00	1/1

Door with handle

Transparent door with handle

Size	Box dimensions WxHxD (mm)	Code	Unit/Pack
3	460x700x260	1SLM006600A0243	1/1
4	590x700x260	1SLM006600A0244	1/1
5	590x855x360	1SLM006600A0245	1/1
6	840x1005x360	1SLM006600A0246	1/1

Opaque door with handle

Size	Box dimensions WxHxD (mm)	Code	Unit/Pack
3	460x700x260	1SLM006600A0233	1/1
4	590x700x260	1SLM006600A0234	1/1
5	590x855x360	1SLM006600A0235	1/1
6	840x1005x360	1SLM006600A0236	1/1



General purpose enclosures

Components for automation applications

Gemini switchboards are designed to be perfectly compatible with ABB components for low voltage control and monitoring. For these applications they can be equipped with modular devices belonging to the System pro M range, with Tmax moulded-case circuit-breakers and control and signalling devices, creating a truly integrated automation system. When deciding the Gemini layout for control and monitoring applications, not only is it possible to select the box and door in the required size, but you can also select the base plate in one of the three versions in the range.

After wiring with the ducts and the Fix-O-Rapid device, the special standard adjustable feet and hooks must be fitted onto the base plate, allowing it to be inserted inside the box at up to seven different depths and three further levels of adjustment: no tools need to be used to carry out these operations. To finish the job, the inner door can be mounted (reversible and in insulating material), guaranteeing IP30 degree of protection when the switchboard door is open. No tools are needed unless the inner door is equipped with buttons, warning lights, etc.



The fixing hooks and feet supplied in the standard versions are applied without having to use tools, making it possible to install the base plate at seven different depths inside the switchboard. They can also be adjusted at three further positions.

Application of the inner door guarantees IP30 degree of protection when the switchboard door is open.



Example of the configuration of a switchboard for an automation application: some ABB control and protection devices are installed on the plate. The inner door is fitted with light-signaling devices.

General purpose enclosures

Components for automation applications

Base plates

- Available in three versions in blank or drilled metal and insulating material
- Positioning at 3 different depths for size 1, 4 different depths for sizes 2-3-4 and 7 different depths for sizes 5-6 (adjustments with 30 mm pitch)
- Supplied with feet and hooks adjustable at three further positions (with 7.5 mm pitch)
- Snap-on mounting
- Plates can also be mounted directly on the base with the special kit.

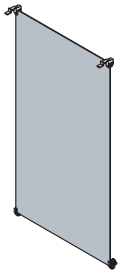

Blank metal base plate

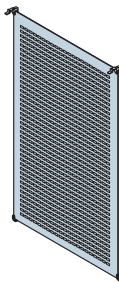

Drilled metal base plate

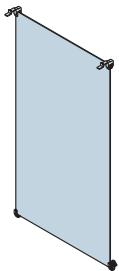

Insulating material base plate

Blank metal

Size of the switchboard	Code	Unit/Pack
1	1SL0259A00	1/6
2	1SL0260A00	1/6
3	1SL0261A00	1/4
4	1SL0262A00	1/4
5	1SL0263A00	1/4
6	1SL0264A00	1/2

Drilled metal

Size of the switchboard	Code	Unit/Pack
1	1SL0275A00	1/6
2	1SL0276A00	1/6
3	1SL0277A00	1/4
4	1SL0278A00	1/4
5	1SL0279A00	1/4
6	1SL0280A00	1/2

Insulating material

Size of the switchboard	Code	Unit/Pack
1	1SL0267A00	1/6
2	1SL0268A00	1/6
3	1SL0269A00	1/4
4	1SL0270A00	1/4
5	1SL0271A00	1/4
6	1SL0272A00	1/2

Description	Code	Unit/Pack
Base mounting kit for metal plate	1SL0383A00	1/10

General purpose enclosures

Components for automation applications

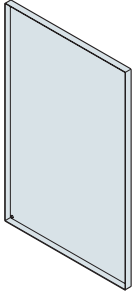

Inner door, sizes 1-2

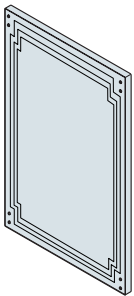

Inner door, sizes 3-4-5-6

Inner doors

- Made in insulating material
- IP30 degree of protection with door open
- Designed so that door can be hinged onto both vertical sides
- Snap-on mounting and fixing

Size of the switchboard	Code	Unit/Pack
1	1SL0251A00	1/4
2	1SL0252A00	1/4
3	1SL0253A00	1/2
4	1SL0254A00	1/2
5	1SL0255A00	1/2
6	1SL0256A00	1/1

General purpose enclosures

Components for automation applications

Wiring ducts

- Made in self-extinguishing thermoplastic material (UL 94 V0), resistant to abnormal heat and fire up to 960 °C (IEC 695-2-1)
- RAL 7030 grey color
- Available in version with 8/12 mm and 4/6 mm slots
- Base strip designed to snap onto Fix-O-Rapid
- Available in standard lengths of 2 m

With 8/12 mm slots

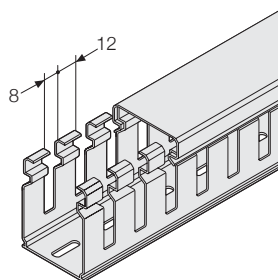

Wiring duct
with 8/12 mm slot

Dimensions WxH (mm)	Code	Weight (kg/m)	Unit/ Pack- meters
15x17	05 019	0,06	46
25x30	05 033	0,21	58
25x40	05 043	0,25	48
25x60	05 063	0,24	34
25x80	05 083	0,29	28
25x100	05 094	0,46	20
40x30	05 035	0,27	40
40x40	05 045	0,31	30
40x60	05 065	0,34	22
40x80	05 085	0,38	36
40x100	05 095	0,53	28
60x30	05 037	0,38	52
60x40	05 047	0,46	40
60x60	05 067	0,47	32
60x80	05 087	0,50	24
60x100	05 096	0,73	20
80x40	05 049	0,47	32
80x60	05 069	0,52	24
80x80	05 089	0,59	16
80x100	05 097	0,91	14
100x40	05 051	0,55	24
100x60	05 071	0,59	20
100x80	05 091	0,68	16
100x100	05 098	1,06	8
120x40	05 053	0,65	20
120x60	05 073	0,73	14
120x80	05 093	0,89	12
150x100	05 099	1,37	8

General purpose enclosures

Components for automation applications

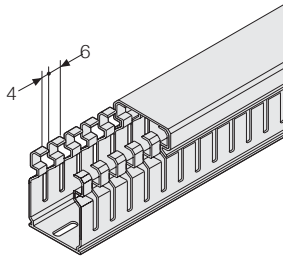

Wiring duct
with 4/6 mm slot

With 4/6 mm slots

Dimensions WxH (mm)	Code	Weight (kg/m)	Unit/ Pack- meters
15x17	05 119	0,06	46
25x30	05 133	0,21	58
25x40	05 143	0,25	48
25x60	05 163	0,24	34
25x80	05 183	0,29	28
25x100	05 194	0,46	20
40x30	05 135	0,27	40
40x40	05 145	0,31	30
40x60	05 165	0,34	22
40x80	05 185	0,38	36
40x100	05 195	0,53	28
60x30	05 137	0,38	52
60x40	05 147	0,46	40
60x60	05 167	0,47	32
60x80	05 187	0,50	24
60x100	05 196	0,73	20
80x40	05 149	0,47	32
80x60	05 169	0,52	24
80x80	05 189	0,59	16
80x100	05 197	0,91	14
100x40	05 151	0,55	24
100x60	05 171	0,59	20
100x80	05 191	0,68	16
100x100	05 198	1,06	8
120x40	05 153	0,65	20
120x60	05 173	0,73	14
120x80	05 193	0,89	12
150x100	05 199	1,37	8

Fix-O-Rapid

Rapid mounting device for attaching wiring ducts to the base plate: it snaps onto the plate after drilling a $\varnothing 7$ mm hole. Two Fix-O-Rapid devices are enough for each wiring duct section. Fix-O-Rapid guarantees maximum insulation since it does not involve the use of any metal component inside the wiring duct. If the wrong wiring duct is selected, it can be dismounted and a version with the same base and a different height can be attached to the Fix-O-Rapid.

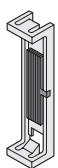

Fix-O-Rapid

Description	Code	Unit/ Pack-no. pieces
Rapid mounting device for wiring duct, W 25 mm	05 270	20/600
Rapid mounting device for wiring duct, W 40 mm	05 272	20/600
Rapid mounting device for wiring duct, W 60 mm	05 274	20/600
Rapid mounting device for wiring duct, W 80 mm	05 276	20/240
Rapid mounting device for wiring duct, W 100 mm	05 278	20/240
Rapid mounting device for wiring duct, W 120 mm	05 280	20/240
Rapid mounting device for wiring duct, W 150 mm	05 282	20/240

General purpose enclosures

Components for distribution and mixed applications

In distribution and mixed applications, the Gemini switchboard is designed to be fitted with System pro M modular devices and Tmax moulded-case circuit breakers. The frame is the load-bearing element of the configuration: DIN rails, partial modular plates and the special Tmax mounting and cabling kits are snapped onto the uprights.

All the components can be adjusted to six different depths with a pitch of 12.5 mm and arranged at heights with standard installation pitch of 150, 225 and 300 mm and a distance of 75 mm between the rows.

Blank or drilled front panels are applied to protect the equipment and these can be hinged onto both sides; the cables are housed inside the vertical wiring duct integrated in the uprights according to an exclusive ABB patent. Wiring is carried out by pulling out the frame and working from the front; the ergonomic grip and the standard feet and snap-on hooks supplied make it easy to insert it inside the switchboard after the job is finished.



The DIN rail is supplied with special hooks already in position for attaching to the uprights.



The upright with the incorporated wiring duct is an exclusive ABB patent that rationalizes the path of cables inside the switchboard.



The depth at which the DIN rail, the modular plates, the kit for fixing the Tmax circuit breakers and the wiring duct are positioned can be adjusted with a simple sliding movement.



The frame can be extracted to make wiring operations easier at the workbench.



The blank and drilled panels are hinged onto both sides; the description of the installed components can be kept in the special compartment protected by a transparent, hinged flange.



Fixing hooks and feet allow the frame to be snap-mounted inside the box.

General purpose enclosures

Components for distribution and mixed applications

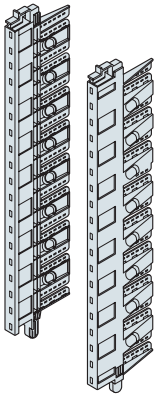

Uprights

Uprights

- Incorporated vertical wiring duct (ABB patent)
- Snap-on mounting of all components (installation pitch of 75 mm)
- Snap-on insertion into box
- Depth of installed components adjusted at a pitch of 12.5 mm
(4 positions for uprights of size 1 and 6 positions for the remaining ones)
- Ergonomic grip to make it easy to insert and extract

Size of the switchboard	Code	Unit/Pack
1	1SL0283A00	1/4
2	1SL0284A00	1/4
3	1SL0285A00	1/4
4	1SL0285A00	1/4
5	1SL0286A00	1/2
6	1SL0287A00	1/1

DIN rails

- Two-sided version
- Supplied with mounting supports that snap onto uprights
- Depth adjustment on uprights
- Designed so that rapid Unifix L mounting bars can be snapped on

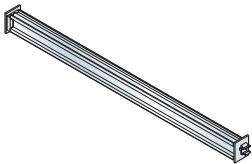

DIN rail

Size of the switchboard	Modules per row	Code	Unit/Pack
1	12	1SL0290A00	1/10
2	18	1SL0291A00	1/10
3	18	1SL0291A00	1/10
4	24	1SL0292A00	1/10
5	24	1SL0292A00	1/10
6	36	1SL0293A00	1/10

General purpose enclosures

Components for distribution and mixed applications

Drilled panels

- Supplied with DIN rail complete with supports to snap onto uprights and adjustable in depth
- Available in 1 module (H 150 mm) and 1+1/2 module (H 225 mm, sizes 2-6) dimensions
- Designed to be hinged onto both vertical sides
- Snap-on mounting onto uprights (in compliance with reference Standards a tool must be used for removing the panel)
- Document pocket for storing descriptions of installed devices

1 module

Size of the switchboard	Code	Unit/Pack
1	1SL0307A00	1/8
2	1SL0308A00	1/8
3	1SL0308A00	1/8
4	1SL0309A00	1/4
5	1SL0309A00	1/4
6	1SL0310A00	1/2

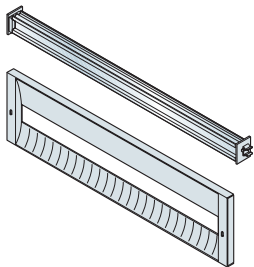

Drilled panel, 1 module

1 + 1/2 module

Size of the switchboard	Code	Unit/Pack
2	1SL0313A00	1/8
3	1SL0313A00	1/8
4	1SL0314A00	1/4
5	1SL0314A00	1/4
6	1SL0315A00	1/2

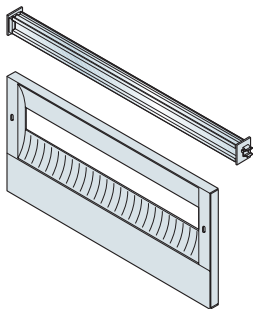

Drilled panel, 1 + 1/2 module

General purpose enclosures

Components for distribution and mixed applications

Blank panels

- Available in 1/2 module (H 75 mm), 1 module (H 150 mm) and 2 modules (H 300 mm) dimensions
- H 150 mm and H 300 panels designed to be hinged onto both vertical sides
- Snap-on mounting onto uprights (in compliance with reference Standards a tool must be used for removing the panel)

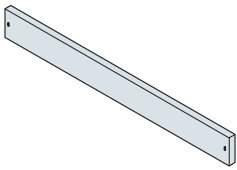

Blank panel, 1/2 module

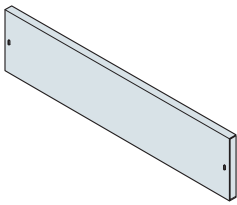

Blank panel, 1 module

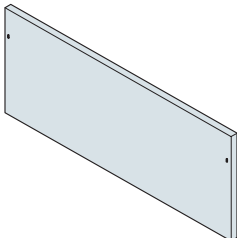

Blank panel, 2 modules

1/2 module

Size of the switchboard	Code	Unit/Pack
1	1SL0318A00	1/10
2	1SL0319A00	1/10
3	1SL0319A00	1/10
4	1SL0320A00	1/6
5	1SL0320A00	1/6
6	1SL0321A00	1/4

1 module

Size of the switchboard	Code	Unit/Pack
1	1SL0324A00	1/8
2	1SL0325A00	1/8
3	1SL0325A00	1/8
4	1SL0326A00	1/4
5	1SL0326A00	1/4
6	1SL0327A00	1/4

2 modules

Size of the switchboard	Code	Unit/Pack
1	1SL0330A00	1/6
2	1SL0331A00	1/6
3	1SL0331A00	1/6
4	1SL0332A00	1/4
5	1SL0332A00	1/4
6	1SL0333A00	1/4

General purpose enclosures

Components for distribution and mixed applications

Partial modular plates

- Available in 1 module (H 150 mm) and 2 module (H 300 mm, sizes 2-6) dimensions
- Snap-on mounting onto uprights with depth adjustment.

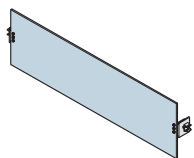

Partial modular plate,
1 module

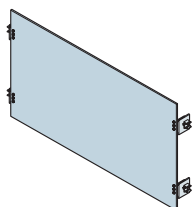

Partial modular plate,
2 modules

1 module

Size of the switchboard	Code	Unit/Pack
1	1SL0296A00	1/6
2	1SL0297A00	1/4
3	1SL0297A00	1/4
4	1SL0298A00	1/4
5	1SL0298A00	1/4
6	1SL0299A00	1/2

2 modules

Size of the switchboard	Code	Unit/Pack
2	1SL0302A00	1/4
3	1SL0302A00	1/4
4	1SL0303A00	1/4
5	1SL0303A00	1/4
6	1SL0304A00	1/2

General purpose enclosures

Components for distribution and mixed applications

Kit for installing Tmax XT moulded-case circuit breakers

- For installing Tmax XT moulded-case circuit breakers in fixed version with front terminals
- Composed of a plate with special drilled holes and a protection panel with vertical slots that can be hinged on both sides and snap-on mounted (in compliance with reference Standards a tool must be used for removing the panel)
- Available for sizes 2-6
- Snap-on mounting onto uprights with the possibility of adjusting the plate depth

H 150 mm

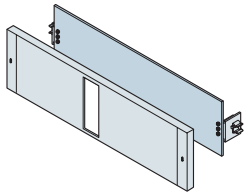

H 150 mm

Size of the switchboard	Code	Unit/Pack
2	1SL0373A00	1/4
3	1SL0373A00	1/4
4	1SL0374A00	1/4
5	1SL0374A00	1/4
6	1SL0375A00	1/2

H 300 mm

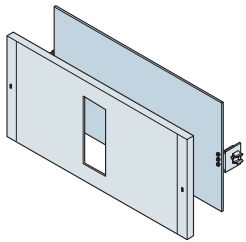

H 300 mm

Size of the switchboard	Code	Unit/Pack
2	1SL0376A00	1/4
3	1SL0376A00	1/4
4	1SL0377A00	1/4
5	1SL0377A00	1/4
6	1SL0378A00	1/2

General purpose enclosures

Components for distribution and mixed applications

Kit selection

Size	Installation	XT1				XT2				XT3				XT4				
		3p	4p	3p D	4p D	3p	4p	3p D	4p D	3p	4p	3p D	4p D	3p	4p	3p D	4p D	
1	D	■	■	■	■	■	■	■	■	■	■	■	■	■	■	■	■	
	O1	■	■	■	■	■	■	■	■	■	■			■	■			
	T	■	■	■	■	■	■	■	■	■	■	■	■	■	■	■	■	
2	D	■	■	■	■	■	■	■	■	■	■	■	■	■	■	■	■	
	K1	■	■	■														
	K2		■	■	■						■	■	■	■				
	O1	■	■	■	■	■	■	■	■	■	■	■	■		■	■	■	■
	O2	■	■	■	■	■	■	■	■	■	■	■	■	■	■	■	■	■
	T	■	■	■	■	■	■	■	■	■	■	■	■	■	■	■	■	■
3	D	■	■	■	■	■	■	■	■	■	■	■	■	■	■	■	■	
	K1	■	■	■														
	K2		■	■	■						■	■	■	■				
	O1	■	■	■	■	■	■	■	■	■	■	■	■		■	■	■	■
	O2	■	■	■	■	■	■	■	■	■	■	■	■	■	■	■	■	■
	T	■	■	■	■	■	■	■	■	■	■	■	■	■	■	■	■	■
4	D	■	■	■	■	■	■	■	■	■	■	■	■	■	■	■	■	
	K1	■	■	■														
	K2		■	■	■						■	■	■	■				
	O1	■	■	■	■	■	■	■	■	■	■	■	■		■	■	■	■
	O2	■	■	■	■	■	■	■	■	■	■	■	■	■	■	■	■	■
	T	■	■	■	■	■	■	■	■	■	■	■	■	■	■	■	■	■
5	D	■	■	■	■	■	■	■	■	■	■	■	■	■	■	■	■	
	K1	■	■	■														
	K2		■	■	■						■	■	■	■				
	O1	■	■	■	■	■	■	■	■	■	■	■	■		■	■	■	■
	O2	■	■	■	■	■	■	■	■	■	■	■	■	■	■	■	■	■
	T	■	■	■	■	■	■	■	■	■	■	■	■	■	■	■	■	■
6	D	■	■	■	■	■	■	■	■	■	■	■	■	■	■	■	■	
	K1	■	■	■														
	K2		■	■	■						■	■	■	■				
	O1	■	■	■	■	■	■	■	■	■	■	■	■		■	■	■	■
	O2	■	■	■	■	■	■	■	■	■	■	■	■	■	■	■	■	■
	T	■	■	■	■	■	■	■	■	■	■	■	■	■	■	■	■	■

Caption

- D, installation on DIN rail
- K1, installation with Tmax kit H = 150 (holes made)
- K2, installation with Tmax kit H = 300 (holes made)
- O1, installation on modular plate (1 module, H = 150 mm)
- O2, installation on modular plate (2 modules, H = 300 mm)
- T, installation on total base plate

General purpose enclosures

Components for distribution and mixed applications

Wiring kits

- composed of wiring duct in versions 25x60 mm and 40x60 mm (WxH, 8-12 mm slots) and Fix-O-Rapid
- Snap-on mounting on uprights with depth adjustment

Wiring duct 25x60 mm

Size of the switchboard	Code	Unit/Pack
1	1SL0353A00	1/4
2	1SL0354A00	1/4
3	1SL0354A00	1/4
4	1SL0355A00	1/4
5	1SL0355A00	1/4
6	1SL0356A00	1/4

Wiring duct 40x60 mm

Size of the switchboard	Code	Unit/Pack
1	1SL0360A00	1/4
2	1SL0361A00	1/4
3	1SL0361A00	1/4
4	1SL0362A00	1/4
5	1SL0362A00	1/4
6	1SL0363A00	1/4

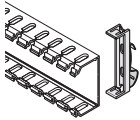
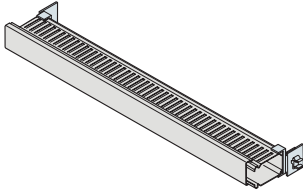

Wiring kit

General purpose enclosures

Accessories

Gemini switchboards have the same accessories for both automation and distribution applications, ensuring maximum versatility and integration of functions. In particular, the ventilation and anti-condensation kits make it even safer for the devices to run, protecting them from the effects of heat and humidity while the wall brackets, pole mounting kit and pedestal make it easier to install the switchboards in any context.

Three different kinds of locks are supplied for the doors with which it is possible to replace the standard double bit model. The universal drill bit can be used to open the side branch connections. Module covers hide the unused modules of the DIN rail guaranteeing IP40 protection when the door is open in distribution and mixed configurations.



The standard locks supplied can be replaced by the version with ciphered key and handle or with square or triangular impression.



Gemini wall-mounted installation using the special mounting brackets.



The fact that Gemini switchboards can also be pole-mounted (see photo above) or mounted on a special pedestal (see photo at the side) makes them suitable for any application situation.

General purpose enclosures

Accessories

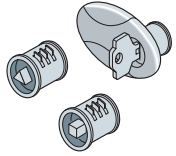

Locks

Locks

Available in three versions with ciphered key and handle, with triangular and square impressions.

Description	Code	Unit/Pack
Lock with Yale type ciphered key and handle	1SL0340A00	1/10
Lock with triangular impression	1SL0341A00	1/10
Lock with square impression	1SL0339A00	1/10
Tamper-proof locking kit (code 1SLO340A00 included)	1SL0458A00	1/10
Gemini standard lock	1SL0459A00	1/10



Locks for doors with handle

Description	Code	Unit/Pack
Yale Lock for door with handle	1SLM006600A0459	1/5
Ronis 455 lock for door with handle	1SLM006600A0460	1/5

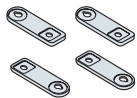

Plastic wall brackets

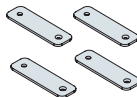

Stainless steel wall brackets

Mounting elements

Guarantee optimum wall, pole and floor mounting conditions.

Description	Code	Unit/Pack
Horizontal and vertical plastic wall brackets (4 pieces)*	1SL0342A00	1/10
Horizontal and vertical plastic wall brackets UL listed (4 pieces)	1SLM006600A0342	1/10
Horizontal and vertical stainless steel wall brackets (4 pieces)	1SL0401A00	1/10
Pole mounting kit for sizes 1 switchboards**	1SL0343A00	1/4
Pole mounting kit for sizes 2-3 switchboards**	1SL0344A00	1/4
Pole mounting kit for sizes 4-5 switchboards**	1SL0345A00	1/2
Pole mounting kit for size 6 switchboards**	1SL0346A00	1/2
IP43 Floor mounting pedestal for sizes 1-4	1SL0352A00	1/1

* There are two types of inserts for adapting brackets to $\varnothing 6$ e 8 mm fixing devices.

** The kit includes two elements for fixing the upper and the lower part of the switchboard.

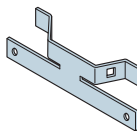

Pole mounting kit

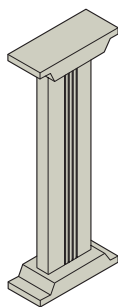

Floor mounting pedestal

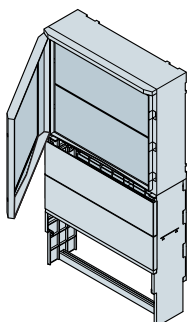

Pedestal

Pedestals

Allows the application of the Gemini switchboard to the ground without the need to prepare the construction of concrete footings or foundations when the pedestal is buried.

Description	Code	Unit/Pack
Pedestal Gemini size 4	1SL0464A00	1/1
Pedestal Gemini size 5	1SL0465A00	1/1
Pedestal Gemini size 6	1SL0466A00	1/1

General purpose enclosures

Accessories

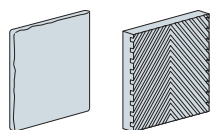

Ventilation kit

IP21/54 ventilation kits

- Composed of plastic grills and filter to ensure switchboard ventilation.
- Degree of protection without filter: IP21.
- Degree of protection with filter: IP54.
- Preassembled seal.

Description	Dimensions (mm)	Code	Unit/Pack
Grid + air flow kit	105x105	EN0105K	1/1
Grid + air flow kit (not suitable for size. 1)	150x150	EN0150K	1/1
Grid + air flow kit (not suitable for size. 1)	204x204	EN0204K	1/1

Note: screws not included; use 4 self lock screws 2,9x13 or ask for order code 1SL0384A00.

Base covers

For aesthetic as well as functional purposes, in particular for pedestal installations.

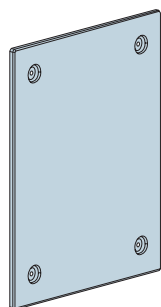

Base cover

Size of the switchboard	Code	Unit/Pack
1	1SL0385A00	1/4
2	1SL0386A00	1/4
3	1SL0387A00	1/2
4	1SL0388A00	1/2
5	1SL0389A00	1/2
6	1SL0390A00	1/2

Coupling kits

It follows the aesthetic outline of the boxes.

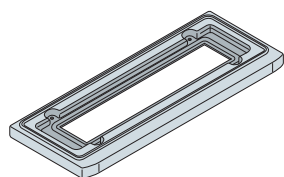

Coupling kit

Description	Code	Unit/Pack
Vertical coupling kit for sizes 2-3 switchboards	1SL0413A00	1/2
Vertical coupling kit for sizes 4 switchboards	1SL0414A00	1/2
Vertical coupling kit for sizes 5 switchboards	1SL0415A00	1/2
Vertical coupling kit for sizes 6 switchboards	1SL0416A00	1/2

General purpose enclosures

Accessories

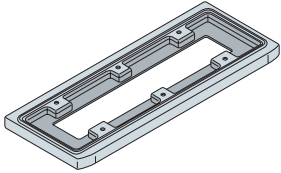

Bottom base

Bottom bases H 30

For fixing the Gemini switchboard directly to the floor.

Description	Code	Unit/Pack
Bottom base for size 2-3 switchboards	1SL0423A00	1/2
Bottom base for size 4 switchboards	1SL0424A00	1/2
Bottom base for size 5 switchboards	1SL0425A00	1/2
Bottom base for size 6 switchboards	1SL0426A00	1/2

Fixed frames

- In combination with bottom base H 30
- For fixing onto poured concrete floors and bases.

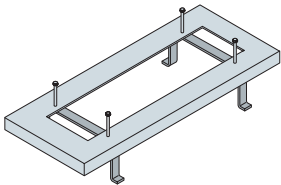

Fixed frame

Description	Code	Unit/Pack
Fixed frame for size 2-3 switchboards	1SL0433A00	1/2
Fixed frame for size 4 switchboards	1SL0434A00	1/2
Fixed frame for size 5 switchboards	1SL0435A00	1/2
Fixed frame for size 6 switchboards	1SL0436A00	1/2

Integral covers

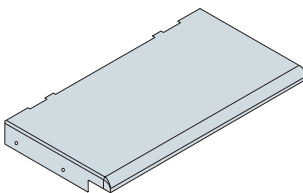

Integral cover

Description	Code	Unit/Pack
Integral cover for size 1 switchboard	1SL0451A00	1/1
Integral cover for size 2-3 switchboard	1SL0452A00	1/1
Integral cover for size 4 switchboard	1SL0454A00	1/1
Integral cover for size 5 switchboard	1SL0455A00	1/1
Integral cover for size 6 switchboard	1SL0456A00	1/1

Horizontal Kits

Kit for a proper opening of switchboard upward.

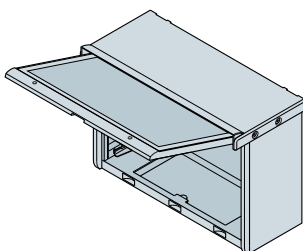

Horizontal Kit Gemini

Description	Code	Unit/Pack
Horizontal Kit Gemini size 3	1SL0470A00	1/1
Horizontal Kit Gemini size 4	1SL0471A00	1/1
Horizontal Kit Gemini size 5	1SL0472A00	1/1

General purpose enclosures

Accessories

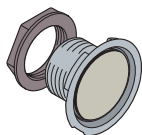

Base socket

Anti-condensation kits

- Kit in special material to prevent condensation from forming inside the switchboard: it include **GORE™ MEMBRANE VENTING**
- Impermeable to water (pressure): 0.6 bar / 60 sec.
- Air flow: 400 ml/min. (dp = 70 mbar)
- 1 kit for sizes 1-2, 2 kits for sizes 3-4 and 3 kits for sizes 5-6 are recommended to guarantee adequate dissipation; in any case the number of kits to be installed depend on the number and type of devices installed inside the switchboard
- IP66

Description	Code	Unit/Pack
Anti-condensation kit	1SL0351A00	1/6

Other accessories

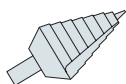

Universal drill bit

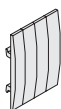

Module covers

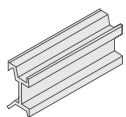

Spacer

Description	Code	Unit/Pack
Universal drill bit	12894	1/30
Module covers in RAL 7035 grey, 4 modules	12863	25/300
Plastic spacer for installing modular devices and moulded-case circuit breakers at the same depth	12851	10/60
Small bag plate mounting kit	1SL0383A00	1/10
Small bag for ventilation kit	1SL0384A00	10/50

Temperature management

IP20 heater

Description	Dimensions (mm)			Code	Package/ No. of pieces
	H	W	D		
Anti-condensation heater 30W, 110-240 Vac-dc	115	42	42	VA7930	1/1
Anti-condensation heater 50W, 110-240 Vac-dcc	165	42	42	VA7950	1/1
Anti-condensation heater 75W, 110-240 Vac-dc	210	42	42	VA7975	1/1
Anti-condensation heater 100W, 110-240 Vac-dc	165	42	51	VA7910	1/1
Anti-condensation heater 150W, 110-240 Vac-dc	146	82	51	VA7915	1/1
Anti-condensation heater with fan 300W, 230 Vac-dc	148	82	91	VA8300	1/1

For technical details, see page 50.

General purpose enclosures

Fast selection table

Basic configuration

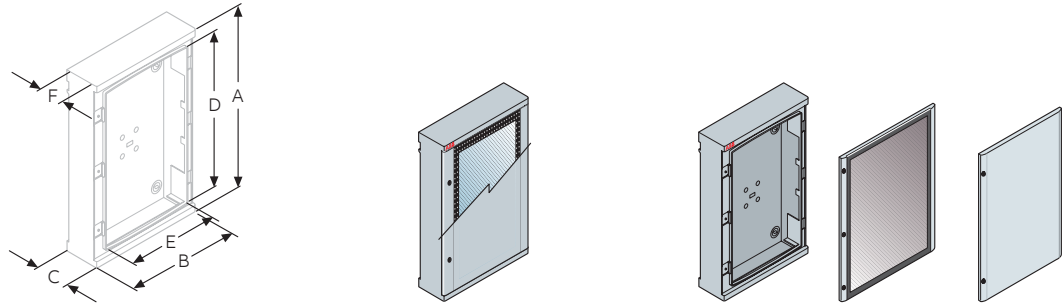

Size	No. of installable DIN modules (mod. x row)	No. of vertical mod. (H=150 mm)	External dimensions			Internal dimensions			Complete switchboard		Box	Door	
			A	B	C	D	E	F	Transparent door	Opaque door		Transparent	Opaque
1	24 (12x2)	2	400	335	210	300	250	180	1SL0211A00	1SL0201A00	1SL0221A00	1SL0241A00	1SL0231A00
2	54 (18x3)	3	550	460	260	450	375	230	1SL0212A00	1SL0202A00	1SL0222A00	1SL0242A00	1SL0232A00
3	72 (18x4)	4	700	460	260	600	375	230	1SL0213A00	1SL0203A00	1SL0223A00	1SL0243A00	1SL0233A00
4	96 (24x4)	4	700	590	260	600	500	230	1SL0214A00	1SL0204A00	1SL0224A00	1SL0244A00	1SL0234A00
5	120 (24x5)	5	855	590	360	750	500	330	1SL0215A00	1SL0205A00	1SL0225A00	1SL0245A00	1SL0235A00
6	216 (36x6)	6	1005	840	360	900	750	330	1SL0216A00	1SL0206A00	1SL0226A00	1SL0246A00	1SL0236A00

Components for automation

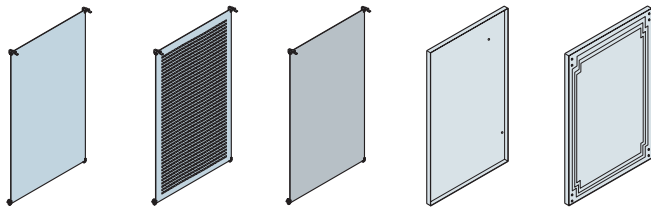

Size	Base plate			Inner door	
	Blank	Drilled	Insulating	Former version	New version
1	1SL0259A00	1SL0275A00	1SL0267A00	1SL0251A00	-
2	1SL0260A00	1SL0276A00	1SL0268A00	1SL0252A00	-
3	1SL0261A00	1SL0277A00	1SL0269A00	-	1SL0253A00
4	1SL0262A00	1SL0278A00	1SL0270A00	-	1SL0254A00
5	1SL0263A00	1SL0279A00	1SL0271A00	-	1SL0255A00
6	1SL0264A00	1SL0280A00	1SL0272A00	-	1SL0256A00

Accessories for distribution

Wiring ducts	Fix-O-Rapid
Check the ABB Library	

General purpose enclosures

Fast selection table

Components for automation

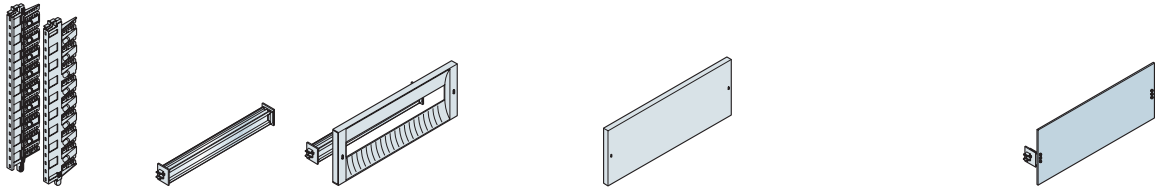

Size	Uprights	DIN rail	Drilled panel		Blank panel			Modular plate	
			H=150 mm	H=225 mm	H=75 mm	H=150mm	H=300 mm	H=150 mm	H=300 mm
1	1SL0283A00	1SL0290A00	1SL0307A00	-	1SL0318A00	1SL0324A00	1SL0330A00	1SL0296A00	-
2	1SL0284A00	1SL0291A00	1SL0308A00	1SL0313A00	1SL0319A00	1SL0325A00	1SL0331A00	1SL0297A00	1SL0302A00
3	1SL0285A00	1SL0291A00	1SL0308A00	1SL0313A00	1SL0319A00	1SL0325A00	1SL0331A00	1SL0297A00	1SL0302A00
4	1SL0285A00	1SL0292A00	1SL0309A00	1SL0314A00	1SL0320A00	1SL0326A00	1SL0332A00	1SL0298A00	1SL0303A00
5	1SL0286A00	1SL0292A00	1SL0309A00	1SL0314A00	1SL0320A00	1SL0326A00	1SL0332A00	1SL0298A00	1SL0303A00
6	1SL0287A00	1SL0293A00	1SL0310A00	1SL0315A00	1SL0321A00	1SL0327A00	1SL0333A00	1SL0299A00	1SL0304A00

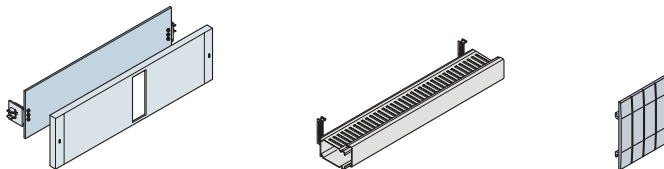

Accessories for distribution

Size	Kit for Tmax XT		x-O-Rapid kit with wiring duct		Module covers RAL 7035
	H. 150 mm	H. 300 mm	25x60 mm	40x60 mm	
1	-	-	1SL0353A00	1SL0360A00	12863
2	1SL0373A00	1SL0376A00	1SL0354A00	1SL0361A00	
3	1SL0373A00	1SL0376A00	1SL0354A00	1SL0361A00	
4	1SL0374A00	1SL0377A00	1SL0355A00	1SL0362A00	
5	1SL0374A00	1SL0377A00	1SL0355A00	1SL0362A00	
6	1SL0375A00	1SL0378A00	1SL0356A00	1SL0363A00	

General purpose enclosures

Fast selection table

Accessories common to the whole range

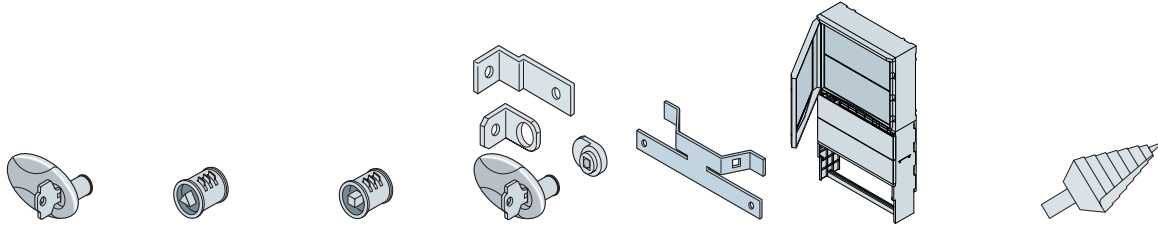

Size	Lock with handle	Lock with triangular impression	Lock with square impression	Anti tampering locking kit	Pole installation kit	Pedestal	Universal drill bit	Base mounting kit for metal and insulated plates
1	1SL0340A00	1SL0341A00	1SL0339A00	1SL0458A00	1SL0343A00	-	12894	1SL0383A00
2					1SL0344A00	-		
3					1SL0344A00	-		
4					1SL0345A00	1SL0464A00		
5					1SL0345A00	1SL0465A00		
6					1SL0346A00	1SL0466A00		

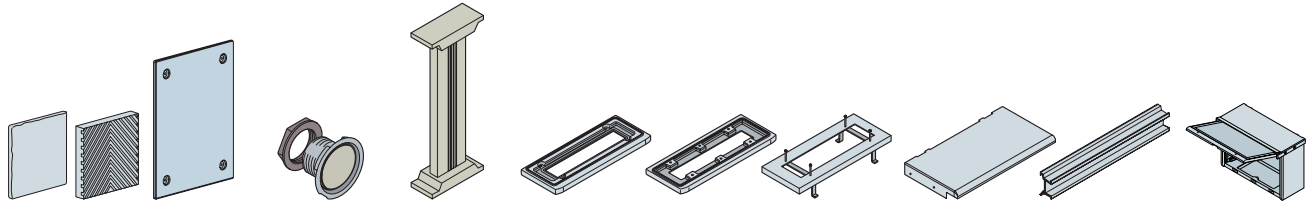

Size	Ventilation kit	Base cover	Anti condensation kit	Floor pedestal	Coupling kit	Bottom base H 30	Fixed frame	Integral cover	Depth adapter	Horizontal kit
1	Check the ABB Library	1SL0385A00	1SL0351A00	1SL0352A00	-	-	-	1SL0451A00	12851	-
2		1SL0386A00			1SL0413A00	1SL0423A00	1SL0433A00	1SL0452A00		1SL0470A00
3		1SL0387A00			1SL0413A00	1SL0423A00	1SL0433A00	1SL0452A00		1SL0471A00
4		1SL0388A00			1SL0414A00	1SL0424A00	1SL0434A00	1SL0454A00		
5		1SL0389A00		-	1SL0415A00	1SL0425A00	1SL0435A00	1SL0455A00		1SL0472A00
6		1SL0390A00		-	1SL0416A00	1SL0426A00	1SL0436A00	1SL0456A00		

General purpose enclosures

Fast selection table

Door with handle



Transparent door with handle

Size	Box dimensions WxHxD (mm)	Code
3	460x700x260	1SLM006600A0243
4	590x700x260	1SLM006600A0244
5	590x855x360	1SLM006600A0245
6	840x1005x360	1SLM006600A0246

Opaque door with handle

Size	Box dimensions WxHxD (mm)	Code
3	460x700x260	1SLM006600A0233
4	590x700x260	1SLM006600A0234
5	590x855x360	1SLM006600A0235
6	840x1005x360	1SLM006600A0236

Accessories



Lock with handle

Description	Code
Yale Lock for door with handle	1SLM006600A0459
Ronis 455 lock for door with handle	1SLM006600A0460

Mounting elements

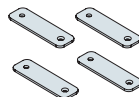
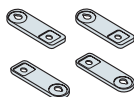

Horizontal and vertical plastic wall brackets (4 pieces)*	Horizontal and vertical stainless steel wall brackets (4 pieces)
1SL0342A00	1SL0401A00

* There are two types of inserts for adapting brackets to $\varnothing 6$ e 8 mm fixing devices.

General purpose enclosures

Configurations examples

The selection of components for the configuration of Gemini switchboards depends on the space available and the type of application. Two examples for each size are given below.

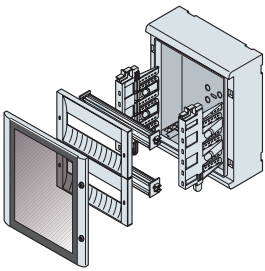

Size 1

Distribution	
Box + transparent door	1SL0211A00
Uprights	1SL0283A00
1-mod. drilled panel + DIN rail	1SL0307A00 (x2)

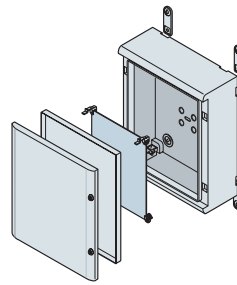

Automation	
Box + opaque door	1SL0201A00
Metal base plate	1SL0259A00
Inner door	1SL0251A00
Wall-mounting brackets	1SL0342A00

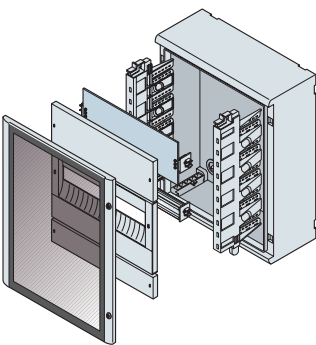

Size 2

Distribution/Mixed	
Box + transparent door	1SL0212A00
Uprights	1SL0284A00
Modular plate 1 mod.	1SL0297A00
Blank panel 1 mod.	1SL0325A00
Drilled panel 1+1/2 mod. + DIN rail	1SL0313A00
Blank panel 1/2 mod.	1SL0319A00
Module covers	12863

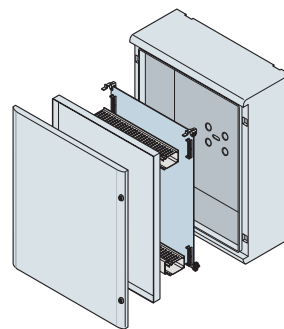

Automation	
Box + opaque door	1SL0202A00
Metal base plate	1SL0260A00
Inner door	1SL0252A00
Wiring duct	Check the ABB Library
Fix-O-Rapid	Check the ABB Library

General purpose enclosures

Configurations examples

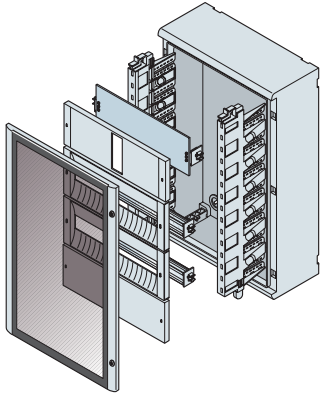

Size 3

Distribution/Mixed	
Box + transparent door	1SL0213A00
Uprights	1SL0285A00
Kit for Tmax	1SL0336A00
Drilled panel 1 mod. + DIN rail	1SL0308A00(x2)
DIN rail	1SL0291A00
Blank panel 1 mod.	1SL0325A00

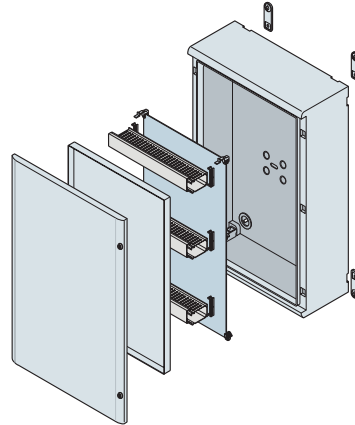

Automation	
Box + opaque door	1SL0203A00
Base insulating plate	1SL0269A00
Inner door	1SL0253A00
Wiring duct	Check the ABB Library
Fix-O-Rapid	Check the ABB Library
Wall-mounting brackets	1SL0342A00

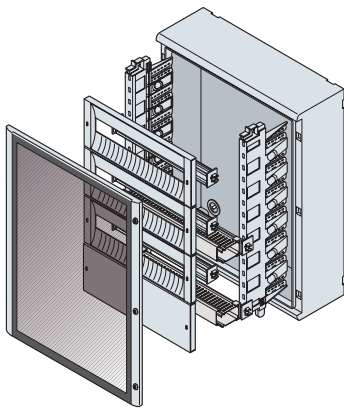

Taglia 4

Distribution/Mixed	
Box + transparent door	1SL0214A00
Uprights	1SL0285A00
Drilled panel 1 mod. + DIN rail	1SL0309A00 (x3)
Blank panel 1 mod.	1SL0326A00
Wiring kit 25x60 mm	1SL0355A00 (x2)
DIN rail	1SL0292A00
Module covers	12863

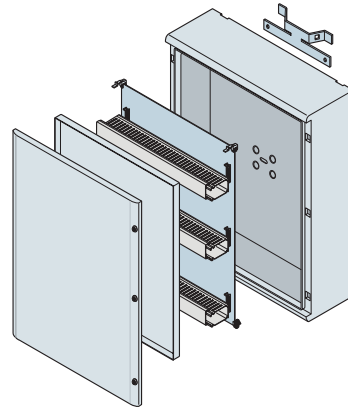

Automation	
Box + opaque door	1SL0204A00
Metal base plate	1SL0262A00
Inner door	1SL0254A00
Wiring duct	Check the ABB Library
Fix-O-Rapid	Check the ABB Library
Fixing on pole kit	1SL0345A00

General purpose enclosures

Configurations examples

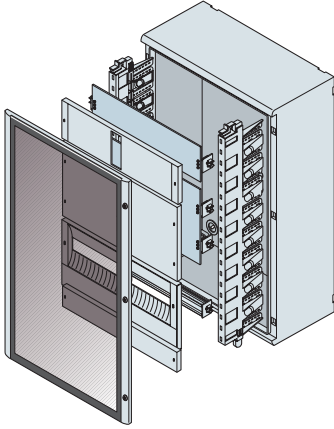

Size 5

Distribution/Mixed

Box + transparent door	1SL0215A00
Uprights	1SL0286A00
Kit for Tmax	1SL0337A00
Modular plate 2 mod.	1SL0303A00
Blank panel 2 mod.	1SL0332A00
Drilled panel 1+1/2 mod.	1SL0314A00
Blank panel 1/2 mod.	1SL0320A00
Module covers	12863

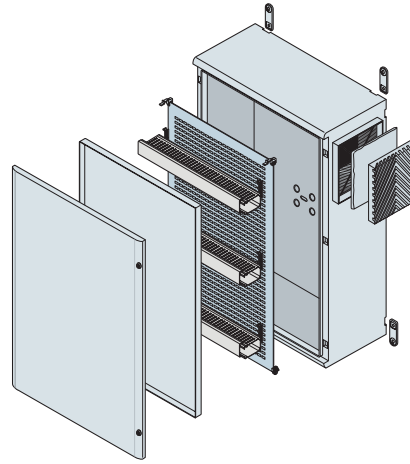

Automation

Box + opaque door	1SL0205A00
Drilled base plate	1SL0279A00
Inner door	1SL0255A00
Wiring duct	Check the ABB Library
Fix-O-Rapid	Check the ABB Library
Wall-mounting brackets	1SL0342A00
Ventilation kit	1SL0350A00

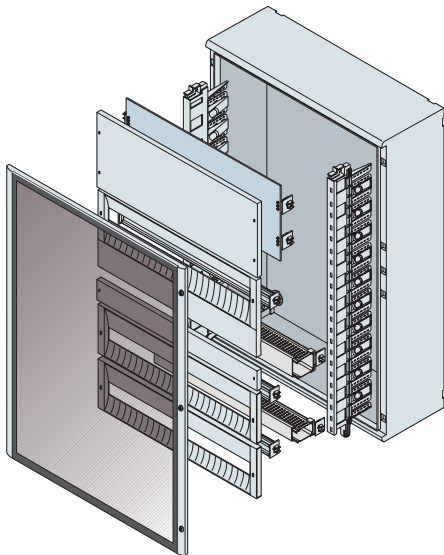

Size 6

Distribution/Mixed

Box + transparent door	1SL0216A00
Uprights	1SL0287A00
Modular plate 2 mod.	1SL0304A00
Blank panel 2 mod.	1SL0333A00
Drilled panel 1+1/2 mod.	1SL0315A00
Blank panel 1/2 mod.	1SL0321A00
Drilled panel 1 mod.	1SL0310A00 (x2)
Wiring kit 25x60 mm	1SL0356A00
Wiring kit 40x60 mm	1SL0363A00

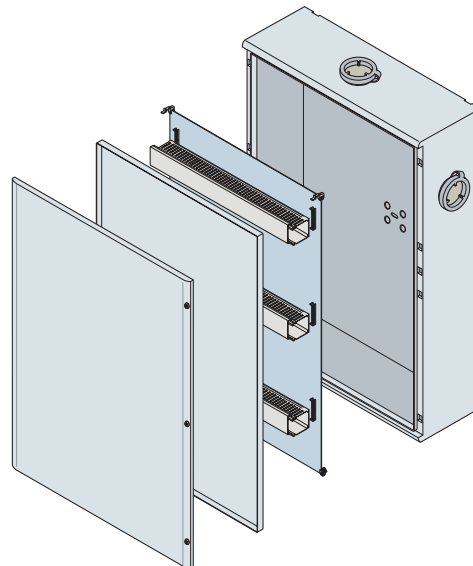

Automation

Box + opaque door	1SL0206A00
Metal base plate	1SL0264A00
Inner door	1SL0256A00
Wiring duct	Check the ABB Library
Fix-O-Rapid	Check the ABB Library
Triangular lock	1SL0341A00 (x3)
Anti-condensation kit	1SL0351A00 (x3)

General purpose enclosures

General characteristics of SR2 Enclosures

The range of SR2 enclosures is a complete offer of monobloc enclosures for constructing small and medium-sized electric automation, switching and control switchboards.

The SR2 enclosures come from the experience ABB has gained over the years in building IP65 metal structures (in accordance with the IEC 60529 Standard), together with the innovative new production process used for construction and patented by ABB.

The typical use of SR2 Enclosures is to make switchgear and controlgear switchboards for a very wide variety of industrial machines: from large machinery with automated production lines or parts of these, down to the typical installations of on-board machine switchboards, boilers, heating plants and so on.

They conform to the EN 62208 Standard "Empty enclosures for low voltage protection switchgear and controlgear assemblies" and allow realization of electrical equipment conforming to the prescriptions of the IEC 60204-1 Standard "Safety of machinery. Electrical equipment of machines" and of the EN 60439-1 Standard and the new EN 61439-1-2 Standard "Low voltage protection switchgear and controlgear for assemblies". The degree of protection, in accordance with the IEC 60529 Standard "Degrees of protection of enclosures (IP Code)", is IP65.

The SR2 enclosures have also passed the control required to obtain the UL (Underwriters Laboratories) and CSA (Canadian Standards Association) Type 12 marks.

The SR2 enclosures also allow secondary distribution switchboards to be made, thanks to the possibility, in the 400, 600 and 800 mm widths, of installing the whole range of apparatus and modular circuit-breakers on DIN rails combined with special pre-drilled and hinged modular front panels, thereby allowing construction of AS/ANS type electrical switchgear conforming to the IEC 60439-1 Standard and the new EN

61439-1-2 Standard. A single line of metalwork structures therefore allows construction of automation and secondary and end distribution electrical switchboards thanks to the availability of a series of accessories (modular panels, DIN rails) and to the possibility of stacking the enclosures.



General purpose enclosures

General characteristics of SR2 Enclosures

The SR2 enclosures are available in two versions (blind door or glazed door) and in 23 different dimensions, as well as a further 19 combinations obtained by stacking the enclosures, up to a maximum height of 2000 mm, which guarantee ample selection possibilities for the various end applications.

The SR2 enclosures have been designed to fulfil all the typical needs of the builder or installer of switchgear in the best way possible and the user is presented with a unique ensemble of functional characteristics:

- wide dimensional range
- certified IP65 degree of protection
- internal galvanised sheet mounting plate with 20/10 thickness (made to allow threaded holes to be made easily), adjustable in depth by using a special accessory
- fairlead plate screwed on (at top and bottom) made of 15/10 thick galvanised sheet, with a sealing gasket applied inside
- complete reversibility of the enclosure, so the door can open either on the right or on the lefthand side
- possibility of installing all the apparatus and modular circuit-breakers on a DIN rail combined with a hinged modular panel

The standard colour is RAL 7035 orange peel. On request, the SR2 enclosures can be ordered in a wide range of RAL colours (see page 24/143).

Both the enclosures with glazed door or blind door can be stacked: stacking is done simply by removing the fairlead plates and inserting the IP65 sealing gasket (GZ....), made of neoprene with closed cells.

Assembly of the stacked enclosures is carried out by means of the same holes used for the fairlead plates.

The door is supplied with the enclosure (single code) so as to reduce the number of articles and assembly times.



General purpose enclosures

General characteristics of SR2 Enclosures

The range is completed with a series of accessories: brackets for wall assembly, rain shield top cover, locks of various types, internal document pocket, spacers, and spray paint for touching up. It is possible floor fixing by means plinth.



Plastic document pocket, RAL 7035, size A4, the pocket is apply within the solid doors wider than 400 mm, with stickers provided.





Many closure systems can replace the standard closures of the external doors. The inserts are interchangeable and easily replaced by loosening a nut.



The brackets for wall mounting allows installation of the boxes on the wall using the holes located on the back of the enclosure.



The bars, made of electrolytic copper with M6 threaded holes in 25 mm, can be mounted on mounting plates using the appropriate supports.

Technical characteristics	
Conformity with Standard	IEC 62208, IEC 61439-1-2
Degree of protection	IP65 (IEC 60529) UL Listed: UL 508A NEMA: Types 1, 3R, 12
Degree of mechanical strength	IK10 blind door IK09 glazed door (IEC 62262)
Certifications	 
Type of material	Metallic
Installation site	Indoor/outdoor
Fixing method	floor/wall
Normal service conditions - ambient temperature	from -5 up to +40°C
Operating climate (t°/Ur%)	constant 23°C/83% - 40°C/93%
	variable 23°C/98% - 40°C/98%

General purpose enclosures

Selection table - SR2 enclosures

Quick selection table

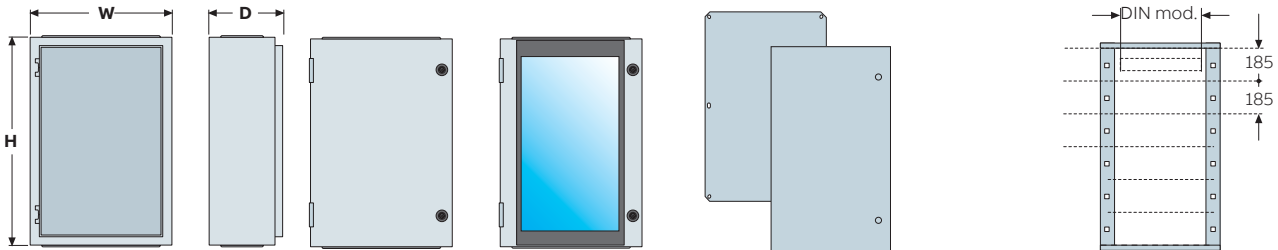

Overall dimensions			Enclosures	Kit for automation			Kit for distribution Supports for mounting modular panels				
H mm	W mm	D mm	Enclosures with blind door + back plate	with glazed door *	Blind counterdoor	Back plate	No. vertical mod. H=185mm	No. DIN mod. per row	Total modules	DIN Supports	
300	200	150	SRN3215K								
	300		SRN3315K								
	400		SRN3415K								
400	300	150	SRN4315K								
	300		200	SRN4320K							
	400		SRN4420K								
	600		SRN4620K								
500	300	200	SRN5320K								
	400		SRN5420K	SRN5420VK*	KC5040K	PF5040	2	14	28	KD5040K	
	400		250	SRN5425K	SRN5425VK*	KC5040K	PF5040	2	14	28	KD5040K
600	400	200	SRN6420K	SRN6420VK*	KC6040K	PF6040	3	14	42	KD6040K	
	400		250	SRN6425K	SRN6425VK*	KC6040K	PF6040	3	14	42	KD6040K
	600		SRN6625K								
700	500	200	SRN7520K	SRN7520VK*	KC7050K	PF7050					
	500		250	SRN7525K	SRN7525VK*	KC7050K	PF7050				
800	600	250	SRN8625K	SRN8625VK*	KC8060K	PF8060	4	25	100	KD8060K	
	600		300	SRN8630K	SRN8630VK*	KC8060K	PF8060	4	25	100	KD8060K
	800		SRN8830K								
1000	600	250	SRN10625K	SRN10625VK*	KC1060K	PF1060	5	25	125	KD1060K	
	600		300	SRN10630K	SRN10630VK*	KC1060K	PF1060	5	25	125	KD1060K
	800		SRN10830K	SRN10830VK*	KC1080K	PF1080	5	36	180	KD1080K	
1200	600	300	SRN12630K	SRN12630VK*	KC1260K	PF1260	6	25	150	KD1260K	
	800		SRN12830K	SRN12830VK*	KC1280K	PF1280	6	36	216	KD1280K	

* The mounting plate must be ordered separately.

General purpose enclosures

Ordering codes - SR2 enclosures

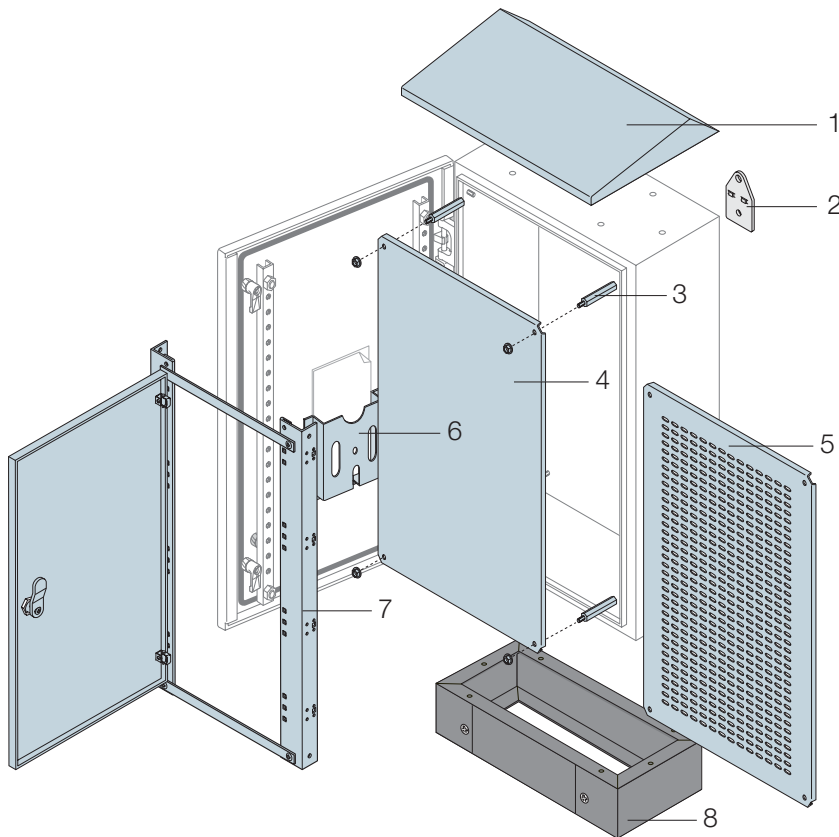

1 - Spray protection roof

2 - Wall-mounting brackets

3 - Spacers for back plates

4 - Blind internal plate

5 - Slotted internal plate

6 - Document pocket

7 - Counterdoor

8 - Plinth

9 - Frame for DIN rail

10 - Modular panels for apparatus

11 - DIN rail

12 - Blind modular panels

13 - Modular panel for DIN rail

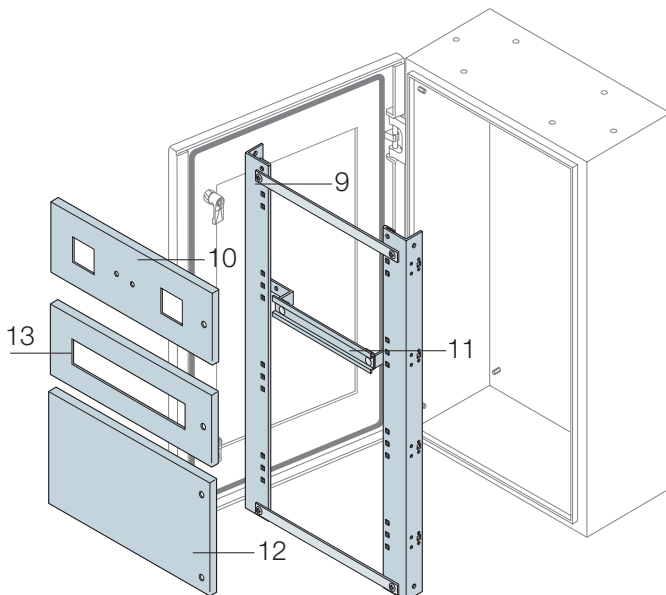

General purpose enclosures

Ordering codes - SR2 enclosures

SR2 Enclosures with blind door (internal plate included)

The enclosures with blind door, typically for making automation switchgear, are already fitted with the internal galvanised sheet mounting plate.

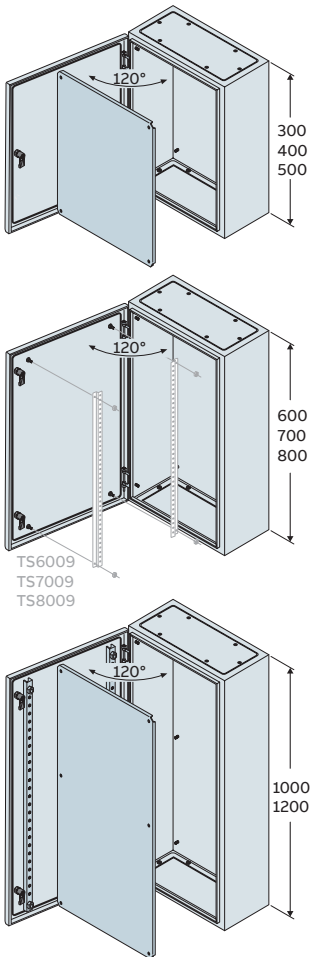

Enclosures with blind door (internal plate included)				
Dimensions (mm)			Code	Package/ No. of pieces
H	W	D		
300 ⁽¹⁾	200	150	SRN3215K	1/1
	300	150	SRN3315K	1/1
	400	150	SRN3415K	1/1
400 ⁽¹⁾	300	150	SRN4315K	1/1
	300	200	SRN4320K	1/1
	400	200	SRN4420K	1/1
500 ⁽¹⁾	600	200	SRN4620K	1/1
	300	200	SRN5320K	1/1
	400	200	SRN5420K	1/1
600	400	250	SRN5425K	1/1
	400	200	SRN6420K	1/1
	400	250	SRN6425K	1/1
700	600	250	SRN6625K	1/1
	500	200	SRN7520K	1/1
	500	250	SRN7525K	1/1
800	600	250	SRN8625K	1/1
	600	300	SRN8630K	1/1
	800	300	SRN8830K	1/1
1000*	600	250	SRN10625K	1/1
	600	300	SRN10630K	1/1
	800	300	SRN10830K	1/1
1200*	600	300	SRN12630K	1/1
	800	300	SRN12830K	1/1

⁽¹⁾ The enclosures with height less or equal to 500mm have only a closing box.

* Plates height 1000 / 1200mm have six mounting points .

General purpose enclosures

Ordering codes - SR2 enclosures

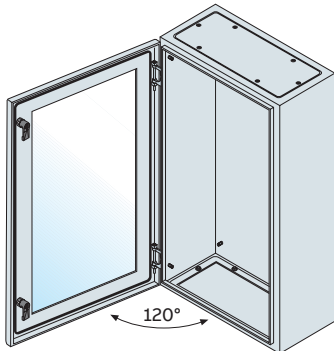

Enclosures with glazed door

The enclosures with glazed door are also used for distribution configurations. The internal equipment is made, alternatively, by selecting the special kits:

- KD... (Distribution Kit) consisting of a pair of functional uprights for assembly of the modular panels (to be ordered separately) and of any compensation panel.

The modular panels, which can also be installed on the enclosures with blind door with the help of the KD.. kit itself, are all hinged and have vertical modularity of 185 mm.

Enclosures with glazed door				
Dimensions (mm)				
H	W	D	Code	Package/ No. of pieces
500 ⁽¹⁾	400	200	SRN5420VK	1/1
	400	250	SRN5425VK	1/1
600	400	200	SRN6420VK	1/1
	400	250	SRN6425VK	1/1
700	500	200	SRN7520VK	1/1
	500	250	SRN7525VK	1/1
800	600	250	SRN8625VK	1/1
	600	300	SRN8630VK	1/1
1000	600	250	SRN10625VK	1/1
	600	300	SRN10630VK	1/1
	800	300	SRN10830VK	1/1
1200	600	300	SRN12630VK	1/1
	800	300	SRN12830VK	1/1

⁽¹⁾ The enclosures with height less or equal to 500mm hare only a closing box.

General purpose enclosures

Ordering codes - SR2 enclosures

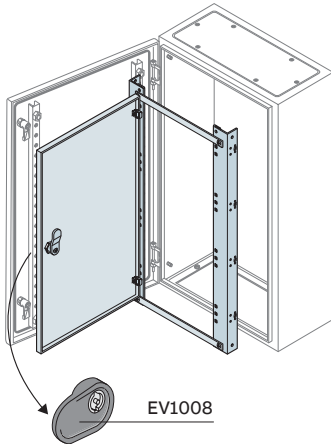

Blind counterdoor

The internal counterdoor guarantees IP20 degree of protection. Made of steel sheet 15/10mm thick, galvanized and painted orange peel RAL 7035 colour, complete with the EV1008 ergonomic box and insert with double tongue.

Blind counterdoor			
Dimensions (mm)			Package/ No. of pieces
H	W	Code	
500	400	KC5040K	1/1
600	400	KC6040K	1/1
700	500	KC7050K	1/1
800	600	KC8060K	1/1
1000	600	KC1060K	1/1
1000	800	KC1080K	1/1
1200	600	KC1260K	1/1
1200	800	KC1280K	1/1

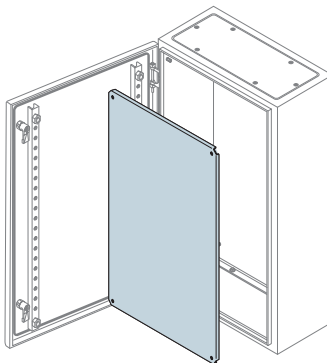

Blind internal mounting plate

Internal galvanised sheet mounting plate 20/10mm thick complete with fixing with small items provided. Possibility of adjusting the depth with the help of a special spacer kit (to be ordered separately).

Blind back plate for enclosure			
Dimensions (mm)			Package/ No. of pieces
H	W	Code	
300	200	PF3020	1/1
300	300	PF3030	1/1
300	400	PF3040	1/1
400	300	PF4030	1/1
400	400	PF4040	1/1
400	600	PF4060	1/1
500	300	PF5030	1/1
500	400	PF5040	1/1
600	400	PF6040	1/1
600	600	PF6060	1/1
700	500	PF7050	1/1
800	600	PF8060	1/1
800	800	PF8080	1/1
1000	600	PF1060	1/1
1000	800	PF1080	1/1
1200	600	PF1260	1/1
1200	800	PF1280	1/1

General purpose enclosures

Ordering codes - SR2 enclosures

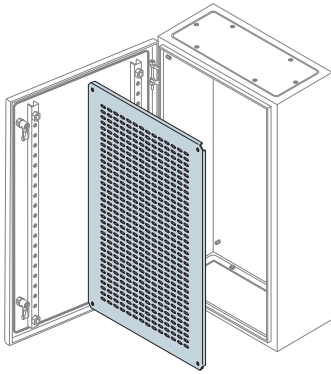

Slotted internal mounting plate

Fixing with small items provided. Possibility of adjusting the depth with the help of a special spacer kit (to be ordered separately).

Back plate for enclosure

Dimensions (mm)			Package/ No. of pieces
W	H	Code	
200	300	TQ3020	1/1
300	300	TQ3030	1/1
400	300	TQ3040	1/1
300	400	TQ4030	1/1
400	400	TQ4040	1/1
600	400	TQ4060	1/1
300	500	TQ5030	1/1
400	500	TQ5040	1/1
400	600	TQ6040	1/1
600	600	TQ6060	1/1
500	700	TQ7050	1/1
600	800	TQ8060	1/1
800	800	TQ8080	1/1
600	1000	TQ1060	1/1
800	1000	TQ1080	1/1
600	1200	TQ1260	1/1
800	1200	TQ1280	1/1

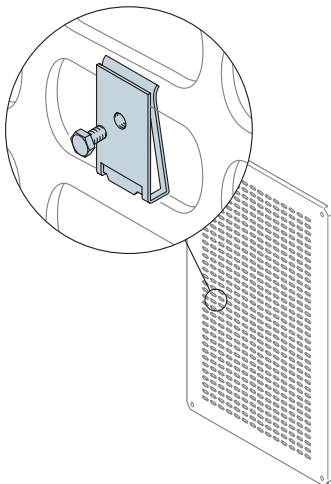

Clip nuts

For slotted plates with M6x10mm hexagonal head screws.

Description	Code	Package/ No. of pieces
No.20 clip nuts	TQ6610	1/20

Spacer Kit for adjusting the depth of the back plates

Kit consisting of 12 spacers for fixing the back plate with the possibility of adjusting the depth with 25 mm pitch.

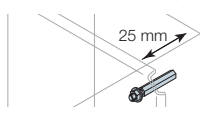
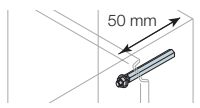
Description	Code	Package/ No. of pieces
Spacers 25mm long 	AA8025	1/12
Spacers 50mm long 	AA8050	1/12

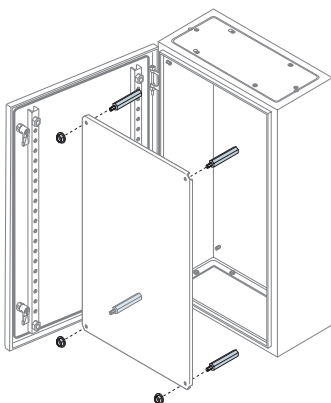

General purpose enclosures

Ordering codes - SR2 enclosures

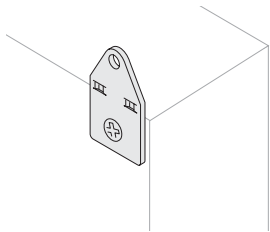

Brackets for wall fixing

These allow wall installation of the enclosures and are mounted by using the special holes positioned on the rear of the enclosures.

Description	Code	Package/ No. of pieces
Brackets for wall fixing	AA1206	1/4

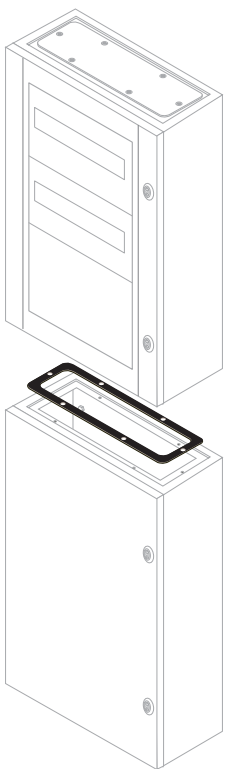

Accessories for stacking

Dimensions (mm)			Package/ No. of pieces
W	D	Code	
IP65 gasket			
400	200	GZ4020	1/1
	250	GZ4025	1/1
600	200	GZ6020	1/1
	250	GZ6025	1/1
	300	GZ6030	1/1
800	300	GZ8030	1/1

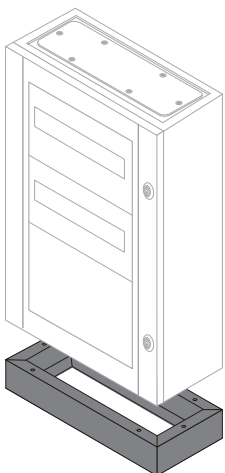

Plinth

Steel plinth 25/10 thick grey RAL7012 color.

Plinth				Package/ No. of pieces
Dimensions (mm)			Code	
W	D	H	Code	Package/ No. of pieces
400	200	100	ZA4020	1/1
	250	100	ZA4025	1/1
600	250	100	ZA6025	1/1
	300	100	ZA6030	1/1
800	300	100	ZA8030	1/1

General purpose enclosures

Ordering codes - SR2 enclosures

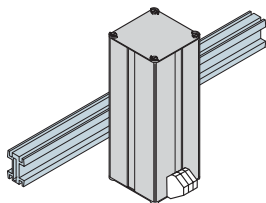

Temperature management

IP20 heater

Their use prevents condensation in the electric cabinets. They consist of a heating element (PTC thermistor) inserted in an aluminium alloy ground plate. The PTC thermistor is a component which modifies its impedance according to the operating temperature. It is intrinsically stable and ensures primary safety features for the heater and service stability.

The main qualities of the heaters using PTC are:

- electrical absorption (or dissipated power) which is almost constant in
- the range of power supply voltage between 100 and 250V;
- electrical absorption bound by inverse law to the trend of the ambient temperature.

The special tubular geometry of the ground plate allows efficient thermal exchange with the heating element. This allows high powers and limited overall dimensions (especially in width and depth); Snap-on assembly on 35 mm DIN rail. Requires a thermostat.

Description	Dimensions (mm)			Code	Package/ No. of pieces
	H	W	D		
Anti-condensation heater 30W, 110-240 Vac-dc	115	42	42	VA7930	1/1
Anti-condensation heater 50W, 110-240 Vac-dcc	165	42	42	VA7950	1/1
Anti-condensation heater 75W, 110-240 Vac-dc	210	42	42	VA7975	1/1
Anti-condensation heater 100W, 110-240 Vac-dc	165	42	51	VA7910	1/1
Anti-condensation heater 150W, 110-240 Vac-dc	146	82	51	VA7915	1/1
Anti-condensation heater with fan 300W, 230 Vac-dc	148	82	91	VA8300	1/1

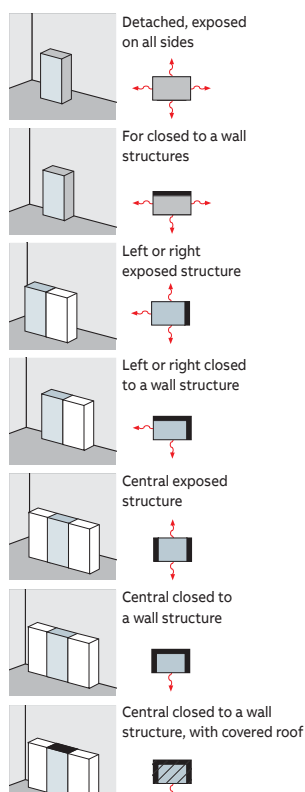

All the heaters with PTC absorb a higher power than the rated one on inrush according to a transitory which lasts a few tenths of a second.

If the heaters are to be supplied by means of an auxiliary transformer, its apparent power must be sized taking 1.5 times the rated power of the heaters with natural aeration and twice those with forced ventilation into consideration.

IEC 890 method for calculating the effective cooling surface (CEI 17-43 method)

The total power dissipation P of an enclosure is linked to the exchange effective dissipating surface S, the ΔT difference between the inner and outer temperature and the k coefficient of heat exchange relative to the material of the enclosure:

$$P = k * \Delta T * S$$

$$k = 5,5 \text{ for painted steel}$$

$$\Delta T = T1 - T2;$$

T1 = dew point temperature (on average 25 °C)

T2 = minimum ambient temperature.

General purpose enclosures

Ordering codes - SR2 enclosures

The exchange surface S can be calculated using the following table taken from the CEI 17-43

Disposition of the cabinet	Calculating the enclosure surface S (mm ²)	Dimensions (m)
Detached, exposed on all sides	$S = 1,8 \times H \times (L+P) + 1,4 \times L \times P$	L = width H = height P = depth
For closed to a wall structures	$S = 1,4 \times L \times (H+P) + 1,8 \times P \times H$	
Left or right exposed structure	$S = 1,4 \times P \times (H+L) + 1,8 \times L \times H$	
Left or right closed to a wall structure	$S = 1,4 \times H \times (P+L) + 1,4 \times L \times P$	
Central exposed structure	$S = 1,8 \times L \times H + 1,4 \times L \times P + P \times H$	
Central closed to a wall structure	$S = 1,4 \times L \times (H+P) + P \times H$	
Central closed to a wall structure, with covered roof	$S = 1,4 \times L \times H + 0,7 \times L \times P + P \times H$	

Using a SRN8630K box, in “for closed to a wall structures” case we will obtain:

$$T_1 = 25 \text{ °C}; T_2 = 20 \text{ °C}; K = 5,5; \Delta T = (25-20) = 5 \text{ °C}; S = 1,4\text{m}^2$$

The total power dissipation P obtained will be:

$$P = k * \Delta T * S = 38,5 \text{ W}$$

The recommended heater is VA7950 (50W).

Temperature management

IP20 Thermostat

Conforms to EN 60730-1, CE and cURus standards, IP20 degree of protection. Grey RAL 7035 colour; electrical life 100,000 cycles. Dimensions (HxWxD) 68x29x45mm, can be mounted on DIN rail. The version with NO (normally open) contact allows closure of a circuit activating ventilation, air conditioning, or alarms. The version with NC (normally closed) contact allows opening of a circuit, disconnecting any anti-condensation resistances.

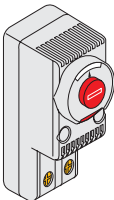

Description	Standard power supply V~/50-60Hz	Code	Package/ No. of pieces
NO ventilation thermostat	12-60 V d.c.; 110-250V a.c.	EN0101K	1/1
NC heating thermostat	12-60 V d.c.; 110-250V a.c.	EN0102K	1/1

Code	Standard power supply V~/50-60Hz	Contact capacity		Temperature scale	Type of contact	Weight
		Load Ω	Load L			
EN0101K	12-60 V d.c.; 110-250V a.c.	10A	2A	-10 +80 °C	NO	54g
EN0102K	12-60 V d.c.; 110-250V a.c.	10A	2A	-10 +80 °C	NC	54g

Frame for DIN rail

Internal supports for fixing modular panels and DIN rails, colour RAL 7035 orange peel.

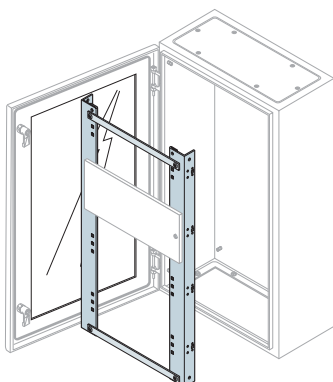

Description	Dimensions (mm)		Code	Package/ No. of pieces
	H	W		
Supports 14 mod. DIN x 2 rows	500	400	KD5040K	1/1
Supports 14 mod. DIN x 3 rows	600	400	KD6040K	1/1
Supports 25 mod. DIN x 4 rows	800	600	KD8060K	1/1
Supports 25 mod. DIN x 5 rows	1000	600	KD1060K	1/1
Supports 36 mod. DIN x 5 rows	1000	800	KD1080K	1/1
Supports 25 mod. DIN x 6 rows	1200	600	KD1260K	1/1
Supports 36 mod. DIN x 6 rows	1200	800	KD1280K	1/1

General purpose enclosures

Ordering codes - SR2 enclosures

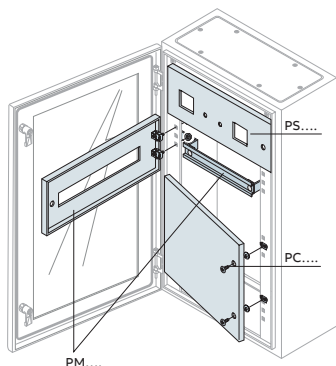

Modular panels

Modular panels made of 12/10mm thick sheet steel painted RAL 7035 colour orange peel. The modular hinged panels can be mounted on the enclosures by using the special kit (KD...) consisting of functional uprights and compensation panel. The hinges patented by ABB, allow automatic earthing for panel contact when it is closed and are also suitable conventional earthing (with a cable). Each modular panel (PM) has a DIN rail provided (adjustable in depth), the fixing brackets and the relative small items. Modular and circuit-breakers and Tmax moulded-case circuit-breakers up to T3 can be placed side by side on the same DIN rail using the special depth adapter AP6001. To install moulded-case circuit-breakers, it is necessary to fix the DIN rail in a position towards the back. The fixing brackets of the DIN rail allow the wiring duct to be mounted up to a maximum size of 60 x 60 mm.

Modular hinged panels for modular apparatus (DIN rail and fixing brackets included)

Description	Dimensions (mm)			Package/ No. of pieces
	H	W	Code	
14 mod. DIN + fixing bracket	185	400	PM1414K	1/1
25 mod. DIN + fixing bracket	185	600	PM1625K	1/1
36 mod. DIN + fixing bracket	185	800	PM1836K	1/1

Modular hinged panels for measuring instruments

Description	Dimensions (mm)			Package/ No. of pieces
	H	W	Code	
2 instruments 72 x 72mm	185	400	PS2476K	1/1
2 instruments 72 x 72mm	185	600	PS2676K	1/1
2 instruments 72 x 72mm	185	800	PS2876K	1/1

Modular hinged blind panels

Description	Dimensions (mm)			Package/ No. of pieces
	H	W	Code	
Blind panel	185	400	PC1406K	1/1
Blind panel	185	600	PC1606K	1/1
Blind panel	185	800	PC1806K	1/1
Blind panel	370	600	PC2606K	1/1
Blind panel	370	800	PC2806K	1/1

DIN rail and fixing brackets

Description	No. of modules	W (mm)	Code	Package/ No. of pieces
DIN rail and fixing brackets	14	400	GD4006	1/1
DIN rail and fixing brackets	25	600	GD6006	1/1
DIN rail and fixing brackets	36	800	GD8006	1/1
Depth adapter				
No.1 depth adapter for Tmax T1-T2-T3-XT1-XT3 W=600mm			AP6001	1/4

Polished flange for DIN-Rail mounting

Description	Code	Package/ No. of pieces
Polished flange for XT1 3P mounted on DIN rail	AD3301	1/1
Polished flange for XT1 4P mounted on DIN rail	AD3302	1/1
Polished flange for XT3 3P mounted on DIN rail	AD3303	1/1
Polished flange for XT3 4P mounted on DIN rail	AD3304	1/1

Already supplied in the DIN-Rail mounting kit for breakers in MCCBs catalogue

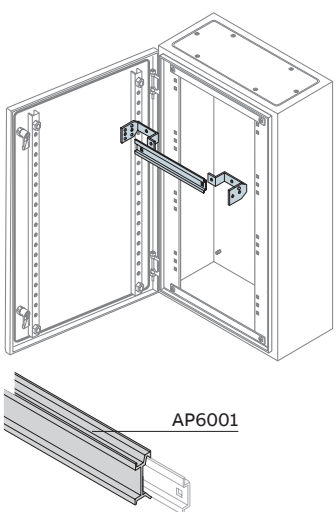

General purpose enclosures

Ordering codes - SR2 enclosures

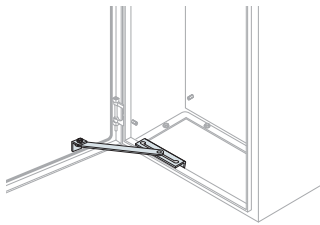

Door anti-closure device

It can't be mounted with the inner-door or with modular/blind panels mounted down in structure and hinged.

Description	Code	Package/ No. of pieces
Door anti-closure device	EV0015	1/4

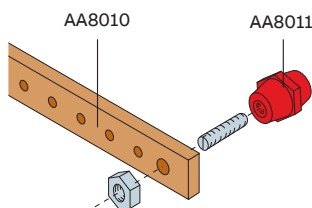

Neutral or earthing busbars

The busbars, made of electrolytic copper with M6 threaded holes with 25 mm pitch, can be mounted on the back plates by means of the special supports. They must be sized according to the enclosure and the position they are installed in.

Description	W (mm)	Code	Package/ No. of pieces
No. 4 busbars sect. 20x5mm	1000	AA8010	1/4
No.5 support for busbar		AA8011	1/5

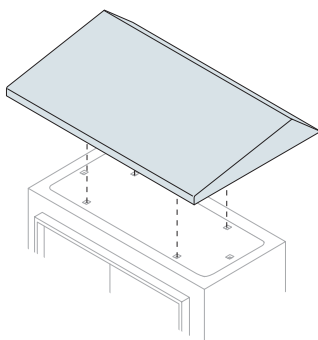

Spray protection roofs

To improve protection against entry of liquids and rain. Made of 15/10mm thick sheet steel, painted RAL 7035 colour orange peel.

Spray protection roof			Package/ No. of pieces
Dimensions (mm)			
W	D	Code	
200	150	TT2015K	1/1
300	150	TT3015K	1/1
400	150	TT4015K	1/1
300	200	TT3020K	1/1
400	200	TT4020K	1/1
500	200	TT5020K	1/1
600	200	TT6020K	1/1
400	250	TT4025K	1/1
500	250	TT5025K	1/1
600	250	TT6025K	1/1
600	300	TT6030K	1/1
800	300	TT8030K	1/1

Shaped sections for accessories

These allow fixing of accessories (e.g. wiring ducts) inside the blind doors. They consist of a pair of vertical crosspieces made of 15/10mm thick white galvanised sheet, pre-drilled with 25 mm pitch. In the enclosures with 1000 and 1200 mm height with blind door, the shaped sections are already provided.

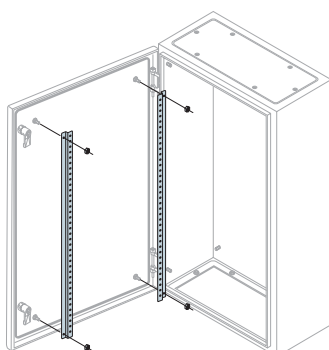

Description	Dimensions (mm)		Package/ No. of pieces
	H	Code	
No. 2 shaped sections for door	600	TS6009	1/1
No. 2 shaped sections for door	700	TS7009	1/1
No. 2 shaped sections for door	800	TS8009	1/1
No. 2 shaped sections for door	1000	1SLM400000A9000	1/1

General purpose enclosures

Ordering codes - SR2 enclosures

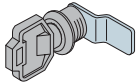

AA8001

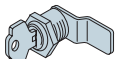

AA8002

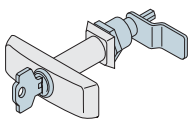

AA8003



EV1008

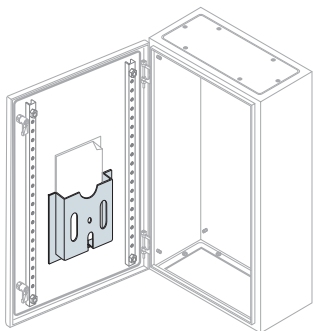

Closing systems

These can replace the standard closures of the external doors.

The inserts are interchangeable and easily replaced by loosening a single nut.

Description	Code	Package/ No. of pieces
Box Ø 19 mm double tongue and plastic key (spare part)	AA8001	1/1
Box Ø 19 mm with security insert and Yale type key	AA8002	1/1
Box Ø 19 mm with handle and Yale type key	AA8003	1/1
Box Ø 19 mm with triangular insert	AA5200	1/1
Plastic key for triangular insert AA5200	AA5190	1/1
Ergonomic box complete with double tongue insert (without tongue)	EV1008	1/1
Single code Yale insert	EV1036	1/1
Ronis 455 insert for	EV1037	1/1
3mm Double tongue insert	EV1039	1/1

Document pocket RAL 7035

Made of plastic, RAL 7035 colour, A4 size. The pocket can be glued inside the blind door with a width of more than 400 mm, using the adhesives provided.

Description	Code	Package/ No. of pieces
Plastic document pocket for A4	EV1075K	1/1

Special Painting Service

Special painting service has to manage with code of enclosure SRN....SPEC (e.g. SRN4320SPEC VERNSR + note about color required). It is necessary specify the color required in the order. Minimum order quantity 4 pieces. For any other component or further information, please contact you local sales network.

Description	Code	Package/ No. of pieces
Extra cost for special SR painting	VERNSR	

Accessories for DIN panel

Hole covering strip RAL7035 colour

Description	Code	Package/ No. of pieces
No.10 hole covers W=2000mm, grey	AD1086	1/10
No.3 hole covers 24 DIN modules W=600mm	AD1088	1/3
No.3 hole covers 36 DIN modules W=800mm	AD1089	1/3

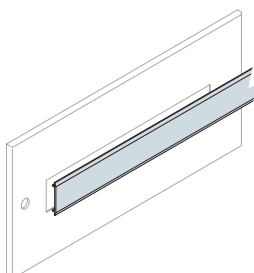

General purpose enclosures

Ordering codes - SR2 enclosures

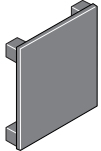
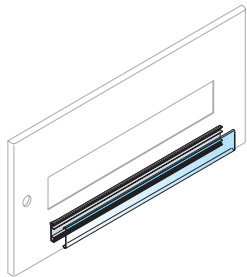
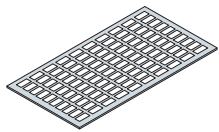
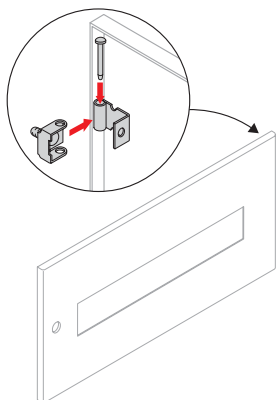

EV1137

EV1135
EV1136AD1101-AD1102
AD1103-AD1104EH2118-EH2129
AD1600-AD1800

Closing plug for instrument holder panels

Description	Code	Package/ No. of pieces
No.10 closing plug for instrument holder panels 72x72mm	EV1135	1/10
No.5 closing plug for instrument holder panels 96x96mm	EV1136	1/5
No.50 tappi di chiusura per pulsanti Ø22 mm	EV1137	1/50

Adhesive name label holders

Description	Dimensions (mm)		Package/ No. of pieces
	W	Code	
No. 20 label holders 18 DIN mod	325	EH2118	1/20
No. 20 label holders 29 DIN mod	525	EH2129	1/20
No. 20 label holders 24 DIN mod	432	AD1600	1/20
No. 20 label holders 36 DIN mod	634	AD1800	1/20

Grafoplast system compatible customizable labels

Description	No. of DIN mod.	Code	Package/ No. of pieces
No. 288 labels 1 DIN mod.	1	AD1101	1/288
No. 192 labels 2 DIN mod.	2	AD1102	1/192
No. 96 labels 3 DIN mod.	3	AD1103	1/96
No. 96 labels 4 DIN mod.	4	AD1104	1/96

Hinges and quick closures for panels

Description	Code	Package/ No. of pieces
No. 10 hinges for panels	EH1889 ⁽¹⁾	1/10
No. 5 quick closures for front panels	EH1890	1/5

⁽¹⁾ Use No.2 hinges for panel H=150/200/300/400mm, No.3 hinges for panel H=500/600mm.

General purpose enclosures

Ordering codes - SR2 enclosures

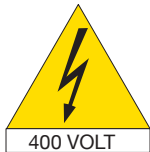
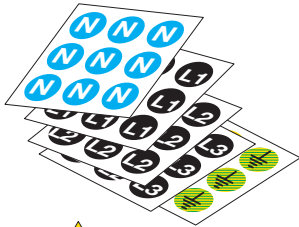

Marking

Description	Code	Package/ No. of pieces
No.5 adhesive labels ABB-IS2 W=1000mm	EV1157	1/5
No.490 adhesive labels Ø 12mm N symbol	EV1150	1/490
No.490 adhesive labels Ø 12mm L1symbol	EV1151	1/490
No.490 adhesive labels Ø 12mm L2 symbol	EV1152	1/490
No.490 adhesive labels Ø 12mm L3 symbol	EV1153	1/490
No.490 adhesive labels Ø 12mm T symbol	EV1154	1/490
No.10 triangular adhesive labels 125mm with 400V lightning arrow symbol	EV1155	1/10
No.100 triangular adhesive labels 50mm with lightning arrow symbol	EV1156	1/100

Screws for apparatus

Description	Code	Package/ No. of pieces
No.1000 perforating screws 4.2x13mm cross slotted head	EV1100	1/1000
No.1000 perforating screws 4.2x19mm cross slotted head	EV1101	1/1000
No.50 trilobed screws M6 L=10mm	AD1033	1/50

Wiring duct support brackets

Description	Code	Package/ No. of pieces
No. 100 wiring duct support brackets on upright structure	EV1131	1/100

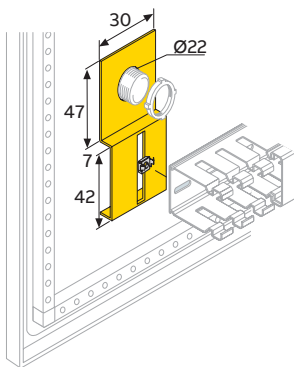

General purpose enclosures

Ordering codes - SR2 enclosures

Spare parts

Description	Code	Package/ No. of pieces
Ergonomic box complete with double tongue insert (without tongue)	EV1008	1/1
N. 10 hinges for SR2 enclosures + countersunk rivets	AA1204	1/1
N. 16 screws and nuts M6x14 for flange	AA1203	1/2
N. 2 fairlead plates for SRN3215K	FLN3215K	1/2
N. 2 fairlead plates for SRN3315K-SRN4315K	FLN3315K	1/2
N. 2 fairlead plates for SRN3415K	FLN3415K	1/2
N. 2 fairlead plates for SRN4320K-SRN5320K	FLN4320K	1/2
N. 2 fairlead plates for SRN4420K-SRN5420K-SRN6420K	FLN4420K	1/2
N. 2 fairlead plates for SRN5425K-SRN6425K	FLN4425K	1/2
N. 2 fairlead plates for SRN4620K	FLN4620K	1/2
N. 2 fairlead plates for SRN6625K-SRN8625K-SRN10625K	FLN6625K	1/2
N. 2 fairlead plates for SRN7520K	FLN7520K	1/2
N. 2 fairlead plates for SRN7525K	FLN7525K	1/2
N. 2 fairlead plates for SRN8630K-SRN10630K-SRN12630K	FLN8630K	1/2
N. 2 fairlead plates for SRN8830K-SRN10830-SRN12830K	FLN8830K	1/2
Blind door 1000x600mm (hxl)	PRN1066K	1/1
Blind door 1000x800mm (hxl)	PRN1086K	1/1
Blind door 1200x600mm (hxl)	PRN1266K	1/1
Blind door 1200x800mm (hxl)	PRN1286K	1/1
Blind door 300x200mm (hxl)	PRN3026K	1/1
Blind door 300x300mm (hxl)	PRN3006K	1/1
Blind door 300x400mm (hxl)	PRN3046K	1/1
Blind door 400x300mm (hxl)	PRN4036K	1/1
Blind door 400x400mm (hxl)	PRN4046K	1/1
Blind door 400x600mm (hxl)	PRN4066K	1/1
Blind door 500x300mm (hxl)	PRN5036K	1/1
Blind door 500x400mm (hxl)	PRN5046K	1/1
Blind door 600x400mm (hxl)	PRN6046K	1/1
Blind door 600x600mm (hxl)	PRN6066K	1/1
Blind door 700x500mm (hxl)	PRN7056K	1/1
Blind door 800x600mm (hxl)	PRN8066K	1/1
Blind door 800x800mm (hxl)	PRN8086K	1/1
Glazed door 1000x600mm (hxl)	PTN1066K	1/1
Glazed door 1000x800mm (hxl)	PTN1086K	1/1
Glazed door 1200x600mm (hxl)	PTN1266K	1/1
Glazed door 1200x800mm (hxl)	PTN1286K	1/1
Glazed door 500x400mm (hxl)	PTN5046K	1/1
Glazed door 600x400mm (hxl)	PTN6046K	1/1
Glazed door 700x500mm (hxl)	PTN7056K	1/1
Glazed door 800x600mm (hxl)	PTN8066K	1/1
Spray paint color grey RAL7035 for structure	VB7035	1/1
Spray paint color grey RAL7012 for plinth	VB7012	1/1

General purpose enclosures

Ordering codes - SR2 enclosures



Painting Special Service

Description	Code
Extra cost for special SR painting	VERNSR

Standard size enclosures, standard colour

Special painting service with standard colour (see on the next page) for standard size enclosures in quantities equal to or greater than 4 units with single code to be managed with code SRN ... SPEC + VERNSR overprice equal to the number of enclosures + colour note to be specified in the order.

Example: SRN4320SPEC 4
VERNSR 4
COLOUR NOTE

Standard size enclosures, non-standard colour

Request feasibility of implementation by completing the relevant Form for special quotations and send it to the R&D ECS office.

Management is per offer.

If the offer is accepted and after having received it, it will be possible to place the order with the codes indicated in the offer that will not be SRN...SPEC, but dummy ones.

Always remember to indicate the offer reference in the order.

Non-standard size enclosures, standard colour

Request feasibility of implementation by completing the relevant Form for special quotations and send it to the R&D ECS office.

Management is per offer.

If the offer is accepted and after having received it, it will be possible to place the order with the codes indicated in the offer, that will not be SRN...SPEC, but dummy ones:

Always remember to indicate the offer reference in the order.

Non-standard size enclosures, non-standard colour

Request feasibility of implementation by completing the relevant Form for special quotations and send it to the R&D ECS office.

Management is per offer.

If the offer is accepted and after having received it, it will be possible to place the order with the codes indicated in the offer, that will not be SRN...SPEC, but dummy ones:

Always remember to indicate the offer reference in the order.

Please note that the minimum quantity is four pieces with a single code.

General purpose enclosures

Standardised RAL colours (on request)

On request, colours other than the standard RAL 7035 orange peel one are available, using the same painting cycle (for other types of colours or paints, please contact ABB).

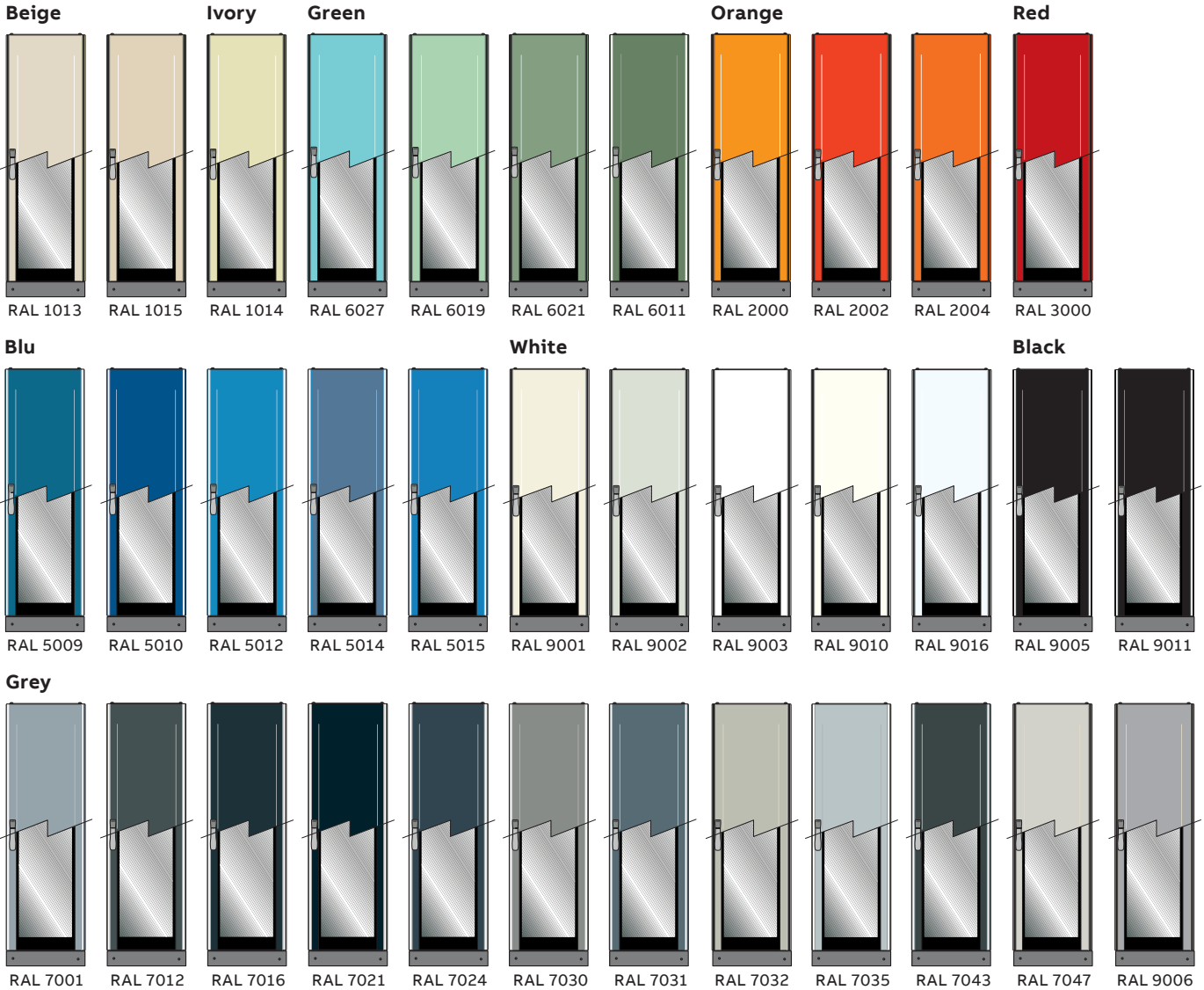

RAL	1013	1015	1014	6027	6019	6021	6011	2000	2002	2004	3000	5009	5010	5012	5014	5015	9001	9002
Smooth			●	●	●		●			●	●		●	●	●	●		●
Orange p.	●	●			●	●	●	●	●			●	●	●		●	●	●

RAL	9003	9010	9016	9005	9011	7001	7012	7016	7021	7024	7030	7031	7032	7035	7043	7047	9006
Smooth	●		●	●										●	●	●	●
Orange p.		●	●	●	●	●	●	●	●	●	●		●		●		

Other types of colours are available on request.

Corrosion test in saline mist

(Ref. Standard UNI ISO 9227, CEI50-5/4, IEC 60068-2-30)

Treatment time (hours)	24	48	72	96	120	144	168	192
Rust penetration	no	no	no	no	no	no	no	193 ⁽¹⁾
Blistering	no	no	no	no	no	no	no	no

⁽¹⁾ When a tearing test with adhesive tape is carried out after 193 hours of exposure, about 3 mm of paint detachment can be noted from the notch area with 1-1.5 mm rust penetration.

General purpose enclosures

Ordering codes - SR2 enclosures

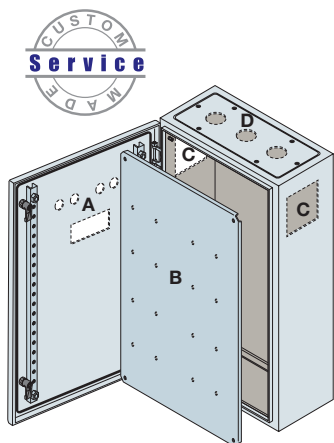

Special Drilling Service

The overprice amount depends on the number of individual drilled parts and not on the number of holes.

For single part it means: A-door B-plate; C-housing; D-top/bottom part.

Please note that the minimum quantity is 4 pieces with a single code.

The price of the special drilling service depends on the number of parts to be drilled and on the amount of enclosures to be drilled.

Description	Code	No. of enclosures to be drilled
Extra cost for drilling service per individual drilled part (A-B-C-D)	FORSR1	4-5-6
Extra cost for drilling service per individual drilled part (A-B-C-D)	FORSR2	7-8-9
Extra cost for drilling service per individual drilled part (A-B-C-D)	FORSR	≥ 10

Standard size enclosures with special drilling

The special drilling service for standard size enclosures in quantities equal to or greater than 4 units with a single code has to be managed with code SRN ... SPEC + overprice FORSR/ FORSR1/FORSR2 (see table) equal to the number of enclosures and the number of parts to be drilled + hole layout to be attached to the order (see on the next page).

Example: Enclosure (4 pcs) with door to be drilled (1 part)

Example: Enclosure (4 pcs) with door and plate to be drilled (1 parts)

SRN4320SPEC 4

FORSR1 4

DRAWINGS TO BE ATTACHED

Example: Enclosure (4 pcs) with door and plate to be drilled (2 parts)

SRN4320SPEC 4

FORSR1 8

DRAWINGS TO BE ATTACHED

Non-standard enclosure sizes, special drilling

Request feasibility of implementation by completing the relevant Form for special quotations and send it together with the drill layout to the R&D ECS office.

Management is per offer.

If the offer is accepted and after having received it, it will be possible to place the order with the codes indicated in the offer, that will not be SRN...SPEC, but dummy ones.

Always remember to indicate the offer reference in the order.

General purpose enclosures

Overall dimensions - Drillings SR2

Drillings SR2

Maximum useful overall dimensions for the drillings.

Flanges

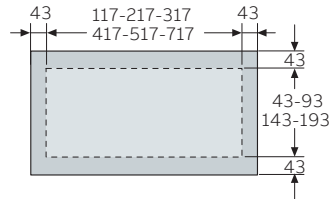

Side

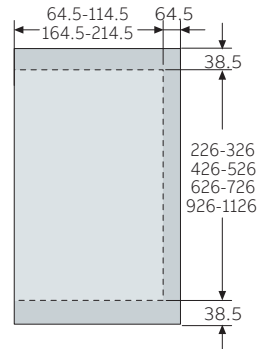

Doors H = 300-400-500

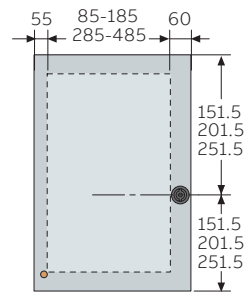

Doors H = 600-700-800

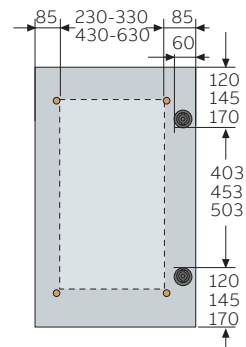

Doors H = 1000-1200

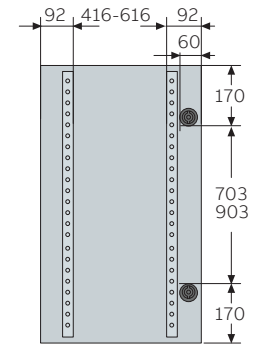

General purpose enclosures

General characteristics and applications - SRX enclosures

The AISI 304 stainless steel used allows the cabinets to be installed either indoors or outdoors, by fixing to the floor or a wall. AISI 304 stainless steel enclosures with opaque door, usually intended for making enclosures for automation, are supplied with the galvanised sheet metal internal plate and do not have cable entry flanges.

SRX enclosures always conform to IEC EN 62208 and to IEC 61439-1-2, have a degree of protection IP66 (IEC EN 60529); NEMA 4X and NEMA 3R (UL standard). The degree of protection against external mechanical impacts is IK10 for the version with opaque door and IK09 for the version with glass door (IEC 62262).

AISI 304 stainless steel enclosures with glass door can also be used for distribution configurations. Alternatively, the

internal equipment is made by selecting special kits (Distribution Kit) consisting of a pair of functional uprights for assembly of the AISI 304 stainless steel modular panels (to be ordered separately) and any compensation panels. The modular panels, which can also be installed on the enclosures with opaque door using the same KD Kit....X, are all hinged and have vertical modularity of 185 mm.



General purpose enclosures

General characteristics and applications - SRX enclosures

SRX enclosures can be equipped with: standard plates, clip nuts, spacers, slotted internal plate, accessories for stacking, DIN rails and fixing brackets, shaped sections for accessories on doors, closing systems.



Spray protection roof

Improves protection against infiltration by liquids and accidental sprays. Made of AISI 304 stainless steel.



Distribution kit

All apparatuses and modular circuit breakers can be installed on a DIN rail combined with a modular panel.



Stacking



SRX enclosures can be stacked using the special kit. The plinth with removable flanges is made of 25/10 thick AISI 304 stainless steel.



Closing box

A new Ø19 mm closing box made of chrome-finished plastic with double tongue key.

Technical characteristics

Conforms to	CEI EN 62208, IEC 61439-1-2
Degree of protection	IP66 (CEI EN 60529) UL Listed: UL 508A NEMA: Types 1, 3R, 4, 4X, 12
Degree of mechanical protection	IK10 opaque door IK09 glass door (IEC 62262)
Certifications	 
Type of material	AISI 304
Installation site	indoors/outdoors
Fixing method	floor/wall
Normal operating conditions - ambient temperature	from -5 to +55°C

General purpose enclosures

Selection of the structure - SRX enclosures

Rapid selection table

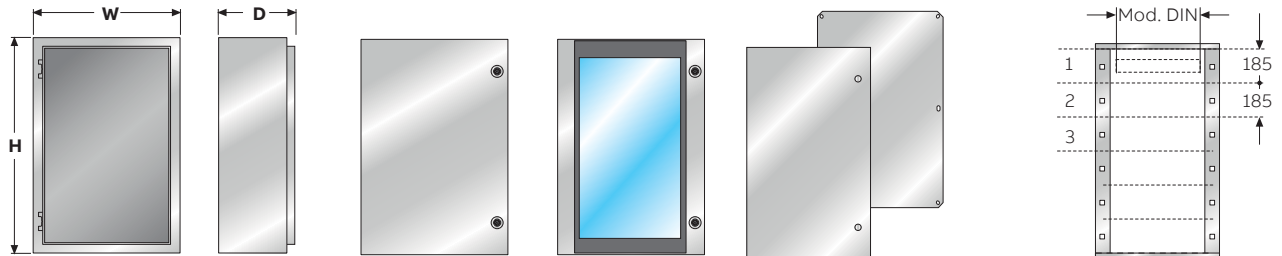

Overall dimensions			Automation kit				Distribution kit Supports for mounting modular panels			
H mm	W mm	D mm	Enclosures with opaque door + mounting plate	Enclosures with transparent door ¹	Opaque inner door IP20	Opaque plate	No. of vertical mod. H=185mm	No. of DIN mod. per row	Total modules	DIN supports
300	200	150	SRN3215X			PF3020				
	400	150	SRN3415X			PF3040				
400	300	150	SRN4315X		KC4030X	PF4030				
		200	SRN4320X							
	400	200	SRN4420X			PF4040				
	600	200	SRN4620X			PF4060				
500	400	200	SRN5420X	SRN5420VX	KC5040X	PF5040	2	14	28	KD5040X
	500	200	SRN5520X			PF5050				
600	400	200	SRN6420X	SRN6420VX	KC6040X	PF6040	3	14	42	KD6040X
		600	200	SRN6620X		PF6060				
	300	SRN6630X								
	700	500	250	SRN7525X	SRN7525VX	KC7050X	PF7050			
800	600	200	SRN8620X		KC8060X	PF8060	4	25	100	KD8060X
		250		SRN8625VX				25	100	
		300	SRN8630X					25	100	
	800	300	SRN8830X			PF8080				
1000	800	300	SRN10830X	SRN10830VX	KC1080X	PF1080	5	36	180	KD1080X
1200	600	300	SRN12630X			PF1260				
	800	300	SRN12830X			PF1280				

¹ Mounting plate to be ordered separately.

General purpose enclosures

Ordering codes - SRX enclosures

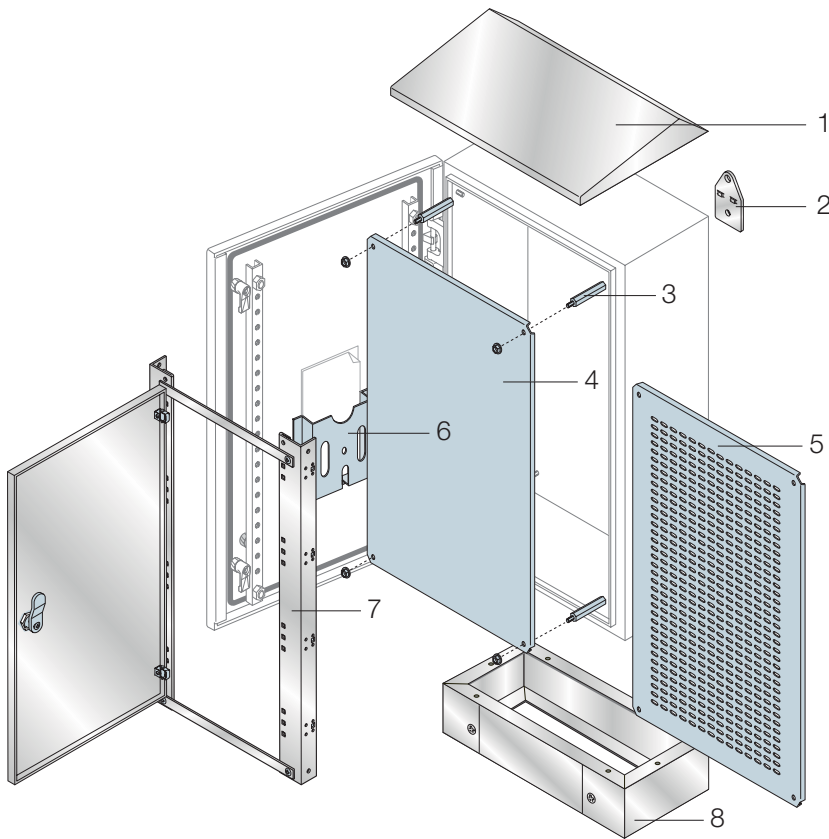

1 - Spray protection roof

2 - Wall-mounting brackets

3 - Spacers for back plates

4 - Opaque internal plate

5 - Slotted internal plate

6 - Document pocket

7 - Opaque inner door

8 - Plinth

9 - Frame for DIN rail

10 - Modular panels for apparatuses

11 - DIN rail

12 - Opaque modular panels

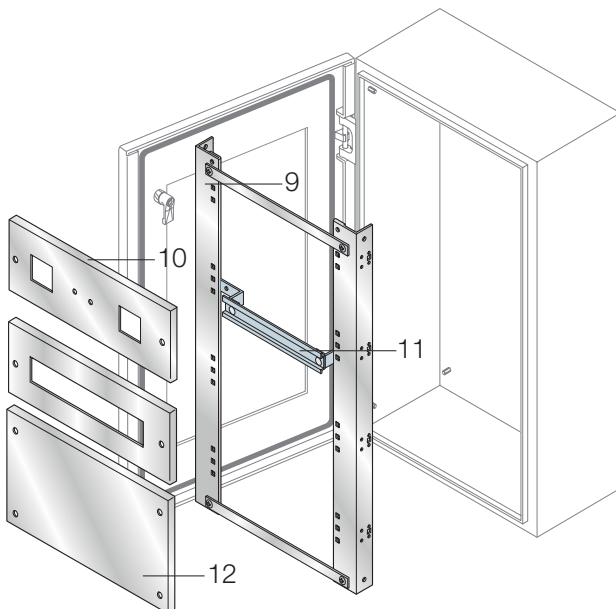

General purpose enclosures

Ordering codes - SRX enclosures

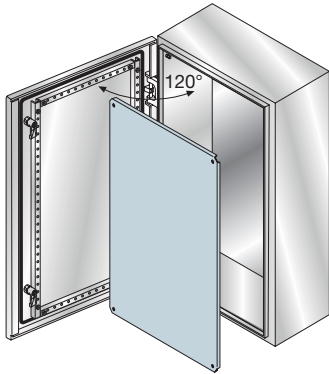

SRX series enclosures with opaque door (internal plate included)

Enclosures with an opaque door, made of AISI 304 stainless steel, usually intended for producing enclosures for automation, come supplied with the galvanised sheet metal internal plate and do not have cable entry flanges.

Enclosures with opaque door complete with internal mounting plate						
Dimensions (mm)				Code	Package/ No. of pieces	
H	W	D				
300	200	150		SRN3215X	1/1	
	400			SRN3415X	1/1	
400	300	150		SRN4315X	1/1	
	300		200		SRN4320X	1/1
	400				SRN4420X	1/1
500	600			SRN4620X	1/1	
	400	200		SRN5420X	1/1	
	500			SRN5520X	1/1	
600	400	200		SRN6420X	1/1	
	600			SRN6620X	1/1	
	600		300		SRN6630X	1/1
700	500	250		SRN7525X	1/1	
800	600	200		SRN8620X	1/1	
	600		300		SRN8630X	1/1
	800				SRN8830X	1/1
1000	800	300		SRN10830X	1/1	
1200	600	300		SRN12630X	1/1	
	800			SRN12830X	1/1	

SRX series stainless steel enclosures with transparent door

AISI 304 stainless steel enclosures with a glass door can also be used for distribution configurations. The internal equipment is set up using the relevant kits:

- KD...X (Distribution Kit) consisting of a pair of functional uprights for assembly of the modular panels made of AISI 304 stainless steel (to be ordered separately) and of any compensation panels. The modular panels, which can also be installed on the enclosures with opaque door using the KD kit, are all hinged and have vertical modularity of 185 mm. The enclosures with see-through door are provided without mounting plate.

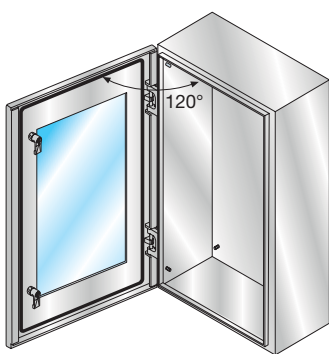

Enclosures with transparent door					
Dimensions (mm)				Code	Package/ No. of pieces
H	W	D			
500	400	200		SRN5420VX	1/1
600	400			SRN6420VX	1/1
700	500	250		SRN7525VX	1/1
800	600			SRN8625VX	1/1
1000	800	300		SRN10830VX	1/1

General purpose enclosures

Ordering codes - SRX enclosures

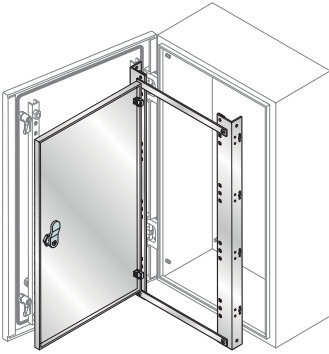

Opaque inner door

The inner door guarantees a degree of protection of IP20. Made of 15/10 thick AISI 304 stainless steel, complete with box and double tongue insert.

Opaque inner door			
Dimensions (mm)			Package/ No. of pieces
H	W	Code	
400	300	KC4030X	1/1
500	400	KC5040X	1/1
600		KC6040X	1/1
700	500	KC7050X	1/1
800	600	KC8060X	1/1
1000	800	KC1080X	1/1

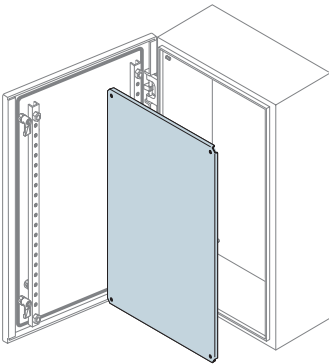

Opaque internal mounting plate

20/10 thick galvanised sheet metal internal plate, complete with fixing with small parts supplied. Depth-adjustable using a special spacer kit (to be ordered separately).

Opaque internal mounting plate			
Dimensions (mm)			Package/ No. of pieces
H	W	Code	
300	200	PF3020	1/1
300	400	PF3040	1/1
400	300	PF4030	1/1
400	400	PF4040	1/1
400	600	PF4060	1/1
500	400	PF5040	1/1
500	500	PF5050	1/1
600	400	PF6040	1/1
600	600	PF6060	1/1
700	500	PF7050	1/1
800	600	PF8060	1/1
800	800	PF8080	1/1
1000	800	PF1080	1/1
1200	600	PF1260	1/1
1200	800	PF1280	1/1

General purpose enclosures

Ordering codes - SRX enclosures

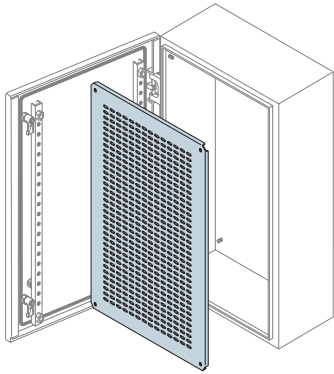

Slotted internal plate

Fixing with small parts supplied. Depth-adjustable using a special spacer kit (to be ordered separately).

Piastra interna asolata			
Dimensions (mm)			Package/ No. of pieces
H	W	Code	
300	200	TQ3020	1/1
300	400	TQ3040	1/1
400	300	TQ4030	1/1
400	400	TQ4040	1/1
400	600	TQ4060	1/1
500	400	TQ5040	1/1
600	400	TQ6040	1/1
600	600	TQ6060	1/1
700	500	TQ7050	1/1
800	600	TQ8060	1/1
800	800	TQ8080	1/1
1000	800	TQ1080	1/1
1200	600	TQ1260	1/1
1200	800	TQ1280	1/1

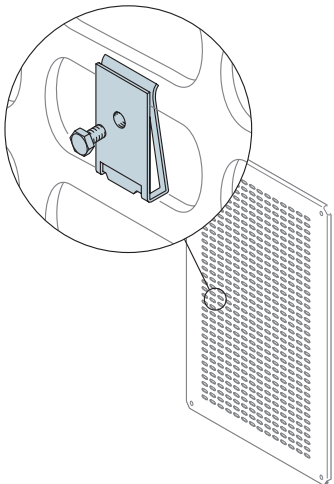

Clip nuts

For slotted plates with M6x10mm hexagonal head screws.

Description	Code	Package/ No. of pieces
Clip nuts	TQ6610	1/20

Spacer kit for adjusting back plate depth

Kit made up of 12 spacers for fixing the mounting plate. Allows depth adjustment in 25 mm steps.

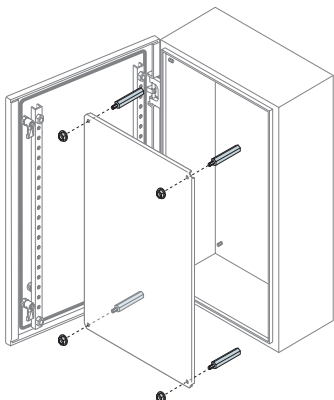

Description	Code	Package/ No. of pieces
Spacers, length 25 mm	AA8025	1/12
Spacers, length 50 mm	AA8050	1/12

General purpose enclosures

Ordering codes - SRX enclosures

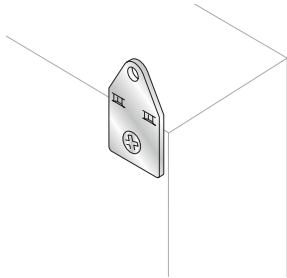

Wall-mounting brackets

Allow enclosures to be wall-mounted and are fitted using the special holes located on the back of the enclosures. Made of 30/10 thick AISI 304 stainless steel.

Description	Code	Package/ No. of pieces
No. 4 wall-mounting brackets	AA1206X	1/4

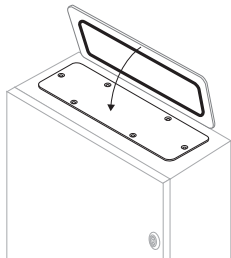

Fairlead plates

Fairlead plates in 25/10 thick AISI 304 stainless steel with polyurethane gasket.

Description	Dimensions (mm)		Code	Package/ No. of pieces
	W	D		
Fairlead plate) for SRN3215X	173	97	FLN3215X	1/1
Fairlead plate for SRN4315X	273	97	FLN4315X	1/1
Fairlead plate for SRN3415X	373	97	FLN3415X	1/1
Fairlead plate for SRN4320X, SRN4320VX	273	147	FLN4320X	1/1
Fairlead plate for SRN4420X, SRN5420X, SRN6420X, SRN5420VX, SRN6420VX	373	147	FLN4420X	1/1
Fairlead plate 500x200mm for SRN5520X	473	147	FLN5520X	1/1
Fairlead plate) for SRN4620X, SRN6620X, SRN8620X	573	147	FLN4620X	1/1
Fairlead plate for SRN7525X, SRN7525VX	473	197	FLN7525X	1/1
Fairlead plate for SRN8625VX	573	197	FLN8625X	1/1
Fairlead plate for SRN6630X, SRN8630X, SRN12630X	573	247	FLN6630X	1/1
Fairlead plate for SRN6830X, SRN8830X, SRN10830X, SRN12830X, SRN10830VX	773	247	FLN6830X	1/1

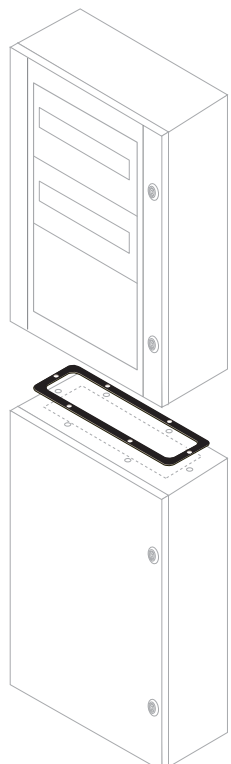

Accessories for stacking

Dimensions (mm)			Code	Package/ No. of pieces
W	D			
IP65 gasket				
400	200		GZ4020	1/1
500	200		GZ5020	1/1
	250		GZ5025	1/1
600	200		GZ6020	1/1
	250		GZ6025	1/1
	300		GZ6030	1/1
800	300		GZ8030	1/1

General purpose enclosures

Ordering codes - SRX enclosures

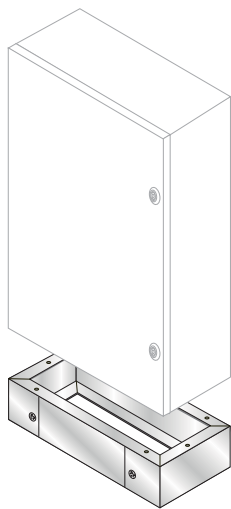

Plinth

25/10 thick AISI 304 stainless steel plinth.

Plinth					
Dimensions (mm)				Code	Package/ No. of pieces
H	W	D			
100	400	200		ZA4020X	1/1
100	500	200		ZA5020X	1/1
100		250		ZA5025X	1/1
100	600	200		ZA6020X	1/1
100		300		ZA6030X	1/1
100	800	300		ZA8030X	1/1

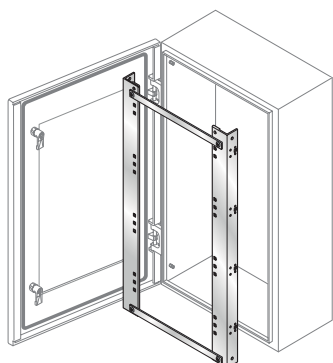

Frame for DIN rail

Internal supports for fixing modular panels and DIN rails, with compensation panels, made of AISI 304 stainless steel.

Description	Dimensions (mm)		Code	Package/ No. of pieces
	H	W		
Supports for 14 DIN mod. x 2 rows	500	400	KD5040X	1/1
Supports for 14 DIN mod. x 3 rows	600	400	KD6040X	1/1
Supports for 25 DIN mod. x 4 rows	800	600	KD8060X	1/1
Supports for 36 DIN mod. x 5 rows	1000	800	KD1080X	1/1

General purpose enclosures

Ordering codes - SRX enclosures

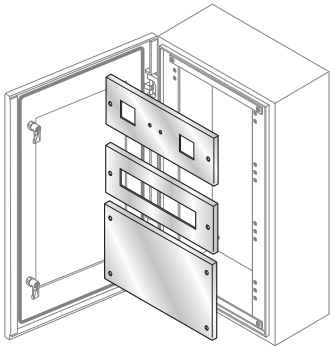

Screwed modular panels

12/10 mm thick AISI 304 stainless steel modular panels. The screwed modular panels can be fitted on the enclosures using the special kit (KD...) consisting of functional uprights and a compensation panel.

Each modular panel (PM) comes equipped with a DIN rail (depth-adjustable), fixing brackets and the relative small parts. Tmax modular and moulded-case circuit breakers up to T3 can be positioned side by side on the same DIN rail using the special depth adapter AP 6001. To install MCCBs, fix the DIN rail in the recessed position. The DIN rail fixing brackets allow mounting of the wiring duct up to a maximum size of 60 x 60 mm.

Stainless steel screwed modular panels for DIN rail (including DIN rail and fixing brackets)

Description	Dimensions (mm)		Code	Package/ No. of pieces
	H	W		
14 DIN mod. + fixing bracket	185	400	PM1414X	1/1
25 DIN mod. + fixing bracket	185	600	PM1625X	1/1
36 DIN mod. + fixing bracket	185	800	PM1836X	1/1

Stainless steel screwed modular panels for measuring instruments

Description	Dimensions (mm)		Code	Package/ No. of pieces
	H	W		
2 instruments 72 x 72mm	185	400	PS2476X	1/1
2 instruments 72 x 72mm	185	600	PS2676X	1/1
2 instruments 72 x 72mm	185	800	PS2876X	1/1

Stainless steel opaque screwed modular panels

Description	Dimensions (mm)		Code	Package/ No. of pieces
	H	W		
Opaque panel	185	400	PC1406X	1/1
Opaque panel	185	600	PC1606X	1/1
Opaque panel	185	800	PC1806X	1/1
Opaque panel	370	600	PC2606X	1/1
Opaque panel	370	800	PC2806X	1/1

Shaped sections for accessories

Allow fixing of accessories (e.g.: wiring ducts) inside the blind doors. Consist of a pair of vertical crosspieces made of 15/10 thick white galvanised sheet metal, pre-drilled with 25 mm pitch. In enclosures with height 1000 and 1200 mm with a blind door, the shaped sections are already supplied.

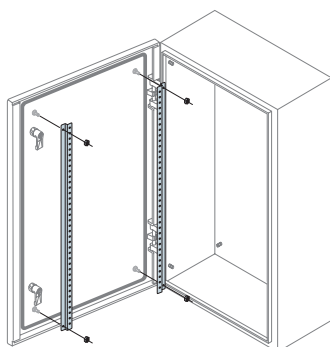

Description	Dimensions (mm)		Code	Package/ No. of pieces
	H	W		
Shaped sections for door	600		TS6009	1/2
Shaped sections for door	700		TS7009	1/2
Shaped sections for door	800		TS8009	1/2

General purpose enclosures

Ordering codes - SRX enclosures

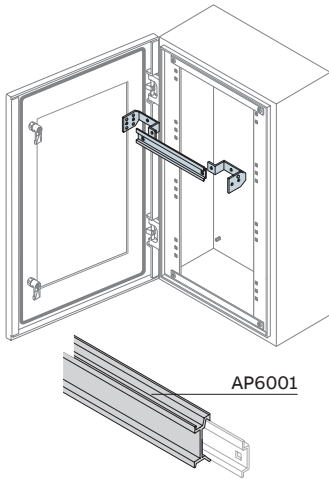

DIN rail and fixing brackets

Description	No. modules	W (mm)	Code	Package/ No. of pieces
DIN rail and fixing brackets	14	400	GD4006	1/1
DIN rail and fixing brackets	25	600	GD6006	1/1
DIN rail and fixing brackets	36	800	GD8006	1/1
Depth adapter				
No.1 depth adapter for Tmax T1-T2-T3-XT1-XT3 W = 600 mm			AP6001	1/4

Spray protection roof

Improves protection against infiltration by liquids and accidental sprays.
Made of 15/10 thick AISI 304 stainless steel.

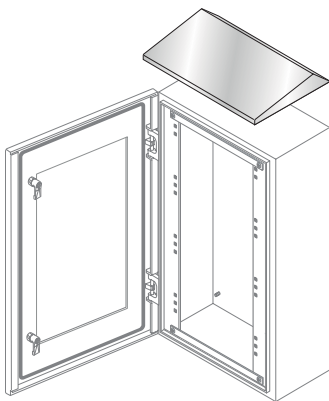

Spray protection roof

Dimensions (mm)			Package/ No. of pieces
W	D	Code	
200	150	TT2015X	1/1
300	150	TT3015X	1/1
400	150	TT4015X	1/1
300	200	TT3020X	1/1
400	200	TT4020X	1/1
500	200	TT5020X	1/1
600	200	TT6020X	1/1
500	250	TT5025X	1/1
600	250	TT6025X	1/1
600	300	TT6030X	1/1
800	300	TT8030X	1/1

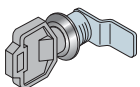

AA8001X

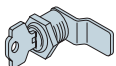

AA8002

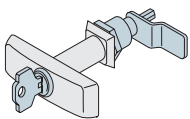

AA8003



EV1008

Closing systems

May substitute standard fasteners for the external doors.

Description	Code	Package/ No. of pieces
Box Ø 19 mm double tongue made of chrome-finished plastic and key for external door	AA8001X	1/1
Box Ø 19 mm with safety insert and Yale type key for external door	AA8002 ⁽¹⁾	1/1
Box Ø 19 mm with handle and Yale type key for external door	AA8003 ⁽¹⁾	1/1
Box Ø 19 mm with triangular insert for external door	AA5200 ⁽¹⁾	1/1
Plastic key for triangular insert AA5200 for external door	AA5190	1/1
Box with double tongue insert made of plastic with key for inner door (without tongue)	EV1008	1/1
Single code Yale insert for inner door	EV1036	1/1
Ronis 455 insert for inner door	EV1037	1/1
3mm double tongue insert for inner door	EV1039	1/1

⁽¹⁾ Only for external door

General purpose enclosures

Ordering codes - SRX enclosures

Spare parts

Description	Code	Package/ No. of pieces
Stainless steel screws (No. 16 screws, flanged nuts and nylon washers M6)	AA1203X	1/1
Opaque door 300x200 mm (HxW)	PRN3026X	1/1
Opaque door 300x400 mm (HxW)	PRN3046X	1/1
Opaque door 400x300 mm (HxW)	PRN4036X	1/1
Opaque door 400x400 mm (HxW)	PRN4046X	1/1
Opaque door 400x600 mm (HxW)	PRN4066X	1/1
Opaque door 500x400 mm (HxW)	PRN5046X	1/1
Opaque door 500x500 mm (HxW)	PRN5056X	1/1
Opaque door 600x400 mm (HxW)	PRN6046X	1/1
Opaque door 600x600 mm (HxW)	PRN6066X	1/1
Opaque door 600x800 mm (HxW)	PRN6086X	1/1
Opaque door 700x500 mm (HxW)	PRN7056X	1/1
Opaque door 800x600 mm (HxW)	PRN8066X	1/1
Opaque door 800x800 mm (HxW)	PRN8086X	1/1
Opaque door 1000x800 mm (HxW)	PRN1086X	1/1
Opaque door 1200x600 mm (HxW)	PRN1266X	1/1
Opaque door 1200x800 mm (HxW)	PRN1286X	1/1
Glass door 400x300 mm (HxW)	PTN4036X	1/1
Glass door 500x400 mm (HxW)	PTN5046X	1/1
Glass door 600x400 mm (HxW)	PTN6046X	1/1
Glass door 700x500 mm (HxW)	PTN7056X	1/1
Glass door 800x600 mm (HxW)	PTN8066X	1/1
Glass door 1000x800 mm (HxW)	PTN1086X	1/1

General purpose enclosures

Ordering codes - SRX enclosures

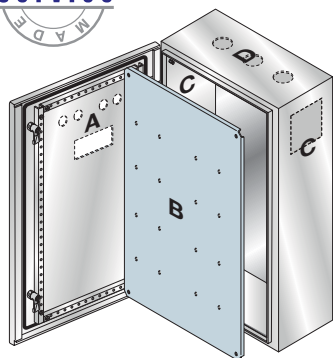

Special Drilling Service

The overprice amount depends on the number of individual drilled parts and not on the number of holes.

For single part it means: A-door B-plate; C-housing; D-top/bottom part.

Please note that the minimum quantity is 10 pieces with a single code. The price of the special drilling service depends on the number of parts to be drilled and on the amount of enclosures to be drilled.

Description	Code	No. of enclosures to be drilled
Extra cost for drilling service per individual drilled part (A-B-C-D)	FORSRX	≥ 10

The special drilling service for standard size enclosures in quantities equal to or greater than 10 units with a single code has to be managed with code SRN ... SPEC + overprice FORSR/ FORSR1/FORSSR2 (see table) equal to the number of enclosures and the number of parts to be drilled + hole layout to be attached to the order.

**Example: SRN4320XSPEC 10
FORSRX 10**

**Example: Enclosure (10 pcs) with door and plate to be drilled (2 parts)
SRN4320XSPEC 10
FORSRX 20
DRAWINGS TO BE ATTACHED**

Non-standard enclosure sizes, special drilling

Request feasibility of implementation by completing the relevant Form for special quotations and send it together with the drill layout to the R&D ECS office. Management is per offer.

If the offer is accepted and after having received it, it will be possible to place the order with the codes indicated in the offer.



Painting Special Service

Request feasibility of implementation by completing the relevant Form for special quotations and send it to the R&D ECS office. Management is per offer.

If the offer is accepted and after having received it, it will be possible to place the order with the codes indicated in the offer.

General purpose enclosures

Overall dimensions - Drillings SRX

SRX enclosure drilling

Maximum working dimensions for drilling.

Flanges

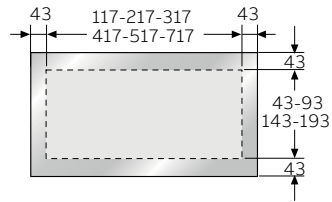

Side

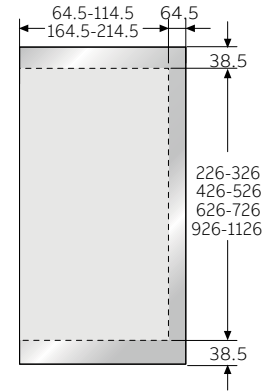

Doors H = 300-400-500

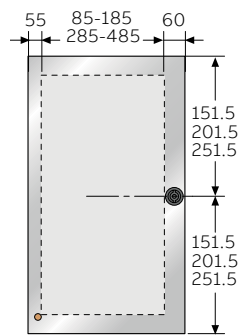

Doors H = 600-700-800

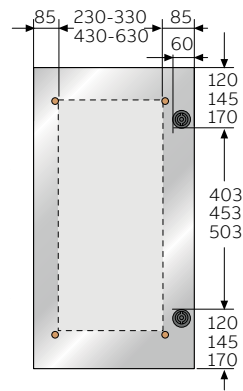

Doors H = 1000-1200

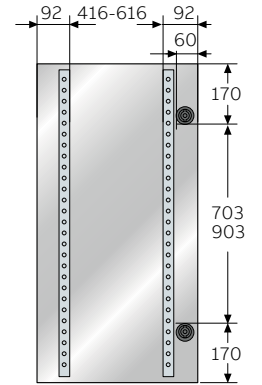

General purpose enclosures

Switchboards for industrial applications
with blank front



General purpose enclosures

Switchboards for industrial applications with blank front

Technical characteristics

- protection degree IP 65
- insulation class II
- available in RAL 7035 grey
- available in the versions with transparent, smoky doors
- in polycarbonate material, self-extinguishing and resistant to abnormal heat and fire up to 960 °C (glow wire flammability index) in compliance with IEC 60695-2-11 Standard
- installation temperature from -25 °C to +60 °C
- resistant to heat: ball thermopressure up to +125 °C in compliance with EN 60695-10-2 Standard
- shock resistance 20 Joules (IK level 10)
- perfectly symmetrical switchboards with possibility of hinging the door onto the front (by means of the special articulated screws supplied) on the right or left with 140° opening
- doors designed to take lock with coded key, code 12 866 all models (except for code 13 200) are fitted with one rigid and one bi-material flange for the facilitated insertion of conduits and cables
- switchboards made and produced in compliance with CEI 23-49 (1996) + V1 + V2, CB certificate IEC 60670-24 Standards
- switchboards are supplied complete with:
 - 4 screw-cover caps to guarantee
 - accessories for hinging the front part
 - 1 self-adhesive indicator strip per row
 - 1 certification plate
 - instruction sheet
- use 3.5×9.5 self-tapping screws to fix the components on the back



General purpose enclosures

Switchboards for industrial applications with blank front



Transparent, smoky door – 12 modules

RAL 7035 grey

Dimensions W × H × D [mm]	Order code	Box/pack No items
275x370x140	M132040020	1/4



Transparent, smoky door – 12 modules

RAL 7035 grey

Dimensions W × H × D [mm]	Order code	Box/pack No items
275x455x140	M132050020	1/3



Transparent, smoky door – 18 modules

RAL 7035 grey

Dimensions W × H × D [mm]	Order code	Box/pack No items
380x570x140	M132080020	1/2

General purpose enclosures

Switchboards for industrial applications with blank front – Accessories



Terminal holders

The terminal block is completed by combining the necessary terminal bars to the terminal holders, taking care to keep the terminal bars separate from each other.

For switchboards type	Description	Order code	Box/pack No items
13 204 - 13 205 - 13 206	for 12 modules	M125400000	12/144
13 208	for 18 modules	M125430000	12/108



Terminal bars

The terminal bars can be installed on any kind of terminal holder; they are snapped onto these with 2 clips for bar, through two holes made at the ends of the bar itself.

Description No of holes × Ø holes (mm) + No of holes × mm ²	Order code	Box/pack No items
5×16	M125310000	20/240
10×16 + 3×25	M125320000	20/240
16×16 + 3×25	M125330000	20/240
15×16 + 6×25	M125340000	20/240
19×16 + 6×25	M125350000	20/240

Terminal holders and terminal bars are supplied separately. In this way, by inserting one or two terminal bars into the terminal holder you can create the best terminal for your requirements, with the advantage of obtaining a terminal block that is cheap as well as personalised, due to the fact that you only need to use material that is really necessary. Some standard configurations are illustrated in the table.

All the possible configurations that can be created for each type of consumer unit are given in the technical details.

General purpose enclosures

Switchboards for industrial applications with blank front – Accessories



Wall brackets

Description	Order code	Box/pack No items
In insulating material	M128580000	20/240