

Welcome to the ABB STOTZ KONTAKT training program about ABB i-bus KNX. This e-learning module deals with basic information about the Energy Actuator SE/S 3.16.1. If you need help navigating through this module, please click the Help button. To view the presenter notes as text, click the Notes button in the bottom right-hand corner. You can also download this presentation in printable format by clicking the attachment button in the top right-hand corner.

Learning objectives



Upon completion of this eLearning module you will have detailed knowledge of...

- the upcoming changes in the field of power generation and distribution
- how and why the energy sector is a state of upheaval
- the resulting need for an even more intelligent switch actuator
- the available solution: the Energy Actuator with its numerous functions based on the ABB i-bus KNX

© ABB Energy Automation Division
November 15, 2013 10:00



At the end of this eLearning module you will have detailed knowledge of

...the upcoming changes in the field of power generation and distribution

...how and why the energy sector is in a state of upheaval.

...the resulting need for an even more intelligent switch actuator

...the available solution: the Energy Actuator with its numerous functions based on the ABB i-bus KNX

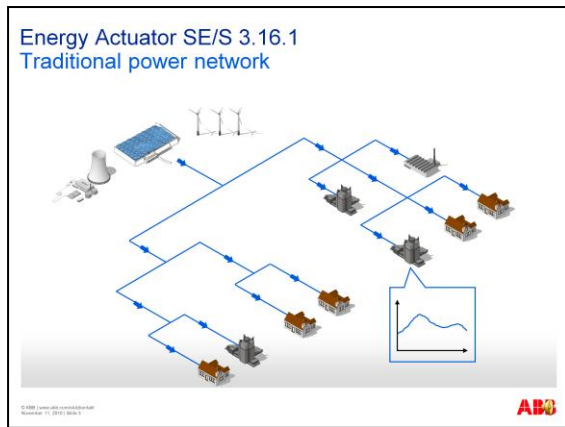

What is the traditional structure of our electrical energy supply?

It is the centralised generation of electrical energy , e.g. in power plants. It is a one-way energy flow, from the power plant to the consumer.

The amount of electrical energy produced must be aligned to the energy used, with only limited storage capabilities available.

At this moment the supply network is hardly prepared to cope with new decentralised energy producers.

Operations such the daily load curves are only based on past experience.

The behaviour of the system (consumption and energy production) is foreseeable.

Energy Actuator SE/S 3.16.1
The Power Network of the Future

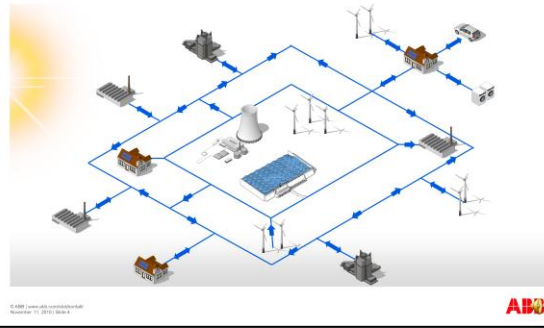

What is the future of electrical energy production? How will the future, the Smart Grid, look ?

De-centralised power generation (wind, solar, block-heating power plants), the energy flow will become bi-directional,

Operations will be based on the prevailing weather conditions (wind, sun), small-scale producers will also be able to access the power network.

In the future the load response will depend on the volume of power generated.

The general behaviour of the system (consumption and energy production) can not be foreseen.

Energy Actuator SE/S 3.16.1



And what about residential buildings, the Smart Home, of the future?

The Smart Home can:

produce electrical energy, for example via photovoltaic systems, communicate with the smart grid and react to flexible electricity rates;

switch consumers intelligently and re-schedule energy consumption;

reduce energy costs and CO₂ emissions;

inform the user simply about costs, tariffs, current and probable future energy consumption.

Energy Actuator SE/S 3.16.1

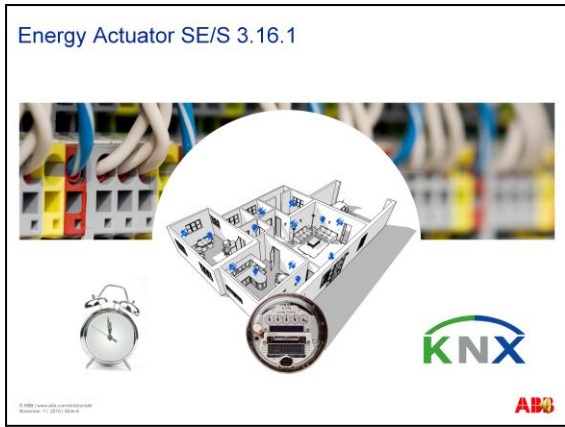

With the intelligent power grids of tomorrow – the Smart Grids – electrical building installations will face new challenges. In order to increase the energy efficiency of buildings, and at the same time integrate the consumers in the load compensation, it is necessary to switch electrical devices in buildings based on external signals such as time, consumption thresholds or similar.

The ABB i-bus® KNX provides the optimum prerequisites for intelligent buildings.

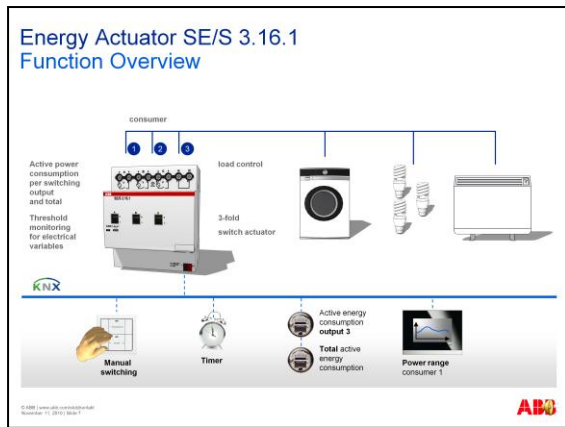

Following the switch actuator with current detection, ABB's Energy Actuator SE/S 3.16.1 represents the next level of intelligent actuators for ABB i-Bus KNX.

In this module you will obtain more information about the Energy Actuator SE/S 3.16.1. Following a graphic overview of its functions the principle of the integrated electricity meter with intermediate metering will be explained, as well as the diagnostics options and threshold value functions. We will look at the principle of load control and finish by taking a closer look at the device's hardware.

This slide shows the most important functions of the device in conjunction with ABB i-bus KNX.

A number of different electrical measurements can be recorded for each channel and transferred to KNX

The active energy consumption for each channel or for all 3 channels can be visualized together or separately, e.g. at a predetermined time by means of a time switch connected to KNX. The power per channel or the total power is measured continuously and can be shown with a display e.g. a touch panel or a visualisation.

As with a classic switch actuator, using sensors such as push buttons, every output can be accessed individually at any time. Load control and threshold value monitoring round off the functionality of the electrical variables.

Energy Actuator SE/S 3.16.1

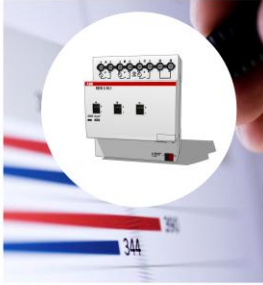

- **Capture of active energy consumption in final circuits („Energy Count“)**
- **Diagnosis and monitoring**
 - Capture / Measuring
 - Threshold values (warning and switching)
- **Load optimisation**
Simple load management in form of load control
- **3-fold switch actuator**
Same as existing ABB i-bus® KNX switch actuators

© 2009 ABB Energy Automation Ltd.
Revised 11/2009 3.16.1



The new Energy Actuator determines the active energy consumption per switching output and provides the total consumption of all three outputs.

Energy Actuator SE/S 3.16.1 Energy consumption – Main meter

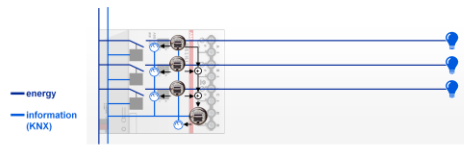

- One „main meter“ per switching channel for active consumption
- Three consumption values added to give total consumption
- Up-to-date meter values transmitted cyclically or on request
- Main meter can be reset with „Master“- Reset
- Measuring accuracy in accordance with accuracy class 2 EN 62053-21 for electronic active consumption meters

© 2009 ABB Energy Automation
Revised 11/2010 3.16.1



There is a main meter to measure the active consumption of each channel and another for the total consumption.

These values can be transmitted from the Energy Actuator to the bus at adjustable time intervals cyclically, or on request.

If needed the main meter can be reset. This is carried out using its own communication object, the enable and reset object.

Measuring accuracy is in accordance with accuracy class 2 for electronic meters.

Energy Actuator SE/S 3.16.1 Energy consumption – Intermediate meter

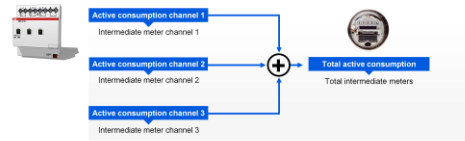

- Every active consumption meter has additional intermediate meter
- Every intermediate meter freely configurable

© 2009 ABB Energy Automation
Revised: 11/2010 (3.16.1)



Besides the main meter every active consumption meter has an intermediate meter, to record for example daily consumption and the subsequent reset of the meter.

The intermediate meters are freely-programmable, for example for the start and stop conditions of the meter.

Energy Actuator SE/S 3.16.1 Energy consumption – Intermediate meter



- All meter values can be transmitted cyclically, on request or upon a start or stop event
- Flexible setting of the intermediate meter
- The assigned switching output can be switched independently of stop events

© 2008 ABB. All rights reserved.
Revised: 11/2008 (3.16.1)



As we mentioned before, the meter values can be transmitted cyclically or on request. The Energy Actuator also allows the meter for example to start at a given time and after a certain operating time to stop automatically. A 1-Bit telegram or the time is available as a start and stop event.

In addition, an end value or an operating time can be parameterized for a stop event. The intermediate meter offers a high level of flexibility.

If the stop condition has been met, the corresponding output can be also switched, to prevent, for example, further energy consumption.

Energy Actuator SE/S 3.16.1 Typical applications – Intermediate meter

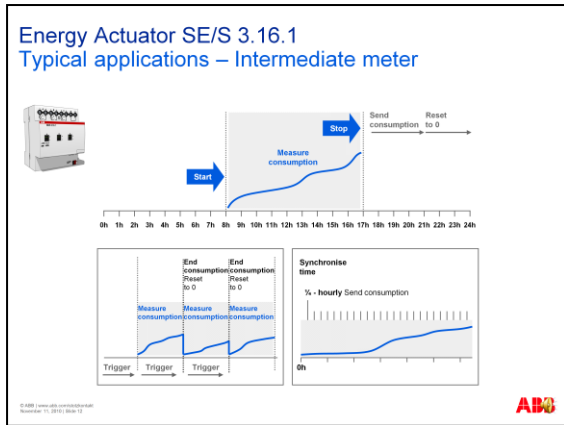

Typical applications for the intermediate meter, which the Energy Actuator makes possible include:

The energy consumption in a system is measured during the operating time.

To do this the Energy Actuator starts the meter at 8 am and stops it at 5 pm.

The value measured is transmitted for example to a display and the meter is reset.

This slide shows an application in which the metering is stopped, the reading transmitted and the meter reset after a period of measurement.

In this example the kilowatt hours are made available every 15 minutes. The values are added in order to always have the latest figures available.

Energy Actuator SE/S 3.16.1

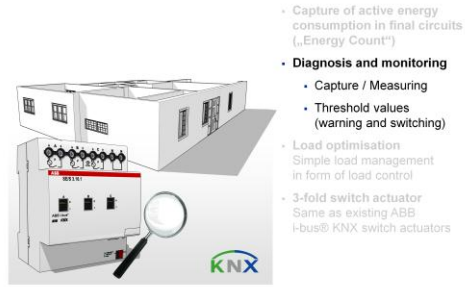

- Capture of active energy consumption in final circuits („Energy Count“)
- **Diagnosis and monitoring**
 - Capture / Measuring
 - Threshold values (warning and switching)
- Load optimisation
Simple load management in form of load control
- 3-fold switch actuator
Same as existing ABB i-bus® KNX switch actuators

© 2008 ABB Energy Automation Division
Revised: 11/2008 (3.16.1)



Active power, current and voltage, as well as other electrical variables (apparent power, reactive power, crest factor, power factor and frequency) can be measured for every channel.

One possible application might be to monitor the electrical systems in an industrial plant. The measurements are then made available via KNX and can be monitored with threshold values. If the defined threshold values are overshoot or undershot a warning can be sent or the channel switched.

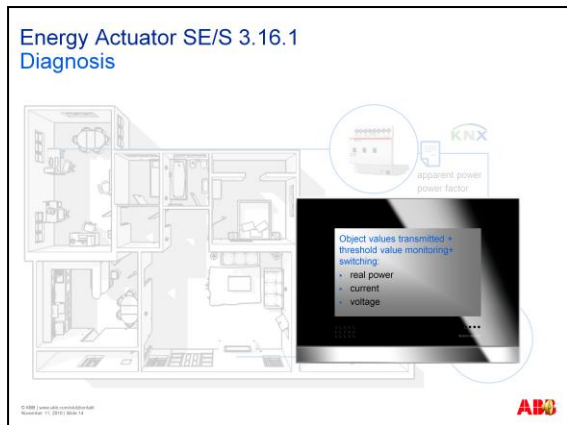

The following electrical variables are available with the Energy Actuator:

Apparent power, power and crest factors.

These values can be transmitted to the bus.

Total active power and frequency. The object values can be transmitted and threshold value monitoring set.

For example, a warning signal can be transmitted when a defined frequency is undershot.

For the real power per channel, current and voltage, the assigned switching output can also be activated when the threshold value is reached .

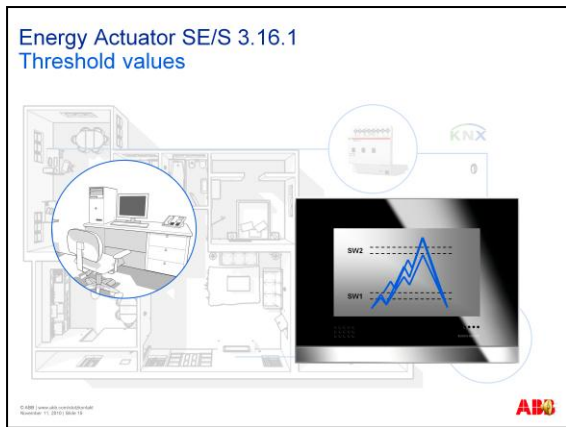

There are 2 threshold values available for each channel, and each threshold value has an upper and a lower limit. This enables a hysteresis function.

A delay time can also be parameterized, so that short overshoot or undershoot can be disregarded. If necessary the threshold values can be altered using a value telegram via the bus.

So it is possible to adjust this threshold value during operation without extra programming. There is also a separate object for the warning function which can transmit a logical 1 or 0 in the event of overshoot or undershoot.

In practice this means that, in order to protect the electronics, the device should not be used if there is undervoltage.

Energy Actuator SE/S 3.16.1



- Capture of active energy consumption in final circuits („Energy Count“)
- Diagnosis and monitoring
 - Capture / Measuring
 - Threshold values (warning and switching)
- **Load optimisation**
Simple load management in form of load control
- 3-fold switch actuator
Same as existing ABB i-bus® KNX switch actuators

© 2009 ABB Energy Automation Ltd.
Revised 11/2009 (3.16.1)



The ETS application also enable a simple load management functionality, with which the channels of up to ten Energy Actuators can be interconnected.

Energy Actuator SE/S 3.16.1 Load control

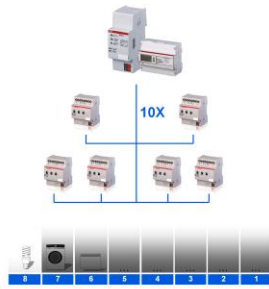

- The master receives up to 10 power values
- 8 settings with priority
- Comparison of the totaled power values with an adjustable threshold value
- Performance values > limit: consumer with low priority is switched off
- power values < limit: switched off circuits reactivated
- Load peaks avoided and hysteresis function

ABB

The master, an Energy Actuator, can receive up to 10 performance values from up to 10 Energy Actuators, i.e. a total of 30 installed load circuits.

It is also possible to incorporate the load levels of other components, e.g. an ABB electricity meter with KNX interface ZS/S 1.1.

The consumers can be assigned to one of the 8 priority levels available .

The power values of all the circuits are added and compared to a parameterised threshold.

In the event of overshoot the consumers with the lowest priority are switched off first.

If this is not sufficient, the next priority level is then switched.

In the event of undershoot the procedure is reversed and the levels with the highest priority are the first to be switched on again.

Delay times allow short load peaks to be avoided and a hysteresis parameterized in the load limits.

Energy Actuator SE/S 3.16.1 Load control



- Deactivation of load control or individual slaves
- Master switches via 1 byte object
- Application: residential building with limited installed power



Whenever necessary, individual slave-channels can be removed via telegram from the load control and the entire control system can also be deactivated.

The communication between master and slave is via a 1 Byte object.

Example for on application : a residential building has only limited of incoming mains connection capacity available .

In order to prevent the entire supply being switched when this value is reached, a simple solution would be the load control of the SE/S 3.16.1

Energy Actuator SE/S 3.16.1



- Capture of active energy consumption in final circuits („Energy Count“)
- Diagnosis and monitoring
 - Capture / Measuring
 - Threshold values (warning and switching)
- Load optimisation
 - Simple load management in form of load control
- **3-fold switch actuator**
 - Same as existing ABB i-bus® KNX switch actuators

© 2008 ABB Energy Automation Ltd.
Revised 11/2008 (08/08) 14



The Energy Actuator SE/S 3.16.1 is also a high-performance 3-channel switch actuator. Most of its functions are available from ABB's proven range of products. These include time and logic functions, priority control or scenes. The electrical consumers connected to the three floating switching outputs can be switched via KNX or manually with manual actuation directly on the device.

Energy Actuator SE/S 3.16.1 Hardware

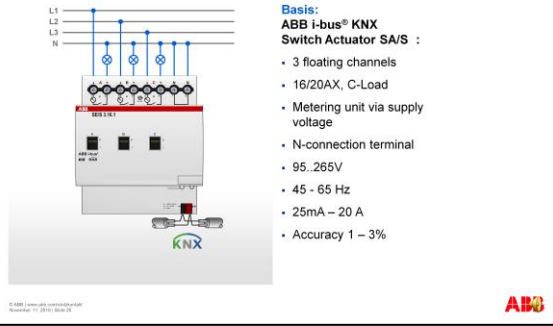

The Energy Actuator hardware is based on the tried and tested ABB switch actuators with the powerful C-load relay, there are 3 channels with 16 or 20 A and AX switching characteristics.

At least one phase of the mains voltage must be connected in order to measure the electrical values.

There is a separate double connection terminal for the neutral wire.

The voltage measuring range is between 95 and 265 V, and the frequency measuring range between 45 and 65 Hertz.

Currents are measured between 25 mA and 20 A.

The accuracy of all these values is normally between 1 and 3 % of the value.

Memorize

Have you understood everything so far?

Yes
(continue)

What have we learnt so far?

- The changing face of energy supply
- How to adapt consumer controlling
- Solution with ABB i-bus KNX and Energy Actuator SE/S 3.16.1
- Current options...
 - transparency in energy consumption
 - monitoring
 - intelligent load control



© 2008 ABB Energy Automation
Reproduction is permitted



What have we learnt so far?

Energy supply is going through a period of change

Control and regulation of the consumers in buildings must adapt to this and provide suitable alternatives

ABB i-Bus KNX with the Energy Actuator SE/S 3.16.1 is the ideal solution

This device offers many interesting options such as

- ...transparency in the energy consumption of individual electrical circuits
- ... monitoring of the installation and consumer
- ... intelligent load control, e.g. in the case of limited connected load

Have you understood everything so far? If you have, please click the „Yes“ button to continue or, “No” if you would like to repeat the topic



Thank you very much for taking this first unit of the eLearning course about the Energy Actuator SE/S 3.16.1. We hope that this course has been interesting and helpful in extending your knowledge of our energy actuator, the technologies involved and their areas of operation.