

Technical reference

Spacing data

In the UK, Building Regulation 2000 : B1 covers the provision of safe and effective means of escape from a building.

Approved Document B (2000) (ADB) is a published guide to the Building Regulations, which specifies that standards for the installation of escape lighting should be according to BS 5266 Part 1.

BS 5266 Part 1 is the umbrella standard which refers to EN 1838 (BS 5266 Part 7), defining emergency lighting levels of minimum 1.0 lux on the centre line of an escape route, and 0.5 lux minimum for open areas larger than 60m².

British Standards are recognised worldwide, or are commonly used as the basis of local standards. NFPA 101 Life Safety Code standards require an average of 10.8 lux with not less than 1.1 lux at any point for escape routes.

We recommend that a copy of relevant local standards are obtained prior to any design work. We are pleased to supply data for any of our luminaires in LUMDAT format, for use with Relux or similar lighting packages.

We offer the following data for guidance to assist with design work to BS 5266 requirements. Data is shown for a selection of luminaires, for a typical 2.5 metre ceiling height.

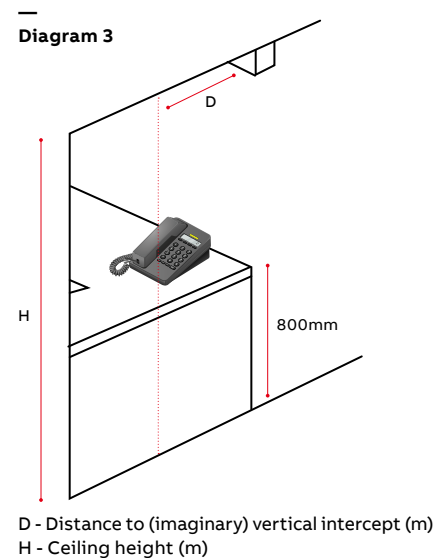
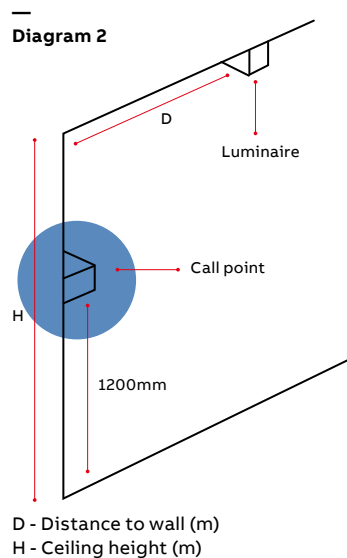
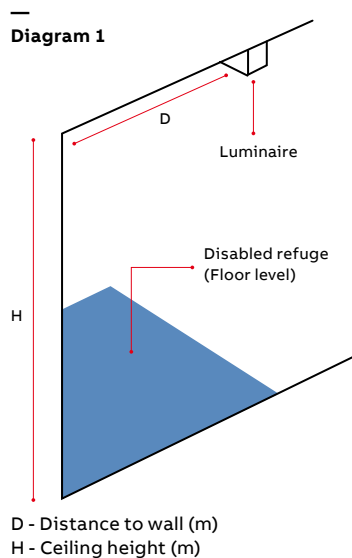

Technical reference

Spacing data

—
Serenga SR2, emergency spot light

Point of emphasis - Disabled refuge see diagram 1

h (m)		Minimum lux
Self-contained		
2.5	1.6	7.2
2.8	1.8	7.2
3.2	1.9	6.3
3.7	2.1	5.5
4.0	2.3	5.05
Slave 230V		
2.5	1.5	8.2
2.8	1.7	7.1
3.2	2	6.6
3.7	2.3	5.9
4.0	2.4	5.7

—
Serenga SR2, emergency spot light

Point of emphasis - Call point see diagram 2

h (m)		Minimum lux
Self-contained		
2.5	1.5	15.5
2.8	1.7	12.7
3.2	1.9	8.15
3.7	2.1	5.56
4.0	-	-
Slave 230V		
2.5	1.5	17.8
2.8	1.75	13.3
3.2	2	9.5
3.7	2.4	6.64
4.0	2.4	5.7

—
Serenga SR2, emergency spot light

Point of emphasis - Telephone see diagram 3

h (m)		Minimum lux
Self-contained		
2.5	1	24.6
2.8	1.1	20.4
3.2	1.2	14.1
3.7	1.5	9.7
4.0	1.9	7.58
Slave 230V		
2.5	1	28.3
2.8	1.15	21.4
3.2	1.4	15.2
3.7	1.5	11.2
4.0	1.75	9.06

—
Serenga SR2, wall mount Lens G

Self contained and Slave (1.0 lux) Slave (1.0 lux)

h (m)		Distance to escape route centre (t)		
		1m	1.5m	
0.5	1.5	3.7	1.7	5.0
1.0	1.6	4.0	1.6	5.7
1.5	1.5	3.6	2.5	5.8
2.0	1.2	3.5	2.5	5.6
2.5	0.0	1.8	2.3	5.3
3.0	0.0	0.0	2.0	5.0
3.5	0.0	0.0	1.1	3.3

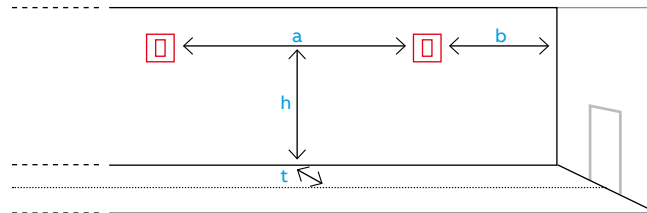

Technical reference

Spacing data

Serenga 2, escape route lighting - lens A

h (m)				
Self Contained (1.0 lux)				
2.0	1.8	4.9	6.4	18.8
2.5	1.3	5.3	6.4	19.4
3.0	1.0	5.0	3.9	18.3
3.5	0.9	3.9	3.6	16.6
4.0	0.9	3.1	2.5	15.6
Slave (1.0 lux)				
2.0	2.0	5.2	7.0	19.7
2.5	1.6	5.6	6.9	20.8
3.0	1.2	5.5	4.8	20.0
3.5	1.1	4.8	4.0	19.7
4.0	1.0	3.7	3.2	16.8

Serenga 2, escape route lighting - lens B

h (m)				
Self Contained (1.0 lux)				
4.5	1.6	4.2	6.9	17.4
5.0	1.6	4.4	7.1	18.3
5.5	1.6	4.5	7.3	19.1
6.0	1.6	4.6	7.1	19.8
6.5	1.5	4.7	7.2	20.3
7.0	1.4	4.7	7.0	20.5
7.5	1.3	4.7	7.0	20.7
8.0	1.1	4.6	6.7	20.7
Slave (1.0 lux)				
4.5	1.7	4.4	7.4	17.8
5.0	1.7	4.6	7.7	19.0
5.5	1.8	4.7	7.8	19.9
6.0	1.7	4.9	7.6	20.7
6.5	1.6	5.0	7.7	21.3
7.0	1.6	5.0	7.7	21.8
7.5	1.5	5.0	7.5	22.0
8.0	1.4	5.0	7.4	22.1

Serenga 2, escape route lighting - lens C

h (m)				
Self Contained (1.0 lux)				
8.5	2.0	5.8	7.1	17.0
9.0	1.9	5.8	7.3	17.7
9.5	1.7	5.9	7.4	18.3
10.0	1.2	5.9	7.5	18.9
10.5	0.0	6.0	0.0	14.1
11.0	0.0	5.2	0.0	12.6
11.5	0.0	4.5	0.0	12.2
12.0	0.0	4.0	0.0	12.0
Slave (1.0 lux)				
8.5	2.1	6.1	7.6	17.4
9.0	2.1	6.2	7.8	18.1
9.5	2.0	6.2	7.9	18.8
10.0	1.9	6.2	8.1	19.4
10.5	1.5	6.3	7.9	20.0
11.0	0.4	6.4	8.0	20.6
11.5	0.0	6.4	0.0	14.0
12.0	0.0	5.2	0.0	13.3

Serenga 2, open area - lens D

h (m)				
Self Contained (0.5 lux)				
2.0	3.9	8.1	3.9	8.1
2.5	4.6	10.0	4.6	10.0
3.0	5.4	11.6	5.4	11.6
3.5	6.0	13.2	6.0	13.2
4.0	6.6	14.8	6.6	14.8
Slave (0.5 lux)				
2.0	3.9	8.2	3.9	8.2
2.5	4.6	10.0	4.6	10.0
3.0	5.4	11.8	5.4	11.8
3.5	6.3	13.4	6.3	13.4
4.0	6.9	15.0	6.9	15.0

Serenga 2, open area - lens E

h (m)				
Self Contained (0.5 lux)				
4.5	5.0	11.0	5.0	11.0
5.0	5.3	12.0	5.3	12.0
5.5	5.5	12.9	5.5	12.9
6.0	5.8	13.7	5.8	13.7
6.5	5.6	14.4	5.6	14.4
7.0	4.2	14.3	4.2	14.3
7.5	3.6	14.1	3.6	14.1
8.0	3.2	14.1	3.2	14.1
Slave (0.5 lux)				
4.5	5.0	11.2	5.0	11.2
5.0	5.3	12.2	5.3	12.2
5.5	5.7	13.1	5.7	13.1
6.0	6.0	14.0	6.0	14.0
6.5	6.0	14.7	6.0	14.7
7.0	8.8	15.5	8.8	15.5
7.5	4.5	15.3	4.5	15.3
8.0	4.1	15.2	4.1	15.2

Serenga 2, open area - lens F

h (m)				
Self Contained (0.5 lux)				
8.5	4.7	11.4	4.7	11.4
9.0	4.8	11.7	4.8	11.7
9.5	4.8	12.0	4.8	12.0
10.0	5.1	12.4	5.1	12.4
10.5	5.1	12.7	5.1	12.7
11.0	5.1	12.9	5.1	12.9
11.5	5.1	13.2	5.1	13.2
12.0	5.3	13.5	5.3	13.5
Slave (0.5 lux)				
8.5	4.9	11.8	4.9	11.8
9.0	5.0	12.1	5.0	12.1
9.5	5.0	12.5	5.0	12.5
10.0	5.3	12.8	5.3	12.8
10.5	5.3	13.1	5.3	13.1
11.0	5.4	13.5	5.4	13.5
11.5	5.6	13.7	5.6	13.7
12.0	5.6	14.0	5.6	14.0

Technical reference

Spacing data

Daylite Prismatic LED 251 Lm

h (m)				
Escape				
2.0	3.5	7.3	1.6	5.5
2.5	4.2	8.8	1.5	4.6
3.0	5.0	10.3	1.1	4.6
4.0	-	13.4	-	3.6
Open				
2.0	3.7	7.6	2.7	6.9
2.5	4.4	9.3	2.3	7.5
3.0	5.2	10.9	2.3	7.8
4.0	6.7	13.8	1.8	6.6

Daylite Opal LED 214 Lm

h (m)				
Escape				
2.0	3.1	7.8	2.8	7.0
2.5	3.3	8.4	2.9	7.6
3.0	3.3	8.9	3.0	8.0
4.0	3.2	9.4	2.8	8.3
Open				
2.0	3.9	9.6	3.5	8.7
2.5	4.2	10.5	3.8	9.5
3.0	4.4	11.3	4.0	10.2
4.0	4.7	12.4	4.2	11.1

Daylite Silverscape Prismatic LED 241 Lm

h (m)				
Escape				
2.0	3.6	7.6	2.6	6.5
2.5	3.9	9.2	2.9	7.1
3.0	4.4	10.7	1.5	7.7
4.0	-	12.0	-	4.6
Open				
2.0	3.8	8.0	3.3	7.5
2.5	4.6	9.6	3.6	8.5
3.0	5.3	11.3	3.8	9.5
4.0	6.0	14.4	2.3	10.6

Cordona Prismatic LED 207 Lm S/C EM

h (m)				
Escape				
2.0	2.9	7.3	2.9	7.3
2.5	3.1	7.9	3.1	7.9
3.0	3.1	8.3	3.1	8.3
4.0	3.1	8.8	3.1	8.8
Open				
2.0	3.7	9.1	3.7	9.1
2.5	3.9	9.9	3.9	9.9
3.0	4.2	10.6	4.2	10.6
4.0	4.4	11.6	4.4	11.6

Cordona & Camarque Opal LED 1830 Lm Slave

h (m)				
Escape				
2.0	5.7	13.8	5.7	13.8
2.5	6.3	15.3	6.3	15.3
3.0	6.8	16.5	6.8	16.4
4.0	7.6	18.8	7.6	18.7
Open				
2.0	6.9	16.7	6.9	16.6
2.5	7.6	18.3	7.6	18.3
3.0	8.2	20.1	8.2	20.0
4.0	9.4	22.8	9.4	22.8

Cordona Prismatic LED 2355 Lm Slave

h (m)				
Escape				
2.0	5.8	14.3	5.8	14.1
2.5	6.5	15.7	6.6	15.5
3.0	7.1	16.8	7.1	16.9
4.0	8.0	19.7	7.9	19.7
Open				
2.0	7.2	17.0	7.1	16.9
2.5	7.8	18.9	7.7	18.7
3.0	8.4	20.8	8.5	20.4
4.0	9.9	23.4	9.9	23.3

Cordona & Camarque Opal LED 207 Lm S/C EM

h (m)				
Escape				
2.0	2.9	7.3	2.9	7.3
2.5	3.1	7.9	3.1	7.9
3.0	3.1	8.3	3.1	8.3
4.0	3.1	8.8	3.1	8.8
Open				
2.0	3.7	9.1	3.7	9.1
2.5	3.9	9.9	3.9	9.9
3.0	4.2	10.6	4.2	10.6
4.0	4.4	11.6	4.4	11.6

Weather force opal LED 207 Lm

h (m)				
Escape				
2.0	2.9	7.5	2.7	6.9
2.5	3.0	8.0	2.9	7.5
3.0	3.0	8.3	2.9	7.8
4.0	2.8	8.6	2.7	8.2
Open				
2.0	3.7	9.4	3.5	8.7
2.5	4.0	10.2	3.8	9.4
3.0	4.2	10.8	3.9	10.0
4.0	4.3	11.6	4.1	10.9

Technical reference

Spacing data

PrimEvo XT100E & XT100ST

h (m)	↔		↔		↔	
2.00	2.49	6.57	6.92	7.19	2.57	
2.50	2.50	6.93	7.17	7.34	2.56	
3.00	2.39	7.11	7.28	7.40	2.43	
3.50	2.14	7.12	7.22	7.32	2.17	
4.00	1.68	6.96	6.99	7.07	1.72	

PrimEvo TW220E

h (m)	↔		↔		↔	
2.50	5.39	11.75	6.85	2.03	0.86	
3.00	6.47	14.11	8.22	2.44	1.04	
3.50	7.15	16.04	9.26	2.66	1.18	
4.00	7.57	17.69	9.89	2.87	1.28	
4.50	7.94	19.15	10.44	3.14	1.36	
5.00	7.93	20.15	10.87	3.39	1.42	

PrimEvo RS100E/RS100ST and SM100E/SM100ST

h (m)	↔		↔		↔	
2.00	1.34	3.41	6.14	9.41	4.10	
2.50	1.40	3.69	6.87	10.66	4.44	
3.00	1.50	3.81	7.44	11.53	4.69	
3.50	1.55	3.91	7.85	12.28	4.90	
4.00	1.53	4.10	8.15	12.86	5.17	

Indulux Double Sided LED IND3LS5DS & CTIND3LS5DS

h (m)	↔		↔		↔	
2.5	3.89	10.70	2.39	6.31		
3.0	3.81	10.91	2.36	6.60		
3.5	3.62	10.94	2.23	6.74		
4.0	3.25	10.82	1.96	6.74		
4.5	2.50	10.54	1.49	6.59		
5.0	0.19	10.09	0.32	6.28		
5.5	-	8.54	-	5.78		
6.0	-	6.80	-	4.22		
6.5	-	3.74	-	2.98		
7.0	-	0.94	-	1.20		

Indulux Single Sided LED IND3LS5 & CTIND3LS5

h (m)	↔		↔		↔	
2.5	3.50	9.24	3.01	7.70		
3.0	3.56	9.65	3.11	8.19		
3.5	3.54	9.92	3.13	8.54		
4.0	3.43	10.06	3.07	8.76		
4.5	3.25	10.09	2.94	8.89		
5.0	2.96	10.02	2.71	8.90		
5.5	2.56	9.82	2.37	8.80		
6.0	1.94	9.50	1.84	8.60		
6.5	0.77	9.08	0.84	8.27		
7.0	-	8.51	-	7.81		

Indulux Double sided LED IND1LS5DS & IND1LS5DSLTC

h (m)	↔		↔		↔	
2.5	5.37	14.17	3.16	7.89		
3.0	5.49	14.73	3.30	8.46		
3.5	5.51	15.11	3.38	8.90		
4.0	5.45	15.36	3.37	9.22		
4.5	5.31	15.48	3.29	9.44		
5.0	5.10	15.47	3.14	9.55		
5.5	4.74	15.35	2.88	9.55		
6.0	4.21	15.14	2.50	9.46		
6.5	2.14	14.80	1.93	9.25		

Indulux Single sided LED IND1LS5 & IND1LSLTC

h (m)	↔		↔		↔	
2.5	4.62	11.80	3.83	9.46		
3.0	4.82	12.50	4.07	10.22		
3.5	4.95	13.04	4.25	10.85		
4.0	5.03	13.48	4.36	11.37		
4.5	5.04	13.82	4.42	11.79		
5.0	5.00	14.05	4.43	12.10		
5.5	4.90	14.20	4.38	12.33		
6.0	4.74	14.28	4.28	12.50		

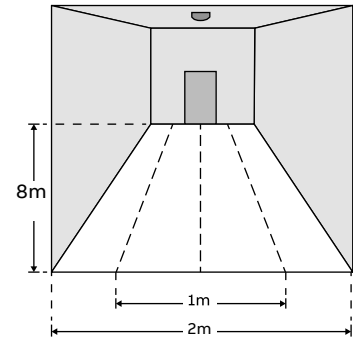

Technical reference

Spacing data

Hyled, escape route lighting

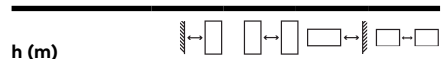

h (m)

Self Contained (1.0 lux) 3hr

2.0	1.8	5.3	3.7	8.2
2.5	1.7	5.2	4.5	8.9
3.0	1.7	5.0	5.2	11.3
3.5	1.8	4.9	5.9	12.9
4.0	2.0	4.9	6.5	14.4
5.0	2.3	5.3	8.2	17.3
6.0	2.5	5.9	9.4	20.2
7.0	2.6	6.5	10.6	23.0
8.0	2.7	7.0	11.7	25.8
9.0	2.7	7.5	12.7	28.3
10.0	2.5	7.8	13.6	30.7
11.0	1.7	8.0	14.0	33.0

Slave (1.0 lux)

2.0	1.9	5.4	3.9	8.2
2.5	2.4	6.8	4.9	10.4
3.0	2.8	8.3	5.7	12.5
3.5	2.8	8.3	6.4	14.2
4.0	2.7	8.2	7.0	15.8
5.0	2.7	7.8	8.5	18.8
6.0	3.0	7.8	9.8	22.0
7.0	3.4	7.9	11.5	24.9
8.0	3.5	8.5	12.6	27.7
9.0	3.8	9.1	14.2	30.6
10.0	4.0	9.7	15.2	33.6
11.0	4.2	10.3	16.8	36.4
12.0	4.3	10.8	17.6	39.2
13.0	4.4	11.3	19.1	41.8
14.0	4.2	11.8	19.9	44.4
15.0	4.0	12.1	20.5	46.8
16.0	3.7	12.4	21.1	49.2
17.0	3.0	12.6	21.6	51.5
18.0	1.6	12.5	21.3	53.7

Hyled, open area

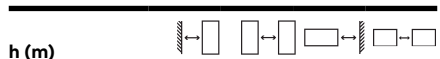

h (m)

Self Contained (0.5 lux) 3hr

2.0	3.4	7.6	3.4	9.6
2.5	4.2	9.1	4.2	9.1
3.0	4.8	10.7	4.8	10.7
3.5	5.2	12.0	5.2	12.0
4.0	5.6	13.3	5.6	13.3
5.0	6.3	15.3	6.3	15.3
6.0	6.8	16.8	6.8	16.8
7.0	7.1	18.1	7.1	18.1
8.0	7.4	19.2	7.4	19.2
9.0	7.5	20.1	7.5	20.1
10.0	7.2	20.9	7.2	20.9
11.0	6.3	21.5	6.3	21.5

Slave (0.5 lux)

2.0	3.6	7.7	3.6	7.7
2.5	4.5	9.7	4.5	9.7
3.0	5.2	11.7	5.2	11.7
3.5	6.1	13.3	6.1	13.3
4.0	6.8	14.5	6.8	14.8
5.0	7.8	17.7	7.8	17.7
6.0	8.7	20.4	8.7	20.4
7.0	9.5	22.5	9.5	22.5
8.0	10.1	24.4	10.1	24.4
9.0	10.6	25.9	10.6	25.9
10.0	11.0	27.3	11.0	27.3
11.0	11.3	28.5	11.3	28.5
12.0	11.9	29.7	11.9	29.7
13.0	12.0	30.7	12.0	30.7
14.0	12.1	31.7	12.1	31.7
15.0	11.6	32.6	11.6	32.6
16.0	11.1	33.2	11.1	33.2
17.0	10.6	33.8	10.6	33.8
18.0	7.6	34.2	7.6	34.2

Ovano, XT200M3H & XT201M3H

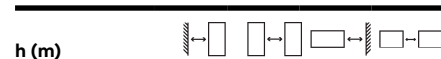

h (m)

XT200M3H

2.0	3.11	7.53	3.29	7.50
2.5	3.35	8.34	3.49	8.37
3.0	3.48	8.98	3.62	8.93
3.5	3.51	9.47	3.68	9.37
4.0	3.47	9.79	3.65	9.70

XT201M3H

2.0	3.24	7.98	2.05	5.04
2.5	3.56	8.71	2.34	5.38
3.0	3.77	9.35	2.60	5.87
3.5	3.90	9.98	2.80	6.48
4.0	3.99	10.43	2.94	7.02

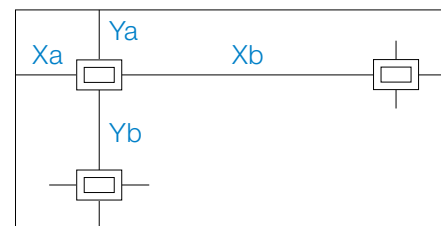

Technical reference

Spacing data

Lutia ceiling mount Open area



h (m)	Ya	Yb	Xa	Xb
Self Contained				
3 hrs (0.5 lux)				
2.0	1.50	3.40	3.00	6.40
2.5	1.40	3.60	4.00	8.00
3.0	1.60	4.00	4.10	10.00
3.5	1.60	4.40	5.00	11.00
4.0	1.50	4.40	5.50	12.00
5.0	1.50	4.40	6.00	15.00
6.0	1.50	4.40	6.50	16.00
Slave (0.5 lux)				
2.0	1.70	4.00	3.00	7.00
2.5	2.00	4.60	3.50	8.00
3.0	2.00	5.00	5.00	10.00
3.5	2.20	5.20	5.00	10.00
4.0	2.30	5.40	6.00	13.00
5.0	2.30	6.20	7.50	15.00
6.0	2.20	6.20	8.00	18.00
7.0	2.20	6.60	8.00	18.00

Lutia ceiling mount escape route

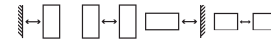

h (m)	Ya	Yb	Xa	Xb
Self Contained				
3 hrs (1.0 lux)				
2.0	1.1	3.2	3.8	8.5
2.5	1.0	3.0	4.5	9.9
3.0	1.0	3.0	5.0	11.3
3.5	1.1	2.9	5.5	12.6
4.0	1.1	2.9	5.8	13.8
5.0	1.0	3.0	5.7	15.6
6.0	0.7	3.0	5.2	16.3
Slave (1.0 lux)				
2.0	1.7	4.5	4.3	9.7
2.5	1.6	4.7	5.0	11.2
3.0	1.6	4.3	5.7	12.6
3.5	1.5	4.4	6.3	14.1
4.0	1.5	4.4	7.0	15.4
5.0	1.5	4.2	7.9	18.1
6.0	1.5	4.3	8.4	20.4
7.0	1.4	4.4	8.3	22.3

MirEvo Twinspot, escape route lighting

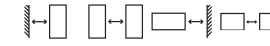

h (m)	Ya	Yb	Xa	Xb
Self Contained				
3 hrs (1.0 lux)				
2.0	2.98	6.71	3.23	7.29
2.5	3.56	8.08	3.78	8.58
3.0	4.06	9.02	4.01	9.29
3.5	4.51	9.90	4.19	9.87
4.0	4.90	10.90	4.35	10.38
Slave (1.0 lux)				
2.0	3.02	6.75	3.26	7.34
2.5	3.69	8.28	3.94	8.91
3.0	4.16	9.25	4.19	9.62
3.5	4.63	10.08	4.40	10.22
4.0	5.05	11.03	4.57	10.75

Lutia wall mount Open area



h (m)	Yb	Xa	Xb
Self Contained			
3 hrs (0.5 lux)			
2.0	1.70	2.50	6.00
2.5	1.70	3.50	8.00
3.0	2.00	4.00	9.00
3.5	2.10	5.30	10.00
4.0	2.10	6.00	14.00
5.0	2.40	6.70	15.00
Slave (0.5 lux)			
2.0	1.90	3.00	7.00
2.5	2.20	4.00	10.00
3.0	2.40	5.00	10.00
3.5	2.60	5.00	10.00
4.0	2.70	6.50	14.00
5.0	2.90	8.00	16.00
6.0	3.10	9.00	18.00
7.0	3.30	9.00	18.00

Lutia wall mount escape route

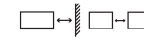

h (m)	Xa	Xb
Self Contained 3 hrs (1.0 lux) Yc = 1m		
2.0	3.50	7.80
2.5	4.10	9.40
3.0	4.60	10.00
3.5	5.00	12.00
4.0	5.20	12.80
5.0	5.30	14.20
6.0	4.60	14.40
Slave (1.0 lux)		
2.0	4.0	8.8
2.5	4.7	10.4
3.0	5.4	12.0
3.5	5.9	13.4
4.0	6.5	14.6
5.0	7.2	17.0
6.0	7.4	19.0
7.0	7.4	20.4

