

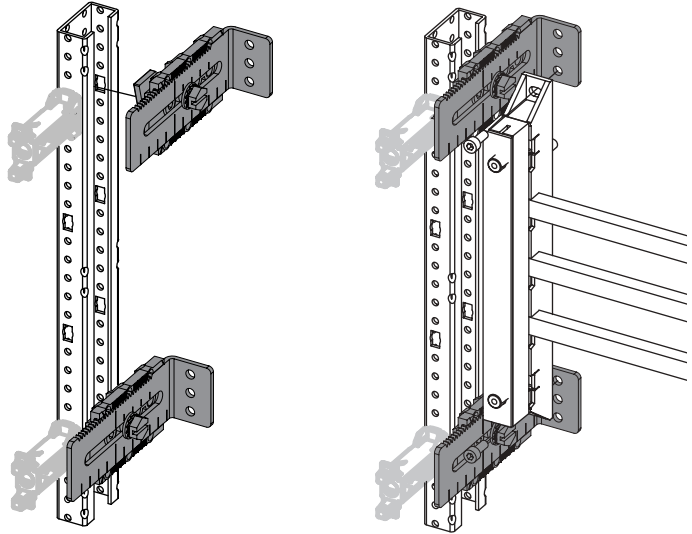

	SW5 max. 5 Nm		
--	----------------------------	--	--



ZW142

ZW144

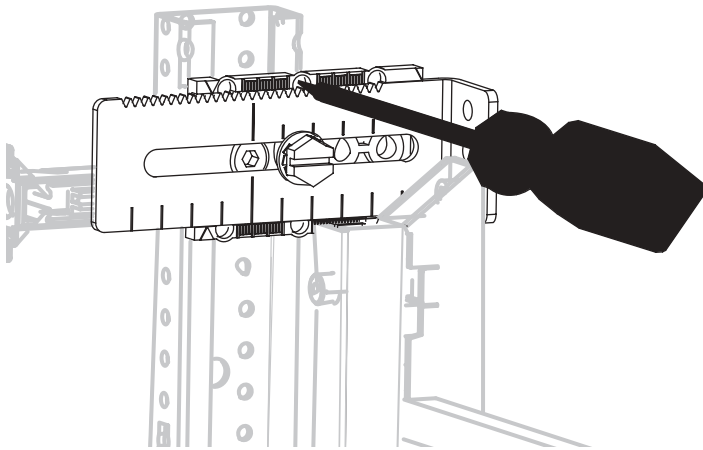

	SW5 max. 5 Nm		
--	----------------------------	--	--

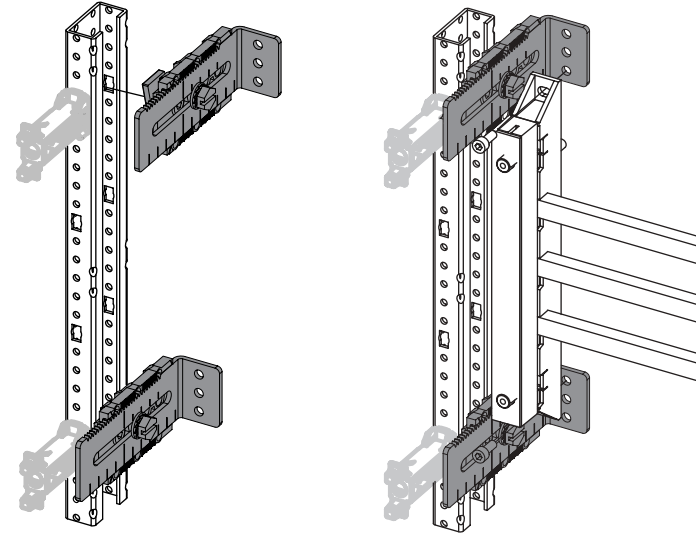

ZW142

ZW144

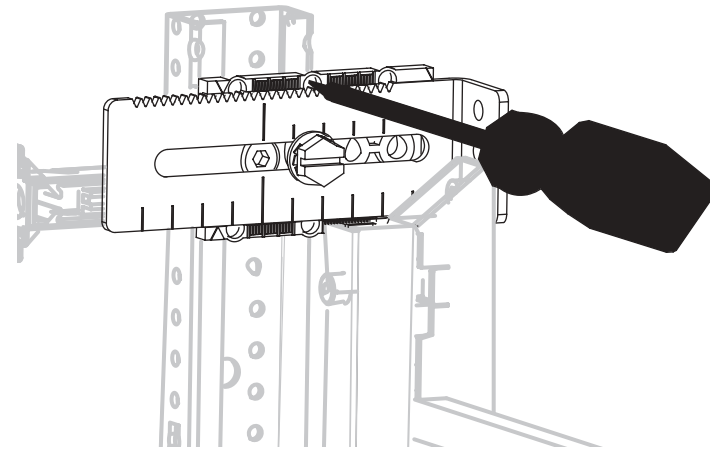

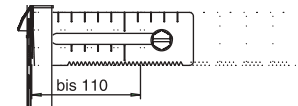
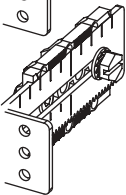
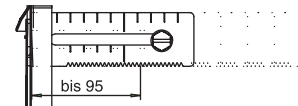
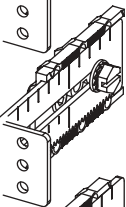
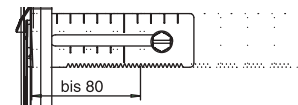
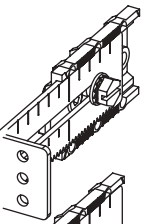
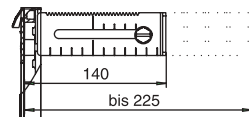
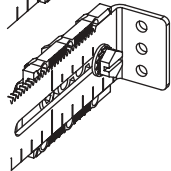
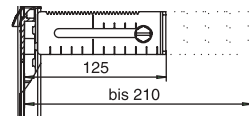
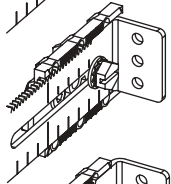
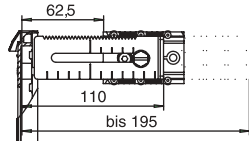
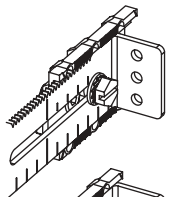

ZW144

(GB)

Only qualified electrical personell according to DIN 57105 part 1 / VDE 0105 part 1 / DIN EN 50110-1 are allowed to work on electrical installations.

(F)

Seul le personnel qualifié en électricité selon DIN 57105 part1 / VDE 0105 part 1 / DIN EN 50110-1 est autorisé à travailler sur installation électrique.

(D)

Arbeiten an elektrischen Betriebsmitteln / Anlagen dürfen nur durch eine ausgebildete Elektrofachkraft gemäß DIN 57105 Teil1 / VDE 0105 Teil 1 / DIN EN 50110-1 durchgeführt werden.
EDV-Nr.: 16743 / A / 12.08.2008

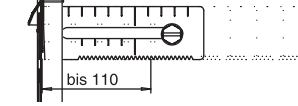
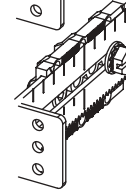
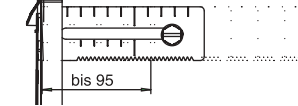
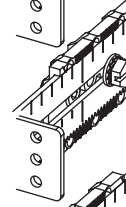
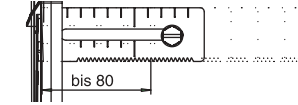
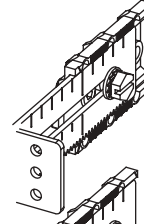
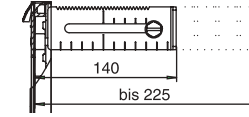
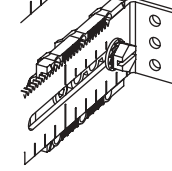
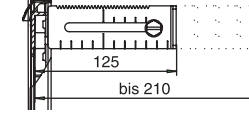
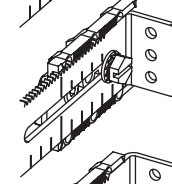
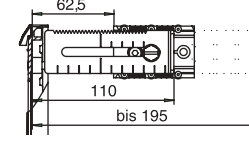
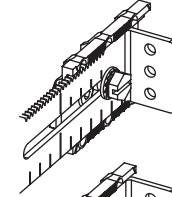
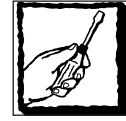

ZW144

(GB)

Only qualified electrical personell according to DIN 57105 part 1 / VDE 0105 part 1 / DIN EN 50110-1 are allowed to work on electrical installations.

(F)

Seul le personnel qualifié en électricité selon DIN 57105 part1 / VDE 0105 part 1 / DIN EN 50110-1 est autorisé à travailler sur installation électrique.

(D)

Arbeiten an elektrischen Betriebsmitteln / Anlagen dürfen nur durch eine ausgebildete Elektrofachkraft gemäß DIN 57105 Teil1 / VDE 0105 Teil 1 / DIN EN 50110-1 durchgeführt werden.
EDV-Nr.: 16743 / A / 12.08.2008

