

Rectifier Diode

5SDD 57X6500

V_{RSM}	=	6500 V
$I_{F(AV)M}$	=	5850 A
$I_{F(RMS)}$	=	9200 A
I_{FSM}	=	$110 \cdot 10^3$ A
V_{F0}	=	0.84 V
r_F	=	0.098 m Ω

Doc. No. 5SYA 1192-01 Mar. 22

- High forward and surge current rating
- Low on-state and switching losses
- Optimum power handling capability
- High case non-rupture current

Blocking

Maximum rated values ¹⁾

Parameter	Symbol	Conditions	Value	Unit
Max repetitive peak reverse voltage	V_{RRM}	$f = 50$ Hz, $t_p = 10$ ms, $T_{vj} = 0 \dots 160$ °C, Note 1	6500	V
Max non-repetitive peak reverse voltage	V_{RSM}	$f = 5$ Hz, $t_p = 10$ ms, $T_{vj} = 0 \dots 160$ °C, Note 1	6500	V

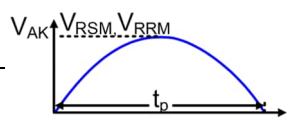

Characteristic values

Parameter	Symbol	Conditions	min	typ	max	Unit
Reverse leakage current	I_{RRM}	V_{RRM} , $T_{vj} = 0 \dots 160$ °C			400	mA

Note 1: Voltage derating factor of 0.11% per °C is applicable for T_{vj} below 0 °C.

Mechanical data

Maximum rated values ¹⁾

Parameter	Symbol	Conditions	min	typ	max	Unit
Mounting force	F_M		81	90	108	kN
Acceleration	a	Device unclamped			50	m/s ²
Acceleration	a	Device clamped			100	m/s ²

Characteristic values

Parameter	Symbol	Conditions	min	typ	max	Unit
Weight	m				3.1	kg
Housing thickness	H	$F_M = 90$ kN, $T_a = 25$ °C	35.2		35.7	mm
Surface creepage distance	D_S		56			mm
Air strike distance	D_a		22			mm

1) Maximum rated values indicate limits beyond which damage to the device may occur

On-state

Maximum rated values ¹⁾

Parameter	Symbol	Conditions	min	typ	max	Unit
Average on-state current	$I_{F(AV)M}$	Half sine wave, $T_c = 90^\circ\text{C}$			5850	A
RMS on-state current	$I_{F(RMS)}$				9200	A
Peak case non-rupture current	I_{RSMC}	$t_p = 10\text{ ms}$, $T_{vj} = 25\text{ }^\circ\text{C}$, sine half wave			$95.0 \cdot 10^3$	A
Peak non-repetitive surge current	I_{FSM}	$t_p = 10\text{ ms}$, $T_{vj} = 160\text{ }^\circ\text{C}$, sine half wave,			$110 \cdot 10^3$	A
Limiting load integral	I^2t	$V_R = 0\text{ V}$, after surge			$60.5 \cdot 10^6$	A^2s

Characteristic values

Parameter	Symbol	Conditions	min	typ	max	Unit
On-state voltage	V_F	$I_F = 5000\text{ A}$, $T_{vj} = 160\text{ }^\circ\text{C}$		1.28	1.33	V
Threshold voltage	V_{F0}	$I_F = 2500 \dots 8000\text{ A}$, $T_{vj} = 160\text{ }^\circ\text{C}$		0.79	0.84	V
Slope resistance	r_F				0.097	0.098

Switching

Characteristic values

Parameter	Symbol	Conditions	min	typ	max	Unit
Reverse recovery charge	Q_{rr}	$di_F/dt = -10\text{ A}/\mu\text{s}$, $V_R = 200\text{ V}$ $I_F = 4000\text{ A}$, $T_{vj} = 160\text{ }^\circ\text{C}$		15000	20000	μAs
Reverse recovery current	I_{RM}				360	450

Thermal

Maximum rated values ¹⁾

Parameter	Symbol	Conditions	min	typ	max	Unit
Operating junction temperature range	T_{vj}		0		160	°C
Storage temperature range	T_{stg}		-40		150	°C

Characteristic values

Parameter	Symbol	Conditions	min	typ	max	Unit
Thermal resistance junction to case	$R_{th(j-c)}$	Double-side cooled $F_m = 81... 108$ kN			4.7	K/kW
	$R_{th(j-c)A}$	Anode-side cooled $F_m = 81... 108$ kN			7.3	K/kW
	$R_{th(j-c)C}$	Cathode-side cooled $F_m = 81... 108$ kN			13.2	K/kW
Thermal resistance case to heatsink	$R_{th(c-h)}$	Double-side cooled $F_m = 81... 108$ kN			1	K/kW
	$R_{th(c-h)}$	Single-side cooled $F_m = 81... 108$ kN			2	K/kW

Analytical function for transient thermal impedance:

$$Z_{th(j-c)}(t) = \sum_{i=1}^n R_i (1 - e^{-t/\tau_i})$$

i	1	2	3	4
R_i (K/kW)	3.042	0.899	0.566	0.193
τ_i (s)	1.018	0.139	0.0165	0.0028

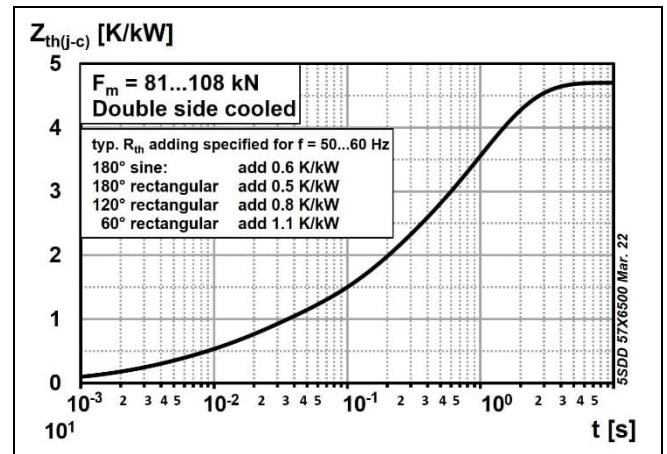

Fig. 1 Transient thermal impedance (junction-to-case) vs. time

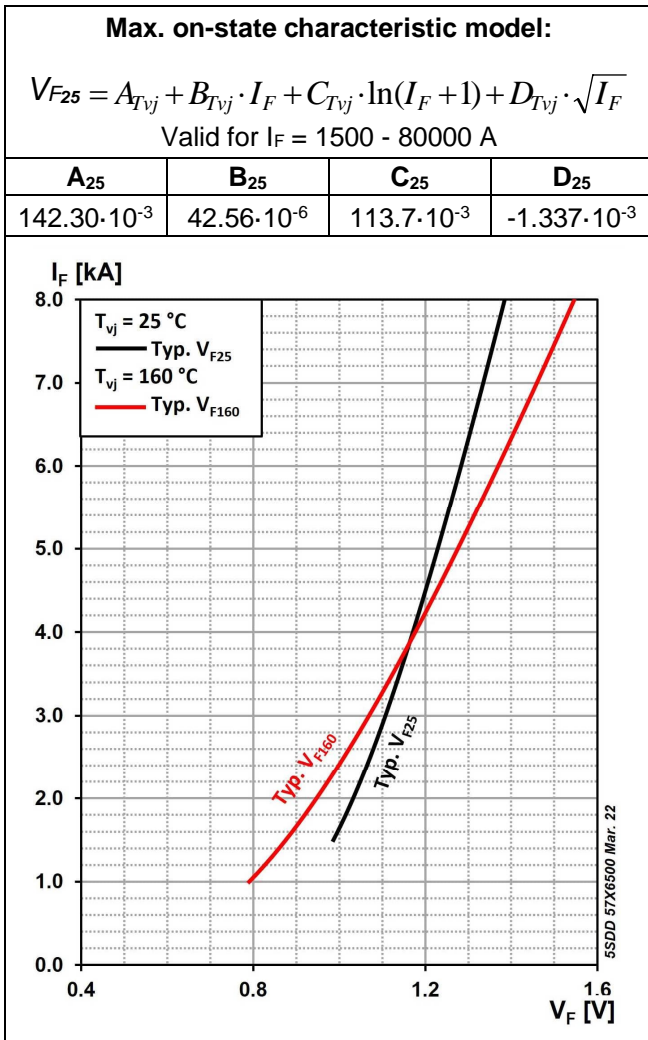

Fig. 2 Typical On-state voltage characteristics

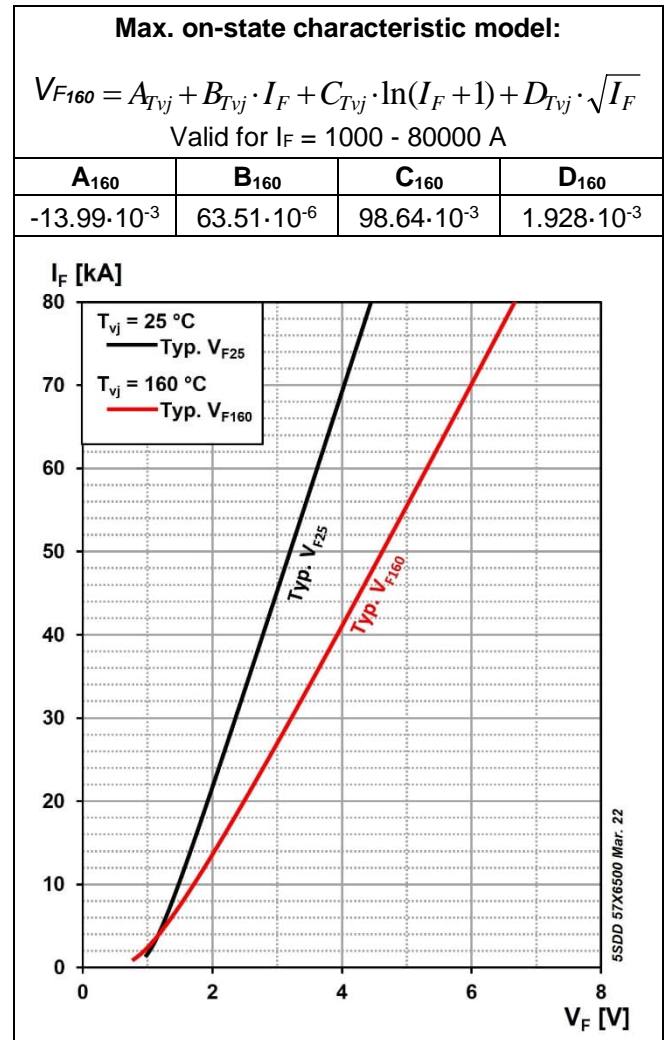

Fig. 3 Typical On-state voltage characteristics

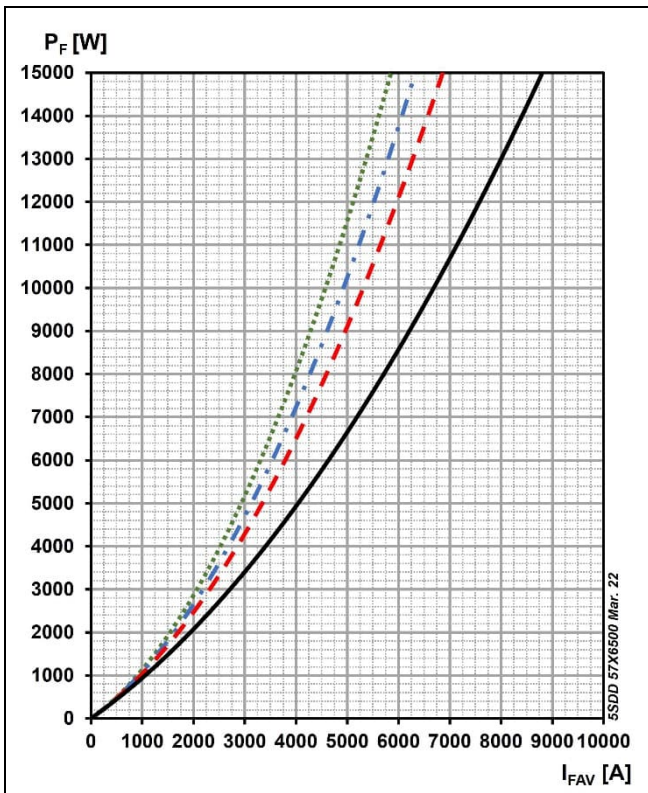

Fig. 4 On-state power dissipation vs. mean on-state current

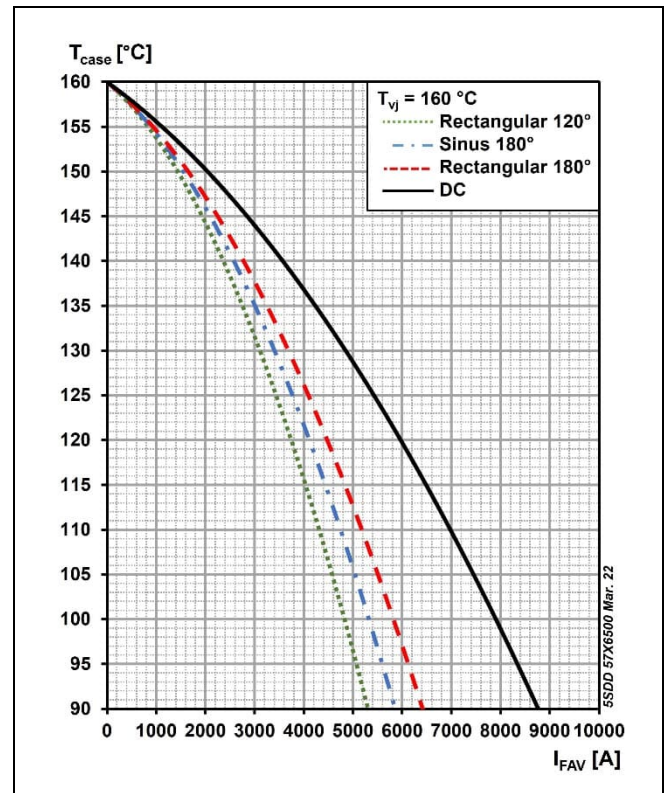

Fig. 5 Max. permissible case temperature vs. mean on-state current

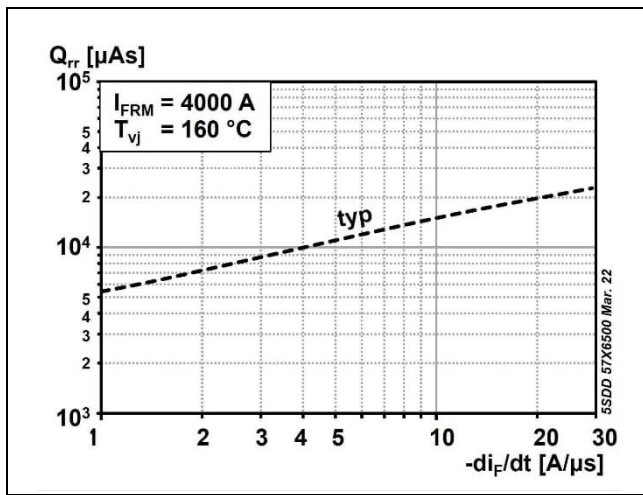

Fig. 6 Typical reverse recovery charge vs. decay rate of on-state current

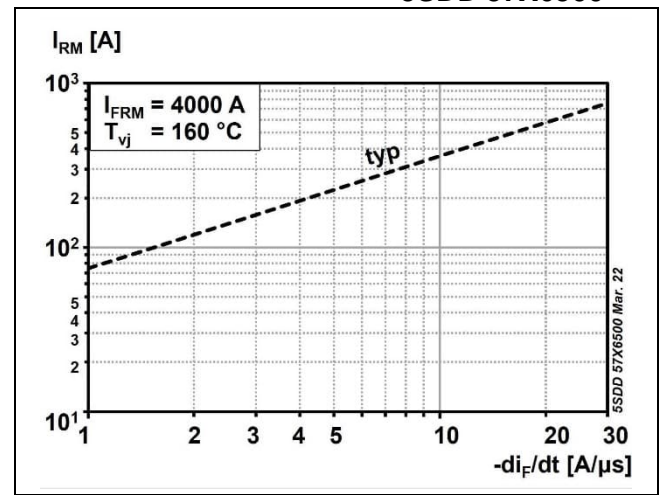

Fig. 7 Typical peak reverse recovery current vs. decay rate of on-state current

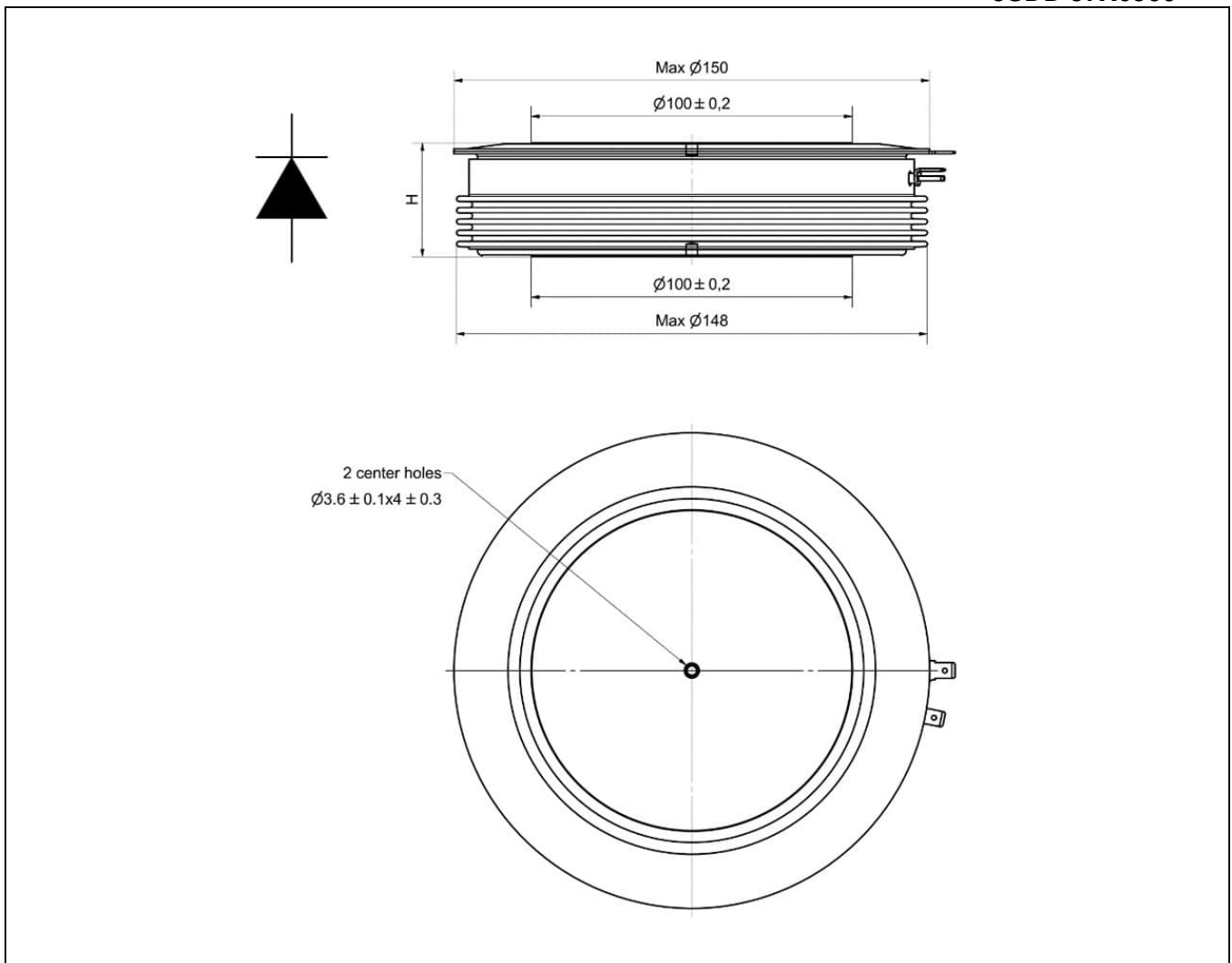

Fig. 8 Device Outline Drawing

Related documents:

5SYA 2020	Design of RC-Snubbers for Phase Control Applications
5SYA 2029	High Power Rectifier Diodes
5SYA 2036	Recommendations regarding mechanical clamping of Press Pack High Power Semiconductors
5SYA 2048	Field Measurements on High Power Press-Pack Semiconductors
5SYA 2051	Voltage Ratings of High Power Semiconductors
5SZK 9118	General Environmental Conditions for High Power Semiconductors

Please refer to <http://www.hitachienergy.com/semiconductors> for current version of documents.

**Hitachi Energy Switzerland Ltd
Semiconductors**
Fabrikstrasse 3
CH-5600 Lenzburg, Switzerland

Telephone +41 (0)58 586 1419
Fax +41 (0)58 586 1306
Internet www.hitachienergy.com/semiconductors