

Product life cycle announcement









Series PRC – Plug-in Relays

Subject: ELIS (legacy GE) Series PRC – Plug-in Relays Life Cycle announcement

Introduction:

In accordance with the ABB global strategy, the Series PRC – Plug-in Relays will enter the **limited phase** of their life cycle on July 1, 2019. These products can be replaced with ABB’s interface relays, which are available through authorized ABB distributors.

Impacted products:

| Legacy Product Line (to be replaced) | Replacement Product Line |
|---|---|
|  <p>PRC4M Plug-in Relays: Miniature square base</p> |  <p>CR-M Plug-in Relays: Miniature</p> |
|  <p>PRC1T Plug-in Relays: Interface relays</p> |  <p>CR-P Plug-in Relays: Standard</p> |
|  <p>PRC2P/PRC3P Plug-in relays: Standard 8/11 pin relays</p> |  <p>CR-U Plug-in Relays: Universal</p> |
|  <p>PRC1S Plug-in Relays: Interface relays</p> |  <p>R600 Boxed Interface relays</p> |

See Appendix A for detailed catalog numbers

ABB CR series plug in relays offer:

- a wide range products and accessories
- logical sockets with protective separation for increased flexibility in installation
- Gold plated contacts for special applications
- An assortment of pluggable functional modules, including modules to protect the system
- Global approvals (UL, CSA, CCC, VDE) and availability

Life Cycle Change Schedule:

| | Classic | Limited | Obsolete |
|----------------------------------|---------------------------|----------------------------|-----------------|
| PRC-Series Plug-in Relays | Current – 06/30/19 | 07/01/19 - 07/01/20 | TBD |

Life Cycle Definitions:

CLASSIC PHASE:

- Product is still available, but not extensively promoted (a substitution product will be identified with cross-reference in most cases)
- No further enhancements or developments
- Customers can take advantages of the complete range of ABB life cycle services, spare parts and maintenance materials
- End users are encouraged to evolve to replacement product

LIMITED PHASE:

- Product is no longer actively promoted
- Service support is ensured, including retrofit kits, spare parts and accessories.
- Product is no longer manufactured or limited production might be available. There are reductions in stock levels and the number of SKUs that are stocked.
- Life extension solutions may be available under a Customer Support Agreement, which provide “Active Phase”-like support from ABB Service team

OBSOLETE PHASE:

- Product is withdrawn from sales
- No longer manufactured as a complete product
- Retrofit kits, where applicable, are available for most applications
- Spare parts availability may diminish over time with decrease in production volumes

Inventory:

Inventory levels will be actively managed to reduce and eliminate the stocking levels and stocked materials.

Pricing:

A price increase of 10% to list price and SPA’s will be applied July 1st, 2019.

During limited and obsolete phase, any exception to price increase must be approved by Pricing Manager and Product Marketing Manager (PMM).

SPA’s will no longer be valid/offered for these products after July 1st, 2020.

General Conversion Support Resources:

- Global Life Cycle Management Page
 - <https://new.abb.com/low-voltage/service/service-for-low-voltage-products/replacements>
- eConfig Tool (product selector)
 - <https://xe-v-lscfe01p.xe.abb.com/global/>
- US Technical Support Contact
 - eppc.support@us.abb.com
- eConfig tool
 - <https://xe-v-lscfe01p.xe.abb.com/global/#/>

Product-Specific Support Resources

- Replacement product website link :
 - <https://new.abb.com/low-voltage/products/electronicrelays/interface-relays-and-optocouplers>
- Product Documentation
 - Interface relays CR-P/CR-M: https://search-ext.abb.com/library/Download.aspx?DocumentID=2CDC110004C0210_05&LanguageCode=en&DocumentPartId=&Action=Launch
 - Selection Guide: https://search-ext.abb.com/library/Download.aspx?DocumentID=2CDC110004C0210_05&LanguageCode=en&DocumentPartId=&Action=Launch
 - R600 Boxed interface relays brochure: https://search-ext.abb.com/library/Download.aspx?DocumentID=2CDC110004C0210_05&LanguageCode=en&DocumentPartId=&Action=Launch
 - CAD drawings: <https://abb-control-products.partcommunity.com/3d-cad-models/?cwid=3665>
- ELIS Control and Automation For industrial applications ED.03 Plug-in relays & Auxiliary contactor: https://www.geindustrial.com/india/brochures/PIR_andAux_Contactors_India.pdf

Product Returns:

During the ABB life cycle phases, the ABB return policy will be enforced. Any requested returns after product obsolescence will only be accepted with approval of ABB District Sales Manager and Product Manager for a grace period of 3 months from date of obsolescence.

Appendix:

Appendix A – Affected Legacy Products

Legacy catalog number construction (EPIS)

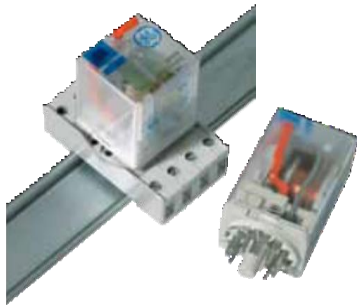

| | | | | | | | | | |
|------------|----------------|--|--|--|--|--|--|--|--|
| PRC | | | | | | | | | L |
| | | | | | | | | | LED |
| | | | | | | | | | Coil voltage |
| | | | | | | | | | A 6 V |
| | | | | | | | | | B 12 V |
| | | | | | | | | | D 24 V |
| | | | | | | | | | G 48 V |
| | | | | | | | | | J 110 V DC/120 V AC |
| | | | | | | | | | N 230 V AC |
| | | | | | | | | | Voltage |
| | | | | | | | | | A AC |
| | | | | | | | | | C DC |
| | | | | | | | | | B AC/DC |
| | | | | | | | | | Special executions |
| | | | | | | | | | D Free wheeling diode (DC only) |
| | | | | | | | | | Contact materials |
| | | | | | | | | | 0 Standard, AgNi |
| | | | | | | | | | 2 Gold plated cont. 5µAu |
| | | | | | | | | | 3 Standard AgSnO ₂ for interface relays |
| | | | | | | | | | No. of contacts |
| | | | | | | | | | 1 |
| | | | | | | | | | 2 |
| | | | | | | | | | 3 |
| | | | | | | | | | 4 |
| | | | | | | | | | Type |
| | | | | | | | | | P Standard pin |
| | | | | | | | | | M Miniature |
| | | | | | | | | | S-T Interface |
| | | | | | | | | | Series |
| | | | | | | | | | 2 Standard 8 pin |
| | | | | | | | | | 3 Standard 11 pin |
| | | | | | | | | | 4 Square base miniature |
| | | | | | | | | | 1 Input/output interface relay |
| PRC | Plug-in relays | | | | | | | | |

Type code construction for replacement products (will need to convert to ABB Ordering Code)

Pluggable Miniature Relays (CR-M)

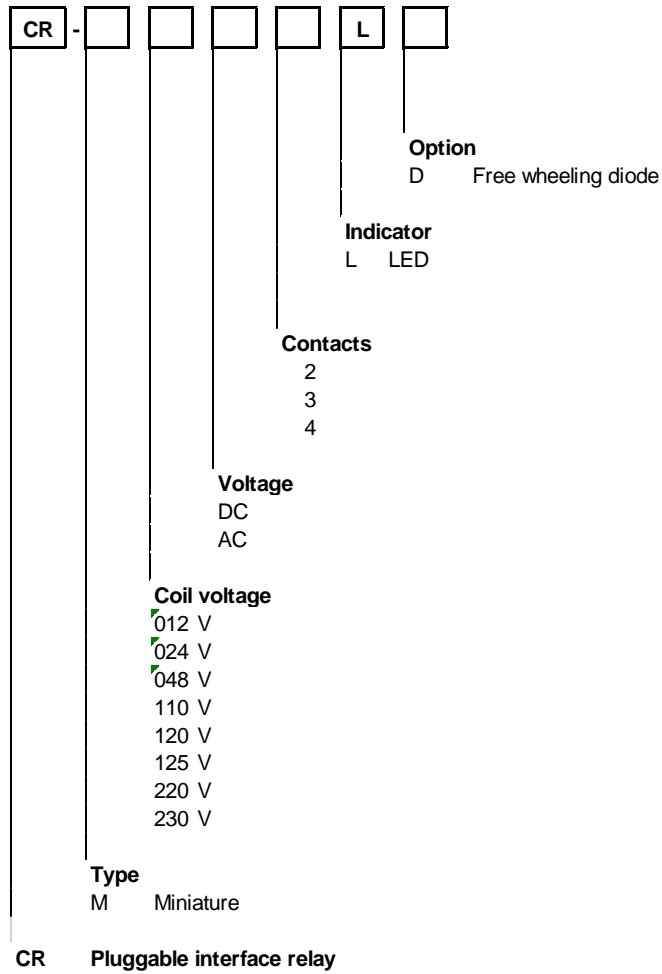

Accessories

| Description | Reference Code |
|--|----------------|
| Standard socket for 2c/o CR-M relay | CR-M2SS |
| Standard socket for 3c/o CR-M relay | CR-M3SS |
| Standard socket, fork type for 2c/o or 4c/o CR-M relay | CR-M4SF |
| Holder for CR-M socket | CR-MH |
| Metal holder for CR-M sockets | CR-MH1 |
| Marker for CR-M socket | CR-MM |

* additional accessories available in complete catalog

Type code construction for replacement products (will need to convert to ABB Ordering Code)

Pluggable Standard Relays (CR-P)

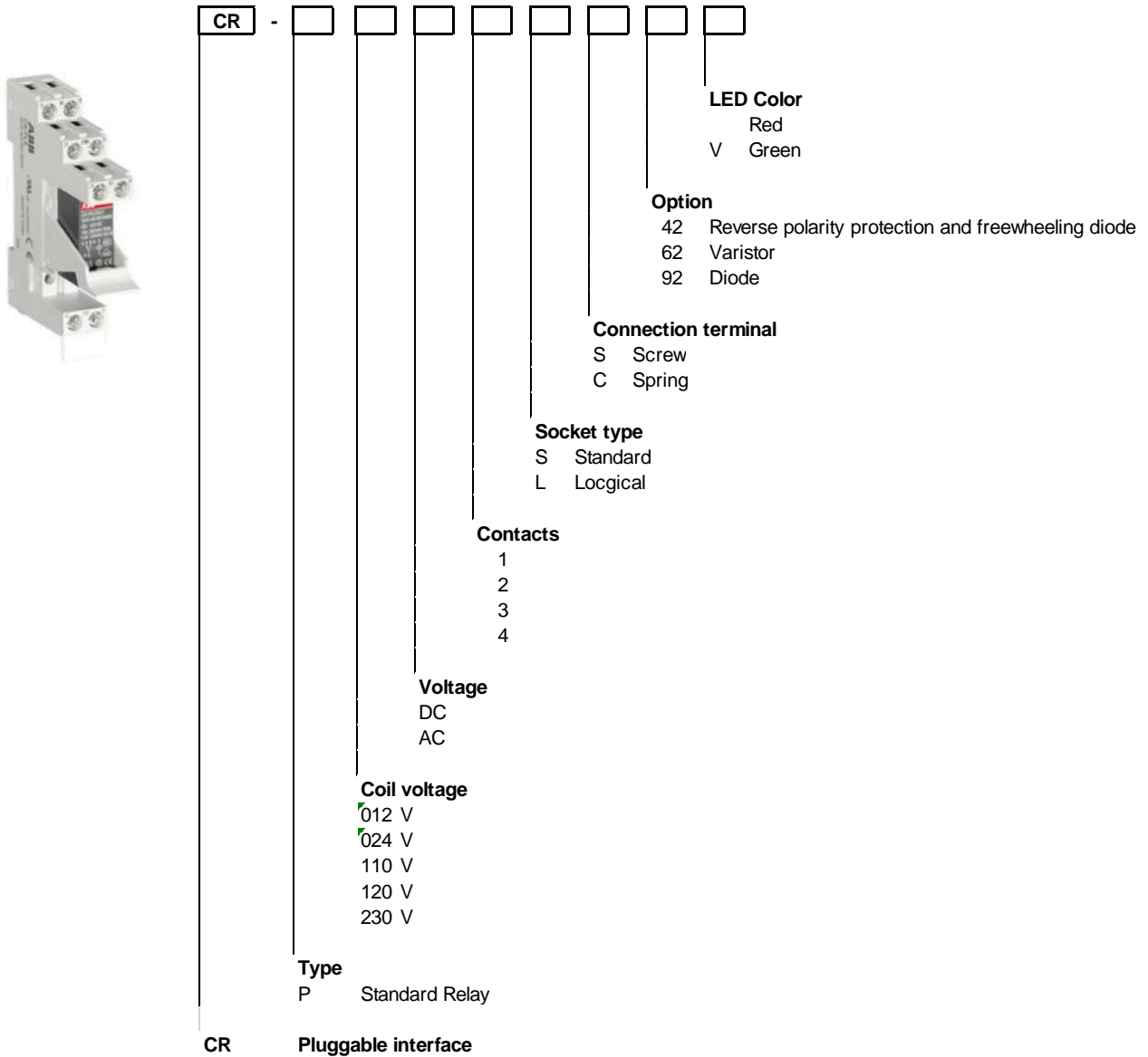

Accessories

| Description | Reference Code |
|---|----------------|
| Holder for CR-P socket | CR-PH |
| Logical socket for 1c/o or 2c/o CR-P relays | CR-PLSX |
| Marker for CR-P socket | CR-PM |

* additional accessories available in complete catalog

Pluggable Standard Functional Modules



| Rated control supply voltage | Description | Version | Type |
|------------------------------|--|------------------------|-------------|
| 6-24 V DC | Diode and LED - Reverse polarity protection/freewheeling diode | red, A1+, A2- | CR-P/M 42 |
| | | green, A1+, A2- | CR-P/M 42V |
| 110-230 V AC/DC | wheeling diode | green, A1+, A2- | CR-P/M 42CV |
| 110-230 V AC/DC | Diode and LED | red, for DC A1+, A2- | CR-P/M 92 |
| 6-24 V AC/DC | Varistor and LED - Over-voltage protection | red, for DC A1+, A2- | CR-P/M 62C |
| | | green, for DC A1+, A2- | CR-P/M 62CV |
| 110-230 V AC/DC | | red, for DC A1+, A2- | CR-P/M 92C |
| | | green, for DC A1+, A2- | CR-P/M 92CV |

Type code construction for replacement products (will need to convert to ABB Ordering Code)

Pluggable Universal Relays (CR-U)

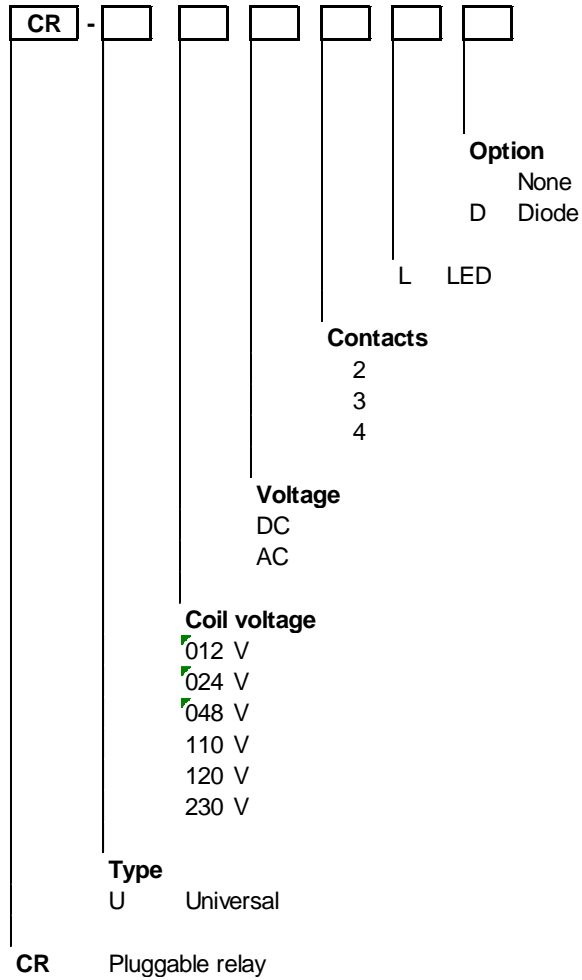

Type code construction for replacement products (will need to convert to ABB Ordering Code)

Boxed relay (R600)

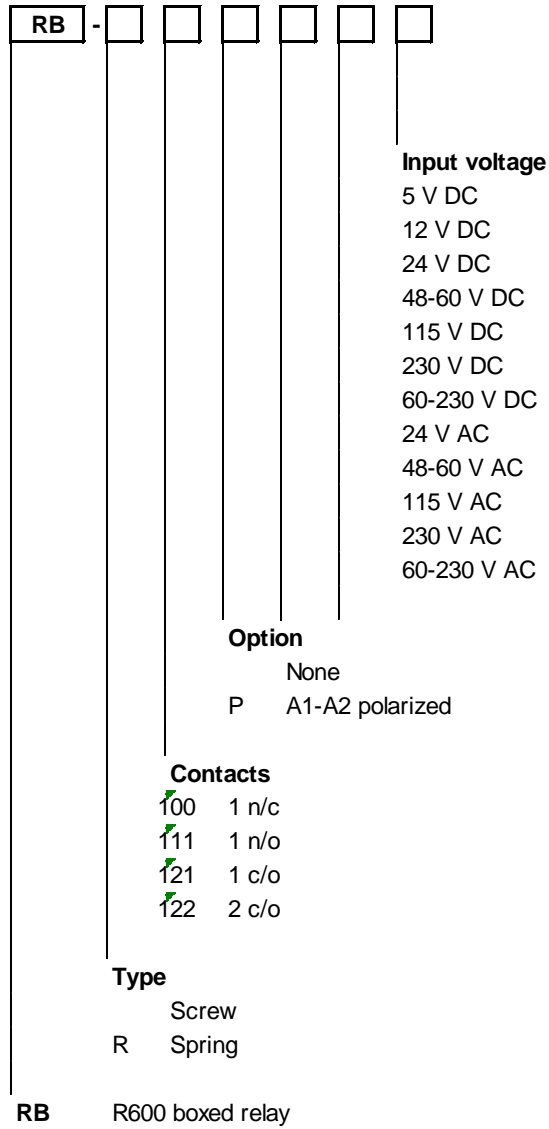



| Catalog No | Series | Type | No. of contacts | Contact material | Ratings AC | Voltage | Coil voltage | LED |
|-------------|-----------------------|-------------------------|-----------------|------------------|------------|---------------|--------------|-----|
| PRC4M20ABL | | | | | | | 12 V | Yes |
| PRC4M20ADL | Square base miniature | Miniature plug-in relay | 2 CO | AgNi | 12 A/250 V | AC (50/60 Hz) | 24 V | Yes |
| PRC4M20AGL | | | | | | | 48 V | Yes |
| PRC4M20AJL | | | | | | | 120 V | Yes |
| PRC4M20ANL | | | | | | | 230 V | Yes |
| PRC4M20CBL | Square base miniature | Miniature plug-in relay | 2 CO | AgNi | 12 A/250 V | DC | 12 V | Yes |
| PRC4M20CDL | | | | | | | 24 V | Yes |
| PRC4M20CGL | | | | | | | 48 V | Yes |
| PRC4M20CJL | | | | | | | 110 V | Yes |
| PRC4M20DCBL | Square base miniature | Miniature plug-in relay | 2 CO | AgNi | 12 A/250 V | DC diode | 12 V | Yes |
| PRC4M20DCDL | | | | | | | 24 V | Yes |
| PRC4M20DCGL | | | | | | | 48 V | Yes |
| PRC4M20DCJL | | | | | | | 110 V | Yes |



| Catalog No | Series | Type | No. of contacts | Contact material | Ratings AC | Voltage | Coil voltage | LED |
|-------------|-----------------------|-------------------------|-----------------|------------------|------------|---------------|--------------|-----|
| PRC4M30ABL | | | | | | | 12 V | Yes |
| PRC4M30ADL | Square base miniature | Miniature plug-in relay | 3 CO | AgNi | 10 A/250 V | AC (50/60 Hz) | 24 V | Yes |
| PRC4M30AGL | | | | | | | 48 V | Yes |
| PRC4M30AJL | | | | | | | 120 V | Yes |
| PRC4M30ANL | | | | | | | 230 V | Yes |
| PRC4M30CBL | Square base miniature | Miniature plug-in relay | 3 CO | AgNi | 10 A/250 V | DC | 12 V | Yes |
| PRC4M30CDL | | | | | | | 24 V | Yes |
| PRC4M30CGL | | | | | | | 48 V | Yes |
| PRC4M30CJL | | | | | | | 110 V | Yes |
| PRC4M30DCBL | Square base miniature | Miniature plug-in relay | 3 CO | AgNi | 10 A/250 V | DC diode | 12 V | Yes |
| PRC4M30DCDL | | | | | | | 24 V | Yes |
| PRC4M30DCGL | | | | | | | 48 V | Yes |
| PRC4M30DCJL | | | | | | | 110 V | Yes |



| Catalog No | Series | Type | No. of contacts | Contact material | Ratings AC | Voltage | Coil voltage | LED |
|-------------|-----------------------|-------------------------|-----------------|------------------|------------|---------------|--------------|-----|
| PRC4M40ABL | | | | | | | 12 V | Yes |
| PRC4M40ADL | Square base miniature | Miniature plug-in relay | 4 CO | AgNi | 6 A/250 V | AC (50/60 Hz) | 24 V | Yes |
| PRC4M40AGL | | | | | | | 48 V | Yes |
| PRC4M40AJL | | | | | | | 120 V | Yes |
| PRC4M40ANL | | | | | | | 230 V | Yes |
| PRC4M40CBL | Square base miniature | Miniature plug-in relay | 4 CO | AgNi | 6 A/250 V | DC | 12 V | Yes |
| PRC4M40CDL | | | | | | | 24 V | Yes |
| PRC4M40CGL | | | | | | | 48 V | Yes |
| PRC4M40CJL | | | | | | | 110 V | Yes |
| PRC4M40DCBL | Square base miniature | Miniature plug-in relay | 4 CO | AgNi | 6 A/250 V | DC diode | 12 V | Yes |
| PRC4M40DCDL | | | | | | | 24 V | Yes |
| PRC4M40DCGL | | | | | | | 48 V | Yes |
| PRC4M40DCJL | | | | | | | 110 V | Yes |

| Catalog No | Series | Type | Description | Material |
|--------------|--------------------------|----------------------------|----------------------|---------------|
| PRCG-ES15/2N | | | socket | |
| PRCG1052 | sockets for PRC4M2..2 CO | Screw terminals two levels | fixing clip | Metal |
| PRCMS35 | | | retainer/extractor | white plastic |
| PRCTR1 | | | identification plate | |
| PRCG-ES15/3N | | | | socket |
| PRCG1052 | sockets for PRC4M3..3 CO | Screw terminals two levels | fixing clip | Metal |
| PRCMS35 | | | retainer/extractor | white plastic |
| PRCTR1 | | | identification plate | |
| PRCG-ES15/3N | | | | socket |
| PRCG1052 | sockets for PRC4M4..4 CO | Screw terminals two levels | fixing clip | Metal |
| PRCMS35 | | | retainer/extractor | white plastic |
| PRCTR1 | | | identification plate | |



| Catalog No | Series | Type | No. of contacts | Contact material | Ratings AC | Voltage | Coil voltage | LED |
|-------------|----------------|--------------|-----------------|------------------|------------|---------------|--------------|-----|
| PRC2P20ABL | | | | | | | | |
| PRC2P20ADL | Standard 8 pin | Standard pin | 2 CO | AgNi | 10 A/250 V | AC (50/60 Hz) | 24 V | Yes |
| PRC2P20AGL | | | | | | | 48 V | Yes |
| PRC2P20AJL | | | | | | | 120 V | Yes |
| PRC2P20ANL | | | | | | | 230 V | Yes |
| PRC2P20CBL | | | | | | | 12 V | Yes |
| PRC2P20CDL | Standard 8 pin | Standard pin | 2 CO | AgNi | 10 A/250 V | DC | 24 V | Yes |
| PRC2P20CGL | | | | | | | 48 V | Yes |
| PRC2P20CJL | | | | | | | 110 V | Yes |
| PRC2P20DCBL | | | | | | | | |
| PRC2P20DCDL | Standard 8 pin | Standard pin | 2 CO | AgNi | 10 A/250 V | DC diode | 24 V | Yes |
| PRC2P20DCGL | | | | | | | 48 V | Yes |
| PRC2P20DCJL | | | | | | | 110 V | Yes |
| PRC2P20DCJL | | | | | | | | |

| Catalog No | Series | Type | No. of contacts | Contact material | Ratings AC | Voltage | Coil voltage | LED |
|-------------|-----------------|--------------|-----------------|------------------|------------|---------------|--------------|-----|
| PRC3P30ABL | | | | | | | 12 V | Yes |
| PRC3P30ADL | Standard 11 pin | Standard pin | 3 CO | AgNi | 10 A/250 V | AC (50/60 Hz) | 24 V | Yes |
| PRC3P30AGL | | | | | | | 48 V | Yes |
| PRC3P30AJL | | | | | | | 120 V | Yes |
| PRC3P30ANL | | | | | | | 230 V | Yes |
| PRC3P30CBL | | | | | | | 12 V | Yes |
| PRC3P30CDL | Standard 11 pin | Standard pin | 3 CO | AgNi | 10 A/250 V | DC | 24 V | Yes |
| PRC3P30CGL | | | | | | | 48 V | Yes |
| PRC3P30CJL | | | | | | | 110 V | Yes |
| PRC3P30DCBL | | | | | | | | |
| PRC3P30DCDL | Standard 11 pin | Standard pin | 3 CO | AgNi | 10 A/250 V | DC diode | 24 V | Yes |
| PRC3P30DCGL | | | | | | | 48 V | Yes |
| PRC3P30DCJL | | | | | | | 110 V | Yes |
| PRC3P30DCJL | | | | | | | | |



| Catalog No | Series | Type | Description |
|------------|---------------------------|---------------------------|-------------|
| PRCZ8 | | screw terminals one level | socket |
| PRCPZ11 | sockets for | | fixing clip |
| PRCG8 | PRC2P20...Standard 8 pin | solder terminal | socket |
| PRCR159 | | | fixing clip |
| PRCZ11 | | screw terminals one level | socket |
| PR4CPZ11 | sockets for | | fixing clip |
| PRCG11 | PRC3P30...Standard 11 pin | solder terminal | socket |
| PRCR159 | | | fixing clip |



| Catalog No | Series | Type | No. of contacts | Contact material | Ratings AC | Voltage | Coil voltage | LED |
|------------|-----------------|----------------------|-----------------|--------------------|------------|---------|--------------|-----|
| PRC1S13BNL | | Interface | 1 single pole | AgSnO ₂ | 6 A/250 V | AC/DC | 230 V | Yes |
| PRC1S13ANL | | Interface | 1 CO | AgSnO ₂ | 6 A/250 V | AC/DC | 230 V | Yes |
| PRC1S13CBL | Interface relay | Interface | 1 CO | AgSnO ₂ | 6 A/250 V | DC | 12 V | Yes |
| PRC1S13CDL | | Interface | 1 CO | AgSnO ₂ | 6 A/250 V | DC | 24 V | Yes |
| PRC1S13BDL | | Interface | 1 CO | AgSnO ₂ | 6 A/250 V | AC/DC | 24 V | Yes |
| PRCTR1S | | Identification label | 1 CO | --- | --- | --- | --- | --- |
| PRCW20 | | 20-way jumper link | 1 CO | --- | --- | --- | --- | --- |

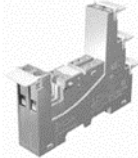

| Catalog No | Series | Type | No. of contacts | Contact material | Ratings AC | Ratings DC | Voltage | Coil voltage | LED |
|------------|-------------------------|-----------|-----------------|------------------|------------|------------|---------|--------------|-----|
| PRC1T10ADL | Interface relay for PLC | Interface | 1 CO | AgNi | 16 A/250 V | 16 A/24 V | AC | 24 V | Yes |
| PRC1T10AJL | | | | | | | | 120 V | Yes |
| PRC1T10ANL | | | | | | | | 230 V | Yes |
| PRC1T10CBL | Interface relay for PLC | Interface | | | | | DC | 12 V | Yes |
| PRC1T10CDL | | | | | | | | 24 V | Yes |
| PRC1T10CJL | | | | | | | | 110 V | Yes |
| PRC1T20ADL | Interface relay for PLC | Interface | 2 CO | AgNi | 8 A/250 V | 8 A/24 V | AC | 24 V | Yes |
| PRC1T20AJL | | | | | | | | 120 V | Yes |
| PRC1T20ANL | | | | | | | | 230 V | Yes |
| PRC1T20CBL | | | | | | | | 12 V | Yes |
| PRC1T20CDL | | | | | | | | 24 V | Yes |
| PRC1T20CJL | | | | | | | | 110 V | Yes |

| Catalog No | Description | Series | Type | No. of contacts | Voltage | Coil voltage | |
|------------|-------------|---------------------------------|--------------------------------|-----------------|---------|---|-------|
| PRCT1AD | Spare parts | | | | | 24 V | |
| PRCT1AJ | Spare parts | | | | AC | 120 V | |
| PRCT1AN | Spare parts | Miniature P.C.B. relays. 16A | | | 1 CO | 230 V | |
| PRCT1CB | Spare parts | | | | | 12 V | |
| PRCT1CD | Spare parts | | | | | 24 V | |
| PRCT1CJ | Spare parts | | | | 110 V | | |
| PRCT2AD | Spare parts | | | | | AC | 24 V |
| PRCT2AJ | Spare parts | | Miniature P.C.B. relays. 8A | | | 2 CO | 120 V |
| PRCT2AN | Spare parts | | | | 230 V | | |
| PRCT2CB | Spare parts | | | | 12 V | | |
| PRCT2CD | Spare parts | | | | 24 V | | |
| PRCT2CJ | Spare parts | | | | 110 V | | |
| PRCGZT80 | Spare parts | | | | | | |
| PRCMS16 | Spare parts | Socket for miniature PCB relays | | | | | |
| PRCTR | Spare parts | | | | | three level screws retainer/retractor plate | |



| Catalog No | Description | Series | Type | For use with sockets: | Direction | Voltage | LED Color |
|------------|---------------------|------------------|--|--------------------------------|------------|----------------|-----------|
| PRCM21P | Modules for sockets | Diode | Protection against polarity | PRCG-ES15/2N, 3N, 4N | +A2 to -A1 | 6 / 230V DC | |
| PRCM21N | | | | | A2 to +A1 | | |
| PRCM31R | Modules for sockets | Diode and LED | Protection against polarity inversion coil energizing indication | PRCG-ES15/2N, 3N, 4N, PRCGZT80 | +A2 to -A1 | | Red |
| PRCM31G | | | | | +A2 to -A1 | | Green |
| PRCM32R | | | | | +A2 to -A1 | | Red |
| PRCM32G | | | | | +A2 to -A1 | | Green |
| PRCM33R | | | | | +A2 to -A1 | | Red |
| PRCM33G | | | | | +A2 to -A1 | | Green |
| PRCM41R | | | | | -A2 to +A1 | | Red |
| PRCM41G | | | | | -A2 to +A1 | | Green |
| PRCM42R | | | | | -A2 to +A1 | | Red |
| PRCM42G | | | | | -A2 to +A1 | | Green |
| PRCM43R | -A2 to +A1 | Red | | | | | |
| PRCM43G | -A2 to +A1 | Green | | | | | |
| PRCM51 | Modules for sockets | RC group | Arc suppression circuit | PRCG-ES15/2N, 3N, 4N | | 6 / 24V AC | |
| PRCM52 | | | | | | 24 / 60 V AC | |
| PRCM53 | | | | | | 110 / 240 V AC | |
| PRCM91R | Modules for sockets | LED and varistor | No protection against polarity coil energizing indication, AC/DC voltage allowed | PRCG-ES15/2N, 3N, 4N, PRCGZT80 | | 6 / 24V AC | Red |
| PRCM91G | | | | | | | Green |
| PRCM93G | | | | | | 110 / 230 V AC | Green |
| PRCM71 | Modules for sockets | Varistor group | No indication, protection against over-voltage | PRCG-ES15/2N, 3N, 4N | | 24 V AC | |
| PRCM73 | | | | | | 230 V AC | |

NOTE: Replacements are not an exact match and for reference only. Please confirm dimensions, rating, and other application requirements with the customer

| EPIS Catalog Number | ELSP Ordering Code | ELSP type | ELSP description |
|---------------------|--------------------|------------------|---|
| *PRCPZ11 | 1SVR405669R0000 | CR-UH | CR-UH Holder for CR-U socket |
| *PRC1C13CDL-C | 1SNA645071R0000 | RB121-24VDC | RB121-24VDC Interface relay R600 1c/o,A1-A2=24VDC,250V/10mA-6A |
| PRC1S13BDL | 1SNA645005R0700 | RB121G-24VUC | RB121G-24VUC Interface relay R600 1c/o,A1-A2=24VAC/DC,250V/3mA-6A |
| PRC1S13BNL | 1SNA645017R2200 | RB111-230VUC | RB111-230VUC Interface relay R600 1n/o,A1-A2=230VAC/DC,250V/10mA-6A |
| PRC1S13CBL | 1SNA645075R0000 | RB121G-12VDC | RB121G-12VDC Interface relay R600 1c/o,A1-A2=12VDC,250V/3mA-6A |
| PRC1S13CDL | 1SNA645072R0000 | RB121G-24VDC | RB121G-24VDC Interface relay R600 1c/o,A1-A2=24VDC,250V/3mA-6A |
| PRC1T10ADL | 1SVR405600R0010 | CR-P024AC1SS62CV | CR-P024AC1SS62CV Interface relay cpl. |
| PRC1T10AJL | 1SVR405600R2010 | CR-P120AC1SS92CV | CR-P120AC1SS92CV Interface relay cpl. |
| PRC1T10ANL | 1SVR405600R3110 | CR-P230AC1SS92CV | CR-P230AC1SS92CV Interface relay, cpl. |
| PRC1T10CBL | 1SVR405600R4010 | CR-P012DC1SS42V | CR-P012DC1SS42V Interface relay cpl. |
| PRC1T10CDL | 1SVR405600R1010 | CR-P024DC1SS42V | CR-P024DC1SS42V Interface relay, cpl. |
| PRC1T10CJL | 1SVR405600R8010 | CR-P110DC1SS42CV | CR-P110DC1SS42CV Interface relay cpl. |
| PRC1T20ADL | 1SVR405601R0010 | CR-P024AC2SS62CV | CR-P024AC2SS62CV Interface relay cpl. |
| PRC1T20AJL | 1SVR405601R2010 | CR-P120AC2SS92CV | CR-P120AC2SS92CV Interface relay cpl. |
| PRC1T20ANL | 1SVR405601R3010 | CR-P230AC2SS92CV | CR-P230AC2SS92CV Interface relay, cpl. |
| PRC1T20CBL | 1SVR405601R4010 | CR-P012DC2SS42V | CR-P012DC2SS42V Interface relay cpl. |
| PRC1T20CDL | 1SVR405601R1010 | CR-P024DC2SS42V | CR-P024DC2SS42V Interface relay, cpl. |
| PRC1T20CJL | 1SVR405601R8010 | CR-P110DC2SS42CV | CR-P110DC2SS42CV Interface relay cpl. |
| PRC2P20ADL | | | |
| PRC2P20AGL | 1SVR405621R5100 | CR-U048AC2L | CR-U048AC2L Pluggable interface relay 2c/o, A1-A2=48VAC, 250V/10A, LED |
| PRC2P20AJL | 1SVR405621R2100 | CR-U120AC2L | CR-U120AC2L Pluggable interface relay 2c/o, A1-A2=120VAC, 250V/10A, LED |
| PRC2P20ANL | 1SVR405621R3100 | CR-U230AC2L | CR-U230AC2L Pluggable interface relay 2c/o, A1-A2=230VAC, 250V/10A, LED |
| PRC2P20CBL | 1SVR405621R4100 | CR-U012DC2L | CR-U012DC2L Pluggable interface relay 2c/o, A1-A2=12VDC, 250V/10A, LED |
| PRC2P20CDL | 1SVR405621R1100 | CR-U024DC2L | CR-U024DC2L Pluggable interface relay 2c/o, A1-A2=24VDC, 250V/10A, LED |
| PRC2P20CGL | 1SVR405621R6100 | CR-U048DC2L | CR-U048DC2L Pluggable interface relay 2c/o, A1-A2=48VDC, 250V/10A, LED |
| PRC2P20CJL | 1SVR405621R8100 | CR-U110DC2L | CR-U110DC2L Pluggable interface relay 2c/o, A1-A2=110VDC, 250V/10A, LED |
| PRC2P20DCBL | 1SVR405621R4400 | CR-U012DC2LD | CR-U012DC2LD Pluggable interface relay |
| PRC2P20DCDL | 1SVR405621R1400 | CR-U024DC2LD | CR-U024DC2LD Pluggable interface relay |
| PRC2P20DCGL | 1SVR405621R6400 | CR-U048DC2LD | CR-U048DC2LD Pluggable interface relay |
| PRC2P20DCJL | 1SVR405621R8400 | CR-U110DC2LD | CR-U110DC2LD Pluggable interface relay |
| PRC3P30ADL | 1SVR405622R0100 | CR-U024AC3L | CR-U024AC3L Pluggable interface relay 3c/o, A1-A2=24VAC, 250V/10A, LED |
| PRC3P30AGL | 1SVR405622R5100 | CR-U048AC3L | CR-U048AC3L Pluggable interface relay 3c/o, A1-A2=48VAC, 250V/10A, LED |
| PRC3P30AJL | 1SVR405622R2100 | CR-U120AC3L | CR-U120AC3L Pluggable interface relay 3c/o, A1-A2=120VAC, 250V/10A, LED |
| PRC3P30ANL | 1SVR405622R3100 | CR-U230AC3L | CR-U230AC3L Pluggable interface relay 3c/o, A1-A2=230VAC, 250V/10A, LED |
| PRC3P30CBL | 1SVR405622R4100 | CR-U012DC3L | CR-U012DC3L Pluggable interface relay 3c/o, A1-A2=12VDC, 250V/10A, LED |
| PRC3P30CDL | 1SVR405622R1100 | CR-U024DC3L | CR-U024DC3L Pluggable interface relay 3c/o, A1-A2=24VDC, 250V/10A, LED |
| PRC3P30CGL | 1SVR405622R6100 | CR-U048DC3L | CR-U048DC3L Pluggable interface relay 3c/o, A1-A2=48VDC, 250V/10A, LED |
| PRC3P30CJL | 1SVR405622R8100 | CR-U110DC3L | CR-U110DC3L Pluggable interface relay 3c/o, A1-A2=110VDC, 250V/10A, LED |
| PRC3P30CNL | 1SVR405622R9100 | CR-U220DC3L | CR-U220DC3L Pluggable interface relay 3c/o, A1-A2=220VDC, 250V/10A, LED |
| PRC3P30DCBL | 1SVR405622R4400 | CR-U012DC3LD | CR-U012DC3LD Pluggable interface relay |
| PRC3P30DCDL | 1SVR405623R1100 | CR-U024DC3LD | CR-U024DC3LD Pluggable interface relay 3c/o, A1-A2=24 VDC, 250V/10A, LED, diode |
| PRC3P30DCGL | 1SVR405622R6400 | CR-U048DC3LD | CR-U048DC3LD Pluggable interface relay |
| PRC3P30DCJL | 1SVR405622R8400 | CR-U110DC3LD | CR-U110DC3LD Pluggable interface relay |
| PRC4M20ADL | 1SVR405611R0100 | CR-M024AC2L | CR-M024AC2L Pluggable interface relay 2c/o, A1-A2=24VAC, 250V/12A, LED |
| PRC4M20AGL | 1SVR405611R5100 | CR-M048AC2L | CR-M048AC2L Pluggable interface relay 2c/o, A1-A2=48VAC, 250V/12A, LED |
| PRC4M20AJL | 1SVR405611R2100 | CR-M120AC2L | CR-M120AC2L Pluggable interface relay 2c/o, A1-A2=120VAC, 250V/12A, LED |
| PRC4M20ANL | 1SVR405611R3100 | CR-M230AC2L | CR-M230AC2L Pluggable interface relay 2c/o, A1-A2=230VAC, 250V/12A, LED |
| PRC4M20CBL | 1SVR405611R4100 | CR-M012DC2L | CR-M012DC2L Pluggable interface relay 2c/o, A1-A2=12VDC, 250V/12A, LED |
| PRC4M20CDL | 1SVR405611R1100 | CR-M024DC2L | CR-M024DC2L Pluggable interface relay 2c/o, A1-A2=24VDC, 250V/12A, LED |
| PRC4M20CGL | 1SVR405611R6100 | CR-M048DC2L | CR-M048DC2L Pluggable interface relay 2c/o, A1-A2=48VDC, 250V/12A, LED |
| PRC4M20CJ | 1SVR405611R8100 | CR-M110DC2L | CR-M110DC2L Pluggable interface relay 2c/o, A1-A2=110VDC, 250V/12A, LED |
| PRC4M20CKL | 1SVR405611R8300 | CR-M125DC2L | CR-M125DC2L Pluggable interface relay 2c/o, A1-A2=125VDC, 250V/12A, LED |

NOTE: Replacements are not an exact match and for reference only. Please confirm dimensions, rating, and other application requirements with the customer

| EPIS Catalog Number | ELSP Ordering Code | ELSP type | ELSP description |
|---------------------|--------------------|--------------|--|
| PRC4M20CML | 1SVR405611R9100 | CR-M220DC2L | CR-M220DC2L Pluggable interface relay 2c/o, A1-A2=220VDC, 250V/12A, LED |
| PRC4M20DCBL | 1SVR405611R4400 | CR-M012DC2LD | CR-M012DC2LD Pluggable interface relay |
| PRC4M20DCDL | 1SVR405611R1400 | CR-M024DC2LD | CR-M024DC2LD Pluggable interface relay |
| PRC4M20DCGL | 1SVR405611R6400 | CR-M048DC2LD | CR-M048DC2LD Pluggable interface relay |
| PRC4M20DCJL | 1SVR405611R8400 | CR-M110DC2LD | CR-M110DC2LD Pluggable interface relay |
| PRC4M20DCKL | 1SVR405611R8500 | CR-M125DC2LD | CR-M125DC2LD Pluggable interface relay |
| PRC4M20DCML | 1SVR405611R9400 | CR-M220DC2LD | CR-M220DC2LD Pluggable interface relay |
| PRC4M30ADL | 1SVR405612R0100 | CR-M024AC3L | CR-M024AC3L Pluggable interface relay 3c/o, A1-A2=24VAC, 250V/10A, LED |
| PRC4M30AGL | 1SVR405612R5100 | CR-M048AC3L | CR-M048AC3L Pluggable interface relay 3c/o, A1-A2=48VAC, 250V/10A, LED |
| PRC4M30AJL | 1SVR405612R2100 | CR-M120AC3L | CR-M120AC3L Pluggable interface relay 3c/o, A1-A2=120VAC, 250V/10A, LED |
| PRC4M30ANL | 1SVR405612R3100 | CR-M230AC3L | CR-M230AC3L Pluggable interface relay 3c/o, A1-A2=230VAC, 250V/10A, LED |
| PRC4M30CBL | 1SVR405612R4100 | CR-M012DC3L | CR-M012DC3L Pluggable interface relay 3c/o, A1-A2=12VDC, 250V/10A, LED |
| PRC4M30CDL | 1SVR405612R1100 | CR-M024DC3L | CR-M024DC3L Pluggable interface relay 3c/o, A1-A2=24VDC, 250V/10A, LED |
| PRC4M30CGL | 1SVR405612R6100 | CR-M048DC3L | CR-M048DC3L Pluggable interface relay 3c/o, A1-A2=48VDC, 250V/10A, LED |
| PRC4M30CJL | 1SVR405612R8100 | CR-M110DC3L | CR-M110DC3L Pluggable interface relay 3c/o, A1-A2=110VDC, 250V/10A, LED |
| PRC4M30CKL | 1SVR405612R8300 | CR-M125DC3L | CR-M125DC3L Pluggable interface relay 3c/o, A1-A2=125VDC, 250V/10A, LED |
| PRC4M30CML | 1SVR405612R9100 | CR-M220DC3L | CR-M220DC3L Pluggable interface relay 3c/o, A1-A2=220VDC, 250V/10A, LED |
| PRC4M30DCBL | 1SVR405612R4400 | CR-M012DC3LD | CR-M012DC3LD Pluggable interface relay |
| PRC4M30DCDL | 1SVR405612R1400 | CR-M024DC3LD | CR-M024DC3LD Pluggable interface relay |
| PRC4M30DCGL | 1SVR405612R6400 | CR-M048DC3LD | CR-M048DC3LD Pluggable interface relay |
| PRC4M30DCJL | 1SVR405612R8400 | CR-M110DC3LD | CR-M110DC3LD Pluggable interface relay |
| PRC4M30DCKL | 1SVR405612R8500 | CR-M125DC3LD | CR-M125DC3LD Pluggable interface relay |
| PRC4M30DCML | 1SVR405612R9400 | CR-M220DC3LD | CR-M220DC3LD Pluggable interface relay |
| PRC4M40ADL | 1SVR405613R0100 | CR-M024AC4L | CR-M024AC4L Pluggable interface relay 4c/o, A1-A2=24VAC, 250V/6A, LED |
| PRC4M40AGL | 1SVR405613R5100 | CR-M048AC4L | CR-M048AC4L Pluggable interface relay 4c/o, A1-A2=48VAC, 250V/6A, LED |
| PRC4M40AJL | 1SVR405613R2100 | CR-M120AC4L | CR-M120AC4L Pluggable interface relay 4c/o, A1-A2=120VAC, 250V/6A, LED |
| PRC4M40ANL | 1SVR405613R3100 | CR-M230AC4L | CR-M230AC4L Pluggable interface relay 4c/o, A1-A2=230VAC, 250V/6A, LED |
| PRC4M40CBL | 1SVR405613R4100 | CR-M012DC4L | CR-M012DC4L Pluggable interface relay 4c/o, A1-A2=12VDC, 250V/6A, LED |
| PRC4M40CDL | 1SVR405613R1100 | CR-M024DC4L | CR-M024DC4L Pluggable interface relay 4c/o, A1-A2=24VDC, 250V/6A, LED |
| PRC4M40CGL | 1SVR405613R6100 | CR-M048DC4L | CR-M048DC4L Pluggable interface relay 4c/o, A1-A2=48VDC, 250V/6A, LED |
| PRC4M40CJL | 1SVR405613R8100 | CR-M110DC4L | CR-M110DC4L Pluggable interface relay 4c/o, A1-A2=110VDC, 250V/6A, LED |
| PRC4M40CKL | 1SVR405613R8300 | CR-M125DC4L | CR-M125DC4L Pluggable interface relay 4c/o, A1-A2=125VDC, 250V/6A, LED |
| PRC4M40CML | 1SVR405613R9100 | CR-M220DC4L | CR-M220DC4L Pluggable interface relay 4c/o, A1-A2=220VDC, 250V/6A, LED |
| PRC4M40DCBL | 1SVR405613R4400 | CR-M012DC4LD | CR-M012DC4LD Pluggable interface relay |
| PRC4M40DCDL | 1SVR405614R1100 | CR-M024DC4LD | CR-M024DC4LD Pluggable interface relay 4c/o, A1-A2=24VDC, 250V/6A, diode |
| PRC4M40DCGL | 1SVR405613R6400 | CR-M048DC4LD | CR-M048DC4LD Pluggable interface relay |
| PRC4M40DCJL | 1SVR405613R8400 | CR-M110DC4LD | CR-M110DC4LD Pluggable interface relay |
| PRC4M40DCKL | 1SVR405613R8500 | CR-M125DC4LD | CR-M125DC4LD Pluggable interface relay |
| PRC4M40DCML | 1SVR405613R9400 | CR-M220DC4LD | CR-M220DC4LD Pluggable interface relay |
| PRCG1052 | 1SVR405659R1100 | CR-MH1 | CR-MH1 Metal holder for CR-M sockets |
| PRCG-ES15/2N | 1SVR405651R1000 | CR-M2SS | CR-M2SS Standard socket for 2c/o CR-M relay |
| PRCG-ES15/3N | 1SVR405651R2000 | CR-M3SS | CR-M3SS Standard socket for 3c/o CR-M relay |
| PRCG-ES15/4N | 1SVR405651R3300 | CR-M4SF | CR-M4SF Standard socket, fork type for 2c/o or 4c/o CR-M relay |
| PRCGZ80 | 1SVR405650R0100 | CR-PLSX | CR-PLSX Logical socket for 1c/o or 2c/o CR-P relays |
| PRCM21N | 1SVR405651R0000 | CR-P/M 22 | CR-P/M 22 Pluggable module polarity protection, 6-220VDC,A1+, A2- |
| PRCM21P | 1SVR405651R0000 | CR-P/M 22 | CR-P/M 22 Pluggable module polarity protection, 6-220VDC,A1+, A2- |
| PRCM31G | 1SVR405654R1000 | CR-P/M 62V | CR-P/M 62V Pluggable module LED green, 6-24VAC/DC |
| PRCM31R | 1SVR405654R0000 | CR-P/M 62 | CR-P/M 62 Pluggable module LED red, 6-24VAC/DC |
| PRCM32G | 1SVR405654R4100 | CR-P/M 62EV | CR-P/M 62EV Pluggable module LED green, 24-60VAC/DC |
| PRCM32R | 1SVR405654R4000 | CR-P/M 62E | CR-P/M 62E Pluggable module LED red, 24-60VAC/DC |
| PRCM33G | 1SVR405654R1100 | CR-P/M 92V | CR-P/M 92V Pluggable module LED green, 110-230VAC/110VDC |
| PRCM33R | 1SVR405654R0100 | CR-P/M 92 | CR-P/M 92 Pluggable module LED red, 110-230VAC/110VDC |
| PRCM41G | 1SVR405652R1000 | CR-P/M 42V | CR-P/M 42V Pluggable module diode and LED green, 6-24VDC, A1+, A2- |

NOTE: Replacements are not an exact match and for reference only. Please confirm dimensions, rating, and other application requirements with the customer

| EPIS Catalog Number | ELSP Ordering Code | ELSP type | ELSP description |
|---------------------|--------------------|-------------|--|
| PRCM41R | 1SVR405652R0000 | CR-P/M 42 | CR-P/M 42 Pluggable module diode and LED red, 6-24VDC, A1+, A2- |
| PRCM42G | 1SVR405652R4100 | CR-P/M 42BV | CR-P/M 42BV Pluggable module diode and LED green, 24-60VDC, A1+, A2- |
| PRCM42R | 1SVR405652R4000 | CR-P/M 42B | CR-P/M 42B Pluggable module diode and LED red, 24-60VDC, A1+, A2- |
| PRCM43G | 1SVR405652R9100 | CR-P/M 42CV | CR-P/M 42CV Pluggable module diode and LED green, 110VDC, A1+, A2- |
| PRCM43R | 1SVR405652R9000 | CR-P/M 42C | CR-P/M 42C Pluggable module diode and LED red, 110VDC, A1+, A2- |
| PRCM51 | 1SVR405653R0000 | CR-P/M 52B | CR-P/M 52B Pluggable module RC element 6-24VAC/DC |
| PRCM52 | 1SVR405653R4000 | CR-P/M 52D | CR-P/M 52D Pluggable module RC element 24-60VAC/DC |
| PRCM53 | 1SVR405653R1000 | CR-P/M 52C | CR-P/M 52C Pluggable module RC element 110-230VAC/DC |
| PRCM71 | 1SVR405656R0000 | CR-P/M 72 | CR-P/M 72 Pluggable module varistor, without LED, 24VAC |
| PRCM73 | 1SVR405656R2000 | CR-P/M 82 | CR-P/M 82 Pluggable module varistor, without LED, 230VAC |
| PRCM91G | 1SVR405655R1000 | CR-P/M 62CV | CR-P/M 62CV Pluggable module varistor and LED green, 6-24VAC/DC |
| PRCM91R | 1SVR405655R0000 | CR-P/M 62C | CR-P/M 62C Pluggable module varistor and LED red, 6-24VAC/DC |
| PRCM93G | 1SVR405655R1100 | CR-P/M 92CV | CR-P/M 92CV Pluggable module varistor and LED green, 110-230VAC/110VDC |
| PRCMS16 | 1SVR405659R0000 | CR-PH | CR-PH Holder for CR-P socket |
| PRCMS35 | 1SVR405659R1000 | CR-MH | CR-MH Holder for CR-M socket |
| PRCT1AD | 1SVR405600R0000 | CR-P024AC1 | CR-P024AC1 Pluggable interface relay 1c/o, A1-A2=24VAC, 250V/16A |
| PRCT1AJ | 1SVR405600R2000 | CR-P120AC1 | CR-P120AC1 Pluggable interface relay 1c/o, A1-A2=120VAC, 250V/16A |
| PRCT1AN | 1SVR405600R3000 | CR-P230AC1 | CR-P230AC1 Pluggable interface relay 1c/o, A1-A2=230VAC, 250V/16A |
| PRCT1CB | 1SVR405600R4000 | CR-P012DC1 | CR-P012DC1 Pluggable interface relay 1c/o, A1-A2=12VDC, 250V/16A |
| PRCT1CD | 1SVR405600R1000 | CR-P024DC1 | CR-P024DC1 Pluggable interface relay 1c/o, A1-A2=24VDC, 250V/16A |
| PRCT1CJ | 1SVR405600R8000 | CR-P110DC1 | CR-P110DC1 Pluggable interface relay 1c/o, A1-A2=110VDC, 250V/16A |
| PRCT2AD | 1SVR405601R0000 | CR-P024AC2 | CR-P024AC2 Pluggable interface relay 2c/o, A1-A2=24VAC, 250V/8A |
| PRCT2AJ | 1SVR405601R2000 | CR-P120AC2 | CR-P120AC2 Pluggable interface relay 2c/o, A1-A2=120VAC, 250V/8A |
| PRCT2AN | 1SVR405601R3000 | CR-P230AC2 | CR-P230AC2 Pluggable interface relay 2c/o, A1-A2=230VAC, 250V/8A |
| PRCT2CB | 1SVR405601R4000 | CR-P012DC2 | CR-P012DC2 Pluggable interface relay 2c/o, A1-A2=12VDC, 250V/8A |
| PRCT2CD | 1SVR405601R1000 | CR-P024DC2 | CR-P024DC2 Pluggable interface relay 2c/o, A1-A2=24VDC, 250V/8A |
| PRCT2CJ | 1SVR405601R8000 | CR-P110DC2 | CR-P110DC2 Pluggable interface relay 2c/o, A1-A2=110VDC, 250V/8A |
| PRCTR1 | 1SVR405658R1000 | CR-MM | CR-MM Marker for CR-M socket |
| PRCTR1S | 1SVR405658R0000 | CR-PM | CR-PM Marker for CR-P socket |
| PRCTR2 | 1SVR405658R0000 | CR-PM | CR-PM Marker for CR-P socket |
| *PRCZ11 | 1SVR405660R0000 | CR-U3S | CR-U3S Socket for 3c/o CR-U relay |
| *PRCZ8 | 1SVR405670R0000 | CR-U2S | CR-U2S Socket for 2c/o CR-U relay |