

TECHNICAL DATA SHEET

PMA Accessories - GMM-M - Lock nut

Hexagonal, metric thread

PMA



CE UK
CA

Features & Benefits:

- Maximum possible torque
- Safe system connection

Materials:

- Nickel-plated brass

Compatible with:

- PMAFIX Pro, PMAFIX, PMA Smart Line, PMA Ex-System fittings

Conforms to:

- Metric thread according to EN 60423

Environmental properties:

- Free from halogens and cadmium
- RoHS and REACH compliant

Product selection:

Part no.	Thread size	Dimensions in mm (nom.)			Weight	Packing unit
		h +/- 0.3	e +/- 1.0	SW		
GMM-M12	M12x1.5	2.8	16.5	15.0	0.2	100
GMM-M16	M16x1.5	2.8	21.0	19.0	0.3	100
GMM-M20	M20x1.5	3.0	26.5	24.0	0.5	100
GMM-M25	M25x1.5	3.5	33.0	30.0	0.8	100
GMM-M32	M32x1.5	4.0	39.5	36.0	1.0	25
GMM-M40	M40x1.5	5.0	50.0	46.0	2.4	10
GMM-M50	M50x1.5	5.0	66.0	60.0	4.8	5
GMM-M63	M63x1.5	6.0	77.0	70.0	5.6	5

Our customer service dept. or local distribution partner will be pleased to help you concerning product availability and lead time



ABB Switzerland Ltd,
PMA Cable Protection
Aathalstrasse 90
8610 Uster, Switzerland
Phone: +41 58 585 00 11
pma-info@ch.abb.com
www.pma.ch

Let's write the future.
Together. **abb.com**

We reserve the right to make technical changes or modify the contents of this document without prior notice. With regard to purchase orders, the agreed particulars shall prevail. ABB Installation Products Inc. does not accept any responsibility whatsoever for potential errors or possible lack of information in this document.

We reserve all rights in this document and in the subject matter and illustrations contained therein. Any reproduction, disclosure to third parties or utilization of its contents – in whole or in parts – is forbidden without prior written consent of ABB Inc. Copyright© 2019 ABB Installation Products Inc. All rights reserved

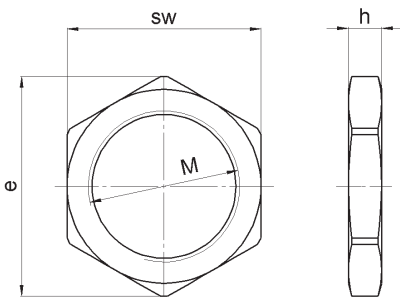