

2TMD042200D0004 | 12.08.2025

Product manual

Busch-Welcome® IP

H82001-W-03 Audio IP

---



1	Notes on the instruction manual .....	4
2	Safety .....	4
3	Intended use.....	4
4	Environment .....	5
4.1	Busch-Jaeger devices.....	5
5	Product description.....	6
5.1	Device type .....	6
5.2	Control elements .....	7
5.3	Terminal description.....	11
6	Technical data .....	12
7	Mounting/Installation .....	13
7.1	Requirement for the electrician .....	13
7.2	Product dimensions.....	14
7.3	Installation height .....	14
7.4	Surface-mounted installation.....	15
8	Commissioning.....	16
8.1	Setting on "Smart Access Point" .....	16
8.1.1	Adding Audio IP via "Smart Access Point" .....	16
8.1.2	Adding Audio IP via App .....	18
8.1.3	Importing a building structure via App .....	20
8.1.4	Accessing the setting screen .....	23
8.1.5	Basic information .....	24
8.1.6	Call button setting.....	25
8.1.7	Unlock button setting.....	27
8.1.8	Light button setting .....	29
8.1.9	Programmed button setting.....	30
8.1.10	Guard unit setting .....	34
8.1.11	Physical address & IP address setting .....	35
8.1.12	Logical address setting .....	39
8.1.13	Ringtone setting.....	40
8.1.14	Renaming the device.....	41
8.1.15	Local Firmware update.....	43
8.1.16	Online firmware update .....	46
8.1.17	Multiple devices setting .....	47
8.1.18	SIP client settings .....	49
8.2	Setting on local device .....	50
8.2.1	Ring volume setting.....	50
8.2.2	Ringtone setting.....	51
8.2.3	Talking volume setting.....	53
8.2.4	Auto unlock setting .....	54
8.2.5	Resetting the device.....	55
9	Operation.....	56

9.1.1	Incoming call .....	56
9.1.2	Intercom .....	57
9.1.3	Unlock .....	58
9.1.4	Turn on a light .....	59
9.1.5	SOS .....	60
10	Cyber security .....	61
10.1	Disclaimer .....	61
10.2	Performance and service .....	62
10.3	Deployment guideline.....	62
10.4	Upgrading .....	63
10.5	Malware prevention solution .....	63
11	Notice .....	64

## 1 Notes on the instruction manual

Please read through this manual carefully and observe the information it contains. This will assist you in preventing injuries and damage to property and ensure both reliable operation and a long service life for the device.

Please keep this manual in a safe place. If you pass the device on, also pass on this manual along with it. Busch-Jaeger accepts no liability for any failure to observe the instructions in this manual.

## 2 Safety



### **Warning**

Electric voltage!

Dangerous currents flow through the body when coming into direct or indirect contact with live components.

This can result in electric shock, burns or even death.

- Disconnect the mains power supply prior to installation and/or disassembly!
- Permit work on the 100-240 V supply system to be performed only by specialist staff!

## 3 Intended use

This device is a part of the Busch-Welcome® IP system and operates exclusively with components from this system. The device must only be installed in dry indoor rooms.

## 4 Environment



### **Consider the protection of the environment!**

Used electric and electronic devices must not be disposed of with household waste.

- The device contains valuable raw materials that can be recycled. Therefore, dispose of the device at the appropriate collecting facility.

### 4.1 Busch-Jaeger devices

All packaging materials and devices from Busch-Jaeger bear the markings and test seals for proper disposal. Always dispose of the packing materials and electric devices and their components via an authorized collection facility or disposal company.

Busch-Jaeger products meet the legal requirements, in particular the laws governing electronic and electrical devices and the REACH ordinance.

(EU-Directive 2012/19/EU WEEE and 2011/65/EU RoHS)

(EU-REACH ordinance and law for the implementation of the ordinance (EG) No.1907/2006)

## 5 Product description

### 5.1 Device type

Article number	Order number	Product name	Colour	Size (DxHxW) Unit: mm
H82001-W-03	2TMA130010W0041	Audio IP, induction loop	White	81 x 198 x 43

5.2 Control elements

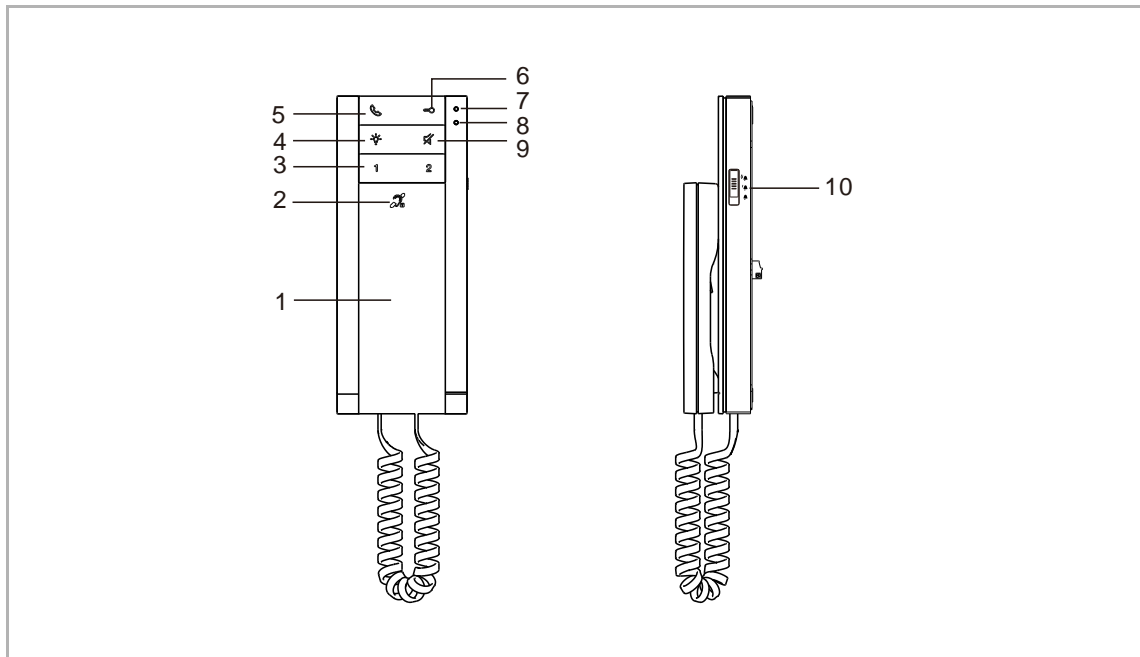



No.	Description
1	<p><b>Handset</b></p> <ul style="list-style-type: none"> <li>▪ During a call request, pick up the handset within 30 seconds to accept the call.</li> <li>▪ During communication, hang up the handset to terminate the call.</li> </ul>
2	<p><b>Induction Loop symbol</b></p> <p>The device is equipped with a hearing loop for coupling the audio signal into hearing aids.</p> <ul style="list-style-type: none"> <li>▪ In order to be able to use such hearing loops, the hearing aid must have a so-called telephone coil (short: "T-coil") that records the magnetic alternating field of the hearing loop.</li> <li>▪ The distance to the device should be a maximum of 80 cm for optimal reception.</li> </ul>
3	<p><b>Programmable button</b></p> <p>The button can be programmed on the "Smart Access Point" for the functions below:</p> <ul style="list-style-type: none"> <li>▪ Intercom to same unit (default)</li> <li>▪ Intercom to another unit</li> <li>▪ Call guard unit</li> <li>▪ Open door with Outdoor station</li> <li>▪ Open door with IP actuator</li> <li>▪ Turn on the designated light</li> <li>▪ SOS function</li> </ul>
4	<p><b>Light button</b></p> <ul style="list-style-type: none"> <li>▪ In standby status, press the button to turn on the designated light.</li> <li>▪ In standby status, hold the button for 5 seconds to set the ringtone type.</li> <li>▪ During communication, hold the button for 5 seconds to set the call volume.</li> </ul>
5	<p><b>Call button</b></p> <ul style="list-style-type: none"> <li>▪ Pick up the handset in standby mode and press the button to communicate with other indoor stations within the same apartment (default setting). In doing so, all existing indoor stations within the apartment will be called simultaneously. In this case, the group call is stopped as soon as one of the indoor stations accepts the call.</li> </ul> <p>The button can be programmed on the "Smart Access Point" to Intercom to another unit or call guard unit.</p>

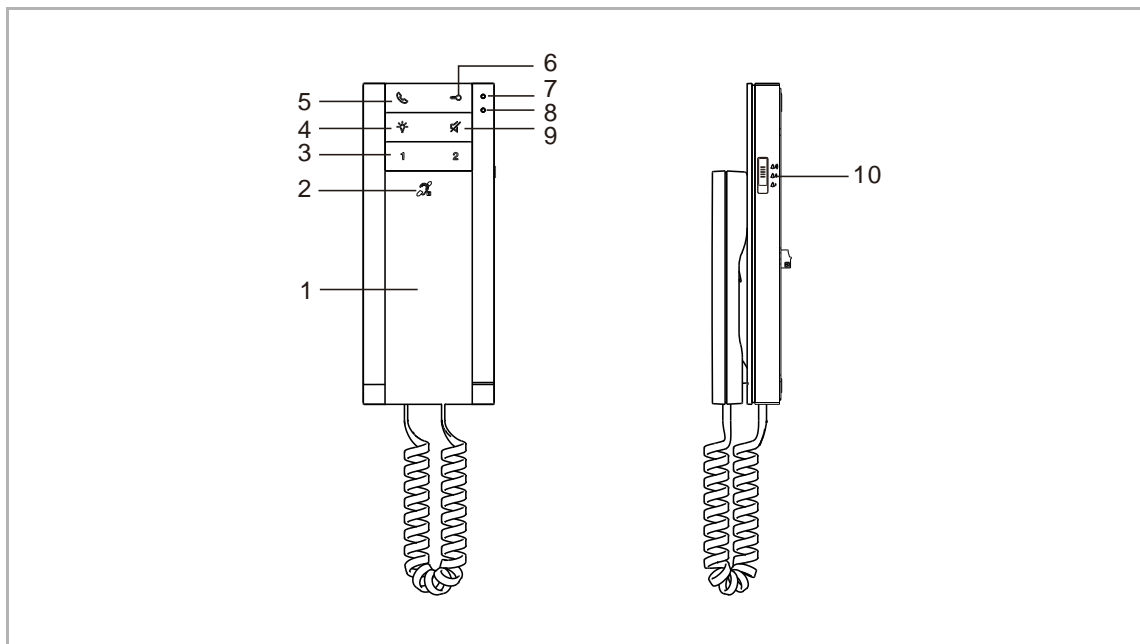











No.	Description
6	<p><b>Unlock button</b></p> <ul style="list-style-type: none"> <li>▪ *In standby status, press the button to release the default lock of the default outdoor station. (A default outdoor station should be set on the "Smart Access Point" before use).</li> <li>▪ In standby status, hold the button for 10 seconds to enable the "Automatic unlock" function. The LED (red) illuminates to indicate that the "Automatic unlock" function is enabled. The same operation will disable the "Automatic unlock" function and the LED (red) will turn off.</li> </ul> <p>* The "Automatic unlock" function means the door will be unlocked automatically during a call request. This function will be disabled automatically after 10 hours.</p>
7	LED (red)
8	LED (blue)
9	<p><b>Mute button</b></p> <ul style="list-style-type: none"> <li>▪ In standby status, press the button to mute the ringtone.</li> <li>▪ In standby status, hold the button for 3 seconds to mute the ringtone for all the indoor stations in the same apartment.</li> <li>▪ During a call request, press the button to mute the ringtone.</li> <li>▪ During communication, press the button to mute the microphone.</li> </ul>
10	<p><b>Volume button</b></p> <p>Adjust the three-level selector (maximum/medium/low) to set the ringtone volume.</p>

### LED Overview

Icon	Description
	Red LED always on
	Blue LED always on
	Red LED flashes slowly
	Blue LED flashes slowly
	Red LED flashes fast
	Blue LED flashes fast

### LED status

LED status	Description
	"Auto-unlock" function is enabled.
	Mute the speaker or the microphone.
	Unsigned status or enters the setting mode.
	During an incoming call.
	Operation failed.
	Operation success.
	IP address conflicts or network connection is not working properly.
	Two LEDs flash alternative, update the firmware.

5.3 Terminal description

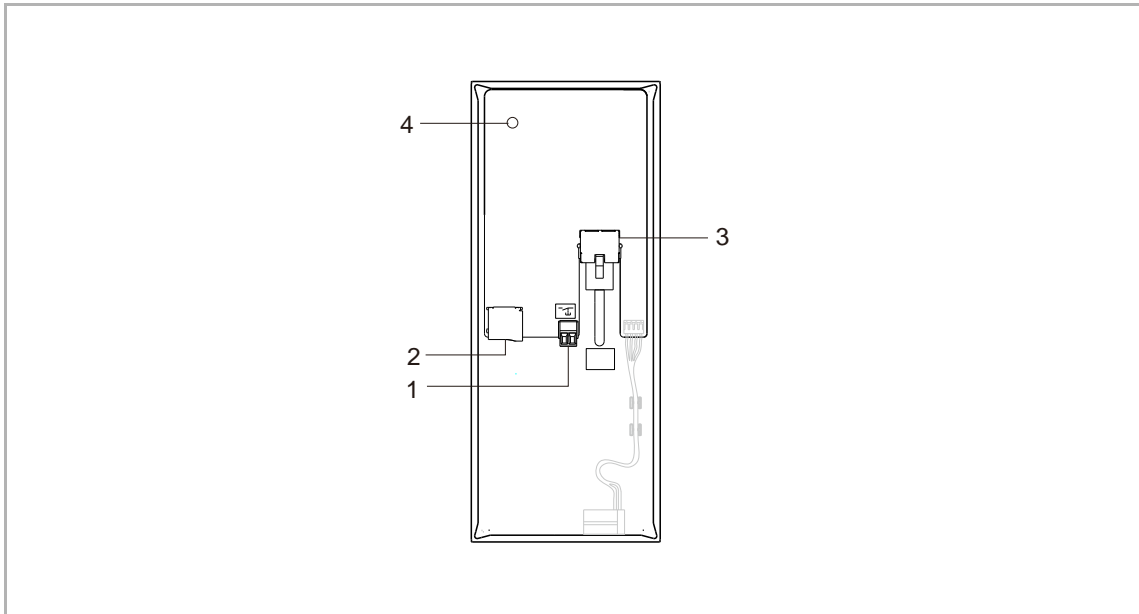

No.	Description
1	A potential-free contact, such as a doorbell
2	Micro SD card slot (only for factory use)
3	LAN (PoE), PoE is the only power supply for this device
4	Reset button

## 6 Technical data

Designation	Value
Rating voltage	48 V $\overline{=}$
Operating voltage	38-57 V $\overline{=}$
Rating current	48 V $\overline{=}$ , 40 mA
Operating temperature	-10 °C...+55 °C
Storage temperature	-25 °C...+70 °C
PoE standard	IEEE802.3 af
IP level	IP 30
Size (DxHxW)	81 x 198 x 43 mm

## 7 Mounting/Installation



### Warning

Electric voltage!

Dangerous currents flow through the body when coming into direct or indirect contact with live components.

This can result in electric shock, burns or even death.

- Disconnect the mains power supply prior to installation and/or disassembly!
- Permit work on the 100-240 V supply system to be performed only by specialist staff!

### 7.1 Requirement for the electrician



### Warning

Electric voltage!

Install the device only if you have the necessary electrical engineering knowledge and experience.

- Incorrect installation endangers your life and that of the user of the electrical system.
- Incorrect installation can cause serious damage to property, e.g. due to fire.

The minimum necessary expert knowledge and requirements for the installation are as follows:

- Apply the "five safety rules" (DIN VDE 0105, EN 50110):
  1. Disconnect
  2. Secure against being re-connected
  3. Ensure there is no voltage
  4. Connect to earth and short-circuit
  5. Cover or barricade adjacent live parts.
- Use suitable personal protective clothing.
- Use only suitable tools and measuring devices.
- Check the type of supply network (TN system, IT system, TT system) to secure the following power supply conditions (classic connection to ground, protective grounding, necessary additional measures, etc.).

### 7.2 Product dimensions

Unit: mm

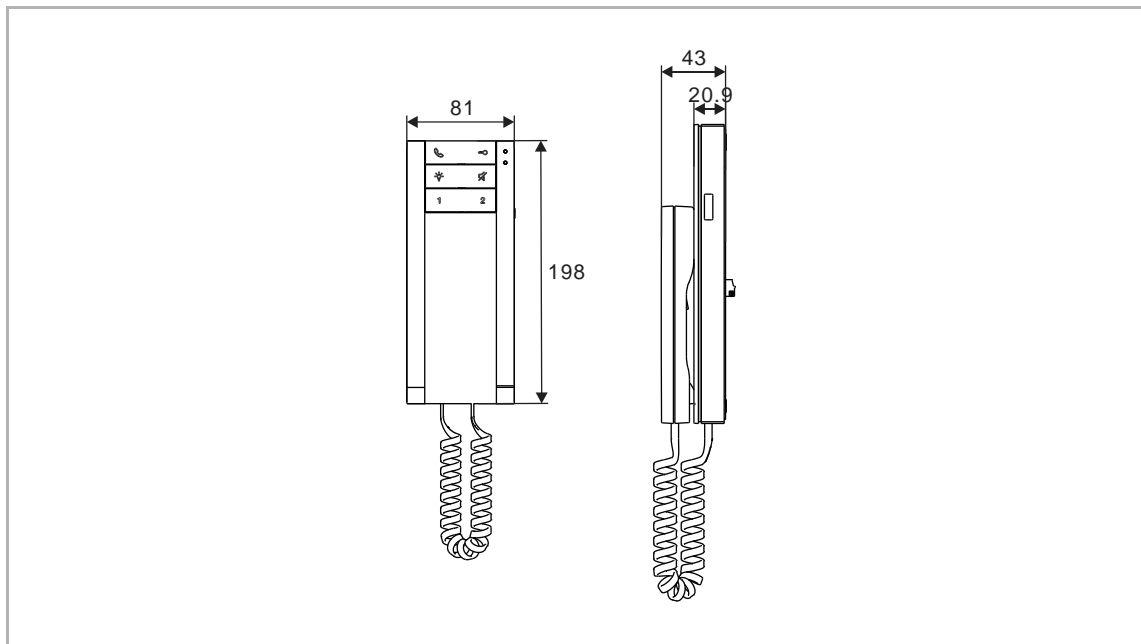

### 7.3 Installation height

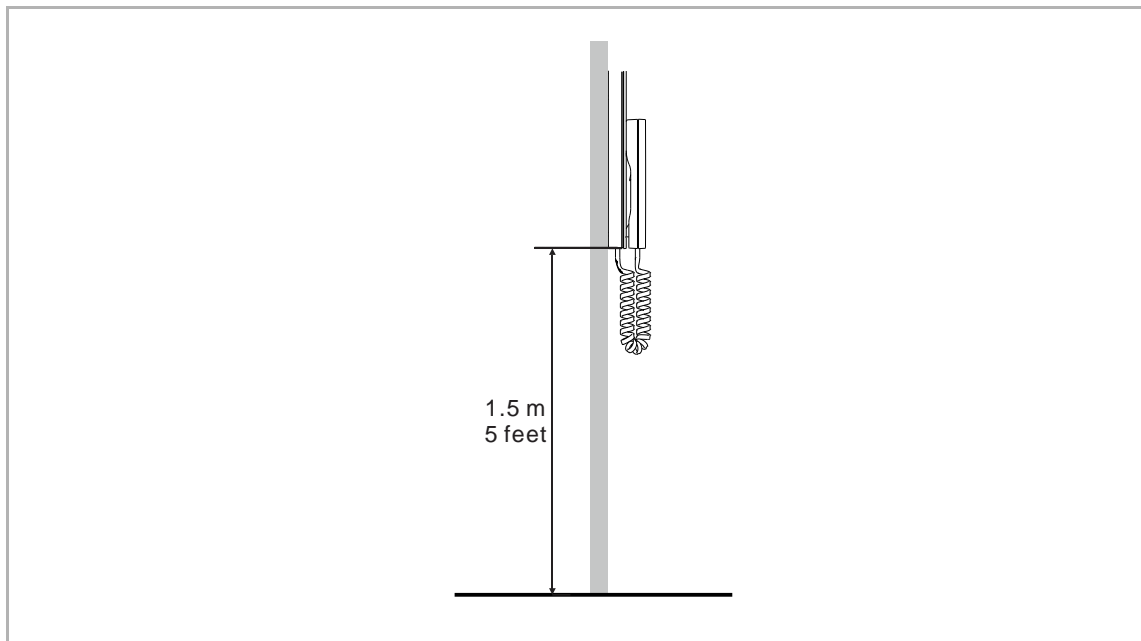

7.4 Surface-mounted installation

Surface-mounted box

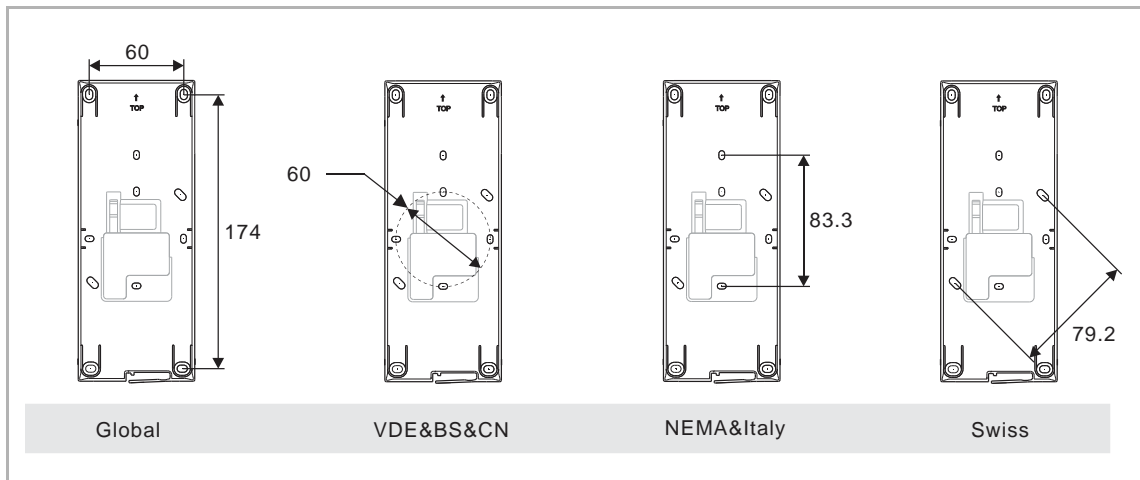

Installation

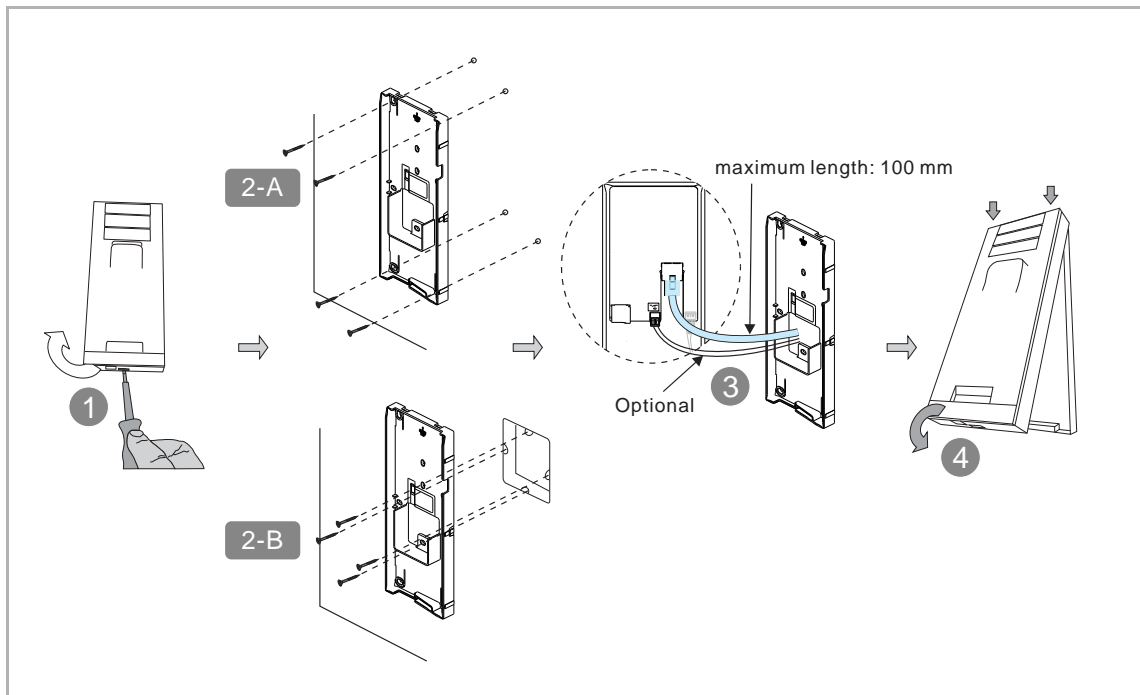

1. Disassemble the upper part from the bottom part by using a screwdriver
- 2-A. Affix the bottom part on the wall
- 2-B. Affix the bottom part on the box
3. Connect the wires.
4. Latch the upper part onto the bottom part.

## 8 Commissioning

### 8.1 Setting on "Smart Access Point"

#### 8.1.1 Adding Audio IP via "Smart Access Point"

##### Precondition

- Audio IP must be powered on.
- Smart Access Point version should be 5.92 or later.
- Audio IP should not be signed by other "Smart Access Point". If Audio IP has been signed by other "Smart Access Point", you need to clear the signature, e.g. reset the Audio IP by pressing and holding the reset button for 3 seconds on the back.

Please follow the steps below:

- [1] On the configuration screen of "Smart Access Point", click "Door entry system" to access the corresponding screen.

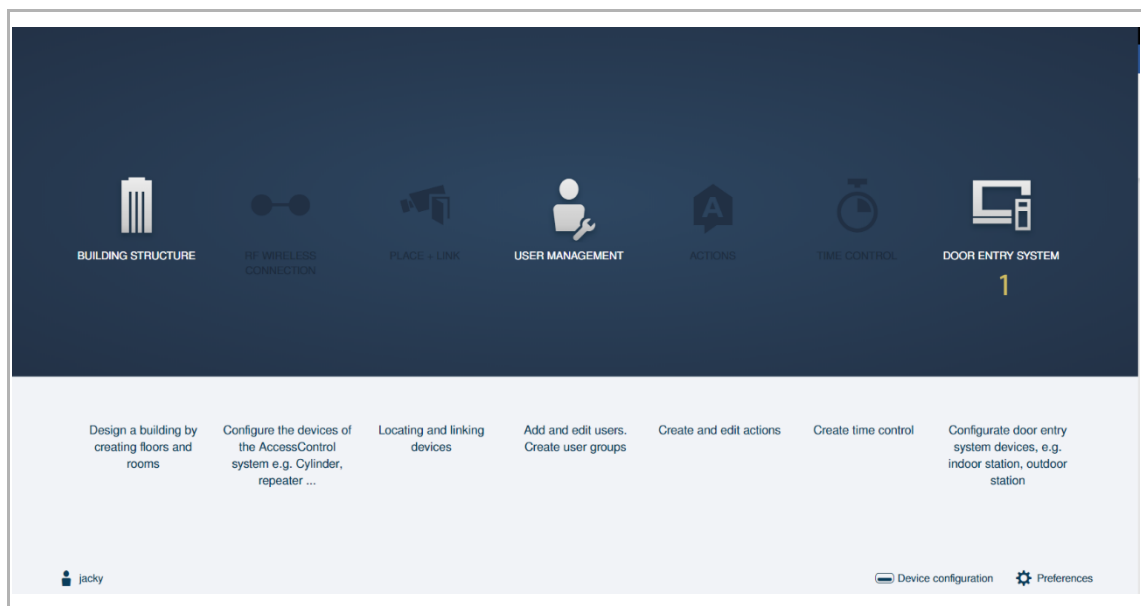

- [2] Click "Add device".
- [3] Select "Indoor station" from the drop-down list.
- [4] Enter block number.
- [5] Enter floor number
- [6] Enter room number.
- [7] Enter device ID:
  - Master indoor station, device ID is 1.
  - Slave indoor station:
    - If Audio IP is connected to the common network, device ID can be 2-3.
    - If Audio IP is connected to the home network, device ID can be 2-32.
- [8] Enter the serial number pasted on the back of the device.
- [9] Click "Save".

The screenshot shows the 'ADD DEVICE' form in the 'INDOOR STATIONS' application. The form is titled 'ADD DEVICE' and contains the following fields:

- Device type:** A dropdown menu set to 'Indoor station'.
- Device addr.:** Four input fields with values 1, 1, 1, and 2.
- Serial No.:** An input field with the value 102807A7F030593.

The form has 'Cancel' and 'Save' buttons at the bottom. The background shows a sidebar with 'Indoor stations' selected and a 'LIST VIEW' panel on the right.

## 8.1.2 Adding Audio IP via App

### Precondition

- Audio IP must be powered on.
- Audio IP should not be signed by other "Smart Access Point". If Audio IP has been signed by other "Smart Access Point", you need to clear the signature, e.g. reset the Audio IP by pressing and holding the reset button for 3 seconds on the back.
- Select "Setup Welcome IP" when login into App.
- A project has been created on the App, this project includes the designated buildings, floors and rooms.

Please follow the steps below:

- [1] Open the App, go to a designated room screen, click .
- [2] Scan the QR code on the back of Audio IP and then continue from step 4.
- [3] Or click "Serial number" and enter the serial number pasted on the back of Audio IP.

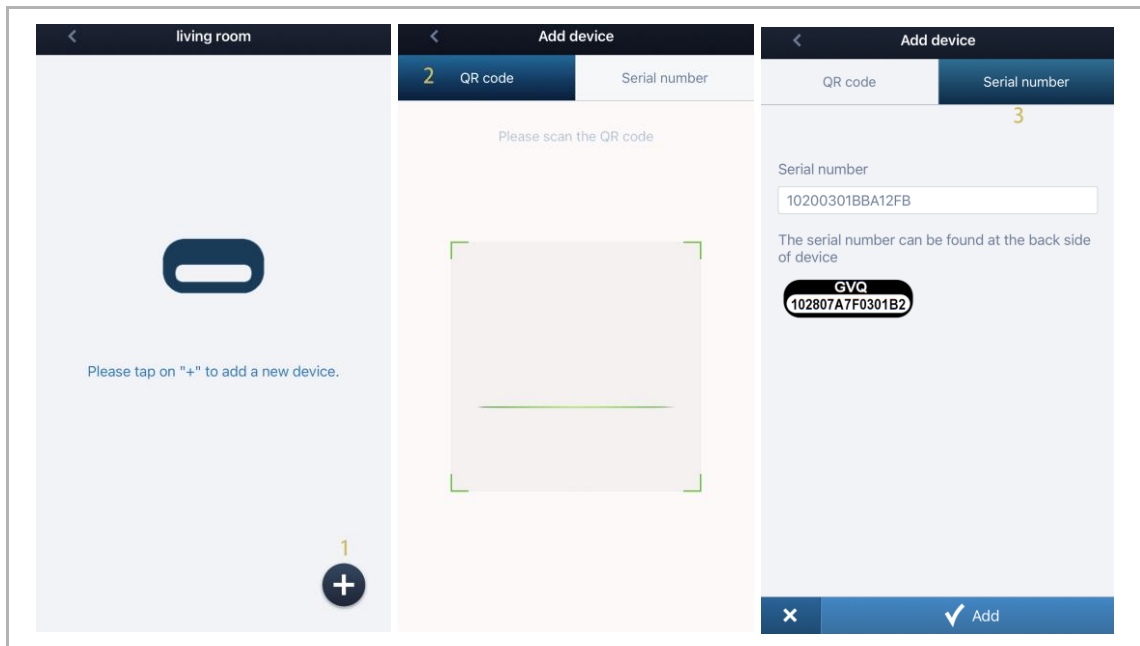

[4] Enter the device ID:

- Master indoor station, device ID is 1.
- Slave indoor station:
  - If Audio IP is connected to the common network, device ID can be 2-3.
  - If Audio IP is connected to the home network, device ID can be 2-32.

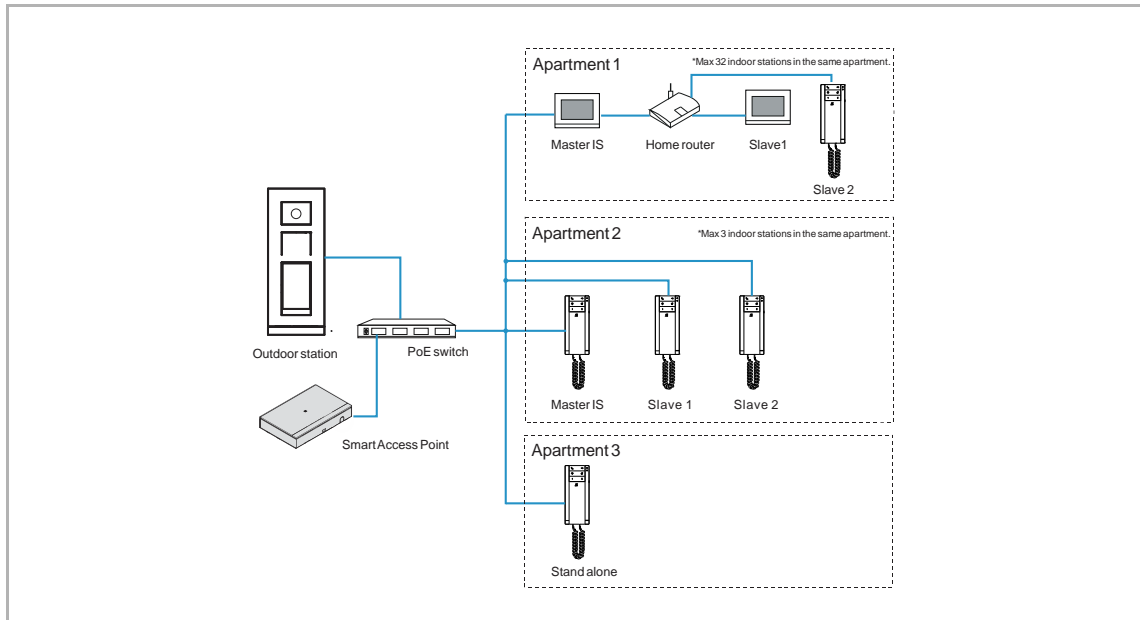

[5] Enter the location information.

[6] Set the device type to "Indoor station".

[7] Click "Add".

[8] On the designated room screen, the result is displayed on the screen.

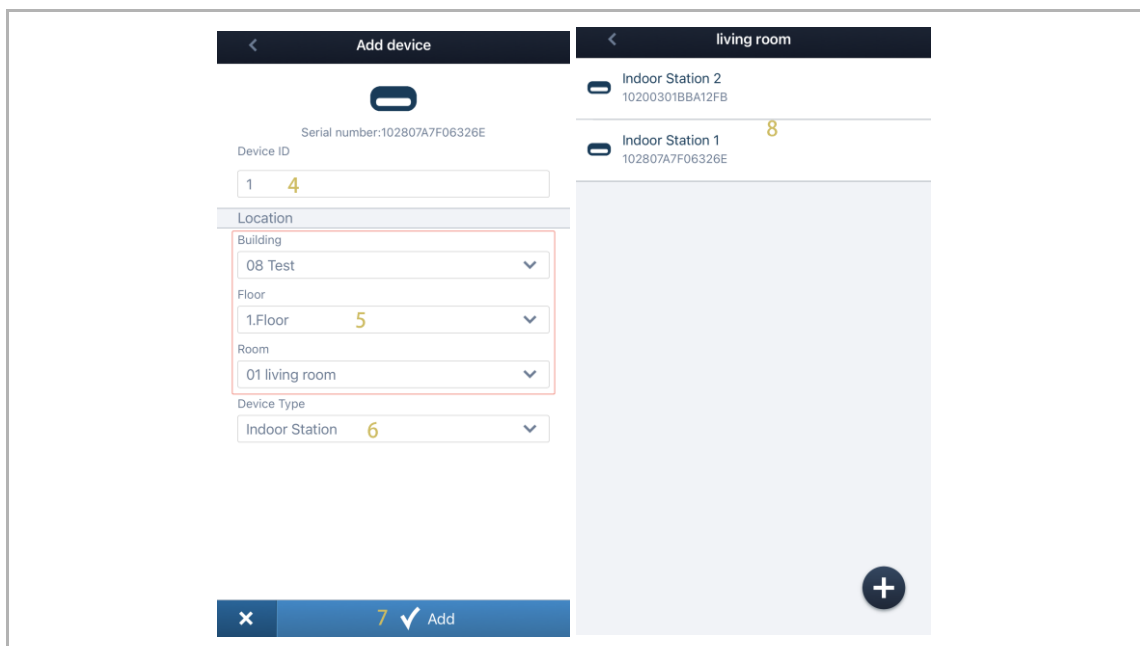

### 8.1.3 Importing a building structure via App

"Smart Access Point" can import the building structure from the App. It is permitted to import one building or multiple buildings as a batch.

#### Importing rule

Building structure will be overwritten according to the building number.

App buildings	"Smart Access Point" original buildings	"Smart Access Point" final buildings
B+	A, B, C	A, B+, C
B+, C+	A, B, C	A, B+, C+
D, E, F	A, B, C	A, B, C, D, E, F

+ means the building structure has been changed.

#### Precondition

App must be on the same network with the router connected to "Smart Access Point".

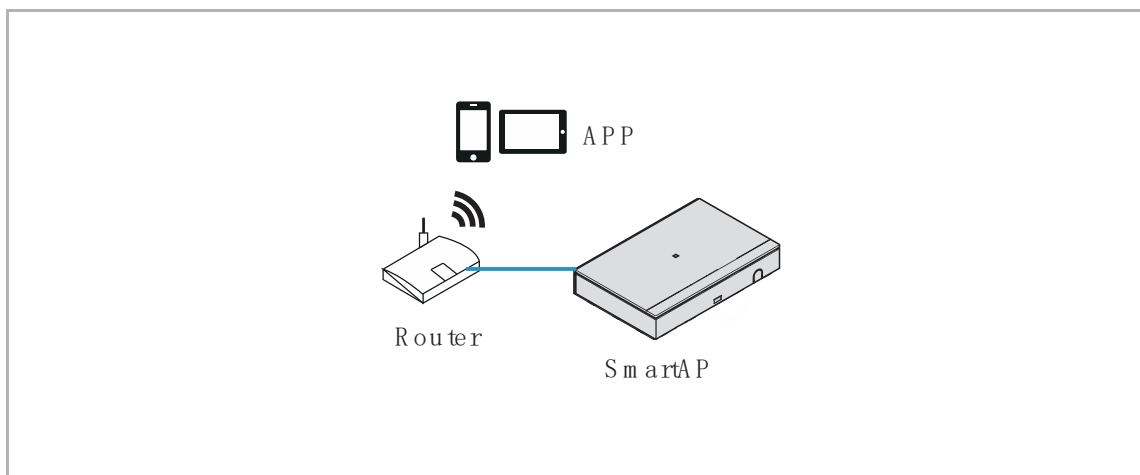

Please follow the steps below:

[1] On the "Main menu" screen of "Smart Access Point", click  .

[2] A pop-up window will be displayed on the screen. Now turn to the App.

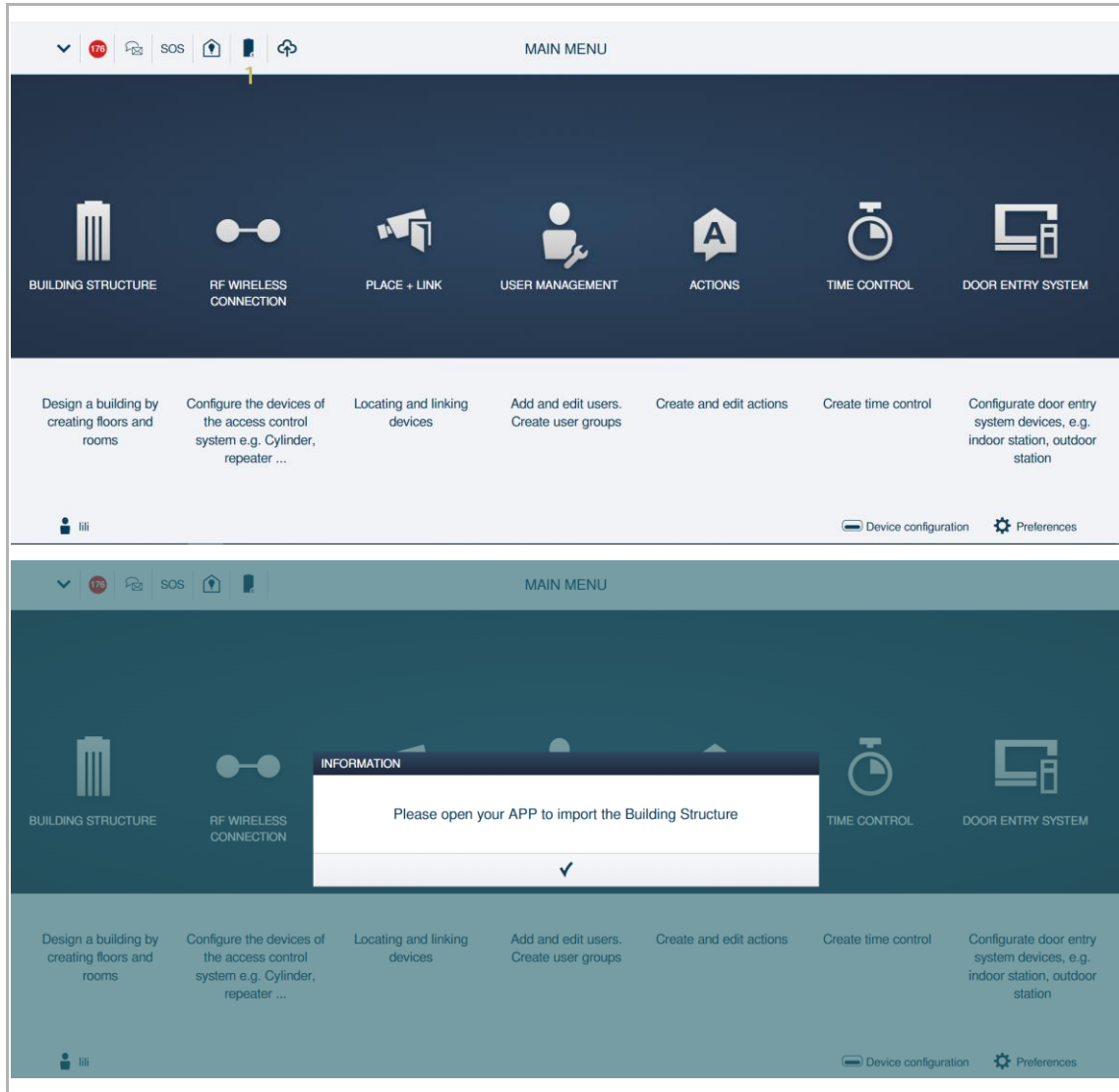

- [3] Open the App, turn to a designated project screen, swipe the project to the right.
- [4] Click .
- [5] Click the designated "Smart Access Point".
- [6] Enter the admin name and password which is used to login "Smart Access Point".
- [7] Click "OK".
- [8] Click "OK".
- [9] On the "Main menu" screen of "Smart Access Point", click "✓" to finish the importing.

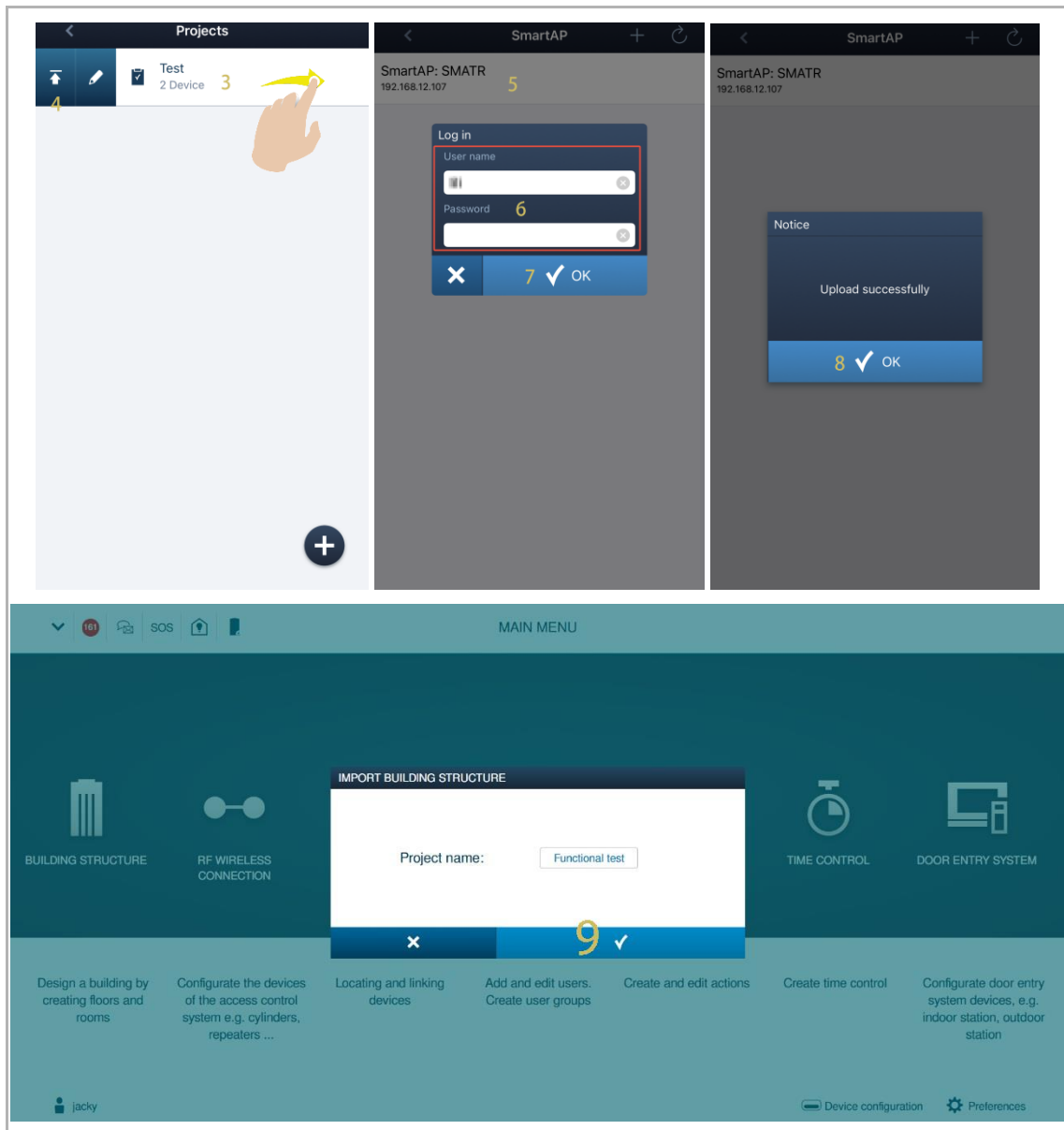

### 8.1.4 Accessing the setting screen

Please follow the steps below:

- [1] On the "Main menu" screen of "Smart Access Point", Click "Door entry system".
- [2] Click "Indoor stations".
- [3] Go to "Audio Indoor Station" section.
- [4] Click the designated Audio IP.

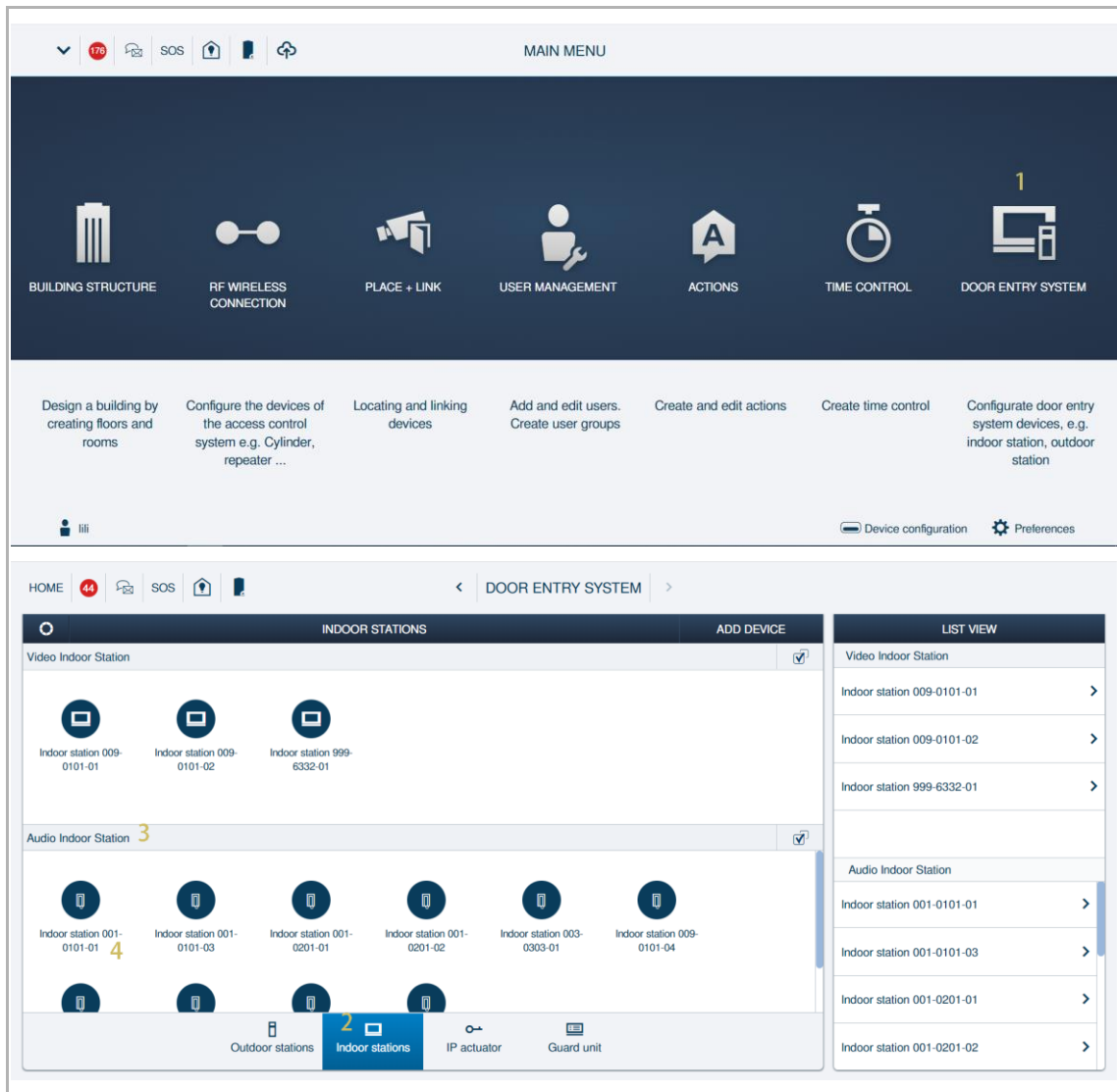

8.1.5 Basic information

On the designated Audio IP screen,

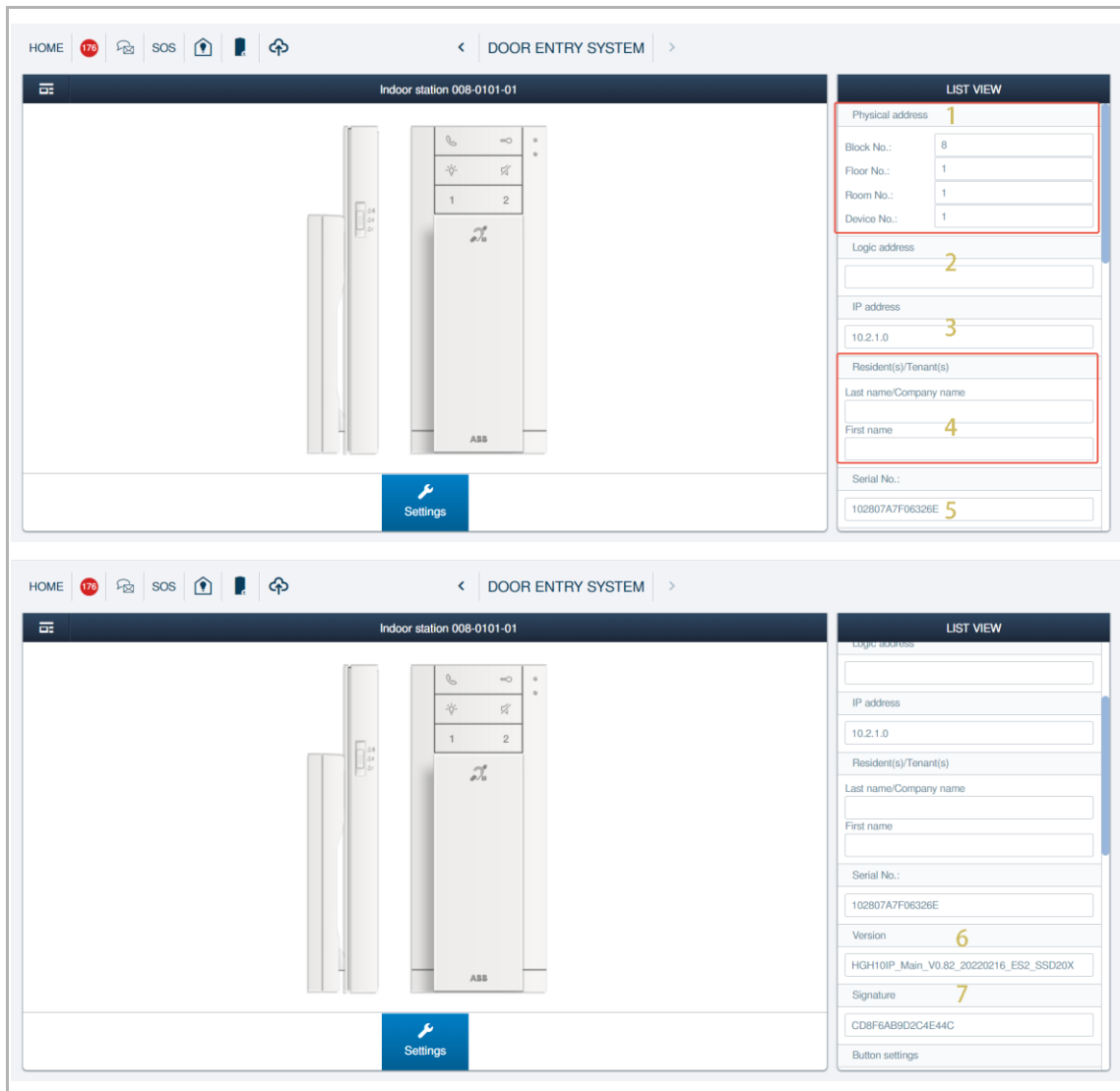

No.	Description
1	View the physical address
2	View the logical address
3	View the IP address
4	View the first name and the last name of the resident or the tenant
5	View the serial number
6	View the firmware version
7	View the signature

### 8.1.6 Call button setting

#### Access the setting screen

Please follow the steps below:

- [1] On the designated Audio IP screen, go to the "Button settings" section.
- [2] Click "Call options". The call button can be set to 3 types of functions.

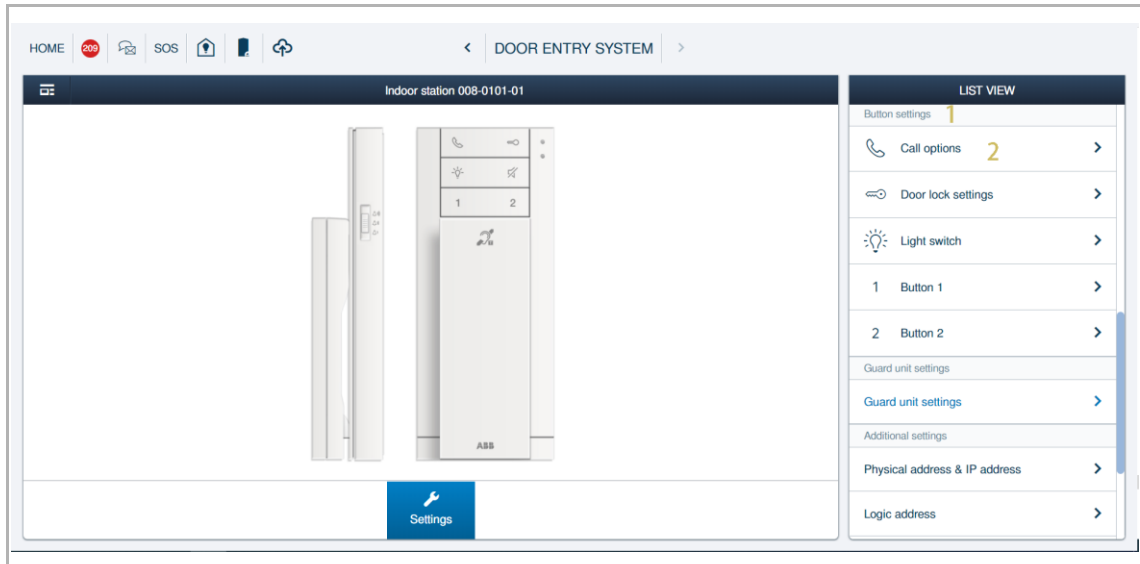

#### Intercom to same unit

Please follow the steps below:

- [1] On the "Call options" screen, select "Intercom to same unit".
- [2] Select the target, it can be "Group call" or designated call.
- [3] Click "Save".

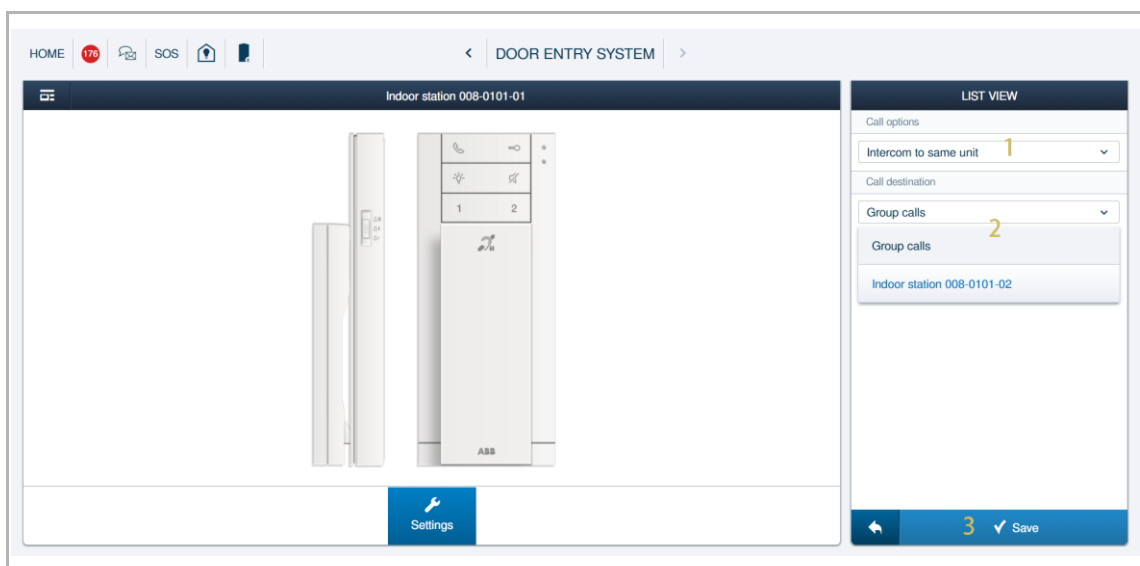

## Intercom to other unit

Please follow the steps below:

- [1] On the "Call options" screen, select "Intercom to other unit".
- [2] Set the position for the designated indoor station, e.g. building, floor and apartment.
- [3] Click "Save".

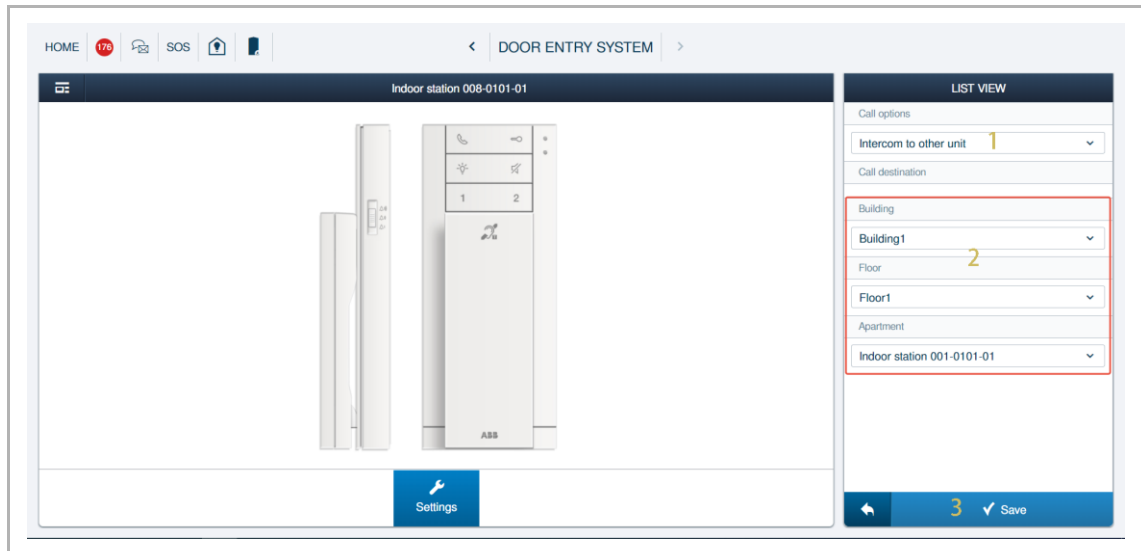

## Call guard unit

Please follow the steps below:

- [1] On the "Call options" screen, select "Call guard unit".
- [2] Click "Save".

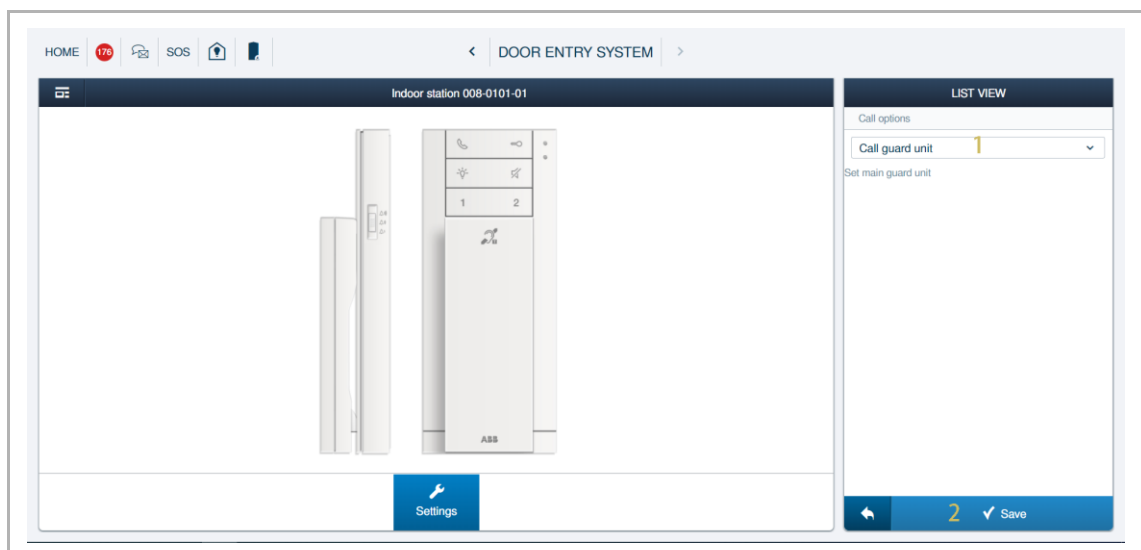

### Note

Guard unit address needs to be set before calling a guard unit.

### 8.1.7 Unlock button setting

#### Access the setting screen

Please follow the steps below:

- [1] On the designated Audio IP screen, go to the "Button settings" section.
- [2] Click "Door lock settings". The unlock button can be set to 2 types of functions.

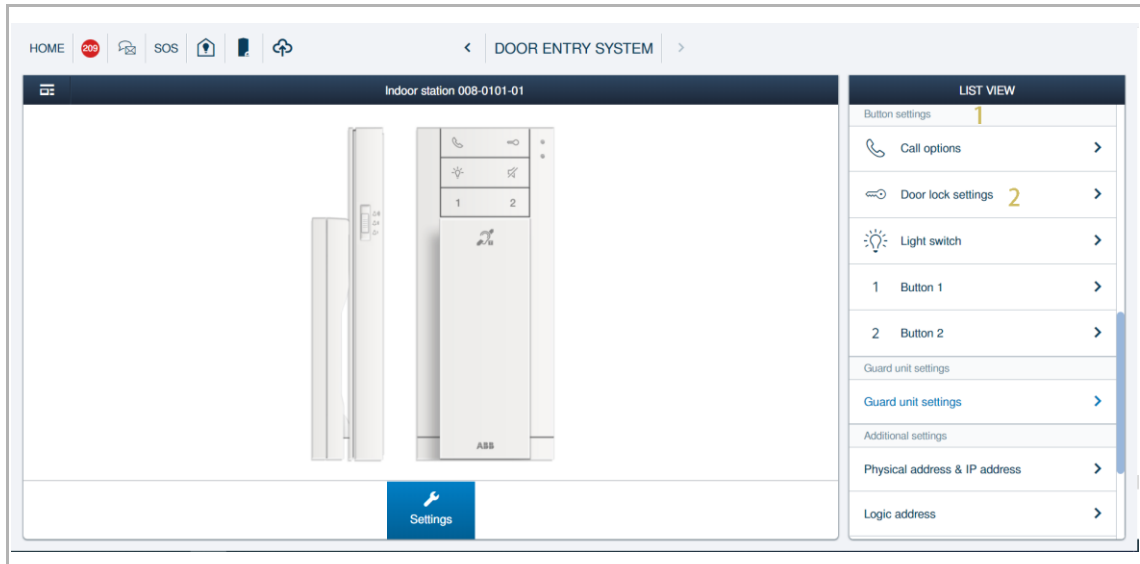

#### Open door with Outdoor station

Please follow the steps below:

- [1] On the "Door lock settings" screen, select "Open door with Outdoor station".
- [2] Select the designated outdoor station or gate station.
- [3] Select the lock type, it can be set to "Default lock" or "Subsidiary lock".
- [4] Click "Save".

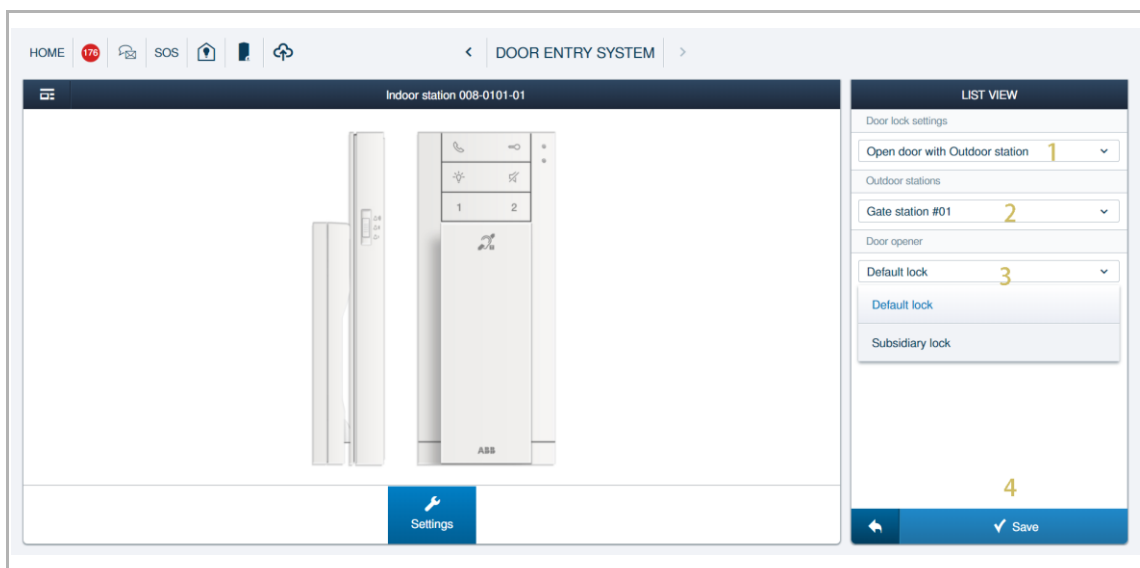

### Open door with IP actuator

Please follow the steps below:

- [1] On the "Door lock settings" screen, select "Open door with IP actuator".
- [2] Select the designated IP actuator connected by the lock.
- [3] Select the lock type, it can be set to "Default lock" or "Subsidiary lock".
- [4] Click "Save".

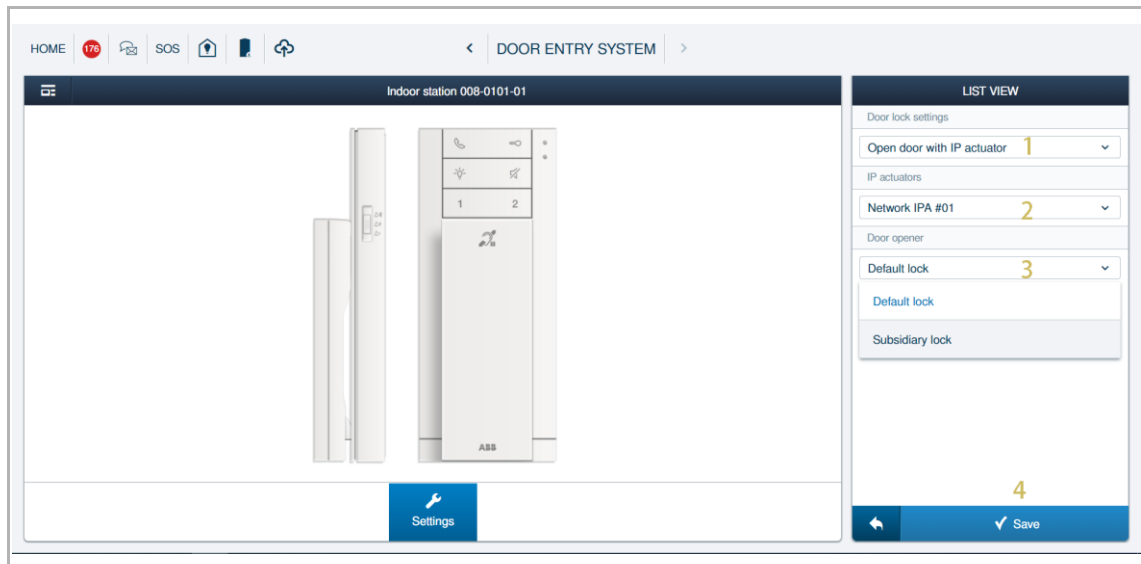

### 8.1.8 Light button setting

Please follow the steps below:

- [1] On the designated Audio IP screen, go to the "Button settings" section.
- [2] Click "Light switch".
- [3] Select the designated IP actuator connected by the light.
- [4] Click "Save".

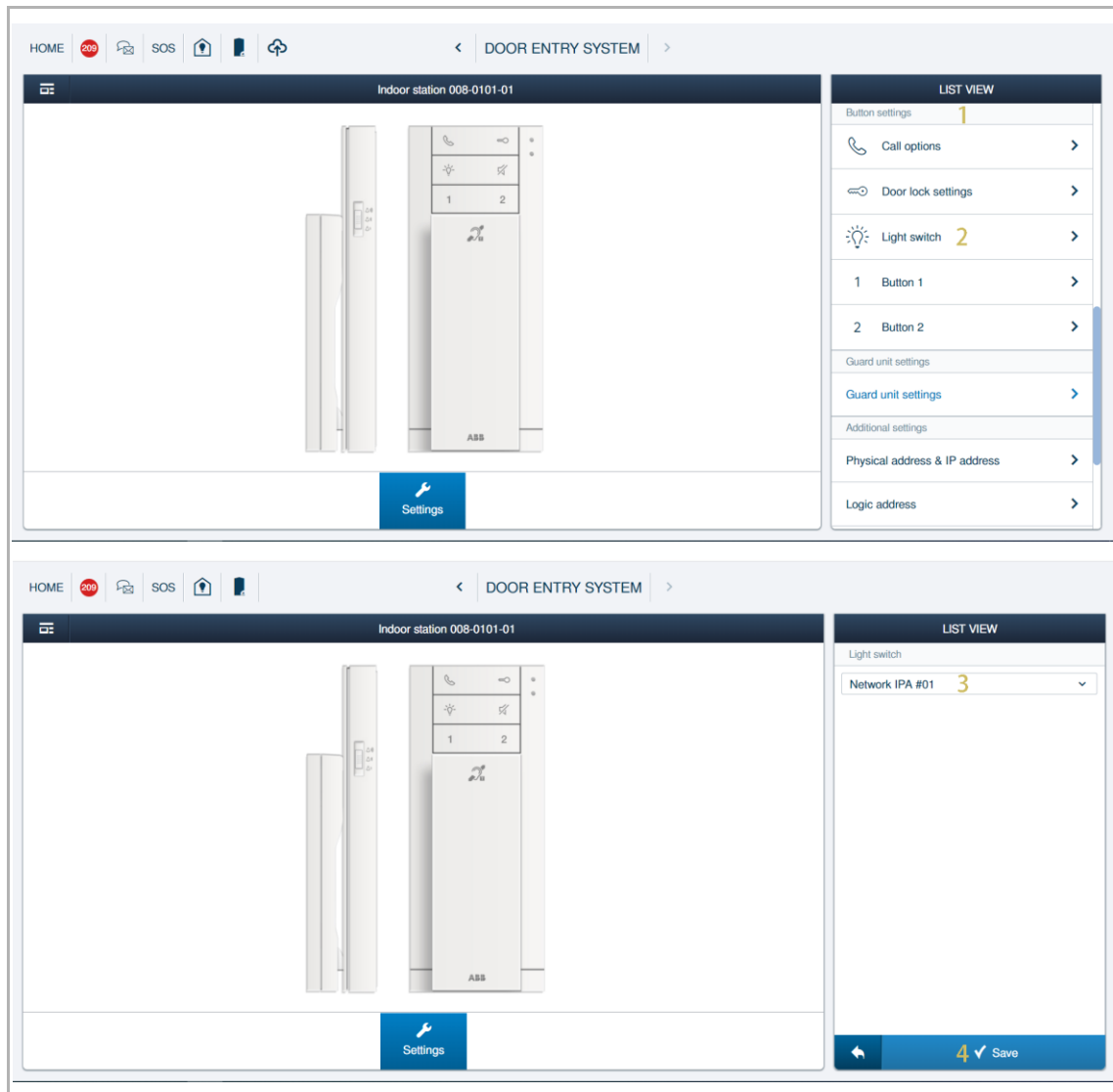

### 8.1.9 Programmed button setting

#### Access the setting screen

Please follow the steps below:

- [1] On the designated Audio IP screen, go to the "Button settings" section.
- [2] Click "Button 1/2". The programmed button can be set to 7 types of functions.

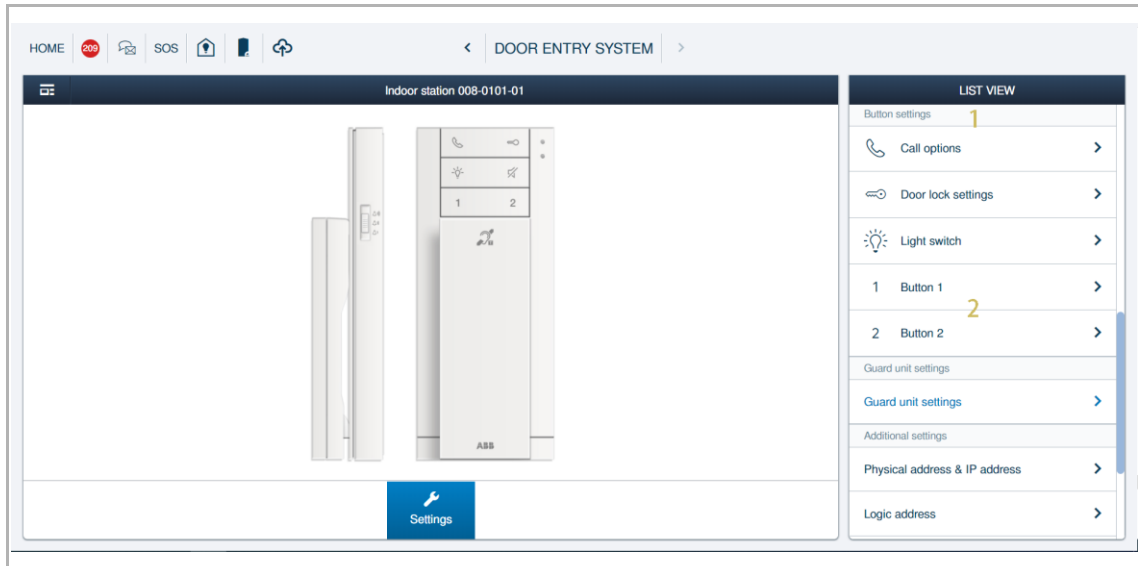

#### Intercom to same unit

Please follow the steps below:

- [1] On the "Button 1/2" screen, select "Intercom to same unit".
- [2] Select the target, it can be "Group call" or designated call.
- [3] Click "Save".

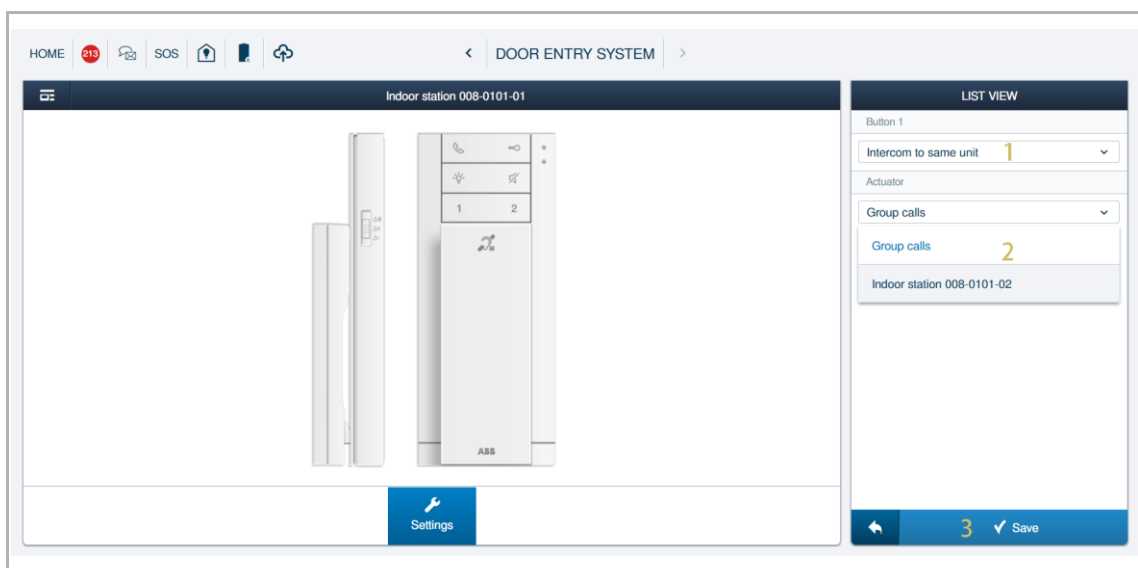

## Intercom to other unit

Please follow the steps below:

- [1] On the "Button 1/2" screen, select "Intercom to other unit".
- [2] Set the position for the designated indoor station, e.g. building, floor and apartment.
- [3] Click "Save".

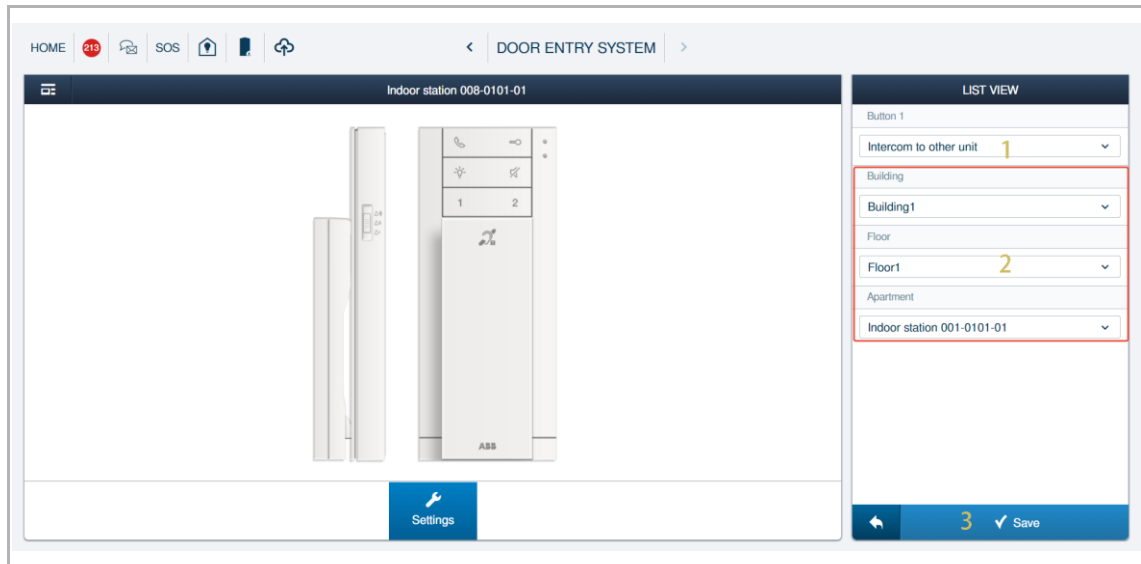

## Call guard unit

Please follow the steps below:

- [1] On the "Button 1/2" screen, select "Call guard unit".
- [2] Click "Save".

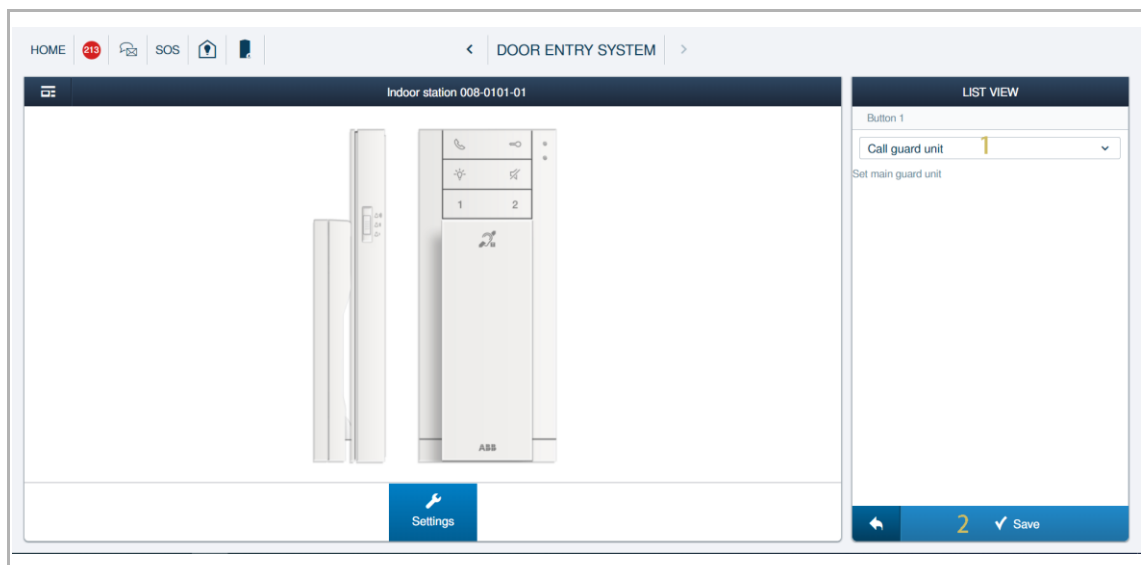

### Note

Guard unit address needs to be set before calling a guard unit.

### Open door with Outdoor station

Please follow the steps below:

- [1] On the "Button 1/2" screen, select "Open door with Outdoor station".
- [2] Select the designated outdoor station or gate station.
- [3] Select the lock type, it can be set to "Default lock" or "Subsidiary lock".
- [4] Click "Save".

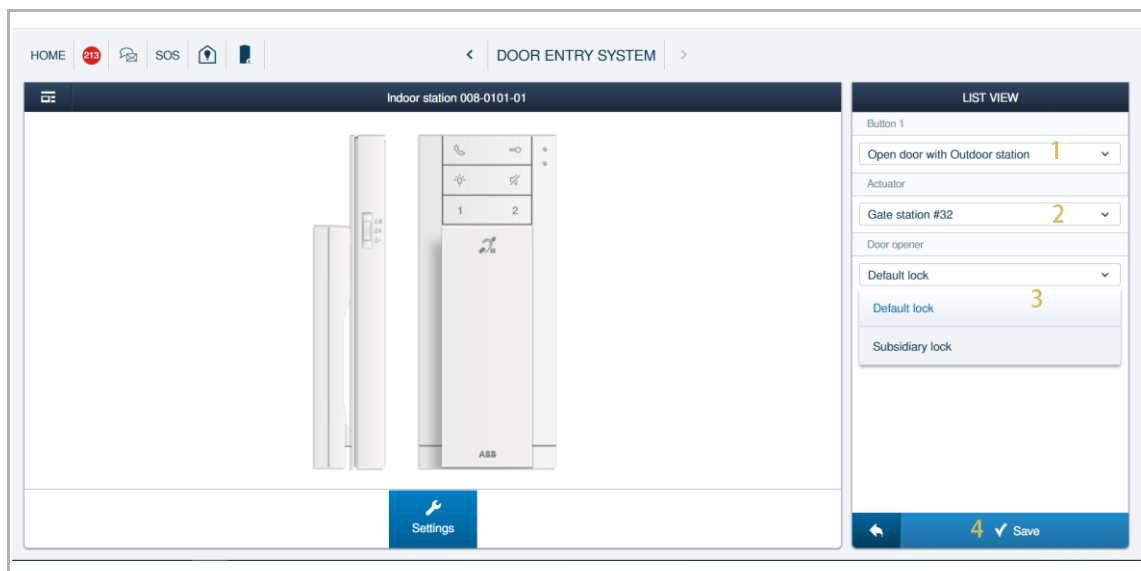

### Open door with IP actuator

Please follow the steps below:

- [1] On the "Button 1/2" screen, select "Open door with IP actuator".
- [2] Select the designated IP actuator connected to by the lock.
- [3] Select the lock type, it can be set to "Default lock" or "Subsidiary lock".
- [4] Click "Save".

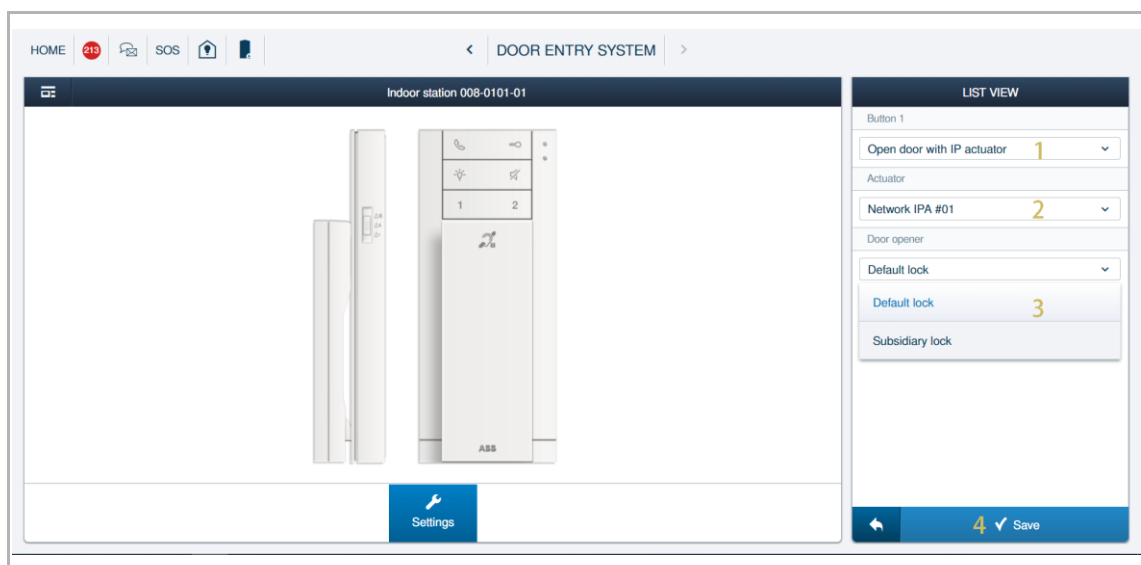

### Light switch

Please follow the steps below:

- [1] On the "Button 1/2" screen, select "Light switch".
- [2] Select the designated IP actuator connected by the light.
- [3] Click "Save".

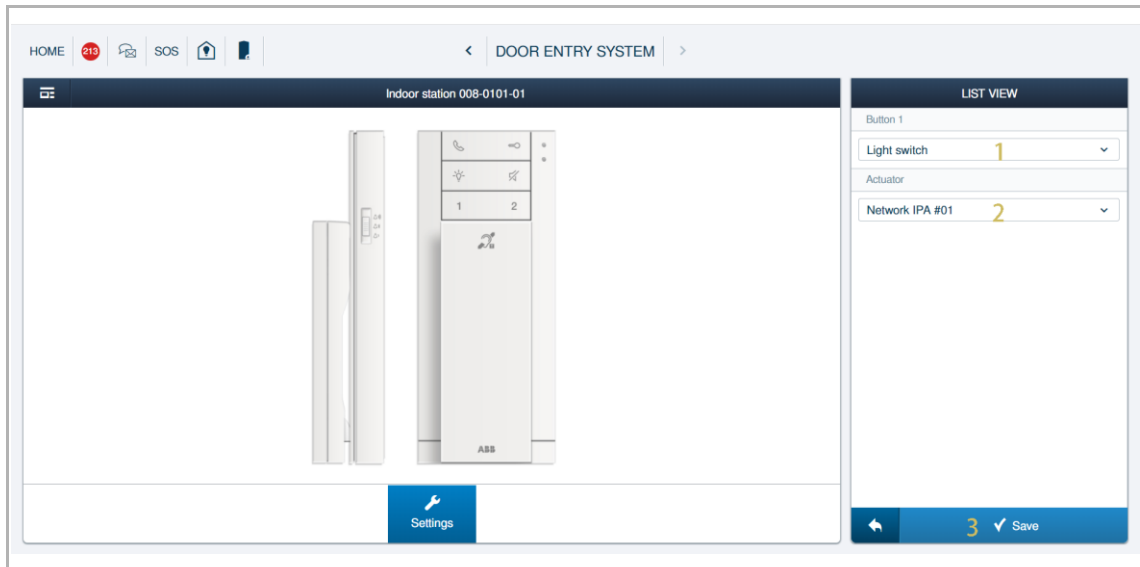

### SOS call

Guard unit address needs to be set before SOS call.

Please follow the steps below:

- [1] On the "Button 1/2" screen, select "SOS call".
- [2] Click "Save".

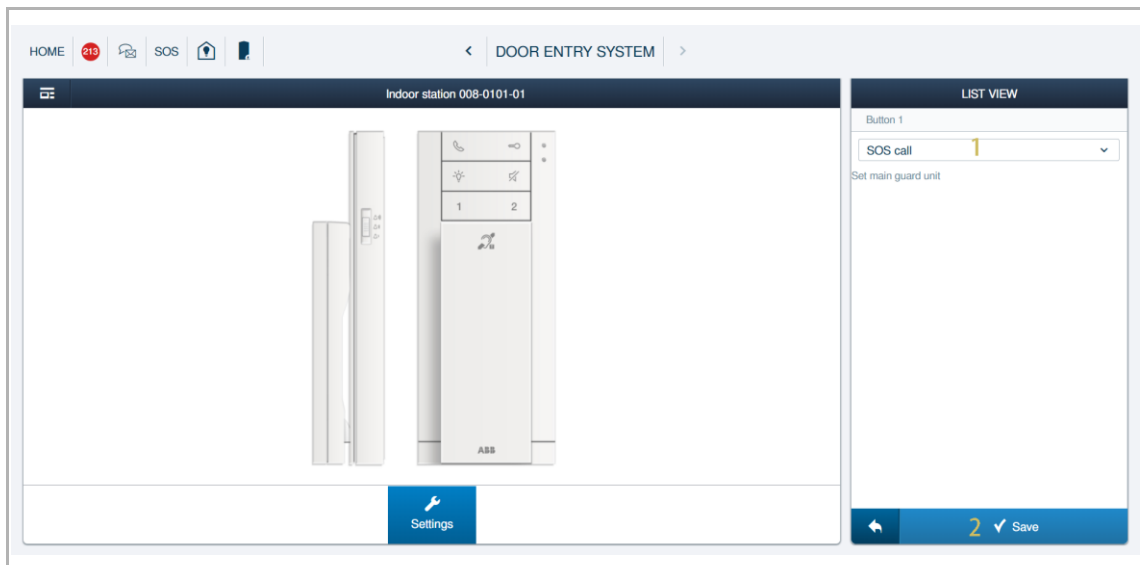

### 8.1.10 Guard unit setting

Please follow the steps below:

- [1] On the designated Audio IP screen, go to "Guard unit settings" section.
- [2] Click "Guard unit settings".
- [3] Set the default Guard unit.
- [4] Click "Save".

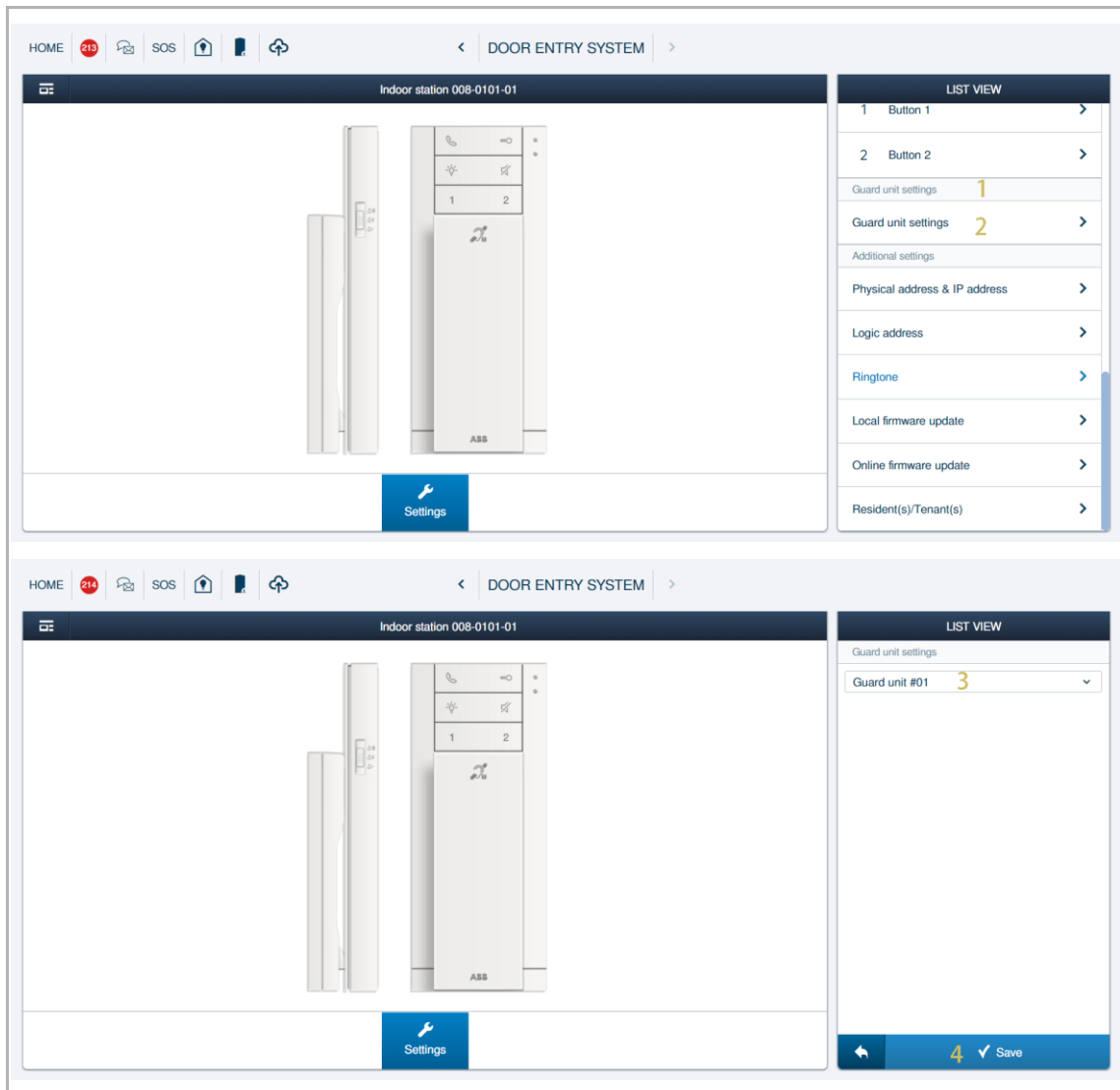

## 8.1.11 Physical address &amp; IP address setting

## Topology

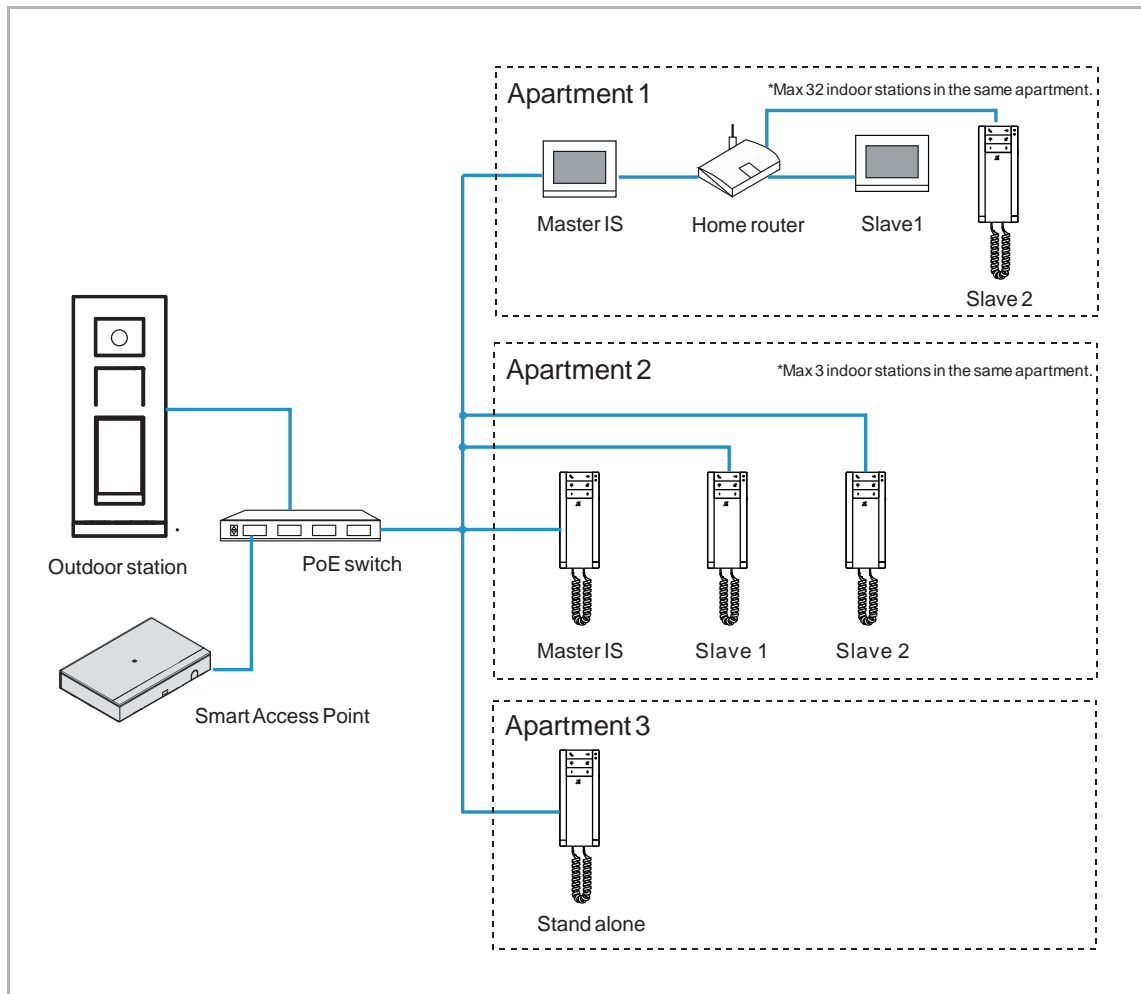

- If Audio IP connects to common network, it can be "Master mode", "Subsidiary mode" or "Independent mode".
- If Audio IP connects to home network, it can be "Subsidiary mode" only, master indoor station should be a video indoor station.

**Master mode/Subsidiary mode:** only one indoor station can be set to master mode in the same apartment, other indoor stations must be set to the subsidiary mode.

### Access the setting screen

Please follow the steps below:

- [1] On the designated Audio IP screen, go to "Additional settings" section.
- [2] Click "Physical address & IP address".

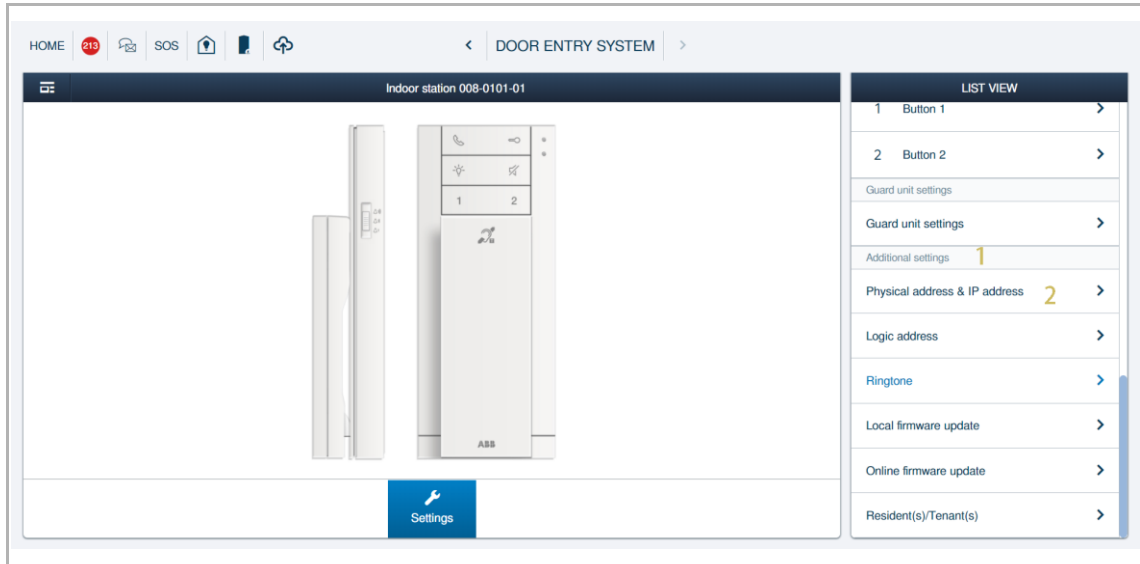

### Master mode

Only the Audio IPs connect to common network can be set to "Master mode".

Please follow the steps below:

- [1] On the "Physical address & IP address" screen, select "Master mode".
- [2] Enter the physical address.
- [3] Select the network type, it can set to "DHCP", "Customizable address" or "ABB Legacy".
  - If "ABB Legacy" is selected, IP address will be "10.0.x.x". Its connect type should be the same as SmartAP.
- [4] Click "Save".

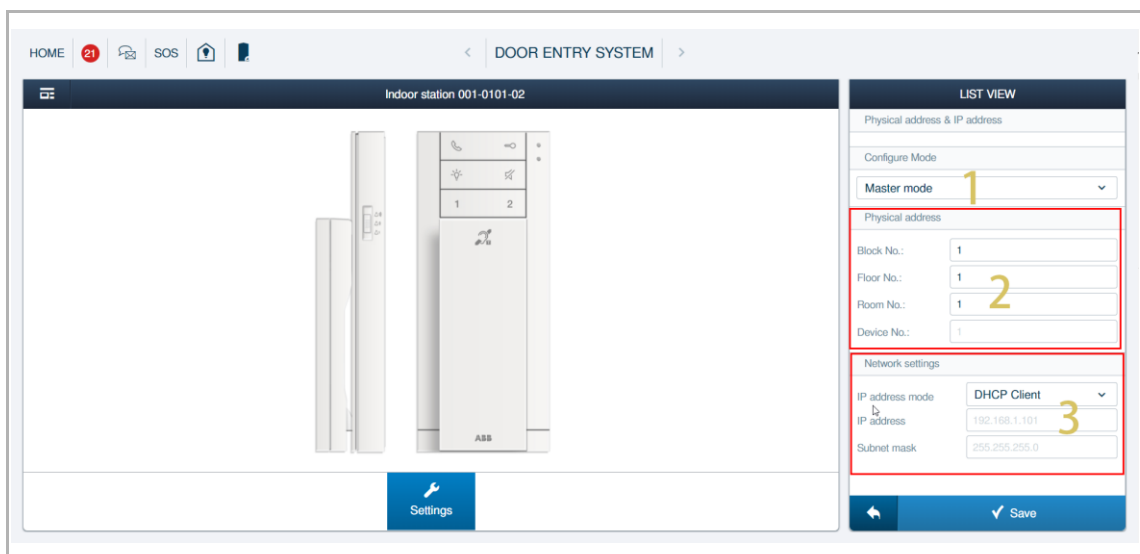



### Subsidiary mode

Please follow the steps below:

- [1] On the "Physical address & IP address" screen, select "Subsidiary mode".
- [2] Enter the physical address.
- [3] Select the network type, it can set to "DHCP", "Customizable address" or "ABB Legacy".
  - If "ABB Legacy" is selected, IP address will be "10.0.x.x". Its connect type should be the same as SmartAP.
- [4] Click "Save".

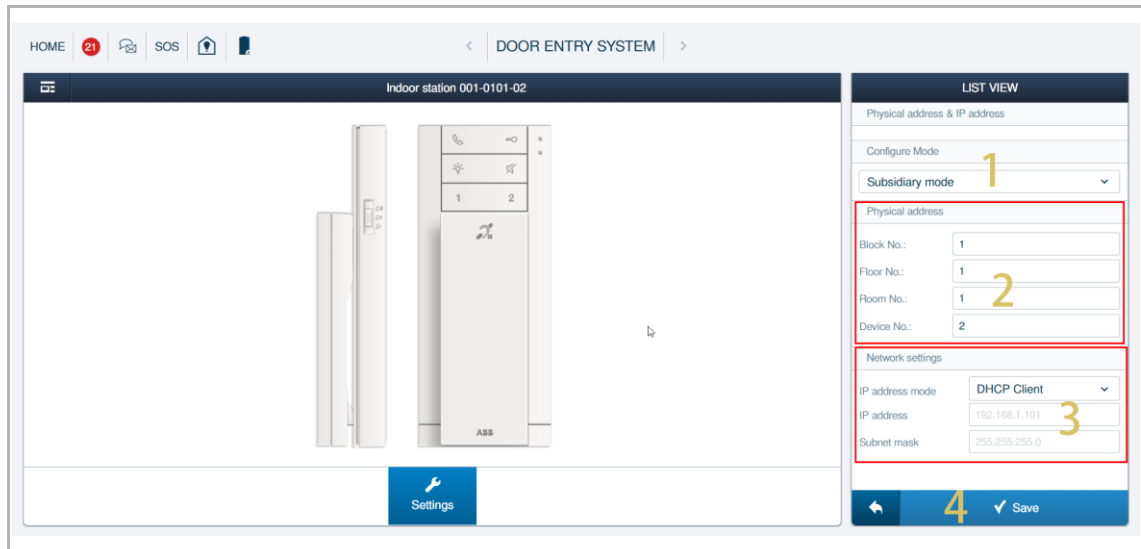

### 8.1.12 Logical address setting

Please follow the steps below:

- [1] On the designated Audio IP screen, go to "Additional settings" section.
- [2] Click "Logic address".
- [3] Enter the logical address.
- [4] Click "Save".

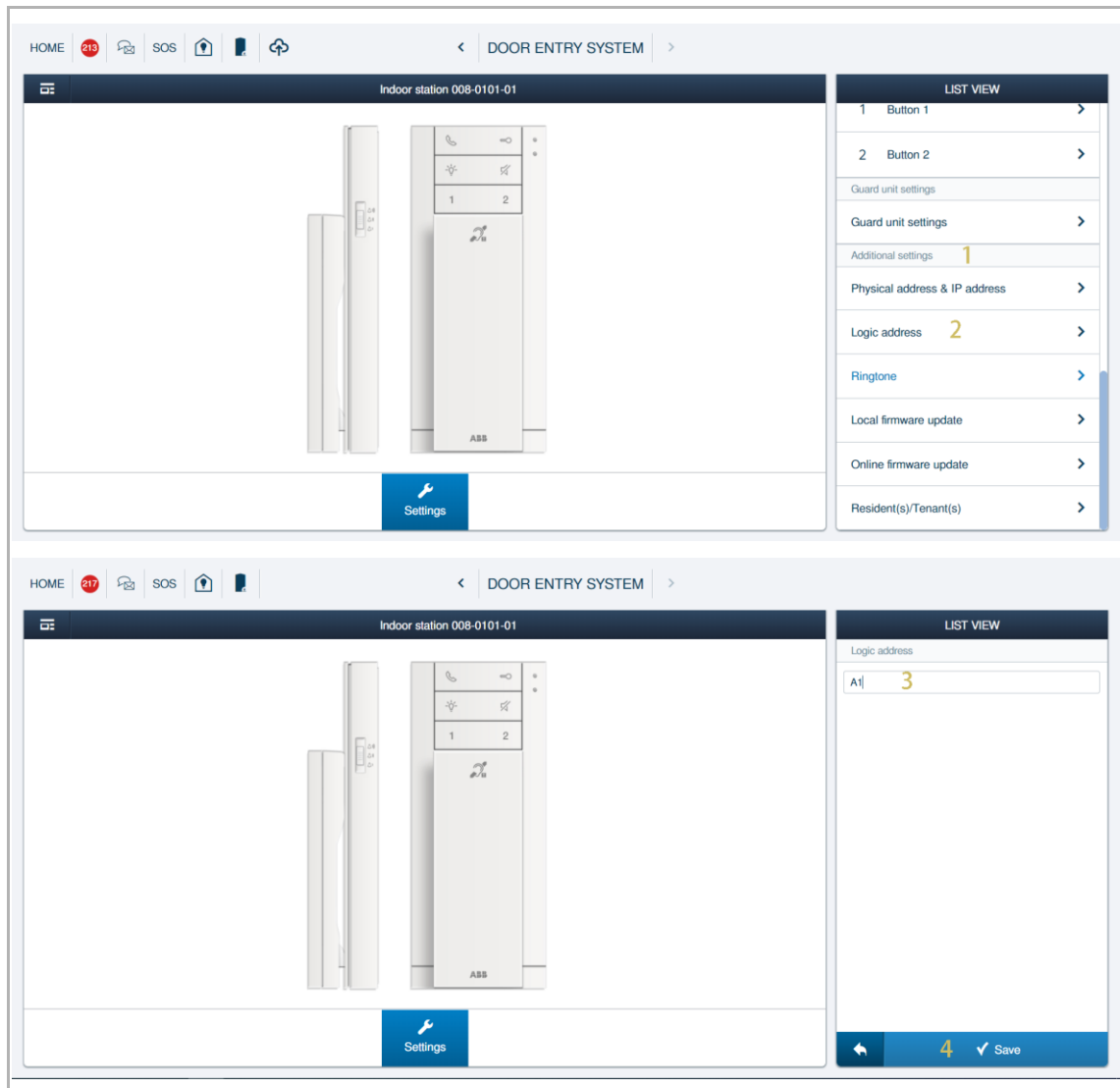

### 8.1.13 Ringtone setting

Please follow the steps below:

- [1] On the designated Audio IP screen, go to the "Additional settings" section.
- [2] Click "Ringtone".
- [3] Select the designated ringtones for different types of devices (5 types of ringtones can be selected).
- [4] "Repeated tone" function:
  - Tick the check box to enable the function, the ringtone will ring repeatedly within 30 seconds during an incoming call.
  - Untick the check box to disable the function, the ringtone will ring only once.
- [5] Click "Save".

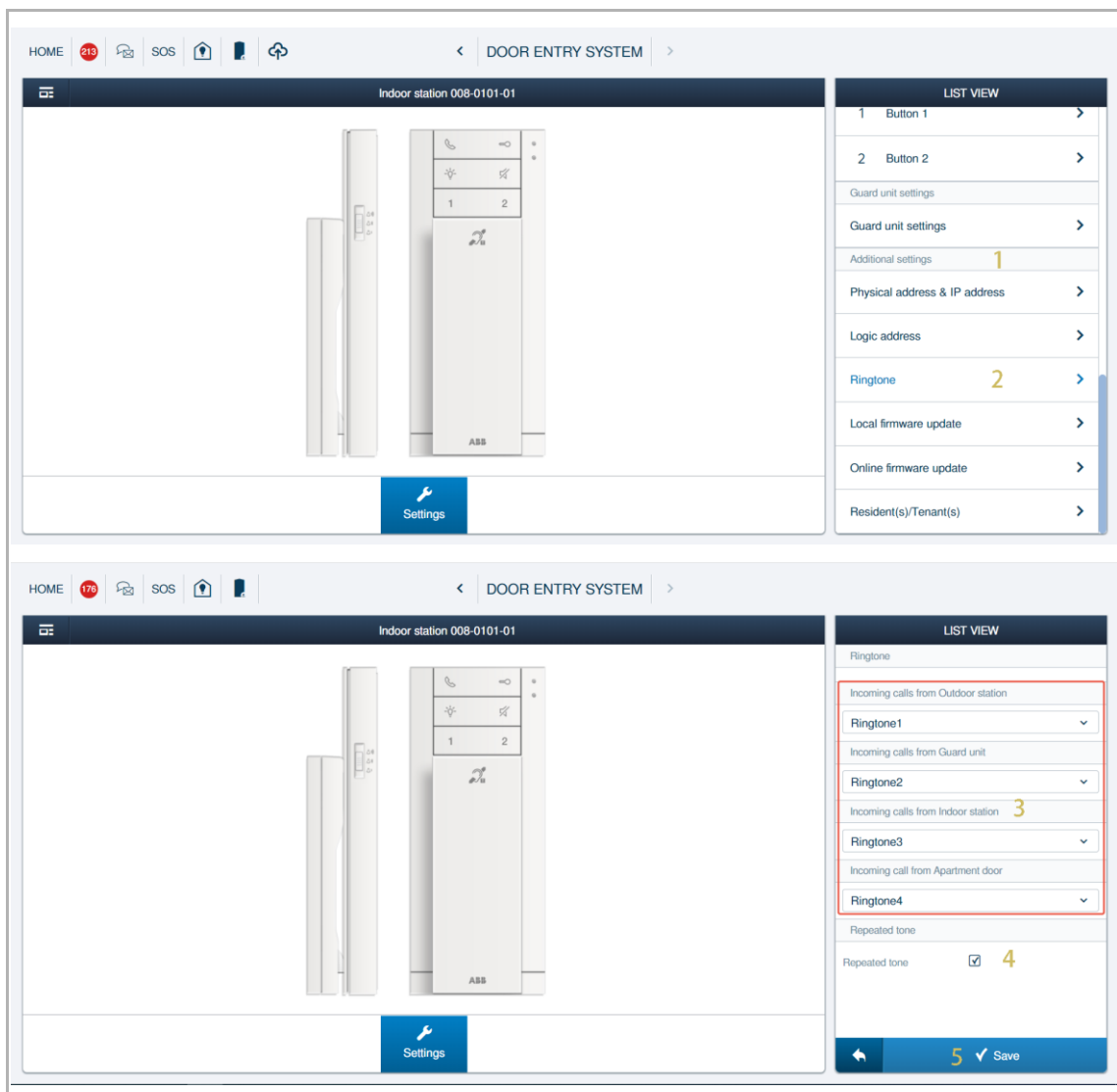

### 8.1.14 Renaming the device

Please follow the steps below:

- [1] On the designated Audio IP screen, go to "Additional settings" section.
- [2] Click "Resident(s)/Tenant(s)".
- [3] Enter the last name and the first name.
- [4] Click "Save".

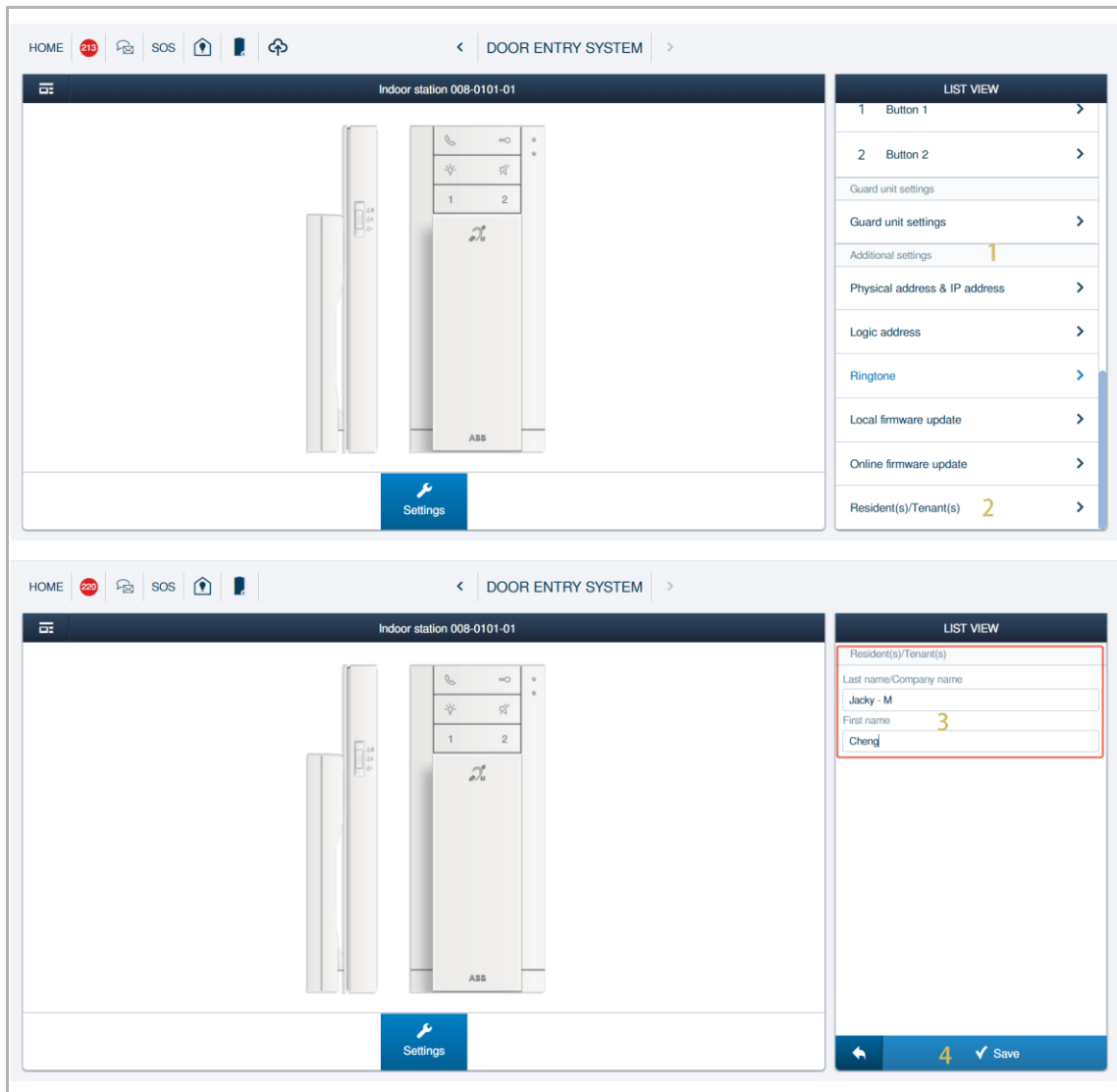

[5] The name is displayed on the screen.

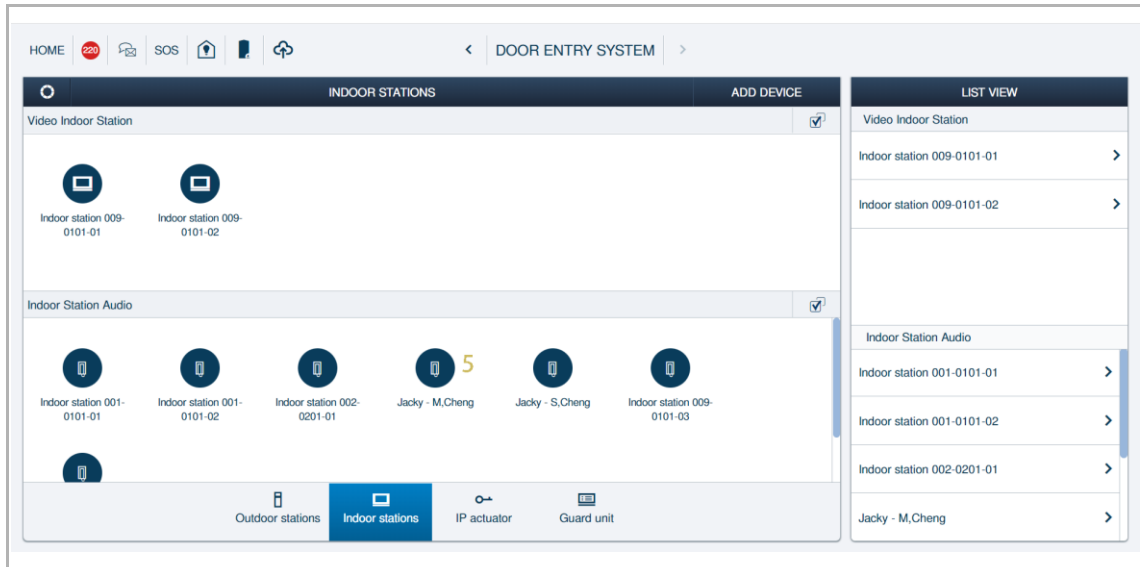

### 8.1.15 Local Firmware update

Please follow the steps below:

- [1] On the designated Audio IP screen, go to "Additional settings" section.
- [2] Click "Local firmware update".
- [3] Click "Browser" to add the firmware update file.
- [4] Click "Browser" to add the firmware signature file.
- [5] Click "Save" to upload the updating files.

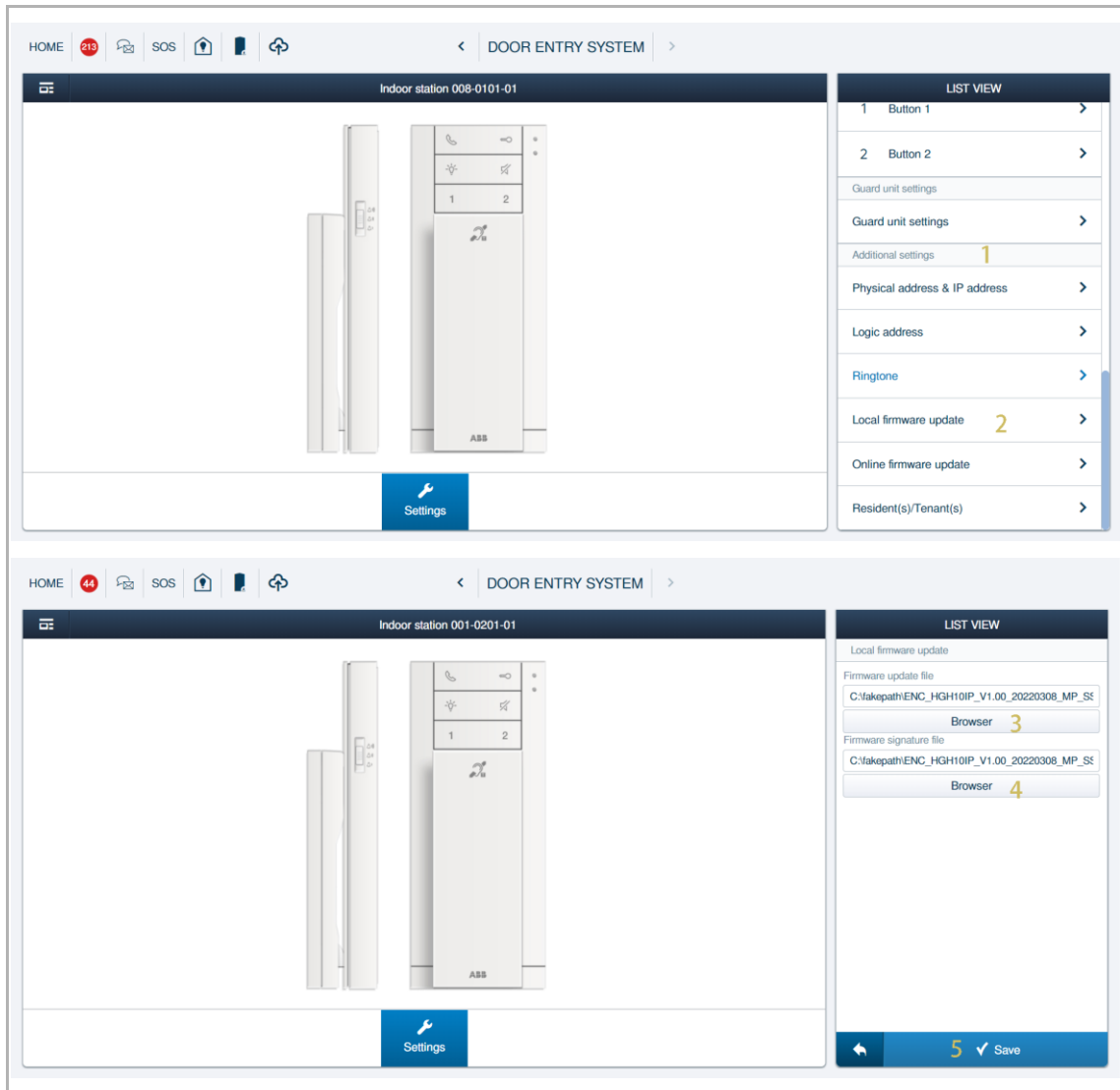

- [6] Click "✓" after uploading the update files successfully.
- [7] Click "Save".
- [8] Click "✓" to accept the "End User License Agreement".

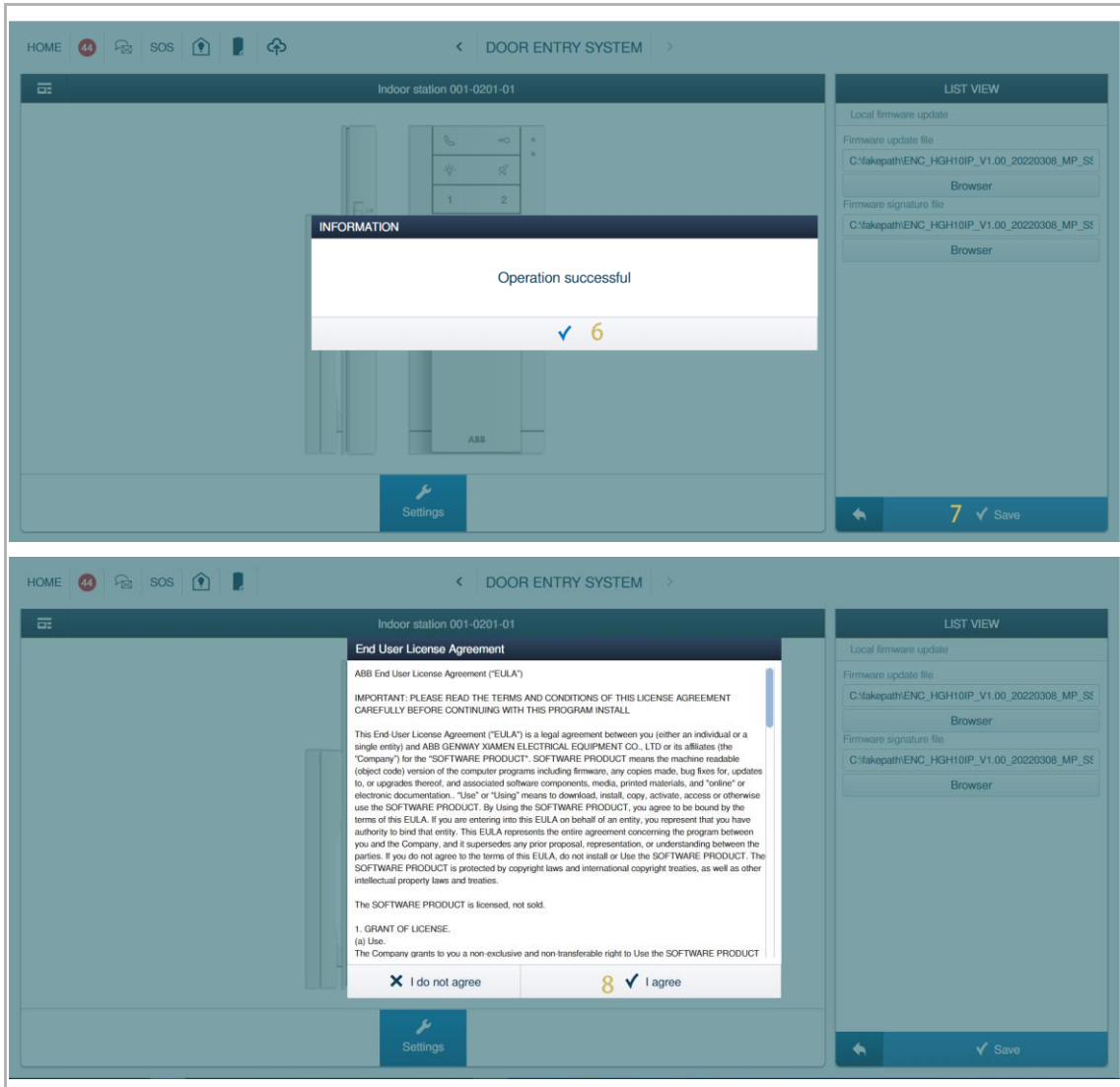

[9] A pop-up window appears to indicate the updating details e.g. Device ID & updating progress.

- The pop-up window can be hidden by clicking "Minimize".
- The updating will be stop if "Cancel the update" is clicked.

[10]Click "Close" to complete the update.

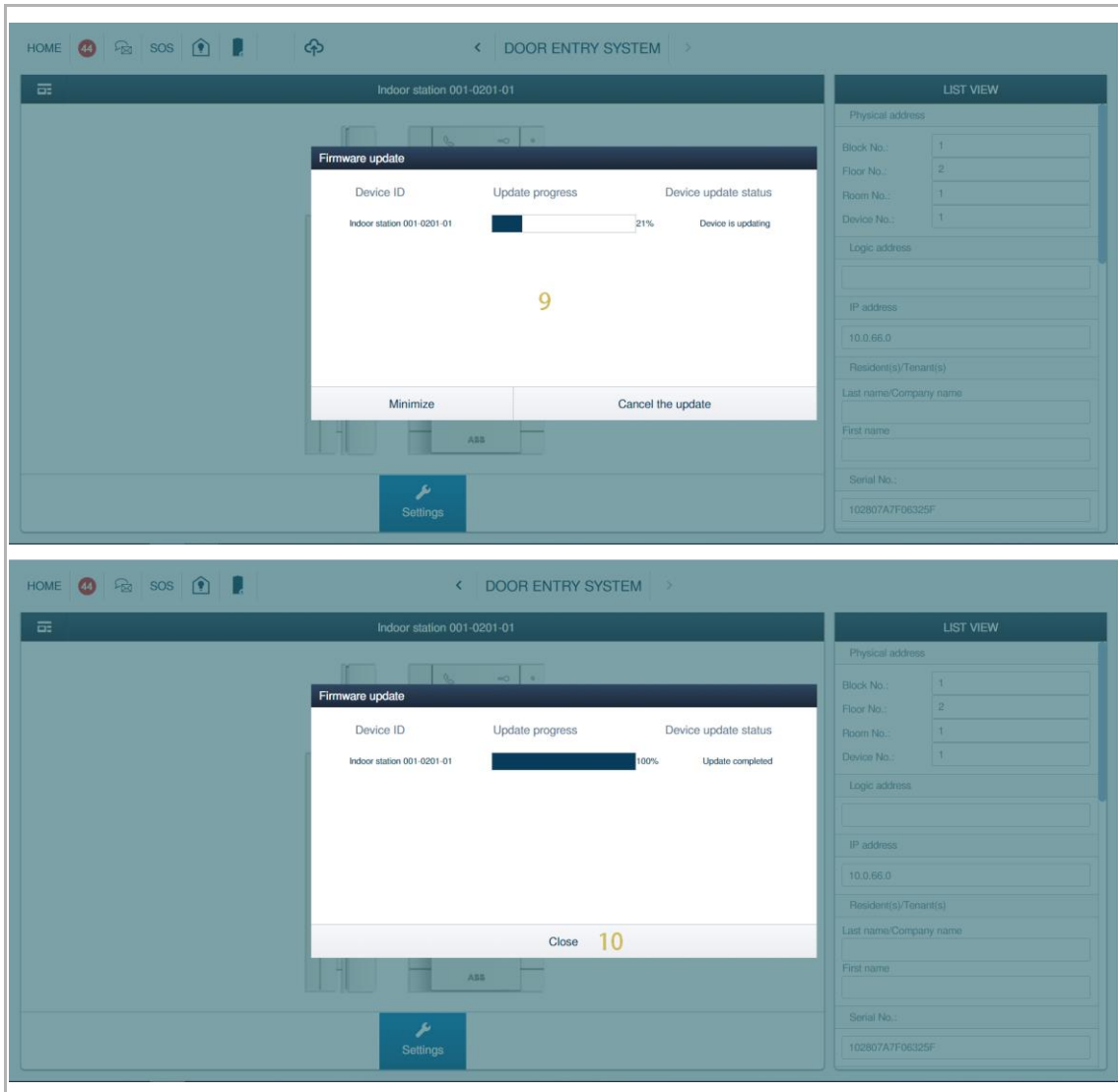

### 8.1.16 Online firmware update

Please follow the steps below:

- [1] On the designated Audio IP screen, go to "Additional settings" section.
- [2] Click "Online firmware update" ("Smart Access Point" must be connected to the Internet).
- [3] Current firmware version is displayed on the screen.
- [4] New firmware version is detected automatically from the website.
- [5] Click "Save" to update the firmware automatically.

The image displays two screenshots of the ABB Door Entry System web interface, illustrating the steps for an online firmware update.

**Top Screenshot:** The interface shows the "DOOR ENTRY SYSTEM" configuration page for "Indoor station 008-0101-01". The main area displays a 3D model of the door entry unit. On the right, a "LIST VIEW" sidebar contains several menu items. Item 1, "Additional settings", is highlighted in yellow. Item 2, "Online firmware update", is also highlighted in yellow.

**Bottom Screenshot:** The interface shows the same configuration page, but the "Online firmware update" section is expanded. It displays the "Current software version" as "HGH10IP\_Main\_V0.82\_20220216\_ES2\_SSD20X". Below this, the "New firmware" section is highlighted in yellow, showing a "New firmware version" of "9.99" and a "V9.99dummy version". At the bottom right, a blue "Save" button with a checkmark is visible, indicating the completion of the update process.

### 8.1.17 Multiple devices setting

Please follow the steps below:

[1] On the "Indoor stations" screen, go to "Audio Indoor Station" section.

[2] Click  .

[3] Select the designated Audio IPs.

[4] Click "Next".

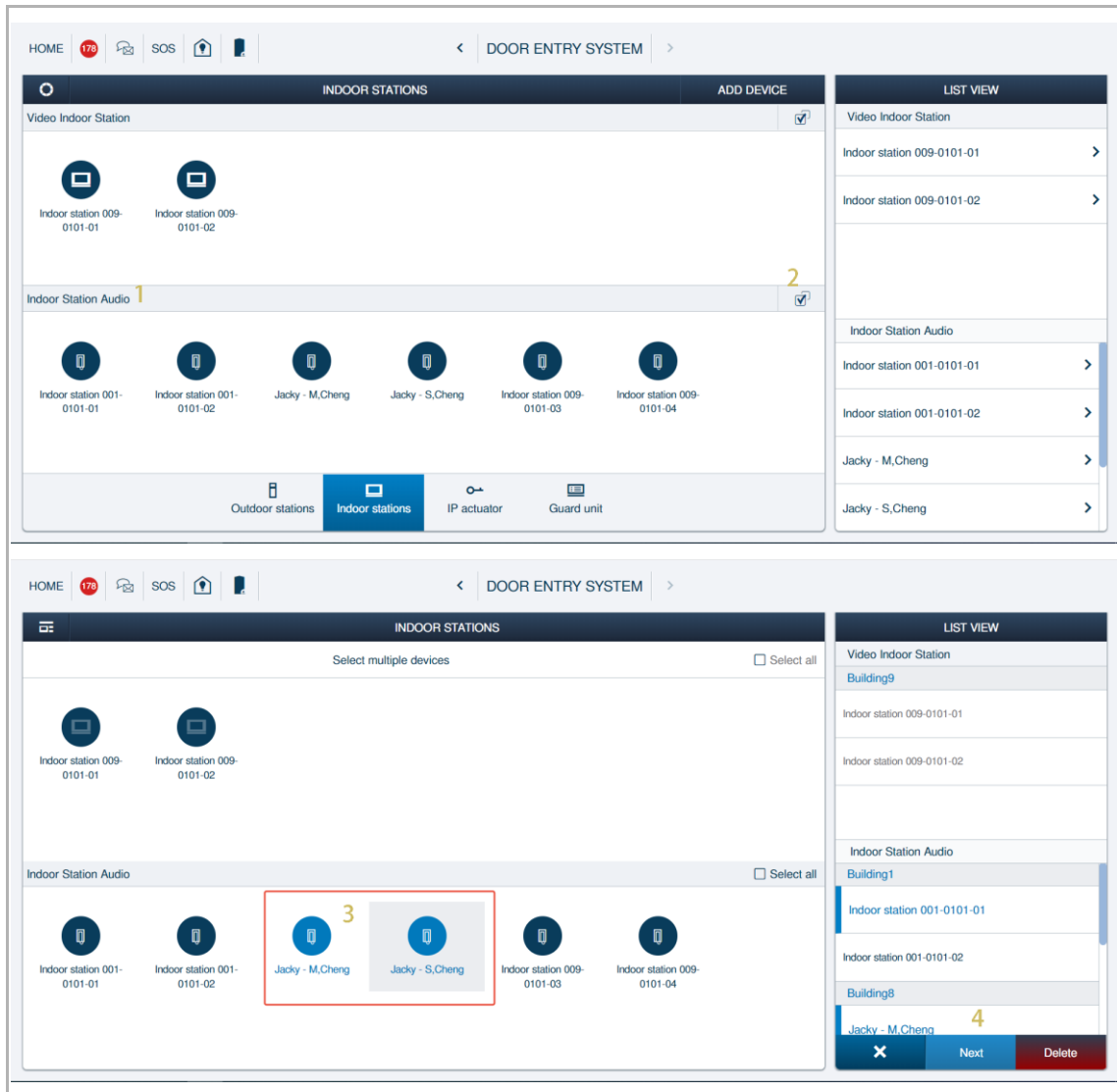

- [5] Select the designated function and carry on the same setting for multiple devices.
- [6] Click "Save".

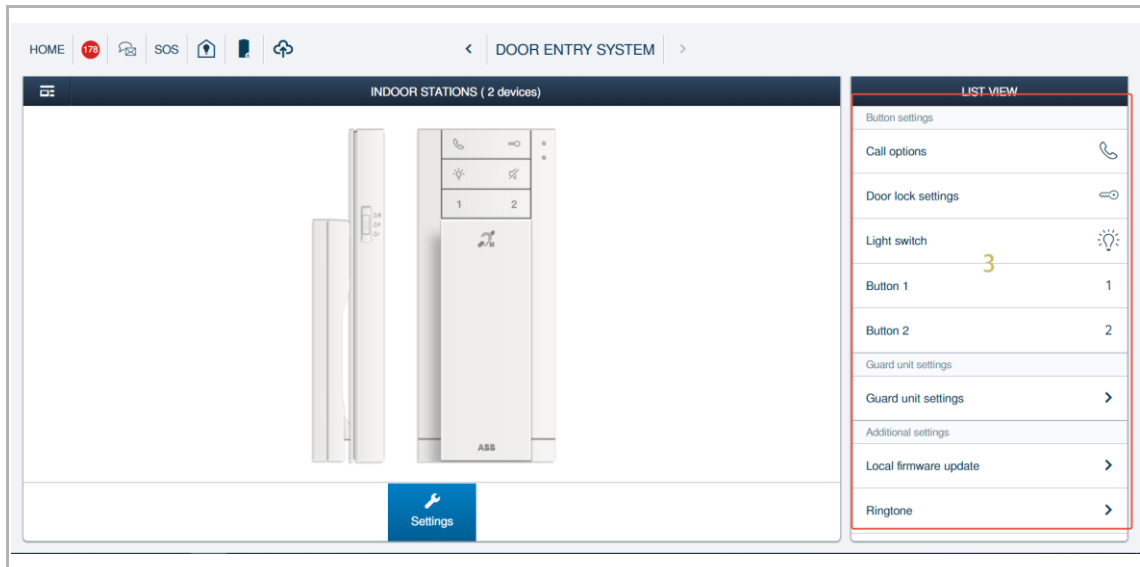

### 8.1.18 SIP client settings

Audio IP needs to be configured before using SIP function.

Please follow the steps below:

- [1] On the designated Audio IP "Settings" screen, click "SIP client settings".
- [2] The following settings will be filled automatically when "Smart Access Point" is enabled as an SIP server and Audio IP has obtained the certification from "Smart Access Point".
  - SIP account
  - SIP server
  - Communication protocol
  - Transport protocol

The image displays two screenshots of the 'SIP client settings' configuration screen. The top screenshot shows the 'LIST VIEW' menu with 'SIP client settings' highlighted. The bottom screenshot shows the 'Advanced settings' section with the following fields:

- Advanced settings
- SIP account
- User name: 0090202
- Password: [masked]
- SIP server: 2
- IP address: 10.0.0.1
- Port: 5060
- SIP protocol:  UDP  TCP  TLS
- Transport protocol:  sRTP  RTP

The 'Save' button is visible at the bottom right of the configuration screen.

## 8.2 Setting on local device

### 8.2.1 Ring volume setting



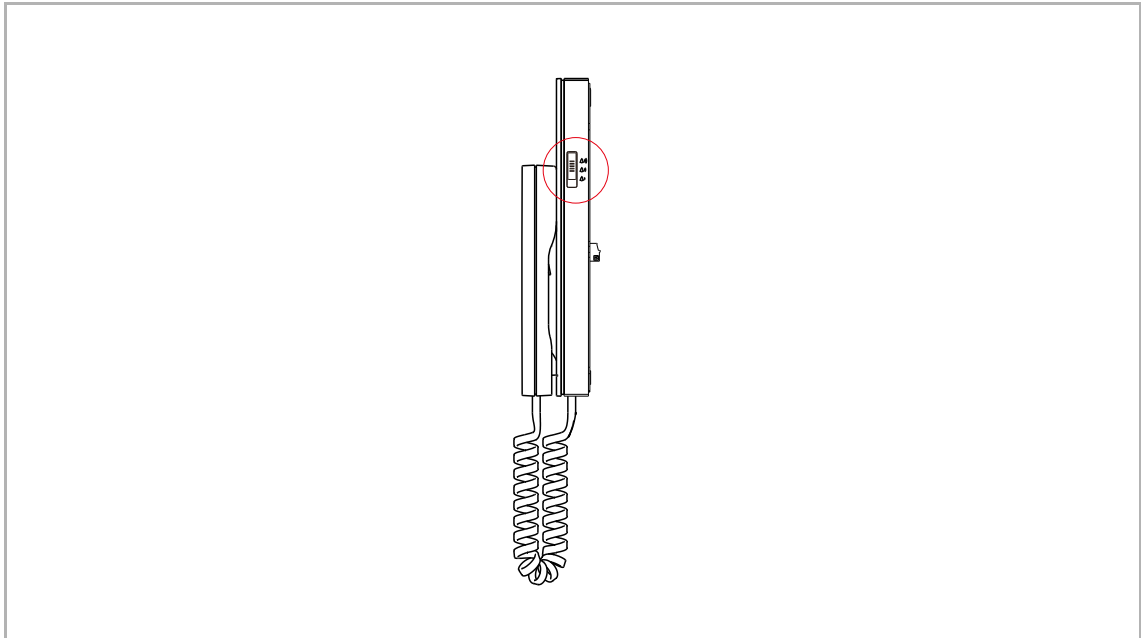

Adjust the three-level selector (maximum/medium/low) to set the ringtone volume.



## 8.2.2 Ringtone setting

### Changing Outdoor station ringtone



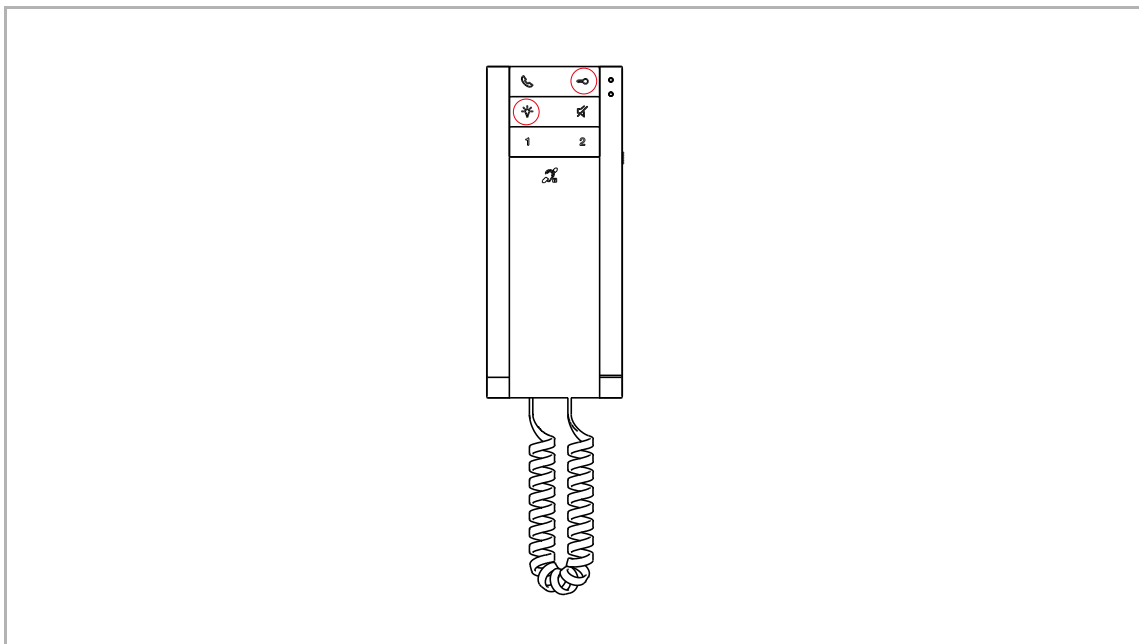

Please follow the steps below:

- [1] In standby status, press and hold the light button  for 5 seconds to enter the setting mode (Red LED and blue LED flash slowly at the same time).
- [2] Press the lock button  to play the current ringtone.
- [3] Press the lock button  repeatedly until the designated ringtone sounds (5 types of ringtones can be selected).
- [4] Press and hold the light button  for 5 seconds to exit the setting mode (Red LED and blue LED turn off at the same time).





## Changing Doorbell ringtone

Please follow the steps below:

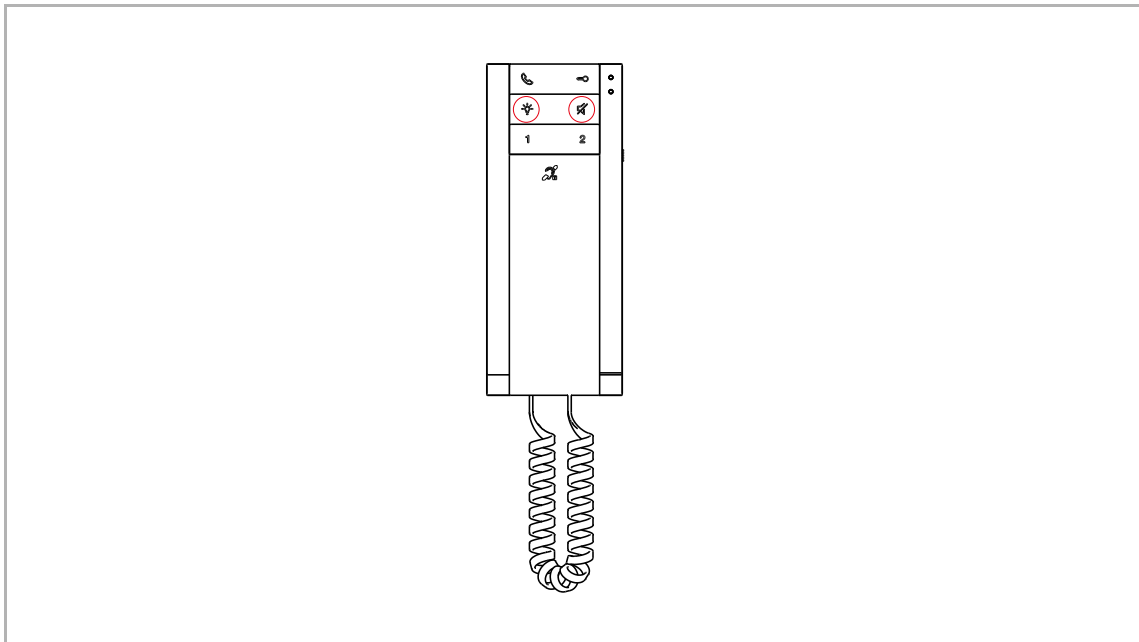
- [1] In standby status, press and hold the light button  for 5 seconds to enter the setting mode (Red LED and blue LED flash slowly at the same time).
- [2] Press the mute button  to play the current ringtone.
- [3] Press the mute button  repeatedly until the designated ringtone sounds (5 types of ringtones can be selected).
- [4] Press and hold the light button  for 5 seconds to exit the setting mode (Red LED and blue LED turn off at the same time).



### 8.2.3 Talking volume setting

During communication, press and hold the light button  for 5 seconds to access the setting mode and then select the designated volume by pressing this button repeatedly (5 levels of volume can be selected). Press and hold the light button  for 5 seconds again to exit the setting.

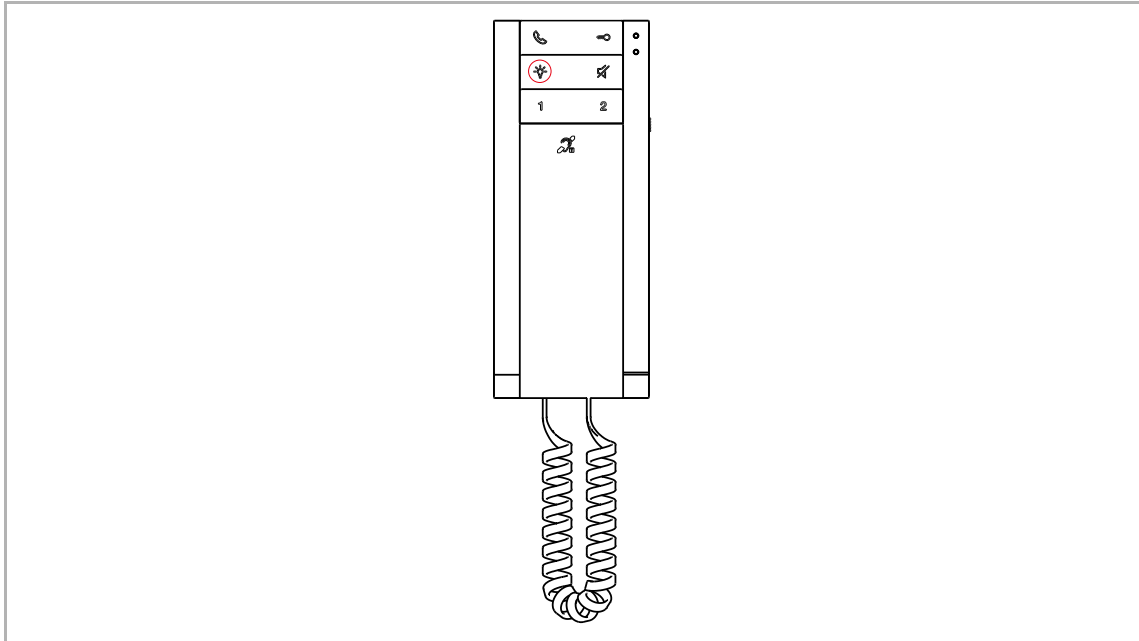

### 8.2.4 Auto unlock setting

The "Automatic unlock" function means the door will be unlocked automatically during a call request. This function will be disabled automatically after 10 hours.

In standby status, press and hold the lock button for 10 seconds to enable the "Automatic unlock" function. Red LED illuminates to indicate that the "Automatic unlock" function is enabled. The same operation will disable the "Automatic unlock" function and Red LED will turn off.

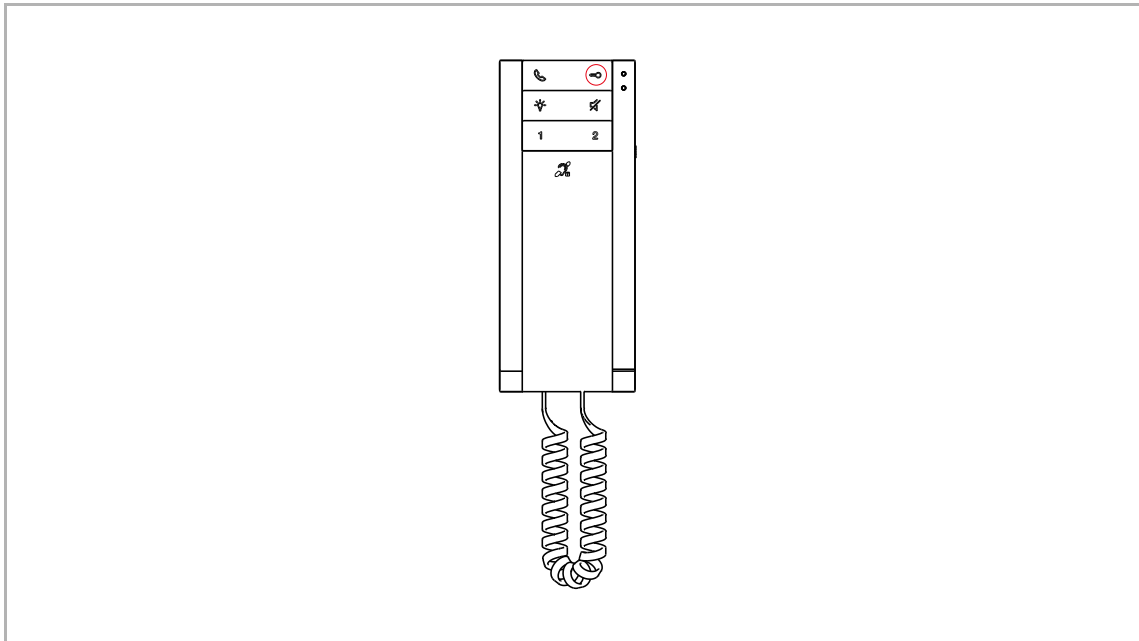
**Note**

Slave Audio IP does not support "Automatic unlock" function.

### 8.2.5 Resetting the device

Please follow the steps below:

- [1] Disassemble the upper part from the bottom part by using a screwdriver.
- [2] Pressing and holding the reset button (on the upper part) 3 seconds to reset the device.

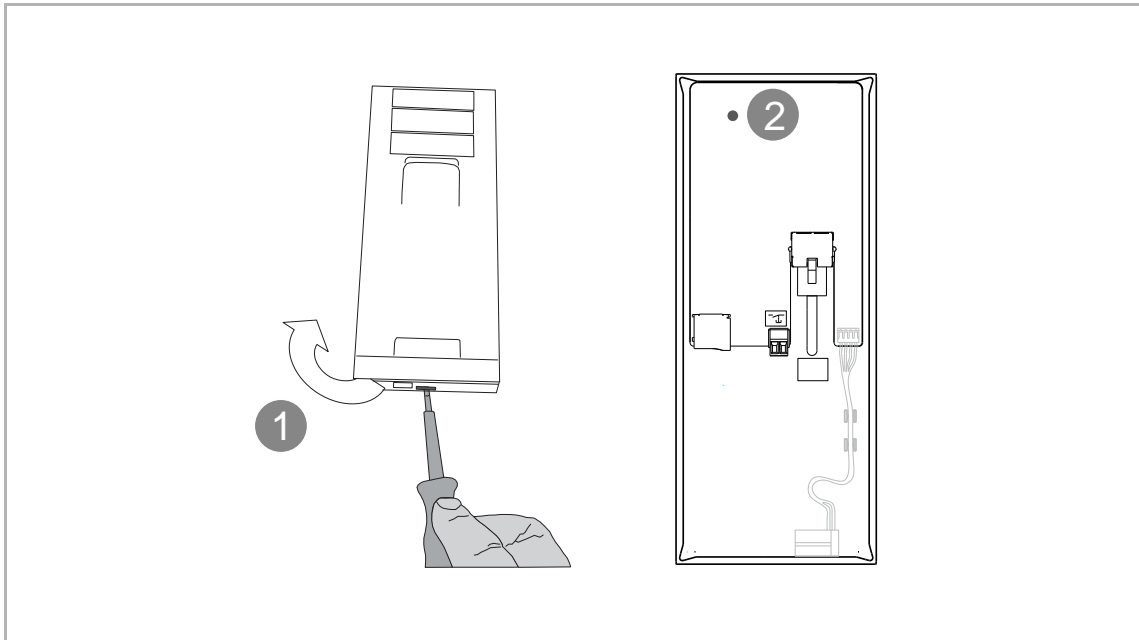



#### Note

Building address, signature and all parameters will be restored to factory settings after the reset operation.

## 9 Operation

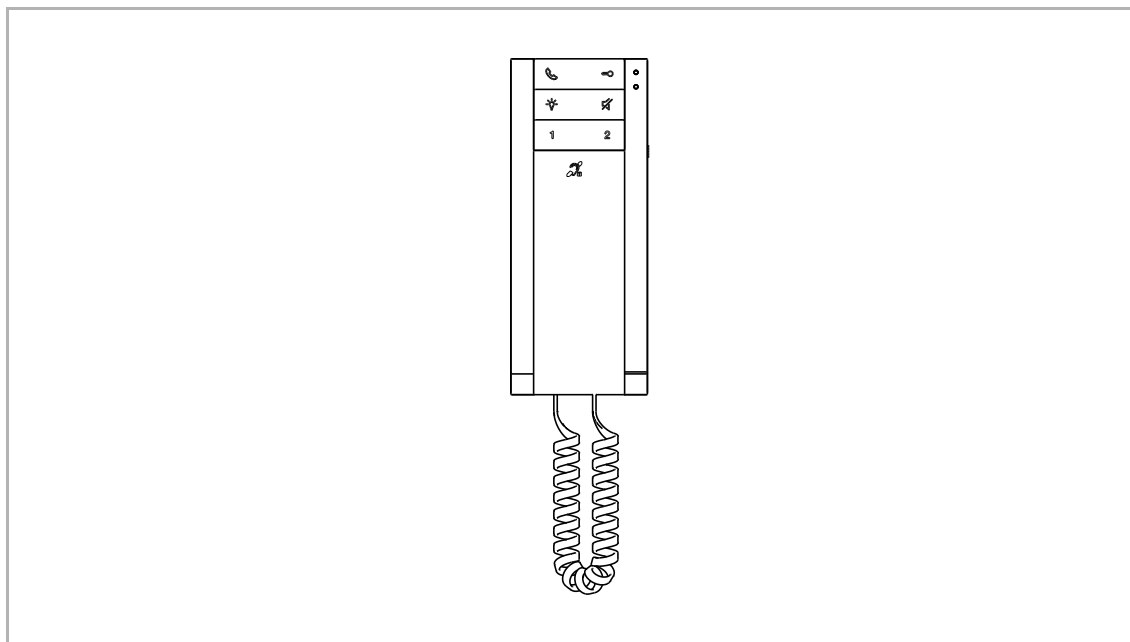
### 9.1.1 Incoming call



- During a call request, pick up the handset within 30 seconds to accept the call.
- During communication, hang up the handset to terminate the call.
- During a call request, press the mute button  to mute the ringtone.

9.1.2 Intercom

1. Intercom via call button

**Precondition**

Call button should be set before use. Please see chapter 8.1.6 “Call button setting” on page 25.

**Operation**

In standby status, pick up the handset and press the call button  to initiate an intercom.

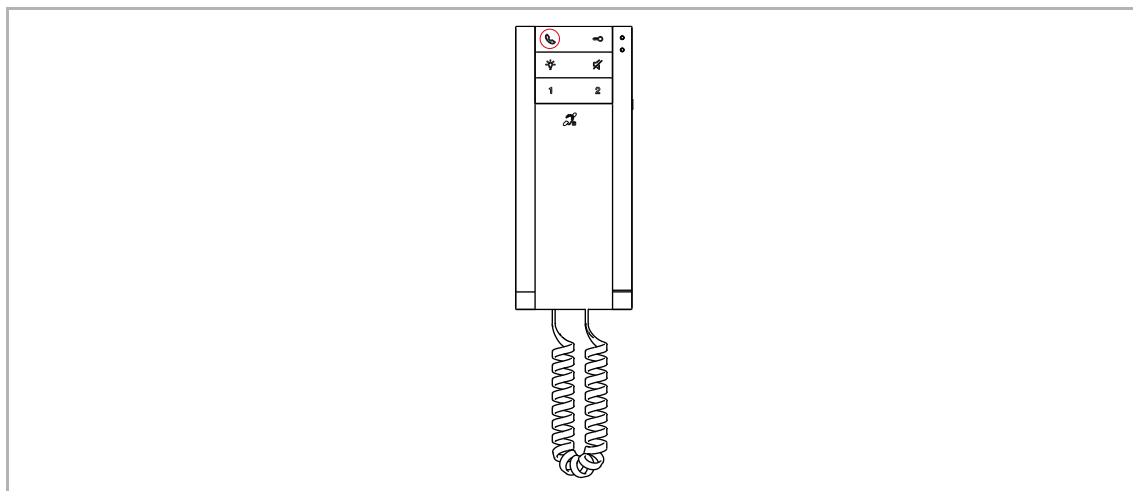

2. Intercom via programmed button

**Precondition**

Programmed button should be set before use. Please see chapter 8.1.9 “Programmed button setting” on page 30.

**Operation**

In standby status, pick up the handset and press the designated programmed button to initiate an intercom.

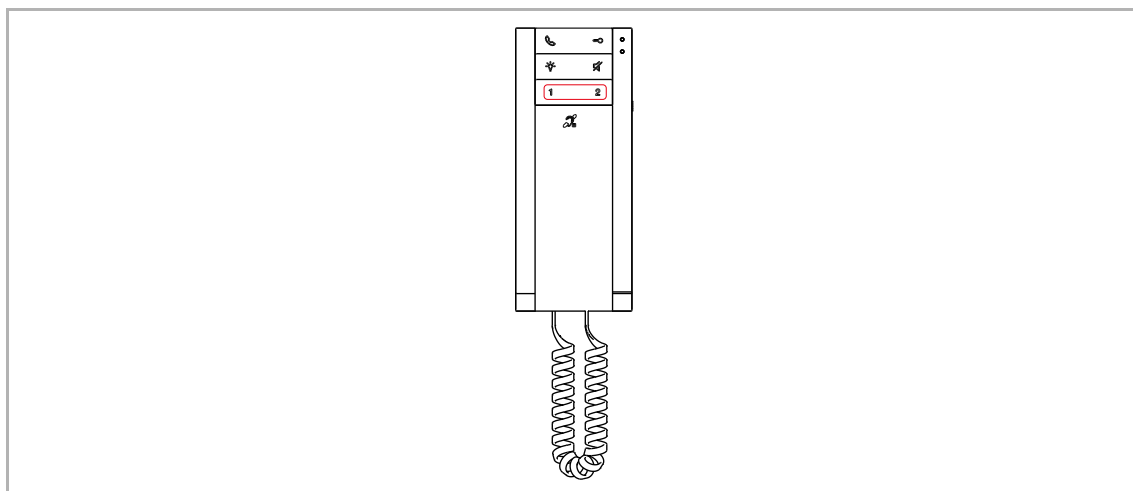

### 9.1.3 Unlock

1. Unlock via unlock button

**Precondition**

Unlock button should be set before use. Please see chapter 8.1.7 “Unlock button setting” on page 27.

**Operation**

In standby status, press the unlock button  to release the designated lock.

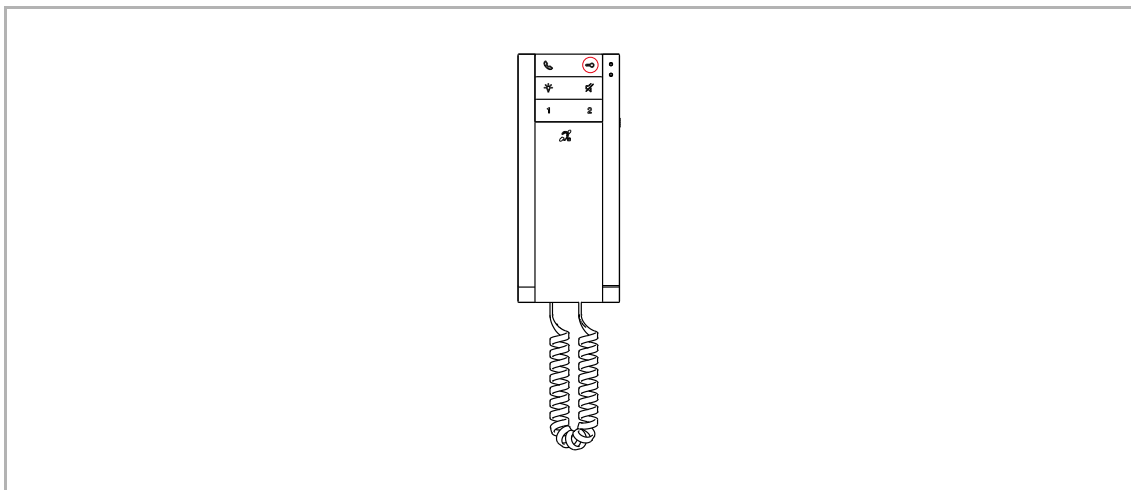

2. Unlock via programmed button

**Precondition**

Programmed button should be set before use. Please see chapter 8.1.9 “Programmed button setting” on page 30.

**Operation**

In standby status, press the designated programmed button to release the designated lock.

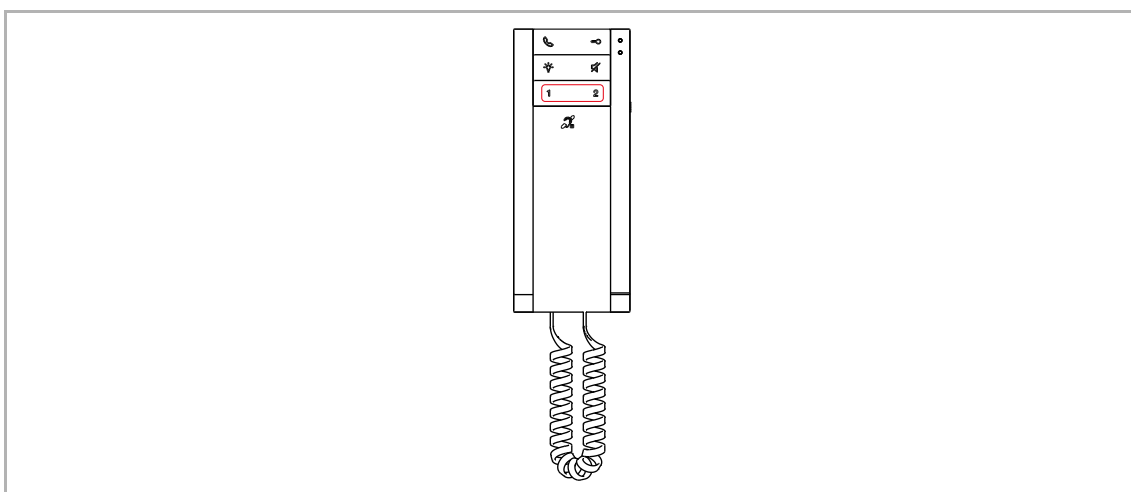

### 9.1.4 Turn on a light

1. Turn on light via light button

**Precondition**

Light button should be set before use. Please see chapter 8.1.8 "Light button setting" on page 29.

**Operation**

In standby status, press the light button  to turn on the designated light.

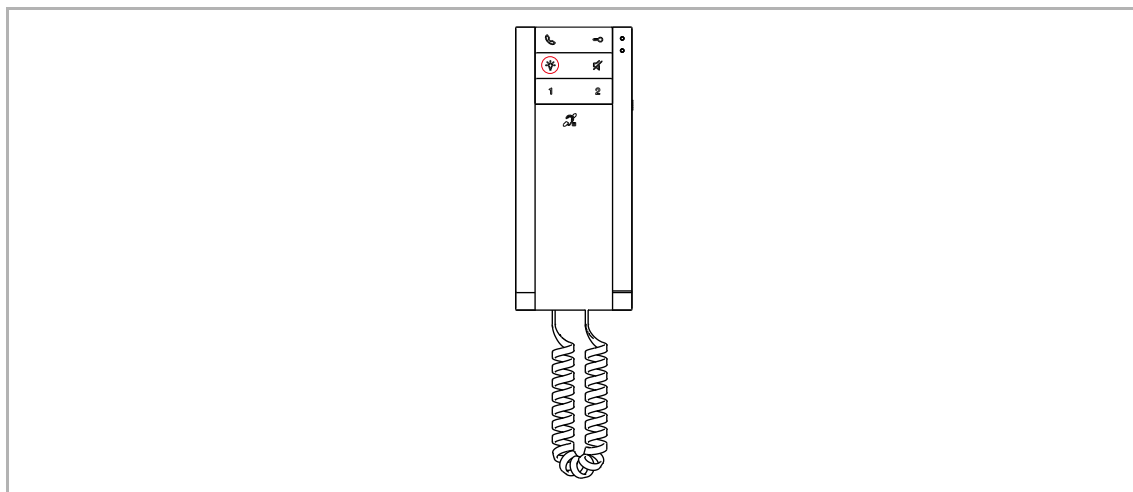

2. Turn on light via programmed button

**Precondition**

Programmed button should be set to "Turn on light" before use. Please see chapter 8.1.9 "Programmed button setting" on page 30.

**Operation**

In standby status, press the designated programmed button to turn on the designated light.

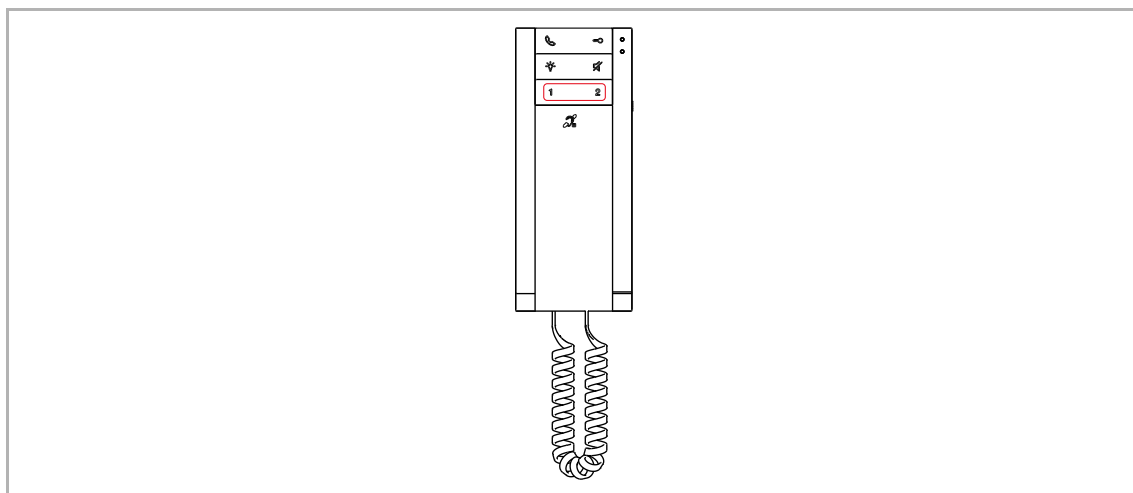

### 9.1.5 SOS

#### Precondition

Programmed button should be set to "SOS call" before use. Please see chapter 8.1.9 "Programmed button setting" on page 30.

#### Operation

In standby status, press and hold the designated programmed button at least 2 seconds to send an alarm to Guard unit or "Smart Access Point".

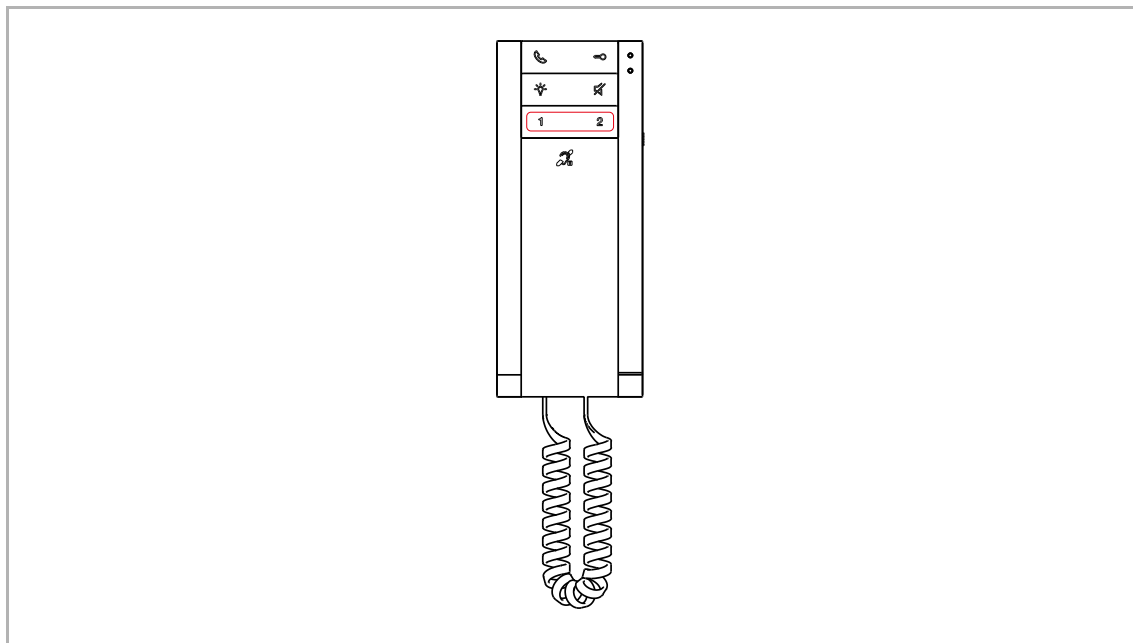

## 10 Cyber security

### 10.1 Disclaimer

This product H82001-W-03 is designed to be connected and to communicate information and data via a network interface, which should be connected to a secure network. It is the customer's sole responsibility to provide and continuously ensure a secure connection between the product and customer's network or any other network (as the case may be) and to establish and maintain appropriate measures (such as but not limited to the installation of firewalls, application of authentication measures, encryption of data, installation of antivirus programs, etc.) to protect the H82001-W-03 product, the network, its system and interfaces against any kind of security breaches, unauthorized access, interference, intrusion, leakage and/or theft of data or information. Busch-Jaeger Ltd and its affiliates are not liable for damages and/or losses related to such security breaches, unauthorized access, interference, intrusion, leakage and/or theft of data or information.

Although Busch-Jaeger provides functionality testing on the products and updates that we release, you should institute your own testing program for any product updates or other major system updates (to include but not limited to code changes, configuration file changes, third party software updates or patches, hardware change out, etc.) to ensure that the security measures that you have implemented have not been compromised and system functionality in your environment is as expected.

## 10.2 Performance and service

### Network performance

Type	Value
Ethernet	36 Mbps (53,568 packets/s)
ARP	17 Mbps (25,296 packets/s)
ICMP	14 Mbps (20,832 packets/s)
IP	22 Mbps (32,736 packets/sec)
UDP	22 Mbps (32,736 packets/sec)

### Port and service

Port	Service	Purpose
5060	UDP	To be used by sip client.
5061	TCP	To be used by sip server
5070	UDP	To be used by sip client.
5070	TCP	To be used by sip server
50602	UDP	To be used by sip server
7777	TCP/UDP	To be used for device management
7005	TCP	To be used for connectivity detection
7006	TCP	To be used for connectivity detection
10777	TLS	Secure channel for device management

## 10.3 Deployment guideline

Please do not install it within a public place and ensure that physical access to the devices is granted only to trusted personal.

All devices on one system shall be signed by a public CA at the commissioning stage; in normal situations, the management software functions as the CA.

If the user decides to remove the device from the system, the user shall reset the device to the factory settings to remove all the configuration data and sensitive data on the device. This will prevent sensitive data leaks.

It is recommended to apply "MAC filter" and "Rate limiter" in the switch to prevent DOS attack.

#### **10.4 Upgrading**

The device supports firmware updating via "Smart Access Point". In this mode, a signature file will be used to verify the authentication and integrity of firmware.

Users are strongly advised not to upgrade their devices using firmware that has not been officially released by Busch-Jaeger.

#### **10.5 Malware prevention solution**

All official firmware versions of the device are scanned for malware before release, and the firmware upgrade mechanism ensures that only the legally released firmware can be upgraded.

While Busch-Jaeger provides maximum security for its products, it strongly advises users not to disassemble the devices or even replace components, which could lead to malware intrusion.

## 11 Notice

We reserve the right to at all times make technical changes as well as changes to the contents of this document without prior notice.

The detailed specifications agreed to at the time of ordering apply to all orders. Busch-Jaeger accepts no responsibility for possible errors or incompleteness in this document.

We reserve all rights to this document and the topics and illustrations contained therein. The document and its contents, or excerpts thereof, must not be reproduced, transmitted or reused by third parties without prior written consent by Busch-Jaeger.

**Service**

ABB AG – BUSCH-JAEGER  
Freisenbergstr. 2, DE-58513 Lüdenscheid

BUSCH-JAEGER.de  
[go.abb/contact](https://go.abb/contact)