

DC DRIVES

ABB industrial drives

DCS880 modules 20 A to 5200 A
Catalog



Scalability.
Reliability.
Functional safety.
DCS880 series.

Table of contents

4	Creating a safer environment
6	What does all-compatible
8	Cost and time savings
9	Flexibility to serve every application
10	Type code
11	Environmental conditions
12	DCS880 power converter modules
13	Ratings, types and voltages
16	Components overview of converter
20	Standard interface and extensions
22	Interface option modules
23	Communication option modules
24	Flexible connectivity
25	Cost and time savings
26	Common features
27	Standard DCS880 drives software
28	The all-compatible DCS880 series
29	Drive programming
30	Intuitive human-machine interface
31	PC tool for easy startup and maintenance
32	External field supply
34	Fuse connections
35	Line reactors L1
36	High power configurations
37	A lifetime of peak performance
38	Services to match your needs
39	Drives service
40	ABB Automation products
41	Save time, ease troubleshooting
42	Plus codes

Creating a safer environment without compromising productivity

The all-compatible drives are designed to provide customers across industries and applications with unprecedented levels of compatibility and flexibility.

DC drives

Our DCS880 industrial drives are customized to meet the precise needs of industries such as oil and gas, mining, metals, cement, non motoric, material handling, pulp and paper, rubber and plastics, marine, water and wastewater, food and beverage and automotive. They control a wide range of applications such as cranes, extruders, winches, winders, conveyors, mixers, millstands, centrifuges, test benches, elevators, electrolysis, kiln.



DC motor control

ABB's motor control technology provides precise speed and torque control for all applications.



Adaptive programming

Adaptive programming is ideal for creating simple control programs for various applications. It does not require expertise in programming and is offered as a standard in all-compatible drives.



Removable memory unit

Stores all the firmware and parameter configurations in an easily replaceable and simple-to-install module.



All typical DC configurations

DCS880 standard firmware supports all standard configurations present in DC drive applications such as 6-pulse, 12-pulse parallel, serial and serial sequential, 24-pulse, M3, M6 and field reversal.



Remote monitoring

With a built-in web server, NETA-21 makes worldwide access easy for industry applications.



Drive-to-drive link (D2D)

Allows fast communication between drives including master-follower configurations as standard.



Drive application programming

Customizable to meet the precise application needs based on IEC 61131-3. Uses the same programming environment and is also easy to integrate with other ABB components such as PLCs and HMIs.

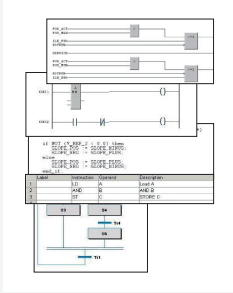

Safety

DCS880 offers safe torque off (STO) built in as a standard. It can be used in safety functions up to SIL3 /PLe enabling you to achieve every safety requirement.



Drives going mobile

We offer several smartphone applications to ease and enhance the use of ABB drives. These tools provide a user-friendly and easy-to-use approach for the commissioning, servicing and use of ABB drives.



Intuitive human-machine interface

User-friendly, high-contrast and high-resolution display enabling easy navigation in multiple languages. Allows USB and Bluetooth connection.



Startup and maintenance tool

Drive composer PC tool for drive startup, configuration and daily use and process tuning. PC tool is connected to the drive via Ethernet or USB interface.



Communication with all major automation networks

Fieldbus adapters enable connectivity with all major automation networks.



Flexible product configurations

Drives are built to order with a wide range of options. Ready made cabinets with or without transformer are available up to 20 MW.



Extended connectivity

In addition to the standard interfaces, the drive has three built-in slots for additional input/output extension modules and speed feedback interfaces.

What does all-compatible mean for you?

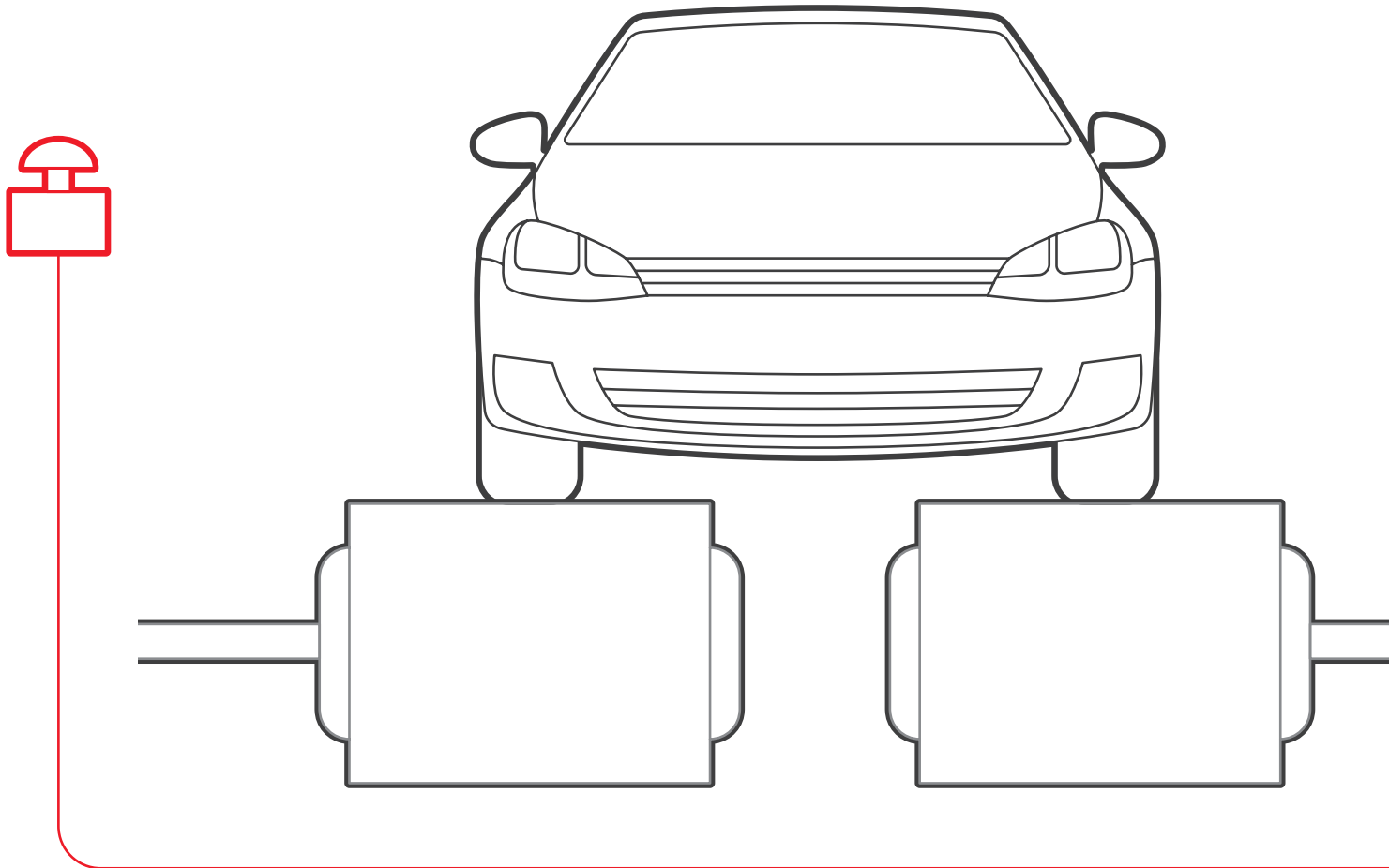

Business all-compatible

The all-compatible drives are not just equipment – they are part of your business strategy. Providing better control over your processes, our drives mean lower energy consumption, improved productivity, flexibility and ease of use. In addition to drives, we offer a wide range of products and services to support your business. With offices in over 90 countries and a global technical partner network, we are in a good position to offer technical advice and local support, worldwide.

Process all-compatible

The drives are compatible with all kinds of processes. They control virtually any type of DC motor, provide extensive input / output connectivity and support all major fieldbus protocols. The drives cover a wide voltage and power range. Control performance is scalable from basic to demanding applications. The flexibility and scalability of the drives enable one drive platform to control virtually any application or process, making your drive selection easy.

Environment all-compatible

There is increased demand for industries to reduce their impact on the environment. Our drives can help you reduce energy consumption in a wide range of applications. Keeping and upgrading of existing equipment reduces the impact a modernization of a production line would have in terms of use of materials and energy for production and transport of new equipment.

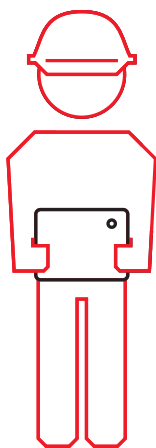
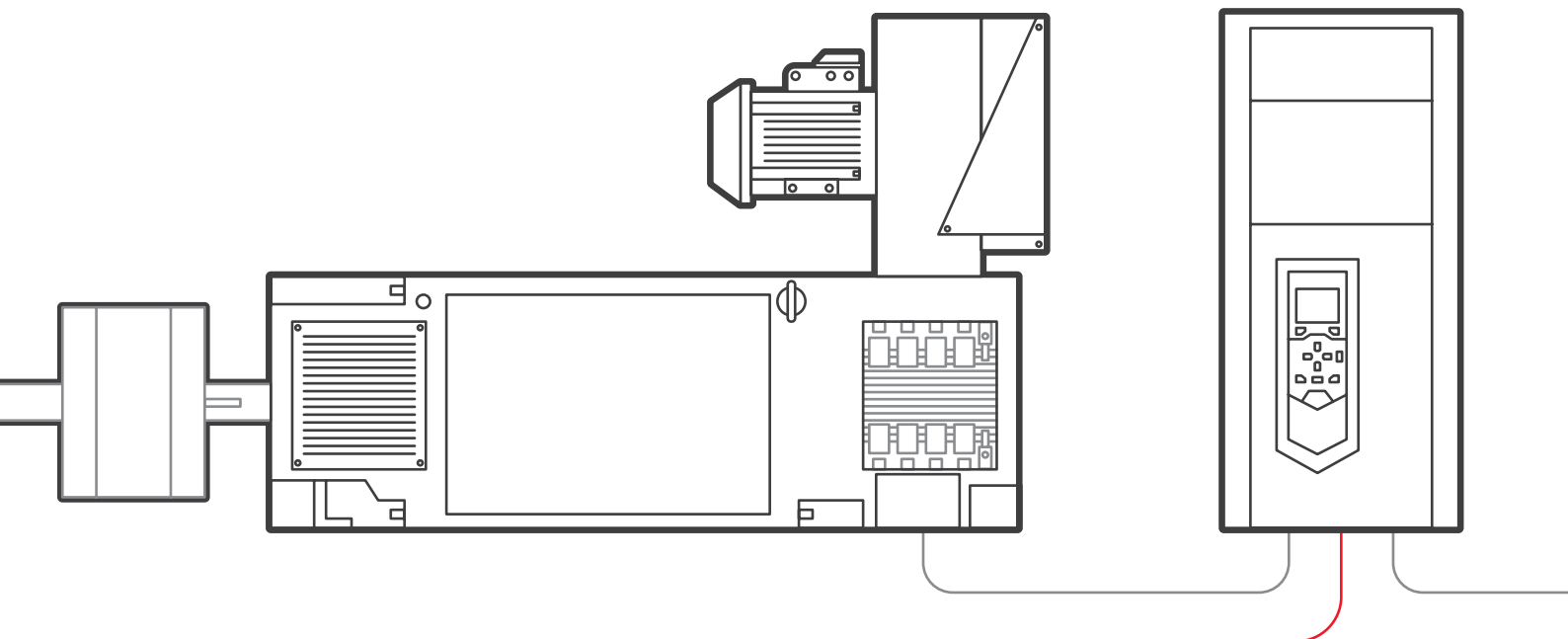
**Human all-compatible**

All our drives share easy-to-use interfaces, saving you time during drive commissioning and maintenance. When you have learned it once, you can use it with all the drives in our all-compatible drives portfolio.

The control panel supports multiple different languages. With the PC tool, you get extensive drive monitoring capabilities and quick access to the drive settings. Integrated and certified safety features provide safety for machine operators.

To further improve the user experience, we have developed mobile apps that can be utilized in interacting with the drive. These apps give you an easy graphical interface for management, maintenance and service of your drives.

Cost and time savings with Drive-based functional safety

DCS880 drives have a safe torque off (STO) function built in as a standard. With our DCS880 drive, you can achieve SIL3 /PLe safety level with certified safety functions modules. The safety module is easy to integrate inside the drive and offers you several safety functions. Integration with automation systems is quick and reliable using PROFI-safe connectivity.

STO built in

The SIL3 /PLe certified Safe Torque OFF (STO) function prevents the motor from generating torque. This allows machine interaction to be performed without complete shut down of the machine.

Scalable safety with PROFI-safe and safety PLC

The safety functionality can be scaled to your needs. From a safety module integrated into a single relay to a complete safety system with a PROFI-safe and a safety PLC, eg, AC500-S.

Safely limited speed

The SIL3 /PLe certified safely-limited speed (SLS) function prevents the motor from exceeding a defined speed limit. This allows machine interaction to be performed at a safe speed without stopping the process.

TÜV-certified safety design tool

Functional safety design tool (FSDT-01) is used for machinery safety. It helps to increase the safety of users in the vicinity of machines. You can perform functional safety modeling, design, calculations and verification for machine functional safety.

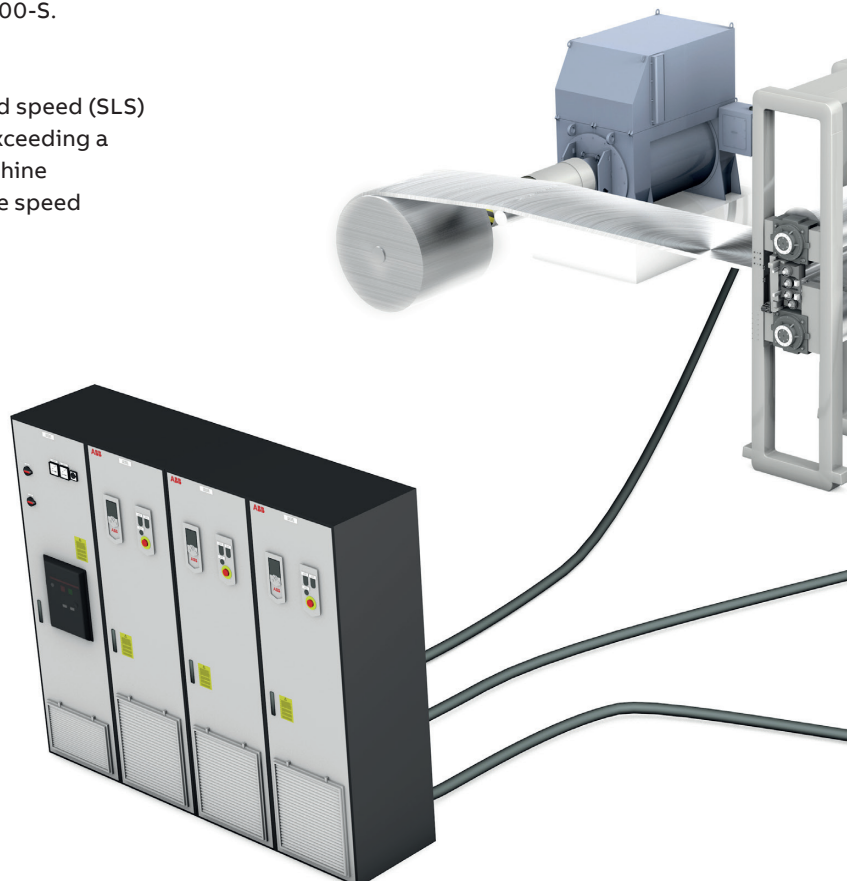

Flexibility to serve every application

with Drive-based adaptive and application programming

The built in PLC capability of the DCS880 provides you a possibility to customize the drive for your application without the cost of extra hardware. As programming is based on the IEC 61131-3 standard used in AC500 PLCs and by many other PLC vendors, you do not need to re-train your staff. By decentralizing your machine control closer to the process, you achieve better control performance.

Adaptive programming

Adaptive programming is ideal for creating simple control programs for various applications. By graphical drag and drop programming it does not require expertise in programming and is offered as standard in all-compatible drives.

Application programming

Application programming makes it possible for system integrators and machine builders to integrate their desired functionality and know-how directly into the drive. Drive application programming is accomplished with the ABB Drive Application Builder tool and is based on the well-known IEC 61131-3 standard. This standard makes it possible to start program development with minimal training and to transfer customized programs to other platforms.

Automation Builder

Automation Builder is an integrated software suite for automation engineering, which makes programming industry devices such as PLCs, robots and human-machine interfaces (HMIs) easy using one integrated engineering suite. Automation Builder is used both for engineering devices and entire automation projects.

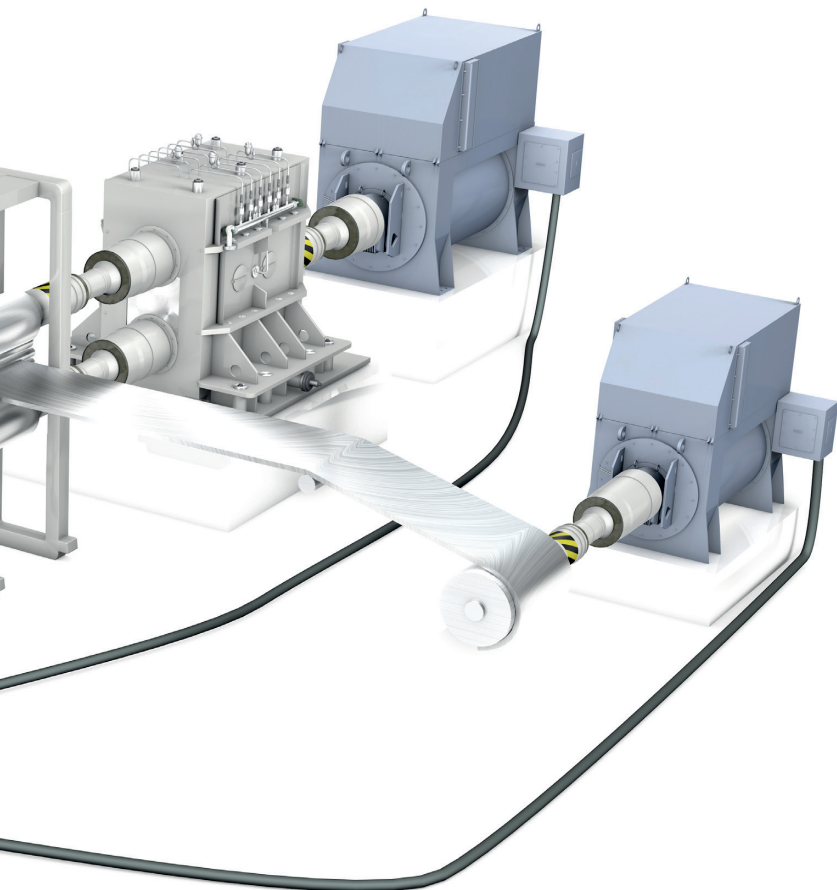

Type code



Type code:

DCS880 - S01 - 0680 - 04 X 0 + L508

Product family

DCS880 = DC converter

Product type

S0 = Standard converter module
 R0 = Rebuild kit
 A0 = Enclosed converter
 E0 = Panel solution

Bridge type

1 = Single bridge (2-Q)
 2 = 2 anti-parallel bridges (4-Q)

Rated DC current

0680 = e.g. 680 A_{DC} (IP00)

Rated AC voltage

04 = 100 ... 415 V_{AC}
 05 = 100 ... 525 V_{AC}
 06 = 270 ... 600 V_{AC}
 07 = 315 ... 690 V_{AC}
 08 = 360 ... 800 V_{AC}
 10 = 450 ... 990 V_{AC}
 12 = 540 ... 1190 V_{AC}

Power connection (H8)

X = Standard (H1 ... H7)
 R = Right side (H8)
 L = Left side (H8)

Revision Code

0 = 1st generation

Plug-in options

External options

Environmental conditions

System connection	
Voltage, 3-phase:	100 to 1000 V acc. to IEC 60038
Voltage deviation:	±10 % continuous; ±15 % short-time *
Rated frequency:	50 Hz or 60 Hz
Static frequency deviation:	50 Hz ± 2 %; 60 Hz ± 2 %
Dynamic: frequency range:	50 Hz: ± 5 Hz; 60 Hz: ± 5 Hz
df/dt:	17 % / s
* = 0.5 to 30 cycles.	
Please note: Special consideration must be taken for voltage deviation in regenerative mode.	
Degree of protection	
Converter module and options (line chokes, fuse holder, field supply unit, etc.):	IP 00
Enclosed converters:	IP 21/42/54
Paint finish	
Converter module:	Body RAL 7012; Cover RAL 9017 & RAL 9002

Sound pressure level

Size	Sound pressure level L _p (1 m distance)	Vibrations
	as module	as module
H1	55 dBA	
H2	55 dBA	
H3	60 dBA	3 mm, 2 ... 9 Hz
H4	66 ... 70 dBA, depending on fan	1 g, 9 ... 200 Hz
H5	75 dBA	
H6	73 dBA	0.3 mm, 2 ... 9 Hz
H7	75 dBA	0.1 g, 9 ... 200 Hz
H8	82 dBA	

UK Legislation - UKCA

In UK the system components fulfil the following regulations.

DCS880-S01/S02 modules sizes H1 ... H8	
Electrical Equipment (Safety) Regulations	2016 UK Safety
Electromagnetic Compatibility Regulations	2016 UK EMC
Supply of Machinery (Safety) Regulations	2008 UK Machinery
Restriction of the Use of Certain Hazardous Substances Regulations	2012 UK RoHS

Regulatory compliance

The converter module and enclosed converter components are designed for use in industrial environments. In EEA countries, the components fulfil the requirements of the EU directives, see table below.

European union directive	Manufacturer's assurance	Harmonized standards Converter module
Machinery Directive		
2006/42/EU	Declaration of Conformity	EN 61800-5-2:2017 EN 62061:2005 + Cor.:2010 + A1:2013 + A2:2015 EN ISO 13849-1:2015 EN ISO 13849-2:2012 EN 61508: 2010, parts 1-7 EN 60204-1:2018 EN ISO 14118:2018
Low Voltage Directive		
2014/35/EU	Declaration of Conformity	EN 61800-5-1:2007 + A1:2017 + A11:2021
EMC Directive		
2014/30/EU	Declaration of Conformity	EN IEC 61800-3:2018
RoHS Directive		
2011/65/EU & 2012/19/EU	Declaration of Conformity	
Relevant standards for DC		
	Declaration of Conformity	EN 60146-1-1:2010 EN 61800-1:1998

Environmental limit values	
Permissible cooling air temperat.	
• at converter module air inlet:	0 to +55°C
with rated DC current:	0 to +40°C
with different DC current:	+30 to +55°C (depending on altitude / cooling air temp.)
• Options:	0 to +40°C
Relative humidity (at 5 ... +40°C):	5 to 95 %, no condensation
Relative humidity (at 0 ... +5°C):	5 to 50 %, no condensation
Change of the ambient temp.:	< 0.5°C / minute
Storage temperature:	-40 to +55°C
Transport temperature:	-40 to +70°C
Pollution degree (IEC 60664-1, IEC 60439-1):	2
Site elevation	
<1000 m above M.S.L.:	100 %, without current reduction
>1000 m above M.S.L.:	with current reduction

North American Standards

In North America the system components fulfil the requirements of the tables below.

DCS880-S01/S02 module sizes H1 ... H8		
	US	Canada
Standard	UL 61800-5-1	CAN/CSA 22.2 No. 274-17
Certificate no.	U8 045204 0008 Rev. 00 (TÜV-SÜD)	

Field exciter DCF803/804-0035, -0050, -0060		
	US	Canada
Standard	UL 61800-5-1	CAN/CSA 22.2 No. 274-17
Certificate no.	U8V 045204 00011 Rev. 00 (TÜV-SÜD)	
Max. AC voltage	500 V _{AC}	500 V _{AC}

DCS880 power converter modules

General

The power converter modules DCS880-S have the protection class IP00 and are to be mounted in a cubicle or finger protected area. There are different sizes (H1 - H8), graduated in terms of current and voltage ranges.

All units are equipped with the DCS880 Control Panel. It can be snapped into place on the power converter module or installed in the switchgear cubicle door by means of a mounting kit.

Accessories such as external fuses, line reactors etc. are also available, to complete the drive system.

All converter modules up to 525 V and 1000 A (H1 ... H4) are equipped with field exciters.

The power section of the converters is available as single (2-Q) bridge or double (4-Q) bridge. 4-Q drives are required for regenerative braking. 4-Q drives can be built by:

- Double (4-Q) armature bridge or
- Single (2-Q) armature bridge plus a double (4-Q) field converter bridge

The bridge type has an influence on the maximum output voltage of the converter. See table below.

System connection voltage	DC voltage (recommended)		Ideal DC voltage without load	Recommended DCS880 voltage class
U_{VN} [V]	$U_{dmax\ 2-Q}$ [V]	$U_{dmax\ 4-Q}$ [V]	U_{dilo} [V]	
230	265	240	310	04
380	440	395	510	04
400	465	415	540	04
415	480	430	560	04
440	510	455	590	05
460	530	480	620	05
480	555	500	640	05
500	580	520	670	05
525	610	545	700	05
575	670	600	770	06
600	700	625	810	06
660	765	685	890	07
690	800	720	930	07
800	915	820	1060	08
990	1160	1040	1350	10
1200	1380	1235	1590	12

Reference variables

The voltage characteristics are shown in the table beside. The DC voltage characteristics have been calculated using the following assumptions:

- U_{VN} = rated input terminal voltage, 3-phase
- Voltage tolerance $\pm 10\%$
- Internal voltage drop approx. 1 %
- If a deviation or a voltage drop has to be taken into consideration in compliance with IEC and VDE standards, the output voltage or the output current must be reduced by the actual factor according to the table on the right.

If armature voltages higher than recommended are requested, please check carefully, whether your system is still working under safe conditions. The maximum output voltage of a 4-Q drive can be increased up to the level of $U_{dmax\ 2-Q}$. Thus the torque reversal from motoring mode to generating mode increases up to 300 ms. This lowers the dynamics of the drive and is only recommended for non-dynamic applications (e.g. E-Stop function).

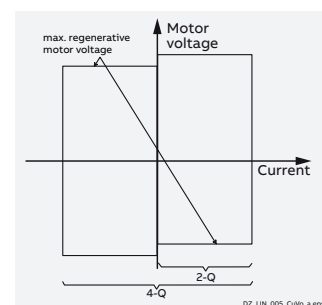
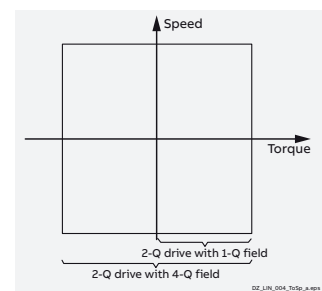

Ratings, types and voltages

Current ratings, dimensions and weights

Unit size	2-Q		4-Q		Supply voltage					Internal field current	Weight	Dimensions		
	rated Current	rated Current	400	500/525	600	690	800	990	1190			[V _{AC}]	[A]	[kg]
	DCS880-S01	DCS880-S02												
	I _{DC} [A]	I _{DC} [A]												
H1	20	25	●	●						0.3 ... 6	11	370.5 x 270 x 216	14.59 x 10.63 x 8.50	
	45	50	●	●						1 ... 12				
	65	75	●	●						1 ... 12				
	90	100	●	●						1 ... 12				
H2	135	150	●	●						1 ... 18	16	370.5 x 270 x 269	14.59 x 10.63 x 10.59	
	180	200	●	●						1 ... 18				
	225	250	●	●						1 ... 18				
	270	300	●	●						1 ... 18				
H3	290	320			●						25	459 x 270 x 313	18.08 x 10.63 x 12.32	
	315	350	●	●						2 ... 25				
	405	450	●	●						2 ... 25				
	470	520	●	●						2 ... 25				
H4	590	650			●						38	644 x 270 x 352	25.35 x 10.63 x 13.86	
	610	680	●	●						2 ... 30				
	740	820	●	●						2 ... 30				
	900	1000	●	●						2 ... 30				
H5	1190	1190	●	●						25 ²⁾	55	740.5 x 270 x 368	29.15 x 10.63 x 14.49	
H6	900	900			●	●				25 ²⁾	110	944 x 510 x 410	37.17 x 20.08 x 16.14	
	1200	1200	●	●						25 ²⁾				
	1500	1500	●	●	●	●				25 ²⁾				
	2000		●	●	●	●				25 ²⁾				
		2000	●	●						25 ²⁾				
H7	1900	1900					●							
	2050	2050		●	●	●					180	1750 x 458.2 x 409	68.90 x 18.04 x 16.10	
	2500	2500	●	●	●	●	●							
	3000	3000	●	●	●	●	●				7	370.5 x 270 x 144	14.59 x 10.63 x 5.67	
H8	2050	2050						●						
	2600	2600						●	●		315	1750 x 760 x 559	68.90 x 29.92 x 22.01	
	3300	3300	●	●	●	●	●	●	●					
	4000	4000	●	●	●	●	●	●	●		7	370.5 x 270 x 144	14.59 x 10.63 x 5.67	
	4800	4800			●	●	●							
	5200	5200	●	●										

2) FEX-425 internal field exciter as option



H1, H2

H3

H4

H5

H6

H7

H8

Current ratings

2-Q converters

The current ratings for the DCS880 with 50 Hz and 60 Hz supplies are given below. The symbols are described below the table. The characteristics are based on an ambient temperature of max. 40°C and an elevation of max. 1000 m a.s.l.

Unit type	I _{DC I}	P _{out} ²⁾	P _{out} ²⁾	Internal	Fan voltage	Air	P _{Loss}	Frame
2-Q converters	[A]	[kW]	[kW]	field current	[V _{AC}]	volume	[kW]	size
		400 V	500 V	[A]		[m ³ /h]	³⁾	
400 V / 500 V / 525 V		400 V						
DCS880-S01-0020-04/05	20	9	12	6	without fan		0.11	
DCS880-S01-0045-04/05	45	21	26	12		57	0.17	H1
DCS880-S01-0065-04/05	65	30	38	12	internal	57	0.22	
DCS880-S01-0090-04/05	90	42	52	12		57	0.28	
DCS880-S01-0135-04/05	135	63	78	18		170	0.38	H2
DCS880-S01-0180-04/05	180	84	104	18	internal	170	0.56	
DCS880-S01-0225-04/05	225	107	133	18		170	0.73	
DCS880-S01-0270-04/05	270	128	159	18		170	0.82	H3
DCS880-S01-0315-04/05	315	146	183	25	internal	170	0.91	
DCS880-S01-0405-04/05	405	188	235	25		170	1.12	
DCS880-S01-0470-04/05	470	218	280	25		255	1.32	H4
DCS880-S01-0610-04/05	610	284	354	30		388	1.76	
DCS880-S01-0740-04/05	740	344	429	30	230; 1-ph	388	2.14	
DCS880-S01-0900-04/05	900	418	522	30		425	2.68	H5
DCS880-S01-1190-04/05	1190 ⁴⁾	553	690	25 ¹⁾	230; 1-ph	918	5.00 ●	
DCS880-S01-1200-04/05	1200	558	696	25 ¹⁾		850	5.10 ●	
DCS880-S01-1500-04/05	1500	698	870	25 ¹⁾	230; 1-ph	850	5.30 ●	H6
DCS880-S01-2000-04/05	2000	930	1160	25 ¹⁾		850	6.60 ●	
DCS880-S01-2050-05	2050	953	1189	-	400; 3-ph; 50 Hz	1700	8.00 ●	
DCS880-S01-2500-04/05	2500	1163	1450	-	525; 3-ph; 50 Hz	1700	9.00 ●	H7
DCS880-S01-3000-04/05	3000	1395	1740	-	460; 3-ph; 60 Hz	1700	11.10 ●	
DCS880-S01-3300-04/05	3300	1535	1914	-		4500	11.70 ●	
DCS880-S01-4000-04/05	4000	1860	2320	-	400; 3-ph; 50 Hz	4500	13.00 ●	H8
DCS880-S01-5200-04/05	5200	2418	3016	-	460; 3-ph; 60 Hz	4500	19.00 ●	
600 V / 690 V		600 V						
DCS880-S01-0290-06	290	203		-	internal	170	0.91 ●	H3
DCS880-S01-0590-06	590	413		-	230; 1-ph	425	1.86 ●	H4
DCS880-S01-0900-06/07	900	630	720	25 ¹⁾		850	5.10 ●	H6
DCS880-S01-1500-06/07	1500	1050	1200	25 ¹⁾	230; 1-ph	850	6.30 ●	
DCS880-S01-2000-06/07	2000	1400	1600	25 ¹⁾		850	8.10 ●	
DCS880-S01-2050-06/07	2050	1435	1640	-	400; 3-ph; 50 Hz	1700	9.20 ●	H7
DCS880-S01-2500-06/07	2500	1750	2000	-	525; 3-ph; 50 Hz	1700	10.20 ●	
DCS880-S01-3000-06/07	3000	2100	2400	-	460; 3-ph; 60 Hz	1700	12.20 ●	
DCS880-S01-3300-06/07	3300	2310	2640	-		4500	13.10 ●	H8
DCS880-S01-4000-06/07	4000	2800	3200	-	400; 3-ph; 50 Hz	4500	15.10 ●	
DCS880-S01-4800-06/07	4800	3360	3840	-	460; 3-ph; 60 Hz	4500	19.50 ●	
800 V		800 V						
DCS880-S01-1900-08	1900	1739		-	400; 3-ph; 50 Hz	1500	9.00 ●	H7
DCS880-S01-2500-08	2500	2288		-	525; 3-ph; 50 Hz	1500	10.70 ●	
DCS880-S01-3000-08	3000	2745		-	460; 3-ph; 60 Hz	1500	12.70 ●	
DCS880-S01-3300-08	3300	3020		-		4500	13.40 ●	H8
DCS880-S01-4000-08	4000	3660		-	400; 3-ph; 50 Hz	4500	15.60 ●	
DCS880-S01-4800-08	4800	4392		-	460; 3-ph; 60 Hz	4500	20.00 ●	
990 V		990 V						
DCS880-S01-2050-10	2050	2378		-		4500	9.70 ●	H8
DCS880-S01-2600-10	2600	3016		-	400; 3-ph; 50 Hz	4500	12.10 ●	
DCS880-S01-3300-10	3300	3828		-	460; 3-ph; 60 Hz	4500	16.60 ●	
DCS880-S01-4000-10	4000	4640		-		4500	20.20 ●	
1190 V		1190 V						
DCS880-S01-2600-12	2600	3588		-		4500	13.50 ●	H8
DCS880-S01-3300-12	3300	4554		-	400; 3-ph; 50 Hz	4500	18.20 ●	
DCS880-S01-4000-12	4000	5520		-	460; 3-ph; 60 Hz	4500	22.20 ●	

1) FEX-425 internal field exciter as option; three-phase or single phase, separate supply max. 500 V_{AC}

2) ratings for recommended DC voltage

3) SDCS-DSL-H1x board as standard

4) Continuous rating is 1190 A_{DC} for 35°C and 1140 A_{DC} for 40°C ambient temperature

I_{AC input} = I_{DC out} * 0.82

Current ratings

4-Q converters

The current ratings for the DCS880 with 50 Hz and 60 Hz supplies are given below. The symbols are described below the table. The characteristics are based on an ambient temperature of max. 40°C and an elevation of max. 1000 m a.s.l.

Unit type	I_{DC} [A]	$P_{out}^{2)}$ [kW]	$P_{out}^{2)}$ [kW]	Internal field current [A]	Fan voltage [V _{AC}]	Air volume [m ³ /h]	P_{Loss} [kW]	Frame size	
4-Q converters		400 V	500 V				³⁾		
400 V / 500 V / 525 V		400 V							
DCS880-S02-0025-04/05	25	10	13	6	without fan		0.11		
DCS880-S02-0050-04/05	50	21	26	12		57	0.17	H1	
DCS880-S02-0075-04/05	75	31	39	12	internal	57	0.22		
DCS880-S02-0100-04/05	100	42	52	12		57	0.28		
DCS880-S02-0150-04/05	150	63	78	18		170	0.38		
DCS880-S02-0200-04/05	200	83	104	18		170	0.56	H2	
DCS880-S02-0250-04/05	250	108	131	18	internal	170	0.73		
DCS880-S02-0300-04/05	300	142	157	18		170	0.82		
DCS880-S02-0350-04/05	350	145	182	25		170	0.91		
DCS880-S02-0450-04/05	450	187	234	25	internal	170	1.12	H3	
DCS880-S02-0520-04/05	520	215	276	25		255	1.32		
DCS880-S02-0680-04/05	680	282	354	30		388	1.76		
DCS880-S02-0820-04/05	820	340	426	30	230; 1-ph	388	2.14	H4	
DCS880-S02-1000-04/05	1000	415	520	30		425	2.68		
DCS880-S02-1190-04/05	1190 ⁴⁾	493	618	25 ¹⁾	230; 1-ph	918	5.00	●	H5
DCS880-S02-1200-04/05	1200	498	624	25 ¹⁾		850	5.10	●	
DCS880-S02-1500-04/05	1500	623	780	25 ¹⁾	230; 1-ph	850	5.30	●	H6
DCS880-S02-2000-04/05	2000	830	1040	25 ¹⁾		850	6.60	●	
DCS880-S02-2050-05	2050	851	1066	-	400; 3-ph; 50 Hz	1700	8.00	●	H7
DCS880-S02-2500-04/05	2500	1038	1300	-	525; 3-ph; 50 Hz	1700	9.00	●	
DCS880-S02-3000-04/05	3000	1245	1560	-	460; 3-ph; 60 Hz	1700	11.10	●	
DCS880-S02-3300-04/05	3300	1370	1716	-		4500	11.70	●	H8
DCS880-S02-4000-04/05	4000	1660	2080	-	400; 3-ph; 50 Hz	4500	13.00	●	
DCS880-S02-5200-04/05	5200	2158	2704	-	460; 3-ph; 60 Hz	4500	19.00	●	
600 V / 690 V		600 V							
DCS880-S02-0320-06	320	200	-	-	internal	170	0.91	●	H3
DCS880-S02-0650-06	650	405	-	-	230; 1-ph	425	1.86	●	
DCS880-S02-0900-06/07	900	563	648	25 ¹⁾		850	5.10	●	H6
DCS880-S02-1500-06/07	1500	938	1080	25 ¹⁾	230; 1-ph	850	6.30	●	
DCS880-S02-2050-06/07	2050	1281	1476	-	400; 3-ph; 50 Hz	1700	9.20	●	H7
DCS880-S02-2500-06/07	2500	1563	1800	-	525; 3-ph; 50 Hz	1700	10.20	●	
DCS880-S02-3000-06/07	3000	1875	2160	-	460; 3-ph; 60 Hz	1700	12.20	●	
DCS880-S02-3300-06/07	3300	2063	2376	-		4500	13.10	●	H8
DCS880-S02-4000-06/07	4000	2500	2880	-	400; 3-ph; 50 Hz	4500	15.10	●	
DCS880-S02-4800-06/07	4800	3000	3456	-	460; 3-ph; 60 Hz	4500	19.50	●	
800 V		800 V							
DCS880-S02-1900-08	1900	1558	-	-	400; 3-ph; 50 Hz	1500	9.00	●	H7
DCS880-S02-2500-08	2500	2050	-	-	525; 3-ph; 50 Hz	1500	10.70	●	
DCS880-S02-3000-08	3000	2460	-	-	460; 3-ph; 60 Hz	1500	12.70	●	
DCS880-S02-3300-08	3300	2706	-	-		4500	13.40	●	H8
DCS880-S02-4000-08	4000	3280	-	-	400; 3-ph; 50 Hz	4500	15.60	●	
DCS880-S02-4800-08	4800	3936	-	-	460; 3-ph; 60 Hz	4500	20.00	●	
990 V		990 V							
DCS880-S02-2050-10	2050	2132	-	-		4500	9.70	●	H8
DCS880-S02-2600-10	2600	2704	-	-	400; 3-ph; 50 Hz	4500	12.10	●	
DCS880-S02-3300-10	3300	3432	-	-	460; 3-ph; 60 Hz	4500	16.60	●	
DCS880-S02-4000-10	4000	4160	-	-		4500	20.20	●	
1190 V		1190 V							
DCS880-S02-2600-12	2600	3211	-	-		4500	13.50	●	H8
DCS880-S02-3300-12	3300	4076	-	-	400; 3-ph; 50 Hz	4500	18.20	●	
DCS880-S02-4000-12	4000	4940	-	-	460; 3-ph; 60 Hz	4500	22.20	●	

1) FEX-425 internal field exciter as option; three-phase or single phase, separate supply max. 500 V_{AC}

2) ratings for recommended DC voltage

3) SDCS-DSL-H1x board as standard

4) Continuous rating is 1190 A_{DC} for 35°C and 1140 A_{DC} for 40°C ambient temperature

$I_{AC Input} = I_{DC out} * 0.82$

Components overview of converter

Size H1 ... H4

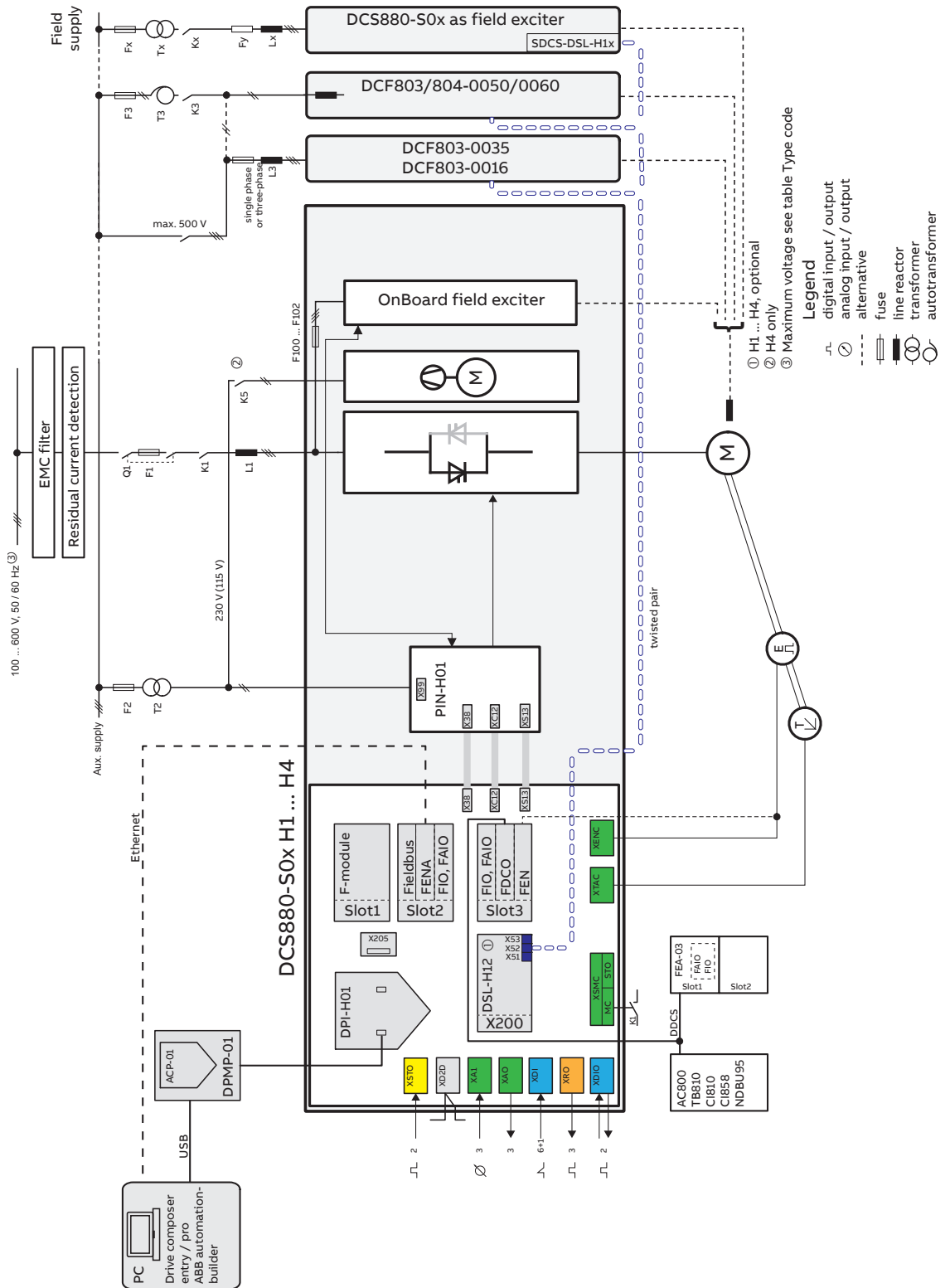

Components overview of converter

Size H5

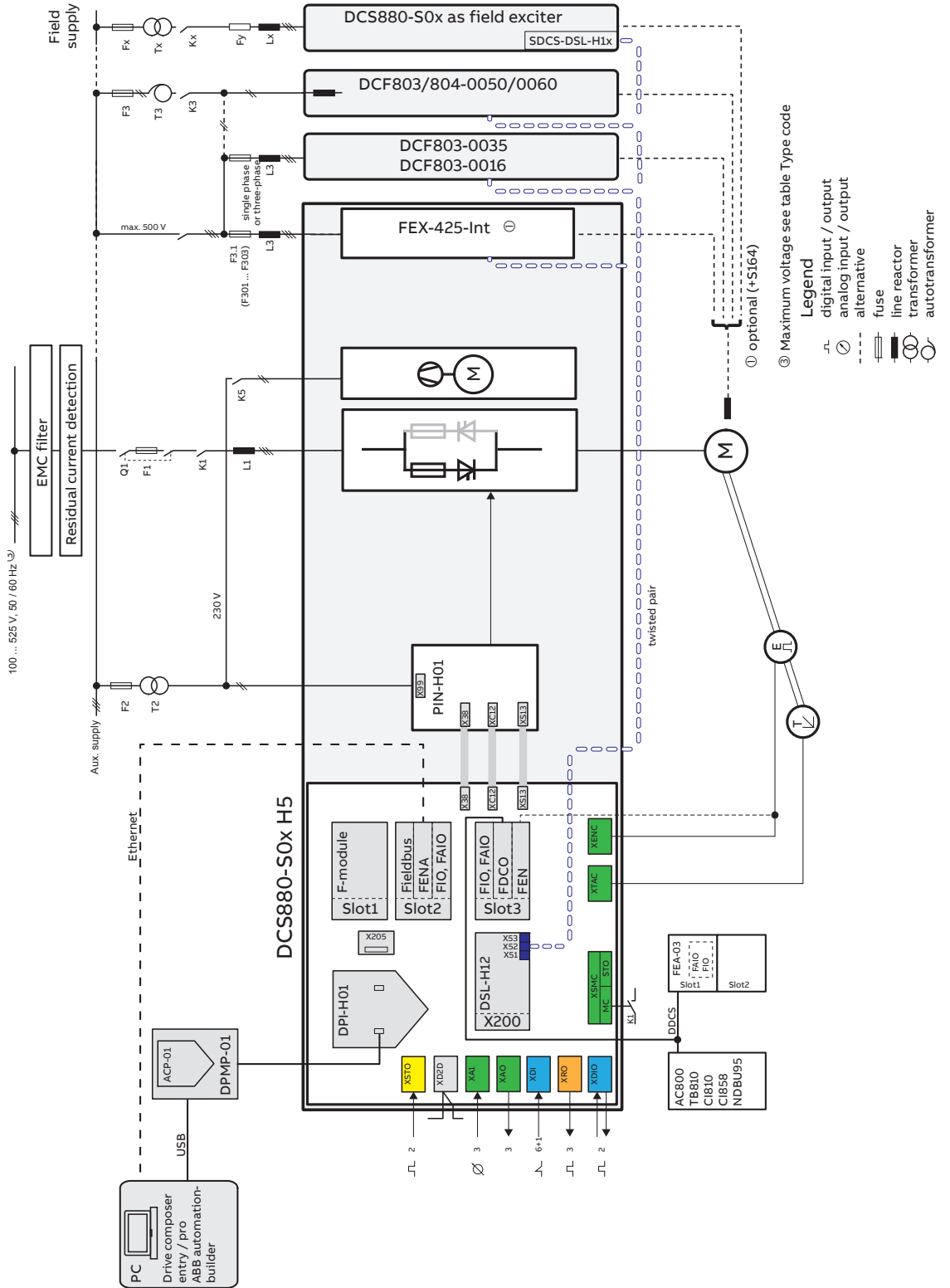

Components overview of converter

Size H6

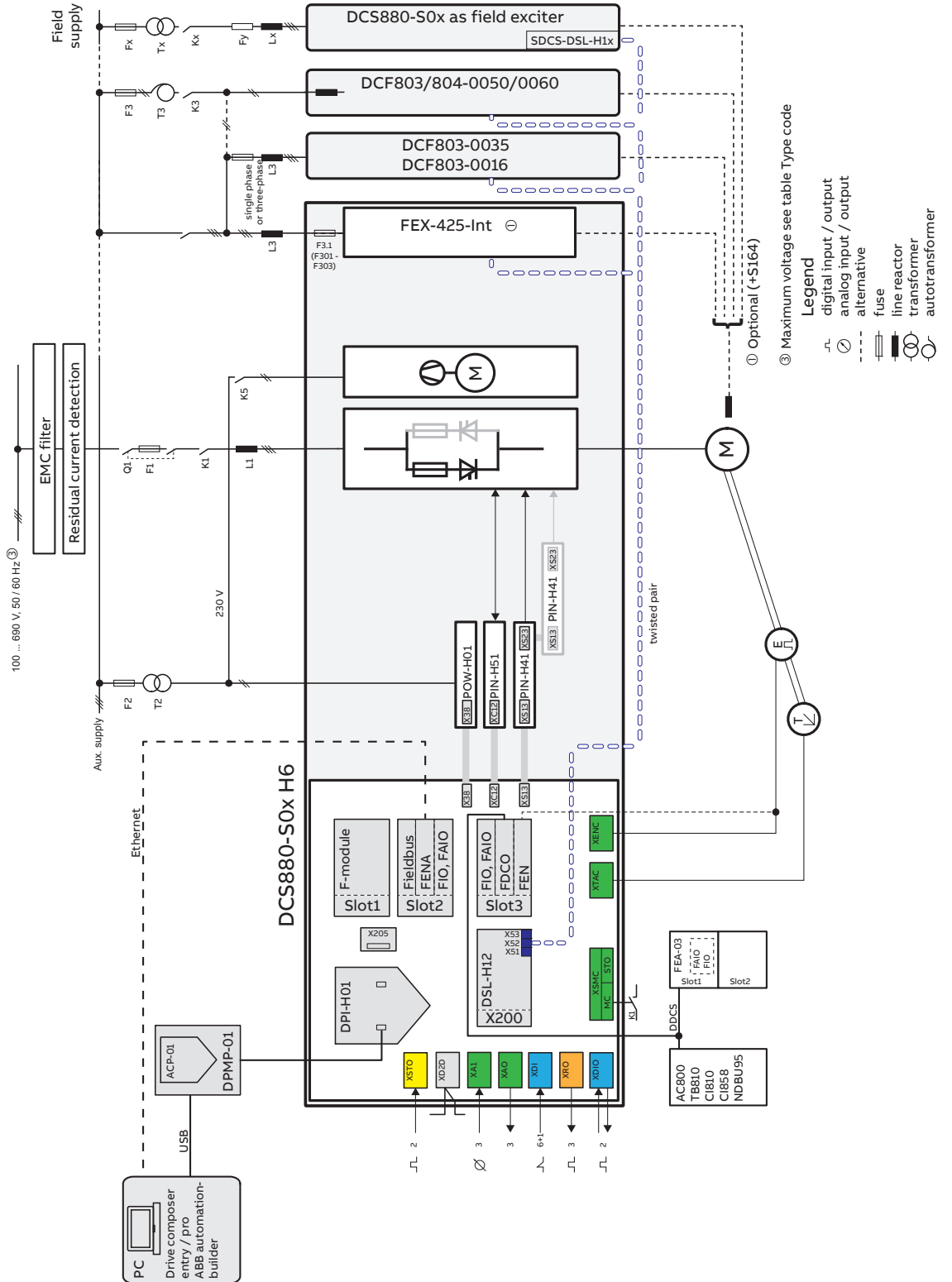

Components overview of converter

Size H7 ... H8 with external control unit

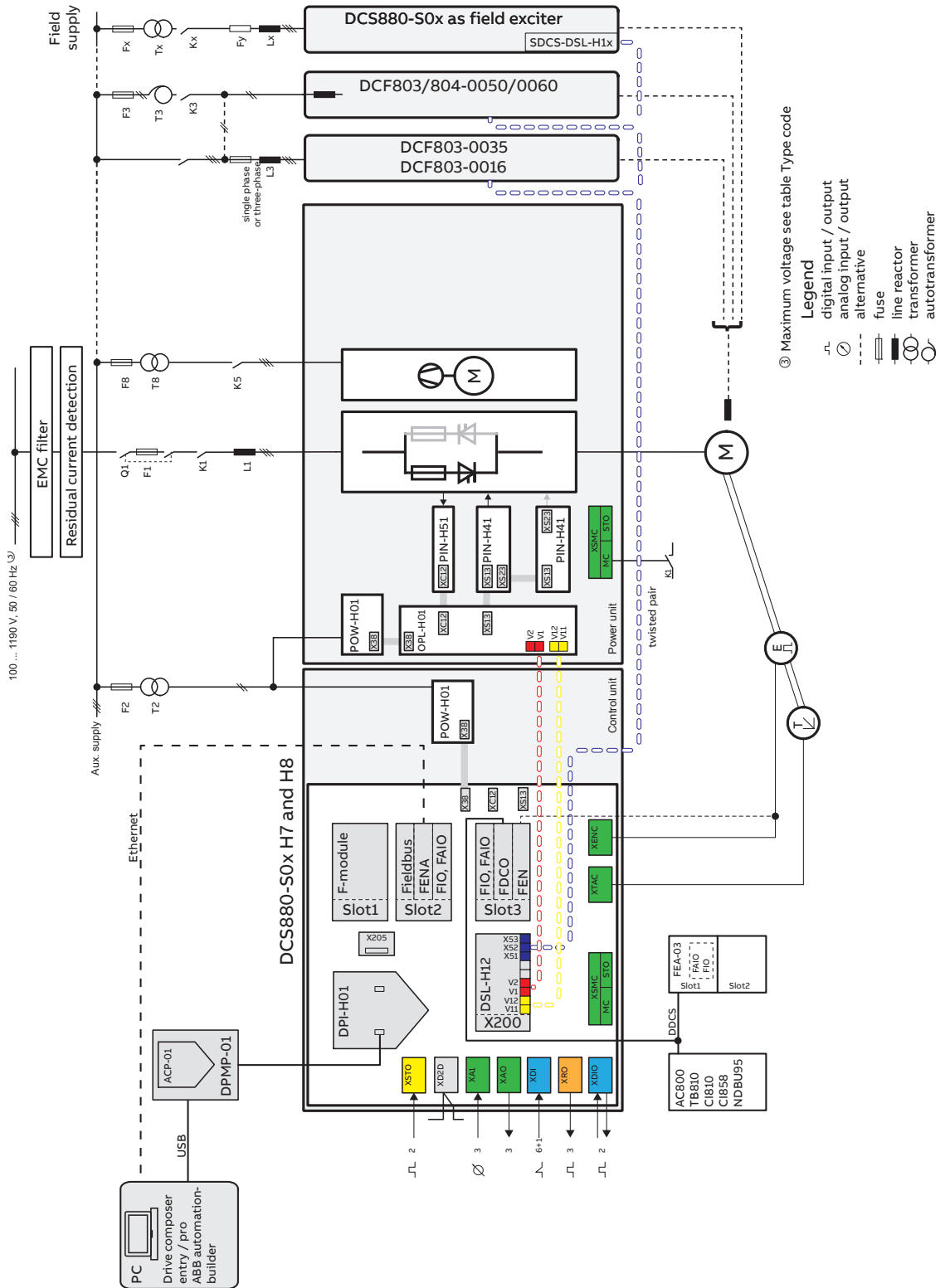

Standard interface and extensions for comprehensive connectivity

Example of a typical single drives input/output connection diagram.

DCS880

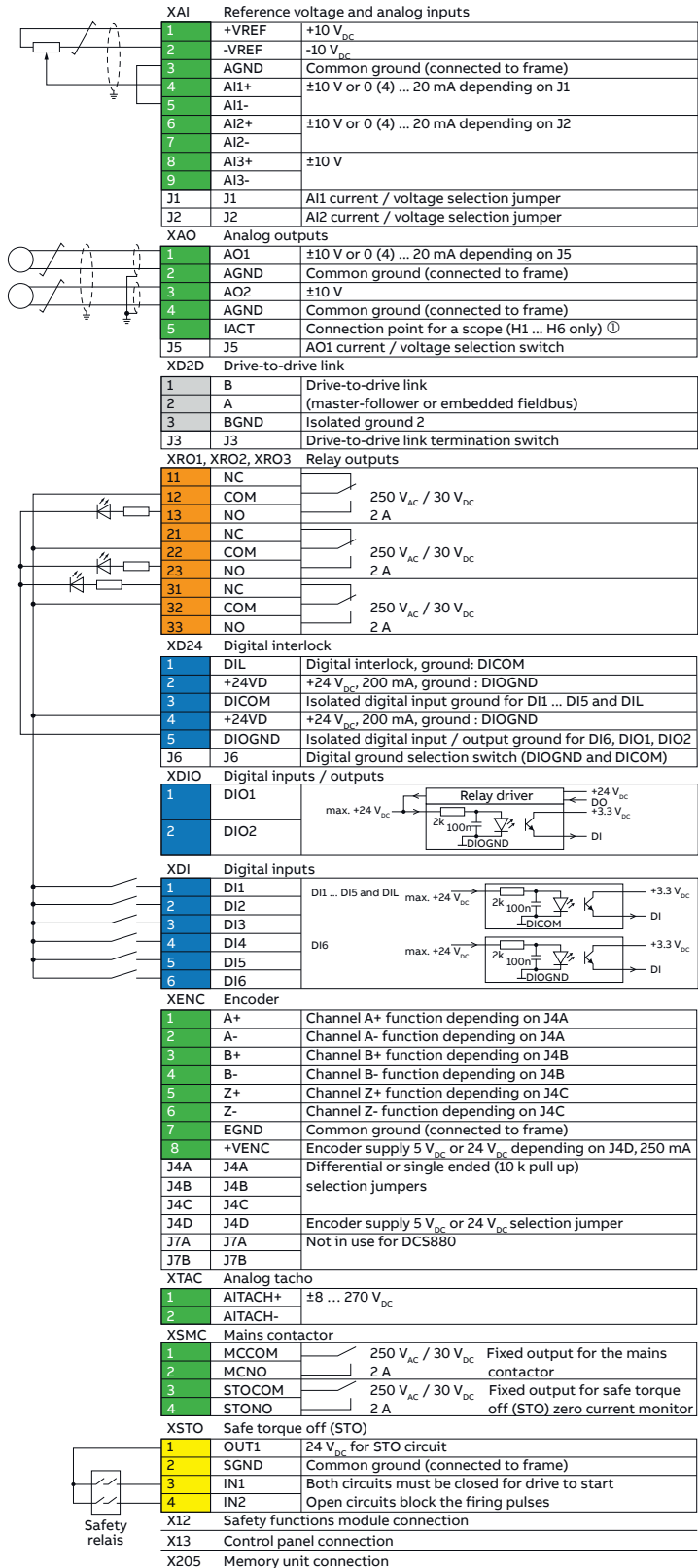

① For H7 and H8 see SDCS-OPL-H01.

—
01 Control unit
SDCS-CON-H01

The DCS880 single drives offers a wide range of standard interfaces. In addition the drive has three option slots that can be used for extensions

including fieldbus adapter modules, input/output extension modules, feedback modules and a safety functions module.

Standard interface	Description
3 analog inputs (XAI)	Current input: -20 ... 20 mA, Voltage input: -10 ... 10 V, Resolution: 15 bit + sign bit
2 analog outputs (XAO)	0 ... 20 mA, 0 ... 10 V
6 digital inputs (XDI)	Input type: Source / Sink (DI1 ... DI5), Source (DI6) DI6 (XDI:6) can alternatively be used as an input for a PTC thermistor.
Digital input interlock (DIIL)	Input type: Source / Sink
2 digital inputs/outputs (XDIO)	As input: 24 V logic level As output: Total output current from 24 V _{DC} is limited to 200 mA Can be set as pulse train input and output
3 relay outputs (XRO1, XRO2, XRO3)	250 V _{AC} / 30 V _{DC} , 2 A
Safe torque off (XSTO)	For the drive to start, both connections must be closed
Main contactor (XSMC)	Main contactor control, fault shut-down circuit
Drive-to-drive link (XD2D)	Physical layer: EIA-485
Built-in Modbus	Physical layer: EIA-485
Assistant control panel/	Connector: RJ-45
PC tool connection	USB via control panel
Encoder	5 V / 24 V, Differential or single ended
Tacho	±8 ... 270 V _{DC}

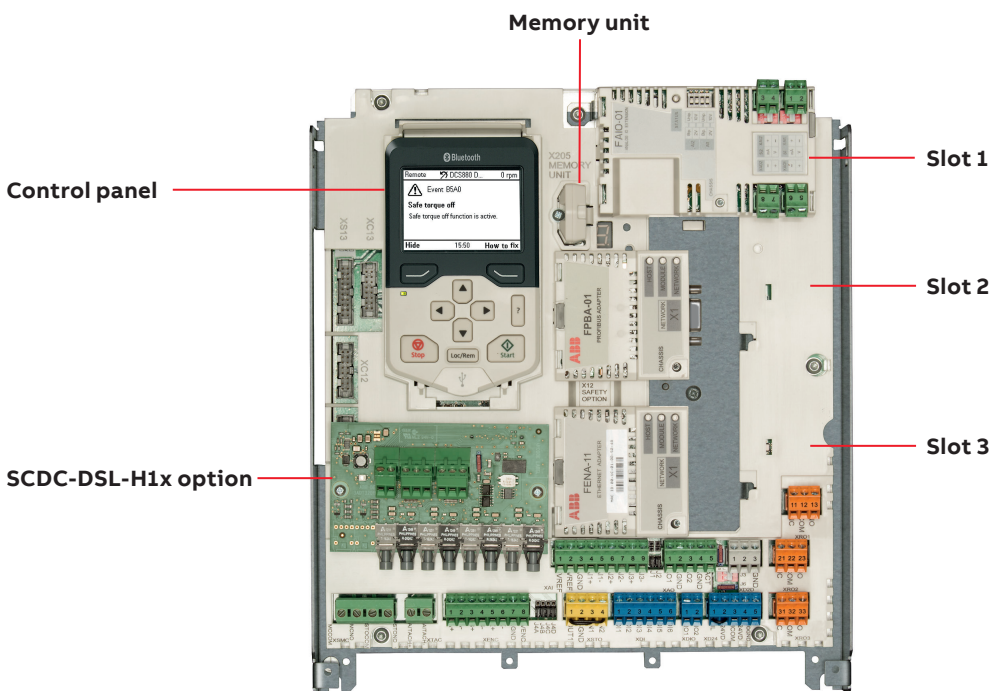

Interface option modules

Input/output extension modules for increased connectivity

Standard input and output can be extended by using optional analog and digital input/output extension modules. The modules are easily installed in the extension slots located on the control unit.

Analog and digital input/output extension modules

Option	Option code	Connections
FIO-01	+L501	4×DIO (24 V), 2×RO
FIO-11	+L500	3×AI (mA/V), 1×AO (mA), 2×DIO
FAIO-01	+L525	2×AI(mA/V), 2×AO(mA)
FDIO-01	+L526	3×DI (24 V, 115 V, 230 V), 2×RO

Speed feedback interfaces for precise process control

DCS880 drives can be connected to various feedback devices, such as HTL pulse encoder, TTL pulse encoder, absolute encoder and resolver. The optional feedback module is installed in the option slot on the drive. It is possible to use two feedback modules at the same time, either of the same type or different type.

Feedback interface modules

Option	Option code	Connections
FEN-01	+L517	2 inputs (TTL pulse encoder), 1 output
FEN-21	+L516	2 inputs (Resolver, TTL pulse encoder), 1 output
FEN-31	+L502	1 input (HTL pulse encoder), 1 output

I/O option extension adapter

For additional I/O option slots the FEA-03 is suitable for this use. An analog and digital input/output extension and speed feedback interface can be installed on the FEA-03. Two extension modules can be installed on each I/O extension slot. The connection to the control unit is via an fiber optic link. The adapter can be mounted on an DIN rail (35 x 7.5 mm). Extension adapter requires FDCO option module

I/O extension adapter

Option	Description	Ordering code
FEA-03	2 x F-type option extension slots	3ADT200067R0001

Communication option modules

DDCS communication option modules

The FDCO-0X optical DDCS communication options are add-on modules on the DCS880 industrial drives control unit. The modules include connectors for two fiber optic DDCS channels. The FDCO-01 module makes it possible to perform master-follower and AC800 M communication.

DDCS communication option modules

Option	Option code	Connections
FDCO-01	+L503	Optical DDCS (10 Mbd/10 Mbd)

DCSLink communication option modules

The SCDC-DSL-H1x DCSLink communication options are add-on modules on the DCS880 industrial drives control unit. The option include connectors for DCSLink communication as well as up to 4 fiber optics channels for optical power link communication. DCSLink is used to control external field exciters and also used for 12- and higher pulse operation. The optical power link communications enable control of a power unit size H7 and H8 as well as parallel operation of up to four power units.

DCSLink communication option modules

Option	Option code	Connections
SDCS-DSL-H10	+S521	1 DCSLink channel, 0 channels optical power link
SDCS-DSL-H12		1 DCSLink channel, 2 channels optical power link
SDCS-DSL-H14	+S523	1 DCSLink channel, 4 channels optical power link

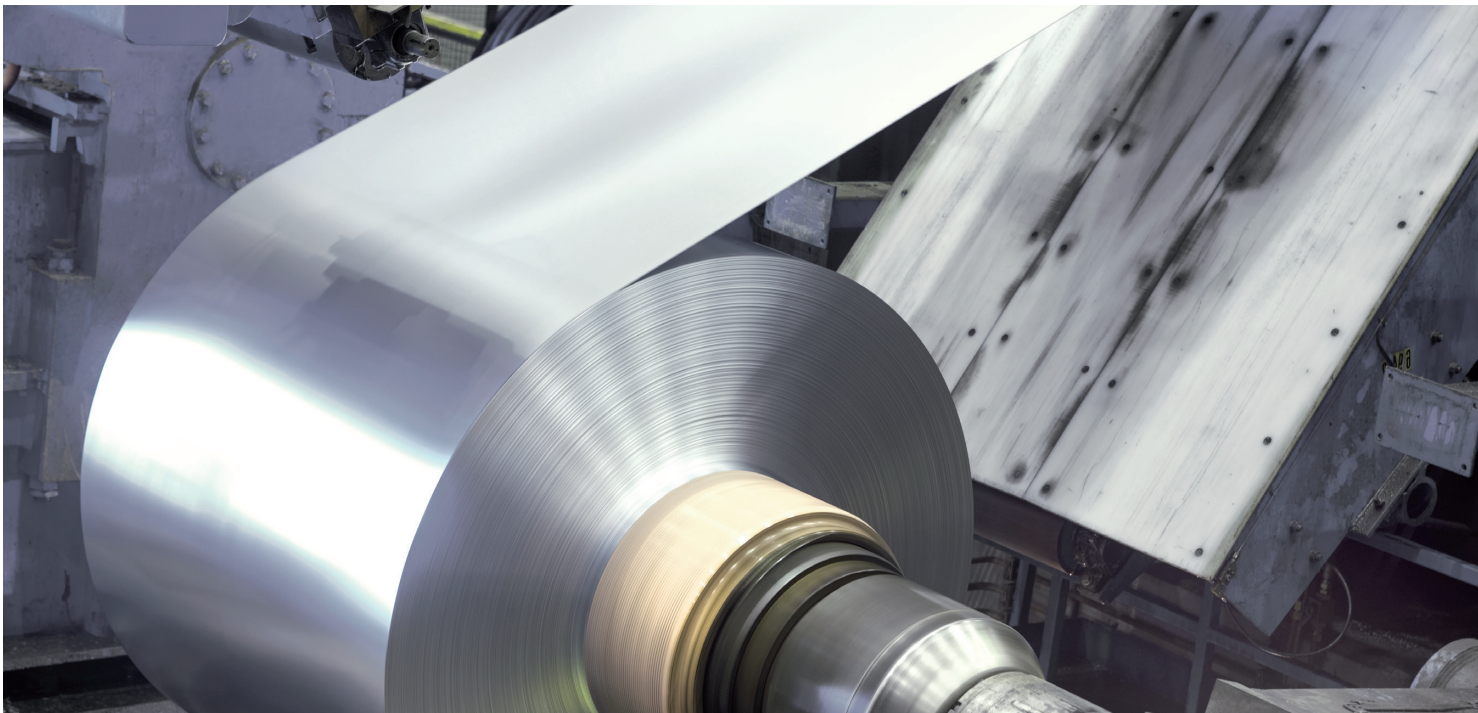

Flexible connectivity to automation networks



— 01 F-type fieldbus adapters
— 02 NETA-21

Our fieldbus adapter modules enable communication between drives, systems, devices and software. Our industrial drives are compatible with a wide range of fieldbus protocols.

The plug-in fieldbus adapter module can easily be mounted inside the drive. Other benefits include reduced wiring costs when compared with traditional input/output connections. Fieldbus systems are also less complex than conventional systems, resulting in less overall maintenance.

Multiple fieldbus connections for flexible control
DCS880 supports two fieldbus connections simultaneously. The user has flexibility of choice for control modes by being able to select one protocol for control and one for monitoring. Also redundant fieldbus connection is possible.

Drive monitoring
A set of drive parameters and/or actual signals, such as torque, speed, current, etc., can be selected for cyclic data transfer, providing fast data access.

Drive diagnostics
Accurate and reliable diagnostic information can be obtained through the alarm, limit and fault words.

Drive parameter handling
The Ethernet fieldbus adapter module allows users to build an Ethernet network for drive monitoring and diagnostic and parameter handling purposes.

Remote monitoring access worldwide
The remote monitoring tool, NETA-21, gives easy access to the drive via the Internet or local Ethernet network. NETA-21 comes with a built-in web server. Through the interface the user can configure drive parameters, monitor drive log data and follow up load levels, run time and I/O data. The user can access the remote monitoring tool web page using 3G modem from anywhere with a standard PC, tablet or a mobile phone. The remote monitoring tool allows personnel to monitor or perform maintenance for unmanned or manned applications and enables access for multiple users from several locations.



Enhanced monitoring functions
Values of process variables or drives actual values can be logged to NETA-21's SD memory card or sent forward to a centralized database.

Cabling
Substituting the large amount of conventional drive control cabling and wiring with a single cable reduces costs and increases system reliability and flexibility.

Design
The use of fieldbus control reduces engineering time at installation due to the modular structure of the hardware and firmware and the simplicity of the connections to the drives.

Commissioning and assembly
The modular machine configuration allows pre-commissioning of single machine sections and provides easy and fast assembly of the complete installation.

Universal communication with ABB fieldbus adapters
The DCS880 supports the following fieldbus protocols:

Fieldbus adapter modules		
Option	Option code	Fieldbus protocol
FPBA-01	+K454	PROFIBUS DP, DPV0/DPV1
FCAN-01	+K457	CANopen®
FDNA-01	+K451	DeviceNet™
FENA-21	+K475	2 port EtherNet/IP™, Modbus TCP, PROFINET IO, PROFIsafe ¹⁾
FECA-01	+K469	EtherCAT®
FSFA-01	+K458	Modbus RTU
FEPL-02	+K470	PowerLink
FEIP-21	+K490	EtherNet/IP™
FMBT-21	+K491	Modbus TCP
FPNO-21	+K492	PROFINET IO
FSPS-21	+Q986	PROFIsafe

¹⁾ For the PROFIsafe to work the PROFINET fieldbus adapter module (FENA-21) and the safety functions module are required.

Cost and time savings with drive-based functional safety

—
03 FSPS-21
—
04 FSO-21, FSE-31

Safety functions

DCS880 converters offer safe torque off (STO) built in as a standard.

Scalable safety with PROFIsafe and safety PLC

The safety functionality can be scaled to your needs. From STO wired to an emergency push button, to a complete safety system with PROFIsafe and a safety PLC, e.g. the AC500-S.

FSPS-21 PROFIsafe safety option module

The FSPS-21 PROFIsafe safety option module enables a safe ethernet connection between drive and safety PLC and provides two safety functions which are activated via PROFIsafe over PROFINET IO.



—
03

Available safety functionality

The following safety functions are supported (which achieve a safety level up to SIL3 / PL e (Cat. 3)):

- Safe torque off (STO).
The STO function corresponds to an uncontrolled stop in accordance with stop category 0 of EN 60204-1. Torque is removed safely from the motor shaft and permits safe maintenance and safe operation of the machinery.
- Safe Stop 1 (SS1-t).
The function SS1-t stops the motor by ramping down the motor speed to zero (stop category 1) and activates safely STO after SS1-t monitored time limit has elapsed regardless of the motor speed.

The drives functional safety is designed in accordance with EN/IEC 61800-5-2 and complies with the requirements of the European Union Machinery Directive (2006/42/EC).

FSE-31 pulse encoder interface module

The FSE-31 pulse encoder interface module is used in safety systems together with the FSO-21 safety functions module. The safety pulse encoder delivers pulses to the FSE-31 module which delivers safe speed, direction and position information to the FSO-21 module.



—
04

Integrated safety simplifies configuration

Easy configuration

Configuring the safety functions module is easy thanks to the graphical user interface of the Drive composer pro PCTool.

TÜV-certified safety design tool

The FSDT-01 functional design safety design tool can be used to design complete safety circuits. It helps to increase the safety of users in the vicinity of machines. You can perform functional safety modeling, design, calculations and verification for machine functional safety.

Common features

throughout the whole DCS880 product family



Standard DCS880 features

DCS880 basic firmware

DCS880 firmware includes the basic function of speed control, armature current, field current and motor voltage. The flexible design for command location enables field bus control or master-follower control or control from hardware signals as well as a mixed structure. The design of drive logic enables a drive reaction defined by Profibus standard but can also be configured to adapt classic command structures.

Integrated safe torque off (STO)

- Safe torque off for implementing safe machinery
- SIL 3, PL e

Extensive I/O connections

- The DCS880 features extensive I/O connections for flexible configuration in various applications
- Colored terminals for easy configuration

Assistant control panel and primary settings

- The ACS-AP-I assistant control panel speaks multiple different languages
- USB interface for PC and tool connection
- Help button for problem-solving

Commissioning Assistants

DCS880 includes an eight step assistant to set up the drive. The assistant is available via control panel and Drive Composer Pro PC-tool.

Following commissioning steps are covered:

- Name plate data
- Standard I/O
- Field current controller with auto tuning
- Armature current controller with auto tuning
- First motor turning
- Speed feedback selection with autodetect of speed feedback device
- Speed controller with auto tuning
- Field weakening with auto tuning



Shared features of the ABB all-compatible drives portfolio

Adaptive programming

- DCS880 firmware includes an easy-to-use and visual adaptive programming feature.
- Adaptive programming can be used to add logical functions and conditions for process fine-tuning.

Same PC tools for ABB all-compatible drives

- Free Drive Composer entry available at www.abb.com.
- Same parameter structure makes the all-compatible platform easy to use.

Removable memory unit

The removable memory unit stores the firmware that includes user settings, parameter settings and motor data. Situated on the control unit, the memory unit can easily be removed for maintenance, update or replacement purposes.

Connectivity

- The DCS880 supports F-series fieldbus adapters used in the ABB all-compatible platform.
- Mobile phone connectivity via the optional Bluetooth assistant control panel.

Standard DCS880 drives software with versatile features

Save commissioning and learning time with the assistant control panel's clear and intuitive user interface and different assistants.

Support for 12-pulse systems to reduce line harmonics, reduce motor noise level, enlarge output current or voltage of the converter system.

Same product for non-motoric applications enables to cover applications such as: water treatment, chlorination, electrolysis, galvanization, magnet, arc furnace and testing.

Adapt and customize using flexible IEC61131-3 programming, making it easy to adapt to any application need.

Built-in Drive-to-Drink link (D2D) to cover all the master follower applications where motors run with the same speed / torque connected to the same shaft or gearbox.

Scale up and customize the drive to your application's requirements with flexible parameter pointers or adaptive programming.

Protect and supervise your motor by powerful supervision functions such as stall protection, thermistor motor protection, armature current ripple, minimum field current and many more.

Analyze and resolve issues with the control panel's diagnostics menu. You can quickly analyze why the drive is performing as it is; running, stopped or running at the present speed.

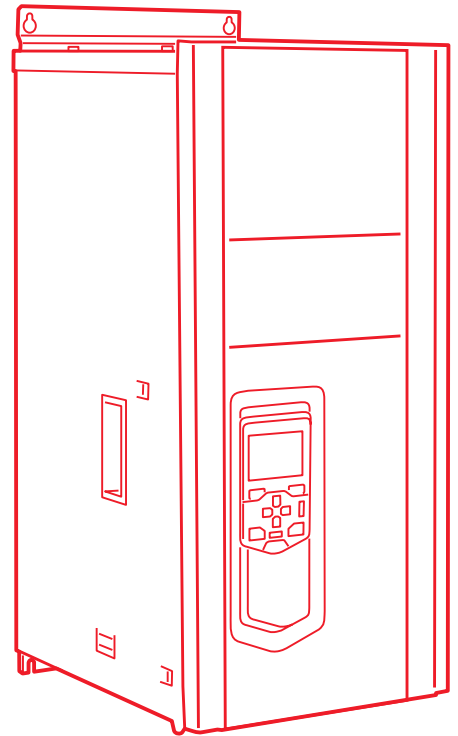

The all-compatible DCS880 series

The first choice for any application

Replacement of existing DC Drives

In many installations DC drives are in reliable operation since decades. While the DC motors can often be operated for many more years, the DC drive however might experience lack of support and spare parts and maybe even reliability.

A replacement of the old DC drive with a DCS880 can extend the lifetime of the equipment by some more decades at very low costs. Additionally it can easily get upgraded to the newest safety requirements by using STO without the need of adding or replacing breakers or contactors. Since existing drive installations from the past decades may comprise many different configurations, the DCS880 is prepared for any challenges with its unique flexibility and programmability.

Ships and offshore

On ships and offshore outstanding robustness and reliability is a must when driving winches, drills, mud pumps or propulsions. On top, the DCS880 offers various marine certifications.

Test equipment

For testing powertrains, materials or any rotating equipment customers can rely on the DCS880's high accuracy speed and torque control, its high dynamic control and the wide field weakening range.

Plastic and rubber

When used in extruders, mixers, kneaders, or calendars the DCS880 convinces with high starting torque and overloadability as well as various protecting functions to protect motor and equipment.

Metals

Rolling or tube mills often combine very high motor power with extremely fast load changes. Consequently, the DCS880 offers both – a proven high dynamic torque control and flexible high power configurations up to 20,000 A /1,500 V_{DC} in 6-pulse, 12-pulse or 24-pulse with high overloadability. Other applications in metals fabrication like roller tables, wire drawing or processing lines benefit from safe operation with STO and the DCS880's robustness in harsh environment.

Pulp and paper

With the DCS880 replacements of old DC drives in an existing paper machine can be executed in very short downtimes as low as eight hours. And thanks to the integrated STO the machine can be upgraded to the newest safety requirements without installing or replacing additional contactors or breakers.

Food and beverage

Sugar centrifuges or meat processing equipment benefit from the compact size - even with regenerative braking - and low losses combined with high reliability.

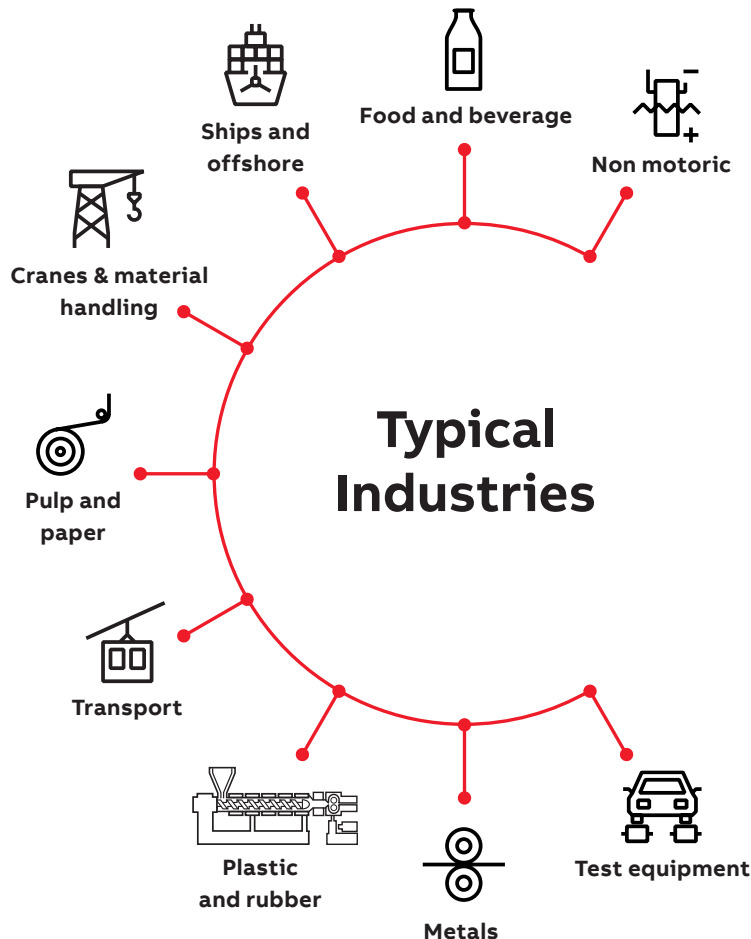

Drive programming

Application programming based on IEC 61131-3

Drive Application Builder (DAB) makes it possible for system integrators and machine builders to integrate their desired functionality and know-how directly into DCS880 drives. This is possible as DCS880 drives come with programming capability embedded inside the drive. Designing an application program in the drive makes the end user application run more efficiently, even without a separate programmable controller. It also brings higher end-product quality and requires less need for installation space and wiring.

very flexible to meet exact requirements set for end user applications. The library management functionality in DAB shortens engineering time as reuse of existing program code is possible. Additional features include the ability to select and use one of five different programming languages, effective program debugging and user password protection. The drive application programming license should be ordered together with the drive.

Drive Application Builder lets you extend the standard functionality of parameter functions for DCS880 drives. This makes the DCS880 drives

Drive application programmability

Option	Option code
License key	+S551

For more and advanced functions the Drive Application Builders tools must be ordered separately. For further information please contact your local ABB.

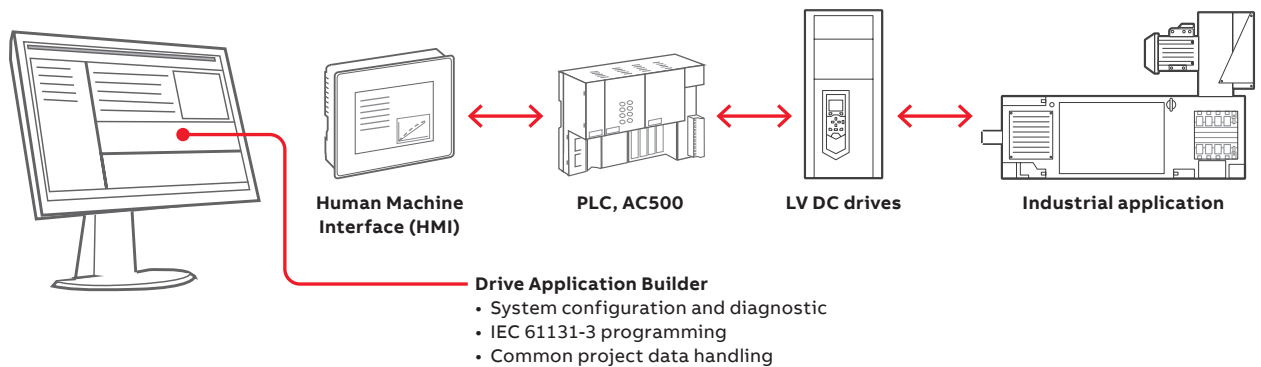

Adaptive programming

Adaptive programming is used to customize the operation of a drive in case the drive parameter setting is not sufficient. The adaptive program is

built with standard function blocks included in the drive firmware elements.

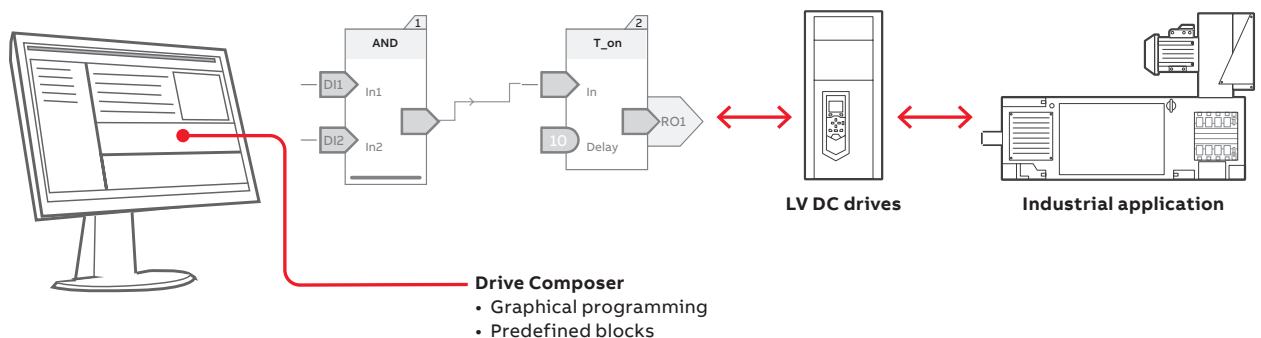

Intuitive human-machine interface



The assistant control panel features intuitive use and easy navigation. High resolution display enables visual guidance. The panel saves on commissioning and learning time by means of different assistants, making the drive simple to set up and use.

It is possible to organize parameters in different ways and store essential parameters for different configurations for any specialized application needed. The menus and messages can be customized for specific terminology so that each application can be set up and configured to its optimum performance. This makes the drive easier to use with information that is familiar to users. With the panel's text editor, users can also add information, customize text and label the drive. Powerful backup and restore functions are supported as well as different language versions. The help key provides context sensitive guidance. Faults or warnings can be resolved quickly since the help key provides troubleshooting instructions.

One control panel can be connected to several drives via DPI-H01 simultaneously using the panel network feature. The user can also select the drive to operate in the panel network. The PC tool can be easily connected to the drive through the USB connector on the control panel. There are also control panel mounting platforms, DPMP-01 and DPMP-02, available for cabinet door mounting with IP55 or IP65 protection class.

Assistant control panel

Option	Option code	Description
ACS-AP-I	standard	built-in
no ACS-AP-I	0J404	no panel
ACS-AP-W	+J429	Bluetooth panel
DPI-H01	+J428	daisy-chain option

Option	Description	Ordering code
DPMP-01	Panel flush mounting kit	3AUA0000108878
DPMP-02	+Panel surface mounting kit	3AXD5000009374



PC tool for easy startup and maintenance

The Drive composer PC tool offers fast and harmonized setup, commissioning and monitoring for the whole drives portfolio. The free version of the tool provides startup and maintenance capabilities, while the professional version provides additional features such as custom parameter windows, control diagrams of the drive's configuration and safety settings.

The Drive composer tool is connected to the drive using an Ethernet connection or through the USB connection on the assistant control panel. All drive information such as parameter loggers, faults, backups and event lists are gathered into a support diagnostics file with a single mouse click. This provides faster fault tracking, shortens downtime and minimizes operational and maintenance costs.

Drive composer pro

Drive composer pro provides basic functionality, including parameter settings, downloading and uploading files and search parameters. Advanced features such as graphical control diagrams and various displays are also available. The control diagrams save users from browsing long lists of parameters and help to set the drive's logic quickly and easily. The tool has fast monitoring capabilities of multiple signals from several drives in a PC tool network. Full backup and restore functions are also included. Safety settings and adaptive programming programs can be configured with Drive composer pro.



Item	Description	Ordering code
Drive composer entry	free of charge	www.abb.com
Drive composer pro tool	single licence	3AUA0000108087
Drive composer pro tool	10 user licence	3AUA0000145150
Drive composer pro tool	20 user licence	3AUA0000145151
USB cable	5 m USB A – USB Mini B	3ADT693714P0001

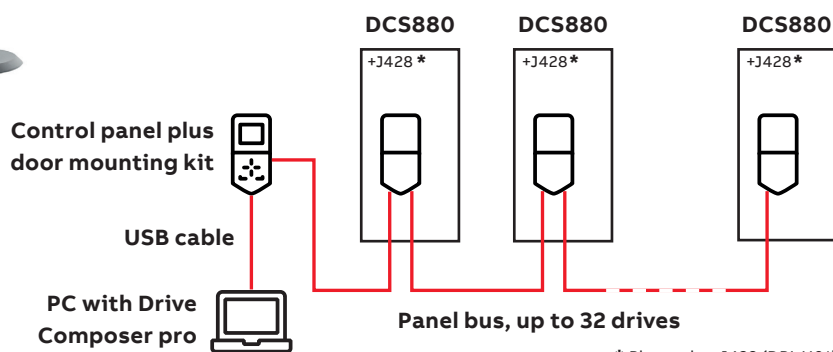

* Plus code: +J428 (DPI-H01)

External field supply

01 DCF803-0035

General data

- Currents from 0.3 to 520 A
- Minimum field current monitor
- Integrated external field power converter or completely separate switchgear cubicle
- single-phase or 3-phase model
- Controlled by serial communication via DCSSLink

All field converters are controlled by the armature converter via a serial interface (SDCS-DSL-H1x board). This interface serves to parameterize, control and diagnose the field converter and thus provides exact control.

We recommend integrating an autotransformer in the field power converter's supply circuit to adjust the AC input voltage to the field voltage and for reducing the voltage ripple in the field circuit for single-phase operation.

Field reversal

Field reversal is basic firmware function of DCS880. Required hardware configuration is a 2-Q (single) armature bridge plus a 4-Q (double bridge) field exciter.

Field reversal offers low dynamic torque reversal which can be used for e.g. propulsion Drive to change speed direction or E-Stop function for unidirectional mills.

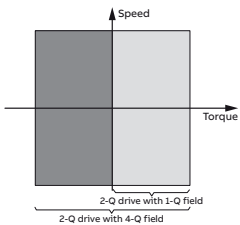

Field converter types DCF803-0035 and DCF803-0016

- Half-controlled thyristor/diode bridge (1-Q)
- Three-phase or single-phase operation
- Microprocessor control, with the electronic system being supplied by the armature circuit converter (24 V).
- Construction and components have been designed for an insulation voltage of 600 V_{AC}.
- Fast-response excitation is possible with an appropriate voltage reserve; de-excitation takes place by field time constant.
- Field Output voltage U_A (single-phase operation):

$$U_A \leq U_V * \left(\frac{100\% + TOL}{100\%} \right) * 0.9$$

TOL = tolerance of line voltage in %
U_V = Mains voltage, U_A = Field voltage

- Recommendation (single-phase operation):
U_A = 0.6 to 0.8 * U_V or U_V = 1.25 to 1.7 * U_A
- Field Output voltage U_A (three-phase operation):

$$U_A \leq U_V * \left(\frac{100\% + TOL}{100\%} \right) * 1.35$$

TOL = tolerance of line voltage in %
U_V = Mains voltage, U_A = Field voltage

Note: Calculation valid also for FEX-425 internal



01

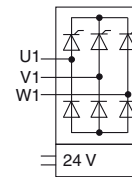

Table of field converter units

Unit type	Output current I _{CC}	AC field supply voltage	auxiliary supply voltage	Remarks
DCF803-0016	0.3 ... 16 A	110 V -15 % ... 500 V / 1-ph +10 % single-phase or three-phase		external fuse L3 line choke for 3-phase operation use:
DCF803-0035	0.3 ... 35 A	110 V -15 % ... 500 V / 1-ph +10 % single-phase or three-phase	24 V _{DC} 200 mA	ND401 ≤ 16 A ND402 > 16 A for 1-phase operation use: ND30 ≤ 16 A ND402 > 16 A
DCF803-0050	0.3 ... 50 A	110 V -15 % ... 500 V / 1-ph +10 %		if necessary via matching autotransformer; fuse external; Dimensions HxWxD: 370x125x342 [mm]
DCF804-0050	0.3 ... 50 A	110 V -15 % ... 500 V / 1-ph +10 %		
DCF803-0060	0.3 ... 60 A	110 V -15 % ... 500 V / 1-ph +10 %		
DCF804-0060	0.3 ... 60 A	110 V -15 % ... 500 V / 1-ph +10 %	115 or 230 V	
DCS880-S0x-xxxx-05		200 V ... 500 V / 3-ph		additional hardware components (DCF 506)

—
02 DCF804-0050
—
03 DCS880-S0
—
04 DCF506-140-51

Single-phase field supply

DCF803-0050 and DCF803-0060

- Single-phase power stack
- Half-controlled thyristor/diode bridge (1-Q).
- Built-in line chokes.
- Microprocessor control with the control electronics being supplied separately (115 ... 230 V/1-ph).
- Construction and components have been designed for an insulation voltage of 690 V_{AC}.
- Field output voltage U_A:

$$U_A \leq U_V * \left(\frac{100\% + TOL}{100\%} \right) * 0.9$$

TOL = tolerance of line voltage in %
U_V = Line voltage, U_A = Field voltage

- Recommendation:
U_A = 0.6 to 0.8 * U_V or U_V = 1.25 to 1.7 * U_A

DCF804-0050 and DCF804-0060

- Single-phase power stack
- Fully-controlled antiparallel thyristor bridges (4-Q)
- This unit offers field reversal as well as fast-response excitation / de-excitation.
- In the steady-state condition, the fully-controlled bridge runs in half-controlled mode so as to keep the voltage ripple as low as possible. With a quickly alternating field current, the bridge runs in fully-controlled mode.
- Same design as DCF803-0050.
- Built-in line chokes.

Autotransformer for single-phase field supply.

for field current I _F	Autotransformer type 50/60 Hz	DCF803-0016	DCF803-0050
		DCF803-0035	DCF804-0050
		FEX-425 Int	DCF803-0060
			DCF804-0060
U _{prim} = ≤ 500 V			
≤ 6 A	T 3.01	x **	x
≤ 12 A	T 3.02	x **	x
≤ 16 A	T 3.03	x **	x
≤ 30 A	T 3.04	x *	x
≤ 50 A	T 3.05		x
≤ 60 A	on request		x
U _{prim} = ≤ 600 V			
≤ 6 A	T 3.11	x **	x
≤ 12 A	T 3.12	x **	x
≤ 16 A	T 3.13	x **	x
U _{prim} = ≤ 690 V			
≤ 30 A	T 3.14		x
≤ 50 A	T 3.15		x
≤ 60 A	on request		x

* three-phase operation recommended
** requires line choke ND 30 or ND402

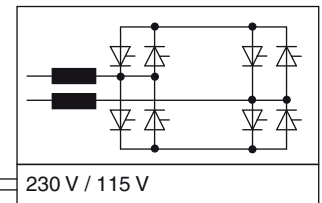

—
02

DCS880 exciter modules

DCS880-S01, DCS880-S02

This converter can also be used for field exciter operation, an additional overvoltage protection unit is required. It provides field currents from 20 A up to 520 A unipolar (2-Q) and bipolar (4-Q) for field reversal function.

- Field output voltage U_A respectively U_{dmax2-Q} : see table on page 13
- Recommendation:
U_A = 0.5 to 1.1 * U_V or U_V = 0.9 to 2.0 * U_A
- The large field supply converters DCS880-S01/S02 need a separate active overvoltage protection unit DCF506 for protecting the power part against inadmissibly high voltages.
The overvoltage protection unit DCF506 is suitable for 2-Q converters DCS880-S01 and for 4-Q converters DCS880-S02.
- DCSLink communication board +S521 required.

Assignment of field supply converter to overvoltage protection unit

Field supply converter for motor fields	Overvoltage protection
DCS880-S0x-0020-04/05	
...	DCF506-0140-51
DCS880-S0x-0100-04/05	
DCS880-S0x-0135-04/05	
...	DCF506-0520-51
DCS880-S0x-0680-04/05 *	

* max field current 520 A



—
03

—
04

Fuse connections

Recommended fuse connections see tables below.

Semiconductor type F1 fuses and fuse holders for AC and DC power lines (DCS880-S01 / DCS880-S02)

The converter units are subdivided into two groups:

- Unit sizes H1, H2, H3 and H4 with rated currents up to 1000 A require external line fuses.
- In unit sizes H5, H6, H7 and H8 with rated currents of 900 A to 5200 A, the semiconductor fuses are installed internally (no additional external semiconductor fuses are needed).

The table assigns the AC fuse types to the converter types. In case the converter should be equipped with DC fuses according to the hints use the same type of fuse used on the AC side now in the plus and minus line (only for sizes H1 ... H4). Blade type fuses are used for all the converters of construction type H1 ... H4 except the converters (610 A, 680 A, 740 A, 820 A, 900 A, 1000 A).

Type of converter	Type	Fuse holder	Design fig.
2-Q Converter	4-Q Converter		
DCS880-S01-0020-04/05	DCS880-S02-0025-04/05	50A 660V UR	OFAX 00 S3L 1
DCS880-S01-0045-04/05	DCS880-S02-0050-04/05	80A 660V UR	OFAX 00 S3L 1
DCS880-S01-0065-04/05	DCS880-S02-0075-04/05	125A 660V UR	OFAX 00 S3L 1
DCS880-S01-0090-04/05	DCS880-S02-0100-04/05	125A 660V UR	OFAX 00 S3L 1
DCS880-S01-0135-04/05	DCS880-S02-0150-04/05	200A 660V UR	OFAX 1 S3 2
DCS880-S01-0180-04/05	DCS880-S02-0200-04/05	250A 660V UR	OFAX 1 S3 2
DCS880-S01-0225-04/05	DCS880-S02-0250-04/05	315A 660V UR	OFAX 2 S3 2
DCS880-S01-0270-04/05	DCS880-S02-0300-04/05	500A 660V UR	OFAX 3 S3 3
DCS880-S01-0315-04/05	DCS880-S02-0350-04/05	500A 660V UR	OFAX 3 S3 3
DCS880-S01-0405-04/05	DCS880-S02-0450-04/05	700A 660V UR	OFAX 3 S3 4
DCS880-S01-0470-04/05	DCS880-S02-0520-04/05	700A 660V UR	OFAX 3 S3 4
DCS880-S01-0610-04/05	DCS880-S02-0680-04/05	900A 660V UR	3 x 170H 3006 5
DCS880-S01-0740-04/05	DCS880-S02-0820-04/05	900A 660V UR	3 x 170H 3006 5
DCS880-S01-0900-04/05	DCS880-S02-1000-04/05	1250A 660V UR	3 x 170H 3006 5
DCS880-S01-0290-06	DCS880-S02-0320-06	500A 660V UR	OFAX 3 S3 3
DCS880-S01-0590-06	DCS880-S02-0650-06	900A 660V UR	3 x 170H 3006 5

Fuses and fuse holders (details see Technical Data)

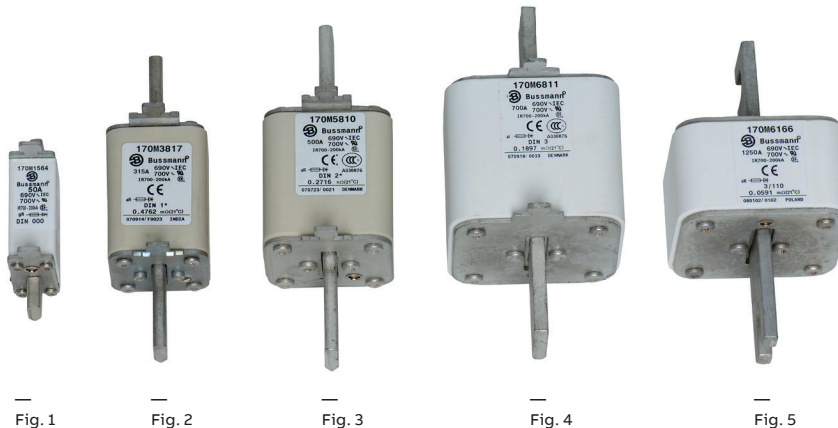

Fig. 1

Fig. 2

Fig. 3

Fig. 4

Fig. 5

Line reactors L1

DCS Type 400V-690V 50/60 Hz		Line choke 1% relative voltage drop	Design fig.	Line choke 4% relative voltage drop	Design fig.
2-Q Converter	4-Q Converter				
DCS880-S01-0020-04/05	DCS880-S02-0025-04/05	ND01	1	ND401	4
DCS880-S01-0045-04/05	DCS880-S02-0050-04/05	ND02	1	ND402	4
DCS880-S01-0065-04/05	DCS880-S02-0075-04/05	ND04	1	ND403	5
DCS880-S01-0090-04/05	DCS880-S02-0100-04/05	ND06	1	ND404	5
DCS880-S01-0135-04/05	DCS880-S02-0150-04/05	ND06	1	ND405	5
DCS880-S01-0180-04/05	DCS880-S02-0200-04/05	ND07	2	ND406	5
DCS880-S01-0225-04/05	DCS880-S02-0250-04/05	ND07	2	ND407	5
DCS880-S01-0270-04/05	DCS880-S02-0300-04/05	ND09	2	ND408	5
DCS880-S01-0290-06	DCS880-S02-0320-06	ND08	2	on request	-
DCS880-S01-0315-04/05	DCS880-S02-0350-04/05	ND09	2	ND408	5
DCS880-S01-0405-04/05	DCS880-S02-0450-04/05	ND10	2	ND409	5
DCS880-S01-0590-06	DCS880-S02-0650-06	ND13	3	on request	-
DCS880-S01-0470-04/05	DCS880-S02-0520-04/05	ND10	2	ND410	5
DCS880-S01-0610-04/05	DCS880-S02-0680-04/05	ND12	2	ND411	5
DCS880-S01-0740-04/05	DCS880-S02-0820-04/05	ND13	3	ND412	5
DCS880-S01-0900-04/05	DCS880-S02-1000-04/05	ND13	3	ND413	5
DCS880-S01-0900-06/07	DCS880-S02-0900-06/07	ND13	3	on request	-
DCS880-S01-1190-04/05	DCS880-S02-1190-04/05	ND14	3	on request	-
DCS880-S01-1200-04/05	DCS880-S02-1200-04/05	ND14	3	on request	-
DCS880-S01-1500-04/05/06/07	DCS880-S02-1500-04/05/06/07	ND15	3	on request	-
DCS880-S01-2000-04/05	DCS880-S02-2000-04/05	ND16	3	on request	-
DCS880-S01-2000-06/07		ND16 *	3	on request	-

* with forced cooling

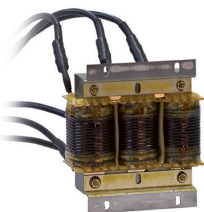

Fig. 1



Fig. 2



Fig. 3

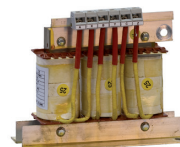

Fig. 4

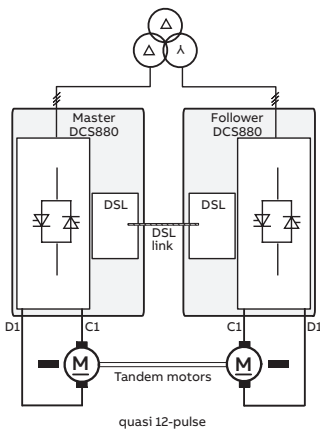

Fig. 5

High power configurations

Converters generate harmonics at the mains. To reduce it is possible to use 12-pulse configuration. Low current harmonic level (THD_cur) results in a minimum voltage distortion (THD_volt) at the PCC.

	5th	7th	11th	13th	THD_cur
6-pulse	21 %	14 %	9 %	7 %	36 %
12-pulse	1 %	1%	6%	7 %	11 %



Quasi 12-pulse Master-Follower configuration

The converters are fed by a 12-pulse transformer with separated secondary windings whose phase positions differ by 30°el.

This configuration delivers the same advantages concerning harmonics to the network as a standard 12-pulse application (see next item), but no T-reactor is needed.

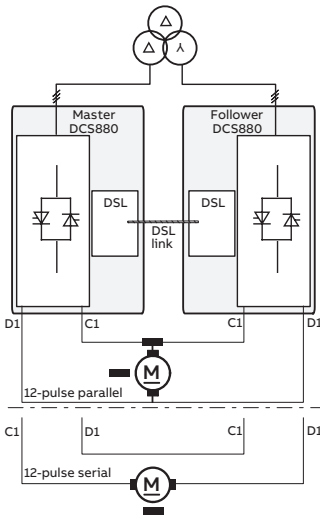

12-pulse parallel, serial or sequential configuration

12-pulse systems are used for reduced line harmonics, reduced motor noise level, enlarged output current or voltage of converter system. Only the 11th and 13th, the 23rd and 25th, the 35th a.s.o. are existing. The harmonics on the DC side are reduced too, which gives a higher efficiency. It is not possible to connect two 12-pulse systems (2 converters, T-reactor and 1 motor) to one 12-pulse transformer.

For more information, please see manual 12-pulse operation.

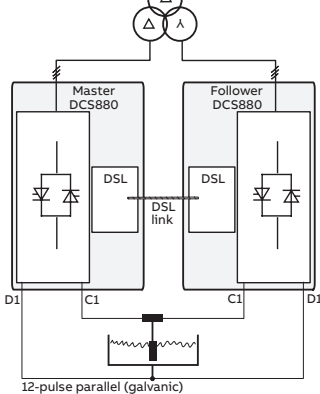

Non motoric, high pulse, high current low output voltage configurations.

DCS880 also supports 6-, 12-, 18- and 24-pulse configurations.

Low output voltages with optimized power factory are realized by dedicated transformers.

Quasi 12-pulse

Frame size	H1 ... H5	H6	H7	H8
max AC voltage	525 V	690 V	800 V	1190 V
typical DC voltage 2Q / 4Q	610 V / 545 V	800 V / 720 V	915 V / 820 V	1380 V / 1235 V

12-pulse parallel

Frame size	H1 ... H5	H6	H7	H8
max AC voltage	525 V	690 V	800 V	1190 V
typical DC voltage 2Q / 4Q	610 V / 545 V	800 V / 720 V	915 V / 820 V	1380 V / 1235 V

12-pulse serial/sequential

Frame size	H1 ... H5	H6	H7	H8
max AC voltage	not usable	2 x 350 V	2 x 600 V	2 x 725 V
typical DC voltage 2Q / 4Q	not usable	800 V / 720 V	1380 V / 1235 V	1600 V / 1500 V

$DC\ output\ voltage = 1.35 \cdot converter\ input\ voltage \cdot 0.9$
 $AC\ current = DC\ current \cdot 0.82$
 $Transformer\ kVA = Converter\ input\ voltage \cdot AC\ current \cdot \sqrt{3}$

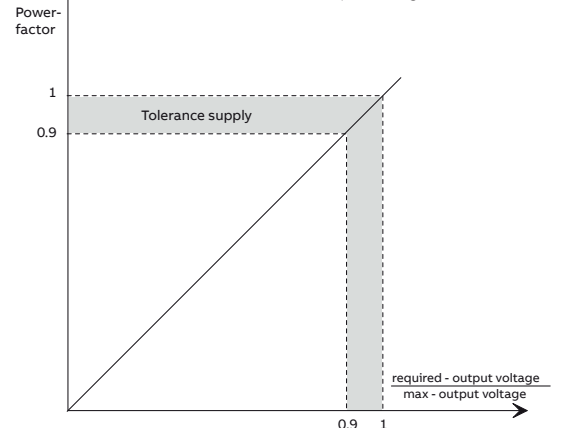

A lifetime of peak performance

You're in control of every life cycle phase of your drives. At the heart of drive services is a four-phase product life cycle management model. This model defines the services recommended and available throughout drives lifespan.

Now it's easy for you to see the exact service and maintenance available for your drives.

ABB drives life cycle phases explained:

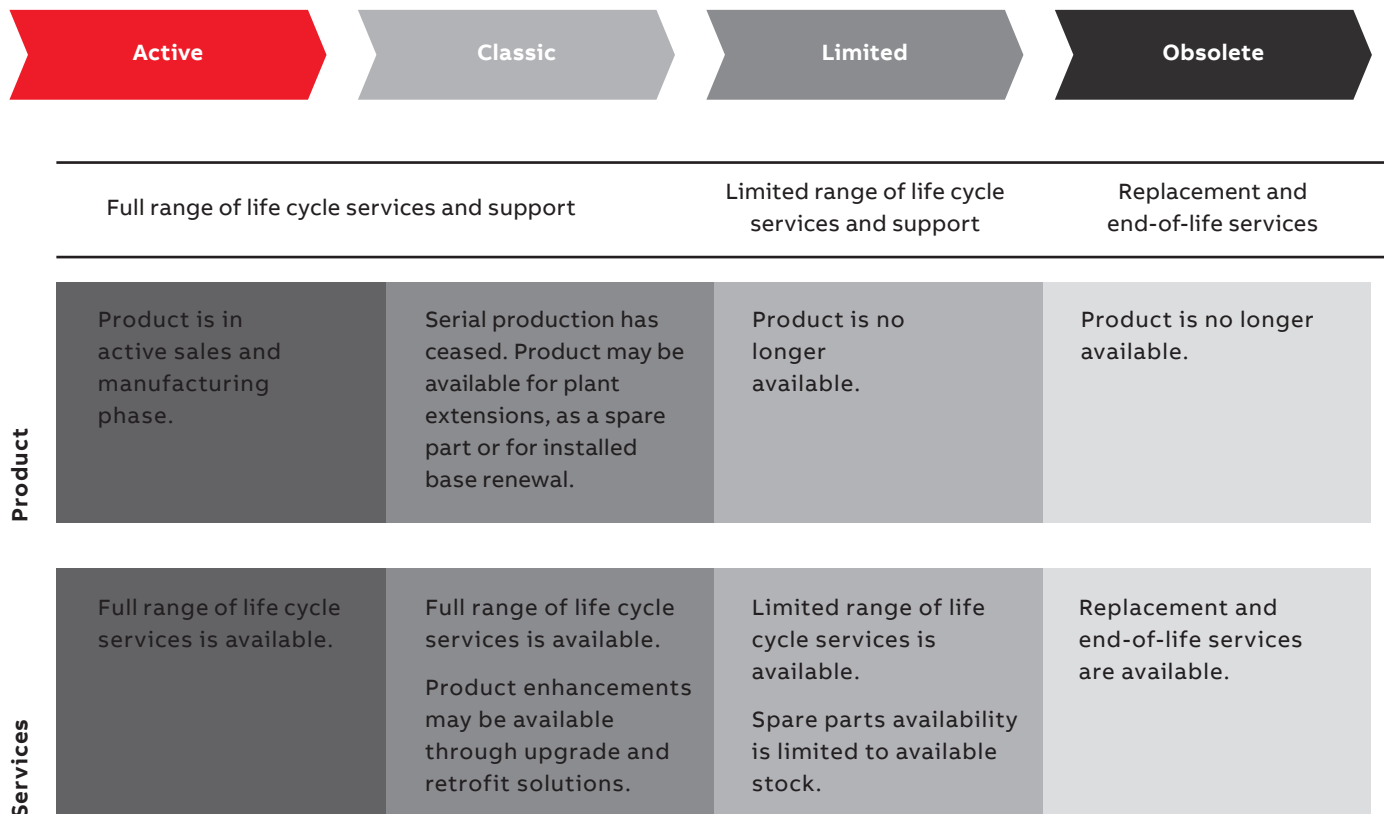

Keeping you informed

We notify you every step of the way using life cycle status statements and announcements.

Your benefit is clear information about your drives' status and precise services available. It helps you plan the preferred service actions ahead of time and make sure that continuous support is always available.

Step 1

Life Cycle Status Announcement

Provides early information about the upcoming life cycle phase change and how it affects the availability of services.

Step 2

Life Cycle Status Statement

Provides information about the drive's current life cycle status, availability of product and services, life cycle plan and recommended actions.

Services to match your needs

Your service needs depend on your operation, life cycle of your equipment and business priorities. We have identified our customers' four most common needs and defined service options to satisfy them. What is your choice to keep your drives at peak performance?

Is uptime your priority?

Keep your drives running with precisely planned and executed maintenance.

Example services include:

- Life Cycle Assessment
- Installation and Commissioning
- Spare Parts
- Preventive Maintenance
- Reconditioning
- ABB Drive Care agreement
- Drive Exchange

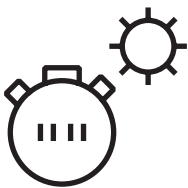

Operational efficiency

Is rapid response a key consideration?

If your drives require immediate action, our global network is at your service.

Example services include:

- Technical Support
- On-site Repair
- Remote Support
- Response time agreements
- Training



Rapid response

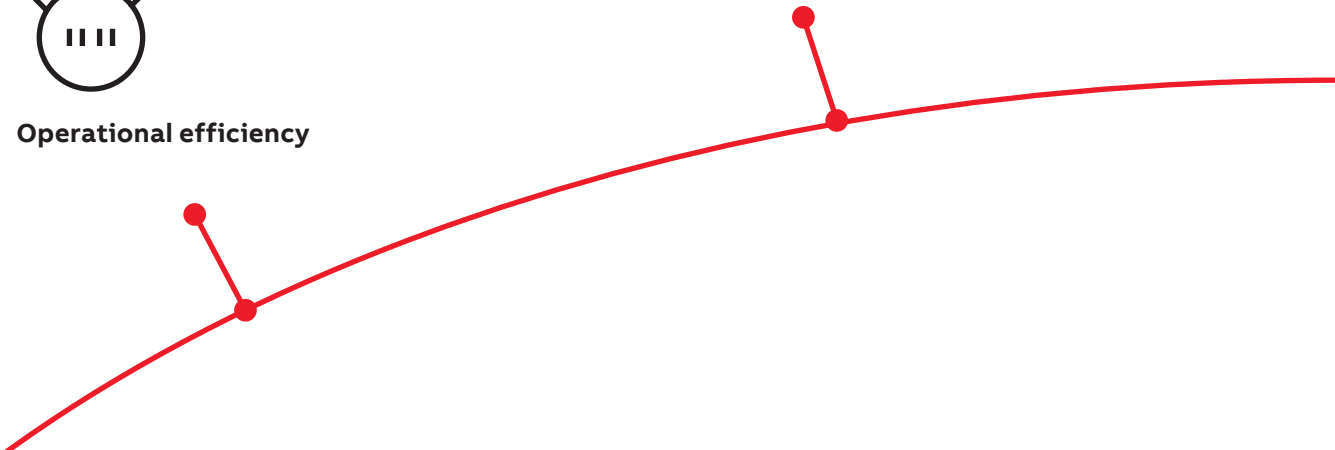

Drives service

Your choice, your future

The future of your drives depends on the service you choose.

Whatever you choose, it should be a well-informed decision. No guesswork. We have the expertise and experience to help you find and implement the right service for your drive equipment. You can start by asking yourself these two critical questions:

- Why should my drive be serviced?
- What would my optimal service options be?

From here, you have our guidance and full support along the course you take, throughout the entire lifetime of your drives.

Your choice, your business efficiency

ABB Drive Care agreement lets you focus on your core business. A selection of predefined service options matching your needs provides optimal, more reliable performance, extended drive lifetime and improved cost control. So you can reduce the risk of unplanned downtime and find it easier to budget for maintenance.

We can help you more by knowing where you are!

Register your drive at www.abb.com/drivereg for extended warranty options and other benefits.

Need to extend your assets' lifetime?

Maximize your drive's lifetime with our services.

Example services include:

- Life Cycle Assessment
- Upgrades, Retrofits and Modernization
- Replacement, Disposal and Recycling



Life cycle management

Is performance most critical to your operation?

Get optimal performance out of your machinery and systems.

Example services include:

- Advanced services
- Engineering and Consulting
- Inspection and Diagnostics
- Upgrades, Retrofits and Modernization
- Workshop Repair
- Tailored services



Performance improvement



ABB Automation products



DCS550

ABB offers the machine building industry a DC drive which combines state-of-the-art drive technology with proven DC technology. The new converter series is suited both for new installations and retrofitting, due to its robust technology and compact design.

Integrated "Winder", programmability and a powerful field converter provide machine manufacturers with a maximum of flexibility in terms of machine integration.



AC500

ABB's powerful flagship PLC offering provides wide range of performance levels and scalability within a single simple concept where most competitors require multiple product ranges to deliver similar functionality.



ACS500

A PLC based modular automation solution that makes it easier than before to mix and match standard and safety I/O modules to expertly meet your safety requirements in all functional safety applications. "Extreme conditions" version is also offered.



Programmability

Drive Application Builder integrates the engineering and maintenance for PLC, drives, motion, HMI and robotics. It complies with the IEC 61131-3 standard offering all five IEC programming languages for PLC and drive configuration. Drive Application Builder supports a number of languages and comes with new libraries, FTP functions, SMTP, SNMP, smart diagnostics and debugging capabilities.

DCT880

ABB's DCT880 offers their customers a thyristor power controller for the accurate control of ohmic or inductive heating elements and infrared radiators in glass, plastic, annealing, drying, melting or heating applications. DCT880 controllers are available in eight compact sizes, ranging from 20 A to 4,200 A.

The integrated three-phase current measurement allows for implementing all load configurations from star, delta, single- and two-phase all the way to reactive-power optimized transformer control.

DCS880-R

The DCS880-R Rebuild Kit replaces the control electronics of an existing DC drive. All power components, including the thyristors, are retained. The DCS880-R Rebuild

Kit is suitable for almost all existing drives from different manufacturers. In addition, ABB has developed specifically tailored solutions for some existing types of converter: this is a cost-efficient option for DC Drive revamping.

All-compatible drives portfolio

The all-compatible drives share the same architecture; firmware platform, tools, user interfaces and options. Yet, there is an optimal drive from the smallest water pump to the biggest cement kiln, and everything in the between. When you have learned to use one drive it is easy use the other drives in the portfolio.

Safety products

ABB safety products are helping machine builders to create production-friendly and safe work environments for operators. We deliver machine safety solutions for single machines or entire production lines. Our long experience of helping customers making solutions for demanding environments has made us experts in combining production demands with safety demands for production-friendly solutions.



Save time, ease troubleshooting and improve drive performance with ABB smartphone apps

Better connectivity and user experience with Drivetune

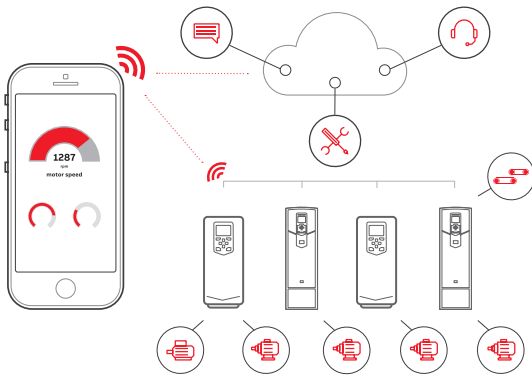

Easy and fast access to product information and support

Manage your drives and the process lines and machines they control



Easy access to cloud-based drive and process information from anywhere via an online connection



Start up, commission and tune your drive and application



Simplified user guidance with instant access to drive status and configuration



Performance optimization via drive troubleshooting features and fast support

Services and support on the go with Drivebase

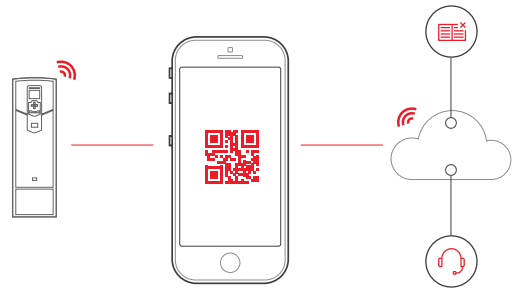

Search for support documents and contacts

Maintain and service all your installed drives on one or multiple sites



Get 6 months extra warranty for free by registering your drive with the Drivebase app



Access your product and service information in the cloud from anywhere



Access your drive's diagnostics data



Push notifications for critical product and service updates

Access information anywhere

Download the apps using the QR codes below or directly from the app stores



GET IT ON Google play



Available on the App Store



Download from Windows Phone Store



Available on the App Store



GET IT ON Google play



Drivetune for commissioning and managing drives

Drivebase for ensured reliability and reduced downtime on production sites

Plus codes

Option	Option code	Description
ACS-AP-I	standard	built-in
no ACS-AP-I	OJ404	No Control panel
ACS-AP-W	+J429	Bluetooth Control panel
DPI-H01	+J428	daisy-chain option
FDNA-01	+K451	Fieldbus DeviceNet
FPBA-01	+K454	Fieldbus PROFIBUS
FCAN-01	+K457	Fieldbus CANOpen
FSCA-01	+K458	Fieldbus Modbus
FECA-01	+K469	Fieldbus EtherCat
FEPL-02	+K470	Fieldbus Ethernet POWERLINK
FENA-21	+K475	Ethernet/IP, Modbus/TCP, Profinet
FEIP-21	+K490	EtherNet/IP™
FMBT-21	+K491	Modbus TCP
FPNO-21	+K492	PROFINET IO
FSPS-21	+Q986	PROFIsafe
FIO-11	+L500	Analog I/O Extension
FIO-01	+L501	Digital I/O Extension
FAIO-01	+L525	Analog I/O Extension 2,
FDIO-01	+L526	Digital I/O Extension 2,
FEN-31	+L502	HTL Encoder Interface
FEN-21	+L516	Resolver Interface
FEN-01	+L517	TTL Encoder interface
FDCO-01	+L503	DDCS communication 10/10 MBd
Application programming	+S551	Memory unit including drive application programming license
no OnBoard field exciter	OS163	Excludes OnBoard field exciter (H1 ... H4)
FEX-425 Int.	+S164	H5 and H6 internal 25 A exciter
SDCS-DSL-H10	+S521	1 DCSLink channel, 0 channels optical power link
SDCS-DSL-H12		1 DCSLink channel, 2 channels optical power link
SDCS-DSL-H14	+S523	1 DCSLink channel, 4 channels optical power link

Additional information

We reserve the right to make technical changes or modify the contents of this document without prior notice. With regard to purchase orders, the agreed particulars shall prevail. ABB AG does not accept any responsibility whatsoever for potential errors or possible lack of information in this document.

We reserve all rights in this document and in the subject matter and illustrations contained therein. Any reproduction, disclosure to third parties or utilization of its contents – in whole or in parts – is forbidden without prior written consent of ABB AG.

—
www.abb.com/dc-drives
www.abb.com/drivespartners

