

review

03|2018 en

Algorithms meet materials

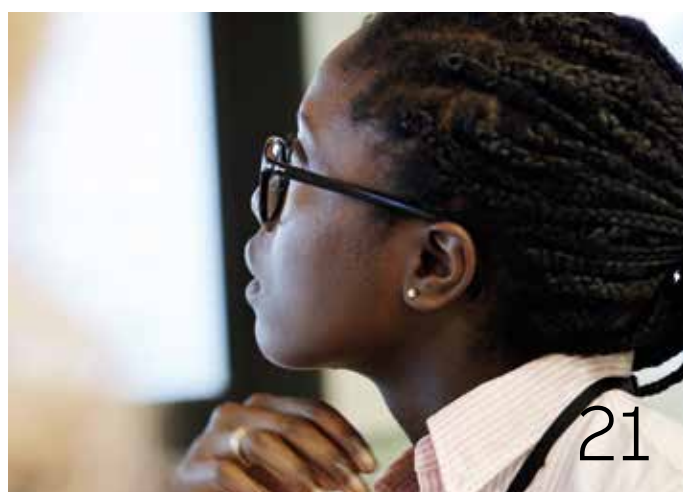

-
- 08–25 Algorithms meet materials
 - 26–43 Transformational trends
 - 44–61 Digital and analytics



46

Power stability for manufacturers



14

Thermoplastic insulation

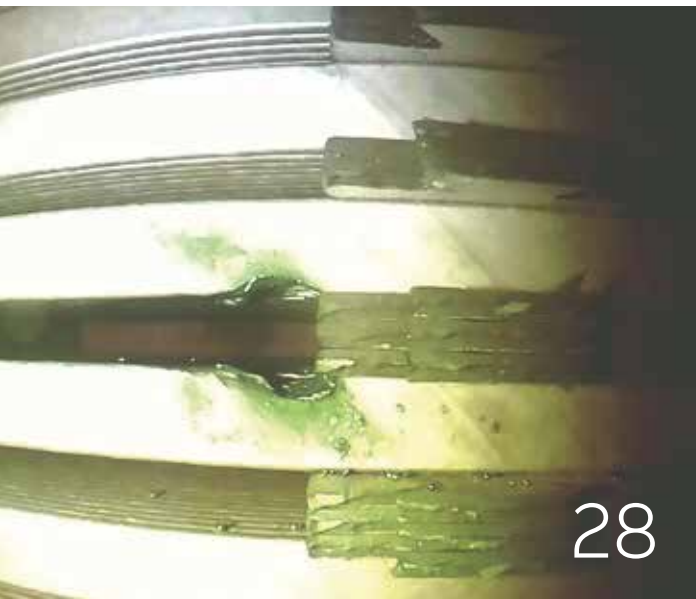

28

TXplore robot inspects transformers

HVDC for offshore wind



36



Modeling of ABB solar inverters

Factory power distribution automation

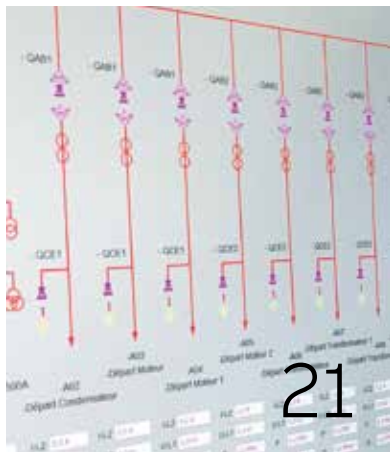

05 Editorial

Algorithms meet materials

- 08 FACTS brings power stability to mining
- 14 Thermoplastic insulation
- 21 Factory power distribution automation

Transformational trends

- 28 TXplore robot inspects transformers
- 36 HVDC for offshore wind

Digital and analytics

- 46 Power stability for manufacturers
- 52 Modeling of ABB solar inverters
- 58 Focusing on cyber security

Buzzword demistifier

- 62 Quantum encryption

63 Imprint

Digitization reaches beyond the collection of vast amounts of data, and the insights they yield, to change the tangible ways technologies and systems are constructed and managed. This issue of ABB Review explores some of the latest examples of where and how businesses are benefiting from it.

As always, your feedback is welcome at abb.com/abbrevreview

EDITORIAL

Algorithms meet materials



Dear Reader,

Industry is entering an unprecedented revolution. Whereas today, many companies build their business on hard-wired factory configurations and installed equipment, in future their competitive advantage will be vested in portable process knowledge and data. Digitization, artificial intelligence and cloud-based services will extend and interconnect knowledge and enable its optimal deployment.

This issue of ABB Review is dedicated to the manufacturing and deployment of materials in connection with smarter digital methods. This includes use of advanced simulation techniques in designing products, the use of robots in inspection and analysis of equipment, and advanced factory control.

Digital technologies greatly improve productivity, but potentially create vulnerability to cyber-attacks. ABB is continuously challenging the status quo in security to be able to offer the highest levels of security. This journal looks at ABB's activities in the fields of cybersecurity and quantum-based encryption.

Enjoy your reading!

A handwritten signature in red ink, appearing to read 'Bazmi Husain', written in a cursive style.

Bazmi Husain
Chief Technology Officer



Algorithm meet mat





ns

erials

Operators of mission-critical technologies rely on established performance criteria. ABB is using advanced data science to research, develop, and test materials that can innovate those systems, like replacing pressboard with thermoplastic radial spacers in transformer windings, and replacing mechanical components of mill drives with gearless motors.

- 08 FACTS brings power stability to mining equipment
- 14 Thermoplastic insulation in power transformers
- 21 Sweet success – power distribution automation for a sugar factory



ALGORITHMS MEET MATERIALS

FACTS brings power stability to mining equipment

Giant gearless mill drives (GMDs) are used extensively to power grinding mills that crush ore. As mine owners opt to increase productivity at existing mines rather than open new ones, more GMDs can be added to an already-loaded power grid. Under these difficult conditions, ABB's FACTS ensure grid stability.



Jose Luis Olabarrieta Rubio
ABB Ring Motors
Trapagarán, Spain.

jose-luis.olabarrieta@es.abb.com

In the mining industry, several different types of mill are used to grind ore into smaller pieces for further processing: Ball mills consist of a rotating horizontal hollow cylinder, with an abrasion-resistant interior. The grinding is performed by free-moving stone, metal or rubber balls that are lifted to a certain height by natural adhesion to the inside of the cylinder. Autogenous (AG) mills are similar but have internal lifting plates and use

GMDs are high-efficiency, variable-speed motors and are considered the most effective solution for high-power mills.



Pablo Eguia
Department of Electrical Engineering, University of the Basque Country
Lejona, Spain

large ore particles as the grinding media. If the ore is too hard or abrasive, steel balls may be added – the mill is then called a semi-autogenous (SAG) mill. AG and SAG mills can be used as a one-stage grinder but are often used as the first stage in a two- or multiple-stage grinding process, where the second stage is carried out by the ball mill.





01

—
 01 Mining companies often opt to expand an existing mine rather than open a new one. ABB FACTS devices allow power-hungry machines such as GMDs to be added without jeopardizing local grid stability. Shown is one of three ABB-installed GMDs at the Esperanza gold and copper mine in Chile.

These mills can be driven by induction motors (low-cost but poor efficiency due to gearbox losses), synchronous motors (which are limited in power to around 9 MW per pinion) or gearless motors, the so-called GMDs. GMDs are high-efficiency, variable-speed motors with powers up to 30 MW and are considered the most effective solution for high-power mills, especially when the total cost of ownership is considered. The GMD's synchronous motor is fed by a cycloconverter, which is a device that converts AC to a lower frequency AC with no intermediate DC link [1].

GMDs have the huge advantage that they eliminate all the mechanical components of a conventional mill drive system, such as the ring-gear, pinion, gearbox, coupling, motor shaft and bearings, thus offering better energy efficiency, superior reliability, increased process availability and longer lifespan →1.

—
 02 Active and reactive power consumed by the startup of a SAG motor at 1,200 s.

—
 03 Nominal voltage drops by about 1.4 percent in different power buses after a new motor startup at 1,200 s.

Mine expansion

The opening and exploitation of a new mine is a complex undertaking. Environmental impact and engineering assessments have to be carried out, and a bewildering array of permissions, licenses, agreements, and authorizations (construction, explosives, etc.) obtained. As a result, mine owners often choose to increase the productivity of existing mines by expansion instead of opening new ones. A typical mine has one or two SAG mills and two to four ball mills; an expansion usually entails adding one more of each type.

—

ABB's FACTS is based on power-electronics controllers that increase the network's transmission capacity and stability margin, and improve its dynamic behavior.

Vulnerabilities of electrical systems in mines

When adding new mills to an existing mine infrastructure, a paramount consideration is the robustness of the electrical grid - ie, its ability to supply steady voltage and frequency irrespective of load and grid disturbances. Some grids benefit from synchronous generators – which not only satisfy the power demand but also provide voltage and frequency stability – but others do not, leaving the grid vulnerable to voltage and frequency excursions at the slightest perturbation, such as a motor startup or small load variation. Mine grids are usually of this weak type – ie, with low short-circuit power and mainly resistive, with low-ratio reactance/resistance.

Moreover, mines are often located in remote areas and at the end of long transmission lines, which makes the power supply even weaker, and more vulnerable and unpredictable. In these weak grids, the active and reactive power consumption of GMDs, generators, lines and transformers lead to voltage drops and poor power quality →2-3. In such situations, voltage stability is a critical consideration in improving power security and reliability [2].

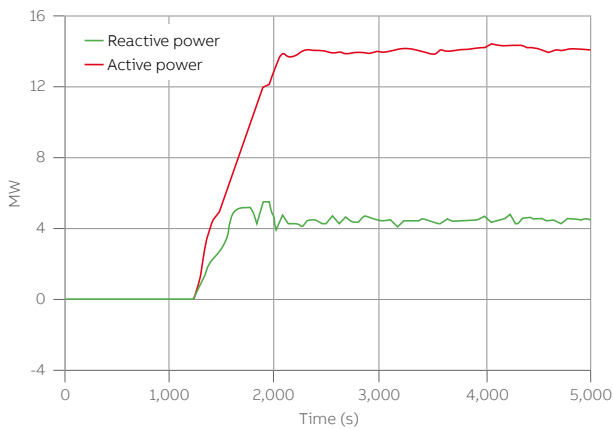

02

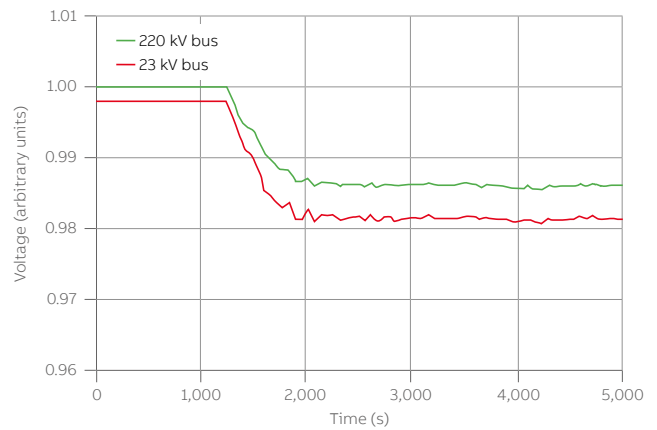

03

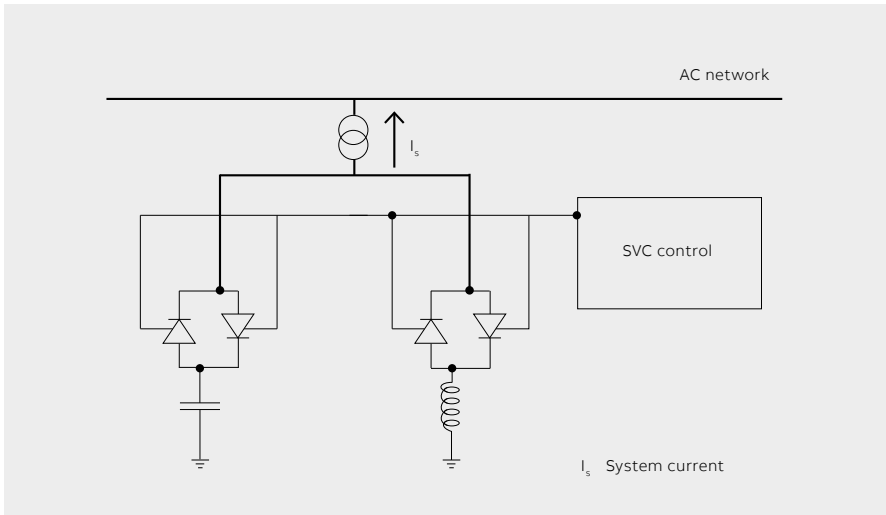

04

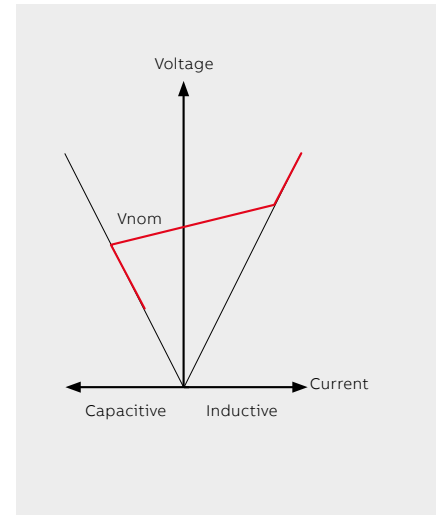

05

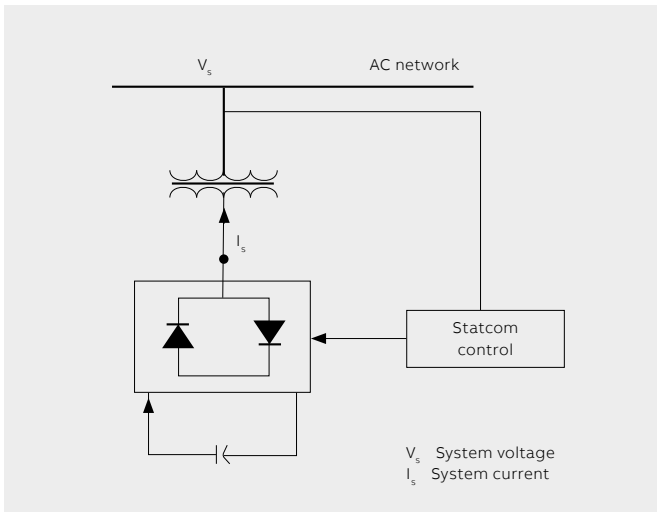

06

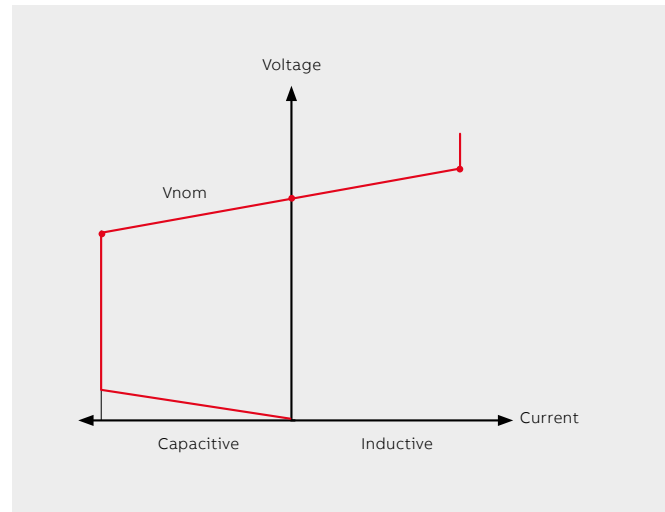

07

— 04 SVC electrical diagram.

— 05 The SVC V-I characteristic indicates that regulation with a slope around the nominal voltage (Vnom) can be obtained in the normal operating range defined by the maximum SVC inductive and capacitive currents. These maximum currents depend on the system voltage.

— 06 STATCOM.

— 07 The STATCON V-I characteristic, which shows that a STATCOM can provide capacitive and inductive current independent of the system voltage.

FACTS devices

In a power network, the ability to transfer AC power is restricted by transient stability considerations and thermal, voltage and short-circuit current limits. ABB's FACTS (Flexible Alternating Current Transmission Systems) is a concept based on power-electronics controllers

SVCs and STATCOMS are the most common FACTS shunt devices found in mining.

that increase the network's transmission capacity and stability margin, and improve its dynamic behavior [3-5]. FACTS also incorporates power-electronics devices to supply inductive or reactive

power to the grid. The main capabilities of these devices are reactive power compensation, voltage control and power flow control. Among FACTS devices one can distinguish between series and shunt types:

- For shunt compensation, the SVC (static var compensator) and the STATCOM (static compensator) operate as reactive power compensators.
- For series compensation, the most important devices are the TCSC (thyristor-controlled series compensator) and the SSSC (static synchronous series compensator), which increase or decrease the transfer reactance of the power line at the rated frequency.

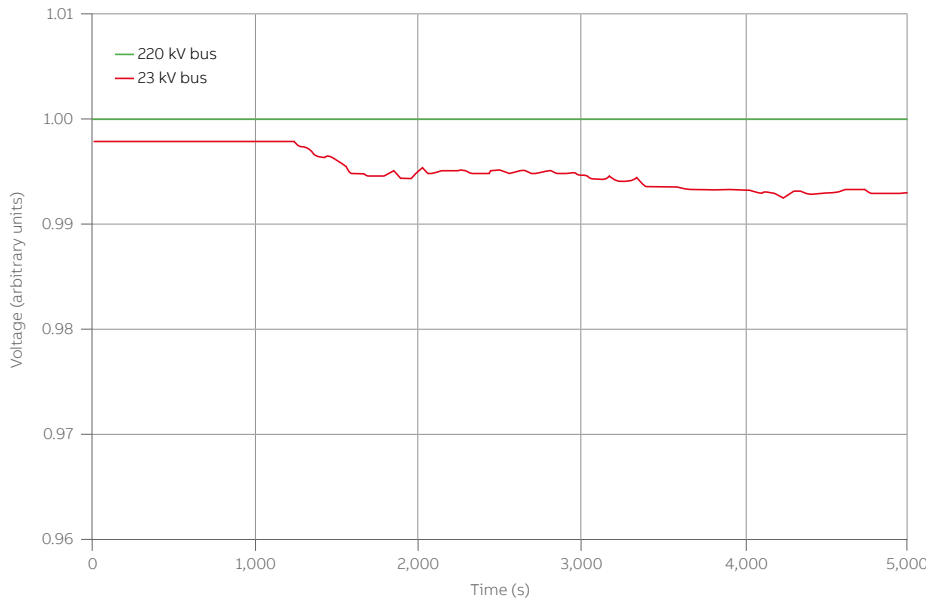

08

08 Simulation of bus voltages after the start up and nominal operation of new GMDs with a STATCOM on the 220 kV bus.

09 Reactive power injected by FACTS device.

References

- [1] A. Symonds, M. Laylabadi, "Cycloconverter Drives in Mining Applications," IEEE Industry Applications magazine Nov/Dec 2015.
- [2] J. Pontt, et al., "Current issues on high-power cycloconverter-fed gearless motor drives for grinding mills," IEEE International Symposium on Industrial Electronics, 2003.
- [3] ABB FACTS. Available: <http://new.abb.com/facts>
- [4] N. G. Hingorani, L. Gyugyi, "Understanding FACTS: concepts and technology of flexible AC transmission systems," Wiley-IEEE Press, 1999.
- [5] K. B. Bimal, "Power Electronics and Motor Drives: Advances and Trends," p. 126, Academic Press, 2006.

These devices are installed worldwide in electrical substations, railways, mining complexes, HVDC (high-voltage DC) stations, renewable energy plants, etc. The total power of shunt devices installed worldwide adds up to about 95,000 MVA while that of series compensation devices is around 360,000 MVA.

For mining applications, shunt devices are preferred and these are commonly installed on the same bus as GMDs. SVCs and STATCOMS are the most common FACTS shunt devices found in mining and their task is to:

- Ensure contractual power exchanges by balancing reactive power
- Maintain power quality despite huge demand fluctuations
- Improve static or transient stability

A STATCOM can compensate for the voltage drop caused by the installation of a new GMD.

SVC

An SVC consists of a combination of thyristor-switched capacitors (TSCs) and thyristor-switched reactors (TSRs) or thyristor-controlled reactors (TCRs) that behaves like a shunt-connected variable reactance. This arrangement either generates or absorbs reactive power in order to regulate the voltage magnitude at the point of connection to the AC network. Coordinated control varies the reactive power at the SVC output, thus continuously varying the capacitive and inductive ratings of the system →4-5.

STATCOM

A STATCOM is equivalent to a controllable voltage source behind a reactance. A STATCOM is a shunt-connected reactive compensation device, capable of producing or absorbing reactive power in the capacitive and inductive range to maintain control over specific system electrical parameters →6-7.

FACTS in mining

To compensate for the voltage drop caused by the installation of a new GMD in a mining application as described above, a shunt device can be chosen – specifically, a STATCOM, due to its ability to provide capacitive and inductive current independent of the voltage level. The STATCOM's required capacity can be described as:

$$\Delta U(\%) = Q/S_{cc} * 100$$

Where,

$\Delta U(\%)$ = percentage of the voltage level to recover, with reference to nominal voltage.

Q = Reactive power of the FACTS system.

S_{cc} = short-circuit power in the bus in which the FACTS system is placed.

Thus, a 40 MVAR STATCOM will be able to recover 4 percent of the nominal voltage in a bus where the short-circuit power is 1,000 MVA. A STATCOM with this rating can control bus voltage and recover any sags caused by, for example, motor starts. A simulation of bus voltages after the start and nominal operation of new GMDs with a STATCOM

—
By taking advantage of ABB's FACTS products, new GMDs and associated equipment can be smoothly integrated into the local power grid without weakening it.

(on the 220 kV bus) is shown in →8. At 1,200 s the first motor starts, consuming active and reactive power and inducing a voltage drop of 1.4 percent. STATCOM control reacts to this by injecting reactive power to compensate the 220 kV bus voltage. As a result of this reactive power injection, the 23 kV bus voltage is also compensated, keeping it above 99 percent of nominal voltage. A second motor is switched on at 2,800 s, causing the STATCOM to inject more reactive power to compensate for this new drop.

→9 shows the reactive power in MVARs injected by the STATCOM. Two reactive power injection events can be discerned: at 1,200 s, when the first GMD starts, and at 2,800 s, when the second GMD motor starts. This reactive power injection stabilizes the system voltage.

The addition of a further GMD allows mining enterprises to achieve higher production and productivity in an existing location and saves them the huge effort involved in opening up a new mining complex. By taking advantage of ABB's FACTS products, new GMDs and associated equipment can be smoothly integrated into the local power grid without weakening it. Indeed, already weak grids will be strengthened by the addition of, for example, SVC or STATCOM devices. ●

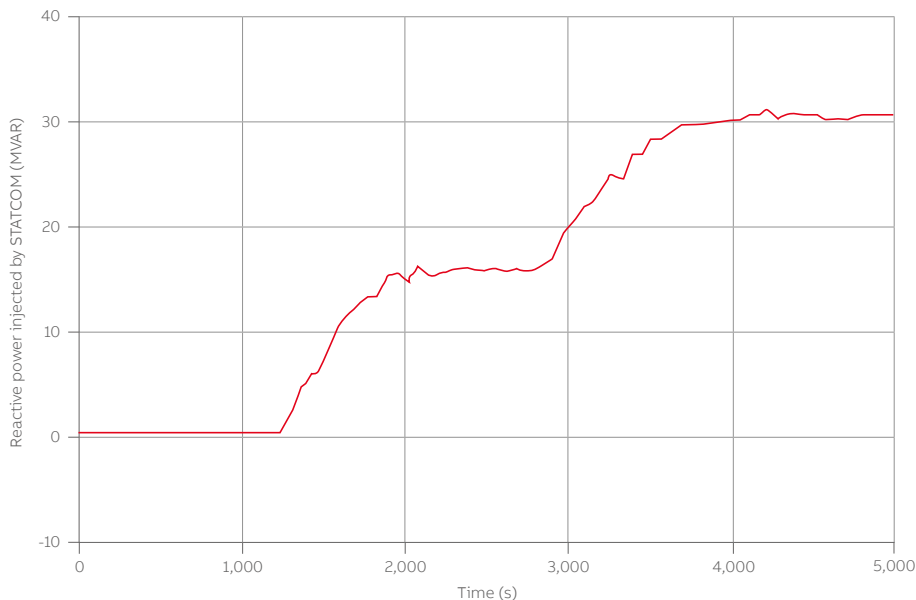

 ALGORITHMS MEET MATERIALS

Thermoplastic insulation in power transformers

ABB has developed and successfully tested thermoplastic radial spacer insulation for oil-filled transformers. By applying the injection molding technique and a new flexible molding tool, a rapid and cost-effective production method was developed to give customers a robust and reliable alternative to pressboard.

Adam Michalik
Renata Porębska
 Corporate Research Center
 Kraków, Poland

adam.michalik@pl.abb.com
 renata.porebska@pl.abb.com

Su Zhao
Orlando Girlanda
Harald Martini
 Corporate Research Center
 Västerås, Sweden

su.zhao@se.abb.com
 orlando.girlanda@se.abb.com
 harald.martini@se.abb.com

Claire Pitois
 ABB Product Group
 Västerås, Sweden

claire.pitois@se.abb.com

ABB is the world's most reliable transformer producer offering customers a complete range of transformers, components and services – identifying individual needs to provide optimal solutions. In response to changing market

In 2011, ABB corporate research centers initiated a collaborative project to identify new material for use in transformer spacer construction.

conditions, ABB has expanded its transformer product family investing in innovation, product and process improvement →1. Currently, ABB is exploring the suitability of new materials for transformer components and redefining production processes to develop the best products possible →2.



—
01 ABB's power transformers are constructed with the expertise and experience of over 100 years.

Radial spacer – small but significant

One of the key insulation components of the typical oil-filled disk-type transformer is a radial spacer. This relatively small element is placed in the heart of the transformer windings and assures the correct distance between each of the transformer's stacked winding disks →2. The spacer must be capable of carrying a constant mechanical load, which arises from the clamping forces and – in case of a short circuit – an additional large load

—
Thermoplastic spacers have excellent dimensional stability and reliability, which guarantees the long-term mechanical performance of the winding.

caused by electro-dynamic forces. Moreover, the spacer must be able to withstand operation temperatures from 98 °C to 110 °C [1,2] and rapid increases in temperature of short duration due to possible overloads. Furthermore, these structures must resist interaction with the transformer oil.

Pressboard has been the product of choice for spacers and insulation transformer components. Developed in the early mid-twentieth century, pressboard is lightweight and well-suited for the demanding mechanical and electrical requirements of transformers. Hence, research and development to investigate the usefulness of other materials was, for a long time, neither considered economical nor technically feasible [3]. Pressboard is used for spacing in most types of transformers today, ranging from small distribution transformers to large power transformers. The only exceptions to these applications are for special transformers, which require extremely high operating temperatures [4,5] or extra-safe solutions, such as traction transformers. In such cases, high performance man-made aramid-based materials are used because of its high strength and nonconductivity.

01

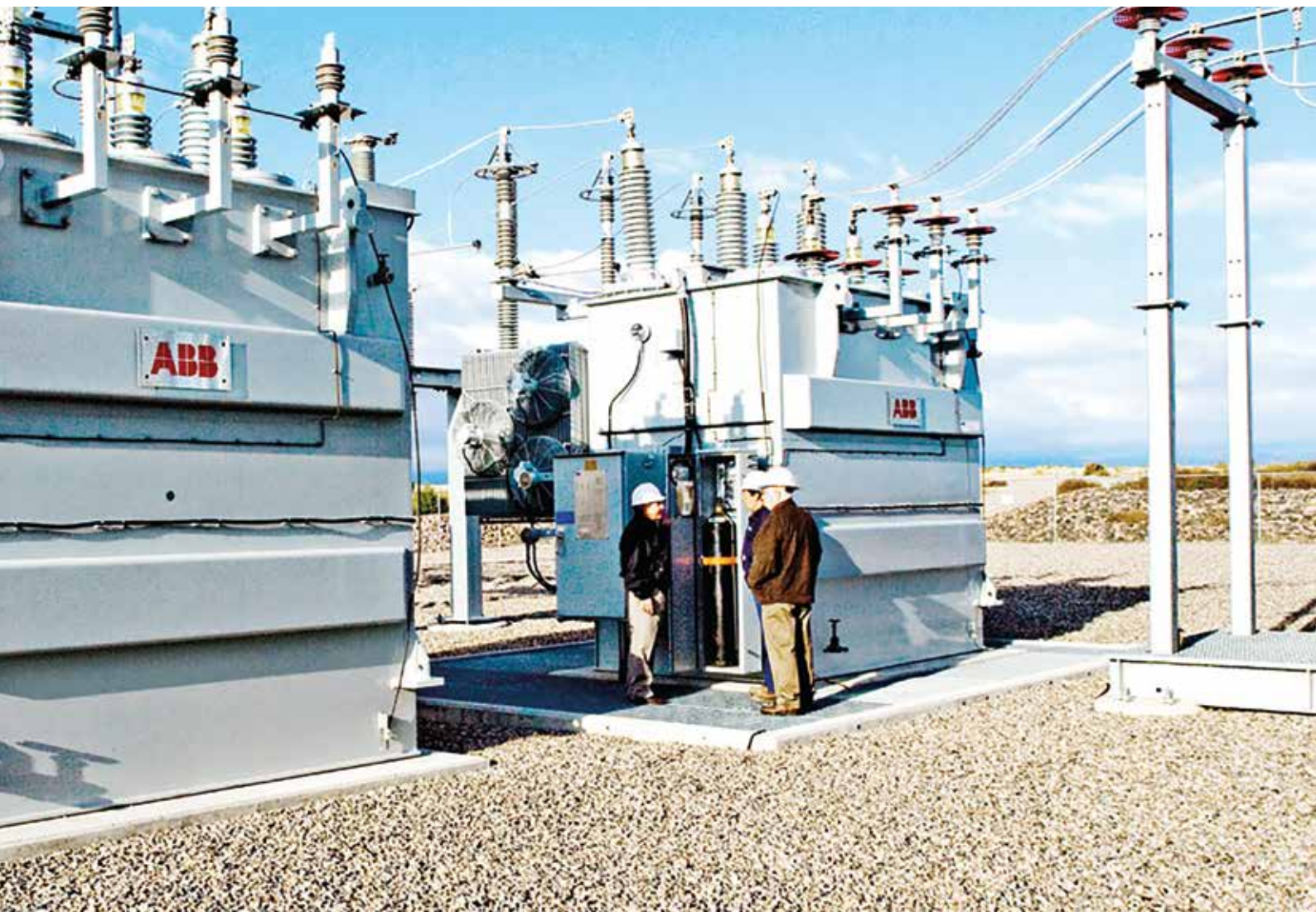



02

Plastic alternatives

After decades of using pressboard as a base material for transformer insulation, ABB believes that the manufacturing market is ready to explore additional innovative materials to improve customer choice. The availability and rapid development of plastics with unique properties suggest applications that have never been possible before. Modern plastics have improved mechanical and thermal properties such as high RTI index, high deflection temperature and high compressive strength; this makes plastic a potential candidate to act dually as a support and insulation material for transformers. Furthermore, breakthroughs in manufacturing processes allow simple and energy efficient production, which increases the attractiveness of plastics.

Generally, plastics are characterized by low rates of water absorption from ambient humidity – in some grades of thermoplastic, water uptake might even be < 1 weight percent — advantageous because water molecules inside the insulation material negatively impact its electrical properties and could impact spacer and winding assembly. Therefore, pressboard spacers and other insulation components are dried: initially, following the winding assembly phase and a second time, just prior to their impregnation with oil [6]. Evacuation

—
The use of new materials such as plastic could eliminate or diminish the need for the drying or sizing steps, thereby saving energy and accelerating production efficiency.

of the absorbed water from the insulation elements can result in dimensional change due to shrinkage. Hence, a special sizing procedure is applied to achieve the desired dimensions of the assembled winding following the drying process. Both the drying and sizing processes require time, effort and a considerable amount of energy [6]. The use of new materials such as plastic could eliminate or diminish the need for these steps, thereby saving energy and accelerating production efficiency.



—
02 Typical power transformer production facility, ABB Monselice, Italy.

—
03 Schematic of transformers showing internal windings and insulation.

Drawing on more than 100 years of experience in transformer production and development in many production facilities, ABB knows that in today's competitive marketplace, utility, rail and other transformer customers trust ABB's know-how and expertise when it comes to insulation. Plastics with superior thermal features and the ability to absorb negligible amounts of water would be ideally-suited as radial spacers and would enable a sleeker production process, which could eliminate or reduce the need for the first drying step and possibly the sizing step. The improved operational efficiency and lower manufacturing costs that result, could translate to real savings for customers who seek alternative radial spacers.

—
The behavior of transformers with thermoplastic spacers was successfully verified under the most onerous operation conditions, such as network short circuit events.

Thermoplastics

In 2011, ABB corporate research centers, initiated a collaborative project with the aim of identifying a material for use in spacer construction that would allow new functional capabilities, thereby providing customers with an improved tangible alternative to pressboard in power transformers. Additionally, the teams sought a quicker, more reliable and cost-effective production method to ensure high precision of produced elements.

Thermoplastics were considered an ideal insulation material for power transformers due to their molecular structure that allows them to melt and remold repeatedly when heat is applied and because they are easy to manufacture. They are increasingly used for diverse electrical devices in the low voltage product segment and have been recently introduced to medium and high voltage applications where they are installed as housing in embedded poles, having replaced conventional epoxy, to provide mechanical support and electric insulation.

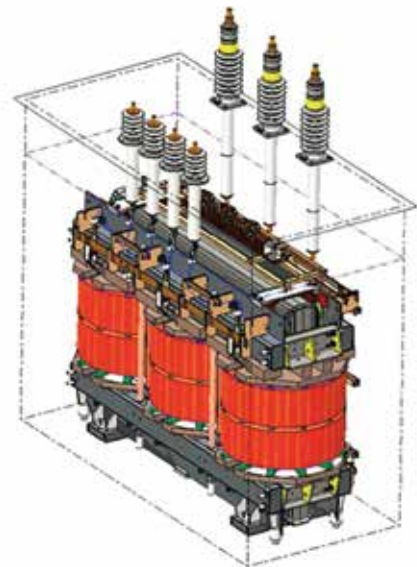
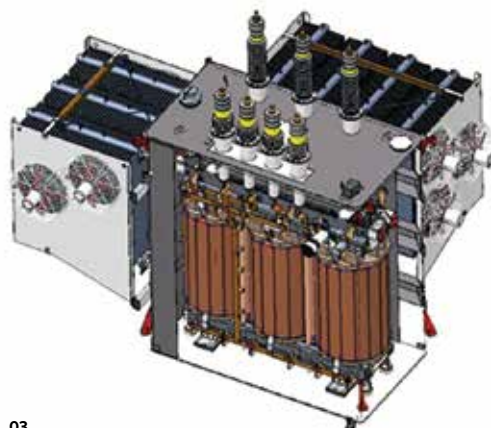

Based on the vast range of thermoplastic grades currently available, surprisingly few have been evaluated for their feasibility in power transformers. Those tests conducted, verified the excellent properties of thermoplastics: stable mechanical behavior under load conditions,

—

Power transformers designed and optimized for specific orders and requirements necessitate a flexible manufacturing process.

even during overload, chemical compatibility or resistance to degradation from interaction with oil, low moisture uptake and customary electrical withstand. Thermoplastic spacers were crafted, and installed within the winding stacks and tested →4, 5a and found to have excellent dimensional stability and reliability, thereby guaranteeing a long-term mechanical performance of the winding →5b.

Thermal behavior was also successfully tested. The tolerance of high temperatures means that the risk of thermal failure related to the winding hot spot is greatly reduced. Use of thermoplastics as spacers therefore make transformers tough and robust.

Efficient process

ABB sought a production method that was fast enough to provide the required large number of spacers (thousands per single transformer) and flexible enough to enable continual variation in the size of the spacers for each manufactured unit due to client order requirements and a rapid response time. Furthermore, the manufacturing process had to ensure superior production precision, homogeneity and excellent reproducibility.

The injection molding technique, conventionally used for processing thermoplastics, was chosen and yet proved to be technically challenging because of the variety of spacer sizes to be produced. This technique has been primarily used for mass production of objects with a fixed geometry. During the process, liquid polymer is injected into the molding cavity with its specific dimensions — only a specific element size can be produced using a single molding tool. Transformers designed and optimized for specific orders and requirements necessitate a flexible manufacturing process in terms of size of the winding and spacers. ABB developed a special molding tool to solve this challenge →6.



04a

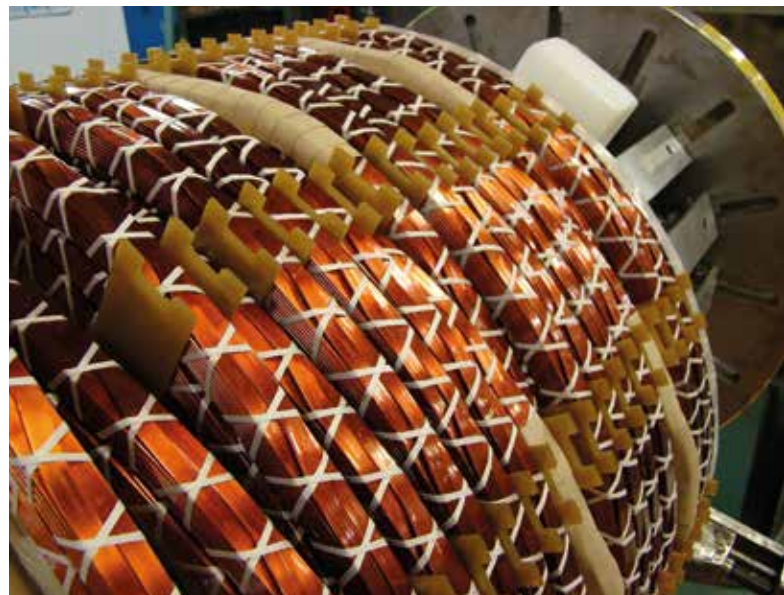

04b

—
04 Thermoplastic radial spacers are stacked and placed within the transformer windings.

04a Thermoplastic radial spacers are shown.

04b Thermoplastic radial spacers provide additional support and electric insulation to winding stacks.

—
05 The installed thermoplastic spacers provide stability.

05a Assembly of the transformer winding stacks using thermoplastic spacers.

05b Transformer winding ready for use.



05a



05b

The modular tool, equipped with adjustable walls, provides the ability to change the spacer length over a continuous range, thereby completely covering the size range required for power transformers. The tool is equipped with multiple molding cavities allowing simultaneous production of a few spacers in less than one minute per single injection cycle.

—
ABB developed a special molding tool equipped with adjustable walls to change the spacer length over a continuous range.

ABB's simulation support team applied their knowledge and experience of advanced multiphysics simulation techniques to the design process, thereby eliminating the traditional trial and error optimization iterations traditionally performed and accelerating the design process.

Finally, after optimization of the process parameters was performed, the tolerances of the spacer thickness could be successfully reduced to ± 0.015 mm — ensuring precision of production, reproducibility and homogeneity of the prototype.

Tests of thermoplastic spacers in power transformers

Rigorous studies of transformers with thermoplastic spacer components yielded exemplary results. To date, transformers with thermoplastic spacers have passed all routine and type tests, including temperature rise with overload tests and dielectric tests. The behavior of transformers with thermoplastic spacers used to separate the stacks of winding was successfully verified under the most onerous operation conditions, such as network short circuit events. Full short circuit tests, were conducted and repeated with success as were visual inspections of the active parts of the components and the individual windings.

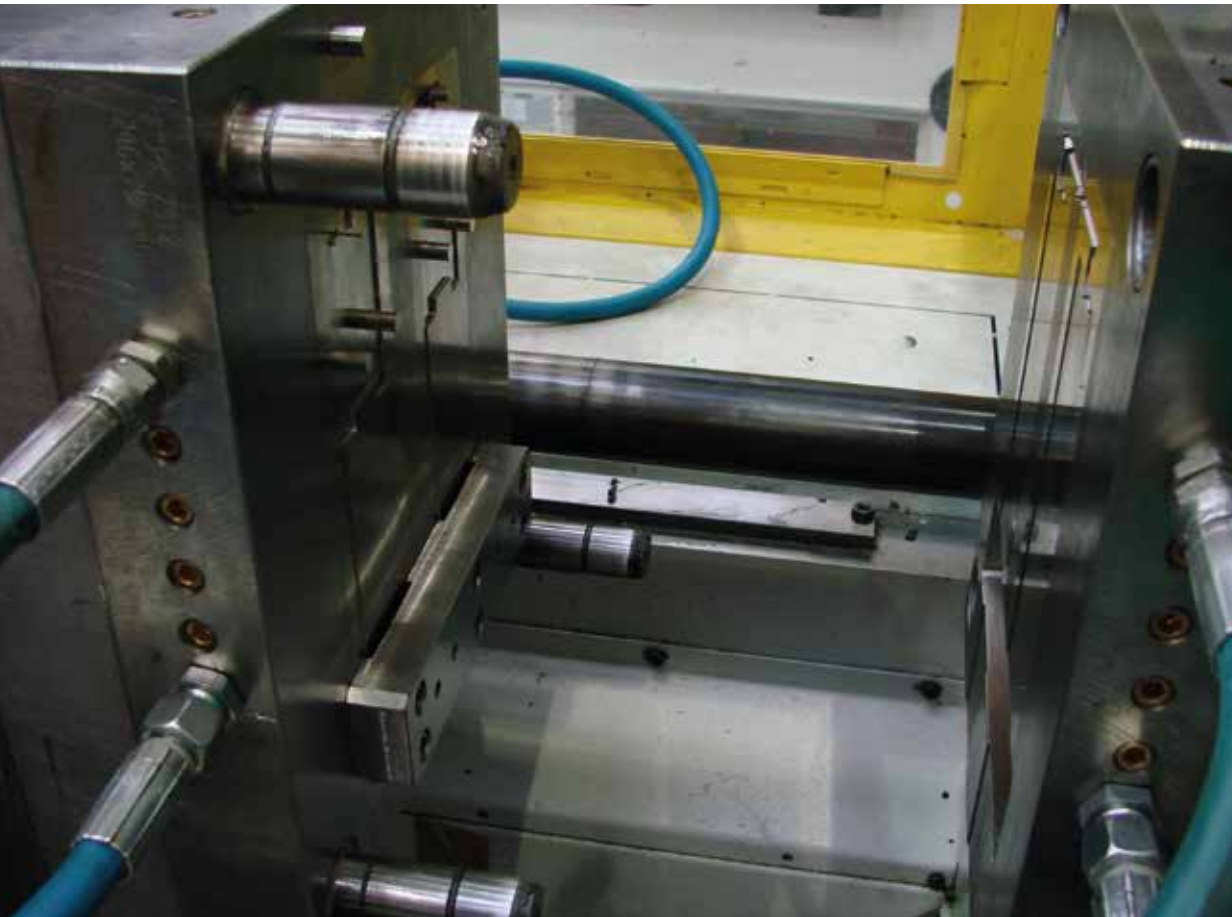

06

—
06 The molding tool allows the radial spacer length to be adjusted according to customer specifications.

References

- [1] IEEE Standard for General Requirements for Liquid-Immersed Distribution, Power, and Regulating Transformers, IEEE C57.12.00: 2015.
 [2] IEC Power transformers – Part 1-7, IEC 60076: 2011.
 [3] IEC Pressboard and press paper for electrical purposes – Part 1 - 3, IEC 6064: 2004.
 [4] IEC Power transformers - Part 14: Liquid-immersed power transformers using high-temperature insulation materials, IEC 60076-14, 2013.
 [5] IEEE Standard for the Design, Testing, and Application of Liquid-Immersed Distribution Power, and Regulating Transformers Using High-Temperature Insulation Systems and Operating at Elevated Temperatures, IEEE C57.154: 2018.
 [6] M.J. Heathcote, "The J&P Transformer Book: A Practical Technology of the Power Transformer", 12th edition, Newnes, Oxford, 1998.

Future insights

The addition of an entirely new thermoplastic radial spacer to ABB's palette of power transformer insulation products ensures customers can access

—
The addition of the new thermoplastic radial spacer to ABB's palette of power transformer insulation products ensures customers can access the right spacer.

the right spacer for the demanding requirements of today's transformer market. This product will be of particular interest to customers in the US market where the use of cellulose-free insulation material is an ABB solution. The combination of this type of insulation material with thermoplastic spacers will allow the elimination of the drying step.

ABB's research teams effectively responded to the availability of new materials to develop a reliable and cost-effective product to stabilize and electrically insulate the transformer winding. The production process has been perfected and simplified; new and modifiable tools help to further stream-line the manufacturing process. The elimination of some production steps while maintaining product quality and improving reliability means a better product for customers.

The significance of using thermoplastic for this new product extends beyond its application for radial spacers. The success of this material, newly adopted for spacers, helps to pave the way for the use of advanced materials for insulation components in the future. ●

ALGORITHMS MEET MATERIALS

Sweet success – power distribution automation for a sugar factory

With its future-oriented concepts and visualization capabilities, ABB's power distribution automation system is helping Sucrivoire boost productivity and safety in their Ivory Coast sugar plant.



Benjamin Kabeya
ABB Technology SA
Yamoussoukro,
Ivory Coast

benjamin.kabeya@
ci.abb.com

Since 1970, annual sugar production in the Ivory Coast has risen from virtually zero to around 200,000 metric tons. A recently privatized state company, Sucrivoire – now a subsidiary of the SIFCA Group, an agribusiness group based in the Ivory Coast – is a major player in this rapidly expanding sugar market. Sucrivoire manufactures and sells multipurpose quality cane sugar that is

used in syrups, baking products and medicines. Sucrivoire's factory has an annual sugar production capacity of 110,000 t, generated from their 11,000 hectares of sugar cane plantations. Production is on track to increase to 118,000 t by 2020.

01



With a single major facility, large annual production quantities and ambitious plans to expand the amount of produce, it is clear that plant uptime is a parameter of the utmost importance for Sucrivoire – particularly during seasonal production peaks.

—
To combat power disruptions, Sucrivoire opted to employ ABB’s latest power distribution automation technology.

One major cause of downtime for Sucrivoire is disruption in the power supplied to the plant. To combat this threat, Sucrivoire opted to employ ABB’s latest power distribution automation technology.

The new ABB distribution automation system combines digital technologies, conventional devices and plug-in applications that enable operators to monitor and quickly obtain a visual overview of the power infrastructure. They are also presented with a list of alarms and trends related to plant operations. This information enables them to reduce power disruptions or restore the supply speedily in case of outages, thereby minimizing unnecessary downtime →2-3. Further, the flexibility of the new distribution automation technology allows for quick and accurate measurement of key production parameters, which enables higher productivity and improved plant safety.

02



—
01 The new ABB distribution automation system combines digital technologies, conventional devices and plug-in applications that enable operators to monitor and quickly obtain a visual overview of the power infrastructure.

—
02 Comprehensive visualization of the plant's power situation allows optimization of operations.

—
03 System overview.

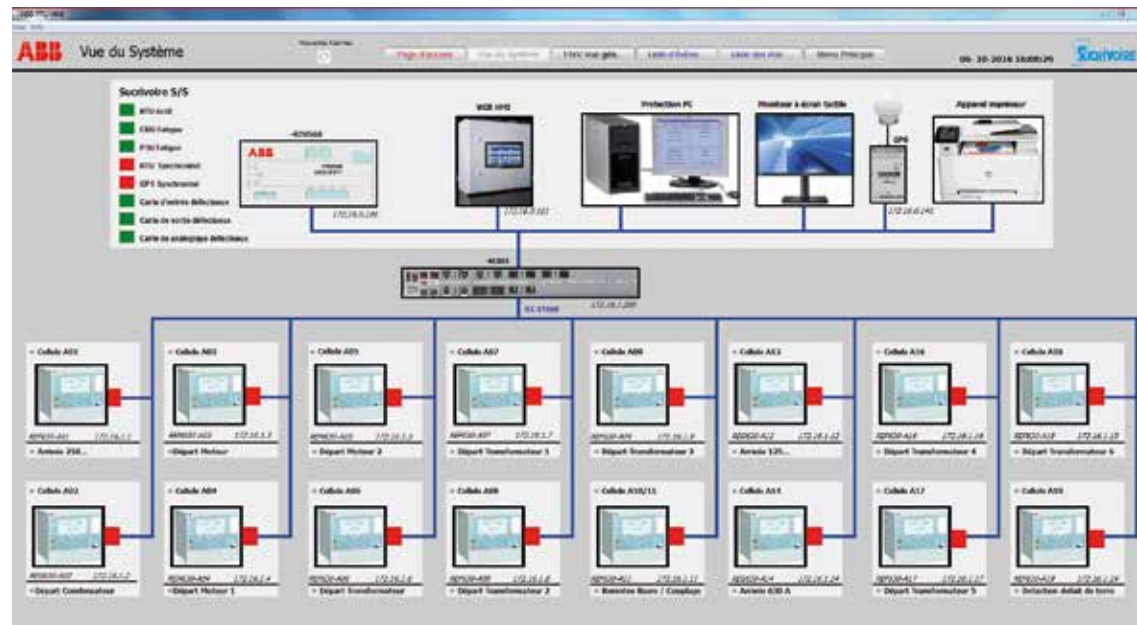

03

RTU540

A key element of the power distribution system is the RTU540 remote terminal unit (RTU). The RTU540 bridges old and new technology and combines existing devices and new standard protocols in one system. An RTU540 incorporates advanced features such as programmable logic control and a human-machine interface (HMI) that are connected to a set of displays. These displays deliver a visualization of the status of the sugar factory's breakers and disconnectors, with measurement values as well as alarm lists and trends. The high-quality, RTU540 compact metal housing can, if necessary, include input and output modules, thus saving space in the control cabinet. The intelligence in the RTU540 allows upfront fast selective data interpretation so that operators are presented with the critical information they need in an efficient manner and less important data is de-emphasised so there is no confusing clutter.

—
The displays deliver a visualization of the status of the sugar factory's breakers and disconnectors, with measurement values as well as alarm lists and trends.

The RTU540 is also simple to configure, so changing sugar factory topologies can be easily accommodated and overview of the critical power data retained.



UniGear ZS1

As a further enhancement to Sucrivoire’s sugar factory power infrastructure, the medium-voltage (MV) air-insulated switchgear has been replaced with ABB’s UniGear ZS1. ABB’s UniGear Digital is a new concept based on an optimized integration of current and voltage sensors into MV switchgear, combined with the latest intelligent electronic

—

UniGear Digital is based on an optimized integration of current and voltage sensors into MV switchgear, combined with the latest IEDs and IEC 61850 communication.

devices (IEDs) and IEC 61850 communication. The concept is embodied in the MV air-insulated switchgear, UniGear ZS1. With the UniGear Digital, “one size fits all” so there is no need to change primary MV components if the load changes. This approach saves time and money during project planning and execution. Energy losses during operation are lower too as the instrument transformer is eliminated. Further, operator safety is enhanced by having all MV parts fully encapsulated in arc-proof cubicles.

Relion®

The power distribution automation system in the Sucrivoire factory also features combined protection and control devices from ABB’s Relion family of IEDs →4. The Relion product family offers the widest range of products for the protection, control, measurement and supervision of power systems for IEC and ANSI applications. To ensure interoperable and future-proof solutions, Relion products have been designed to implement the core values of the IEC 61850 standard.



04a

—
04 Relion IEDs.

04a The RTU540CMD01 is a module of the RTU540 product line consisting of a communication unit and a galvanically isolated wide-range power supply in a metal DIN rail housing.

04b The 540CID01 has the same features as the 540CMD01 but has also a multi-I/O module.

ABB Ability™

The ABB products employed in the Sucrivoire factory benefit from ABB's overarching digitalization concept – ABB Ability. ABB Ability

—
The Relion family offers the widest range of products for the protection, control, measurement and supervision of power systems for IEC and ANSI applications.

is a unified, cross-industry digital capability - extending from device to edge to cloud - with devices, systems, solutions, services and a platform that enables more knowledge of the system, more capabilities and improved performance delivered by the connectivity of ABB Ability enabled equipment.

ABB's distribution automation systems

ABB's distribution automation system offering contains a much wider range of products than those delivered to Sucrivoire: From basic distribution automation systems, renewable integration and battery storage right up to advanced distribution automation systems, ABB delivers greenfield solutions as well as the ability to modernize existing installations in the most cost-efficient way, as is the case at Sucrivoire.

—
Sucrivoire's ABB power distribution automation system has vastly improved the factory power grid reliability and efficiency.

Sucrivoire's ABB power distribution automation system has vastly improved the factory power grid reliability and efficiency and has given the operators full vision into the power infrastructure as well as control over it, thus enabling the factory to boost productivity and safety. In this way, Sucrivoire can ensure that the ambitious production goals they have set themselves have every chance of becoming a reality. ●



04b



Trans- formation trends



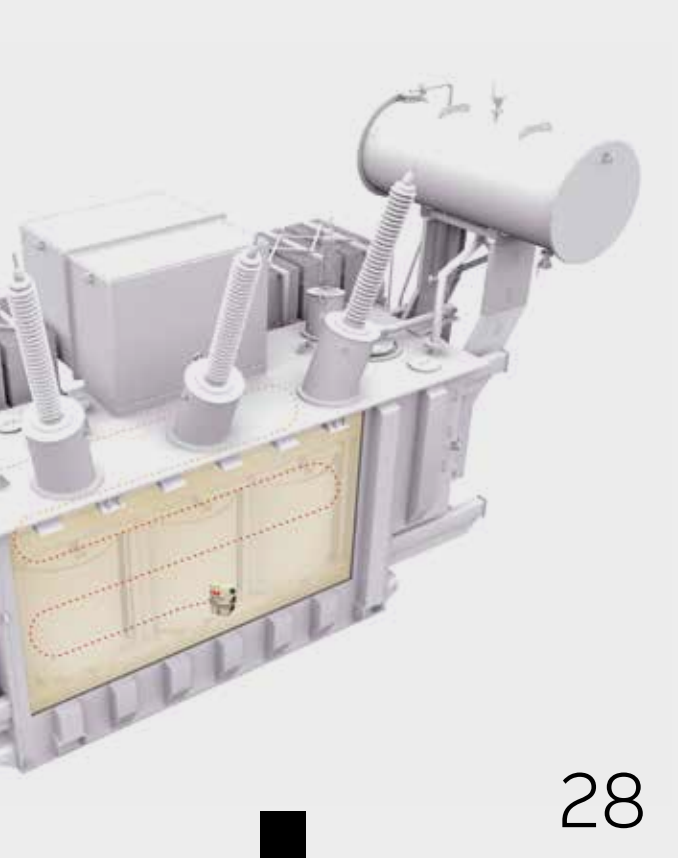

mal

28

Whether bringing visibility to the interiors of complex and dangerous oil-filled transformers via the digital “eyes” of a new robot, or moving electrical power from offshore wind farms to national grids with novel high-voltage direct current technology, ABB is innovating with utilities how to safely resource and distribute energy.

- 28 ABB’s TXplore robot redefines transformer inspection
- 36 HVDC technology for offshore wind is maturing



36

TRANSFORMATIONAL TRENDS

ABB's TXplore robot redefines transformer inspection

ABB's new validated robot inspection system, TXplore, is tailored to the complex oil-filled transformer environment. Rigorous testing provides overwhelming support of robotic over human internal inspection in terms of cost, safety and digital leverage.

Gregory Cole
Harshang Shah
ABB USCRC Mechatronics
and Sensors
Bloomfield, CT,
United States

gregory.a.cole@
us.abb.com
harshang.shah@
us.abb.com

Craig Stiegemeier
ABB Transformer
Remanufacturing and
Engineering Services
St. Louis, MO,
United States

craig.stiegemeier@
us.abb.com

Jamie Stapleton
ABB Transformers
Business Unit
Worthing, United
Kingdom

jamie.stapleton@
gb.abb.com

Despite the use of non-invasive condition monitoring techniques to determine possible faults and avoid adverse failures in oil-immersed transformers [1], there are routine and emergency situations that require costly internal inspections with major risk to both transformer structure and human inspectors. Nowadays, utilities perform internal visual inspections following lightning

—
Commonly, during inspections, transformer downtime is three days — seen overall, internal human inspection has high human and capital costs.

strikes and when there is the need to isolate the exact location or severity of a fault, multiple faults or complete a planned repair [2]. In cases such as these, the mineral oil must be removed and stored so that a highly skilled transformer inspector can enter the hazardous enclosed space of the transformer tank, risking damage to both the inspector and transformer. The inspection process also requires medical teams and other expert personnel to be present. Commonly, during inspections, transformer downtime is three days — seen overall, internal human inspection has high human and capital costs.

—
01 TXplore remotely driven robot uses propellers and buoyancy control to navigate freely; light sources and cameras secure quality images.



01

With over 200,000 projects completed, ABB is a global leader in the production, monitoring and maintenance of transformers. Much thought has been devoted to internal inspections of

—
In 2012, ABB proposed a remotely driven robotic system to operate reliably and effectively within the toxic and fragile environment of a transformer unit.

these devices with the aim of lowering capital costs, improving the effectiveness of inspection data, lowering the safety risk to humans and transformer assets and reducing downtime.

In late 2012, ABB proposed a concept to develop a remotely driven robotic system to operate reliably and effectively within the toxic and fragile environment of a transformer unit and eliminate the need for human inspection. To be a viable option for utilities, the remotely driven robotic system must inspect the transformer, navigate effectively and maintain the integrity of both the transformer and its oil. High quality visual images and data must be collected and transmitted to external systems for evaluation. A multi-disciplinary team of scientists and engineers from ABB was formed to design such a system. The result of their efforts is the submersible transformer inspection robot now known as TXplore →1.

Technical development and validation of TXplore

Power transformers are expensive yet critical machines that are designed and manufactured using complex engineering and construction

—
TXplore was designed to navigate and collect high quality inspection data safely and easily without becoming stuck or damaging the transformer.

methods to deal with stressors encountered during their lifetime - eg, overvoltage, short-circuit currents, high temperature of windings and contaminants. The circulation of insulating oil allows heat to be removed from the windings and is crucial to the health of the transformer. Any object, including a robot, which enters the transformer must preserve the integrity of the oil. For this reason, ABB designed the entirely new TXplore system →1-2.

TXplore system design

The newly designed inspection system for de-energized transformers only requires two personnel once the unit is prepared: a top-side equipment technician to setup and manage the robot and a robot pilot to navigate, gather data and communicate with experts and customers →3. The equipment operator is responsible for the installation tasks and placement of the robot into or out of the system →3.

TXplore is designed to navigate and collect high quality inspection data safely and easily. The photos and videos can be produced without becoming stuck or damaging the transformer or its components →4. The tetherless robot is shaped and sized to balance ease of navigation with robustness, which allows the submersible robot to inspect all areas of interest such as bushings, leads, tap changer, core top, core support and insulation and more. Additionally, redundant safety systems and extensive thermal and environmental safety testing verify the TXplore system is ready to inspect transformers under a variety of demanding conditions.

02



—
02 TXplore remotely driven robot can navigate freely and safely within a de-energized oil-filled transformer.

—
03 An in-situ internal inspection of a transformer showing the robot pilot, equipment manager and the robot.



Equipment manager



Device inspection



Robot pilot



03

With the preservation of mineral oil quality of primary importance, the robot construction is optimized to leave no detectable footprint — either chemical or physical — as it operates within the transformer. The robot's outer shell is made of a high performance plastic that minimizes the risk of electric coupling and structural damage to the transformer while allowing the craft to operate safely in demanding environments at high temperatures.

—
Only two employees, a robot pilot and a top-side equipment operator, are needed on-site during a TXplore inspection.

High quality inspection images can be made on-site and transmitted worldwide. Redundant radio systems ensure that navigation can continue even when communications are impaired. The unique system architecture allows future technologies to be added as advances are made and end user demand grows →5. In this way the TXplore system provides digital leverage.

Human versus robot

The safety of the people responsible for inspection and the integrity of the transformer are paramount and the system design ensures optimal navigation and communication ability. A comparison of the proposed workflow to conduct a robot inspection with that of a traditional human invasive inspection indicates this →6. TXplore navigates in the oil, thereby eliminating the need for processing equipment eg, tanker trucks, processing and vacuum filling rigs or personnel to remove and store the oil — a common practice during human inspections. And, because the robot enters the unit instead of a human, no medical or environmental safety team is required during inspection. Remarkably, only two employees, a robot pilot and a top-side equipment operator, are needed on-site during a TXplore inspection, once the transformer has been prepared →3. Overall, robotic inspection can be completed in less than one day with only two employees — a dramatic reduction in personnel, time and cost compared to a standard human inspection which, requires a large team and lasts three or more days.



Validation

Whole system and subsystem investigations were undertaken in the laboratory and at testing facilities before pilot studies were conducted in near-real-world installations. Tests were performed for leakage, navigation capability, temperature and chemical stability and possible oil contamination.

—
Robotic inspection can be completed in less than one day with only two employees.

Prototypes were tested for leakage at various temperatures for more than 96 hours under pressure conditions that reached up to more than twice the expected field pressures. Spatial and depth navigation abilities were assessed in seven different oil-filled tanks to determine robot stability and to ensure that visual system could be stabilized to support high quality images.

The impact of the robot prototype on the mineral oil was evaluated in an elegant way: Two tanks of oil were prepared, one with a volume of highly contaminated oil (taken from a field transformer) and one with 100 gallons of clean oil. A baseline set of measurements were made for volumes of oil.

The robot was then placed in the tank of highly contaminated oil for 6 hours. The robot was removed and re- processed using ABB's validated cleaning and site preparation techniques. Afterward, the remotely driven robot was placed in the clean oil tank for an extended period. At this point samples were retrieved from this oil tank and analyzed to ascertain whether or not the robot contaminated the second oil tank. The results were then compared to the baseline results. The contamination level of the oil (from clean and new to practically black and highly contaminated with particles present) →7, temperature (from -5°C to 27°C) and the impact of the robot on the oil were examined. The findings show that the oil maintains its integrity throughout the inspection process if procedures are followed.

04

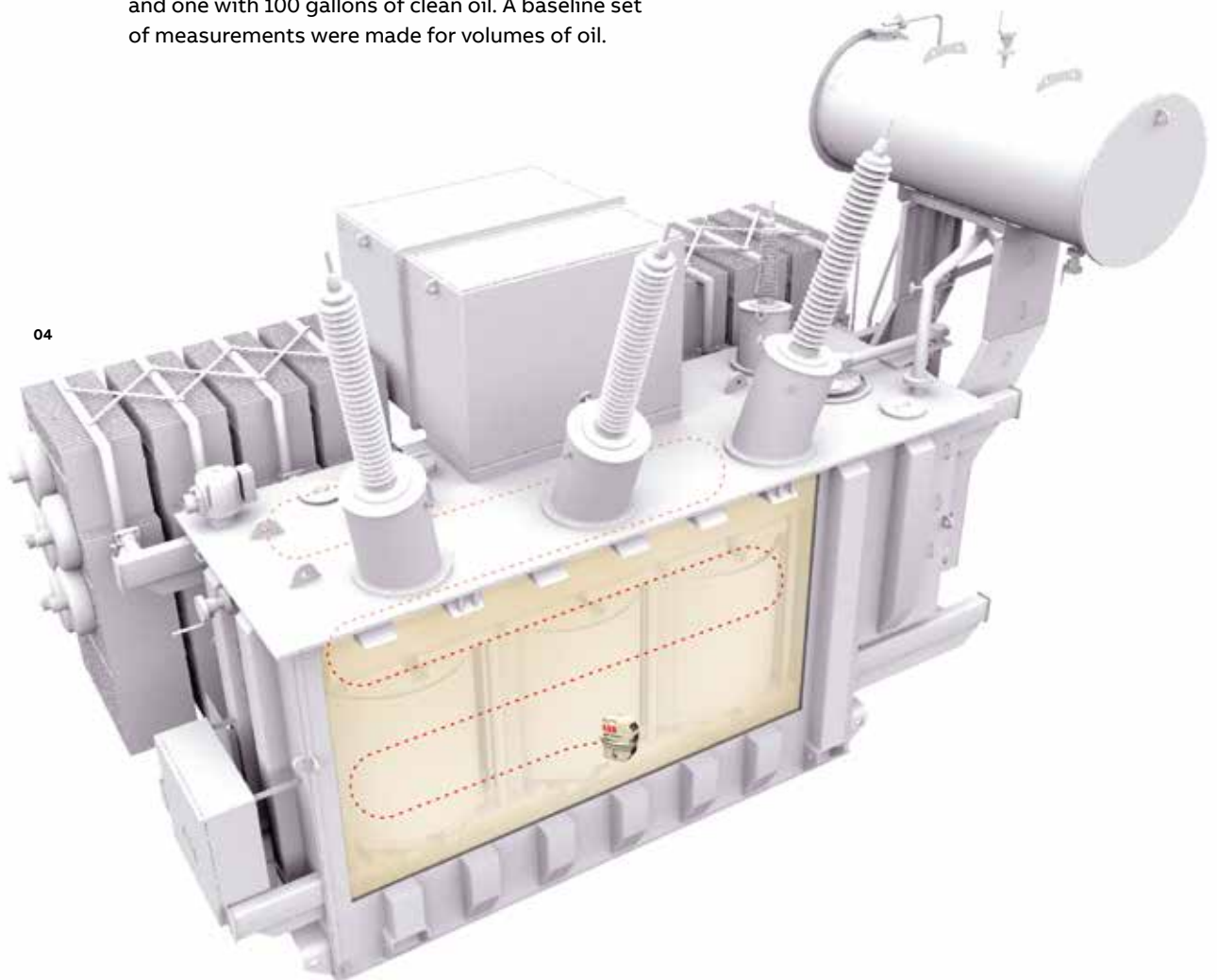

04 A schematic showing TXplore navigating within the oil-filled transformer.

05 The system architecture shows electric, mechanical control systems and data collection systems.

06 Current human workflow versus proposed robot workflow for a transformer inspection.

07 An example of oil contamination test results showing no particulate contamination following introduction of the robot in the oil-immersed transformer.

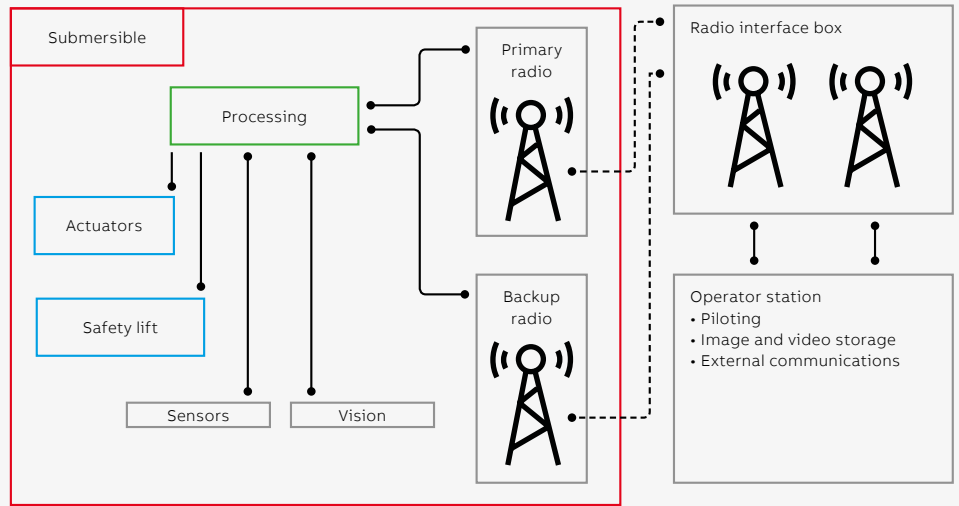

05

It is known that remotely operated vehicle (ROV) propulsion systems often generate bubbles through cavitation. Design elements were carefully included to prevent this. For example, the propulsion system of the robot can be a source of cavitation. A stroboscopic investigation of the propeller was performed at all possible rotational frequencies to evaluate this process. There were no gas bubbles detected, even in areas likely to act as cavitation nucleation sites such as the leading edge of the propeller or the gap between the propeller and shroud.

Pilot system inspections were conducted under various conditions and temperatures; the result was a dramatic reduction in inspection time to less than two-hours. Clear and accurate images were taken →8, recorded and provided to the customer in the form of a detailed report that documents the inspection. All relevant information could be shared with experts worldwide in near-real-time. This capability ensures customer will have the right diagnosticians to deal with any transformer issues encountered. TXplore inspection allows a return to service with confidence that the future plan of operation or repair of the transformer asset can be maintained.

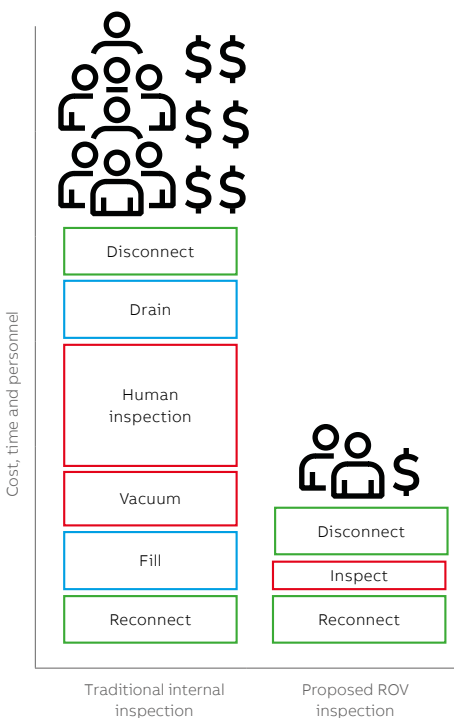

06

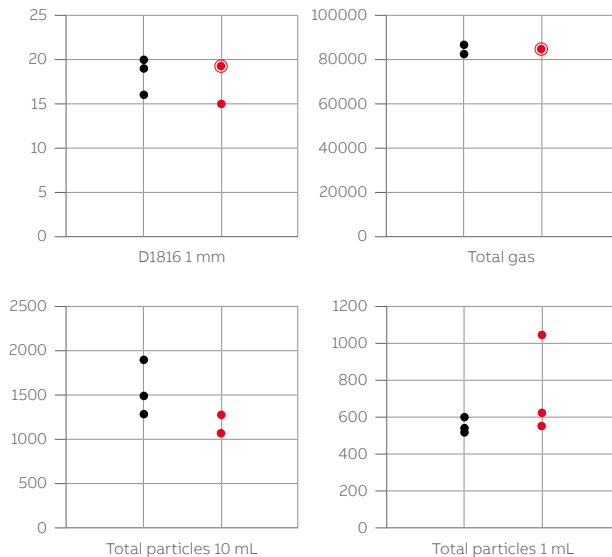

07



08a



08b

Case study

Robotic inspection test results have been reaffirmed by transformer inspections conducted in 2016 at the St. Louis power transformer factory on production transformers and on a critical substation that provides power to the high-voltage test facility →9.

In 2017, ABB successfully performed an internal inspection of a transformer at an AEP station without the need for any oil handling.

Additionally, American Electric Power (AEP), a large utility in the United States, viewed a demonstration of a remotely driven robot inspection of a tank at ABB Customer World in March, 2017. AEP approached ABB about the possibility of performing an inspection of one of their large power transformers that would be taken out of service. During the summer of 2017, ABB’s development team brought the robot and

control and recording equipment to the AEP station and successfully performed an internal inspection of a transformer that was more than 50 years old without the need for any oil handling. TXplore successfully inspected the transformer and ABB could verify the benefits of effective mobility of the robot, visualization ability and collaboration potential, both remote and local, as well as the efficient overall operation.

Product Launch

Prototype data and performance information were reviewed following these pilot inspections. As a result, design modifications were made to improve reliability, longevity and to enhance the ability of TXplore to perform inspections in hot oil. The first production robots were initially tested and completed trial inspections in February 2018. The robot was introduced to the market at the Hanover Trade Fair and initial orders for pilot trials of the final design were received March 1. Production service inspections are scheduled to begin in May 2018. From this time forward robot production will allow global ABB to perform inspections on any oil-filled transformer large enough to accommodate the patented robot. Production will continue to enable a fleet of robots to support ABB service operations.

08 Images taken by TXplore during an inspection of a 20 year old transformer that had tripped off line.

08a The customer thought the source of failure could be the tap changer but TXplore image shows this is not the case.

08b TXplore image shows clearly that a disk to disk failure was the source of the problem.

09 The TXplore transformer inspection process is shown.

09a A demonstration of a remotely driven robotic inspection within an oil-filled tank.

09b The inspection utilizes a top-side equipment technician to set-up and manage the inspection and a robot pilot to navigate.

09c TXplore is safely placed into the oil-filled transformer by a top-side equipment technician.

09d TXplore navigates freely and safely within the oil-immersed transformer without risk to employees.

References

[1] L. Carlzon, A. Fazlagic, P. Lorin, Service Handbook for Transformers, P. Boss, D.G. Frimpong, and M. Turner, eds. ABB, 2007.
[2] H.C Sun, Y.C. Huang, C.M. Huang, "A review of dissolved gas analysis in power transformers" Energy Procedia, volume 14, pp. 1220-1225, 2012.

The future is safe and digital

Robotic inspection eliminates the need to bring in heavy equipment and reduces the size of the supervisory team, dramatically shortens downtime, usually to under a day, and is cost-effective.

Most significantly, TXplore can navigate the oil and visually map the entire interior of the transformer unit.

Moreover, the ability of the system to provide a comprehensive inspection data set make robotic inspection beneficial. Nevertheless, the most significant advantage of using a remotely driven robot to navigate the oil is the ability to visually

map the entire interior of the transformer unit and remotely view the inspection results safely without requiring humans to enter the enclosed space of the transformer. ABB takes this advantage one step further and will integrate the robot and system into the ABB Ability™ Platform. The forthcoming digital solutions and services will be built around the inspection data.

By revolutionizing oil-immersed transformer inspection, not only has ABB anticipated the customers' desire to improve safety and lower costs, they have transformed inspection data gathering and management to provide digital leverage to customers and that all important competitive edge. ●

09a



09b



09c



09d

TRANSFORMATIONAL TRENDS

HVDC technology for offshore wind is maturing

Offshore wind is the fastest-growing renewable-power segment. The connection of wind farms that are far from the shore of national grids requires high-voltage direct current (HVDC) technology, with which ABB has long experience. What challenges have been overcome in the last decade in this maturing area?



Athanasios Krontiris
HVDC Connections,
ABB Power Grids
Mannheim, Germany

athanasios.krontiris@
de.abb.com

With an average annual growth rate of 13 percent over the last five years and total installed capacity reaching 540 GW in 2017, wind power has seen rapid development →1-2. Offshore wind power, although still contributing only 3.5 percent of total installed wind power, is expanding at an even higher rate: 28 percent →3. Offshore wind power is concentrated in the North Sea but is spreading to North America, East Asia, India and elsewhere.



Peter Sandeberg
HVDC Connections,
ABB Power Grids
Ludvika, Sweden

peter.sandeberg@
se.abb.com

As well as growing in terms of rated power, offshore wind power plants are also being located farther from coasts and grid entry points.

As well as growing in terms of rated power, offshore wind power plants are also being located farther from coasts and grid entry points. These factors present significant technical challenges.



—
01 Offshore wind power generation grew by nearly 30 percent in 2017.

AC versus DC for offshore connection

When choosing between AC or DC for connecting offshore wind farms to the grid, the main parameters to be considered are rated power, distance to shore and the distance on shore to the nearest strong grid connection point, which can be up to 100 km away as landfall is often located in lightly populated areas where the transmission grid is weak.

A major advantage of AC is the low station cost. However, in AC transmission, losses rise with the voltage, the capacitance and the cable length. Beyond the so-called critical length (100 to 150 km depending on cable type) there will be no capacity left for active power transmission. The classical way to increase the transmission capacity is to increase the voltage level, but because reactive power increases with the square of the voltage, the voltage increase reduces the critical length.

A DC connection has the advantage of lower cable costs. And because the cables are only charged when energized, and the complete current-carrying capability can be used for power transmission, cable losses above a certain distance are lower than with the AC equivalent. These factors compensate for higher DC converter costs.

Further, HVDC cables with XLPE insulation are lighter than other cables, making their installation offshore easier and cheaper. Their lower weight per unit length allows the transport of longer sections, which translates into fewer cable joints, reduced installation time and lower risk of failure.

The DC alternative, therefore, becomes competitive - both from an investment and operational cost perspective - with increasing power rating and transmission distance.

HVDC offshore today

Currently, 40 of the over 90 offshore wind farms in Europe have a nameplate capacity (intended full-load sustained output) higher than 200 MW and roughly one-third of these are connected to the grid by HVDC transmission, individually or in groups. So far, there are seven HVDC offshore wind connection systems in operation and another three under construction. They are all located in the area of the North Sea known as the German Bight and are operated by the transmission system operator TenneT Offshore. With further projects proposed around the globe, the short- to mid-term outlook for offshore wind HVDC connection is bright.



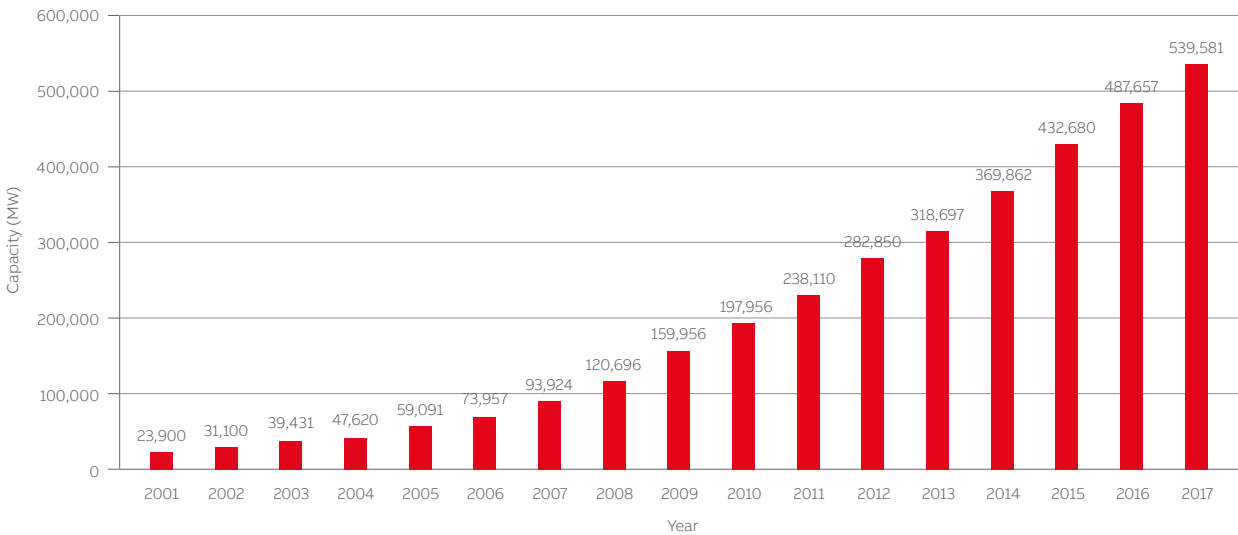

02

Possible configurations for HVDC connection

The most straightforward HVDC offshore wind farm configuration is a point-to-point connection of an offshore converter, installed on a platform, and an onshore converter →4a. So far, all offshore wind HVDC connections in operation are of this type.

—

An offshore “hub” located on a platform is connected via “spokes” to several onshore grids in the same or different synchronous areas.

A concept of increasing interest is the hybrid system, ie, a combination of subsea interconnectors between offshore grids and connection of these to shore →4b-4d. Such concepts have been recently proposed for the North Sea and are referred to as “hub-and-spoke” arrangements: An offshore “hub” located on a platform, or even on an artificial island, is connected via “spokes” to several onshore grids in the same or different synchronous areas. This concept can be utilized both for AC connections and DC connection to shore, although the distances to shore in the North Sea are prohibitive for the AC option. For the DC option, the hub may either be interconnected with multiple, parallel point-to-point HVDC links or with a multiterminal HVDC system.

Advantage of hub-and-spoke

Interconnection with other grids greatly increases link utilization as the link utilization of a single-purpose offshore wind connection depends solely on the intermittent character of the local wind.

Further, if an internationally coordinated approach to the installation of the transmission infrastructure can be adopted, costs can be reduced. Additional benefits may accrue from the facilitation of energy exchange between international markets.

Finally, the hub-and-spoke concept enables stepwise expansion, with transmission capacity added in stages, thus allowing higher energy availability sooner. The stepwise approach also means changes can be carried out and new technology incorporated as the wind farm develops, and investment can be made incrementally.

The first project of this kind is currently under construction in the Baltic Sea. In the Kriegers Flak Combined Grid Solution project, an AC interconnector has been established between Denmark and Germany via the offshore wind farms Kriegers Flak A and B, and Baltic 1 and 2. To provide frequency decoupling between the Nordic and continental Europe synchronous areas, ABB is supplying a back-to-back HVDC converter at the landing point in Germany (Bentwisch) and a master controller that best utilizes the hybrid interconnector assets. Operational experience from this project is expected to play an important role in the further deployment of the hub-and-spoke concept.

— 02 Global cumulative installed wind capacity 2001 to 2017.

— 03 Installed offshore wind capacity worldwide.

03a Cumulative offshore wind capacity by country 2016 versus 2017.

03b Annual cumulative capacity 2011 to 2017.

ABB HVDC offshore wind connections

ABB has successfully delivered three HVDC links for offshore wind connection →5-7. These projects would not have been possible without significant development steps in platform design by ABB’s partners and in HVDC technology by ABB.

The compact design of the HVDC Light equipment allows for cost-effective implementation on an offshore platform.

Voltage source converter technology, first launched by ABB as HVDC Light®, has been the key enabler for offshore HVDC links. By controlling voltage and frequency in the islanded offshore AC grid, the offshore converter station automatically transmits as much active power

as wind farms produce to the onshore AC grid while maintaining a stable AC voltage and frequency in the offshore AC grid. At the same time, the compact design of the HVDC Light equipment allows for cost-effective implementation on an offshore platform.

Pioneering HVDC work for offshore wind connection

Compared to other HVDC scenarios, offshore implementation presents some unique design requirements. Some of the main challenges arise from environmental conditions offshore, the lack of widely used standards for offshore HVDC systems and components, accessibility and marine operation limitations, and challenging interface management. At the same time, the system behavior of an islanded offshore AC grid differs significantly from typical transmission grids.

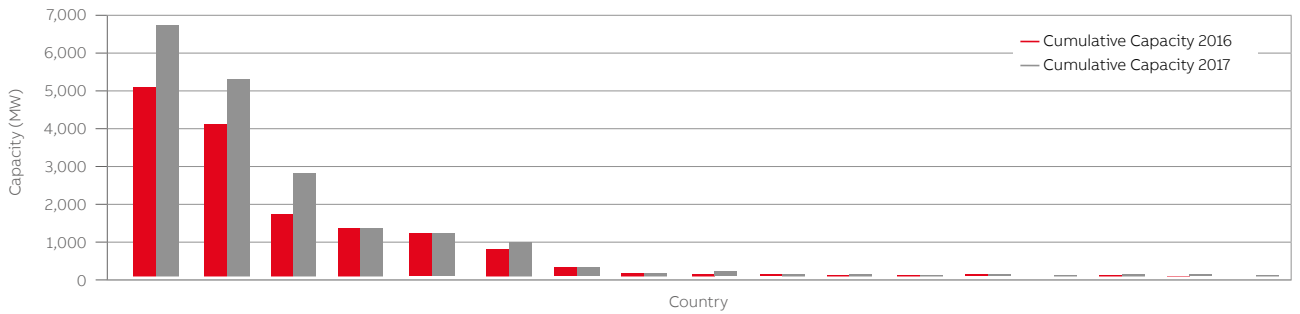

	UK	Germany	PR China	Denmark	Netherlands	Belgium	Sweden	Vietnam	Finland	Japan	S Korea	US	Ireland	Taiwan	Spain	Norway	France	Total
Total 2016	5,156	4,108	1,627	1,271	1,118	712	202	99	32	60	35	30	25	0	5	2	0	14,483
New 2017	1,680	1,247	1,161	0	0	165	0	0	60	5	3	0	0	8	0	0	2	4,331
Total 2017	6,836	5,355	2,788	1,271	1,118	877	202	99	92	65	38	30	25	8	5	2	2	18,814

03a

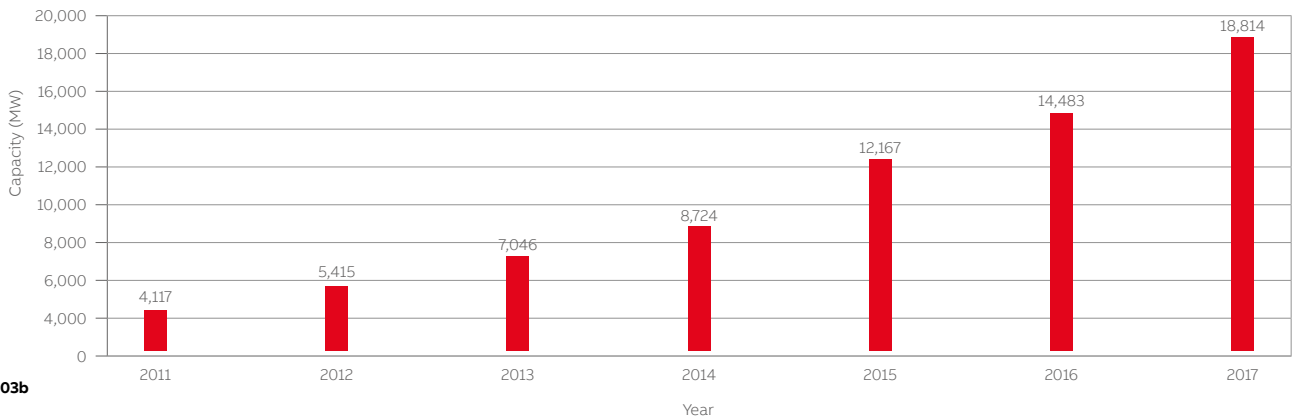

03b

Environmental conditions offshore

Offshore HVDC transmission systems will typically face harsh environmental conditions such as mechanical loading from vibration, temperature extremes, excessive humidity and salt pollution. Also, weather and sea conditions, and marine handling impact equipment storage and transportation. However, experience shows that, with careful design, these challenges can be overcome.

ABB has developed and successfully implemented innovative concepts for the control of islanded offshore grids during normal conditions and disturbances.

Platform design and design codes

The first two platforms built for offshore wind HVDC converter stations were based on a conventional topside jacket solution. For the DolWin2 project, ABB developed, in close cooperation with a Norwegian yard, a flexible, highly innovative, robust and scalable platform for greater production efficiency and ease of installation (no heavy-lift vessels or jack-up operations are required) →7-8.

This platform is based on a combination of semisubmersible and gravity-based designs – ie, it acts as a semisubmersible platform during transport and installation, after which it is ballasted to sit solidly on the seabed.

The offshore industry has strict requirements and designs must be approved by a certifying authority. A strong partnership with a knowledgeable platform designer is crucial in this respect to ensure short project lead times and reduce risk.

Modes of operation

ABB has developed and successfully implemented innovative concepts for the control of islanded offshore grids during normal conditions and disturbances. One such innovation is the installation of a large, electronically controlled brake resistor (chopper) to enhance the stability of the offshore grid in case of disturbances in the onshore grid.

Lessons learned from early offshore wind connections motivated TenneT to adjust the offshore grid connection codes. The flexible, modular control software design used by ABB for HVDC and ABB’s FACTS (Flexible Alternating Current Transmission Systems) allowed for the easy implementation of the new grid codes in already operational links.

04a

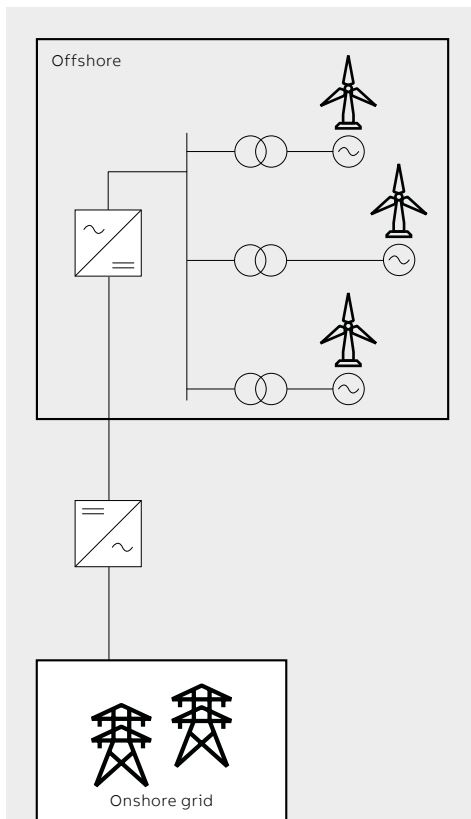

04b

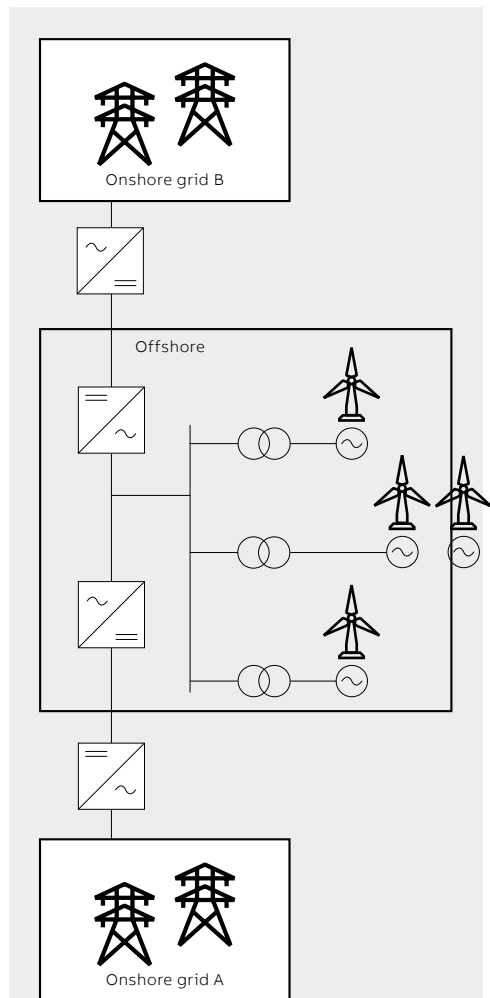

04 HVDC connection schemes for offshore wind.

04a Point-to-point connection.

04b Hub-and-spoke with multiple HVDC links.

04c Hub-and-spoke with multi-terminal HVDC system.

04d Hub-and-spoke with AC links and HVDC back-to-back station as is implemented in, for example, the Kriegers Flak Combined Grid Solution project.

Special features of offshore AC grids

Unlike typical transmission grids with transmission lines, loads and large generating units based on synchronous machines, an offshore AC grid comprises nonsynchronous generating units, submarine cables as well as many transformers in the step-up AC substations

The flexible, modular control software design used for HVDC and FACTS allowed for the easy implementation of the new grid codes in already operational links.

and the wind turbine generators (WTGs) that are close to each other. Due to the lack of synchronous machines, an offshore AC system has low, or even no, inertia. A large frequency and phase-angle excursion can take place in such a system in the case of load rejection caused by an onshore or offshore AC fault.

This makes it challenging for the phase-locked loop (PLL) of the WTG controllers to track the grid voltage accurately. For faults in the onshore grid, the DC chopper mentioned above acts as a firewall, absorbing the excess energy from the wind farms that cannot be transmitted to the onshore grid and, thus, preventing the disturbance in the onshore grid from entering the offshore grid. Together with the frequency and voltage control in the offshore HVDC converter, the chopper guarantees the stability of the offshore grid. For faults in the offshore grid, proper control design for the HVDC and WTGs is required. Further, resonances created by the capacitance of cables and the inductance of cables and transformers are poorly damped, especially during the early stage of AC system energization when there is little, or no, wind generation.

04c

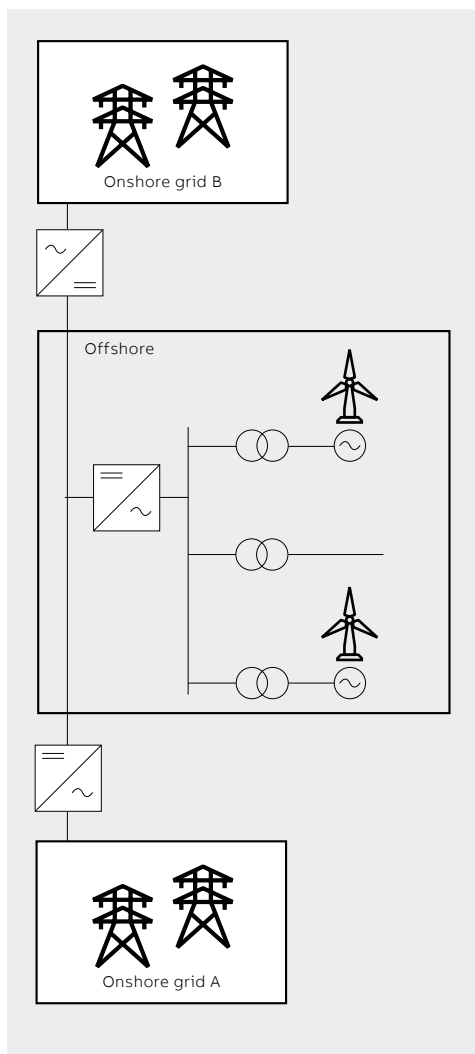

04d

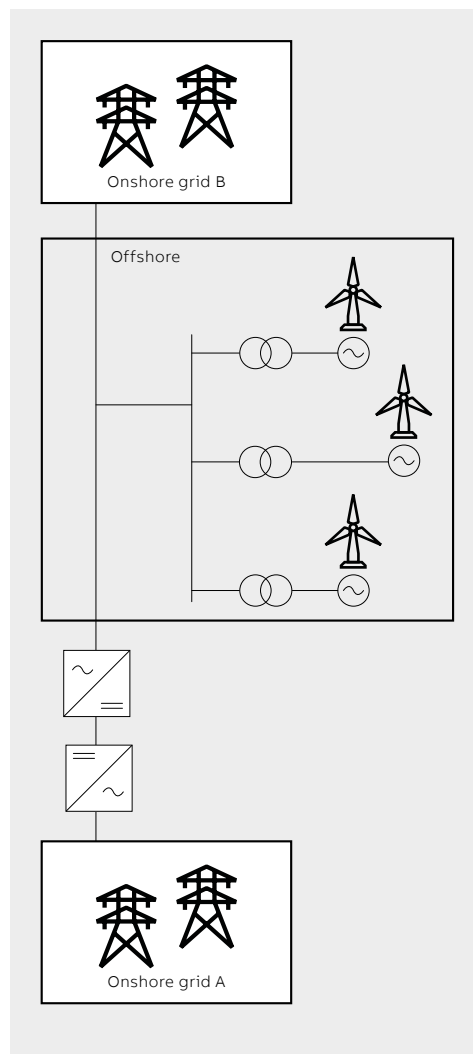

	BorWin1	DolWin1	DolWin2
Customer (location)	TenneT (Germany)	TenneT (Germany)	TenneT (Germany)
Operating since	2009	2013	2014
Power rating (MW)	400	800	916
AC voltage (offshore) (kV)	155	155	155
DC voltage (kV)	±150	±320	±320
AC voltage (onshore) (kV)	380	380	380
Land cable length (km)	2 x 75	2 x 90	2 x 90
Sea cable length (km)	2 x 125	2 x 75	2 x 45
Platform supplier	Heerema Fabrication Group	Heerema Fabrication Group	Aibel AS
Platform design	Jacket topside	Jacket topside	Gravity-based
Connected offshore wind farms	Bard Offshore 1	Borkum West II MEG Offshore 1 Borkum Riffgrund 1	Merkur Offshore Trianel Borkum Borkum Riffgrund 1

05

Also, due to the close electric proximity of transformers, sympathetic interaction during transformer energization at the start-up of an offshore wind farm can be expected, causing temporary harmonic overvoltages, increased stress on transformer windings and potential malfunction of transformer differential and overcurrent protection. Start-up of an offshore AC grid is by no means a trivial task. Possible measures to avoid exciting resonances or sympathetic interaction of transformers include

— The DC chopper absorbs excess energy to prevent onshore grid disturbances from entering the offshore grid.

controlled switching (point-on-wave switching), enhanced harmonic filtering with the offshore HVDC converter or installation of harmonic filters. Together with TenneT, ABB has developed solutions to tackle such instabilities.

06



— 05 HVDC systems for offshore wind connection delivered by ABB.

— 06 The DolWin2 platform en route to its installation site.

— 07 DolWin2 Beta HVDC platform.

The value of standardization

Over the last decade, the industry has collected valuable experience in the design and operation of offshore HVDC wind connections. Lessons learned and best practices are collected in

—

A robust design that is proven in practice and openness toward technical innovations are important factors in further reducing the cost of offshore wind generation.

industry recommendations and grid codes. Standardization of system design is a powerful way to exploit best practices and enhance harmonization between vendors.

Nevertheless, standardization should not hinder technical innovations, such as the currently discussed concept of direct connection of wind turbines to the HVDC offshore converter without intermediate step-up AC substations on separate platforms.

Maintaining the right balance between keeping a robust design proven in practice and opening up for technical innovations with potential advantages is important in order to further reduce the cost of offshore wind generation.

Market tailwinds

The offshore wind industry has expanded rapidly over the last decade and will continue to grow, supported by economy of scale throughout a supply chain devoted to the supply of generating units with ever-higher rated powers and wind farms with ever-higher nominal powers. This development will create further demand for HVDC connections. Technology maturity, together with increasing positive experience from already-operating systems, helps to lower risk and secure timely and efficient implementation of grid connections. At the same time, ABB, with its long-term commitment to offshore wind connections, will continue to introduce innovations in HVDC technology in order to enable stronger, greener and smarter offshore grids. ●

07





Digital an analytics



d



Whereas analog risk is expressed as a probability, digital tools allow it to be quantified and therefore managed. ABB works with customers to maintain power stability in manufacturing processes, model ABB solar inverters for power system analyses, and apply the latest concepts of cybersecurity across its business units. The result is fewer surprises, if any.

- 46 Power stability for manufacturers
- 52 Modeling of ABB solar inverters in power system simulations
- 58 Focusing on cyber security

DIGITAL AND ANALYTICS

Power stability for manufacturers

Manufacturing is a critical aspect of many economies. However, many places lack power grid stability, which leads to production disruption. ABB's PCS100 family of power protection products ensures a continuous supply of good-quality power to industrial processes, even in the face of drastic voltage sags.



Bruce Bennett
ABB Power Conditioning
Napier, New Zealand

bruce.bennett@nz.abb.com

For years, companies have pursued various techniques to improve productivity and lower manufacturing costs. Success in this endeavor makes further gains harder to achieve – the law of diminishing returns. As a result, many companies are automating ever more processes in an effort to meet targets and remain competitive. This movement toward mass automation is driving a commoditization of manufacturing machinery – and, in some cases, of entire manufacturing plants.

Although possibly more efficient, new machinery can place further strain on an already-loaded generation, transmission and distribution network.

More automation demands more power

Principles proven over decades of lean manufacturing, such as waste reduction by equipment breakdown minimization or the deletion of non-value-adding activities, remain unchanged. But the digitization of manufacturing made possible by increased computing power delivers more advanced analytics, data

collection from more sensors, better automation technologies (such as touch-interactive robotics), and more machine performance information that the manufacturing company can use to refine existing processes.

All of this improved technology and process analytics requires electrical energy. Where the power supply is unreliable or prone to being out of specification, there is a very real risk of improper operation of equipment that may produce questionable, inaccurate, or possibly false, data.





01

—
01 A reliable power supply is critical for modern production techniques, especially in developing countries where manufacturing can lift an economy out of agricultural subsistence.

Further, even very short variations in the power supply can cause fatal machinery damage or shut down a manufacturing process or entire facility →1. Apart from production losses, non-delivery of product to the customer and possible equipment damage, unscheduled interruptions can be very costly in other ways. For example, in hygienic production environments such as dairy or food processing, hours may be spent clearing, cleaning, decontaminating and restarting.

As production demands increase, more and bigger machinery may be added. Although possibly more efficient, this new machinery can place further strain on an already-loaded generation, transmission and distribution network. The result of this additional load is a further reduction in stability and a consequent increased risk of interruption due to events on the network.

The cost to manufacturers of unscheduled process interruptions due to power events has been estimated to be as high as 4 percent of the company turnover [1]. Such an impact can quickly negate any gains in throughput, unit production cost or quality that have been made through investment.

The ABB PCS100 product line

All electricity networks will suffer power quality issues to some degree. These disturbances come in many forms – blackouts, noise, frequency variation or harmonics – but 90 percent of instabilities affecting manufacturing facilities are voltage sags, where the supply voltage drops markedly for a brief period. Most voltage sags are caused by external factors, such as high winds, heavy rain, snow and ice buildup, traffic accidents and excavation miscalculations. These events are beyond the control of the plant engineer and so protection against them must be planned for.

From continuous voltage regulation, through sag protection, to supplying the load during outages, the PCS100 product line provides clean, balanced and phase-corrected voltage that remains within specification.

ABB offers manufacturers a portfolio of power conditioning solutions that provide power event protection to machinery, production lines, or an entire facility. These solutions deliver an energy supply that is consistently within specification and that lowers the risk of process interruption or fatal machinery damage. From continuous voltage regulation, through sag protection, to supplying the load during an outage event, the PCS100 product line provides a customer's load with clean, balanced and phase-corrected voltage that remains within specification.

PCS100 AVC-20

The PCS100 AVC-20 is an inline continuous voltage regulator. It regulates the incoming supply voltage to 100 percent of nominal even when the grid-supplied voltage varies as much as ± 20 percent continuously.

ABB's PCS100 AVC-20 regulates the incoming supply voltage to 100 percent of nominal even when the grid-supplied voltage varies as much as ± 20 percent continuously.

For example, in a network in which the infrastructure capacity lags demand and large customer loads are connected, there are often periods of a minute to several hours duration in which the voltage drops well below the nominal supply voltage.



—
02 PCS100 AVC-40. The PCS100 family is suitable not only for developing countries with weaker infrastructure, but also for developed countries, where even marginal gains in productivity can bring a significant competitive advantage.

These undervoltages often occur during peak demand times when industrial plants are drawing the highest load. In a three-phase 400V nominal network in which such events occur, the AVC-20 will boost the voltage from as low as 320V back up to the nominal 400V for as long as the grid-side low voltage exists so that any load connected downstream of the PCS100 AVC-20 is not affected by the undervoltage. In the same manner, the PCS100 AVC-20 will buck an overvoltage of as much as 20 percent when, for example, a large network load ceases operation and the voltage climbs rapidly.

Not only does the PCS100 AVC-20 regulate voltage continuously, but it is also capable of regulating extremely rapidly: from instability detection to full regulation typically takes under 20ms – less than one cycle on a 50 Hz network.

PCS100 AVC-40

In a plant where severe sags are present, the PCS100 AVC-40 will correct a sag of 40 percent in the nominal voltage →2. For example, a three-phase 400V network voltage could drop to 240V and the PCS100 AVC-40 will restore it to 400V – in less than 18 ms. To provide such a high level of voltage correction, the PCS100 AVC-40 limits the correction duration to 30 s (due to thermal constraints). The continuous regulation ability of the PCS100 AVC-40 is ±10 percent.

—
The PCS100 AVC-40 will correct a sag of 40 percent in the nominal voltage.

Single- and two-phase sags can also be corrected by the AVC-40 and any resulting phase-angle shifts corrected as necessary.

There is no need for batteries or other energy storage as the PCS100 AVC-40 draws energy from the connected utility (and thus relies on it remaining connected).

PCS100 UPS-I

Manufacturing plants connected to supply networks that often suffer outages or blackouts, and that have a backup power source such as a second transmission-level connection or a generator, can be protected from interruption by ABB's PCS100 UPS-I →3.





03

Designed to bridge the period from the moment the utility supply drops below a preset voltage, or disconnects completely, until the backup comes on line, the PCS100 UPS-I will supply an industrial load from an energy storage source connected to the UPS-I controller. This controller manages the transfer to the secondary source and back to the utility once power is restored and within specification. Depending on the backup type, the UPS-I energy storage may be batteries or ultracapacitors. When transferring to a standby generator, batteries provide a minimum of 30 s full load autonomy – sufficient time to start and bring most generators online.

—

The PCS100 UPS-I bridges the period from the moment the utility supply drops below a preset voltage, or disconnects completely, until the backup comes on line.

In the case of a plant supplied by two transmission-level systems, for example, two 110kV feeders from two generation sites, ultracapacitors are used to supply the load for up to 2 s during the automatic transfer switch operation.

In all cases, the load is continuously supplied from the moment the supply goes out of specification until the backup is successfully up and running. The UPS-I manages this transfer and synchronizes the UPS-I output and network supply accordingly.

—

Delivering protection at plant supply level, the PCS120 MV UPS is connected at a distribution voltage of either 11 or 22 kV.

**Protection at medium-voltage:
the PCS120 MV UPS**

ABB'S PCS100 portfolio of products provides protection from common power events at tool, line or plant level with models rated from 150kVA to 3,600kVA. As plant load and complexity increase, broader protection strategies are required and reliable power conditioning systems are needed at a higher level. Therefore, ABB has introduced a medium-voltage power protection product - the PCS120 MV UPS →4. Delivering protection at plant supply level the PCS120 MV UPS is connected at a distribution voltage of either 11 or 22kV. One unit is rated at 2.25 MVA and units can be connected in parallel to protect loads up to the limit of available fault protection and switching devices.

— 03 PCS100 UPS-I.

— 04 PCS120 MV UPS.

Reference

[1] Copper Development Association, "The Cost of Poor Power Quality," ECI Publication No Cu0145, October 2015. Available: <http://admin.copperalliance.eu/docs/librariesprovider5/power-quality-and-utilisation-guide/21-the-cost-of-poor-power-quality.pdf?sfvrsn=4&sfvrsn=4>

Energy storage strategies similar to the PCS100 UPS-I are employed and secondary supply sources are managed by the MV UPS. This product is currently being promoted in the data center industry as the PCS120 MV UPS is suited to large industrial loads where entire plant level protection is desirable.

In their efforts to remain competitive, modern manufacturing plants are employing more automation, technology and electronically-driven processes and equipment.

ABB power conditioning products give plant engineers and managers a way to avoid costly unscheduled interruptions while protecting expensive technologies from damage caused by repeated power supply events beyond their control. They also enable complex and exacting manufacturing processes to run trouble-free, continuously and accurately, thus maintaining the company's competitive edge. ●

04

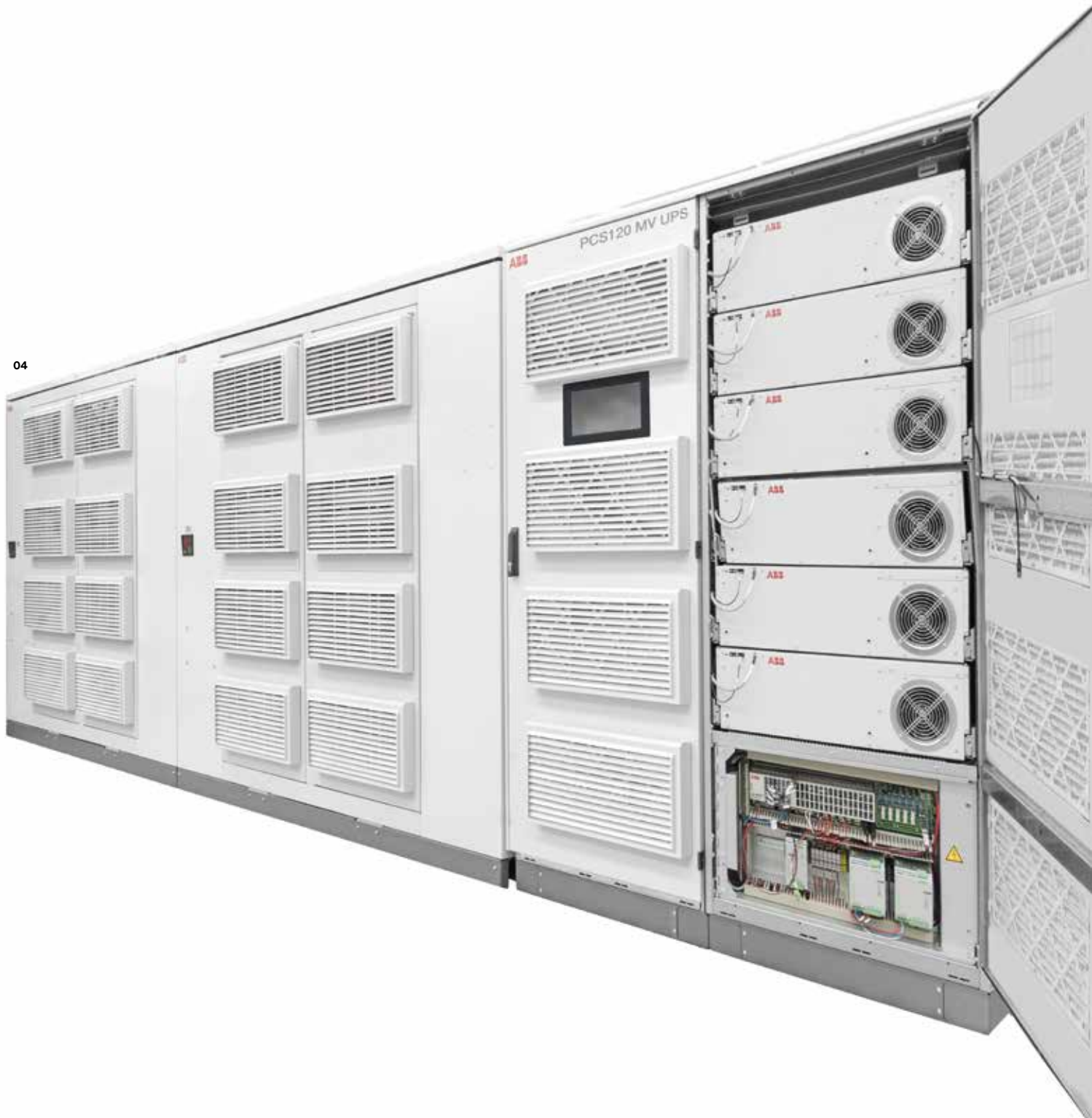

DIGITAL AND ANALYTICS

Modeling of ABB solar inverters in power system simulations

ABB offers solar inverters for a wide range of rated powers and voltages. This extensive portfolio necessitates a tool for fast, accurate and customer-oriented device modeling. ABB's Universal Framework simulation tool can be used in various simulation software packages applicable to power system analyses.

Piotr Mars
Miłosz Miśkiewicz
Paweł Błaszczuk
Tomasz Kuczek
ABB Corporate Research
Cracow, Poland

piotr.mars@
pl.abb.com
milosz.miskiewicz@
pl.abb.com
pawel.blaszczuk@
pl.abb.com
tomasz.kuczek@
pl.abb.com

The very significant contribution that photovoltaic (PV) technology makes to renewable energy generation is set to continue in the years to come. Hence, delivery of a wide range of solar products is seen to be a crucial element of ABB's future growth.

ABB offers solar inverters for applications with a wide range of generated power at different voltage levels.

Amongst other PV-related products, ABB offers solar inverters for applications with a wide range of generated power at different voltage levels:



—
01 ABB PVS980
inverter.

- Single- or three-phase string inverters rated between 2kW and 60kW. These find use in residential applications but can be combined into a larger setup for decentralized industrial- or utility-scale PV power plants.
- Central inverters rated at 100 kW to 2,300kW and turnkey stations (inverters and related equipment), which are suitable for larger commercial- and utility-scale solar farms.

The Universal Framework simulation tool

The wide range of potential applications for ABB solar inverters raises a question: Is it possible to create a universal tool that allows fast, accurate and customer-oriented computer modeling of how these inverters will behave in all potential power system applications? The answer is, “yes,” and this article will describe just such a tool – the ABB Universal Framework simulation tool – as well as its use for the PVS980 central inverter in various simulation software packages that are utilized in power system analysis →1-2.

The ABB Universal Framework simulation tool is based on the generation of dynamic linked libraries (DLLs) that model the PVS980 central inverter in terms of its control algorithms and connection to a power system. Analyses show that universal black-box models generated by the tool provide the same quantitative results for all software packages considered – PSCAD, Matlab, DlgSILENT PowerFactory and PSS/E – which gives great flexibility in accommodating different customer design environments.

ABB’s Universal Framework simulation tool has been created over a number of years and now covers all requirements of power system design and analysis. The tool is simple to use and easy to adapt to new requirements →2.

—
Is it possible to create a universal tool for fast, accurate and customer-oriented computer modeling of inverter behavior in all power system applications?

Meet the grid codes

One critical aspect of PV inverter simulation covered by the tool is grid code compliance [1]. Inverters connected to a power grid must be compliant with requirements – so-called country grid codes – set out by the network operator that define the safe and proper operation of the entire power system. These compliance requirements can nowadays be reflected in a computer model that is accurate enough to represent the electrical characteristics of real devices under various working conditions.

01



The grid codes describe how devices and reference models should operate during normal network conditions and how they should behave in terms of active and reactive power provision when a fault occurs. The inverter model generated by the Universal Framework simulation tool should contain information about the quantities of active power delivered to the grid as a function of primary energy supply – both at a defined set point and in the event of network frequency change. The regulation of reactive power at different set points should be determined by a characteristic power quality curve.

The model must also follow inverter behavior regarding the withstanding of sudden grid voltage deviation from the nominal amplitude for a certain period and trip when the deviation duration exceeds the time given in the specification. Another aspect that must be covered by the model is the reactive current injected to provide grid support during a voltage dip. The satisfactory performance of the Universal Framework simulation tool under such line fault conditions has been validated by measurements. The certificate from that validation is very often required by the customer, so is of significant additional value.



The model should contain information about the quantities of active power delivered to the grid as a function of primary energy supply.

Universal model principles

Primarily, the Universal Framework simulation tool must provide the functionality to simulate all grid code scenarios. The two most important components in such a simulation are the PV source and the inverter.

—
02 Logo of the Universal Framework simulation tool.

—
03 Comparison of conventional and framework workflow approaches.

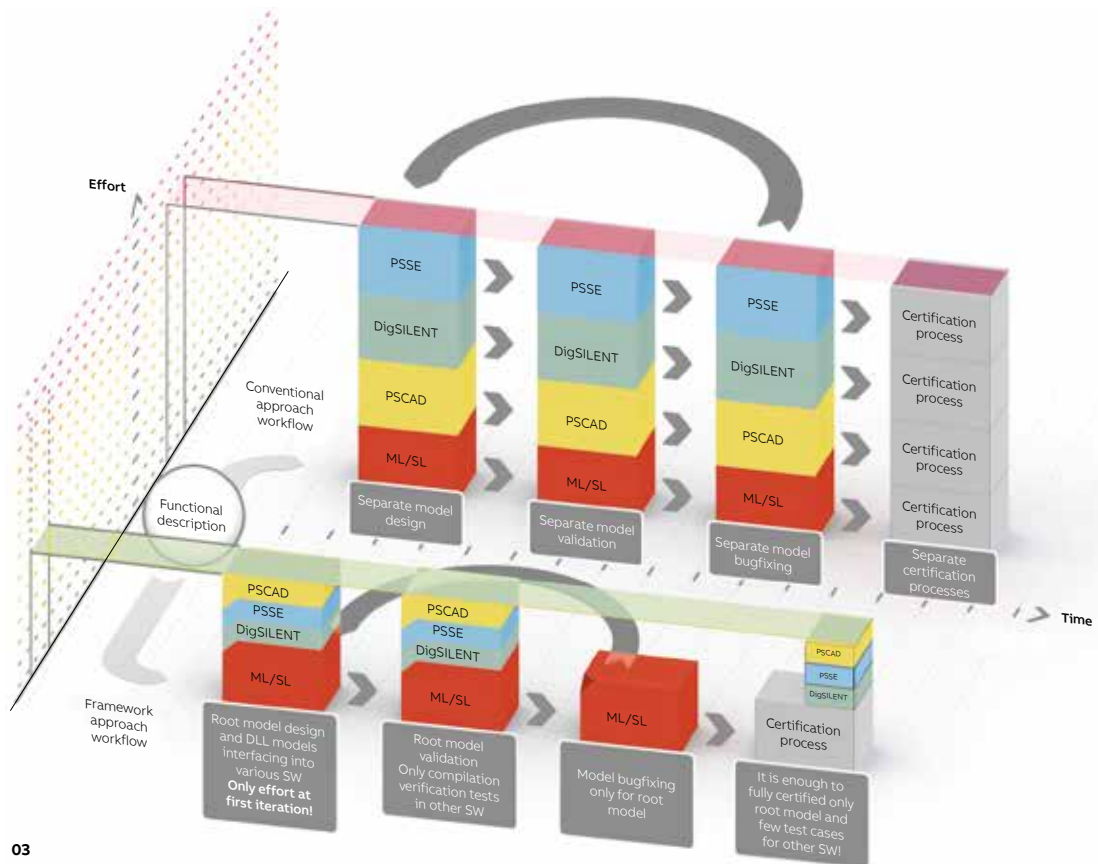

03

The simulation of the PV source component relies on a mathematical or physical model of the solar panel, with irradiance and temperature as basic parameters. Users can define the panel's characteristics in the tool based on its datasheet and create, at will, virtual solar arrays to simulate various input power levels. This part can be included in a DLL, but this is not mandatory as a customer might want to connect an external PV farm model.

The simulation of the inverter component contains a mathematical implementation of the inverter and related control algorithms that covers maximum power extraction from the PV plant, grid synchronization and support (eg, reactive power injection), voltage control, active and reactive power provision control or fault ride through. The Universal Framework simulation tool supports electromagnetic transient and root-mean-square (RMS) input-output interfaces to accommodate different simulation types used by the customer.

As different customers use different simulation environments, it is desirable to have a way to transfer a single basic model into different functional modules. One way to achieve that functionality is to use a Matlab/Simulink root model to generate DLL blocks, which can then be used as separate, external modules in third-party software (such as DigSILENT PowerFactory,

—
Primarily, the Universal Framework simulation tool must provide the functionality to simulate all grid code scenarios.

PSCAD or PSS/E). Full automation of this process is provided by introducing a common framework that is responsible for functional code generation for the model. Interface code for the third-party simulation software (a so-called wrapper) is provided and integrated into the final model.

Additional functionalities required of the tool are: support of automated testing, report generation and model regression testing. These functions support developers in the model building, testing and bug-fixing process.

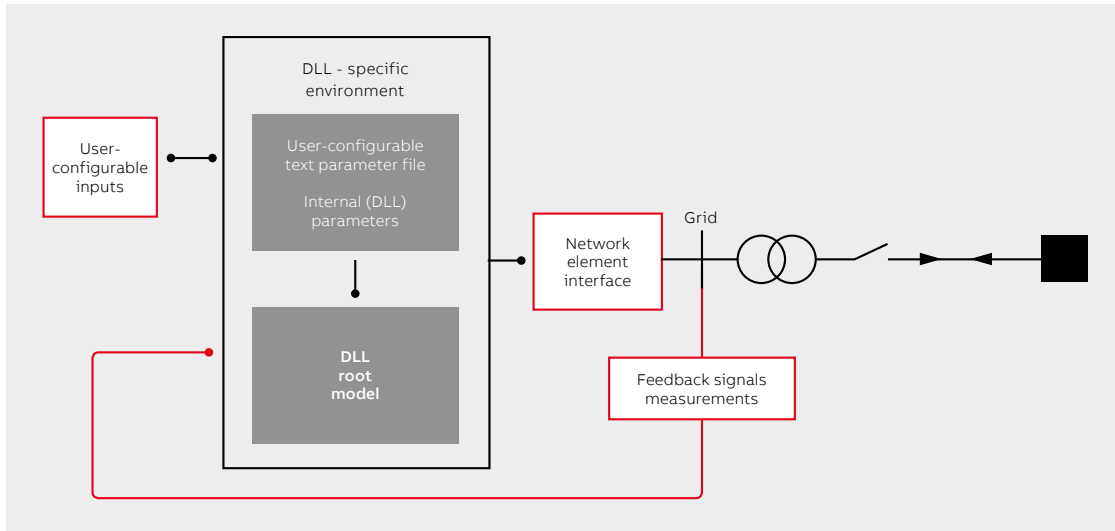

04

The tool also supports DLL back-testing in the Matlab/Simulink environment (so-called software-in-the-loop testing), which is crucial to prove that the code has been generated correctly. The DLL block can be tested in the same environment as the base model. Additionally, the generated models can be delivered as a black-box model to customers who use a Matlab/Simulink simulation environment.

The biggest advantage of black-boxing is that the internal ABB DLL intellectual property is protected. In this way, the entire model can be sent to the customer in PSCAD, PowerFactory or PSS/E without disclosing the internal algorithms. With the manuals provided, the customer can easily reproduce the results in order to validate the grid code behavior of the solar inverter. The whole process of model development and certification can be significantly improved by using the Universal Framework simulation tool as opposed to a conventional approach →3.

The DLL model implementation process usually depends on the simulation software employed and is not as straightforward as it may seem to be. Different simulation packages utilize different

solvers, computational methods, signal interfaces and element libraries. The Universal Framework simulation tool overcomes all the inconveniences related to the implementation process by the creation of an intermediate DLL-specific environment that states a software-specific

—
The ABB Universal Framework tool for solar inverter modeling opens up the possibility of significant cost reduction through its simplicity, flexibility, adaptability and reusability.

interface. Such a solution enables the DLL model to cooperate with the grid by controlling the software-specific network element based on the feedback measurements and user-configurable input signals. The DLL root model-specific parameters are configurable through the external parameter text file, which is common for all simulation software packages →4.

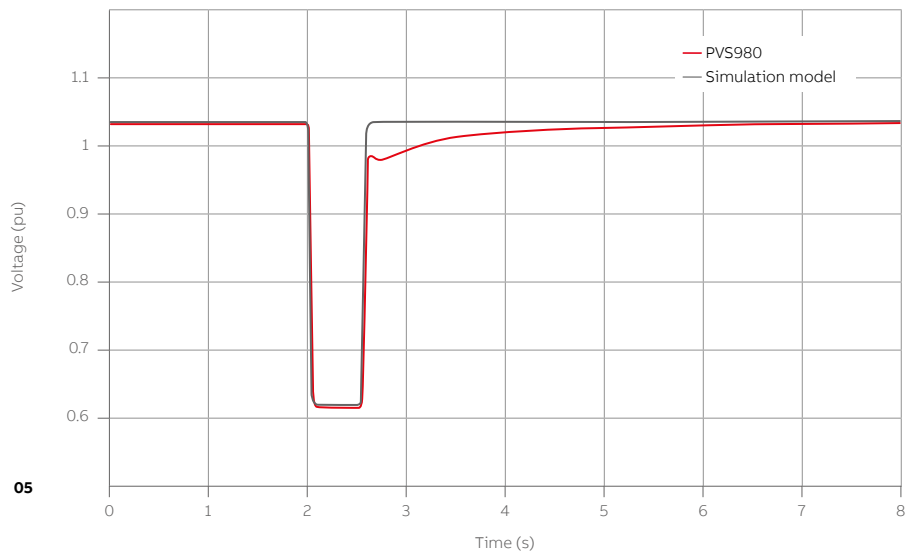

05

— 04 DLL model interfacing in various simulation software packages.

— 05 Positive-sequence voltage RMS line-to-line value during a symmetric fault - measurements and simulation results comparison.

— 06 Positive-sequence RMS line current during a symmetric fault - measurements and simulation results comparison.

— 07 Example reference design with eight solar inverters.

Reference

[1] I. Romero, J. Daniel, D. Pereira, et al., "Consulting the grid code: ABB and its power consulting experts are helping networks integrate renewables and meet grid code requirements," *ABB Review 4/2015*, pp. 50-55.

Model validation

To show that the model developed provides a correct response for various grid code scenarios, it was verified against laboratory experiments. Examples of solar inverter voltage and current during the fault test are illustrated in →5-6. A high level of curve convergence is visible in the prefault steady state and during the fault; transient regions are convergent, too. The differences occur after the fault phase due to the transformer inrush current, which was not taken into consideration during grid modeling. However, the error is within the tolerance margin.

Such validated models can be used for further studies in which the entire customer grid is included. Such a reference design is shown in →7. The grid part uses software-specific libraries and typically contains distribution and power transformers, cables and grid impedances at the point of common coupling (PCC).

A truly universal tool

The approach taken by the Universal Framework tool has been successfully verified for other solar inverter family products, which underlines its reuse credentials. The tool is also compatible with a range of power system analysis software packages and could also be reused for different product groups such as wind turbine inverters, STATCOMs (static compensators) and medium-voltage drive inverters. Moreover, the universal model approach can be extended to other simulation software packages that support a DLL interface, if such a customer demand appears. Compared to the conventional approach, the ABB Universal Framework tool for solar inverter modeling opens up the possibility of significant cost reduction through its simplicity, flexibility, adaptability and reusability. ●

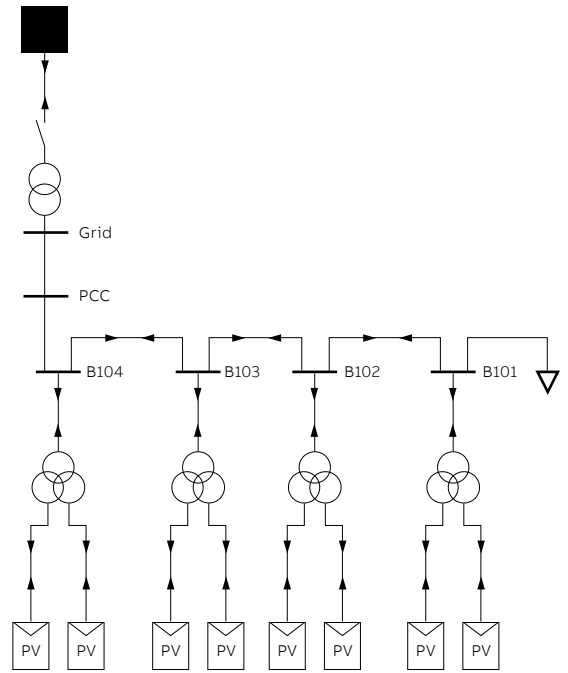

07

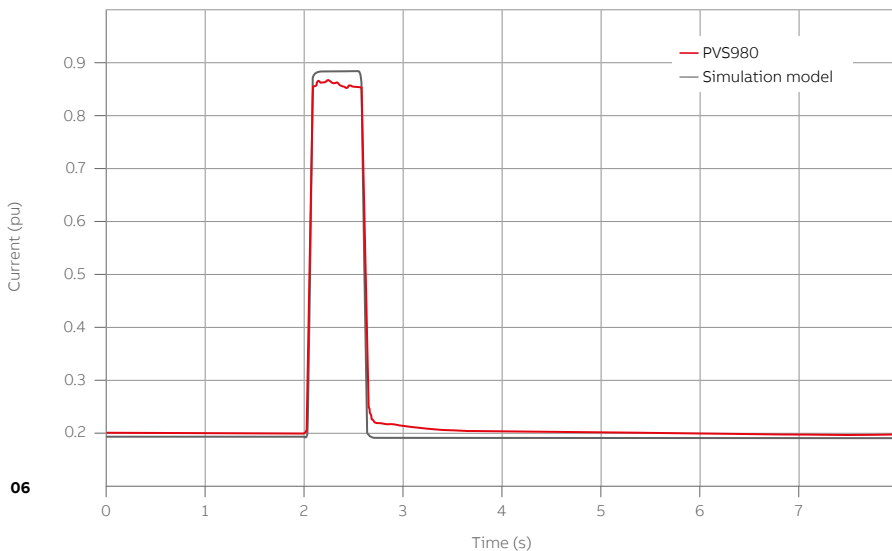

06

DIGITAL AND ANALYTICS

Focusing on cyber security

As businesses attempt to integrate new and legacy systems, often without taking a holistic approach to network security, the worldwide pricetag for cybercrime is expected to nearly double over the next five years. With an installed base of 70 million connected devices, 70,000 digital control systems and 6,000 enterprise software solutions, ABB takes this trend very seriously. The company's Group Cyber Security Council brings together experts from throughout the organization to maximize awareness of potential threats and ensure that measures are implemented according to the same standards across the entire company.



Satish Gannu
ABB Industrial Automation
San Jose, CA, United States
satish.gannu@us.abb.com

According to a recent study conducted by Juniper Research, a UK-based technology research firm, criminal digital data breaches could cost businesses a total of \$8 trillion worldwide over the next 5 years. The growing size of such breaches is being driven in large part by the steady increase in Internet connectivity and by the challenges faced by enterprises as they struggle to keep up with this trend by rolling out new cyber security measures.

Criminal digital data breaches could cost businesses a total of \$8 trillion worldwide over the next 5 years.

In its study [1], Juniper Research estimates that the number of personal data records stolen by cyber criminals is likely to nearly double to 5 billion by 2020 from an estimated 2.8 billion in 2017.



This trend indicates that cyber security problems are becoming particularly acute as businesses attempt to integrate new and legacy systems without taking a holistic approach to network security.

Huge installed base

ABB takes this trend very seriously. The company has an installed base of 70 million connected devices, 70,000 digital control systems and 6,000 enterprise software solutions. As a leader in the industrial space, it has four decades of experience creating secure digital solutions for customers in critical business segments, such as oil and gas, power generation and distribution. The slightest interruption in such areas can have massive consequences for economic activity and the environment.

Worldwide wake-up call

The 2010 cyber security breach that came to be known as Stuxnet at the Natanz uranium enrichment plant in Iran was a wake-up call for the entire industry – and for the whole world.

ABB has four decades of experience creating secure digital solutions for customers in critical business segments.

Although ABB equipment was not compromised, the incident triggered a process of internal reflection and investigation.



ABB Group Cyber Security Council



ABB has a formally established cyber security organization reporting to top management

01

The Stuxnet breach made clear that any company could have been hit and it exposed the potential vulnerabilities of a vast range of devices.

Strengthening operational readiness

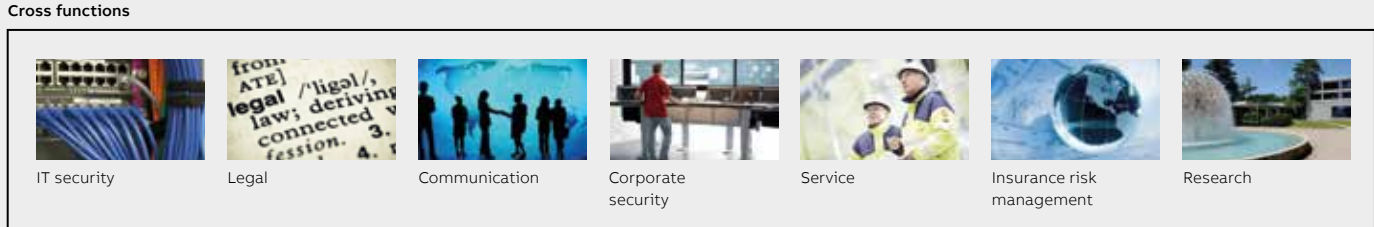
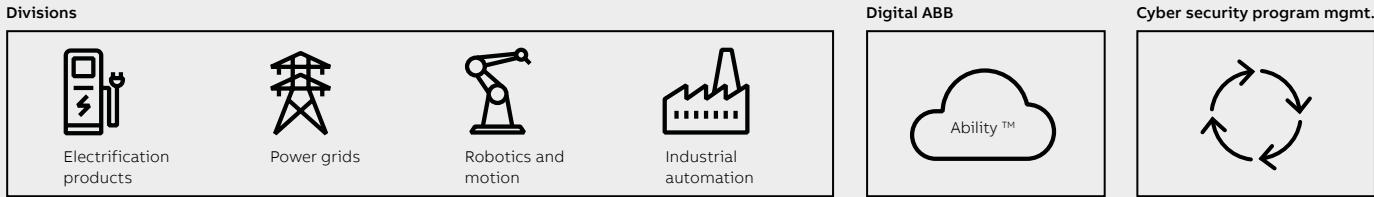
With this in mind, ABB initiated a process of scaling up local and divisional initiatives to group level. As a result, the Group Cyber Security Council was created. As indicated in →1, the Council evolved into a body designed to ensure an ongoing strengthening of ABB’s operational readiness.

The Group Cyber Security Council works to keep internal cyber security awareness at a high level throughout the organization.

Benefitting from a wide range of experts in areas such as R&D, IS infrastructures, legal and communications, the Council actively works to keep internal cyber security awareness at a high level throughout the organization.

The Council also participates in standardization efforts such as Platform Industrie 4.0 and the Industrial Internet Consortium and works closely with dozens of universities. Furthermore, the Council ensures that measures are implemented according to the same standards across the entire company →2 and that ABB suppliers are at the same level of security as is ABB itself.

Cyber security: front and center

Over the years, cyber security has become an integral part of ABB’s product portfolio. Today, it is front and center at every phase, from design and development to product maintenance and support.

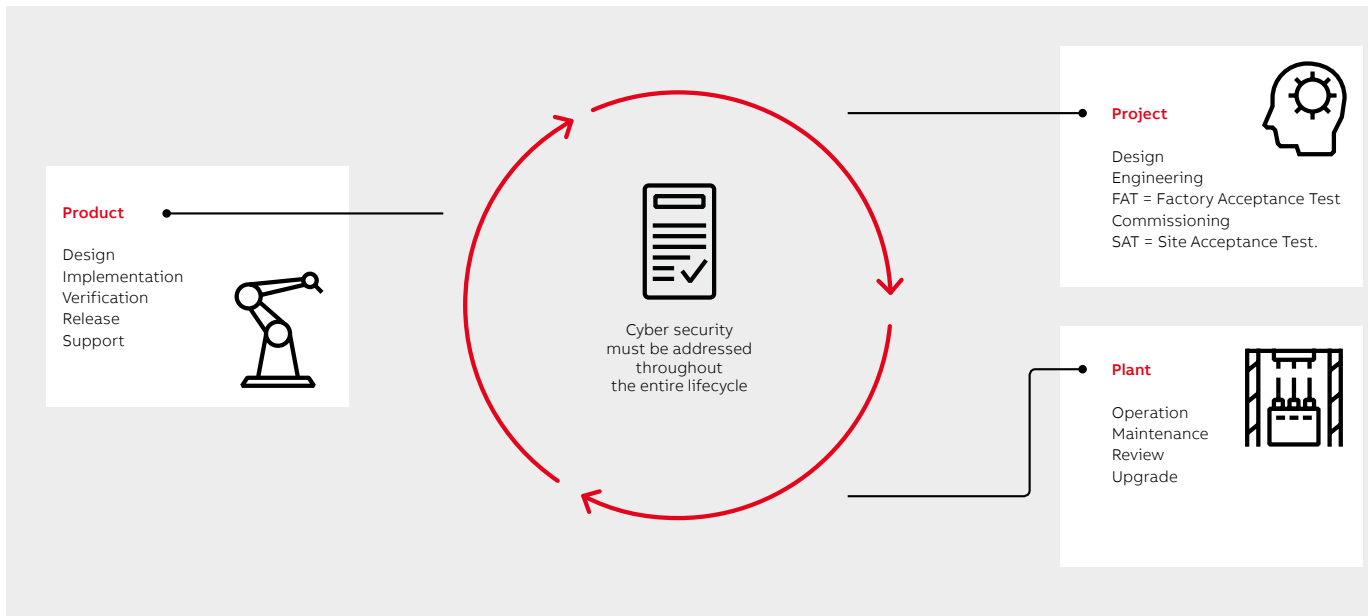

02

—
01 The Group Cyber Security Council is designed to ensure an ongoing strengthening of ABB's operational readiness.

—
02 ABB's approach to cyber security is holistic. It addresses everything from design and development to product maintenance and support.

—
Reference
[1] Juniper Research, "Cybercrime to cost global business over \$8 trillion in the next 5 years." Available: [https://www.juniperresearch.com/press/press-releases/cybercrime-to-cost-global-business-over-\\$8-trn](https://www.juniperresearch.com/press/press-releases/cybercrime-to-cost-global-business-over-$8-trn)

A few examples of what ABB is doing to increase the reliability and security of its solutions include:

- Threat modeling and security design reviews
- Security training of software developers
- In-house and external security testing as part of quality assurance processes.

What has already happened in the IT sector is now taking place in industrial-control-system cyber security. Indeed, cyber security is becoming an integral part of daily life with automated software updates, security patches and antivirus updates designed to thwart a growing number of threats. ABB is ready to enhance security features on a constant basis through innovations and to provide the right products to meet the security needs of its customers' critical infrastructures. ●

—
ABB is ready to enhance security features on a constant basis through innovations and to provide the right products to meet the security needs of its customers' critical infrastructures.

BUZZWORD DEMYSTIFIER

Quantum-Safe encryption

Mission critical systems, such as railway, air-traffic control or power-grids require encryption that is both extremely secure and provide long term data protection in a post-quantum world. Quantum physics provides such a solution.



Rouven Floeter
ABB Power Systems,
Grid Automation
Baden, Switzerland

rouven.floeter@
ch.abb.com

Industry is becoming more and more digital and more and more interconnected. Ever increasing volumes of data are being transmitted. Some of this data requires a high level of security and even long-term futureproof protection, especially in mission-critical processes. Even communication links that are physically protected and encrypted are not invulnerable to attacks. Physical security can be worked around, and there are sniffing methods that permit data to be coupled from a communication line without requiring physical contact to the device.

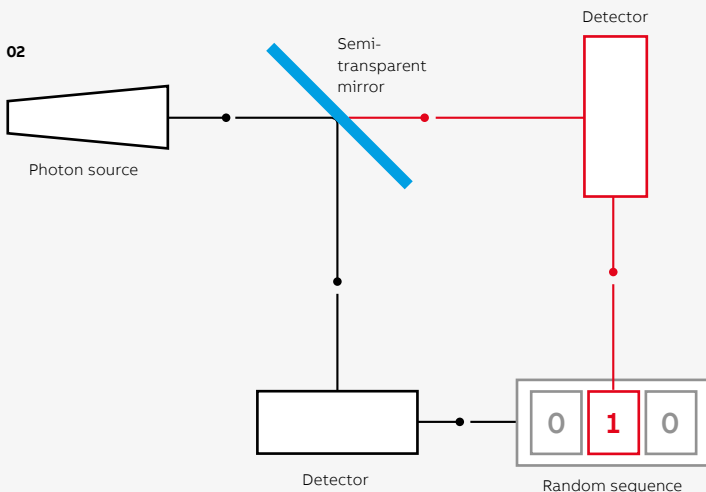

01



Cryptography revolves around digital keys. A key is essentially a large number used to encrypt data. If a third party eavesdrops on the transmission, they can observe and record the individual bits of the message, but if they do not know the key, the number crunching required to break the code is so large as to be unviable.



—
01 Quantum physics permits the creation of truly nondeterministic systems.

—
02 ABB's SECU1 encryption card uses quantum physics to create encryption keys in a truly nondeterministic manner.

Secure transmission has two phases: the encryption of the data and the exchange of the necessary keys. Conventional methods based on mathematically generated random numbers will soon no longer be sufficient for secure key generation, because the computers they run on are themselves deterministic, and because quantum computers will soon be able to crack this type of asymmetric encryption. Quantum safe cryptography breaks new ground and uses a method that uses the physical properties of light to generate truly random numbers.

One simple way of achieving this is to consider a photon hitting a semi transparent mirror. A single photon can be reflected from the surface or transmitted through it, but not both at the same time. If one detector is positioned to register a transmitted photon and another a reflected photon, the combination of the outputs of both detectors forms a truly random binary sequence. →1

The second phase is the key transmission. In quantum key distribution, the basic idea is that the orientation of the electric field of a photon is used to transmit the keys. To transmit the keys, a transmitter generates photons with random orientation. As soon as a hacker tries to listen to the key, he changes the bits of the quantum code.

The reading process already changes the state. Sender and receiver detect this, and the attempted eavesdropping is revealed. The key generation and transmission starts again from the beginning. The quantum method for key distribution has already been successfully tested and makes data transmission much more secure.

The best cryptography is of little value in a mission-critical system if the special requirements of mission-critical applications regarding communication performance (eg, jitter, migration, latency), but also regarding the availability of the communication infrastructure are not taken into account by extensive measurements of these critical parameters.

In 2017, ABB acquired the network business of KEYMILE and is now able to offer quantum-safe communication solution for critical infrastructure. By installing devices such as the SECU1 encryption card →2 between a device and the network, communications can be made secure without adding to latency. ●

Imprint

Editorial Board

Bazmi Husain
Chief Technology Officer
Group R&D and Technology

Adrienne Williams
Senior Sustainability
Advisor

Christoph Sieder
Head of Corporate
Communications

Reiner Schoenrock
Technology and Innovation
Communications

Roland Weiss
R&D Strategy Manager
Group R&D and Technology

Andreas Moglestue
Chief Editor, ABB Review
andreas.moglestue@
ch.abb.com

Publisher

ABB Review is published
by ABB Group R&D and
Technology.

ABB Switzerland Ltd.
ABB Review
Segelhofstrasse 1K
CH-5405 Baden-Daettwil
Switzerland
abb.review@ch.abb.com

ABB Review is published
four times a year
in English, French,
German and Spanish.
ABB Review is free of
charge to those with
an interest in ABB's
technology and
objectives.

For a subscription, please
contact your nearest
ABB representative or
subscribe online at
www.abb.com/abbreview

Partial reprints or
reproductions are
permitted subject to
full acknowledgement.
Complete reprints require
the publisher's written
consent.

Publisher and copyright
©2017
ABB Switzerland Ltd.
Baden/Switzerland

Printer

Vorarlberger
Verlagsanstalt GmbH
6850 Dornbirn/Austria

—
Layout
DAVILLA AG
Zurich/Switzerland

—
Artwork
Konica Minolta
Marketing Services
WC1V 7PB London,
United Kingdom

Disclaimer

The information
contained herein
reflects the views of
the authors and is for
informational purposes
only. Readers should not
act upon the information
contained herein without
seeking professional
advice. We make
publications available
with the understanding
that the authors are not
rendering technical or
other professional advice
or opinions on specific
facts or matters and
assume no liability
whatsoever in
connection with
their use.

The companies of the ABB
Group do not make any
warranty or guarantee,
or promise, expressed or
implied, concerning the
content or accuracy of the
views expressed herein.

ISSN: 1013-3119

<http://www.abb.com/abbreview>



Tablet edition

ABB Review is
also available
for your tablet.

Please visit
abb.com/abbreviewapp

Stay informed...

Have you ever missed a copy of ABB Review?
Sign up for the email alert at
abb.com/abbreview
and never miss another edition.

Please note that when you register for this alert, you will
receive an email with a confirmation link. Please ensure that
you have confirmed your registration.



Next 04/2018

Autonomous Systems

A factory is traditionally a physical location where things are made, but the digitization of industry is transforming it into something much more: A collection of skills, abilities, and systems that get smarter over time, thereby enabling businesses to innovate what, how, who, and where manufacturing gets done. The next issue of ABB Review will provide first-ever visibility in how its customers are implementing such cutting-edge ideas.