







Hazlux® LE2 LED Series

The LE2 LED Series is a slim, shock and vibration resistant fixture made of copper-free aluminum. This durable product has exposed hardware made from stainless steel and is suitable for marine and wet locations.

CERTIFICATION	
CLASS I	
Division 2	Group A, B, C, D
CLASS II	
Division 1	Group E, F, G
CLASS III	
Classification may vary depending on the product configuration. Please follow catalogue information and exceptions.	

APPROVALS		
		
		

APPLICATIONS
Power plants
Paper mills
Wastewater treatment plants
Loading docks
Chemical processing
Storage facilities

LINEAR LIGHTING

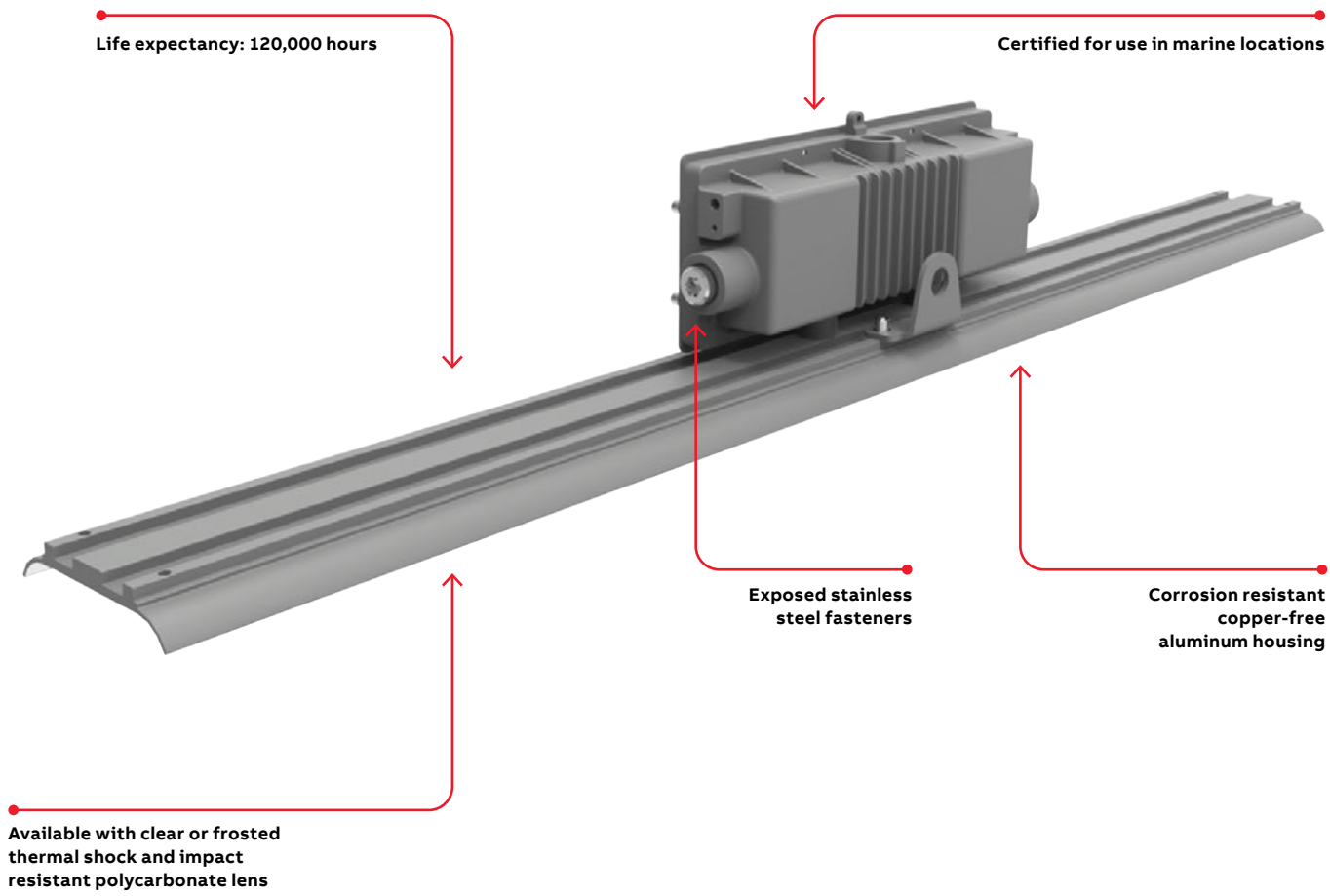

Life expectancy: 120,000 hours

Certified for use in marine locations

Exposed stainless steel fasteners

Corrosion resistant copper-free aluminum housing

Available with clear or frosted thermal shock and impact resistant polycarbonate lens

Hazlux® LE2 LED Series

Key features and information

FEATURES

Operating temperature: -40°F to 122°F (-40°C +50°C)
optimal 77°F (25°C)

Exposed hardware made of stainless steel

Slim and compact design

HOUSING

Housing made of copper-free aluminum

Anti-corrosion housing (tested for 1000hrs)

Shock and impact resistant polycarbonate lens

Lens tested to IK08

LED

Efficacy: up to 137 Lm/W

Lumen output: from 5,480 lumens to 10,960 lumens

Meanwell LED's

UL 8750 LED safety

CRI Ra>70

Correlated Color Temperature (CCT): 5000K (standard),
3000K and 4000K (optional)

ELECTRICAL

Operating voltage: universal 120-277 VAC, 347-480 VAC
(50/60Hz)

Power factor 0.95

Driver efficiency 90%

THD <20%

Surge protection standard at 4KV
(Contact your sales representative if high protection is
required.)

MOUNTING

Pendant mount

Optional yoke/pipe bracket for wall/ceiling or pole
mount

Chain mount ("Chain" supplied by others)

APPROVALS

UL844 & CSA C22.2 No. 137-M1981

UL 1598A marine

UL 1598 wet locations

UL 8750 LED safety

FCC

IP66

IK08

5G (shock and vibration resistant)

1000hrs salt spray

WARRANTY

5 Years limited warranty

T-code chart

Fixture	40 watt	80 watt
C1D2	T3C	T3C
C1D1	T4A	T4A

Electrical specifications

Specification	LE2-4	LE2-8
Rated power	40W	80W
Input voltage	120-277, 347-480V	
Input frequency	50/60Hz	
Input current	(120/277V) 0.34/0.16A	0.67/0.32A
	(347/480V) 0.13/0.09A	0.25/0.18A

Lighting output

Fixture	40 watt	80 watt
Lumen output	5480	10960
Lumen per watt	137	137



Hazlux® LE2 LED Series

PHOTOMETRY

110 degree

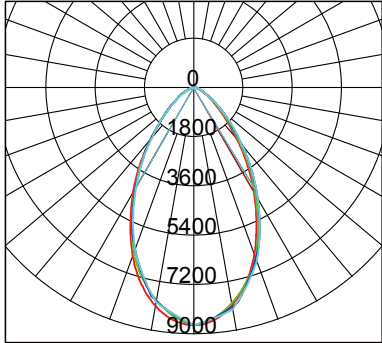

- C0/180,60.8
- C30/210,60.8
- C60/240,61.3
- C90/270,61.0

BUG rating: B3-U0-G1

MOUNTING AND OPTIONAL ACCESSORIES (sold separately)

Pendant mount (included standard)

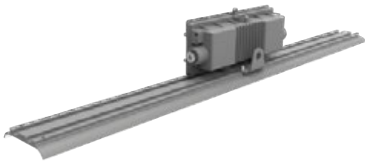

Chain mount (compatible)

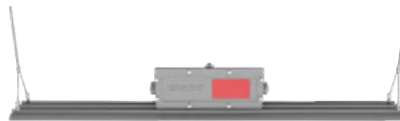

Chain supplied by others.

Yoke/pipe bracket (optional accessory) Ceiling and wall

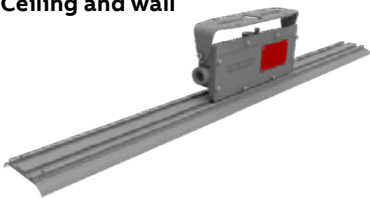

Stanchion mount (optional accessory)

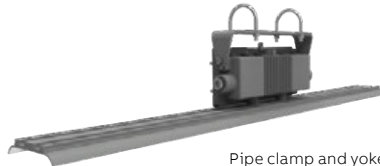

Pipe clamp and yoke/pipe bracket required for stanchion installation. Sold separately.

Accessories



PC01 - Pipe clamp (1 pair)
Pipe clamp (M8*48mm) for pole Ø1-7/8" (48mm)



PC02 - Pipe clamp (1 pair)
Pipe clamp (M8*60mm) for pole Ø2-3/8" (60mm)



UB02 - Yoke/pipe bracket (SUS 304) stainless steel



SC02 - Stainless steel safety cable kit

Hazlux® LE2 LED Series

DIMENSIONS

Dimensions are approximate and subject to change.

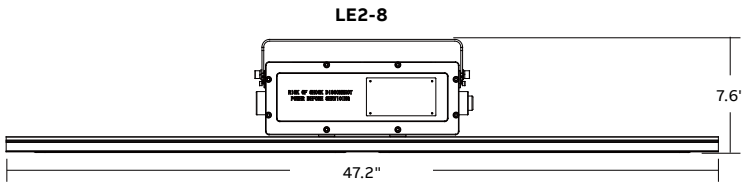
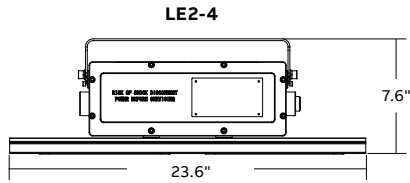

Bracket dimensions

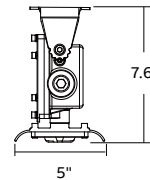
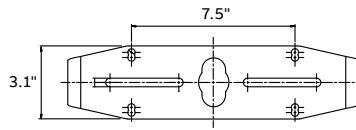

SC02 - Stainless steel safety cable kit

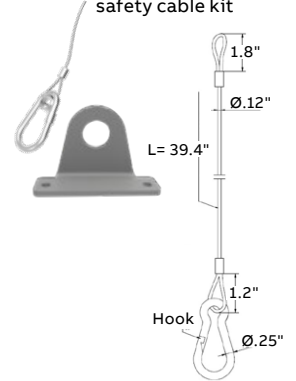

Model	Weight	Dimensions (L x W x H)
LE2-4	5.5kg/12.1lbs	23.6 x 5.0 x 7.6 in
LE2-8	7.6kg/16.7lbs	47.2 x 5.0 x 7.6 in

¹Dimensions are approximate and subject to change.

NUMBERING SYSTEM

Lighting fixture

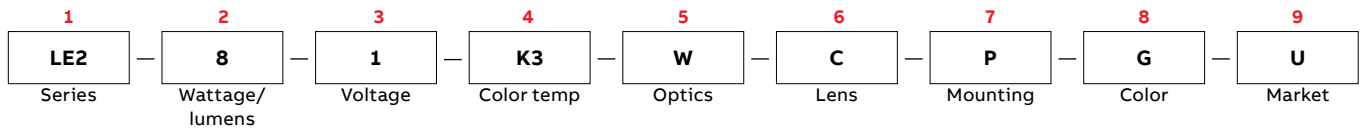

Ordering information

Part	Part number	Description
1 Series	LE2	Hazlux® linear light LED
2 Wattage/lumens	4	40W (5,480 lm)
	8	80W (10,960 lm)
3 Voltage	1	120-277V
	4	347-480V
4 Color temp	K3	3000K ¹
	K4	4000K ¹
	K5	5000K (standard)
5 Optics	W	110°
6 Lens	C	Clear polycarbonate
	F	Frosted polycarbonate ¹
7 Mounting	P	NPT 3/4 pendant mount
	U	NPT 3/4 pendant mount + yoke bracket
8 Color	G	Gray
9 Market	U	U.S. market
	Blank	Canadian market

¹Longer lead time, contact your sales representative for more details

Accessories (sold separately)

PC01	Pipe clamp (1 pair) Pipe clamp (M8*48mm) for pole Ø 1-7/8" (48mm)
PC02	Pipe clamp (1 pair) Pipe clamp (M8*60mm) for pole Ø 2-3/8" (60mm)
SC02	Stainless steel safety cable kit
UB02	Yoke/pipe bracket (SUS 304) stainless steel

Note: For Canadian market, please add "-CA" to the part no. (ex: PC01-CA).