

## MURRAYLINK, THE LONGEST UNDERGROUND HVDC CABLE IN THE WORLD

<b>I. MATTSSON*</b>	<b>B.D. RAILING</b>	<b>B.WILLIAMS</b>	<b>G. MOREAU</b>	<b>C. D. CLARKE</b>
<b>A. ERICSSON</b>	<b>J.J. MILLER</b>	<b>TransÉnergie AUS</b>	<b>Hydro- Québec</b>	<b>SNC Lavalin</b>
<b>ABB</b>	<b>TransÉnergieUS</b>	<b>(Australia)</b>	<b>(Canada)</b>	<b>(Canada)</b>
<b>(Sweden)</b>	<b>(USA)</b>			

### 1. INTRODUCTION

The Murraylink Transmission Company Ltd (MTC) awarded a contract in December 2000 for the turnkey engineering, procurement and construction of the Murraylink Transmission Interconnection Project in Australia. The contract included two complete AC/DC converter stations interconnected by a pair of underground DC cables, a new substation and AC cable interconnections from each converter to the nearby AC switchyard [1].

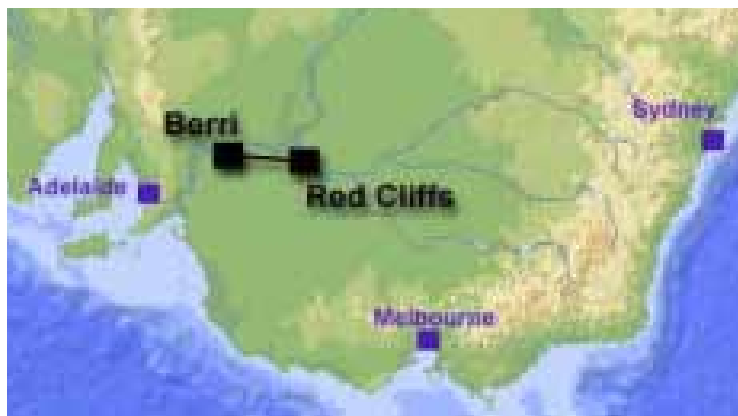

Figure 1. Murraylink Geographical Location

Murraylink provides a new directly controllable interconnection between the electricity market regions of Victoria and South Australia. The link is used to transfer power in either direction in response to market price differences. Reliability of the

Riverland area electricity supply, which is in the vicinity of Berri, is also vastly improved by the introduction of Murraylink.

Key reasons for the choice of voltage source converter (VSC) based HVDC technology for the project include: 1) the use of a light weight, solid insulated HVDC cable system that could be direct buried, allowing the use of existing rights-of-way and fast permitting/approvals; 2) reactive power control for support of the relatively weak AC networks; 3) compact converter station layout primarily within a standard warehouse-style building, and 4) modular, factory-tested



Figure 2. HVDC station at Red Cliffs

\* ABB Power Technologies, HVDC, Sweden; E-mail [ingemar.mattsson@se.abb.com](mailto:ingemar.mattsson@se.abb.com)

design that allows for a short field testing and commissioning period. The complete development period for Murraylink from project conception to commercial operation was 39 months.

The Murraylink project earned several Australian state and national awards for both environmental and engineering excellence.

## 2. GENERAL SYSTEM DESCRIPTION

### 2.1 AC Networks

As illustrated in Figure 3, Murraylink interconnects the AC networks in the states of South Australia and Victoria. These AC networks are contained within two separate market regions. Connection to the South Australia AC transmission system was established through the construction of a new 132 kV substation at Monash. This substation contains two line bays to accommodate the existing 132 kV transmission lines, two 18 Mvar breaker switched shunt capacitor banks, and a bay for connection of a 400 m underground AC cable tie to the Berri converter station. In Victoria, the Red Cliffs converter station is connected to an existing 220 kV position at the Red Cliffs Terminal Station (RCTS), by a 330 m underground AC cable tie. Three 220 kV transmission lines emanate from RCTS connecting into the transmission network in New South Wales as well as central Victoria.

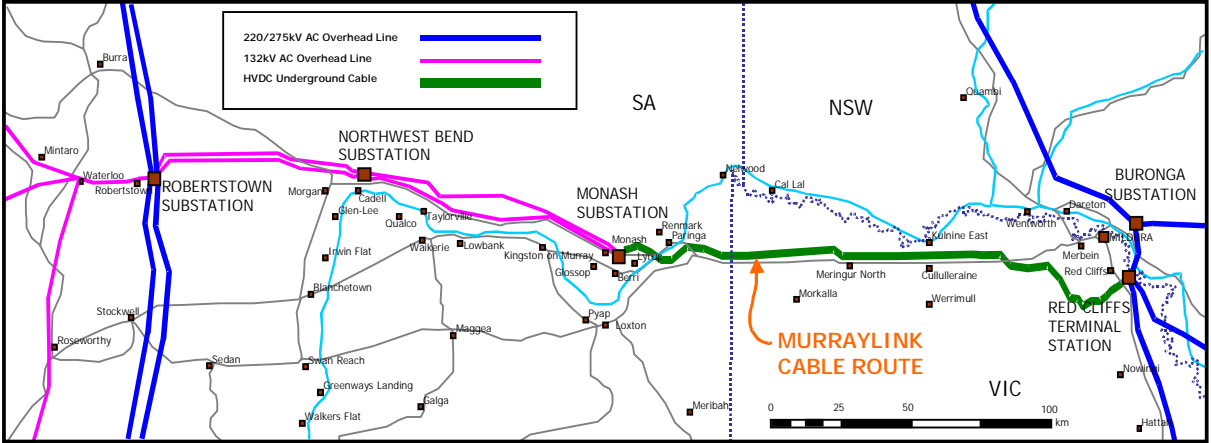

Figure 3. Murraylink AC interconnection locations

Both Murraylink converters are connected to the AC networks at fairly remote locations, consequently short circuit strength of the AC networks is relatively weak. With all local AC transmission lines in service, the approximate three-phase short circuit strengths are:

- Monash 132 kV substation, SA – 450 MVA
- Red Cliffs 220 kV terminal station, Victoria – 1000 MVA

Given the relatively weak interconnection points, the AC voltage control provided by the Murraylink VSCs is very instrumental in supporting real power transfers between the AC networks. Equivalent transfers would not be possible with conventional HVDC technology or an AC tie without addition of variable reactive power support from an SVC or similar device.

A further consequence of the relatively weak connection points is that Murraylink power transfers can be constrained during times of high network load (particularly summer loads). These constraints can be due to either thermal or voltage stability conditions following contingent outage of critical supply-side network elements. In order to increase Murraylink power transfer capability without requiring major physical AC network augmentations, MTC elected to exploit the controllable features of the VSC technology and implement power transfer run-back controls. The run-back schemes monitor the status of remote network elements (circuit breakers, lines and transformers) and, in the event of a remote trip will reduce Murraylink power transfer to relieve post-contingent network loading. Run-back speeds can be designed to accommodate specific outages of critical plant and also future load growth in the surrounding AC networks.

## 2.2 DC Transmission System

### 2.2.1 Converter Equipment

The Murraylink converter equipment is very similar to the equipment used for the Cross Sound Cable (CSC) project between New York and Connecticut in the U.S.A. As the number of pages of this publication is limited, the reader is kindly asked to review reference [2] for information on the converter equipment. The following paragraphs will only elaborate on the differences between the two projects. The Murraylink converter rating is slightly lower than CSC's. The Murraylink converters can deliver 220 MW at the inverter PCC, while CSC delivers 330 MW. The converters can operate in any point within the P-Q diagram shown on Figure 4.

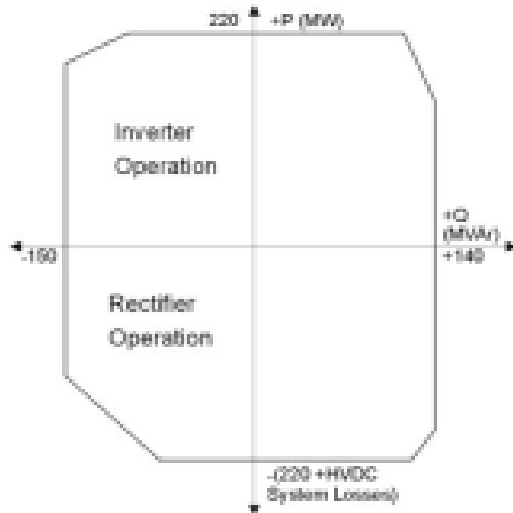

The Murraylink IGBT valves are switched at 1,350 Hz compared to 1,260 Hz for CSC, which result in different tuning frequencies for the AC filters shown on Figure 5.

The limits for DC side harmonics are tighter for Murraylink, which required the addition of a zero-sequence reactor and of a 9<sup>th</sup>/21<sup>st</sup> harmonic filter.

Figure 4 Active and Reactive Control Range

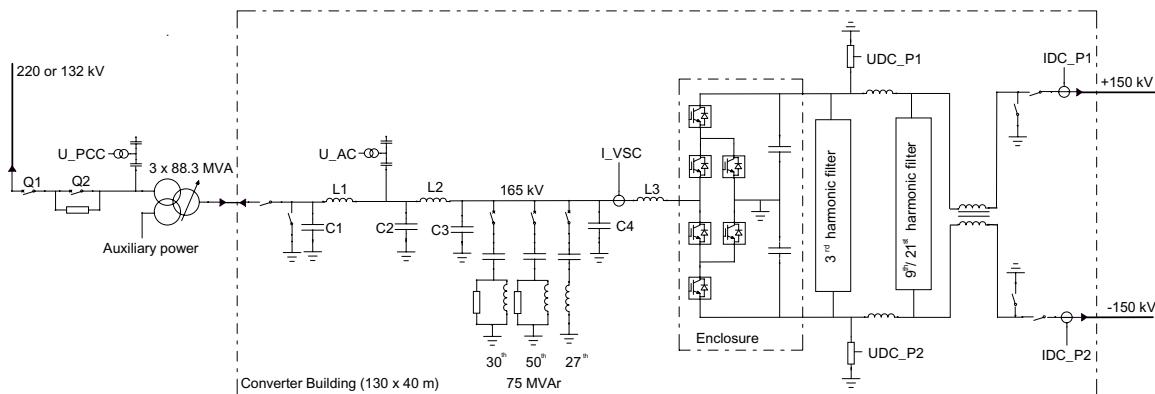

Figure 5. Single Line Diagram of Murraylink

### 2.2.2 Converter Control and Protection

#### 2.2.2.1 AC voltage control

By using the AC voltage control feature available in the VSC technology, over voltages due to events in the grid could be alleviated. The AC voltages at the Murraylink converters are very sensitive to changes in reactive power flow, due to the high impedances in the network. However, the control is stable in all modes of operation and supports the network voltage during dynamic events.

#### 2.2.2.2 Control Differences compared to Cross Sound Cable Project (CSC)<sup>[2]</sup>

Although the converter design is similar for both Murraylink and CSC, the Murraylink control system uses sinusoidal pulse width modulation (PWM) without the third harmonic modulation used in CSC. The reason for this is that the active power requirement is less than in CSC. In Murraylink there is no need for sub-synchronous damping control as there are no generators close to the converters.

The use of a long DC cable does not impact on the structure of the DC voltage controller, however the setting is different from CSC. This applies also to the DC voltage balance control since the common mode DC impedance is different from that in CSC. The reason for the different impedance is not only

due to the length of the cable, but also to the use of an additional ninth harmonic DC filter and the connection of two AC filters to ground compared to only one in CSC.

### 2.2.2.3 Similarities to CSC control

In both Murraylink and CSC, one converter controls DC voltage and the other controls active power. It is possible to operate either converter in reactive power control or in AC voltage control independent of which is controlling active power.

The control is duplicated to increase availability with one control active and the other in standby. The design allows interruption free transfer between the two control systems. The protection systems are implemented separately from the converter controls to ensure safe operation.

### 2.2.3 DC Transmission Cables, Installation and Rating

A completely dry cable system was chosen for the transmission link having cost-effectiveness as a main parameter. The design concept was based on earlier commercial deliveries and the preceding development work has been reported elsewhere [3].

The cable design employed two different aluminium conductor areas, 1200 mm<sup>2</sup> and 1400 mm<sup>2</sup>, as the thermal properties of the soil were not uniform along the cable route [4]. Further thermal optimisation would have been possible, but with marginal savings as only two conductor sizes made it possible to use a single joint design for the whole project. The insulation system consists of inner semi-conducting screen, main insulation wall and outer semi-conducting screen where the materials are specially designed for DC applications. The insulation system is covered by a copper wire screen, on top of which a radial water blocking system is applied. The latter consists of a layer of swelling tape and a watertight aluminium/polyethylene laminate. Finally, an HDPE jacket is extruded as an outer protection.

The cable terminations are of an all-dry type using a design with a stress relief cone and weather sheds made of EPDM rubber. No special tools are necessary for the assembly of the terminations. For a cable system with close to 400 joints, as in the Murraylink, a robust and easy-to-mount joint was essential. The chosen design was a one-piece 150 kV pre-fabricated joint that uses a field controlling layer as shown in Figure 6. The field-controlling layer resides between the cable insulation and the insulating material of the joint and has non-linear electrical properties in order to cope with both DC and AC-type conditions such as surges [5].

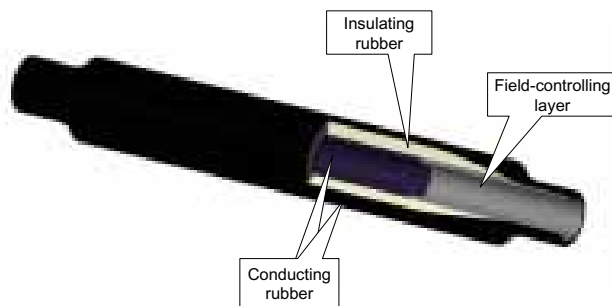

Figure 6. Prefabricated DC joint



Figure 7. Cable-laying machine

The installation of the 177 km long cable system was done at an unprecedented speed in accord with a very strict Environmental Management Plan (even detailing the number of bushes to be trimmed etc.). The laying speed averaged over 1000 m per day with peak speeds up to 3000 m per day, using cable-laying machines as pictured in Figure 7. These speeds were achieved even though the laying was in close proximity to protected vegetation, communication wires and a gas pipeline over a portion of the route. As a result of the meticulous work, the installation was honoured with the 2002 National Case Earth Award for environmental excellence.

### **3. COMMISSIONING**

The installation of the DC transmission cables was completed in early July 2002. These cables were confirmed suitable for transmission testing using portable DC hi-pot and pulse-echo equipment. Converter station installation was completed in late July, 2002. Sub-system testing of the installed converter stations was performed in a period of 4-6 weeks, most of which was completed in parallel with the installation. This short period was possible due to the modular design of the converter sub-systems and pre-testing in the factory.

The converter terminal tests and the transmission tests commenced in early August 2002, after the completion of the sub-system testing. This test period was completed by Sept 30, 2002 except for a few high power test levels that could not be performed due to AC network constraints. High voltage is first applied to each converter station during the terminal tests. Tests are performed to verify protections, controls and switching sequences. Transmission testing is performed following the completion of the terminal testing, again to verify the protections, controls and now the transmission operating modes. Performance measurements were made at the end of the transmission tests period. Parameters measured during the performance tests were step responses, AC and DC side harmonics, losses, audible sound and high voltage transients.

### **4. STEADY STATE PERFORMANCE**

#### **4.1 Audible Sound**

According to the contract the measured, tonal adjusted, energy averaged noise level,  $L_{eq}$ , generated by the converter station at Red Cliffs must not exceed 36 dB(A). At Berri converter station the target figure was 35 dB(A). These stringent demands resulted in a transformer design with extremely low flux density. The transformers did not exceed 84 dB(A) at maximum network voltage. Measurements at Red Cliffs without the converter station in service showed a higher noise level than the demands. From the sound measurements, it was determined that the transformers in the adjacent existing AC substation are the primary source of this noise. Emissions from the Berri converter station were less than the specified criterion.

#### **4.2 AC Side Harmonics**

The connecting utilities stipulated strict limits on AC side harmonics as shown in Table I. The top part of Figure 8 indicates that the requirements were met as the only noticeable increase in AC voltage distortion is at the 29<sup>th</sup>. In fact the low order harmonics are reduced when the interconnection is in operation. This was not the case at the beginning of the commissioning: the 7<sup>th</sup> harmonic was problematic but this was quickly resolved by tuning the low order harmonic controllers. Total harmonic distortion (THD) is also reduced (from 1.0 to 0.8%) when the interconnection is in operation. The telephone interference factor (TIF) slightly increases from 10 to 15 when the converters are in operation.

#### **4.3 DC Side Harmonics**

Very strict requirements were also specified for the DC side harmonics to prevent telephone interference, which is more probable with underground transmission as telephone cables can come within a few meters of the power cables. The requirements were expressed by a psophometrically weighted rms value of the DC side residual current, namely  $I_{eq}$  factor, with a maximum threshold of 200 mA<sub>rms</sub>. As shown in the bottom part of Figure 8, the major components of the DC side converter current are even harmonics (except the 3<sup>rd</sup>), which are pole mode. Furthermore the DC cable screen offers a very good shielding as shown on a log scale on the bottom curve. This was measured via Rogowski coils installed around the DC cables. The corresponding value for the psophometrically weighted residual current was 50 mA<sub>rms</sub>.

Table I – Maximum levels for AC side harmonics

Odd Harmonics Non Triplen		Odd Harmonics Triplen		Even Harmonics	
Order h	D <sub>h</sub> (%)	Order h	D <sub>h</sub> (%)	Order h	D <sub>h</sub> (%)
5	0.625	3	0.625	2	0.31
7	0.625	9	0.625	4	0.31
11	0.625	15	0.20	6	0.31
13	0.625	≥ 21	0.13	8	0.25
17	0.625			10	0.25
19	0.625			≥ 12	0.13
23	0.625				
≥ 25	0.50				
THD (%)		≤0.9			
TIF		<40			

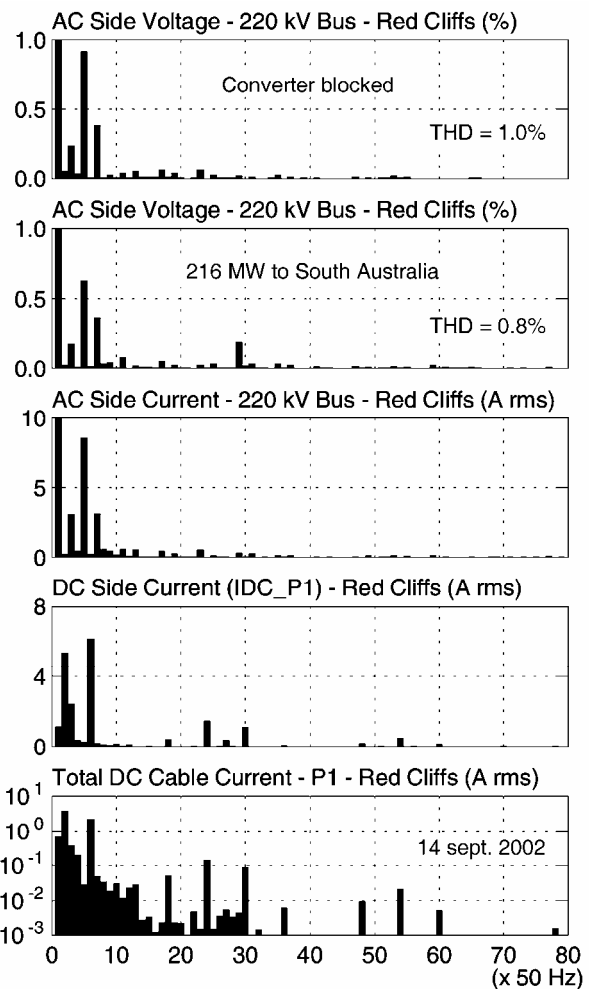

Figure 8  
Typical spectra for AC side and DC side harmonics

#### 4.4 Losses

Actual Murraylink transmission system losses were measured during commissioning of the project. All converter station auxiliary power was supplied by the Murraylink power transformer tertiary windings during measurements. The cooling systems for the IGBT valves, phase reactors, building areas and power transformers were operated at maximum to simulate cooling load at 40°C dry-bulb air temperature. The actual loss curve shown in Figure 9 was created by taking MW values from the 132 kV and 220 kV utility revenue meters at the AC network point of common coupling at each VSC. As seen in Figure 9, actual measured losses were found to be lower than the initial estimated losses based on previous projects, especially at high MW power transfer. The combination of three-level bridge valve design, higher currents and lower switching frequency as used in Murraylink offered better power loss performance than anticipated as compared to the two-level bridge design used in earlier VSC projects such as Directlink [6].

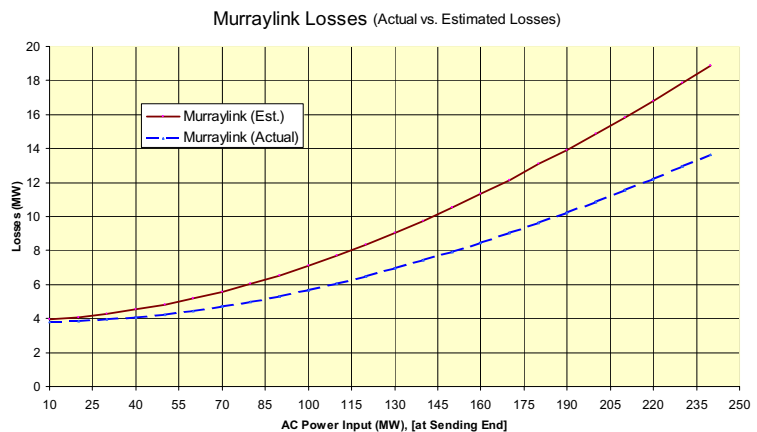

Figure 9. Murraylink Actual and Estimated Losses

## 5. TRANSIENT PERFORMANCE

With the converters being integrated to the AC substations with very low short circuit strength, special attention had to be paid to the transient behaviour due to frequent operations like converter energisation and converter deblocking. The converter AC voltage regulator would also play a major role during operation.

### 5.1 Converter energisation

As seen on the single line diagram of Figure 5, the incoming breaker is equipped with pre-insertion resistors to limit the converter energisation transients which consist of converter transformer inrush currents and charging current of the important DC side capacitances made of the DC side capacitors at both ends plus the DC cable capacitance. Figure 10 shows that the energisation transients are indeed very well controlled: the transient AC voltage fluctuation is limited to approximately 2% at Berri. It is noticed also that the steady state voltage change at energisation is limited to approximately 0.3%. This could not have been achieved without the AC filter circuit breakers that allow delay of the AC filter energisation with the converter deblocking.

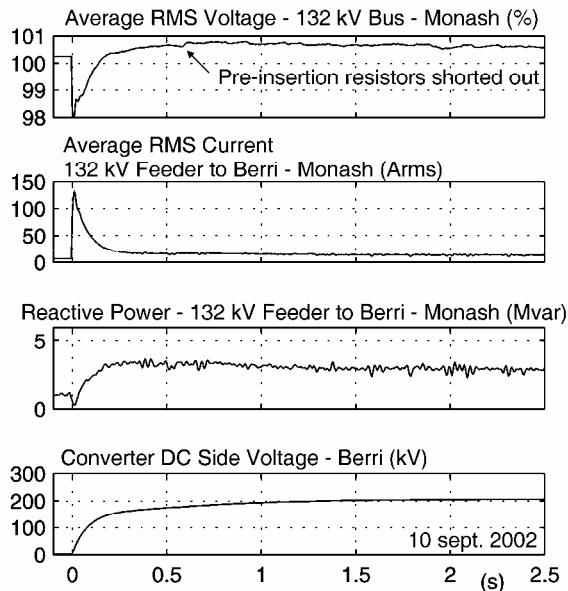

Figure 10  
Converter energisation

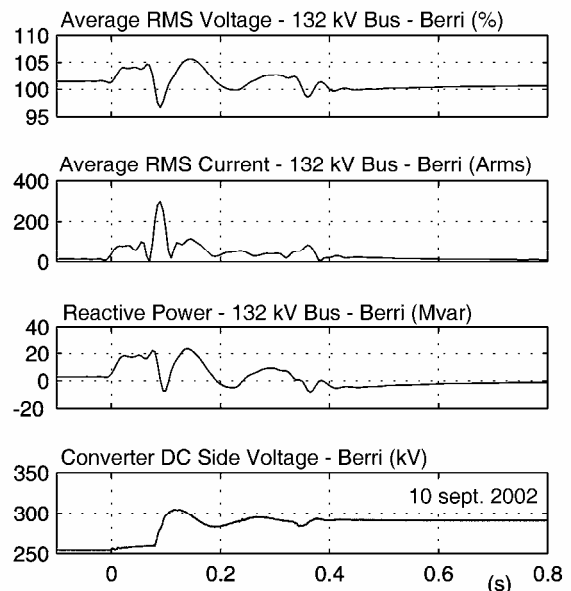

Figure 11  
Converter deblocking

### 5.2 Converter deblocking

This sequence consisting in the release of the valve firing pulses and in the energisation of the three AC filters has been designed to minimize the voltage transients at the PCC. First the AC filter breakers have been equipped with a synchronous closing function to limit the filter energisation transients. Then the various actions have been staggered as seen in Figure 11: the 27<sup>th</sup> harmonic AC filter is first energized followed 80 ms later by the release of the valve firing in reactive power control with an order of 0 Mvar. The 2<sup>nd</sup> and 3<sup>rd</sup> AC filters are brought in respectively 170 and 270 ms later. This whole sequence limits the transient AC voltage excursions to approximately  $\pm 4\%$ . Although this is considered adequate, it is believed that this could be further improved if required.

### 5.3 Step responses

Step responses of various control loops were evaluated during commissioning and the two most pertinent step response tests for system operation are presented in Figure 12. The step response of the active power controller (Figure 12a) exhibits a very fast behaviour (a rise time of 3.5 ms) compared to the conventional HVDC schemes. The AC voltage control (Figure 12b) has been intentionally set on the sluggish side but it could be made much faster if needed.

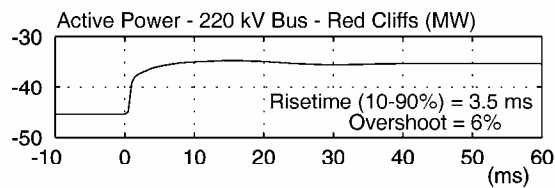

a) Step response of the active power controller

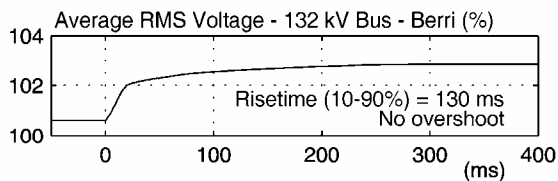

b) Step response of the AC voltage controller

Figure 12  
Step responses

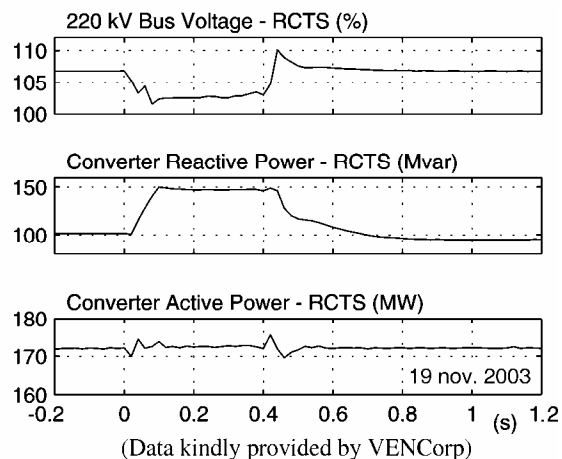

Figure 13  
AC fault on Victorian network

### 5.4 AC Voltage control

The AC networks are relatively weak, especially in Berri (minimum 232 MVA with one AC line out-of-service). The converters have to run continuously in AC voltage control to reduce the risk of voltage collapse. The presence of the converters has greatly improved the steady state voltage regulation at each interconnection point. Transient behaviour is also improved as shown in Figure 13 for an AC fault. Here the converter went to its full reactive power output while the transmitted power remained unchanged.

## 6. OPERATIONAL EXPERIENCE

Commercial operation started on Oct 1, 2002. Availability was in the 97% range for the first year of operation. Availability was impacted in the first year of commercial operation by scheduled outages to complete punch list items, complete testing that was delayed due to AC network constraints and by several forced outages. The most serious forced outage was due to a DC transmission cable fault that caused an outage between December 22 – 28, 2002. The cause of the DC cable fault was most likely due to a localized damage during installation.

## 7. CONCLUSION

The 220 MW Murraylink HVDC interconnection features a 177 km long underground cable, which is the longest high voltage underground cable system in the world. Project implementation was only 22 months after contract signing due to use of easy to install solid dielectric cables, modular VSC based converter equipment and a well-proven control and protection system.

## 8. REFERENCES

1. M. Wyckmans, "Innovation in the Market: HVDC Light, the new technology", [7<sup>th</sup> International Energy T & D Conference, Adelaide, Australia 2003].
2. L. Ronström, B. D. Railing, J. J. Miller, P. Steckley, G. Moreau, P. Bard, J. Lindberg, "Cross Sound Cable Project - second generation VSC technology for HVDC", [CIGRÉ Paris August 2004].
3. A. Ericsson, M. Jeroense, J. J. Miller, L. Palmqvist, B. D. Railing, P. Riffon: "HVDC-Light cable systems – the latest projects", [Nordic Insulation Symposium, Tampere, Finland, 2003].
4. T. B. Worzyk, M. Jeroense, T. Sörqvist, M. Farr, "The Murraylink Project – the First Commercial 150 kV Extruded HVDC Cable System", [JICABLE, France, 2003].
5. A. Krivda, F. Greuter, L. Palmqvist, "Characterisation of Electric Stress Control Materials by DC Conductivity and Impulse Measurements", [13<sup>th</sup> ISH, Delft, The Netherlands, 2003].
6. B. D. Railing, J. J. Miller, G. Moreau, J. Wasborg, Y. Jiang-Häfner, D. Stanley, "The DirectLink VSC-based HVDC Project and its Commissioning", [CIGRÉ 2002, Paper no. 14-108].